

TABLE OF CONTENTS

Preface	iv
CHAPTER 1. Overview	1-1
The Environment	1-1
The Nature of Special Reconnaissance	1-2
Special Operations Imperatives	1-8
Special Reconnaissance Fundamentals	1-10
Battlefield Operating Systems	1-12
Relationship to Other Missions	1-14
Employment	1-16
SR and Air-Land Operations	1-16
Historical Perspective	1-18
CHAPTER 2. Prepermission Activities	2-1
Section I. Mission Analysis	2-1
Procedures	2-1
Products	2-4
Staff Activities	2-5
Subordinate Operational Elements	2-8
Section II. Mission Planning	2-9
Mission Planning Process	2-9
Feasibility Assessment	2-10
Post-FA Activities	2-12
Plan of Execution Development	2-12
Section III. Mission Preparation	2-19
Training	2-20
Intelligence	2-21
Personnel	2-22
Logistics	2-22
Communications	2-22
Periodic Update	2-22
Section IV. Preemployment Preparation	2-23
Deliberate Planning	2-23

REFERENCES

SOURCES USED

These are the sources quoted or paraphrased in this publication.

Joint and Multiservice Publications

Joint Publication 1-02. *DOD Dictionary of Military and Associated Terms*, 15 April 1988.

Joint Pub 3-05.5. *Joint Special Operations Targeting and Mission Planning Procedures (Final Draft)*, August 1990.

STANAG 2174. *Military Routes and Route/Road Networks*, 10 September 1978.

Army Publications

AR 381-10. *U.S. Army Intelligence Activities*, 1 July 1984.

FM 3-18. *Special NBC Reconnaissance (LB Team)*, 3 June 1992.

FM 5-34. *Engineer Field Data*, 14 September 1987.

FM 5-103. *Survivability*, 10 June 1985.

FM 7-93. *Long-Range Surveillance Unit Operations*, 9 June 1987.

FM 21-76. *Survival*, 5 June 1992.

FM 31-20. *Doctrine for Special Forces Operations*, 20 April 1990.

FM 31-26. (*SECRET/NOFORN/WNINTEL*) *Special Forces Advanced Operations Techniques (U)* (To Be Published).

FM 31-71. *Northern Operations*, 21 June 1971.

FM 33-1. *Psychological Operations*, 31 July 1987.

FM 34-36. *Special Operations Forces Intelligence and Electronic Warfare Operations*, 1 July 1990.

FM 90-3. *Desert Operations*, 19 August 1977.

FM 90-5. *Jungle Operations*, 16 August 1982.

FM 90-6. *Mountain Operations*, 30 June 1980.

FM 90-10 (HTF). *Military Operations on Urbanized Terrain (MOUT) (How to Fight)*, 15 August 1979.

- FM 100-25. *Doctrine for Army Special Operations Forces*, October 1990.
- FM 101-5. *Operations*, 5 May 1986.
- FM 101-5-1. *Operational Terms and Symbols*, 21 October 1985.
- STP 31-18C34-SM-TG. *Soldier's Manual and Trainer's Guide for MOS 18C, Skill Levels 3 and 4*, 5 October 1990.
- STP 31-18F4-SM-TG. *Soldier's Manual and Trainer's Guide for MOS 18F, Skill Level 4*, 10 June 1991.
- TC 31-19. *Special Forces Military Free-Fall Operations*, 9 September 1988.
- TC 31-24. *Special Forces Air Operations*, 9 September 1988.
- TC 31-25. *Special Forces Waterborne Operations*, 3 October 1988.
- TC 31-29. *Special Forces Operational Techniques*, 9 September 1988.
- TC 57-1. *The Jumpmaster*, 28 September 1979.

DOCUMENTS NEEDED

These documents must be available to the intended users of this publication.

DA Form 5517-R. *Standard Range Cards (LRA)*, February 1986.

READINGS RECOMMENDED

These readings contain relevant supplemental information.

FM 25-101. *Battle Focused Training*, 30 September 1990.

FM 34-60A. *Counterintelligence Operations (SECRET/NOFORN/WNINTEL)*, 6 June 1989.

FM 41-10. *Civil Affairs Operations*, 11 January 1993.

Department of Army Information Security Program, 25 February 1988.

PREFACE

Special reconnaissance (SR) is defined as reconnaissance and surveillance actions conducted by Special Forces (SF) to obtain or verify, by visual observation or other collection methods, information concerning the capabilities, intentions, and activities of an actual or potential enemy or to secure data concerning the meteorologic, hydrographic, geographic, or demographic characteristics of a particular area. It includes target acquisition, area assessment, and poststrike reconnaissance.

Field manual (FM) 31-20-5 provides the doctrinal basis for the conduct of SR missions across the operational continuum. It is a continuation of the doctrinal education process that begins with Joint Publication 3-05.5 and FMs 100-25 and 31-20. This manual provides information and guidance to SF commanders, staffs, and operational personnel at battalion and lower echelons (Special Forces operational detachments [SFODs] C, B, and A) in their conduct of SR. It is a general guide and does not eliminate the requirement for well-written, practiced, and mission-essential task list (METL)-driven standing operating procedures (SOPs).

It is designed to expand on and be supported by FM 31-20-1, Special Forces Tactics, Techniques, and Procedures (to be published). It was written under the assumption that the user understands these basic fundamentals. However, it expands on this basic information by providing a number of historical examples to highlight key points throughout the text as well as advanced tactics, techniques, procedures, and references to support future SF operations. Users of this FM should adapt its contents to meet the situation and knowledge and skill levels of the SFOD to be employed through the mission, enemy, terrain, troops, and time available (METT-T) analysis system.

The chapters provide general SR mission procedures and information. This information is ordered chronologically from receipt of the unit mission letter through postmission activities. Figure P-1 shows the applicability of each chapter to the differing unit levels. Examples of specific SR techniques and procedures are provided in the appendixes. The order of the appendixes follows the order they appear in the text. This organization permits the user of this FM to review the basics of SR mission performance from beginning to end without becoming embroiled in a mass of detail with which the user may be thoroughly familiar. For those users only interested in the details of specific techniques, the appendixes provide reference material keyed to the generic activities in the text.

Commanders and trainers should use this and other related manuals in conjunction with command guidance, the Army Training and Evaluation Program

(ARTEP), and the Mission Training Program to plan and conduct mission-specific training. Planning SR-related training prior to being employed with a specific SR mission is the key to assuring success.

The provisions of this publication are the subject of the international agreements listed in the references in the back of this book. There are numerous acronyms, abbreviations, and terms found within this manual. Users should refer to the Glossary section at the back of the manual for their meanings or definitions.

The proponent of this publication is the United States Army John F. Kennedy Special Warfare Center and School (USAJFKSWCS), Fort Bragg, NC. Reviewers and users of this manual should submit comments and recommended changes on DA Form 2028 to Commander, USAJFKSWCS, ATTN: AOJK-DT-DM, Fort Bragg, NC 28307-5000.

Unless otherwise stated, whenever the masculine gender is used, both men and women are included.

Applicability	Chapter 1 Overview	Chapter 2 Pre-mission Employment	Chapter 3 Employment	Chapter 4 Postmission Activities	Appendixes
SF Group					
SFOD C					
SFOD B					
SFOD A					

Figure P-1. User applicability guide.

INDEX

A

advanced operational base (AOB)	2-4, 2-6, 2-8, 2-11, 4-1, G-2
advanced special operations training (ASOT)	2-3
advanced trauma life support (ATLS)	1-7
air defense	1-13
air-land operations	1-17
area assessment (AA)	1-4, 1-14, 1-17, 3-1, C-13
area of operations (AO)	3-1
area of responsibility (AOR)	2-1
area orientation	1-7
area reconnaissance	B-1, B-5
area specialist team (AST)	2-13
area studies	2-21
assessment team (<i>see also</i> pilot team and survey team)	1-4, 1-14
augmentation	3-22

B

battle drills (BDs)	1-12
battlefield operating systems (BOS)	1-12 through 1-14
beach survey format	D-51
“BLUES” application	A-1, A-14
bridge report (BRIDGEREP)	3-8, D-18
briefback	2-18 and 2-19

C

camouflage and concealment	C-21 and C-22
CARVER	3-13
analysis	3-8
assessment	3-15

matrix	1-7, 3-15
reconnaissance report checklist	3-15
chemical reconnaissance team "LB"	E-1
civil affairs (CA)	1-14, 1-16, 2-7
civil-military operations	2-15
close air support (CAS)	1-13
collateral activities	1-16
combat patrolling	2-24
combat service support (CSS)	1-13
command and control (C ²)	1-13
command, control, communications, and intelligence (C ³ I)	1-11
commander in chief (CINC)	1-18
communications site	A-16
compartmentation	2-13
contingency operation	1-17
counterdrug (CD)	1-16
counterinsurgency (COIN)	C-16
counterintelligence (CI)	4-2
counterterrorism (CT)	1-15
countertracking	C-23
courses of action (COAs)	2-3, E-1
criticality, accessibility, recuperability, vulnerability effect, recognizability (CARVER)	1-4
CS gas (see tear gas)	

D

damage

collateral	3-11
immediate	3-11
debriefing	
collective intelligence	4-2
format	D-54 and D-55
general collective	4-3
individual	4-3
decision-making process	2-5
deliberate planning	2-23
Desert Storm (<i>see also</i> Operation Desert Shield/Desert Storm)	1-17
direct action	1-14

E

electronic countermeasures (ECM) A-3

electronic counter-countermeasures (ECCM) A-3

electronic filmless camera system (EFCS) 2-7, C-11

electronic information retrieval 4-4

emerging missions 2-23

employment 1-16, 3-1

escape and evasion (E&E) 1-15

 plan 1-13, C-5

estimates 2-3 and 2-4, 2-16

Executive Order 12333 F-3

explosive ordnance disposal (EOD) 3-22, I-1

 detachment E-3

F

F-470 Zodiac inflatable boat C-3

feasibility assessment (FA) 2-10

field standing operating procedures (FSOPs) 1-12

foreign internal defense (FID) 1-14

forward operational base (FOB) 2-4, 2-6, 2-8, 2-13, 4-1, G-2

G

Geneva Convention on Prisoners of War F-5

grenades I-4

group chemical detachment E-1

H

high altitude high opening (HAHO) operations
(*see also* military free-fall [MFF] operations) C-2

high altitude low opening (HALO) operations
(*see also* military free-fall [MFF] operations) 2-6, 2-17, C-2

host nation (HN) 1-14

host nation law F-2

human intelligence (HUMINT) 1-8, 1-18

hydrographic survey format D-52 and D-53

I

“ICE Packs” (*see* individual chemical equipment [ICE] resupply procedures)

imagery intelligence (IMINT) 1-8, C-9, C-11

immediate action drills (IADs)	1-12
incidental information collection	1-5, 3-23
indicators	3-21, 3-23
individual chemical equipment (ICE) resupply procedures	E-3
initial area assessment (IAA)	3-1
intelligence and electronic warfare (IEW)	3-23
intelligence preparation of the battlefield (IPB)	1-8, 3-1
intelligence summaries (INTSUMs)	2-6
intermediate staging bases (ISB)	C-1
internal defense and development (IDAD)	1-14
isolation facility (ISOFAC)	4-1

J

joint force commander (JFC)	1-11
joint force special operations component commander (JFSOCC)	G-1
joint force special operations air component commander (JSOACC)	G-1
Joint Readiness Training Center (JRTC)	2-7
joint special operations areas (JSOAs)	1-5
joint special operations task force (JSOTF)	1-11, G-1
joint strategic capabilities plans (JSCPs)	2-2
joint targeting coordination board (JTCB)	G-2

K

Klepper Arius 2 military canoe	C-3 and C-4
KS-99 series camera system	C-11

L

land mines	I-2
laws of war	F-1
LB team (<i>see also</i> chemical detachment team "LB")	1-4, 3-19 and 3-20, 3-22
lines of communication (LOC)	1-15, B-1
LOC surveillance	3-21
long-range surveillance unit (LRSU)	2-24

M

message pickup (MPU) operations	C-6
military free-fall (MFF) operations	C-2
military intelligence (MI)	1-12

military intelligence detachments (MID) 2-8, 3-22

mission concept (MICON) 2-13, 2-16

mission, enemy, terrain, troops, and time
available (METT-T) 1-16, 3-4, A-9, C-12

 analysis system iv

 factors 3-21, A-1, A-8, A-15

mission-essential task list (METL) 1-3, 2-20, 2-23

mission-essential equipment 2-18, H-1

mission letter 2-2

mission-oriented protective posture (MOPP) E-3

mission planning 2-9

mission planning agent (MPA) 2-19

mission-specific equipment 2-10, H-1

mission support sites (MSSs) 1-13

mission support package (MSP) 2-19

mission tasking package (MTP) 2-9

mobile training team (MTT) 3-23

modification table of organization and equipment (MTOE) 2-4

N

National Command Authorities (NCA) F-5

near-real-time (NRT) 1-3

 information 1-11

 intelligence 1-14, 1-17

night observation C-18

night vision devices (NVDs) 2-18, C-20

night vision goggles (NVGs) 2-18

O

observation and surveillance sites

 construction A-2, A-4, A-6, A-7, A-9

 techniques A-12 through A-15

 in nonpermissive environments A-2

 in northern areas A-7

 in permissive and semipermissive environment A-2

 in the desert A-5

 in the forest A-6

 in the jungle and swamp A-7

 in the mountains A-3

occupation A-1
 selection A-2 through A-4, A-8
 types of A-10 through A-12
 observation and fields of fire, cover and concealment,
 obstacles, key terrain, and avenues of approach (OCOKA) C-7, C-9, C-13
 observation log C-8
 Operation Desert Shield/Desert Storm 1-17 and 1-18
 operational continuum 1-2
 operations and intelligence (O&I) 2-4
 operations security (OPSEC) 1-12
 overt collection 1-5

P

peacetime campaign plans (PCPs) 2-2
 pilot team (*see also* survey team and assessment team) 1-4, 1-15, 2-3, 2-8
 plan of execution (POE) 1-13, 2-12
 principal area assessment (PAA) 3-1
 PROJECT DELTA 1-19
 psychological operations (PSYOP) 1-5, 1-13 and 1-14, 1-16, 2-7
 PSYOP themes 3-19

Q

quick reaction force (QRF) 4-1, C-5

R

radio direction finding (DF) A-15
 reconnaissance
 hydrographic, meteorological, and geographic 1-4
 poststrike 1-4, 3-10, I-6
 nuclear, biological, and chemical (NBC) 1-4
 reconnaissance and surveillance (R&S) 1-5, 3-11
 report
 after-action 1-5, 4-5
 CARVER reconnaissance 3-14
 formats D-1 through D-55
 historical 4-5
 of enemy sighting (SPOTREP) D-1
 of lessons learned 4-5
 requests for intelligence information (RIIs) 2-6

requests for information (RFIs) 2-6, 2-14
 river/estuary report (DELTREP) 3-8, D-16
 "rolled over" (see also "rollover") 1-14
 "rollover" 1-15, 3-21
 routes and roads report (ROUTEREP) 3-8, D-7
 rules of engagement (ROE) 1-2

S

satellite 3-11
 security assistance (SA) 1-16
 sensitive compartmented information facility (SCIF) 3-22
 SFOD SOPs 1-12
 signal center (SIGCEN) 4-2
 signals intelligence (SIGINT) 1-8
 size, activity, location, unit, time, and equipment (SALUTE) C-7
 small boat operations C-2 and C-3
 SO legal considerations 2-4, F-1 through F-5
 SOMPF shell 2-12
 Special Air Service (SAS) 1-18
 Special Forces operational base (SFOB) G-2
 special operations command (SOC) 1-11, G-1
 special operations command and control
 element (SOCCE) 2-4, 2-7, 2-13, G-2 and G-3
 Special Operations Command Research Analysis and
 Threat Evaluation System (SOCRATES) 2-21, 4-2, 4-4
 special operations coordination element (SOCCOORD) G-2
 Special Operations Debriefing and Retrieval System (SODARS) 4-2, 4-4
 special operations imperatives 1-8 through 1-10
 special operations mission planning folder (SOMPF) 2-6, 2-12, 2-19
 Special Operations Target Interdiction Course (SOTIC) 2-4
 special reconnaissance (SR) iv, 1-2 and 1-3, 1-6, 1-10
 specific data collection (SDC) 3-21
 SR relationship to other missions 1-14
 staff judge advocate (SJA) F-1
 staff weather officer (SWO) 4-2
 support of GP forces 1-16
 support operations teams A (SOTs A) 2-3, 2-8
 surf report (SURFREP) 3-2, D-14 and D-15
 survey team (see also pilot team and assessment team) 1-4

T

tactical beach report (TACBEREP) 3-4, D-10

target acquisition 1-3

target analysis (TA) 1-4, 3-13

target areas of interest (TAIs) 1-10

target intelligence packages (TIPs) (*see also* SOMPF shell) 1-10, 2-21

target reconnaissance report (TGTRECONREP) D-3 through D-6

target survey checklist 3-14

tear gas F-5

technical intelligence exploitation plan and
category requirements format D-21 through D-44

terrorist F-4

theater special operations support command (TASOSC) G-2

threat order of battle 1-12

Title 10 of the U.S. Code 2-20

tracking C-23

types of photography C-10

U

unconventional warfare (UW) 1-15

United States Commander in Chief,
Special Operations Command (USCINCSOC) 2-20

unmanned aerial vehicle (UAV) 3-11

use of force F-3

V

validation and certification 2-20

W, X, Y, Z

zone reconnaissance techniques B-1 through B-4

GLOSSARY

PART I- ACRONYMS

AA	area assessment
ADA	air defense artillery
AO	area of operations
AOB	advanced operational base
AOE	area of effect
AOR	area of responsibility
APC	armored personnel carrier
ARSOTF	Army special operations task force
ARTEP	Army Training and Evaluation Program
ASA	American Standard Association
ASOT	advanced special operations training
ASP	ammunition supply point
AST	area specialty team
ATLS	advanced trauma life support
BD	battle drill
BDU	battle-dress uniform
BLS	beach landing site
BOB	back of beach
BOS	battlefield operating systems
BRIDGEREP	bridge report
C ²	command and control
C ³ I	command, control, communications, and intelligence
CA	civil affairs

CARVER	criticality, accessibility, recuperability, vulnerability, effect, recognizability
CAS	close air support
CCTV	closed-circuit television
CD	counterdrug
CI	counterintelligence
CINC	commander in chief
COA	course of action
COIN	counterinsurgency
CONOPS	concept of operations
CONPLAN	concept plan
CONUS	continental United States
CP	command post
CSM	command sergeant major
CSS	combat service support
CT	counterterrorism
DA	direct action, Department of the Army
DCSINT	Deputy Chief of Staff for Intelligence
DELTREP	river/estuary report
DF	direction finding
DOD	Department of Defense
DODIC	Department of Defense Identification Code
DP	datum point
DTG	date-time group
DZ	drop zone
E&E	evasion and escape
ECCM	electronic counter-countermeasures
ECM	electronic countermeasures
EFCS	electronic filmless camera system
EMR	electro-magnetic radiation
EOD	explosive ordnance disposal
FA	feasibility assessment
FCB	forward control base

FID	foreign internal defense
FM	field manual
FOB	forward operational base
FSOP	field standing operating procedure
GP	general purpose
HAHO	high altitude high opening
HALO	high altitude low opening
HE	high explosive
HEAT	high explosive anti-tank
HF	high frequency
HLZ	helicopter landing zone
HN	host nation
HNS	host nation support
HUMINT	human intelligence
IAA	initial area assessment
IAD	immediate action drill
ICE	individual chemical equipment
IDAD	internal defense and development
IEW	intelligence and electronic warfare
IFV	infantry fighting vehicle
IMINT	imagery intelligence
INTSUM	intelligence summary
IPB	intelligence preparation of the battlefield
IR	information requirements
ISB	intermediate staging base
ISOFAC	isolation facility
IV	intravenous
JFC	joint force commander
JFSOCC	joint force special operations component commander
JIC	joint information center
JRTC	Joint Readiness Training Center
JSCP	joint strategic capabilities plan

JSOA	joint special operations area
JSOACC	joint force special operations air component commander
JSOTF	joint special operations task force
JTCB	joint targeting coordination board
KIA	killed in action
LBE	load-bearing equipment
LNO	liaison office
LOC	lines of communication
LRRP	long-range reconnaissance patrol
LRSU	long-range surveillance unit
LTD	laser target designation
LZ	landing zone
METL	mission-essential task list
METT-T	mission, enemy, terrain, troops, and time available
MFF	military free-fall
MHW	mean high water
MI	military intelligence
MICON	mission concept
MID	military intelligence detachment
MLW	mean low water
MOPP	mission-oriented protective posture
MOS	military occupational specialty
MPA	mission planning agent
MPU	message pickup
MRE	meal, ready-to-eat
MSC	major subordinate command
MSD	minimum safe distance
MSP	mission support package
MSS	mission support site
MSU	major subordinate unit
MTOE	modification table of organization and equipment
MTP	mission tasking package

MTT	mobile training team
NAI	named area of interest
NATO	North American Treaty Organization
NBC	nuclear, biological, and chemical
NCA	National Command Authorities
NCO	noncommissioned officer
NM	nautical miles
NRT	near-real-time
NVD	night vision device
NVG	night vision goggles
O&I	operations and intelligence
OB	order of battle
OCOKA	observation and fields of fire, cover and concealment, obstacles, key terrain, and avenues of approach
OP	observation post
OPCEN	operations center
OPLAN	operation plan
OPSEC	operations security
ORP	objective rally point
PAA	principal area assessment
PCP	peacetime campaign plans
PDM	pursuit deterrent mines
PIR	priority intelligence requirements
POC	point of contact
POE	plan of execution
POI	point of impact
POL	petroleum, oils, and lubricants
PSYOP	psychological operations
PW	prisoner of war
PWP	plasticized white phosphorous
QRF	quick reaction force
R&S	reconnaissance and surveillance

RFI	request for information
RII	request for intelligence information
ROE	rules of engagement
ROUTEREP	routes and roads report
RP	rally point
RPG	rocket propelled grenade
RSP	render-safe procedures
S1	personnel officer
S2	intelligence officer
S3	operations officer
S4	logistics officer
SA	security assistance
SALUTE	size, activity, location, unit, time, and equipment
SAS	Special Air Service
SATCOM	satellite communications
SCIF	sensitive compartmented information facility
SDC	specific data collection
SF	Special Forces
SFOB	Special Forces operational base
SFOD	Special Forces operational detachment
SIGCEN	signal center
SIGINT	signals intelligence
SIO	senior intelligence officer
SIR	specific information requirements
SJA	staff judge advocate
SL	static-line
SLR	single-lens reflex
SO	special operations
SOC	special operations command
SOCCE	special operations command and control element
SOCOORD	special operations coordination element
SOCRATES	Special Operations Command Research Analysis and Threat Evaluation System

SODARS	Special Operations Debriefing and Retrieval System
SOF	special operations forces
SOMPF	special operations mission planning folder
SOP	standing operating procedure
SOT A	support operation team A
SOTIC	Special Operations Target Interdiction Course
SPETSNAZ	Soviet Special Purpose Forces
SPOTREP	report of enemy sighting
SPTCEN	support center
SR	special reconnaissance
SUPCEN	support center
SURFREP	surf report
SWO	staff weather officer
TACBEREP	tactical beach report
TACCTA	tactical commander's terrain analysis
TA	target analysis
TAI	target area of interest
TASOSC	theater Army special operations support command
TE	technical evaluation
TGTRECONREP	target reconnaissance report
TIP	target intelligence package
TOC	tactical operations center
UAV	unmanned-aerial vehicle
USAJFKSWCS	United States Army John F. Kennedy Special Warfare Center and School
USASOC	United States Army Special Operations Command
USCINCSOC	United States Commander in Chief, Special Operations Command
USMC	United States Marine Corps
USSOCOM	United States Special Operations Command
UW	unconventional warfare
WIA	wounded in action
WLTS	water line at the time of sounding
WP	white phosphorous

PART II - DEFINITIONS

area assessment	In unconventional warfare, the collection of specific information prescribed by the commander to commence immediately after infiltration. It is a continuous operation, and it confirms, corrects, refutes, or adds to intelligence acquired from area studies and other sources prior to infiltration.
asset (intelligence)	(DOD, IADB) Any resource—person, group, relationship, instrument, installation, or supply—at the disposition of an intelligence organization for use in an operational or support role. Often used with a qualifying term such as agent asset or propaganda asset. (JCS Pub 1-02)
compartmentation	(DOD) 1. Establishment and management of an intelligence organization so that information about the personnel, organization, or activities of one component is made available to any other component only to the extent required for the performance of assigned duties. (JCS Pub 1-02) 2. In unconventional warfare, the division of an organization or activity into functional segments or cells to restrict communication between them and prevent knowledge of the identity or activities of other segments except on a need-to-know basis. 3. Restricting the use of specific cryptovars to specific users for the purpose of limiting access to the information protected by these cryptovars and limiting the adverse impact of a compromise of these variables. (AR 310-25)
deconflict	To reconcile or resolve a conflict in interests as in targeting.
direct action	In special operations, a specified act involving operations of an overt, clandestine, or low visibility nature conducted primarily by special operations forces in hostile or denied areas. (JCS Pub 1-02)
direct action operations	Short-duration strikes and other small-scale offensive actions by special operations forces to seize, destroy, or inflict damage on a specified target; or to destroy, capture, or recover designated personnel or material. In the conduct of these operations, special operations forces may employ raid, ambush, or direct assault tactics; emplace mines and other munitions; conduct standoff attacks by fire from air, ground, or maritime platforms; provide terminal guidance for precision guided munitions; and conduct independent sabotage. (USCINCSOC)
evasion and escape	(DOD, I, NATO, IADB) The procedures and operations whereby military personnel and other selected individuals are enabled to emerge from an enemy-held or hostile area to areas under friendly control. (JCS Pub 1-02)
evasion and escape net	(DOD, IADB) The organization within enemy-held or hostile areas that operates to receive, move, and exfiltrate military personnel or selected individuals to friendly control. (JCS Pub 1-02)
executive order	Order issued by the President by virtue of the authority vested in him by the Constitution or by an act of Congress. It has the force of law. (AR 310-25)
exfiltration	(DOD) The removal of personnel or units from areas under enemy control. (JCS Pub 1-02)
foreign intelligence	Information relating to the capabilities, intentions, and activities of foreign powers, organizations, or persons, but not including counterintelligence, except for information on international terrorist activities. (DOD Directive 5240.1)

infiltration	(DOD, NATO, IADB) 1. The movement through or into an area or territory occupied by either friendly or enemy troops or organizations. The movement is made either by small groups or by individuals at extended or irregular intervals. When used in connection with the enemy, it infers that contact is avoided. 2. In intelligence usage, placing an agent or other person in a target area in hostile territory. Usually involves crossing a frontier or other guarded line. Methods of infiltration are black (clandestine), grey (through legal crossing point but under false documentation), white (legal). 3. A technique and process in which a force moves as individuals or small groups over, through, or around enemy positions without detection. (JCS Pub 1-02)
intelligence reporting	(DOD, IADB) The preparation and conveyance of information by any means. More commonly, the term is restricted to reports as they are prepared by the collector and as they are transmitted by him to his headquarters and by this component of the intelligence structure to one or more intelligence-producing components. Thus, even in this limited sense, reporting embraces both collection and dissemination. The term is applied to normal and specialist intelligence reports. (JCS Pub 1-02)
joint doctrine	(DOD) Fundamental principles that guide the employment of forces of two or more Services of the same nation in coordinated action toward a common objective. It is ratified by all four Services and may be promulgated by the Joint Chiefs of Staff. (JCS Pub 1-02)
joint operations	Operations carried on by two or more of the Armed Forces of the United States (Army, Navy, Air Force). (AR 310-25)
joint special operations area	That area of land, sea, and airspace assigned to a joint special operations command to conduct SO activities.
low intensity conflict	(DOD) A limited politico-military struggle to achieve political, social, economic, or psychological objectives. It is often protracted and ranges from diplomatic, economic, and psychosocial pressures through terrorism and insurgency. Low intensity conflict is generally confined to a geographic area and is often characterized by constraints on the weaponry, tactics, and the level of violence. Also called LIC. (JCS Pub 1-02)
low visibility operations	(DOD) Sensitive operations wherein the political/military restrictions inherent in covert and clandestine operations are either not necessary or not feasible; actions are taken as required to limit exposure of those involved and/or their activities. (JCS Pub 1-02)
observation post (OP)	An OP is a valuable part of most defensive postures. OPs are normally temporary or one-time-use positions occupied overnight. They are used to ensure early warning for the defensive perimeter.
observation site	An observation site is a preplanned structure that is designed to be occupied for extended periods. Construction techniques should be practiced in areas where the conditions and/or terrain are similar to those found in the target area. The size of the site must be large enough to accommodate both the observers and their equipment.
operational command	(DOD, IADB) Those functions of command involving the composition of subordinate forces, the assignment of tasks, the designation of objectives, and the authoritative direction necessary to accomplish the mission. Operational command should be exercised by the use of the assigned normal organizational units through their responsible commanders or through the commanders of subordi-

	<p>nate forces established by the commander exercising operational command. It does not include such matters as administration, discipline, internal organization, and unit training, except when a subordinate commander requests assistance. (JCS Pub 1-02) The term is synonymous with “operational control” and is uniquely applied to the operational control exercised by the commanders of unified and specified commands over assigned forces in accordance with the National Security Act of 1947, as amended and revised (10 United States Code 124). (JCS Pub 1-02)</p>
overt operation	<p>(DOD, IADB) The collection of intelligence openly, without concealment. (JCS Pub 1-02)</p>
proactive	<p>Acting in anticipation of future problems or needs.</p>
special operations	<p>Actions conducted by specially organized, trained and equipped military and paramilitary forces to achieve military, political, economic, or psychological objectives by nonconventional military means in hostile, denied, or politically sensitive areas. They are conducted in peace, conflict, and war, independently or in coordination with operations of conventional forces. Politico-military considerations frequently shape special operations, requiring clandestine, covert, or low visibility techniques, and oversight at the national level. Special operations differ from conventional operations in degree of risk, operational techniques, mode of employment, independence from friendly support, and dependence on detailed operational intelligence and indigenous assets. (USCINCSOC)</p>
special reconnaissance	<p>SR operations are reconnaissance and surveillance actions conducted by special operations forces to obtain or verify, by visual observation or other collection methods, information concerning the capabilities, intentions, and activities of an actual or potential enemy or to secure data concerning the meteorological, hydrographic, or geographic characteristics of a particular area. It includes target acquisition, area assessment, and poststrike reconnaissance. (USCINCSOC)</p>
strategic intelligence	<p>(DOD) Intelligence that is required for the formation of policy and military plans at national and international levels. Strategic intelligence and tactical intelligence differ primarily in level of application but may also vary in terms of scope and detail. (JCS Pub 1-02)</p>

SPECIAL RECONNAISSANCE TACTICS, TECHNIQUES, AND PROCEDURES FOR SPECIAL FORCES

DISTRIBUTION RESTRICTION:

Distribution authorized to U.S. Government agencies only to protect technical or operational information from automatic dissemination under the International Exchange Program or by other means. This determination was made on 7 March 1990. Other requests for this document will be referred to Commander, U.S. Army John F. Kennedy Special Warfare Center and School, ATTN: AOJK-DT-DM, Fort Bragg, NC 28307-5000

DESTRUCTION NOTICE:

Destroy by any method that will prevent disclosure of contents or reconstruction of the document.

Headquarters, Department of the Army

POSTMISSION ACTIVITIES

Information gathering is the goal of all SR operations. Gathering additional information accomplishes two goals. First, the information prevents the SFOD from having to go back into the same area to perform another reconnaissance to gain more information. Second, if needed, a quick reaction force (QRF) or other reinforcements can be given guidance for the best route through the area to adjacent SFODs or units. After completing SR mission tasks, the SFOD quickly exfiltrates to an isolation facility (ISOFAC) or other secure area for debriefing, preparation of after-action and lessons learned reports, reconstitution, recovery, stand down, or regeneration as required. SF units have SOPs for postmission SFOD debriefing to ensure all needed information is obtained. Debriefings must be timely and address PIR, IR, other mission-specific requirements, and other information. Command emphasis is essential to the success of these postmission activities.

MISSION DEBRIEFING

Immediately after the SFOD's arrival at the ISOFAC, the staff of the recovering operational base begins the debriefing process. The purpose of this quick and systematic debriefing is to capture as much accurate information as is available from the SFOD in the shortest time possible. For example, PIR may be mission-specific information on the operational capability of an enemy unit. However, if the SFOD noticed large movements of noncombatants during certain hours, reporting this information may help to identify enemy population control operations being undertaken. This extra information could play a key role in the timing of future infiltrations. The returning SFOD is also questioned about map corrections during all debriefing sessions. This key information aids in both planned and emergency exfiltrations or reinforcement operations.

Debriefing Staff

The AOB and/or FOB debriefing staff conducts debriefings. Appendix D contains information on debriefing formats. Priority in debriefing the SFOD goes to the SIO and his staff. Debriefings are tape recorded and or videotaped, and the SIO maintains these tapes on file for long-term use. The debriefing staff is made up of the following:

- OPCEN director or base deputy commander (committee chairperson).
- OPCEN operations officer (S3).
- SIO (S2).

- AST for the recovered SFOD.
- SPTCEN personnel officer (S1).
- SPTCEN logistics officer (S4).
- CA staff officer.
- PSYOP staff officer.
- Signal center (SIGCEN) director or senior signal officer.
- Medical operations officer.
- Judge advocate.
- Staff weather officer (SWO).
- Chaplain.
- Unit historian.
- Others as directed by the OPCEN director.

Procedures

As soon as the SFOD is recovered, and before its members are allowed to attend to personal hygiene and other personal matters, members undergo a rapid debriefing as a group. The debriefing procedures described below address the basic steps to be followed as part of the debriefing process.

Collective Intelligence Debriefing. The intelligence staff conducts this debriefing, but other staff elements may also be present. The purpose of this debriefing is to answer PIR and/or SIR, elicit indications, and provide warning.

Format. This debriefing is quick and to the point. The format and line of questioning varies from mission to mission but is determined by the OPCEN director in accordance with the unit SOP. See FMs 34-36 and 31-20 for examples of the types of information for which the SFOD can be queried. For use of specific debriefing guides from the United States Special Operations Command's (USSOCOM's) concept of operations (CONOPS), and Special Operations Debriefing and Retrieval System (SODARS), refer to USSOCOM's SOCRATES. The Battalion S2 has access to this system. Appendix D has an example of a debriefing guide. The intelligence staff immediately exploits time-sensitive information critical to decision making by the commander or higher headquarters. For example, a priority may be the location of insurgent safe houses that are targets for DA teams.

Technique. Normally, the principal debriefer uses a technique known as "map-tracking." The primary debriefing aid used is a map of the SFOD's AO. The debriefer starts at the point of infiltration or embarkation and follows the route travelled by the unit. He proctors the flow of information to ensure all events, sightings, and activities conducted to the point of exfiltration or debarkation are covered. After getting the initial information, the debriefer then segments return route information. He asks specific questions with emphasis on operating systems (intelligence, communications, engineering, weaponry, and medical aspects) that affected the SFOD's mission. Throughout the debriefing, the debriefer maintains a relaxed and nonhostile atmosphere in which the unit recounts its activities. A qualified debriefer such as a member of the battalion counterintelligence (CI) team, an interrogator, or an order of battle technician conducts the

debriefing. If such a person is not available, a detached but knowledgeable proctor and prompter collect and record the information concerning the SFOD's observations during its mission.

Review of SFOD Documents and Other Materiel. After the collective intelligence debriefing, the intelligence staff gathers all maps, notebooks, papers, exposed film, video tapes, photographs, recovered equipment, and other materiel. It then releases the SFOD to attend to personal hygiene, rest, and recuperate. If necessary, all rucksacks, map cases, and uniform pockets are inventoried to ensure all items of intelligence interest are collected. The intelligence staff thoroughly reviews all of the collected items for data and formulates more detailed questions for the next stage of debriefing.

Individual Debriefing. As soon as the intelligence staff is ready, and in any case not later than three hours after the SFOD has recovered to the operational base, the intelligence staff calls SFOD members in individually for detailed debriefing. At this stage in debriefing, the intelligence staff focuses first on the commander's PIR and SIR and then on IR. The intelligence staff also collects information on the adequacy of preinfiltration intelligence support. As an individual is released by the intelligence staff, other staff elements may conduct similar individual debriefings. However, no other staff element should talk with an SFOD member until the intelligence staff has had its turn.

General Collective Debriefing and After-Action Review. After individual debriefings, and not later than 6 hours after the SFOD has recovered to the operational base, the base debriefing staff assembles the SFOD and the staff as a group for a general collective debriefing and after-action review. The base commander may also be present. At this debriefing, the SFOD leader gives a quick summary of the operation, focusing on the SFOD's stated and implied missions. He also briefs unanticipated SFOD's or members' activities (for example, to exploit a high-value source of information). After the SFOD leader gives his summary, each staff section, in turn, questions the SFOD members and augmenters. At the conclusion of this stage of the debriefing, the commander or OPCEN director provides any necessary further guidance. The SFOD is then released to prepare its after-action review and report of lessons learned. Ordinarily, this debriefing includes—

- Name, rank, and position of each SFOD member.
- Mission.
- Time, location, and insertion and extraction methods.
- Routes.
- Terrain (vegetation, height of canopy if in forest, trails, water sources and direction of flow, LZs and BLZs), local population, including distance and direction to the nearest terrain feature, and natural and man-made obstacles to movement in the area.
- SFOD's uniforms and equipment.
- Hostile forces (strength, activity, location, uniform, time, equipment, weapons, and morale).
- Results of hostile contact (friendly and enemy killed in action [KIA] and wounded in action [WIA], disposition of KIA, PWs, descriptions and serial numbers of captured weapons, and descriptions of captured documents and equipment).

- Weapons, demolitions, and ammunition used and results.
- Map corrections.
- Communications equipment used and results.
- Friendly contacts, including descriptions, locations, circumstances, and results.
- Miscellaneous information such as incorporation of surveillance plan, security procedures, surveillance techniques used, and surveillance site type, construction, and occupation.
- Condition of the SFOD, including time needed to prepare for the next mission.
- Conclusions and recommendations.

Electronic Information Retrieval. Upon completion of a debriefing, the battalion S2 places the information into the most appropriate format in accordance with USSOCOM's CONOPS and SODARS to ensure it can be retrieved and cross-referenced within the chain of command and the SOCRATES. The battalion S2 has access to these formats and systems. He forwards debriefing reports via secure STU III data modem or by mail or courier on 5.25-inch floppy disks through operational channels to the Deputy Chief of Staff for Intelligence (DCSINT), United States Army Special Operations Command (USASOC), for final review and electronic submission via SOCRATES to USSOCOM.

Security Manager Duties. Once a debriefing is completed, the unit security manager reviews all resulting reports to ensure they are properly classified. He further reviews each report for any unclassified but sensitive information. He ensures that each report is marked with the appropriate classification markings.

FOLLOW-ON MISSIONS

As stated in FM 31-20, follow-on missions may be conducted; however, such missions must be performed by exception and not by rule. SFODs may perform these missions under the following conditions:

- The follow-on mission becomes a new, separate mission.
- The new mission allows for additional planning time.
- The new mission does not compromise the main mission.
- The follow-on mission does not go beyond the SFOD's capability or its task organization.
- The SFOD A trained for the mission and has the mission-specific equipment.
- The SFOD going into isolation understands that this is a "**be prepared to**" follow-on mission at the time the mission letter and/or briefing is issued.

WRITTEN REPORTS

After the debriefing, the SFOD leader, assisted by other members of the SFOD and attachments, prepares several written reports. The unit historian prepares the unit's historical report.

After-Action Report

The after-action report states the *who, what, when, why, where*, and *how* of the operation. It is a permanent record of the SFOD's major activities from isolation to debriefing. As such, it is an extremely important template on which past missions may be compared and future missions planned. The battalion S3 will submit the SFOD's after-action report through command channels to the group commander not later than 48 hours after the SFOD A has been debriefed. The intelligence and operations officers at each echelon maintain copies of SFOD's after-action report. The unit historian reviews this report and prepares a draft historical report.

Report of Lessons Learned

Shortly after completing the after-action report, or simultaneously with its submission, the SFOD leader submits a report of lessons learned. This report is the SFOD leader's reflection on the operation and his recommendation for the future. This report organizes lessons learned according to the seven BOS (see Chapter 1). It addresses what worked and did not work on the operation, why it did or did not work, and what changes are needed in existing tactics, techniques, and procedures in the unit.

Unit Historical Report

The unit historian reviews the report of lessons learned and then finalizes the draft unit historical report and submits it for the commander's approval. He issues the official historical report of the operation, in classified and unclassified versions as appropriate, within 90 days after the completion of the operation.

Technical Intelligence Report

SFODs may encounter first seen, odd, or modified U.S. or foreign equipment. These items should be reported using a technical intelligence report (shown in Appendix D). New, modified, or enhanced equipment is not normally considered classified, but enemy-modified U.S. equipment is. For example, a discovery of a U.S. projectile modified by the enemy to accept non-U.S. fuzes would be classified. Common sense and AR 380-5 will dictate classification.

CHAPTER



EMPLOYMENT

There are no “generic” SR missions on today’s battlefields or during peace. Each mission has challenges that must be overcome through comprehensive planning. The goal of the planners must be to identify those tasks that must be accomplished to execute the OPLAN. Some of the tasks that will support the OPLAN during the conduct of SR are area assessment, target acquisition, hydrographic reconnaissance, poststrike reconnaissance, technical evaluation, NBC reconnaissance, specific data collection, and other related tasks.

AREA ASSESSMENTS

An AA is defined and discussed in FM 31-20 as part of the situation development process. AAs are not independent SR missions. The AA is often associated with infiltration, but in fact, is a continuous process. As shown in Figure 3-1 (page 3-3), the AA starts at infiltration and ends after exfiltration. AA is linked with the IPB process and is directly related to on-going and/or future operations. The AA serves as the basis for the commander’s estimate of the situation in the area of operations (AO). He uses it to modify plans made during isolation. For this reason, the information must be updated as the mission permits. The AA process can be divided into two distinct stages—initial and principal area assessments.

Initial Area Assessment

An initial area assessment (IAA) is done by the SFOD immediately upon infiltration. An example of information reported in the IAA is unexpected ground conditions that will prevent the SFOD from arriving at the target during the planned time. The IAA is reported to the rear in a timely manner. It is routinely included in the initial entry report as a one-line entry in the other information section. The exact time requirement for these reports must be part of the OPLAN. The IAA ends after it has been transmitted and received through the chain of command. The principal area assessment (PAA) then begins.

Principal Area Assessment

The primary goal of the PAA is to continually “confirm, correct, refute, or add to previous intelligence gained before infiltration.” The PAA should expand the IAA to include all aspects of the operational area. Some of the aspects are the threat, resistance movements, civil government, populace, targets, weather, terrain, and the logistical capabilities of the area.

TARGET ACQUISITION

SF conducts target acquisition for two reasons. The primary goal is to “fix” the target. An example of fixing the target is to verify the emplacement of mobile weapons systems at prepared launch sites (Figure 3-2). The second goal is to update information on known or suspected targets. To gain this information, PIR and IR must address the SIR of the follow-on DA element or of personnel deploying weapons systems against the target. During target acquisition, the SFODs continue with the AA process and report changes that could hinder the following operations. Some of the planning considerations are—

- The rules of engagement.
- Coordinated linkup operations with the follow-on forces.
- Coordinated no-fire and restrictive-fire zone for weapons systems operators.
- Political considerations.
- Effect and reaction of the local populace.

HYDROGRAPHIC RECONNAISSANCE

Hydrographic reconnaissance is the reconnaissance of operationally or strategically significant bodies of water and marginal land areas. It is conducted to determine water depths, beach gradients, the nature of the bottom, location of obstacles and barriers, speed of currents, thickness of ice, defensive preparations, and other military and nonmilitary characteristics of a target. SFODs perform hydrographic reconnaissance of point, diffuse, and linear targets that lie above and below the water line. Hydrographic reconnaissance missions conducted by SF are described below. For a detailed discussion of SF waterborne operations, see TC 31-25.

Beach Surveys

A beach survey is the collection of data describing the characteristics of a specific beach. Figure 3-3, page 3-4 is a typical beach profile. The survey is used to determine if the beach is suitable for military operations. A beach survey may be conducted openly or clandestinely using the beach survey format at Appendix D. SFODs normally conduct beach surveys to validate preexisting data. Often, these surveys are in support of other SOF. SFODs may also prepare tactical beach reports (TACBEREPs) and surf reports (SURFREPs) using the message formats at Appendix D. When reconnoitering beaches, SFODs can perform basic beach reconnaissance as depicted in Figure 3-4 and as described below.

Beach Characteristics. A beach is a strip of sand, pebbles, or other material extending inland from the line of extreme low water to the coastline. Its length is the distance along the beach at the water's edge during high and low tides between the ends of the beach. The shape of a beach is classified as straight, concave, or convex. The coastline is marked by the limit of normal wave action and is classified as cliff, dune, or plain.

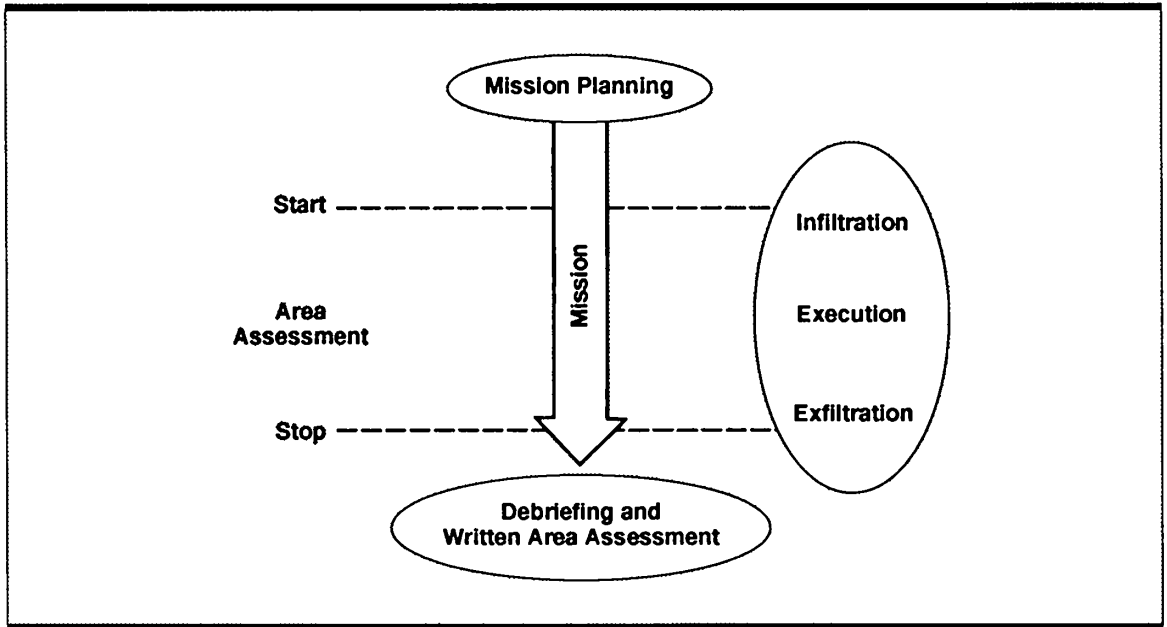

Figure 3-1. Area assessment.

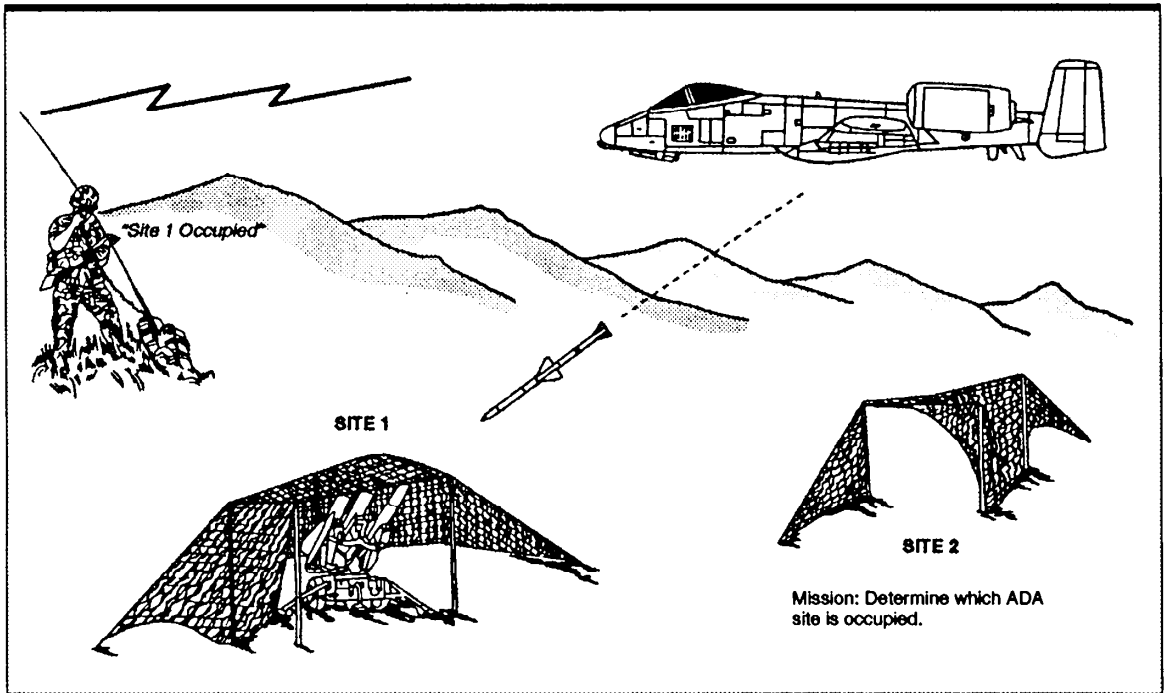

Figure 3-2. Target acquisition example.

Beach width is the average distance from the low-waterline to the coastline. The datum plane is used to determine the shoreline and the low-water line.

The foreshore is part of the shore or beach that lies between the extreme low-water line and the upper limit of normal waves. The composition of the foreshore may be silt, mud, gravel, boulders, rock, coral, or any combination. The gradient (or percentage of slope) of the foreshore is expressed as a ratio of water depth to horizontal distance. See the TACBEREP message format at Appendix D.

The Backshore width is measured from the upper limit of normal wave action inland to the extreme limit of storm wave action. Backshore gradient and composition are identified in the same manner as those of the foreshore. Vegetation is often found growing here since it is normally dry and acted upon only by storm waves.

The hinterland is the area extending five miles inland. It begins at the coastline (the first line of permanent vegetation).

Beach Survey Procedures Beach survey procedures will vary according to METT-T and the permissiveness of the environment. During the reconnaissance, each swimmer records obstacles, wave height, surf conditions, and other pertinent information. Time and azimuth are used to record distances and locations, which will be approximate even under optimal water and light conditions. The procedures described below characterize a relatively simple tactical beach reconnaissance (see Figure 3-4, page 3-5).

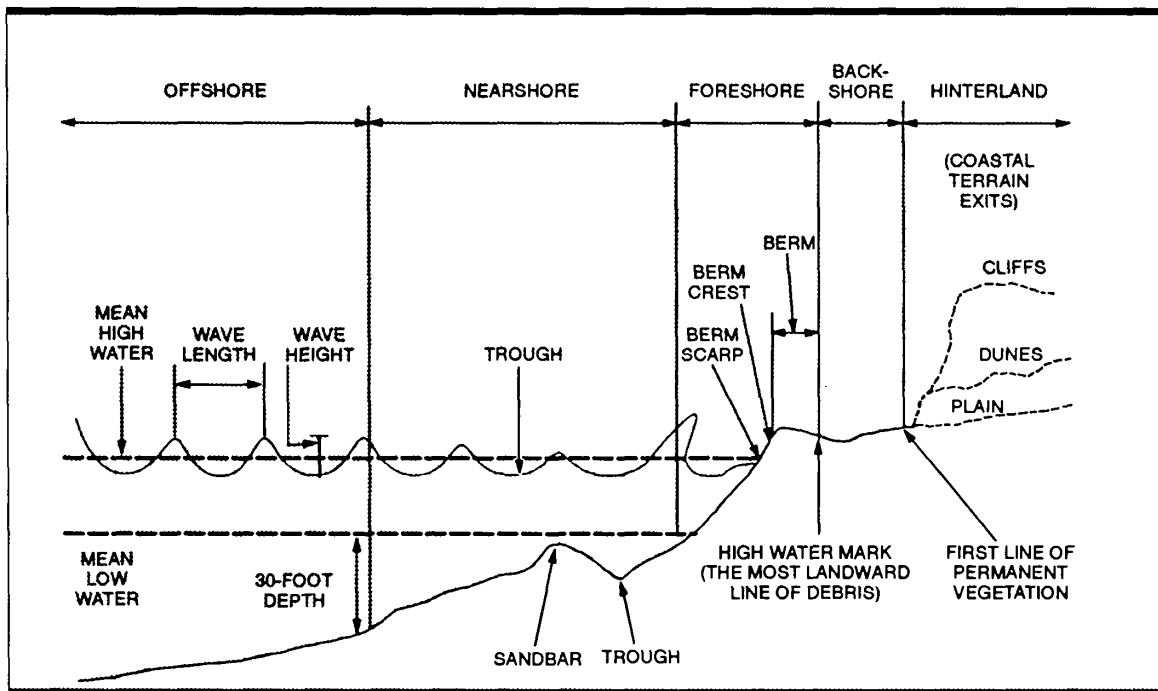

Figure 3-3. Typical beach profile.

Two-man swim teams are dropped off by aircraft or watercraft parallel to the beach and outside the surf zone. One man in each team carries a leadline for measuring depths. The other man in the team is the recorder. There are normally two swimmers for every 25 meters of beach to be reconnoitered. The team leader and assistant team leader are paired in the center of the formation and act as a guide and reference point for the other teams in the line.

Upon signal from the guide team, the swimmers move toward the beach. The guide team may use a compass to help in swimming a predetermined course to and from the beach, or it may guide on a designated object on the beach.

Teams remain at 25-meter intervals and swim parallel to each other as they slowly move toward the beach. With a current in excess of 2 knots, the SFOD will tend to drift in the direction of current.

Just outside the surf zone, each team halts and examines the beach and as far into the backshore as can be seen.

When the leadline man in each team estimates the depth is 6.5 meters (usually the depth at which recordings are first made), he lowers his line.

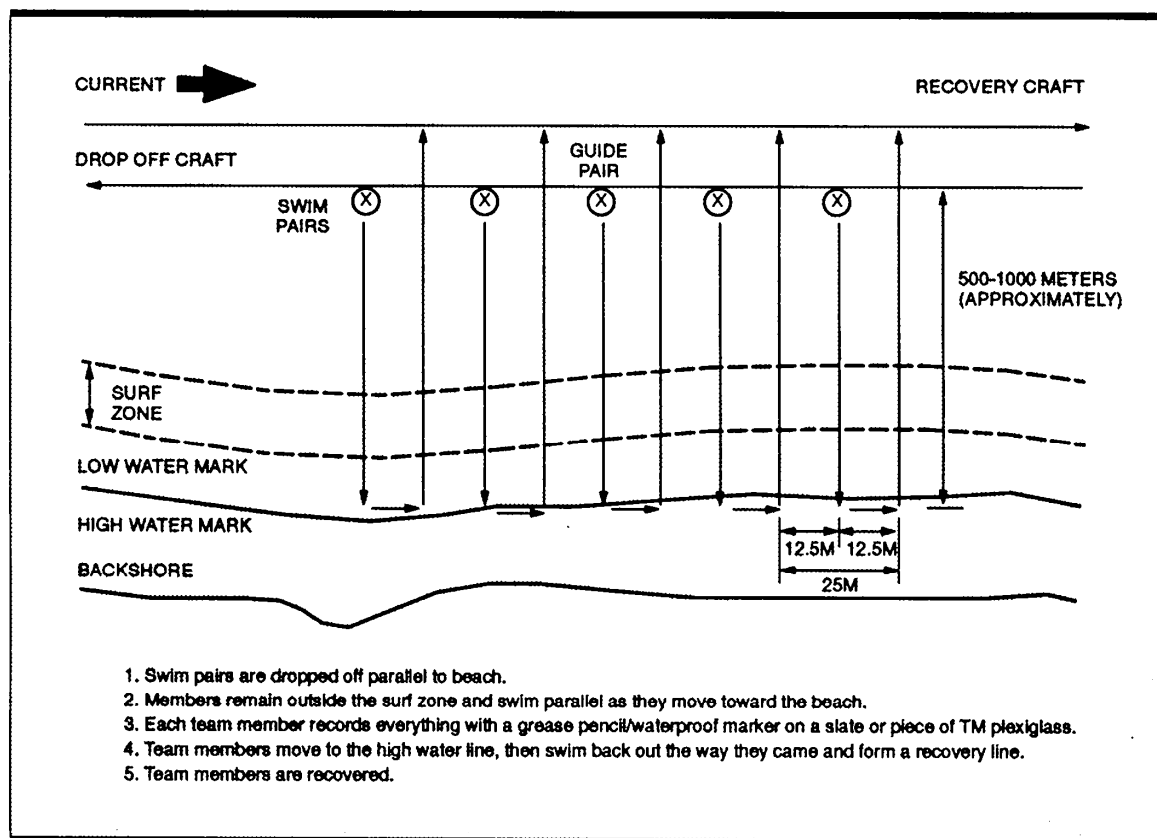

Figure 3-4. Tactical beach survey procedures.

When the leadline touches the bottom, the leadline man notifies his buddy (the recorder) who signals the guide team to stop. The recorder records the depth on his slate.

The guide team estimates the distance to the high watermark and signals all teams to take a sounding.

From this point on, soundings are recorded every meter towards the target area until a 1.8-meter depth is reached and then at 0.3-meter increments up to the water's edge. Whenever a swim team reaches a 5.5-, 3.6-, or 1.8-meter sounding, it also takes a bottom sample. On the seaward lane the process is reversed.

At the high waterline (or at the water's edge if the team leader has determined that is the safe limit for the team), all teams shift left 12.5 meters with each team recording the beach gradient and any other significant foreshore, backshore, or hinterland features in its area. A technique for measuring the beach gradient is illustrated in Figure 3-5. Each swim team also covers its assigned sector of fire to protect the team from surprise attack from its front or flanks.

When the shift left has been completed, all teams swim back out to sea, taking soundings as before, following the guide pair. Once the mission is complete, the swim teams will then be extracted. Extraction may be at a prearranged time or after a prearranged signal from the pickup craft.

Key Points. Several key points need to be kept in mind as the SFOD conducts a tactical beach survey.

One team of swimmers should be designated beforehand to observe the surf for a SURFREP rather than take soundings during the reconnaissance.

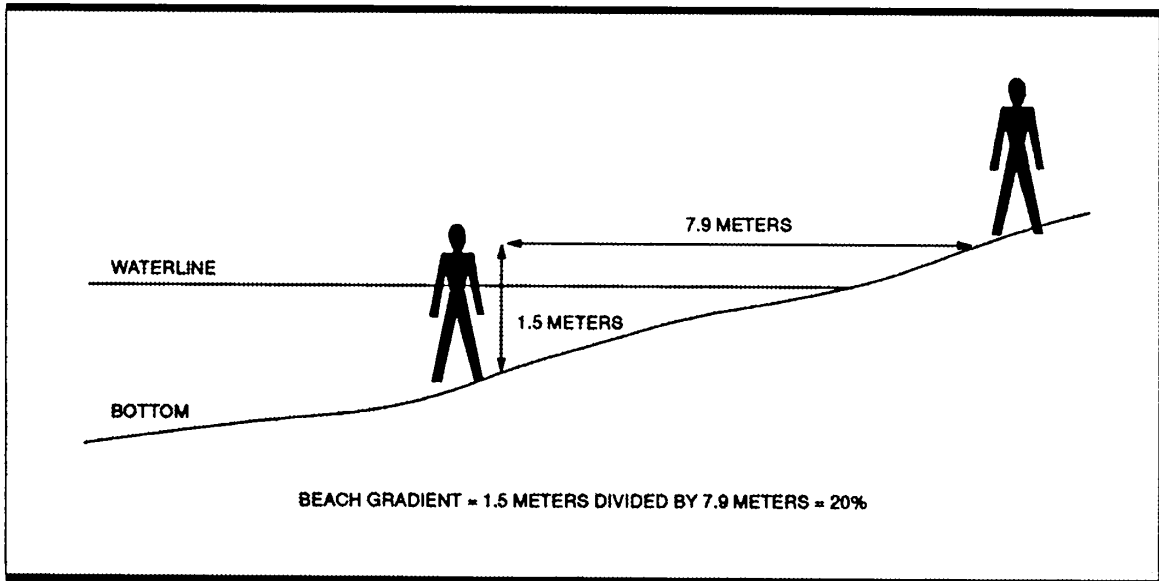

Figure 3-5. Measuring beach gradient.

If the reconnaissance is to be accurate, the swim teams must maintain the proper interval and all pairs must follow the guide throughout the reconnaissance. Another technique to add accuracy is to have a third swimmer with a 25-meter line accompany the guide pair, he can swim ahead to where the next sounding should be taken. This procedure can also help verify the guide's initial distance estimate.

When making a dive during a tactical survey, swimmers must ensure noise and/or light discipline for security purposes. Swimmers should be careful to avoid detection from the beach. They should avoid allowing the sun to reflect off the face mask, holding the line or slate above water when sounding or recording, proceeding into shallow water, or raising the body out of the water when close to the beach.

During each beach survey, thorough photographic coverage is essential. See Appendix C. The areas to be covered are—

- Offshore to hinterland panoramas.
- Backshore and hinterland panoramas.
- Beach exits.
- Hinterlands.
- Miscellaneous.

From both the left and right flanks of the beach, standing at the water's edge, the photographer takes overlapping panoramic views beginning offshore and sweeping inshore. If light conditions permit, a videocamera is used. The frames show the approaches, reefs, waterlines, full length of the beach, full width of the beach, and beach gradient.

From the scarp at the center of the beach, the photographer takes a panorama of the backshore and hinterland, ridges, escarpments, vegetation, and obstacles.

The photographer obtains medium views and close-ups emphasizing location, surrounding features, and trafficability. He takes views from the beach facing inland and from the high ground inland facing seaward.

The frames of the hinterland show vegetation, soil and rock types, trafficability indications such as wheel tracks and swamp areas, obstacles, habitation, roads, and defenses or defensible positions.

The photographer takes pictures that show conditions or obstacles that will help identify the material composition and trafficability of the beach. He should take complete coverage (including close-ups) of any features encroaching on or limiting the usefulness of the landing areas, such as hazards to approach and barriers to egress. He includes personal or familiar objects in photographs to help the interpreter in determining measurements. All photographs are logged as described in Appendix C.

Hydrographic Surveys

A hydrographic survey is the collection and assessment of data about specific bodies of water and marginal land areas and their effects on operations. A hydrographic survey and beach survey overlap in that they both involve the collection of data relative to the foreshore area. The survey may be conducted openly or

clandestinely. SFODs normally do hydrographic surveys to confirm or verify information on a particular body of water and marginal land areas. The hydrographic survey report is written in message format, depending on mission requirements. The written report may be accompanied by sketches (see Figure 3-6), overlays, photographs, and exposed film, bottom samples from the foreshore and nearshore approaches are also attached to amplify information contained in the report. The sketch that accompanies the report is to scale. It shows the shoreline; the 1-, 2-, and 3-fathom curves; the foreshore; obstacles cultural features; beach flanks; and beach interruptions as seen from above. The sketch depicts the nearshore and foreshore gradients by showing three cross-sections taken at the beach center and in the middle of the left and right sections of the beach. The vertical scale of the cross-sections is usually larger than the horizontal scale of the cross-sections. All soundings by the survey party are shown on the sketch. The intelligence NCO, under the supervision of the SFOD technician, prepares the hydrographic survey report in accordance with the format at Appendix D. In the course of doing a hydrographic survey, the survey team may prepare SURFREPs and river/estuary reports (DELTREPs).

Ports Reconnaissance

A port is a town or city having a harbor for ships taking on or discharging cargo. Because of the high density of man-made structures and their relevance to SO, the SR of ports combines the techniques of hydrographic survey; AA; technical evaluation and CARVER analysis; and mapping, sketching and photographing (Appendix C). SFODs can conduct port reconnaissance overtly or clandestinely. The emphasis in port reconnaissance is the identification, location, and assessment of critical infrastructure and the accessibility and vulnerability of that infrastructure. At a minimum, port surveys address—

- Access routes, capacities, and conditions of cargo, refueling, and repair berths and other facilities.
- Bulk energy production, storage, transmission, and distribution (petroleum, oils, and lubricants [POL], electric power).
- Telecommunications (radio, television, telephone).
- Transportation, LOC, and associated facilities (railroads, highways, bridges, and airfields).
- Bulk water supply.
- Bulk storage of dry goods.
- Health services.
- Government administration and services.
- Fire and security services.
- Local military forces.

Waterway Reconnaissance

Waterways include trafficable estuaries, rivers, canals, locks, and other associated structures such as bridges and dams. SFODs perform waterway surveys in much the same way as they do coastal hydrographic surveys. The basic message format used is the DELTREP (Appendix D). In inland surveys of integrated transportation, the SFOD maps out the transportation network infrastructure, focusing on critical nodes and choke points within this network. The basic message formats used in the reconnaissance of land routes are the routes and roads report (ROUTEREP) and bridge report (BRIDGEREP).

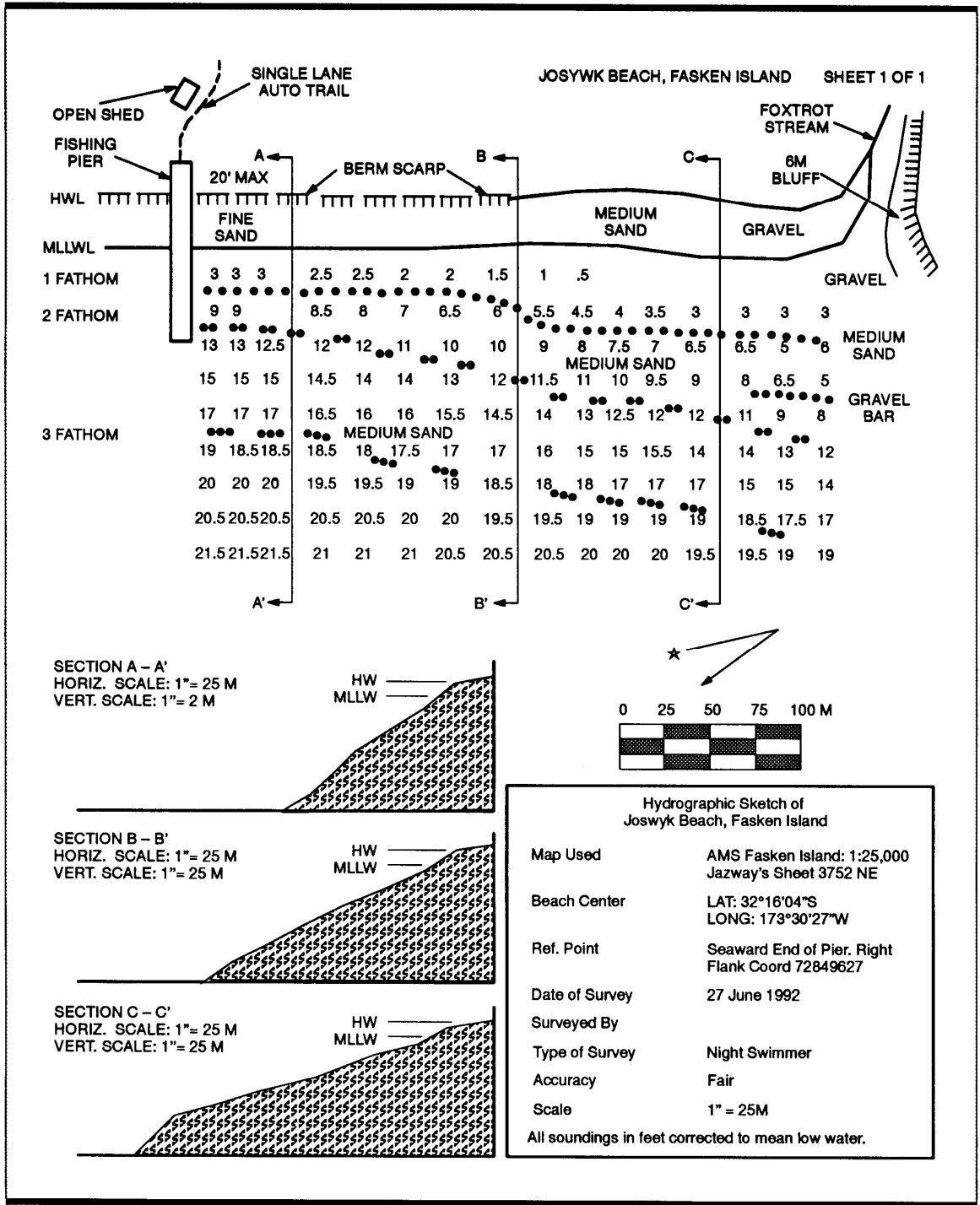

Figure 3-6. Hydrographic survey sketch.

METEOROLOGICAL RECONNAISSANCE

Sudden changes in weather conditions often play a major role in the execution or development of military plans. Meteorology for a specific area plays a major role in determining mission requirements. The two areas most affected by the weather are transportation and supply activities. Commanders need to have a clear and current understanding of all aspects of the JSOA. SF units conducting meteorological reconnaissance can provide information that will help commanders determine where they can maneuver their units to best exploit their strengths against the threat's weaknesses. Learning the true amount of illumination passing through dense foliage or the fordability of a rain swollen river or the trafficability of a region all fall under this area of SR. As mentioned before, SFODs should cross reference information available from other national assets such as satellites or sources currently in the JSOA.

GEOGRAPHIC RECONNAISSANCE

Like meteorological reconnaissance, geographic reconnaissance may be required to support developing or existing plans. Specific questions about planned routes can help commanders determine what vehicle or unit will best be able to execute the mission at hand.

POSTSTRIKE RECONNAISSANCE

Poststrike reconnaissance is the visual, photographic, and/or electronic survey to measure results of a specific point or area of operational, tactical, or strategic significance that has been subjected to a strike. Effects measured by an SFOD may be of a military or nonmilitary nature, addressing material, informational, economic, psychological, or cultural impacts of the strike. A poststrike reconnaissance by SFODs may be a short-term survey to determine immediate and collateral material damage.

Information Requirements

If the reconnaissance is of a strike by friendly forces, SFOD preparation for post-strike reconnaissance begins with the question "What was the type and extent of the damage intended, as stated by the commander ordering the strike?" If the reconnaissance is of a strike by threat forces, the starting point is the assumed intent of the threat commander. The SFOD organizes its efforts to gather indicators and other information that will aid the senior intelligence officer (SIO) in the FOB in answering the following SIR:

- What was the weapon used?
- What did the strike actually hit (stated in terms of actual point[s] of impact, immediate damage, and collateral damage)?
- Was the intended type and extent of damage or effect achieved?
- To what degree was effect achieved (stated as intended point or points of impact, distance and azimuth from the intended point[s] of impact, and a percentage of damage)?

- What part of the target was hit or missed?
- Was the prestrike target analysis accurate and adequate? If not, what were the deficiencies?
- What is the target activity as a result of the strike?
- Are forces on or near the target employing any special or unique recovery equipment, techniques, or procedures?

Employment of SFODs

SFODs should be committed to poststrike reconnaissance only where the data to be collected is of the utmost strategic importance and cannot be collected by other means, for example, aerial reconnaissance, satellite, unmanned aerial vehicle (UAV), developed human sources. SFODs should not be sent to confirm if every mission hit the target because the indiscriminate employment of SFODs may establish a pattern, alerting threat forces, increasing risk of detection and compromise, and degrading the probability of mission success. Threat forces quickly become aware of a pattern of sending in reconnaissance teams on poststrike assessments and actively seek to interdict and destroy them.

Techniques and Procedures

During the poststrike mission certain locations must be determined. To collect the needed information on these locations, SFODs use a variety of standard and nonstandard techniques and procedures in poststrike reconnaissance.

Reconnaissance and Surveillance. To collect the needed information, SFODs normally conduct patrolling and/or set up observation and surveillance sites. The emphasis is on offset methods in most cases as opposed to actually entering or traversing the target.

The intended point of impact (POI) is that specific point on the ground where the ordnance was to impact. The SFOD may be given only a general idea of its location in relation to its target. In most cases, the POI will be identifiable as a crater or a scorched area.

Damage in the area of effect (AOE) maybe classified as immediate or collateral. Immediate damage is that damage directly inflicted by the ordnance at the moment of its impact and/or detonation. Collateral damage is the secondary effects of the ordnance. Fires, structural weakening and/or collapse, abandonment or reinforcement of the target are all secondary effects. Taken together, the areas of immediate and collateral damage constitute the AOE.

When planning a poststrike mission, the SFOD must consider the minimum safe distance (MSD) and what will happen if the target has not sustained the desired effect? Will another mission be fired or flown? If so, what will be fired or dropped? This information will be important when planning the safe distances required for the placement of the observation and surveillance sites, mission support sites, or other fixed locations. Planning should also include establishing an exclusionary zone from which all patrols must depart before ordnance is delivered. This procedure aids commanders in ensuring that friendly fire casualties are avoided. Safe distances can be calculated by using Figure 3-7, page 3-12. An example of a poststrike overlay depicting the POI, AOE, and MSD is shown in Figure 3-8, page 3-12. Other specific ordnance safety considerations used when moving around an area where different types of munitions have been used are addressed in Appendix I.

EXPLOSIVE WEIGHT		SAFE DISTANCES FOR PERSONNEL IN THE OPEN	
KG	LB	METERS	FEET
.45 to 12.3	1 to 27	300	900
45.4	100	465	1,390
113.8	250	630	1,890
226.8	500	800	2,400
453.6	1,000	1,600	4,800
907.2	2,000	3,200	9,600

Weights not found in this chart can be calculated using the following formula:
 SAFE DISTANCE IN FEET = 100 x (EXPLOSIVE WEIGHT x .33)

NOTE: All distances are calculated for soldiers in open flat terrain.

Figure 3-7. Safe distances for standard bomb sizes.

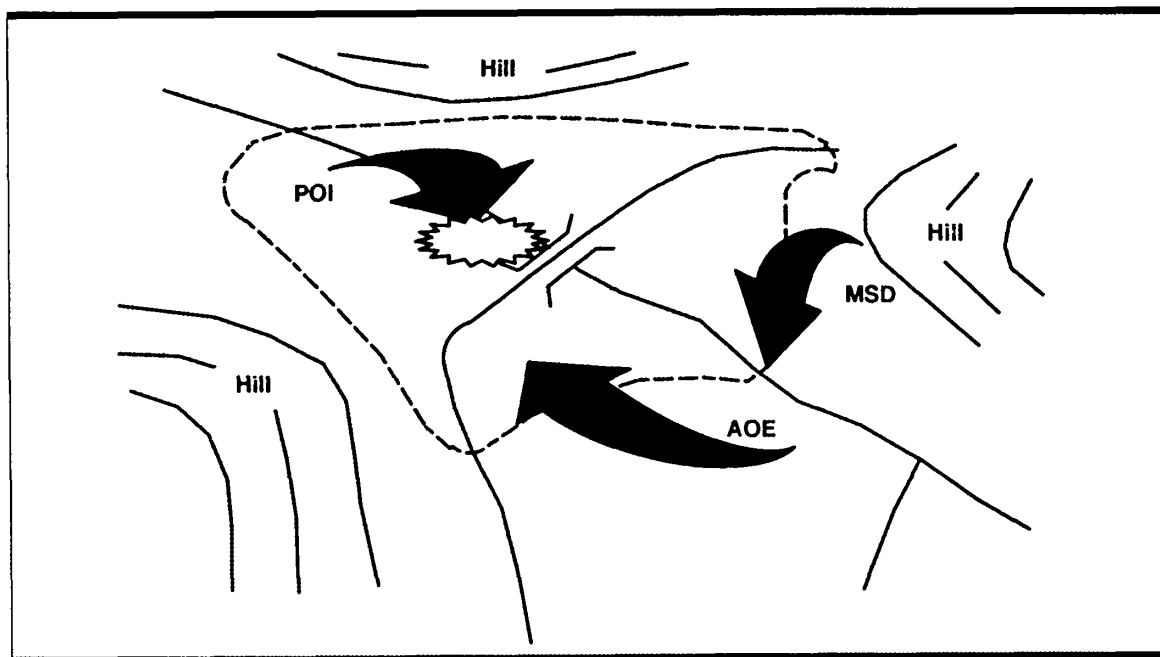

Figure 3-8. Poststrike overlay.

Records. Complete records must be maintained during the conduct of the post-strike mission. These records should include maps, sketches, photographs, notes, and other records of the SFOD's observations. Record keeping is discussed in Appendix C.

TARGET ANALYSIS

TA is the assessment of a specific, technically complex target in the context of PIR, IR, and/or SIR grouped into the categories of criticality, accessibility, recuperability, vulnerability, effect, and recognizability. An SFOD may, for example, conduct a TA of an industrial establishment or other technically sophisticated complexes for follow-on DA or UW attack. The same sort of analysis can allow an HN government to defend such a complex in a FID environment. The CARVER target analysis matrix and the feasibility assessments are the foundation of the TA process. The FA is an evaluation of the risks of a mission, and it answers questions of whether the attacking force can complete the mission and survive. TA is a cooperative effort between the SFOD performing the SR mission and the intelligence functions at battalion and company level. This analysis seeks to answer PIR/IR and SIR in the CARVER target analysis matrix categories. Target analysis is the responsibility of the battalion S2, but the SFOD can often be used to answer SIR that can be satisfied by no other means. Preparation for TA requires review and understanding of the steps in the process described below.

TA Steps

TA can be overt or clandestine. It can be conducted as part of a larger AA, or it can be a distinct mission activity. It can take place during peacetime competition, conflict, or war. It is often more than a traditional reconnaissance and less than a full-scale analysis. It comprises the cyclic steps outlined below.

Step One. The first step is a joint S2 and SFOD review of the commander's guidance and stated requirements, which set out what is to be accomplished regarding the target. In a FID environment, this step includes an evaluation of the threat to the target.

Step Two. The second step is the gathering, organizing, and evaluating of all available information about the target and the identification of gaps in the data. The S2 provides maps, photographs, flow charts, blueprints, diagrams, and other data for review. With the help of the S2, the employed SFOD examines the information to answer as much of the mission PIR and/or IR before infiltration. The S2 begins preparing a CARVER report and "target folder" that highlights the gaps in available information at this step and uses them to develop a detailed collection plan.

Step Three. After infiltration, the SFOD surveys the target. In a nonpermissive environment, the SFOD ordinarily tries to penetrate the target area and set up fixed sites to survey the target and/or run small patrols into the target (particularly if it is a complex spread over a wide area). The SFOD gathers information that—

- Validates data gathered and conclusions drawn up to this step.
- Satisfies PIR and IR.
- Gives the supported targeting analyst and/or the SFOD a "feel" for the target.

If the survey is overt and with the cooperation of personnel working at the site, the SFOD follows the rules in the target survey checklist shown in Figure 3-9.

Step Four. The fourth step is the completion of the CARVER reconnaissance report and its transmittal to the battalion S2. Figure 3-10 is a checklist showing the minimum recommended data requirements for a CARVER reconnaissance report prepared by an SFOD.

- Note layout, construction, location and composition of key components, security, and communications.
- Find out what the key components of the site are likely to be by previsit research, and check this information against what you see or are told on the site.
- Determine who the key personnel at the site are and what they do.
- Get permission to take photographs prior to taking any.
- Look for those things that would be important if the site had to be attacked in the future.
- Dress neatly but not conspicuously and in a manner that blends with the environment (for example, no "Death From Above" T-shirts).
- Note manufacturers and model numbers of key components. Find out which, if any, of these components are made by cast methods or are otherwise extremely difficult to replace.
- Be conscious of where you are on site at all times in relation to key components and notice what type of machinery or equipment is in your immediate vicinity.
- Try to discern how the site is similar to other sites in its class; note any significant differences.
- Take brief but good notes. Ensure that notes do not comment on security or access and/or egress points.
- Be polite and attentive when someone from the site is speaking. Direct questions one at a time to your host.
- Do not badger guides with persistent questions about subjects they are unsure about or do not want to discuss.
- Avoid making comments about perceived lax security.
- Do not wander away from the tour group or into restricted areas; such conduct will offend your host.
- Do not smoke where there is even a remote fire hazard or without the permission of your host.
- Be especially alert for flow charts and layout diagrams.
- Get the name, job title, and telephone number (or mailing address) of persons at the site who act as your host, for example, by asking for a business card. Send the person a thank-you note after the tour.
- Do not volunteer any more information about yourself or your purpose than is necessary to accomplish your mission.
- Log the direction and location of each picture.
- Ask for informational handouts, such as illustrated public relations literature, that provide technical information about the site.

Figure 3-9. Target survey checklist.

CARVER Matrix

The SFOD can reproduce the results of its TA graphically in a matrix through which target variables are reduced to numbers (Figure 3-11, page 3-16). This matrix is a tool for rating the relative desirability of potential targets and for allocating resources for subsequent DA. Normally, the SFOD, company, and battalion intelligence NCOs jointly prepare the CARVER matrix. A 10-point scale is used to measure each of the CARVER variables.

Criticality. A target is critical when its damage or destruction will have a significant influence on military, political, or economic operations. SFODs consider each target in relation to other elements of the particular target system or target complex nominated or designated for attack. The criticality of the target changes with the situation. For example, when one has few locomotives, railroad bridges may be less critical as targets; however, safeguarding bridges may be critical to maneuvering GP forces who use such bridges. The standard of assigning criticality values on CARVER matrixes is shown in Figure 3-12, page 3-16. Criticality depends on several factors:

- **Time:** How rapidly will the impact of the target attack affect operations?
- **Qualify:** What percentage of output, production, or service will be curtailed by target damage?
- **Surrogates:** What will be the effect on the output, production, and service?
- **Relativity:** How many targets are there, what are their positions, how is their relative value determined, and what will be affected in the system or complex?

<input type="checkbox"/> Site/system/complex layout diagram with north arrow and scale.
<input type="checkbox"/> CARVER assessment. (Focus on accessibility, vulnerability, and recognizability.)
<input type="checkbox"/> Map coverage of 1:250,000 out to 50 nautical miles (NM), 1:50,000 out to 10 NM, and 1:25,000 out to 5 NM from the target with significant installations and activities noted. (Do not overlook unusual and nonstandard map coverage. Examples include foreign military or civilian maps [with no grid lines, strange scales and the like], street plans, water line plans, and power grid maps.)
<input type="checkbox"/> High-angle overhead, oblique overhead, and ground photography of the target with annotations of installations, activities, and differences observed.
<input type="checkbox"/> Site communications and electronics data (for example, gathered by an attached SOT A).
<input type="checkbox"/> Locations of the nearest fixed-wing capable airstrip and fixed-wing capable instrumented airstrip, ground distances from each of the above airstrips to the target, and the nearest drop zones (DZs), landing zones (LZs), and beach landing sites (BLSs).
<input type="checkbox"/> Summary of local human and material resources available to support special operations.
<input type="checkbox"/> List of sources used.

Figure 3-10. CARVER reconnaissance report checklist.

FOSSIL-FUEL BULK POWER PLANT							
TARGET COMPONENT	C	A	R	V	E	R	TOTAL
FUEL TANKS	8	9	3	8	5	6	39
FUEL PUMPS	8	6	2	10	2	3	31
BOILERS	6	2	10	4	7	4	33
TURBINES	8	6	10	7	9	9	49
GENERATORS	4	6	10	7	9	9	45
CONDENSERS	8	8	5	2	9	4	36
FEED PUMPS	3	8	5	8	4	6	34
CIRCULATING PUMPS	3	8	5	8	6	4	34
STEP-UP TRANSFORMER	10	10	10	9	10	9	58

LOW - 1 AVERAGE - 5 HIGH - 10

ENEMY ← ADVANTAGE → FRIENDLY

Figure 3-11. CARVER matrix.

CRITERIA	SCALE
Immediate halt in output, production, or services target cannot function without.	9-10
Halt within 1 day or 66% curtailment in operations.	7-8
Halt within 1 week or 33% curtailment in operations.	5-6
Halt within 10 days or 10% curtailment in operations.	3-4
No significant effect on operations.	1-2

Figure 3-12. Assignment of criticality values.

Accessibility. A target is accessible when an operational element (including knowledgeable insiders) can infiltrate the target with sufficient personnel and equipment to accomplish its mission. Assessing accessibility entails identifying and studying critical path(s) that the operational element must take to achieve its objective(s) and measuring those things that aid or impede access. The standard for assigning accessibility values on CARVER matrixes is shown in Figure 3-13. Accessibility may be broken down into three parts:

- Infiltration from the staging base to the target area.
- Movement from the LZ, DZ, BLS, or other entry points to the proximity of the target.
- Movement into the target and onto the critical element(s).

In most cases, assessing the critical path(s) an SFOD performing a DA mission must take to exfiltrate the target area is desirable. Factors to consider when evaluating accessibility include man-made and other barriers and obstacles, active and passive early warning systems, swimmer detection devices, air defense capabilities in the target area, road and rail transportation assets, land use, cover and concealment, and population density. The analysis along each critical path to the target should measure the time it would take for the SFOD to bypass, neutralize, or penetrate barriers and obstacles along the way. Accessibility is measured in terms of relative ease or difficulty of movement for the SFOD and the likelihood of detection. Analysts should always consider the use of standoff weapons such as mortars or antitank type weapons in such evaluations.

Recuperability. A target's recuperability is measured in time, that is, the time it will take to replace, repair, or bypass destruction of or damage to a target. Recuperability varies with the sources and type of targeted components in the target complex. Recuperability should factor in such items as stockpiles, backup systems, repair facilities, and spare parts. The standard for assigning recuperability values on CARVER matrixes is shown in Figure 3-14, page 3-18.

CRITERIA	SCALE
Easily accessible, standoff weapons can be employed.	9-10
Inside a perimeter fence but not inside the building.	7-8
Inside a building but on the ground floor.	5-6
Inside a building but on the second floor or in the basement; climbing or lowering required.	3-4
Not accessible or accessible with extreme difficulty.	1-2

Figure 3-13. Accessibility value standards.

Vulnerability. A target is vulnerable if the SFOD has the means and expertise to successfully attack the target. When determining the vulnerability of a target, the SFOD A compares the critical component with the capability of the attacking element to destroy or damage it. In general, the attacking element may tend to choose special components, do permanent damage, prevent or inhibit cannibalization, maximize effects through use of on-site materials, and/or cause the target to self-destruct. Vulnerability depends on the nature and construction of the target, amount of damage required, and the assets available. Examples include personnel, expertise, motivation, weapons, explosives, and equipment. The standard for assigning vulnerability values on CARVER matrixes is shown in Figure 3-15.

CRITERIA	SCALE
Replacement, repair, or substitution requires 1 month or more.	9-10
Replacement, repair, or substitution requires 1 week to 1 month.	7-8
Replacement, repair, or substitution requires 72 hours to 1 week.	5-6
Replacement, repair, or substitution requires 24-72 hours.	3-4
Same day replacement, repair, or substitution.	1-2

Figure 3-14. Recuperability value standards.

CRITERIA	SCALE
Vulnerable to long-range laser target designation, small arms fire, or charges of 2.2 kilograms (kg) or less.	9-10
Vulnerable to light antiarmor weapons fire or charges of between 2.2 and 4.5 kgs.	7-8
Vulnerable to medium antiarmor weapons fire, bulk charges of between 4.5 and 13.6 kgs, or very careful placement of smaller charges.	5-6
Vulnerable to heavy antiarmor fire, bulk charges of between 13.6 and 22.6 kgs, or special weapons.	3-4
Invulnerable to all but the most extreme targeting measures.	1-2

Figure 3-15. Vulnerability value standards.

Effect. The effect of a target attack is a measure of possible military, political, economic, psychological, and sociological impacts at the target and beyond. Closely related to the measure of target criticality is the type and magnitude of given effects desired that will help planners select targets and target components for attack. Effect in this sense, however, addresses all significant effects, whether desired or not, that will likely result once the selected target component is attacked. Traditionally, this element has addressed the effect on the local populace, but now broader considerations are addressed as well. For example, the primary effect of the destruction of two adjacent long-range radar sites in an early warning system may be to open in the system a hole of sufficient size to cause enough down time to permit the attacker to launch a successful airmobile or missile strike against the defender. Effects can also include the triggering of countermeasures, support or negation of PSYOP themes, unemployment, reprisals against the civilian populace, collateral damage to other targets, and the like effects. Possible effects can be speculative (and should be labelled as such), and effects of the same attack maybe quite different at the tactical and the operational and/or strategic levels. An example of speculative effects is the destruction of a substation that does not affect local power supply but cuts off all power to an adjacent region. The standard for assigning effect values on CARVER matrixes is shown in Figure 3-16, page 3-20.

Recognizability. A target's recognizability is the degree to which it can be recognized by an operational element and/or intelligence collection and reconnaissance assets under varying conditions of distance, weather, light, and season without confusion with other targets or components. Factors that influence recognizability include the size and complexity of the target, the existence of distinctive target signatures, the presence of masking or camouflage, and the technical sophistication and training of the attackers. The standard for assigning recognizability values on CARVER matrixes is shown in Figure 3-17, page 3-20.

NUCLEAR, BIOLOGICAL, AND CHEMICAL RECONNAISSANCE

NBC reconnaissance can be in a wide range of forms. For example, overflights can be used to look for dead vegetation and wildlife. However, if a possible NBC area is encountered, commanders will have many questions such as—

- When and where did the NBC strike occur?
- Will the threat continue using NBC weapons?
- Were the weapons effective?

Given the effectiveness of modern weapons, questions concerning NBC use will have a high priority on the PIR and IR lists. One of the first questions should be whether or not anything happened at all. For example, industrial accidents or attacks on industrial facilities often produce effects similar to NBC strikes. If, on the other hand, NBC use can be confirmed, the battlefield commander is then permitted to request a response in kind. The theater commander would task the SF group through the SOC to obtain samples and information that confirm or deny NBC use. SFODs supported by group chemical assets, such as the LB team, can perform this type of mission.

The primary problem with using SF soldiers to conduct NBC reconnaissance is that extensive training and equipment are required. Such NBC training and equipment are not normally afforded to SFODs. This void was identified and filled by LB teams, who have been assigned to SF groups. The LB team has the special skills and equipment to conduct this hazardous mission when augmented to SFODs. For a further explanation of the role of SF and non-SF units during chemical operations, refer to Appendix E and FM 3-18.

CRITERIA	SCALE
Overwhelmingly positive effects; no significant negative effects.	9-10
Moderately positive effects; few significant negative effects.	7-8
No significant effects; neutral.	5-6
Moderately negative effects; few significant positive effects.	3-4
Overwhelmingly negative effects; no significant positive effects.	1-2

Figure 3-16. Effect value standards.

CRITERIA	SCALE
The target is clearly recognizable under all conditions and from a distance and requires little or no training for recognition.	9-10
The target is easily recognizable at small-arms range and requires a small amount of training for recognition.	7-8
The target is difficult to recognize at night or in bad weather or might be confused with other targets or target components and requires some training for recognition.	5-6
The target is difficult to recognize at night or in bad weather. Even within small-arms range, it is easily confused with other targets or components and requires extensive training for recognition.	3-4
The target cannot be recognized under any conditions, except by experts.	1-2

Figure 3-17. Recognizability value standards.

SPECIFIC INFORMATION AND OTHER COLLECTION REQUIREMENTS

Specific data collection (SDC) is the most common task associated with SR. The SFOD conducts SDC mission to collect a specified piece or type of information. Normally, an SFOD conducts SDC as the collateral requirements of SR, that is, the requirement to infiltrate, to operate, and to exfiltrate undetected. The most common types of SDC include but are not limited to LOC surveillances, point target surveillance, information collection, and signal intercept.

LOC Surveillance

In this type of operation, the SFOD infiltrates a JSOA and establishes surveillance along the specified LOC. The LOC could be a major highway, a rail line, or even a canal, along which significant traffic passes or is expected to pass. The SFOD then collects and reports information concerning activity along the LOC based upon predetermined or specified significant indicators. These indicators are normally pieces of equipment, types of units, or even certain types of activities. The indicators may themselves be innocuous, but their presence or absence along the LOC may provide significant operational or strategic intelligence. Examples of significant indicators are NBC delivery means, chemical decontamination equipment, air defense artillery (ADA) system radars, special purpose troops, large or unusual troop or equipment convoys, refugee movements, specialized unit equipment, security force activities, or heavy construction activities.

LOC surveillance units provide the CINC or JTF commander "eyes on" HUMINT of threat operational or strategic intent. SFODs receive this tasking because it is beyond the capability of other means or because the tasking authority needs the flexibility that human operators provide.

The success of SFODs conducting this type of surveillance often depends on their ability to avoid compromise. Operational security requirements drive many of the considerations that determine infiltration and/or exfiltration means as well as the surveillance and observation technique and equipment selected to perform the mission. Almost exclusively, these missions will require static observation techniques. Movement equates to compromise! The SFOD must consider METT-T when selecting LOC observation sites. Site selection drives the SFOD's ability to place constant observation on the LOC. Use of visual observation aids (binoculars, scopes, cameras) and thermal or infrared devices increase the SFOD's stand-off distance and lessens the risk of compromise. Poor weather or heavy vegetation may require the SFOD to use multiple sites to achieve constant observation.

Specific Target Surveillance

Specific target surveillance is much like LOC surveillance. For example, an SFOD assigned this mission infiltrates and observes a specific target, location, or activity such as threat strength or activity at a suspected supply base, prisoner-of-war (PW) compound, air base, or missile launch site. Unlike LOC surveillance, the SFOD does not have the same options in selecting its observation site(s). Vantage points may be limited or restricted in terms of how they may be used to accomplish the mission. SFODs consider all METT-T factors when selecting proposed sites.

SFODs conduct specific target surveillance missions to collect, confirm, or refute intelligence about a target(s). This information, once processed, is used to plan

interdiction missions or to support DA missions against the target(s) in question. The SFOD tasked with the surveillance mission does not routinely “rollover” and conduct the DA against the target. That mission normally will be tasked to another SFOD that will specifically plan DA against the target using the information provided by the SR element.

JR for these missions are normally worded very precisely. If vaguely presented, the SFOD ensures clarification early in the mission planning cycle. Often, the IR or their associated reporting requirements determine observation site selection or the surveillance technique selected to effect the mission. For example, a large compound can require the use of multiple sites to ensure sufficient coverage. These large targets present command and control problems and heighten the risk of compromise. Multiple sites pose special problems for the SFOD communications capabilities, especially in the numbers and types of radios required. Multiple surveillance sites also require the SFOD to determine its internal communications needs whether the element acts independently or in coordination with other elements. The SFOD always balances security considerations against execution techniques.

A key to mission success during SR is the ability to infiltrate the target area, gain all available information, then exfiltrate while the threat remains unaware of the SFOD's presence.

Information Collection

This term generically addresses those SR missions to obtain information previously unknown or to refute or confirm specific information about a target that does not neatly fall under the category of surveillance. Examples of this type of SR include NBC agent confirmation; soil, water, or air survey and/or sampling; mute reconnaissance DZ and/or LZ surveys; or any other specific data requirements. Such a mission is almost always limited to the specific data or indicators required.

Often, these missions require the SFOD to conduct mission-specific skill training or to accept augmentation by non-SF subject matter experts. Augmentation may entail an LB team, topographic or civil engineers, explosive ordnance disposal (EOD) soldiers, or scientific specialists such as toxicologists or meteorologists. When augmenters conduct a mission, special premission training is required for both the SFOD and the augmenters. Regardless of the rank of the augmentee, the SFOD is responsible for safe infiltration, security, and exfiltration as well as reaction to contingencies. Specialists focus on their specialty, while the SFOD supports them.

Once the SFOD collects the information, it forwards that information to the FOB. The SFOD must know when there is enough information to warrant a report.

Signal Intercept

An SFOD tasked to conduct signal intercept operations requires extensive language and equipment training. For this reason, a SOT A, found in the battalion military intelligence detachments (MIDs), is attached to an SFOD to conduct signal intercept operations. Signal intercept missions, both voice and code, are closely controlled by the theater intelligence center. The SOT A collects information that may have tactical, operational, or strategic value. This information almost always passes from the SOT A and terminates at the SFOB's or FOB's sensitive compartmented information facility (SCIF).

When a SOT A performs this type of SR in a nonpermissive environment, it normally is attached to an SFOD. This augmentation occurs because the MOS training of the SOT A covers only general soldier skills and its signal collection training. The SFOD conducts joint mission planning and premission training to ensure all participants understand their responsibilities. FM 34-36 provides a definitive explanation of SOT A and SOF intelligence and electronic warfare (IEW) operations.

INCIDENTAL INFORMATION COLLECTION

Incidental information collection is not a separate mission. It is, as the name implies, conducted “incidentally” to another mission. Incidental information collection, which is passive and overt, does not provide a reason for active information collection. Missions cannot be planned to obtain incidental information.

Incidental information collection is not conducted in response to taskings or requirements. Taskings and requirements imply that SFODs are authorized to actively collect data and that they are expected to fulfill those requirements. Incidental information collection objectives imply no such charter, and the SFOD is not held responsible for meeting them. Obtaining the data specified in incidental information collection objectives is merely an additional benefit of other activities. To specify incidental information collection objectives, the SIO reviews his existing data bases for missing or incomplete information. Additionally, he maintains active coordination with other elements that may have identified intelligence deficiencies. He should maintain these intelligence shortfalls as a standing list of IR. The SIO reviews this list when preparing a mission brief for an SFOD. Those items that do not directly relate to the tasked mission but with which the SFOD may reasonably be expected to observe become incidental information collection objectives.

After the SFOD receives the mission briefing, it reviews the incidental information collection objectives. After the SFOD A completes the POE, the intelligence sergeant analyzes it to identify likely times when locations or activities listed in the objectives may be observed. No alteration of the plan is made to increase likelihood of observing the desired data. Where the objective data itself may not be directly observable, the intelligence sergeant develops a list of indicators for SFOD members. All members are “sensitized” (made aware of) to the objectives and indicators.

The preferred means of reporting incidental information collection objectives is by including the data in routine encrypted reports at the earliest possible time. The SFOD must be sensitive to the fact that any appearance of active espionage may damage the primary mission or even jeopardize relations with the host nation. Therefore, the SFOD should limit and carefully safeguard written records. Each returning SFOD should include any incidental information in their area assessment or after action review within 24 to 48 hours after being debriefed.

For clarity, the following is an example of an SFOD involved in incidental information collection while acting as a mobile training team (MIT) tasked to conduct training in nation X at the 33d Battalion. The SFOD provides small unit patrolling training to a select border reconnaissance company. One of the SFOD’s incidental information collection objectives is to note indicators of external support

to dissidents in the 33d Battalion's area of responsibility. Such indicators may include the presence of foreign weapons and munitions, propaganda products beyond local reproduction capability, or the presence of foreign personnel in unlikely locations or numbers.

During the training, a squad leader in the border reconnaissance company produces a specific type of antitank weapon of recent manufacture that is foreign to the HN and United States. He indicates that it was recovered during a recent raid on a suspected dissident safehouse. As part of the training, he is interested in knowing the purpose of the weapon and safe handling procedures for this and similar artifacts captured in the future.

Since the SFOD clearly identified the weapon as coming from an external source and allegedly being in the possession of known dissidents, the SFOD would report the data through the battalion SIO to the interested agency. The data was obtained in the course of routine activity and was not the result of active collection attempts. Similarly, the SFOD, while eating in a local restaurant, may see high-quality anti-U.S. propaganda posters echoing certain themes. This information may be an important indicator obtained in the course of normal activities.

PREMISSION ACTIVITIES

Development of a special operations mission planning folder (SOMPF) and supporting POE is the goal of premission training. The nature of SR requires a higher degree of mission analysis, planning, and mission specific training than that associated with combat patrolling. This chapter is broken down into four sections. The first section describes mission analysis and command and staff responsibilities upon receipt of a mission tasking in a garrison posture. The second section describes the mission analysis and home station planning in support of a specific operation plan (OPLAN). The third section describes specific SR mission preparation and training done before becoming operational. The last section discusses the final preparation for planned missions and adaptive planning for emerging missions in an operational configuration.

SECTION I. MISSION ANALYSIS

Mission analysis views all sources of mission taskings and sets priorities for resources and efforts through a clear statement of the battalion commander's intent and concept of operations. It provides the basis for the battalion preparation of mission letters to the SFOD A and support platoon and/or detachment level.

PROCEDURES

Home station mission analysis follows the procedures outlined in FM 101-5. The specific application of this decision-making process to SR is described below. This process assumes the SF battalion has more than one OPLAN it may be required to execute. It is designed to allocate resources and set priorities of effort. Draft METLs are developed and refined based on specific mission planning. The bulk of the work on area studies is completed prior to beginning specific mission planning. Sources, processes, and products are summarized in Figure 2-1 (page 2-2).

An SF battalion is seldom activated from scratch; therefore, planning does not begin with a total absence of previous guidance or planning. The process is normally modified and enhanced by prior work done by the battalion. Complete reviews of the nature described above should be done—

- As soon as a new mission letter is received.
- When supported OPLANs are significantly changed.
- When the situation in the area of responsibility (AOR) changes dramatically (as in Europe in the recent past) or as the commander prescribes (normally once every 18 months to 2 years).

Step 1 - Mission Receipt

The mission analysis process at battalion level and below begins with receipt of the mission letter from the SF group (refer to FM 31-20, Appendix F). This level is the lowest level at which a mission letter will identify the requirement to conduct SR. The battalion staffs must analyze the mission letter in conjunction with a number of other documents. Among them are specific OPLANs the battalion is tasked to support. Peacetime campaign plans (PCPs) outline major operations such as the overall counterdrug efforts for an area or region. Joint strategic capabilities plans (JSCPs) are the plans used to allocate appropriate resources and manpower. The PCPs and JSCPs developed at the JCS and unified command levels are basic outlines of the "big picture" for regional U.S. efforts. The battalion must also review other documents, such as developed war plans (OPLANs and/or concept plans [CONPLANs]) containing or implying mission requirements. In addition to extend documents specifying potential missions, the battalion commander may deduce missions based on his evaluation of the assigned AOR. The battalion commander must direct priority of effort first to externally directed missions and second to deduced missions. The battalion staff should forward deduced mission requirements to the SF group for validation and inclusion in tasking documents. SFOD A commanders must have a clear understanding of the intent of all the commanders involved whether or not the mission is externally or internally developed. If any staff member notes a conflict or lacks overall understanding of the intent, he should resolve these problems at the highest level before mission analysis proceeds.

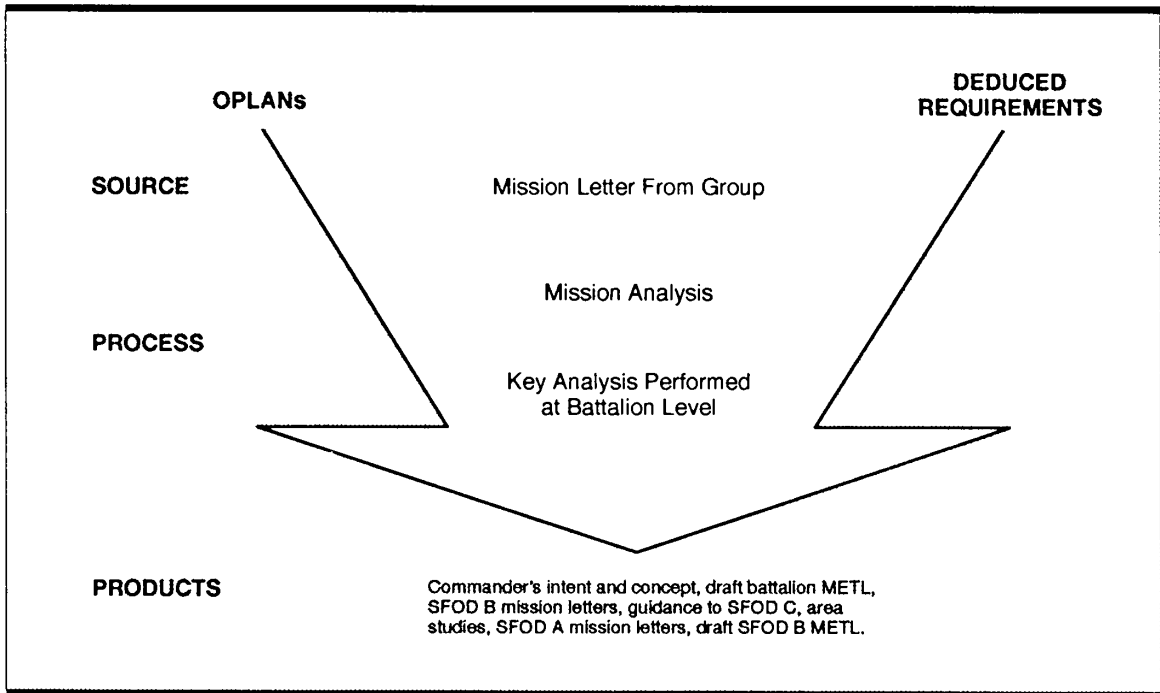

Figure 2-1. Mission analysis.

Step 2 - Information Exchange

During this step, staff representatives and commanders exchange information critical to initial mission analysis. The battalion staff is the focal point for passing information. Therefore, it must ensure that all requests and responses are quickly and fully disseminated.

Step 3 - Initial Mission Analysis

Using BOS, the commander, selected staff representatives, and certain key support element leaders review the documents received in step 1 and list the specified and implied tasks. They must consider the relationship of SR to other missions, as well as its status as a mission. For example, a UW or FID mission may imply an SR requirement in the form of a pilot team. At this point, they do not direct mission analysis against a specific target for execution by a specific SFOD A. Rather, they direct analysis at allocating resources against projected requirements to best achieve the SF group commander's intent. The final products are the basis for routine personnel and administrative activities during garrison operations. They are also used to develop specific battalion- and lower-level POEs. The result of this analysis is the battalion commander's restated mission and operational planning guidance. The restated mission must clearly identify the requirement to conduct SR, contain specific courses of action (COAs), and provide general guidelines.

Step 4 - Staff Estimate Preparation

The staff may present staff estimates orally or in writing. The volume of material may require estimates to be briefed to the commander orally with emphasis on the staff sections' conclusions and recommendations. The following paragraphs discuss, by staff section, considerations concerning the overall SR requirement.

S1 Personnel Estimate. In considering the battalion's overall SR requirement, the S1 must evaluate battalion personnel strengths in terms of its capability to accomplish the mission. The S1 presents the battalion commander with projected shortfalls in specific military occupational specialties (MOSs), individual qualifications, distribution of personnel, or projected losses, gains, and absences affecting readiness.

S2 Intelligence Estimate. The key to developing the intelligence estimate is a thorough review of the available systems and information and the identification of required intelligence support. The S2 section identifies intelligence estimate requirements as soon as possible to ensure mission success. While the S2 and other staff members are reviewing available data, such as area studies, after-action reports, and area assets, they must consider alternate means of gathering the required information. These means may include requesting overflights and satellite photography or exploiting sources in the target area. S2 personnel review all available information related to the PIR and IR reports passed by deployed SFODs to gain current information and adjust established POEs. They should also review information gathered by other group and battalion assets such as the MI detachment and its support operations teams A (SOTs A).

S3 Operations Estimate. The S3 section prepares the operations estimate, which contains a recommendation of the number of subordinate units required to meet SR requirements. The operations estimate must identify general requirements for SR-related schooling (advanced special operations training [ASOT]), operations

and intelligence [O&I], Special Operations Target Interdiction Course [SOTIC], language training) and training along with an evaluation of the SFOD's current status and/or capability. Typical considerations for SR include the—

- Number of SFODs A and SFODs B dedicated to preparing for SR as a primary mission. (FM 31-20 states that an SFOD A can be tasked to prepare for two of the five primary SF missions.)
- Feasibility of functionally aligning SFODs A within the companies with all SR-tasked teams in one company or having them decentralized.
- Requirements to deploy a forward operational base (FOB), advanced operational base(s) (AOB[s]), and/or special operations command and control element(s) (SOCCE[s]) and, if so, the number required. For detailed information on the SOCCE, see Appendix G.

S4 Logistics Estimate. The logistics section analyzes the logistics needs to support the required type and number of SR missions. This estimate may drive acquisition of certain types of items or modification table of organization and equipment (MTOE) revision. Samples of logistical considerations for SR include the quantity and type of observation devices, photographic equipment, vehicles, and specialized field gear required and available. This estimate drives budgeting for batteries (with the communications section), expendable, and air items to support SR.

Other Staff Estimates. Special staff sections (signal, medical, and legal) may be required to provide estimates. They must, as a minimum, prepare communications, medical, and legal estimates for SR-tasked teams. They must—

- Evaluate the adequacy of the type and density of communications systems available versus mission requirements.
- Identify special medical requirements to support the types and numbers of SR missions to be performed in a given AOR.
- Evaluate the legality of the general type of SR missions proposed, particularly that of battalion-generated functional SR requirements. See Appendix F for detailed information concerning SO legal considerations.

PRODUCTS

Once the staff sections prepare the estimates, they present or brief them to the commander. Based on the information contained in the estimates, the commander, with the assistance of the battalion executive officer, command sergeant major (CSM), and S3, prepares the commander's estimate. This estimate evaluates SR requirements, sets priorities, and factors in other SR missions and non-SR requirements. The commander then formulates a clear statement of intent and/or concept of operations, which establishes his priorities relative to SR. He further translates his concept of operations into a written mission letter to the companies. These products drive a number of activities on the part of the battalion staff and subordinate units. Although these actions begin during product development, they will not be finalized until after completion of premission activities and mission planning. This process is summarized in Figure 2-2.

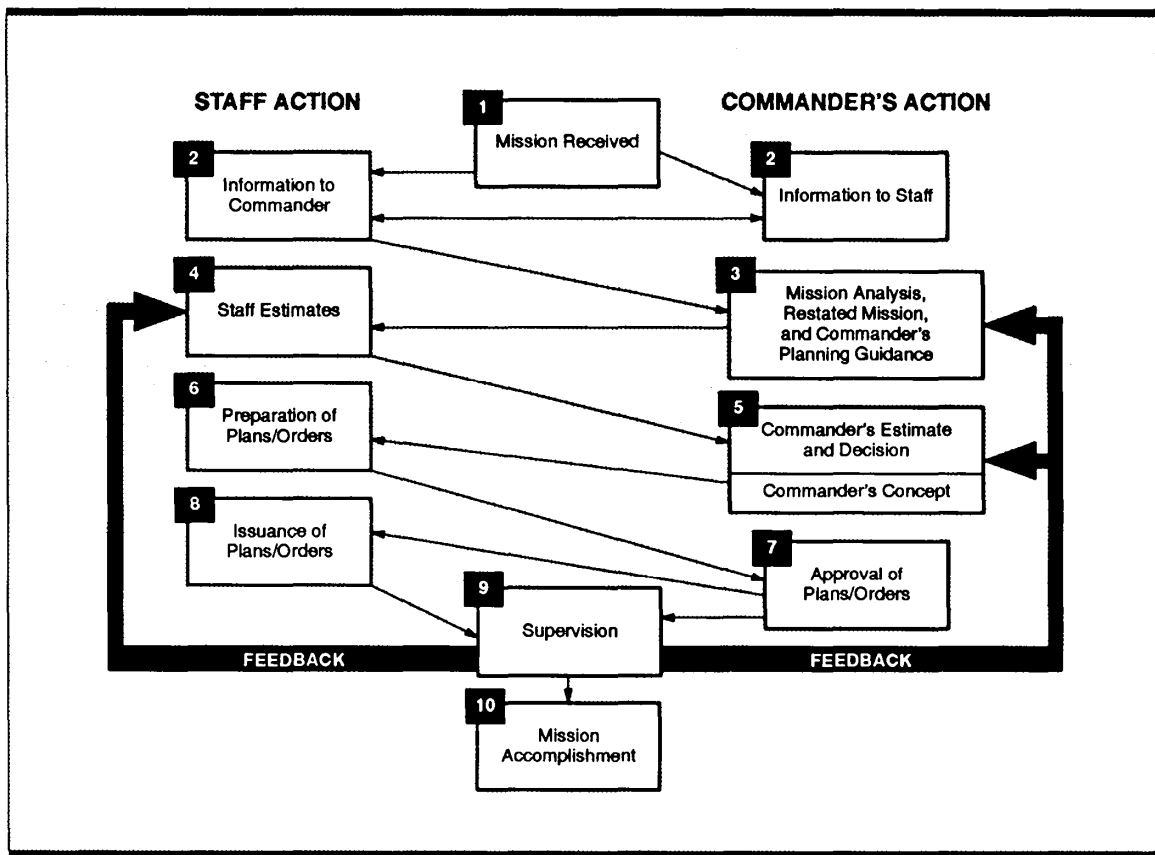

Figure 2-2. Decision-making process.

STAFF ACTIVITIES

As a result of the commander's statement of intent, mission letters, and guidance to battalion staff sections, a variety of actions begin. The goal of these actions is to aid the preparation, conduct, and support of SR operations. These actions normally parallel actions taken in support of other missions. However, there are SR-specific considerations that each staff element fulfills.

S1 (Personnel)

Based on the general guidance contained in the commander's statement of intent and guidance to the battalion, the S1 conducts a comprehensive review of personnel resources, assignments, and procedures. Working closely with the S3, battalion CSM, company commanders, and sergeants major, the S1 determines the adequacy of assigned personnel to meet the specific SR mission requirements. If shortfalls in MOSs or specific qualifications are identified, the S1 forwards personnel requests to the SF group. If authorizations under the current MTOE do not support requirements, the S1 works with the S3 in submitting

MTOE changes. Where shortfalls in training are identified such as the lack of high altitude low opening (HALO)- or SOTIC-qualified personnel, the S3 corrects the shortcomings in the MTOE or obtains schooling as required. The S1 maps the location of personnel with SR mission-essential skills, experience, and abilities. For example, certain missions may call for a native speaker, a member of a given ethnic group, 20/20 vision, or an individual with in-country experience. Although identifying requirements is not the S1's responsibility, identifying and locating the assets is. Based on requirements identified by the SFODs A and B, S3, commanders, and sergeants major, the S1 matches available personnel who have SR-related skills with existing mission profiles. Working with the SF group S1 and the battalion CSM, the battalion S1 requests appropriate personnel and advises the commander on the most appropriate assignment of incoming personnel. After mission-specific planning is completed, the battalion S1 and company staffs monitor the profiles for individual positions to assign incoming personnel accordingly. For example, the ideal candidate required by an SFOD A to perform a specific mission is required to have certain skills. These skills may include experience in rock climbing, an extensive background in foreign equipment, or expertise in an SF-specific method of infiltration/exfiltration. Personnel who meet the ideal requirements may not be available, but these profiles should serve as a baseline for assignments.

S2 (Intelligence)

During all stages of the mission, the S2 section, more than any other staff section, must be proactive. Given the commander's intent, the S2 anticipates the IR and generates the appropriate requests for intelligence information (RIIs) and requests for information (RFIs). As soon as a target or mission is identified, the S2 section begins—

- Collecting all available information on the target area.
- Deploying organic assets to collect current information.
- Sending RFIs to all available sources and agencies to gain current material and information about the target and target area.
- Reviewing on-hand information. A detailed review of the target SOMPF along with intelligence summaries (INTSUMs) reflecting information about the target and target area is required.
- Reviewing map coverage requirements for the target area.

S3 (Operations)

The S3 reviews specific skill qualifications and requests required school quotas. Working with subordinate element commanders and sergeants major, he sets priorities for allocations to SR-related schools. The S3 drafts and presents the battalion METL. This draft must consider requirements for the FOB or AOB and/or SOCCE(s). He synchronizes specific mission planning with other elements participating in the supported OPLAN. When missions are to be performed in support of or in proximity to GP elements, he requests direct liaison authority during plan development. Based on the draft METL and commander's concept of the operation, he drafts the battalion commander's training guidance and begins work on the battalion's long-range training plan. He matches ammunition and other resource forecasts to SR-specific requirements. He must also

be alert to training opportunities that are relevant to METL requirements. Examples of this long-range planning include examining mission profiles at Joint Readiness Training Center (JRTC) and programming appropriate subordinate elements against specific rotations. (For example, an SFOD A without SR as one of its two primary missions would not be scheduled to perform such a mission at JRTC. Units programmed for SR duties would receive that opportunity.)

S4 (Logistics)

The S4, like the S2, must anticipate SFOD requirements. The S4 section orders, purchases, or identifies specialized equipment. Where the current MTOE does not support the requirements, the S4 submits MTOE changes. See Appendix H for a discussion of mission-specific clothing and equipment that support SR missions.

S5 (Civil-Military Operations)

The S5 plans section must ensure all plans relevant to SR operations are made readily available. This section coordinates with supporting PSYOP elements to determine possible (positive and negative) psychological impacts of the mission on noncombatants and enemy forces. It then relays information to the tasked SFODs. The S5 coordinates with CA elements to generate data on the local populace and possible sources of supply and to estimate effects of military operations on the local populace. In an SR context, examples of this support include but are not limited to—

- Predicting the local populace's reaction to inadvertent compromise of the SFODs.
- Determining availability of equipment in the local economy.
- Identifying sources of potable water.

Additionally, the S5 plans section oversees and synchronizes the area study effort within the battalion to minimize duplication of effort.

Signal Section

The signal section analyzes the requirements for SR-unique communications capabilities and evaluates the battalion's ability to support the mission with organic assets. Considerations for SR communications are generally the same as those for other missions. Certain SR-specific aspects, however, require special consideration. Many SR missions require NRT transmission of data not common to other missions such as FID and UW. The frequent use of the split team concept during SR often requires additional communications equipment. In those instances, the signal section immediately submits MTOE changes. Differing mission environments will dictate special equipment needs. Desert environments limit the SFOD's capability to construct antennas (no trees), and standard communications gear may not be appropriate for urban operations. For other SR missions, data transmission capabilities may be essential (FAX, filmless camera). Planning for SR communications requirements is vital to mission success. If the SFOD cannot successfully transmit data in a timely manner, the mission is a failure. Redundancy and reliability of communications become imperative. Unfortunately, the nature of SR limits bulk and weight that can be transported. The signal section must actively seek the best compromise between weight and capabilities that supports the mission.

SUBORDINATE OPERATIONAL ELEMENTS

The transmission of mission letters to the SF companies begins their direct involvement in the mission analysis process. The SF battalion support company also receives a mission letter.

The SF Company

The SF company begins mission analysis upon receipt of its mission letter. Based on the mission letter, the company determines the SR-related SFOD B missions, which may—

- Include area assessment (pilot team).
- Establish an AOB in support of an SR mission(s).
- Function as a SOCCE with a supported and/or supporting headquarters.
- Augment the FOB.

It sets priorities for probable missions, both in support of SR and other missions. Then, based upon the mission letter, the company commander designates primary missions for each SFOD A. He provides each SFOD A with a mission letter clearly stating his intent and setting priorities for SFOD A missions.

The company commander and his staff analyze the capabilities of each SFOD A ensuring that SR missions go to the best qualified SFOD A.

The SF Battalion Support Company

To best support the battalion's SFODs, the SF battalion support company must have a clear picture of mission requirements. The first source of these requirements is the mission letter. Working with other primary and special staff sections, the S3 section prepares this letter, which is issued by the battalion commander. The letter contains general guidance as to the types and quantities of support the company will be required to provide. With respect to SR, the mission letter must include guidance for the SOTs A of the MI detachment. The letter must alert the signal section to unusual requirements and include other SR-specific taskings. This letter serves the SF battalion support company commander as a basis for METL development. The second means of identifying support requirements are the briefbacks conducted by the employed SFODs. Representation of all concerned staff sections at this mostly oral presentation enhances mission success more than almost any other briefing. The briefback is normally the last chance for the S3 and S4 representatives to brief the SFOD and commanders present on last minute updates to outstanding requests.

Upon completion of specific mission planning, the support company commander revises the draft METL. Working with the appropriate staff section, the support company commander issues guidance to each of his subordinate elements in a mission letter, which includes a statement of intent and concept of operations. This letter provides a start point for developing battalion METL. Specific and related tasks are drafted from this general analysis.

SECTION II. MISSION PLANNING

The joint speckd operations targeting process develops and refines SR mission taskings. The targeting process determines which mission concepts become SR and results in SOC and/or JSOTF taskings to the SF group and/or SFOB to plan and execute. Mission taskings take the form of the mission tasking package (MTP) and the TIP.

MISSION PLANNING PROCESS

The mission planning process begins with receipt of the MTP and TIP. The process will ultimately result in a completed SOMPF. Each MTP contains the SOC and group commanders' operational intent. It also contains a specification of pre-mission constraints and considerations that will hamper the assessment and planning process. The group commander and staff review the MTP and TIP to determine the general shortcomings and requirements inherent in the mission tasking. They then assign a battalion to assess the mission's feasibility and to begin planning the mission. Although the group passes the action to the battalion for more detailed analysis, group staff elements must continue their own analysis and begin to coordinate known shortfalls. Figure 2-3 depicts mission planning.

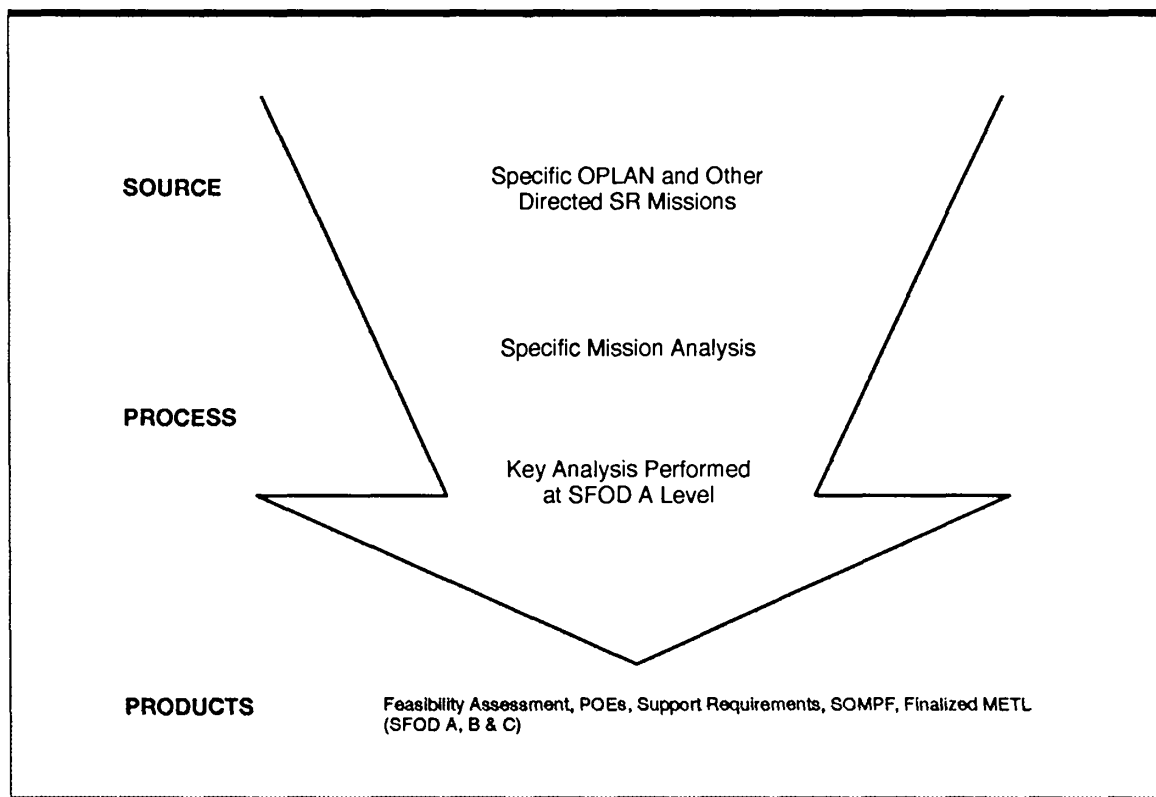

Figure 2-3. Mission planning.

FEASIBILITY ASSESSMENT

Upon receipt of the MTF, the SF battalion begins the feasibility assessment (FA) process. This assessment determines the ability of the SFOD A to perform the mission and the abilities of the battalion or SFOD B to support the mission. The BOS and SO imperatives are the best guides for conducting an FA. The FA process requires direct involvement of the battalion and/or FOB staff, the SFOD B staff, and the SFOD A. Each has specific degrees of concern and areas of responsibility that, when addressed, will accurately reflect mission feasibility. This process must address TAIs, NAIs, and other known aspects of the target area. The review of these items ensures unity of effort of all units in the area of the SR target and ensures deconfliction between friendly units. When determining mission feasibility for a preconflict mission assignment at home station, planners must forward to the isolated SFOB detailed mission shortfalls in training or resource requirements that are beyond the battalion's capability to fix, such as school quotas and mission-specific equipment. Once completed, the FA must clearly indicate whether or not mission feasibility is conditional upon the resolution of identified shortfalls. The battalion commander translates training deficiencies into additions to the SFOD METL for training. He then tasks his staff to resolve or coordinate the resolution of materiel or personnel shortfalls.

Battalion FA Activities

The battalion commander and his staff consider the specific mission requirements in the context of overall group and battalion plans. They must assess the battalion and/or FOB staff's ability to prepare, support, sustain, and command and control SR elements once they are committed to an operation. The SF battalion has two principal roles in the FA process. The first is to guide and support the SFOD's efforts. The second is to determine its own capability to support the SFODs. In the deliberate, home station planning process, where time is not a critical factor, the battalion will not determine a mission infeasible without allowing the tasked SFOD to conduct its assessment. If the SFOD's and the battalion staff's assessments conflict, the battalion commander makes the final determination. The battalion operations staff serves as the focal point for coordinating infiltration and exfiltration feasibilities. SFODs and battalion staffs must consider all methods of infiltration and exfiltration during FA. Infeasible or inappropriate methods of infiltration or exfiltration are excluded from future consideration. A mission becomes infeasible when all potential infiltration and/or exfiltration methods are infeasible. If you can't get there, the mission is infeasible! The battalion and/or FOB staff forwards to the tasked SFOD A and B known constraints, available information, and the commander's intent, which become their basis for assessment.

Company FA Activities

A battalion tasks missions directly to each of the operational detachments, 3 SFODs B and 18 SFODs A. This tasking does not imply, however, that the company headquarters does not participate in the process of tasking its organic SFODs A. Unless there are overriding security reasons for compartmentalizing the mission (in SR, these reasons would include having the SFOD B in the JSOA in an operational role simultaneously with the SFOD A on unrelated missions), the company receives the MTP from the battalion commander and staff. It then

tasks one of its SFODs A and supervises its assessment activities. The SF battalion commander has three reasons why he would pass the MTP through the company commander. First, the SF company manages the day-today activities of the SFOD A, specifically training. Second, operational experience of the SF company headquarters normally exceeds that in the SFOD A. The company staff provides capable mentorship for the SFOD A. Third, after deployment the two most common missions for an SFOD B will be as an AOB or as a SOCCE in support of the employed SFODs A. As an AOB, its personnel must know the C² and support requirements of elements performing SR within its AOR. For SR, the company's feasibility assessment concerns include—

- Communications means and schedules.
- Emergency exfiltration requirements.
- Emergency resupply considerations.
- Medivac availability.

Operational Detachments' FA Activities

The SFOD A or B performing FAs for specific missions does and develop complete plans at this time. For SR, it—

- Considers all appropriate means of infiltration and exfiltration required.
- Assesses its ability to fix the target, avoid compromise, recognize and/or detect the indicators, communicate the data acquired in a timely manner, and exfiltrate the area.

The SFOD A and/or B determines the nature of the SR task and examines applicable SR tactics. It identifies interagency coordination, required resources, training beyond its organic capability, or augmentation needs. It must include such requirements as conditions in the final FA. FAs are—

- Affirmative (we can do it as trained, equipped, and routinely supported).
- Conditional (we can do it, but the following conditions exist).
- Negative (we cannot accomplish this mission because of a clearly stated reason).

FA Conducted by Supporting Agencies

Aviation assets conduct the following FAs:

- Aircraft availability.
- Aircraft compatibility with mission guidelines.
- Routes for infiltration and exfiltration.

Technical augmenters conduct FAs to ensure compatibility with the mission. This FA should include:

- Capability to execute the selected means of infiltration.
- Transportation requirements for technical equipment.
- Mission specific skills required for the mission.

POST-FA ACTIVITIES

Once a mission is determined feasible or conditionally feasible, the FOB staff and/or SFOD anticipates actual mission tasking. The battalion and/or FOB staff immediately identifies requirements for schooling, training, and equipment. Modifying MTOEs to meet mission requirements is one example of long-term fixes that must begin upon FA. The battalion staff and the SFOD retain all documentation and working papers from the FA since they form the basis for subsequent POE development.

PLAN OF EXECUTION DEVELOPMENT

The POE is the final element of the SOMPF. It represents how the SFOD intends to carry out the assigned mission. Specific mission preparation begins when the battalion receives the tasking to prepare a SOMPF to accomplish a tasked mission (see Joint Pub 3-05.5).

SOMPF Shell

This tasking takes the form of a SOMPF “shell” containing all elements developed to that point (see Joint Pub 3-05.5 for SOMPF contents). Ideally, the SOMPF contains a completed TIP, which requires constant update until mission execution. This update process requires the supporting intelligence agencies to anticipate mission-specific requirements and to react to the developing situations particular to SR missions. The TIP, however, is critical to operational planning. Options for conducting specific mission planning include—

- Activating the FOB for training and isolating SFODs so they may accomplish their detailed planning.
- Conducting planning as part of the routine training day.

Battalion Activities

The battalion commander and staff plan for support of the overall operation. Additionally, the battalion has activities that support SFOD POE development. Building upon the analysis conducted during the FA, the battalion staff uses a standard decision-making process as described in FM 101-5. For non-time-critical planning, the staff prepares formal written estimates. These estimates identify anticipated SR mission-specific requirements of the SFODs. They also address planning options available to the tasked SFOD. For example, the signal section addresses available communications capabilities and procedures for transmitting data without undue risk of compromise. At the battalion level, the battalion commander directs the decision process toward—

- Selecting the specific SFOD(s) to conduct the missions.
- Developing estimates to be used in preparation of the battalion order and SFOD planning guidance.
- Developing the commander's intent into a feasible concept of operations.
- Planning for FOB activities required to support the employed SFODs.

The battalion planning process produces the battalion order. The battalion order encompasses all missions that the battalion's SFOD will accomplish as well as

SR. The operations annex to the order contains the specific mission-target taskings, usually a target list appendix. Compartmentation requirements normally keep the target list restricted to battalion and/or FOB and SFOB staff use. SF company commanders normally only receive target list extracts for their SFODs B and applicable SFODs A. SFODs only receive target information pertaining to their target or JSOA.

Once completed, the coordinated battalion plan or order becomes a supporting plan to the group and/or SFOB OPLAN. Revised or new missions normally require the staff to review previous analysis and coordination. Unless the changes entail extensive modifications, only the target list appendix requires revision.

The order must clearly state the commander's intent. For SR missions, the battalion commander's general statement of intent for the overall operation is insufficient. He must include a separate statement of intent for each specific mission tasking. The intent directs mission concept (MICON) development at the SFOD level. The order must contain sufficient detail to guide the SFOD commander's mission analysis and decision-making process without unduly limiting the SFOD's planning options.

The battalion commander issues a mission letter to each company and, through the company mission letter, the SFOD A receives its SR taskings. The company commander also provides the battalion OPLAN and SOMPF to the SFOD. The SFOD A needs time to review this information before it receives the mission briefing from the battalion commander and staff. The mission briefing consists of battalion staff officers and/or NCOs summarizing their specific areas and elaborating on specific data or changes in the OPLAN that have particular impact on the SFOD's SR mission. The SFOD does not leave the briefing until it understands the commander's intent and has asked all the questions generated by its review of the battalion OPLAN and SOMPF. The battalion staff answers all questions concerning, for example, infiltration platforms, support equipment availability, and rehearsal areas available to the SFOD. The SFOD includes them in the area specialist team's (AST's) mission file.

An SFOB or FOB may employ multiple SFODs on the same SR mission. For example, several SFODs may be employed against a linear target such as a rail line. These SFODs may operate in an integrated manner or separately. Multiple SFODs provide information of greater accuracy in less time than independent SFODs. One disadvantage of using multiple SFODs is mission complexity. Also, saturation of a target area increases the chances of mission compromise and makes such missions more dangerous for the deployed SFODs. Regardless, whenever multiple SFODs are employed, they must operate far enough apart to preclude interfering with each other.

Company Activities

This discussion presumes that the SFOD B is not compartmentalized from the SFOD A receiving the mission. The SF company commander and staff receive the mission briefing with the SFOD A. This practice ensures the SFOD B—

- Is available to the SFOD A during the planning process.
- Understands the training and resource requirements related to the mission,
- If tasked to act as an AOB, SOCCE, or as FOB augmentation, understands the missions it is supporting or controlling.

If the SFOD B is tasked to act as a SOCCE to support an SR mission, it acts as the liaison between the supported unit and the SF battalion and SFOD A throughout the planning process. Additionally, it must ensure resolution of operational conflicts between the GP force and the SFOD. For more information on the SOCCE, see Appendix G.

The SOCCE reviews the completed battalion OPLAN (especially those portions relating to the specific SR mission[s] that support a GP force commander). The review ensures the POE meets the supported unit's requirements and does not conflict with that unit's operations. When available, the SOCCE attends the mission briefing to answer questions concerning the operations of the supported unit. The battalion staff coordinates this liaison through the SFOB operations center.

SFOD Activities

FM 31-20 and FM 31-20-1 outline SFOD A mission planning procedures. The events described in the deliberate and adaptive planning cycles apply for home station POE development. Time is not a factor at this point. Likewise, mission-specific training does not have to take place during the planning cycle. It can be accomplished as part of the unit's normal training plan.

Step 1 - Receive the Mission. The SFOD receives the battalion staff's planning guidance. This guidance may come in a mission letter during normal peacetime operations, or it may come in the form of an OPLAN and SOMPF during hostilities. The company passes command guidance to the SFOD A. The SFOD commander reviews this planning guidance and activates the staff sections within the SFOD A. Unit SOPs designate SFOD A members for each staff section according to their MOSs and assigned staff responsibilities. Each SFOD member reviews his portion of the OPLAN. When review of the OPLAN is complete, the SFOD discusses the battalion commander's intent. Each member voices his concerns and develops questions to be answered in the mission briefing to the team. The SFOD develops and puts into writing RFIs. These RFIs address unanswered questions and unclear points in the commander's intent. These RFIs are forwarded to the battalion staff and a mission briefing is scheduled. The battalion staff presents the mission briefing, during which it answers as many RFIs as possible and provides a working status on the others. The SFOD questions each staff member as required. The SFOD commander ensures that the SFOD's perception of the commander's intent is correct through face-to-face discussion with the battalion commander. For SR, specific considerations include—

- Communications requirements (particularly in terms of timeliness and interface with non-SF systems).
- Political and legal constraints to consider in planning.
- Availability of infiltration and exfiltration means.
- Clarification of the specific intelligence requirements and why indicators were selected.
- The indicators or combinations of indicators that are critical to determining the PIR and/or IR.
- What the indicators mean in terms of PIR and/or IR (allowing the team to develop additional or alternative indicators).
- Availability of specialized equipment.
- Success criteria.

Step 2 - Exchange Information. After the mission briefing is complete and all questions have been answered or noted for further research and/or coordination, the SFOD commander conducts an abbreviated mission analysis session with the SFOD. This session is held to ensure SFOD members understand PIR, indicators, legal and political constraints, and timeliness requirements. In this session, the SFOD reviews all available information to ensure that all SFOD members agree on what has been presented. SFOD members with specialized skills and/or experience (either in the mission or in the JSOA) provide information on their unique perspectives or requirements. If confusion over factual information or interpretations of information exists, the SFOD develops and forwards additional RFIs to the battalion for clarification.

Step 3 - Restate The Mission and Produce Planning Guidance. After exchanging information, the SFOD commander, SFOD operations sergeant, and SFOD SO technician (or SGM and S3 officer if an SFOD B) meet to develop a restated mission and produce planning guidance. In this step, the SFOD leadership—

- Reviews the mission tasks from the operations order.
- Reviews the battalion mission statement and commander's intent.
- Considers the information received to date.
- Reviews the feasible infiltration and/or exfiltration means.

Based on this information, the SFOD leadership develops a comprehensive list of specified and implied tasks and the commander develops a restated mission. There is no need to rearrange the wording of the task in the operations order. The restated mission specifically identifies the SR task as the “what” of the who, what, when, where, and why. For example, it identifies the operation as target acquisition, area assessment, and so forth. In the case of “other collection tasks,” a description of the activity is substituted. Based on the SFOD leadership's knowledge of the skills, capabilities, current and achievable standards of training of the SFOD, and available resources, it develops COAs for consideration. For SR, these COAs must include—

- SR tactics (R&S, overt collection).
- Infiltration and/or exfiltration means.
- Required task organization.
- Guidance on specific techniques to be employed such as static surveillance or mobile reconnaissance.

Planning responsibilities different from, or not covered by, unit SOPs are also clearly stated. When the SFOD leadership has completed its analysis, it passes the findings out to the entire SFOD. Normally information is disseminated verbally; however, written guidance or the use of training aids (for example, flip charts) is preferable where guidance is complicated. As a minimum, the SFOD leadership must present COAs in writing.

Step 4 - Prepare Staff Estimates. Based on the planning guidance and unit SOPs, the SFOD members prepare estimates for their areas of responsibility. These estimates are not limited to those of the traditional staff areas of responsibility. For SR, specific skills and mission requirements may create a need for a “special staff” type estimate. Formats for staff estimates are in FM 101-5. PSYOP and civil-military operations (CMO) estimates will always be prepared for SF

operations. For home station planning (where time is not a factor), SFODs prepare written estimates. Written estimates provide continuity for replacements when SFOD members rotate. Staff estimates must identify requirements for support for each COA. Once completed, the staff estimates are briefed to the SFOD. The briefing serves the purpose of exchanging information between SFOD members.

Step 5 - Prepare Commander's Estimate and Decision. After the staff estimate briefings, the SFOD commander reassembles the SFOD leadership and with their assist ante prepares the commander's estimate. A critical portion of this step is determining and weighing the factors against which the COAs will be evaluated. The SFOD leadership selects the specific factors for the mission based on the commander's intent and the specified and implied tasks. For SR, these factors should account for timely transmission of data, OPSEC, and the quantity and quality of indicators the COAs should produce. The commander's estimate must include specific factors for each of the functional areas in the BOS. The SO imperatives should also be translated into specific factors related to the mission. Whatever set of factors is used, the SFOD commander must state why he selected those factors. The commander's estimate is also prepared in written form. Based on his estimate, the commander decides which COA the SFOD will plan to execute. The product of this step is a statement of the SFOD commander's intent and a concept of the operation. The SFOD commander briefs them to the entire SFOD. This briefing serves to answer any questions the SFOD may have and serves as the SFOD "murder board" for the concept. After the briefing, the commander schedules a MICON briefing for the battalion commander.

Step 6 - Present MICON Briefing. The MICON briefing is an informal briefing presented to the battalion commander to receive his approval of the SFOD's concept of the operation prior to expending time in detailed planning. MICON briefings have no format. For SR missions, the MICON briefing normally includes the—

- COAs considered.
- Factors used to evaluate the COAs.
- Commander's decision.
- Specific SR tasks derived.
- SR tactic selected.
- Task organization (to include requests for required attachments).
- Infiltration and exfiltration means.
- Identification of external support required (such as interagency approval of certain activities, specialized equipment).
- General statement of the commander's concept of operations.
- Mission essential personnel and equipment.

Visual aids should be restricted to those already being used by the SFOD for mission planning. The MICON briefing should not be so formal the "event" hinders the SFOD's planning activities. The battalion commander either approves the concept, modifies it, or directs the SFOD to return to step 3, providing additional guidance to clarify his intent. Key battalion staff members should accompany the battalion commander to the MICON briefing. If they do not, they must familiarize themselves with the approved concept.

Based on the approved concept, the battalion staff anticipates the SFOD's support requirements. For example, if the mission concept calls for HALO infiltration of a 12-man element, the S4 does not wait for a support request for HALO air items for the infiltration. The selected concept drives intelligence requirements. Because of the generally repetitious IR, intelligence personnel are able to anticipate many of these requirements. The SFOD is not relieved of the responsibility to plan all details of the operation.

Approval of the MICON ends the concept development phase for this planning session. Responsibility for the concept now rests with the battalion commander and the SFOD concentrates on detailed planning.

Step 7. Prepare Operation Plan. Upon approval of the MICON, the SFOD leadership produces the body of the OPLAN. The written OPLAN specifies taskings to subordinate elements and individual members of the SFOD. Annexes are not included at this point. They are produced during the detailed planning phase. The plan must be in keeping with the battalion commander's guidance and understock by all members of the SFOD. If this criteria is satisfied, the battalion commander approves the plan after the briefback.

Step 8. Conduct Detailed Planning. The SFOD organizes for planning the same as it would for mission execution. When the mission does not require the entire SFOD, nonessential members help subelements in the mission planning process. Compartmentalization within the SFOD is generally counterproductive. For example, multiple surveillance teams working a single TAI must synchronize their activities to avoid compromising one another. Each SFOD member or element completes a detailed plan for the execution of assigned tasks. SFODs must focus on the selected tactics and techniques (Appendix C) to be used during employment and the SIR during the development of the SR POE. The POE must address the following questions:

- How do we get to the NAI and/or TAI?
- How do we collect the data (SR techniques used)?
- How do we report the data?
- How do we exfiltrate the area?

As discussed in Chapter 1, there is no set way to conduct an SR mission. There are, however, numerous techniques that can be applied as the situation warrants. These techniques and their advantages, disadvantages, and applicability to the various SR tasks are described in Appendix C. As specific detailed plans are developed for SR missions, they must be wargamed to ensure they are complete and viable. Members of the SFOD brief their respective areas, while other members provide appropriate critique. The battalion staff should be available to provide the same service with the added advantage of greater objectivity.

In SR, certain aspects of the mission may be beyond the actual experience of any of the planners. In these circumstances, rehearsals are excellent mission planning tools. New or unfamiliar employment techniques may be tested by realistic rehearsals of portions of the plan during its development. Often, walking through an action will revent the need for modifications to the plan. In any case, before an SFOD briefs an SR POE to its battalion commander, it should physically verify the viability of the plan under the most realistic circumstances possible. This verification requires the S2 to identify the best available sites and facilities to duplicate the intended mission site. The S3 makes provisions to use those sites

and facilities. SFODs A and the S3 maintain rehearsal information for future reference. Examples of such information include time factors for surveillance site construction or movement rates with specified weights over specific terrain types. When such data has general applicability and does not compromise operational security, commanders should forward it to the USAJFKSWCS to be included in the appropriate appendix in the next iteration of this FM. Refer to FM 31-20 for a flow chart on POE development. The format for a POE is in Appendixes G and H of Joint Publication 3-05.5. Formats for specific subelements of the detailed plan that support the POE vary with the mission. Some portions of the POE may require annexes, while others only require mention in a larger section. The selected format should chronologically track the conduct of each activity (for example, surveillance site construction) from beginning to end. It should relate the activity performed in terms of how it contributes to collecting and reporting requirements or how it enhances the survivability of the SFOD. The POE lists all mission-essential equipment and accounts for the disposition of that equipment in SFOD packing and resupply plans. The SFOD leadership ensures that all supporting subplans are consistent and mutually supportive. They also must ensure that specialized equipment used for one activity can also be used for another. For example, if night vision equipment is necessary for movement and for observation, the same piece of equipment should be used for both activities, which may entail some compromise. A tripod or rifle mounted night vision devices (NVDs) may be best for observation, but night vision goggles (NVGs) may be required for movement. For SR it is usually impractical to have both. Upon completion of all supporting subplans, the SFOD leadership supervises the preparation of the formal POE. It includes all the annexes, notes, narratives, or graphics essential to conduct the mission.

Step 9 - Conduct Briefback. The briefback serves a distinct purpose. Where the POE details what an SFOD intends to accomplish, the briefback explains to the battalion commander how the SFOD will execute the assigned tasks. For SR missions, once the SFOD infiltrates, the battalion commander effectively loses his ability to supervise the performance of tasks. He cannot supervise surveillance site selection, routes, or movement techniques. His last effective influence on these activities is through guidance given at the briefback.

The briefback format is driven by the plan, not the reverse. There are several available mission briefback formats that provide general guidance. There is no "best" format or checklist for SR. The content of a briefback for an area assessment to determine FID requirements may vary widely from that of an SR mission for target acquisition in support of a GP maneuver force. The format chosen for briefing the information must be adapted to meet the mission requirements rather than to fit a prescribed format. The latter procedure leads to including irrelevant information and deleting critical factors. The SFOD prepares the briefback using the completed detailed plan. The plan is not written to a briefback format. Existing formats are useful as a means to organize the presentation (in general terms) and as a checklist to look for obvious areas that were overlooked during planning. Briefback preparation often reveals gaps in planning. In adapting the format, the following principles apply:

- The format must provide a detailed description of the activities of each SFOD member throughout the execution of the mission (it provides a mental picture of the operation for the commander receiving the briefing).
- The briefing employs visual aids only if they clarify the briefing.

- Briefers must avoid constant reference to the commander's folder as it denies the staff access to necessary information (use charts instead).
- The briefing must flow in such an order that the recipients can apply information from one section to the next.
- The briefing must provide the commander with adequate information to judge the efficacy of the plan.

SFODs present their briefback in the facility where the planning was conducted. This practice enhances OPSEC and minimizes administrative requirements for the SFOD. Although rehearsal and professional presentation are required, the goal is clarity, not display. Each SFOD member briefs his own responsibilities. The battalion commander is interested in how the surveillance element intends to conduct surveillance, not in how the security element or command element thinks the surveillance element intends to conduct surveillance. The staff focuses questions on areas where they did not hear adequate information to judge the completeness or viability of the plan. However, all staff elements should have thoroughly coordinated their input during the mission planning phase. The traditional habit of quizzing SFOD members' memory of details and cross-training is not appropriate for this briefback since mission preparation and training will continue. The sole purpose of this briefback is to judge the adequacy of the plan. For example, if the battalion communications representative hears reference to a communications system that he cannot personally vouch for as available, he quizzes the SFOD on the availability of that system. If he hears discussion on the use of an antenna that appears inappropriate, he questions that selection. This briefback is intended to disclose any weaknesses in the plan while they can be corrected. If the SFOD cannot justify any action, no matter how minute, the action needs to be reconsidered. SR, like other SO, can fail due to minor oversights. The battalion S4 must address outstanding support requests and any other shortfalls.

Once the battalion commander is confident the plan is workable, he approves the POE. If further work is required, he gives specific guidance and returns the SFOD to the planning phase. The commander determines the extent of revision and whether or not another full briefback is required. As a minimum, he should require the appropriate staff officer to personally brief him on any changes. Once the plan is approved, the SFOD commander is responsible only for the preparation of the SFOD and execution of the mission. The battalion commander assumes responsibility for the viability of the plan. The commander should withhold final approval of plans until all support requests are confirmed and the mission tasking authority approves the POE.

Step 10 - Obtain POE Approval. Once the POE is completed and approved by the battalion commander, the S3 forwards it through the SF group to the tasking agency. The tasking agency then compiles the SOMPF by obtaining the TIP, mission support package (MSP), and other supporting documents. The S2/S3 secures the basic folder and returns a copy to the mission planning agent (MPA). This procedure constitutes POE approval.

SECTION III. MISSION PREPARATION

Mission preparation must predate isolation and the deliberate planning process. During mission preparation, specific mission employment is not required. However, SFODs tasked to conduct a specific type of mission or use a specific

means of infiltration, continue to support their METL list through scheduled training. Best accomplished at the unit's home station, mission preparation includes unit training, individual, and mission-specific training.

TRAINING

Mission preparation and training provide the tools for coping with the ambiguous nature of SR. By developing specific METL based on theater-specific requirements, the techniques in the appendixes of this FM, those taught at the USAJFKSWCS, and those contained in related publications (for example, FM 31-26, FM 31-20-1), can be applied to a wide variety of SR requirements. Special equipment and organization, coupled with the METL-driven training, produce uniquely capable, area-oriented forces, prepared to conduct SR in a specific environment.

Mission-Essential Task List

Once the battalion completes its OPORDs and/or OPLANs and tasked detachments complete their detailed planning, all levels of command must revise and refine the draft METLs. The battalion S3 addresses the specified and implied tasks for each mission and at each level in the appropriate METL. METLs should be mutually supporting between levels of command.

Unit Training Plans

The battalion S3 orients unit training plans toward the METL derived from the mission analysis. Each level of command should analyze each task on the METL to determine its supporting, collective, and individual tasks. The MTP is an excellent source for developing such an analysis as are the appropriate soldiers manuals. Care must be taken not to overlook a task because it is not listed in a reference. For SR, many tasks are mission specific (such as operating a nonstandard piece of communications equipment) and are developed as tasks, conditions, and standards for training.

Evaluations

Evaluations of units (both internal and external) must measure the unit's capability to meet its mission obligations as defined in its METL. Commanders should not evaluate skills and performance for generic tasks not related to the METL until all METL tasks are completely trained.

Validation and Certification

Title 10 of the U.S. Code specifically requires that United States Commander in Chief, Special Operations Command (USCINCSOC) validate readiness and certify to supported CINCs that SOF based in the continental United States (CONUS) are prepared to complete their assigned missions. The USCINCSOC conducts this program through his components. Certification and validation programs are delineated in unit training regulations, policies, and SOPs. To be effective, these programs must focus on unit METL derived from the supported CINCs' mission requirements. Units must coordinate their METL with the command element directing and conducting such certification and validation programs. Unit METL must be validated by the supported headquarters just as POEs

are approved by the supported headquarters. For SF performing SR, this headquarters will normally be a theater SOC. The battalion commander must coordinate training requirements that detract from readiness to perform tasked SR with the supported CINC as they impact on the certification of mission readiness.

Schools

School support for required skills is a shared responsibility of the SFOD, company, and battalion. The SFOD submits requirements for schooling identified during mission planning. The S3 at battalion coordinates quotas. The company operations officer maintains requirements, allocated quotas, and unit fill for the company commander. The battalion, company, and SFOD commanders ensure that mission requirements are met or ensure that shortfalls are reported in terms of mission readiness.

Operational Environment

For all forms of SR, the SFOD must know the operational environment. For this reason, the SFOD often seeks opportunities to deploy to the actual operational area, even when the activities in the potential JSOA are not directly related to the SR mission tasks. The opportunity to survey the climatological, geographical, cultural, and other environmental factors must not be lost. Where it is impossible to deploy to the actual area and to conduct offset training, the S3 coordinates with the battalion S2 to identify accessible locations for training that replicate each SFOD's operational area. SFODs are programmed to exercise their mission plans as realistically as possible while carefully maintaining OPSEC.

INTELLIGENCE

The battalion S2 is the primary point of contact for all intelligence-related matters. Due to the nature of SR, the battalion S2 will play a key role in mission success. All mission planners must understand IR and goals.

Target Intelligence Packages

Intelligence is perishable over time. The battalion S2 has primary responsibility for maintaining the intelligence data base current. The S2 section conveys changes to the situation and to TIPs that affect mission accomplishment to the appropriate SFOD. This section must provide the SFODs current situation updates, INTSUMs, and answer intelligence-related questions and requests.

Area Studies

At the company and SFOD level, the area study is the primary tool for tracking intelligence over time. The SFOD continuously updates the area study. The battalion S2 provides the data base for updating the study using all available sources to include the Special Operations Command Research Analysis and Threat Evaluation System (SOCRATES) (see Chapter 4 for more information on SOCRATES).

Validity

The S2 must ensure the PIR and IR on which the mission is based have not been nor can be satisfied by other sources. If the S2 identifies other mission-capable

sources, he informs the battalion commander through the S3. The battalion commander then has the option to request relief from the mission tasking. For example, during initial planning of the mission, external sources were not available to obtain the required PIR and IR. This planning may have taken place years in the past. However, after the S2 reviews the assets available, a new satellite is identified that can provide required information. This new satellite coverage over the target eliminates the need to isolate and deploy an SFOD A to a target not requiring on-site human analysis. The SFOD A is saved for targets that meet the SR mission profile.

PERSONNEL

The battalion S1 and CSM assign personnel according to the specific requirements for individual skills identified during mission analysis and planning. In addition to careful monitoring of the assignment of incoming personnel, some crossleveling of skills within the battalion may be advantageous. The S1 and CSM must weigh the relative contribution of the additional SR-related skill against the advantages that unit cohesion and continuity of personnel bring to SR missions. Personnel turbulence triggers mandatory POE reviews. A good reference for review is the changing of any two of the SFOD leaders or when any four SFOD members who developed the POE rotate out of the SFOD.

LOGISTICS

All levels of command review SR-specific requirements for logistics. The S4 must redistribute the available supplies and equipment within the battalion and make inventory adjustments.

COMMUNICATIONS

SR communications requirements are usually unique. The signal section must review density and type of equipment to ensure that all requirements can be met. Battery inventory is particularly critical. The annual budget must include projections for training requirements. Where nonstandard equipment is used, the signal officer and his staff must identify reliable sources for repair parts and batteries.

PERIODIC UPDATE

The S3 must periodically review and update SR mission SOMPFs. This review and update should take place whenever—

- There is a significant change in the situation (intelligence).
- The supported plan or basic tasking changes.
- Personnel turbulence affects mission readiness.

SECTION IV. PREEMPLOYMENT PREPARATION

This section deals with execution of an SR mission after the battalion has been alerted and has activated the FOB. Normally, the FOB will operate from a forward secure area, but it may also operate from home station. The deliberate planning cycle and isolation procedures described in FM 31-20 do not change for SR.

DELIBERATE PLANNING

The deliberate planning cycle discussed in this paragraph continues the planning sequence begun with receipt of the mission letter and continued with receipt of the MTP and TIP (Sections I and II of this chapter). Deliberate planning of this nature presumes that the SFOD has completed an SOMPF for the mission and conducted its mission preparation at home station. Tasks like reviewing the current INTSUM for changes and the confirmation of infiltration and exfiltration means are critical activities. The nature of SR, however, often fails to provide the standard 5-day period from the order to execute. For SR, an alternative to shorten the time from execute order to employment is to alert an SFOD to be prepared to execute a specific SR mission in 5 days. This procedure permits the team to complete the isolation procedures in FM 31-20 and standby for an actual execute order. The actual time required from the execute order to infiltration is considerably shortened and is generally limited by infiltration requirements. There are, however, disadvantages to this approach. First, it commits the SFOD to a specific mission. Shifting to another mission (even one that has a completed SOMPF prepared by that SFOD) is a mentally and emotionally difficult shift that requires, as a minimum, that the SFOD pass through the 5-day cycle again. Second, the stress of being consistently ready to execute SR missions without a specific time or date of execution will eventually wear on the SFOD, and the SFOD will lose its edge. Failure to allow the SFOD to complete the activities of the SF planning cycle significantly increases the probability of mission failure.

EMERGING MISSIONS

Emerging missions are those missions for which a requirement was not anticipated and no SOMPF has been prepared. The planning process for such missions involves a 7-day cycle. The first two days are used by the FOB to prepare orders; the last five days are dedicated to the deliberate planning process during SFOD isolation. FM 31-20 has a complete discussion of this process. As with any such procedural guide, the time frames are approximate and are adjusted as required (for example, the MICON brief may occur late on the first day or early on the third day of isolation, rather than on the second day). The 7-day time frame obviously does not permit the type of meticulous, METL-driven mission preparation described in the previous sections of this chapter. If, however, the battalion has done a reasonably thorough job of mission analysis for its assigned AOR, the general conditions of the emerging mission will parallel other missions for which it has prepared its SFODs. The JSOA will be similar (if not the same) as will the threat and various other factors of the operational environment. The battalion and company commanders must make every effort to assign the mission to the SFOD that has most closely prepared for the mission. During time-sensitive planning, staffs must

anticipate mission requirements and staff to staff coordination. Planners must consider the transportation and information needs commonly requested for the type target being considered. Some specific areas that are particularly critical to time-sensitive planning are communications, map coverage, intent, infiltration and exfiltration, and logistics.

The battalion communications section must provide the SFOD with viable communications. Communications means must be adequately responsive to SR mission requirements.

No significant planning can begin in the absence of map coverage. The FOB S2 must supply adequate maps to the SFOD. Overhead imagery significantly enhances the probability of mission success.

The commander's intent and the precise nature of the SIR, PIR, and IR must be clearly stated and understood. There will be no time for clarification later. A clear understanding of the intent and requirement permits maximum flexibility to the deployed SFOD.

Detailed planning for infiltration and exfiltration is critical. Compromise of the SFOD on infiltration usually means the SR mission will be a failure. Since infiltration and exfiltration involve external assets, coordination is more difficult in a short period. Face-to-face coordination between the SFOD and the supporting asset (for example, pilot, boat operator and/or ship captain) is crucial.

Supplies found in the FOB support center (SPTPCEN) are, in all probability, the only logistical support available. This situation highlights the need for the battalion S4 to plan to deploy with a wide range of equipment and supplies rather than just those required for preplanned missions.

COMBAT PATROLLING

SF assets are not optimally employed in a conventional, non-SO role. Circumstances, however, may drive the JFC to employ them in this manner. He may direct reconnaissance of an emerging target without the minimum 5 days required for the deliberate planning process. In such a situation, the FOB operations center (OPCEN) functions as a tactical operations center (TOC), and the SFOD operates using standard infantry and/or ranger troop leading procedures. (See Appendix B.) Although the SFOD can be reasonably expected to perform beyond the capabilities of a GP reconnaissance element (long-range surveillance unit [LRSU] or squad patrol), the employing headquarters must not harbor unrealistic expectations. During combat patrolling, the SFOD is not performing SR. Combat patrolling is likely to overlook numerous aspects of the mission that would have been accounted for during the deliberate planning process. The advantage of SFODs conducting a light infantry reconnaissance patrol is their experience and high degree of training. These advantages will aid the probability of a mission success; however, the risk of compromise is significantly higher. A mission such as this is a misuse of a limited asset, justifiable only if the tasking is the product of a deliberate analysis of the risk versus potential gain.

OVERVIEW

The preface to this manual defines special reconnaissance and briefly describes the types of activities conducted under the umbrella of SR. This description is not intended to limit an SR mission to specific activities. This chapter explains the nature of SR and describes the environment in which it is conducted. It provides the criteria for determining the difference between SR performed by U.S. Army Special Forces and other types of reconnaissance.

THE ENVIRONMENT

Historically, U.S. security strategy, national military strategy, and military force development have stressed deterrence to war through the preparation for it. Although the United States has successfully deterred war, conflicts short of war have become pervasive. The contemporary strategic environment dictates that U.S. armed forces think in terms of an operational continuum made up of three conditions: peace, conflict, and war (Figure 1-1).

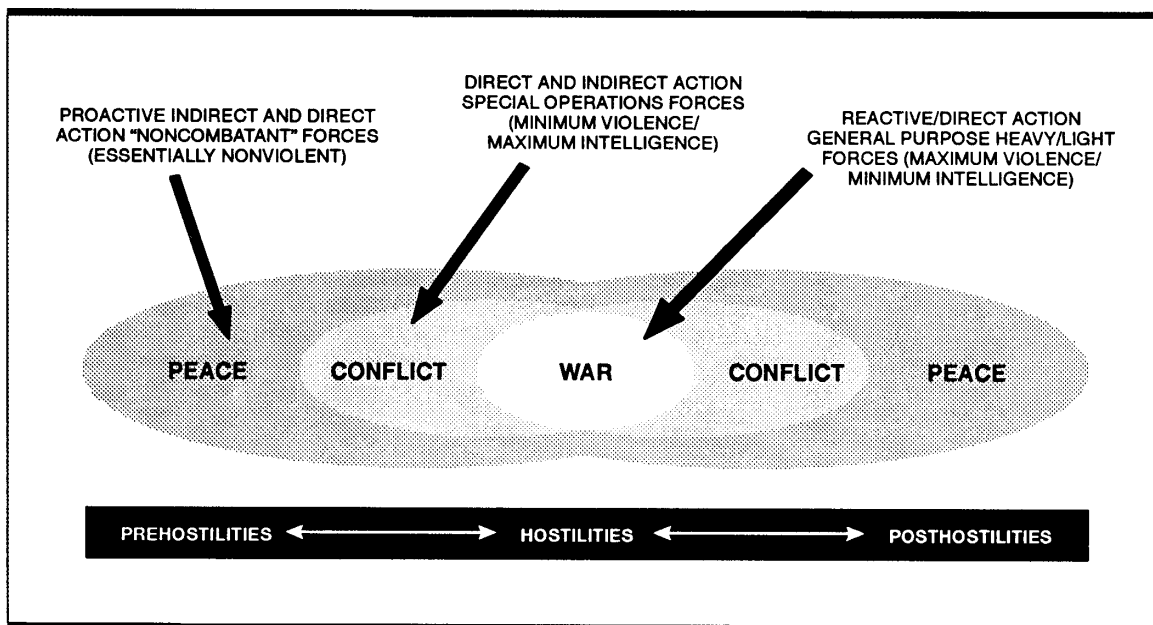

Figure 1-1. The operational continuum.

The Operational Continuum

The states of the operational continuum are dynamic but not distinct with well defined boundaries. Although the states are useful in generally defining the operational environment and predicting probable types of mission tasking, there is little or no value in trying to define a clear point at which an operation ceases to be set in peace as opposed to conflict, or conflict as opposed to war. At that degree of resolution, specific rules of engagement (ROE) are much more important. Due to the dynamic nature of the continuum, what occurs at one point of a given state can decisively shape other points in other states and determine the outcome of the overall struggle. There is, for example, a direct correlation between the largely nonviolent, indirect, and proactive operations performed during peace and the violent and direct, combined arms battles of war. The success of operations during peace and conflict may directly influence the success of operations in war, if not preclude the necessity for war altogether.

The Light/Heavy/SOF Mix

The role of the Army is to project land power through combined arms operations. SF units play an integral part in this role. Because SF units are often employed prior to hostilities, they may already be deployed in an operational area. Because of their area orientation, area expertise, and peacetime employment, SF can provide timely and accurate intelligence before the supported commander's other assets can respond. The depth at which SF can operate extends beyond normal assets available to maneuver commanders. Finally, the opportunity to deploy humans who use their judgement and technical expertise and who have an intimate knowledge of the operational area provides a dimension not present in other intelligence and reconnaissance mechanisms.

Role of Special Operations Forces

Recently, the Army has devoted increased resources to special operations forces (SOF). In part, this increase in resources is in recognition of the importance of SF in the light/heavy/SOF force mix during combined arms combat operations. The Army has also become more aware of the need to emphasize operations in conflict and peace. A part of the Army's aim in developing SOF has been to identify and defeat threats to national interests before they can escalate to war. Technological advances and the increased involvement of a sophisticated society have expanded the notion of "war." Conflicts have become very complex and now include direct and indirect political, military, economic, psychological, or social struggles. They are waged by foreign or domestic adversaries at any point along the operational continuum. SOF and SF in particular are well suited to operate in these environments. These environments, and the operations SOF conduct in them, generate unique information requirements (IR) that SF, performing SR, is uniquely qualified to fulfill.

THE NATURE OF SPECIAL RECONNAISSANCE

SR operations normally have a defined scope and preplanned duration and exfiltration. They are designed to answer specific, well defined, and often time-sensitive priority intelligence requirements (PIR), IR, and specific information requirements (SIR) of strategic, tactical, or operational significance. The unique nature of SR encompasses tasks often not clearly defined or even identified.

Units must conduct a thorough mission analysis that defines the SR tasks they are likely to perform. They must then apply an appropriate mix of the basic skills and techniques in which they have been trained to accomplish a specific mission (Figure 1-2). SR training, therefore, depends heavily on the unit METL derived from theater-specific requirements and may vary widely among units.

Special Reconnaissance Tasks

Success in peace, conflict, and war often depends on the availability of detailed, near-real-time (NRT), and all-source intelligence at all levels of execution. Because of their unique capabilities, area orientation, and location on the battlefield or in the operational area, SFODs can provide some of the most detailed information available for operational and strategic planners. This information can be used to reduce uncertainties and risks to acceptable levels. Unless hostile contact is part of the mission, SFODs performing SR normally strive to avoid detection. Chapter 3 and Appendixes A, B, and C of this FM contain detailed information on the execution of the typical SR tasks discussed below.

Target Acquisition. SR target acquisition is the detection, identification, and location of a target in sufficient detail to permit the effective engagement of the target by appropriate lethal or nonlethal means. The purpose of SR target acquisition is to obtain information on target type, location, movement, development, strength, and vulnerability. Simultaneously, the SFOD collects information on the weather, climate, and geography of the target area.

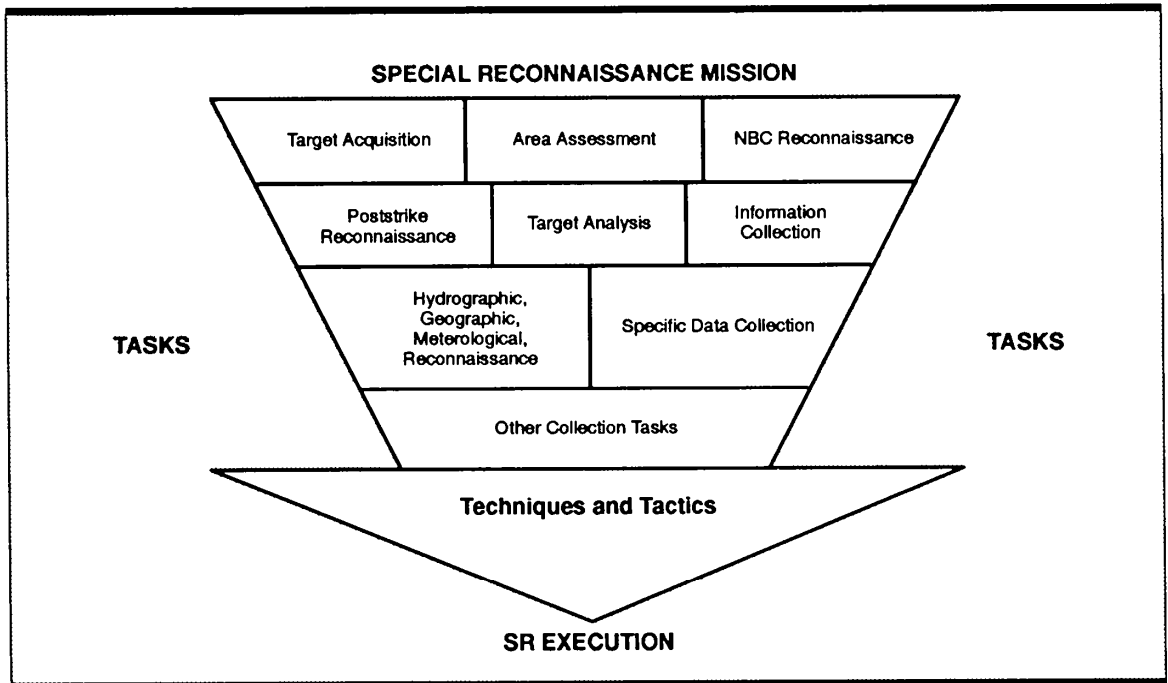

Figure 1-2. SR tasks.

Area Assessment (AA). AA is inherent to all SF missions. It is the continuous and generalized or specific collection and evaluation of information about a specific country, region, or other defined area of interest. It is used to confirm, correct, refute, or add to other intelligence and the area study. Pilot, survey, or assessment teams are generally employed to conduct AAs prior to conducting foreign internal defense (FID) or unconventional warfare (UW) missions. SFODs conduct these AAs to gather enough data to conduct effective mission planning. They are then continued by the operational element after deployment. Such AAs are particularly critical when relatively little current information is available. SFODs are normally employed in remote areas to provide otherwise unavailable real-time data and generate an extremely valuable data base for subsequent operations. In some situations, SFODs perform specialized AAs to support crisis response and emergency evacuation at theater level. Through AAs, SF provides otherwise unavailable NRT data and generates an extremely valuable data base for subsequent operations.

Hydrographic, Meteorological, and Geographic Reconnaissance. Mission planners often encounter unknown variables. These variables may be hydrographic, meteorological, and geographic in nature. SF teams can be tasked to resolve trafficability or fordability, or locate obstacles or barriers. Planners can review defensive preparations and other military and nonmilitary characteristics of a named area of interest (NAI) up to the time that general purpose (GP) forces link up with the SFOD. Appendix D contains examples of report formats commonly associated with reconnaissance.

Poststrike Reconnaissance. Poststrike reconnaissance is the distant or close visual, photographic, and/or electronic surveillance of a specific point or area of operational or strategic significance that has been subjected to attack (lethal or nonlethal). Its purpose is to measure results of such activity. SFODs are committed to poststrike reconnaissance only by exception. In this context, poststrike reconnaissance does not indicate the use of special weapons of mass destruction.

Target Analysis (TA). The combination of the conventional engineer reconnaissance and SF area assessment techniques results in what is known as TA. The criticality, accessibility, recuperability, vulnerability, effect, recognizability (CARVER) formula plays an important role in this process. TA examines technically complex targets in the context of PIR, IR, and SIR. It may be used to evaluate potential targets for follow-on SOF direct action (DA) or UW operations. It may also be used to evaluate friendly installations or facilities as a basis for defensive activities.

Nuclear, Biological, and Chemical (NBC) Reconnaissance. NBC reconnaissance by SFODs is the collection and evaluation of specific information about the presence (or absence) of radiological, biological, and/or chemical contamination (see Appendix E). The information that is collected is used to determine the extent of contamination on specific terrain, buildings, equipment, and/or airspace in selected areas of strategic or operational significance. SFODs can, with appropriate premission training, conduct NBC reconnaissance unilaterally. They may also conduct such reconnaissance with augmentation from the SF group's NBC assets, particularly from the detachment's LB team. In permissive environments, the LB team may also do NBC reconnaissance independently.

Specific Data Collection. This task is similar to target acquisition but results in data for uses other than targeting. As an example, GP forces planning a contingency

operation may require specific information on the trafficability of a given area or the disposition or intentions of threat forces in an operational area. An SFOD may infiltrate deep into a threat area prior to hostilities to obtain the required data. This task is different from AA in that specific data is collected to support a maneuver commander. Under no circumstances should an SFOD be committed under the guise of "AA" to generate data of general interest for a supported maneuver commander. Specific PIR of an operationally or strategically significant nature is required to justify committing SF assets to such a mission.

Other Collection Tasks. In addition to the foregoing, SFODs can be tasked for other collection activities. These tasks are defined as activities conducted in support of national policy objectives, planned and executed so that the role of the U.S. Government is not apparent or acknowledged publicly. Some collection tasks support such activities; however, they are not intended to influence U.S. political processes, public opinion, policies, or media. They do not include diplomatic activities or the collection and production of intelligence or related support functions.

Incidental Information Collection. In addition to conducting SR as an assigned mission, SF soldiers are expected to collect facts incidental to all other activities. Incidental information collection is an inherent responsibility as opposed to a tasking. As a result of extensive travels to areas of actual or potential interest to the U.S. Government, SF soldiers often have unique, direct or indirect access (and often the only U.S. military access) to critical military, political, and economic infrastructure and potential joint special operations areas (JSOAs). SF soldiers are obligated to note and promptly report all such unique or unusual information that comes to their attention. Incidental information collection is passive and overt in that access is with consent. An example of incidental information collection is an after-action report or trip report that notes new phone numbers or new personnel who are key to operations.

SR Tactics and Techniques

SR tactics are grouped into reconnaissance and surveillance (R&S) and overt collection (Figure 1-3, page 1-6). R&S is normally conducted in battle dress within a zone of armed conflict or war. This activity may, however, be clandestine or covert. Overt collection may be conducted in or out of battle dress in an environment such as FID. All SR activities are tied to a predetermined potential action. Examples include a missile strike, ground force raid, psychological operations (PSYOP) program, or FID or UW mission. SR is not conducted in the absence of such potential action. However, this rule of thumb does not imply that SR is only conducted after the decision to commit forces is made. On the contrary, SR may be conducted to determine the need for, or viability of, contemplated operations.

Reconnaissance and Surveillance. R&S is the survey of activity in a particular area of operations. SFODs perform this activity in one or more carefully selected NAI to provide an accurate picture of the battlefield or operational area. It is conducted to provide timely information on weather, threat, terrain, economy, and population and accurately locate dangerous, high value, relevant targets for theater weapons systems.

Overt Collection. Overt collection is the observation with consent of selected activities in a particular area of interest or operations. It may be a primary activity, or it may be incidental to other mission activities.

Criteria

One of the most commonly asked and difficult to answer questions is this: When is a mission "special" reconnaissance rather than just reconnaissance? SR missions are normally beyond the organic capabilities of Army corps commanders, intelligence resources of other services, and national intelligence assets. SFODs may be tasked to conduct SR when constraints on other systems prevent the gathering of required data in sufficient detail and accuracy. GP forces may be prevented from executing the mission because of—

- Physical distances.
- Political considerations.
- Lack of required special skills and expertise.
- Threat capabilities.
- Follow-on SF missions, for example, FID and UW.

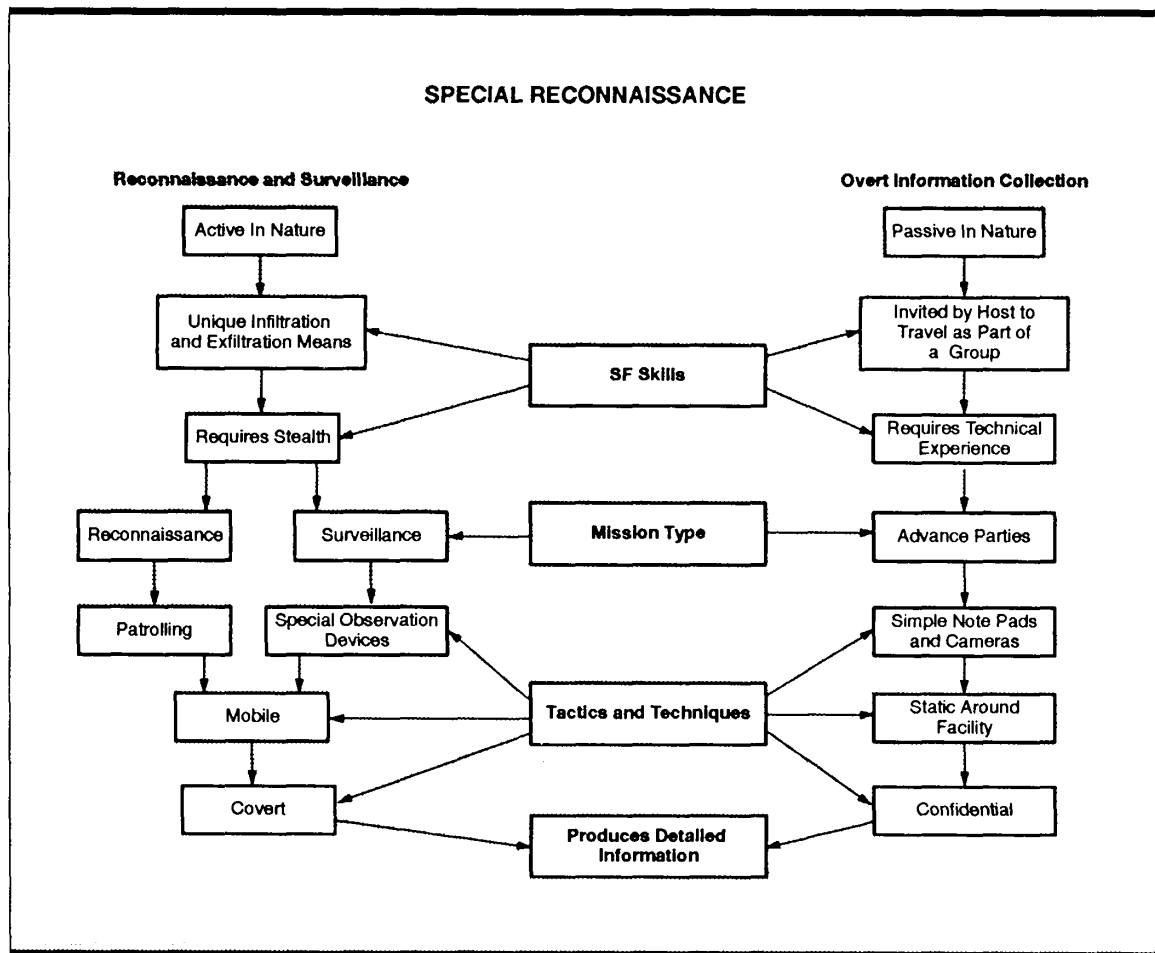

Figure 1-3. Special reconnaissance tactics and techniques.

Some types of support that are required by employed units may be beyond the capabilities of the corps commander to provide. Examples include—

- Infiltration and exfiltration means.
- Medical support and evacuation.
- Fire support.
- Resupply.
- Communications.
- Intelligence.
- Unique equipment, weapons, and resources.
- Augmentation.

Because of their training, organization, and capabilities, SF units generally do not have the constraints of GP forces. The following paragraphs describe how SFODs employ their training, organization, and capabilities in the conduct of SR.

Threat forces are using a neutral country's territory as logistical and staging bases. These bases, which form a complex, are supported by rail systems, waterways, and bulk power facilities. Mission planners have determined that the use of U.S. GP forces crossing the border into the neutral country is politically infeasible unless specific detailed information on threat activities is available. The physical distances involved are beyond the range of the corps commander's systems. National intelligence sources have confirmed that the threat force is in the area, but its exact location is not known and its activities are difficult to distinguish from routine economic activity. All efforts to "fix" threat bases have been exhausted.

This mission meets the criteria of SR and warrants targeting by SF. SFODs could cross into the target area by air, land, or sea using clandestine techniques routinely practiced at their home station. Their prior training reduces the time required for final mission preparation activities.

Limitations such as the routine medical support and communications augmentation required by GP units are overcome due to the capabilities of the independent health care practitioners and communications noncommissioned officers (NCOs) found in each SFOD A. When medical evacuation is not available or would compromise the mission, SF medical NCOs, because of their unique training and experience, can overcome these limitations. The medical NCO has extensive training in such areas as advanced trauma life support (ATLS) and minor surgery. The communications NCO has the ability to employ standard organic equipment or nontechnical means of communicating over extended distances. The special communications techniques include high-frequency (HF) burst transmission satellite communications and alternate secure means of passing messages.

SFODs also have the expertise to identify crucial subcomponents of the target complex and, with a high degree of probability, determine if these components are operational. Using the CARVER matrix, they report the information obtained to the tasking headquarters.

Area orientation and language qualification are other special skills associated with SFODs. For example, the deploying SFODs may have been previously assigned to the target area. As a result, they know what the region looks like, how

the local population may react, or what other subtle factors may exist. At a minimum, they are trained in the local customs and taboos and can talk, listen, and read in the language of the populace. The SFOD knows its logistical needs and the resources available in the target area to support its mission.

SPECIAL OPERATIONS IMPERATIVES

FM 31-20 explains the general application of the special operations (SO) imperatives to SF operations. The following paragraphs address their application to SR. SF commanders tasked to conduct SR must incorporate these imperatives into their planning and execution if they are to effectively employ their forces.

Understand the Operational Environment

In SR, SF soldiers must have a firm grasp of the political, economic, sociological, geographical, psychological, and military aspects of their operational environment. They must understand their circumstances and be ready to respond to rapid changes in a manner that assures survival and mission accomplishment. They must know—

- What they are looking for.
- The purpose for which the information is required.
- What they are working against.
- How to adjust their tactics, techniques, and procedures for optimal success.
- How to exploit perishable opportunities.

Commanders and their staffs must determine their charter. They must also determine the ROE and chain of command of the organization or agency in charge of the operations.

Recognize Political Implications

The role of SF is frequently a supporting one that creates the conditions for decisive nonmilitary or military activities to occur. When conducting independent SR operations during peace, conflict, or war, commanders must focus primarily on the political effects of their military activities. Even when their activities support conventional military operations during contingency operations or open hostilities, the political implications often remain significant. They must clearly understand the potential implications of exceeding the mission charter or of compromising a clandestine or covert activity.

Facilitate Interagency Activities

As part of the multiagency intelligence preparation of the battlefield (IPB), SR missions must accommodate the SIR, PIR, IR, and other information requests generated by other agencies. Planners must synchronize the collection efforts, ensuring they are complementary and mutually supporting. SFODs may conduct SR using intelligence collection disciplines such as human intelligence (HUMINT), signals intelligence (SIGINT), or imagery intelligence (IMINT). These actions will present commanders with an expanded picture of the operational area in question.

Engage the Threat Discriminately

SF is a limited resource that cannot be rapidly reconstituted. This fact, combined with the often sensitive political implications of SR, requires commanders to carefully assess the SR requirements against loss of this valuable asset. Planners must also consider collateral damage to civilian property or compromise of the SFOD by noncombatants.

Consider Long-Term Effects

SF commanders must take a long-term approach to the issues. They must place each individual event in broader political, military, and psychological context to avoid strategic failure while achieving tactical or short-term success. SFODs should not be used for short-term transitory gain such as road watching along secondary roads or trails. They should, however, be used for surveillance of threat first strike and special weapons systems to aid in identification of a threat's operational and/or strategic military capabilities.

Ensure Legitimacy and Credibility of SO

Without legitimacy and credibility, SR will not get the needed support of indigenous elements, the U.S. population, other government agencies, or the international community. Commanders must insist that their legal advisors (normally found at the group level) review each operation plan for violations of established laws and rules of engagement. (See Appendix F.) Moral legitimacy as well as legality must be considered. For example, would compromise of a deployed SFOD offend world opinion?

Anticipate and Control Psychological Effects

SF commanders must clearly understand the psychological nature of the SR mission. Some SR activities may be initiated specifically to produce a psychological effect. For example, an SFOD may be sent across a hostile border to deliberately leave a sign of its presence. Such an action is intended to indicate to the government of that territory that the United States has the capability and the will to conduct operations against it or to provoke it in a certain way. Plans should include both the psychological exploitation of success and contingency plans for minimizing the damage of mission failure or compromise. All planners must integrate psychological considerations into every SF mission to ensure suitable results.

Apply Capabilities Indirectly

SR planners must determine SIR indicators to minimize the need for direct observation of the target. This analysis permits SFODs to gather the required information with a minimum of risk. For example, the SR target complex requires resupply of raw materials. These materials are often transported by visible means such as trucks or railroads. Reports of the continued arrival and quantity of shipments can be used to determine the level of activities in the facility. As another alternative to physical presence, SF should emphasize the advice, training, and assistance of indigenous military and paramilitary forces as surrogates if surrogates are permissible under the ROE. The prime use of surrogates is to permit deniability and create a desirable force multiplier effect. Applying indirect capabilities lowers U.S. visibility, risk, and cost while achieving the desired intelligence objectives.

Develop Multiple Options

In a dynamic and volatile environment, SFODs must maintain maximum operational flexibility through a broad range of SR options. They must maintain the ability to shift from one option to another before and during mission execution. SFODs should not only focus on the optimal method of mission execution but should also address unanticipated success. They should also focus on putting the U.S. commander in the best possible position on the battlefield in the event of failure. Selection of alternative indicators, observation sites, and objectives are all critical aspects of mission planning.

Ensure Long-Term Sustainment

During long missions such as surveying a threat transportation system, the SFOD must be able to sustain such a protracted operation. The key to ensuring long-term sustainment is early identification of the expected duration of the mission. Because of external support limitations, planning for essential supplies to cover a specific time frame is a must.

Provide Sufficient Intelligence

SR missions not only gather information for but depend upon accurate and timely intelligence. This fact is especially true in fluid, high-risk environments. SFODs conducting SR require detailed target intelligence packages (TIPs) as part of their mission preparation. Lack of thorough TIPs may cause delays or the abortion of the SR mission. One example might be the lack of information on area security around a special weapons site. Another consideration of this imperative applies to the mission tasking itself. The political gain may not justify the risk. Information must be sufficient for subsequent operations, but the high risks associated with SR make gathering less than crucial information infeasible.

Balance Security and Synchronization

Security concerns often compartmentalize SR activities, but compartmentation can exclude key personnel from the planning cycle. SF soldiers must resolve these conflicting demands on mission planning and execution. Insufficient security can compromise a mission. Excessive security can cause the mission to fail because of inadequate coordination, result in duplication of effort, or even cause fratricide. Control measures, such as restricted fire areas, protect the force but often draw undesired attention to the operational area.

SPECIAL RECONNAISSANCE FUNDAMENTALS

SF may be used in friendly, denied, or contested areas at any point on the operational continuum to conduct reconnaissance in NAIs and/or surveillance on specified highly profitable target areas of interest (TAIs). As outlined below, SR must be purposeful, continuous, aggressive, timely, secure, reliable, and accurate. It must also be centrally targeted at the highest level and planned at the lowest level, stress flexibility, and emphasize stealth.

Purposeful

SR is purposeful when it supports specific strategic, tactical, or operational missions and activities. An example of a purposeful SR mission is the prestrike and poststrike surveillance of a major command, control, communications, and intelligence (C³I) node that must be neutralized before theater forces can undertake a planned follow-on operation. SR is not purposeful when it is not tied to a specific mission or activity or when the mission or activity is not of operational or strategic significance.

Continuous

SR is continuous when it is undertaken in all conditions of weather and terrain. Continuous SR missions are not limited by season, light, time of day, temperature, precipitation, or other environmental factors.

Aggressive

An example of an aggressive SR mission is the close human observation of insurgent leaders in an urban environment. Fixing this type of target is often impossible to do with a mechanical device.

Timely

SR is timely when the commander who employs the SFOD has the needed information in time to act on it in a way that promotes friendly interests. Such information is often called near-real-time information.

Secure

SR is passive. Security relies on stealth, secrecy, and speed. Lightly equipped SF teams conducting SR will have a high risk of casualty if compromised. These SF teams generally do not carry the bulky weapons needed to engage threat units for extended periods of time.

Reliable and Accurate

SR is reliable and accurate when it generates detailed information about, and determines precise information on, reconnaissance targets.

Centrally Targeted

SFODs performing SR should be centrally targeted at the highest echelon that can use the information they produce: for example, the theater special operations command (SOC), joint special operations task force (JSOTF), or joint force commander (JFC). Placing SFODs under the control of lower echelons risks less-than-optimal employment of a scarce resource.

Planned at the Lowest Level

Operators should be planners of all SO. Those who will be required to face the physical risks during execution of the mission should be the planners. The farther removed from the actual dangers and difficulties, the more feasible the mission appears. Additionally, given the diverse nature of SR, the actual operational element has the clearest appreciation of its capabilities and limitations.

Flexibility

Commanders should stress flexibility in employing assets. Brittle, choreographed operations are easily disrupted by the unexpected. SFODs conducting SR must be committed to plans that give them the widest latitude possible consistent with mission requirements and the commander's intent. The plan must allow the SFOD to survive unaided in the environment.

Stealth

Small-unit tactics combined with the field crafts practiced by SF units exemplify stealth. The SFOD's ability to blend into an area is often its best defensive measure. Stealth techniques are rehearsed as stated in SFOD SOPs.

BATTLEFIELD OPERATING SYSTEMS

Battlefield operating systems (BOS) were developed as a functional check for commanders during mission planning and as a tool for force requirements analysis. This analytical tool is used continually while planning an operation to ensure completeness of the plan. BOS consist of seven systems. Each system, as described below, must be considered when conducting SR operations.

Intelligence

This system concerns the gathering and evaluation of information to support mission planning and execution through the IPB process. In SR, the intelligence function extends beyond tactical analysis of the operational area. Threat order of battle (OB) and the terrain in the area of operations are always the focus of all military operations. However, planners must also consider such things as ethnic and religious groups in the local population and regional economics. SF group and battalion military intelligence (MI) assets, working with the S2 staffs in the operational bases, must continually review local threat operations. They must address such items as base operations security (OPSEC) and overhead satellite surveillance. They must also prepare an analysis of the local populace. When gathering information, they should focus on populace control measures and monitoring abilities for threat signals. Additionally, they must address hostile civilians and local police procedures and capabilities.

Maneuver

A key to a successful SR mission is the positioning and/or repositioning of the SR elements. Movement (stealth), infiltration and exfiltration, and route planning are critical. In the event of threat contact (planned or unplanned) or compromise, the employment of direct fire weapons and explosive devices against threat forces, materiel, and facilities in support of the SR mission requires detailed planning and practice. SFODs must refine their immediate action drills (IADs), battle drills (BDs), and field standing operating procedures (FSOPs) to the point that all members of the SFOD react as one with a minimum of commands.

Fire Support

Fire support is the conduct of lethal and nonlethal attacks on targets using other than direct fire means. Fire support may or may not be available for elements employed on an SR operation due to the distances involved or the geometry of

the battlefield. SFODs must request and coordinate close air support (CAS) or naval gun fire support as soon as the need is identified during mission planning. Addressed in the plan of execution (POE) and operations orders, close coordination is further required with all the services and organizations providing the fire support. This coordination must clearly identify restricted fire or no-fire zones for areas or routes that affect the SFODs. Staff sections and SFODs must also consider exploiting targets through nonlethal PSYOP. These operations and products can enhance security and cover the movements of SR elements where no other means can prove effective.

Air Defense

Any measure taken to reduce the effectiveness of attack by hostile aircraft is considered air defense. A passive defensive posture is usually the only air defense available to SR elements. The position of the SFODs must remain undetectable, even if surface-to-air weapons accompany the SR element. Like fire support, air defense must be planned, requested, and briefed to all air components providing coverage for the areas where SR elements are working. Again, planners can set up restricted fire and no-fire schedules, particularly for infiltration and exfiltration routes.

Mobility and Survivability

This system concerns those measures taken to enhance mobility of SOF units, degrade threat freedom of movement, and protect forces from threat intelligence gathering and the effect of threat weapons systems. The mobility of an employed SFOD is normally limited by the nature of the SR mission. During all movements, the SFOD must consider travel distances, infiltration and exfiltration platforms, and sites. Further, during planning and training for a mission, SFODs must consider all means of movement. Snowmobiles, four-wheel-drive vehicles, canoes, and rafts all serve as a useful means of infiltration, exfiltration, and mobility within the operational area. All SR elements must know the evasion and escape (E&E) plan before deployment. This E&E plan and the security measures taken by the SFOD are the foundation of the SFOD's survivability.

Combat Service Support (CSS)

The actions taken to sustain SOF units, primarily in the field of logistics, personnel services, and health services are classified as CSS. This system includes actions employed to link indigenous populations and agencies with U.S. and international agencies. The SFODs executing SR have little or no CSS available to them. Extended missions require careful analysis and planning to ensure mission supply needs are met. Commanders and their staffs must plan mission support sites (MSSs), patrol bases, caches, and resupply bundles to support around-the-clock operations.

Command and Control (C²)

The last system within BOS addresses actions taken by a commander to exercise authority and direction over assigned forces in accomplishing the mission. Many SR missions are generated from non-SF group IR. The C² relationships must include information flow and coordination lines between the SFODs and their supporting operational bases and supported units. (See Appendix G.) Simplicity and the ability to function must be the basis for the C² plan. All SFODs must have a

communications link that permits them to pass instructions, near-real-time intelligence, and the collected data. Further, SFODs must plan C² for any potential linkup operations using a format common to all.

RELATIONSHIP TO OTHER MISSIONS

SR is not only a mission but also a function performed as part of all other SF missions. Figure 1-4 depicts this relationship. AA, for example, may be an SR mission performed by an assessment team to prepare other SFODs for a planned FID mission.

Direct Action

DA operations are offensive and typically short. DA missions include raids, ambushes, and related actions conducted against key targets or personnel. SFODs may also be employed to acquire and survey a specific target for an incoming SFOD conducting a DA operation. If remaining in the area, the SR element can provide absolute, last-minute data to the DA element and then possibly augment it. In extreme circumstances, the SFOD can be "rolled over" to perform DA missions. Such a change of mission should not be undertaken unless the value of attacking the target clearly outweighs the value of maintaining an SR capability on the ground and the compromise and potential loss of the SFOD. Also, SFODs tasked for SR normally lack mission preparation, practice, and equipment to perform DA. If there is enough data to require a "rollover" to a DA mission, the tasked element should plan the operation as a DA mission from the beginning. The alleged SR aspects of the mission are really nothing more than a leader's reconnaissance to deal with a lack of intelligence during mission planning. They may also verify and update the last intelligence received in isolation. In cases where such a change of mission is undertaken, the SFOD may require resupply of weapons, munitions, and explosives.

Foreign Internal Defense

FID is the participation by civilian and military agencies of one government in any of the internal defense and development (IDAD) programs undertaken by another government to free or protect its society from subversion, lawlessness, and insurgency. SFODs support FID operations by conducting SR missions as survey or assessment teams to gather information for mission planning. In addition, FID presents the greatest opportunity for incidental information collection and AA. SF elements engaged in FID are also often tasked to gather information in support of civil affairs (CA) or PSYOP, to look for indications and warning of insurgent activity, or to seek intelligence in support of interagency initiatives. SR operations in FID specifically involve the assessment of the political legitimacy and effectiveness of the host nation (HN) government, the insurgents, other opposition (such as organized criminal groups), and third parties. They also involve the—

- Assessment of training, organization, morale, equipment, and capabilities and limits of the HN military.
- Measurement of the effectiveness of HN CA or PSYOP programs.
- Data for limited DA or GP force contingency operations.
- Information for force protection.

The finished product of the collated information will help commanders set goals and refine the on-going IDAD operations, training, or support requirements.

Unconventional Warfare

UW is a broad spectrum of military and paramilitary operations conducted in threat-held or politically sensitive territory. UW includes, but is not limited to, the interrelated fields of guerrilla warfare, E&E, subversion, sabotage, and other low visibility, covert, or clandestine operations. In UW, pilot teams may assess resistance potential in a likely JSOA, conduct TA on targets of interest, and conduct AAs for the supported U.S. commander or non-Department of Defense (DOD) agencies.

Counterterrorism (CT)

CT is offensive measures taken to prevent, deter, and respond to terrorism, including information gathering and threat analysis in support of those measures. In CT, SR operations can involve the—

- Identification of the terrorist political, economic, and military infrastructure
- Identification and surveillance of critical terrorist installations.
- Identification and surveillance of crisis sites.
- Identification and surveillance of lines of communication (LOC).

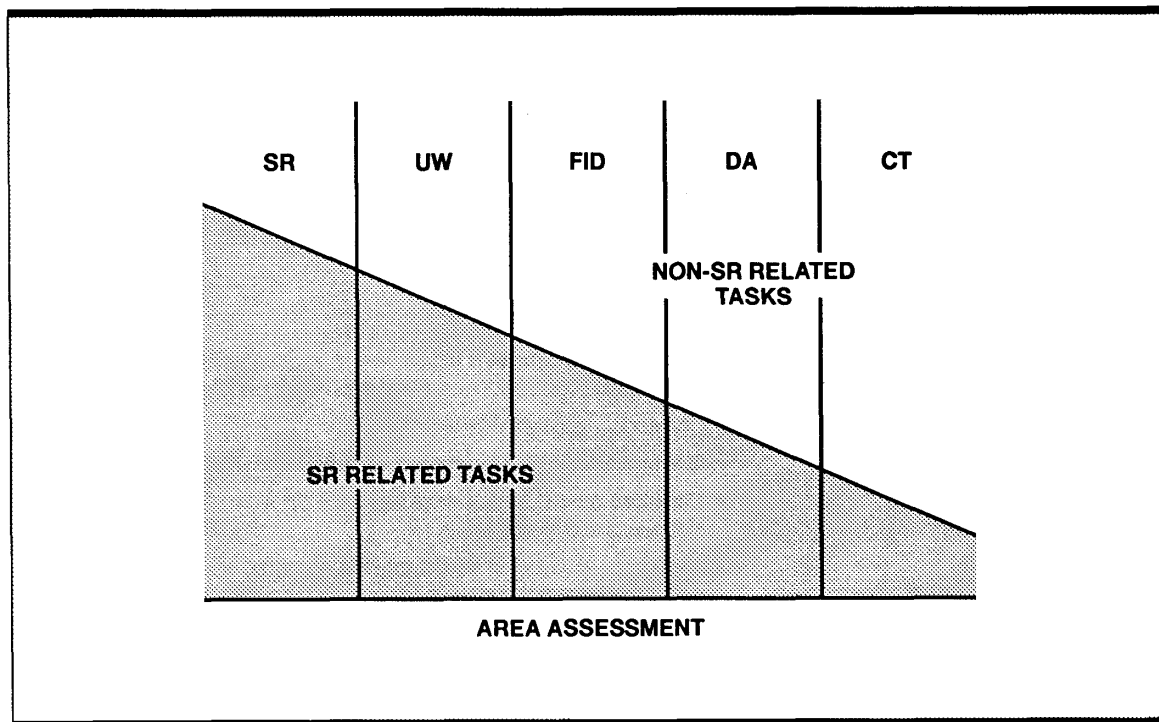

Figure 1-4. SR relationship to other missions.

Psychological Operations

An SFOD conducting SR, and particularly AA, may be tasked to collect data relative to PSYOP PIR and/or IR. Permission coordination with PSYOP assets is essential, and PSYOP personnel may be attached as technical augmenters to the SFOD if the tactical situation permits.

Civil Affairs

SF is also uniquely suited to gather information for CA units. Permission coordination with CA elements is essential.

Collateral Activities

SF SR skills are well suited to a number of collateral activities such as security assistance (SA) or counterdrug (CD) missions. The same assessments that support FID are applicable to SA. Employment of SF teams conducting SR in support of CD operations could involve the—

- Identification and surveillance of key narcotics manufacture and transport nodes.
- Assessment of political, social, and psychological impacts in rural areas of government drug eradication programs.
- Measurement of the potential political, economic, and military recuperability of criminal narcotics organizations.
- Narcotics lines of communication.

Support of GP Forces

Unity of effort must extend beyond other SF and SOF units. SFODs performing SR can also support GP forces. This support may be answering specific questions such as trafficability or identifying infiltration corridors associated with engineer reconnaissance. Passing the requested information will eliminate the need to deploy another unit into the operational area and limit the risk of compromise to both units.

EMPLOYMENT

The method of employment is determined in accordance with METT-T and applicable political considerations. SF executes SR operations in four ways:

- Unilateral-conducted by pure SF.
- Combined Arms U.S.)—conducted by a mix of SF and other U.S. forces.
- Combined (non-U.S./U.S.-mixed)—often SF led but conducted using foreign teams and/or surrogates.
- Surrogate-conducted as a combined operation with SF trained and directed foreign teams and/or surrogates.

SR AND AIR-LAND OPERATIONS

The theory of waging wars has evolved from men randomly striking each other with sticks to today's air-land operations. Swift movement of soldiers, material,

and supplies plays a major role in determining the outcome of today's wars. There are several aspects of air-land operations that affect the conduct of SR. They include—

- A nonlinear battlefield for warfighting.
- A CONUS-based, globally oriented, contingency-postured force.
- A smaller Army.
- Forward presence vice forward-deployed forces.
- An emphasis on proactive operations across the operational continuum.

A nonlinear battlefield is only viable for GP maneuver forces with complete, accurate, and NRT intelligence. To mass forces at decisive points and times on the battlefield, the commander must be able to—

- Accurately fix the threat's location, movement, and reserves.
- Visualize the terrain through engineer reconnaissance, soil samples, photographs or videos, and assessments of obstacles.
- Anticipate the threat's actions.

Technological advances have enhanced the ability to locate the threat and provide the means to rapidly receive overhead imagery. However, the need for a reconnaissance platform that couples judgement with the ability to transmit raw data has also increased. Surveillance of the nuances of threat activity overtime is often a more reliable indicator of its actual intentions than are the gross indicators detectable by technological means. Some information is not verifiable by technical means. For example, determining trafficability of sandy soil from a picture is difficult. Also, pictures normally cannot depict structural damage to a bridge. Unless the bridge can be viewed from the underside, planners cannot determine how much weight it can support. Such IR call for human judgments and calculations through reconnaissance. Reliance on technological means alone leaves the commander susceptible to deception.

During Desert Storm, the Iraqi obstacles confronting the U.S. Marine Corps (USMC) appeared complete and formidable based on analysis of technologically produced data. When the first human reconnaissance assets arrived on the scene, however, they rapidly learned that the defenses could be penetrated more easily than had been estimated.

A CONUS-based force, postured to deploy anywhere in the world on short notice, requires responsive intelligence assets on the ground during contingency planning and prior to actual deployment. The regional expertise of the Army will, in the future, rest almost totally in SOF' area oriented SF. SF area orientation, backed by the data bases developed by incidental information collection, AAs, detailed after-action reports, debriefs, and previous SF missions, makes SF assets invaluable during planning where a contingency operation is contemplated. The sensitive nature of employing reconnaissance assets before conducting a contingency operation places such activity squarely within the domain of SF and SR.

As the former Soviet Union fell, the major threat to the United States ended. The lack of a global adversary has reduced the need to maintain a large forward-deployed force. During the era of a bipolar world, dominated by the United States and Soviet Union, probable locations for war could be anticipated and

units could be forward-deployed to that area. In a world characterized by increasingly capable third world forces and regional conflicts, stationing forces at all possible points of confrontation is economically impossible, even if that were politically acceptable. As a result, smaller, less capable forces will maintain a presence in selected areas, and temporarily deployed forces will provide the forward presence in the majority of potential trouble spots. SF units deployed on FID and FID-related missions are ideal to provide this forward presence. As a result, their role assumes increasing importance as SF units prepare to move from FID to SR in support of a contingency. For FID, the SO imperative "develop multiple options" must be interpreted to require planning for such a transition.

The emphasis on peace and conflict highlights the SR mission. AAs in support of FID and UW become increasingly important as does incidental information collection. The ability of SF to perform other SR missions in a low visibility, clandestine, or covert manner is also increasingly important.

HISTORICAL PERSPECTIVE

SR operations have been boldly conducted in the past. These operations, called by many different names, have provided units with the ability to learn quickly what is happening in an area and with a high degree of correctness. One example of large-scale battlefield SR operations is the 1982 British use of its 22d Special Air Service (SAS) Regiment in the recapture of the Falkland Islands from Argentina. In early May the SAS inserted eight 4-man patrols deep into enemy-held territory up to 20 miles from their hide sites. Each man carried equipment to last him up to 25 days or more due to resupply limitations. The patrols surveyed major centers of enemy activity. The initial pattern of the patrols was to scout near the Argentinean positions during the hours of darkness and then, because of the sparse and uncomfortable cover, move before light to "lay up" in observation posts (OPs) several miles from the nearest Argentinean position. Information gathered by these teams was relayed to the fleet by radio burst transmissions. Because of the dangers of movement across open country, some teams transmitted from their OPs, while others viewed the risk of radio direction finding to be greater and transmitted from sites far removed from their OPs. Although tremendous amounts of vital combat information were reported by these patrols, the stress and physical wear on the men were enormous. Nonetheless, their activities generated an accurate operational picture of the disposition, strengths, weaknesses, and vulnerabilities of the Argentineans. The information reported was vital to the success of British planning and the ultimate reconquest of the Falklands.

In Operation Desert Shield/Desert Storm, U.S. Army SF performed SR in several forms. Several SFODs worked in concert with the Saudi forces, providing critical border surveillance and early warning during the period of the expected Iraqi offensive. Prior to the start of the ground offensive, SF elements conducted specific data collection, which was required to validate offensive campaign assumptions. At D-day, H-hour, SF elements were already performing SR information collection missions designed to provide HUMINT on Iraqi force movements along LOC deep behind Iraqi lines. This knowledge provided the commander in chief (CINC) and ground tactical commanders with vital information on Iraqi defensive intent and counteroffensive capabilities.

Though little publicized (at least accurately), SR as conducted in Southeast Asia played a key tactical, operational, and potentially strategic role in the

commander's plans. Some of these SR missions were conducted under the Code Name "PROJECT DELTA." These units collected information on an unsuspecting enemy, which often determined North Vietnamese intent and capabilities. Their actions often led to the interdiction and disruption of LOC for men and material, upsetting or canceling untold operations against South Vietnamese or U.S. GP forces.

By Order of the Secretary of the Army:

Official:

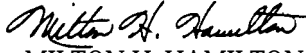
MILTON H. HAMILTON
Administrative Assistant to the
Secretary of the Army
03810

GORDON R. SULLIVAN
General, United States Army
Chief of Staff

DISTRIBUTION :

Active Army, USAR, and ARNG: To be distributed in accordance with DA Form 12-11E, requirements for FM 31-20-5, Special Reconnaissance Tactics, Techniques, and Procedures for Special Forces (Qty rqr block no. 5098).

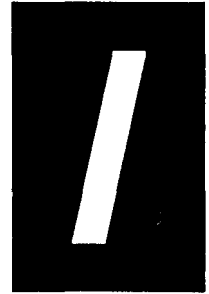

EXPLOSIVES AND MUNITIONS SAFETY

The purpose of this appendix is to provide safety considerations for explosives and munitions commonly encountered on the battlefield. This appendix will not replace the skills or training that qualified EOD or engineer personnel can provide to deploying SFODs. It will, however, provide information that will help personnel employed in remote areas where this external support is not available.

GENERAL SAFETY CONCEPTS

Certain safety concepts must apply to all ordnance. The SFOD must apply the concepts described in the following paragraphs when encountering ordnance in the field.

If required to approach a piece of ordnance, expect the most hazardous conditions. Limit exposure time to the hazard. Only one person should approach the munition.

Do not expose munitions or bulk explosives to heat, shock, static electricity, or radio waves.

If a hazard is encountered, but there are no plans to do anything about it at that time, mark the hazard to alert other friendly personnel. Report major hazards to the next higher headquarters using a 10-digit grid.

Do not dismantle ordnance items. If movement is required, move all hazardous munitions remotely.

Record and report any signs of tampering, modifications, or unusual markings on discovered ordnance.

Avoid liquids, smoke, fumes, or vapors coming out of items of ordnance. Liquid propellants are extremely caustic. Contact will result in blister-agent type chemical burn. If inhaled, extreme damage to the lungs and other internal organs, or death will occur.

All ordnance and explosives exposed to fire are extremely hazardous. Chemical changes take place within the explosive that may result in crystallized by-products. These crystals, or "salts," are extremely sensitive to friction, heat, and shock. Often, if these salts are walked on, they will explode.

Do not depress, turn, remove, or disturb any arming vanes, plungers, levers, or other control fittings on any item of ordnance. This action may arm or set off the item.

Do not remove an item of ordnance if the site will permit disposal by detonation in place.

Take booby trap precautions on all ordnance encountered. Probe and examine the area around the item for wires, lines, and secondary devices. Never uncover more than one third of a land mine at a time. Never completely uncover any item of ordnance. This action may activate a pressure-release booby trap.

Do not rely on markings or color codes on ordnance encountered in the field or captured from enemy forces. All munitions may have been modified or booby-trapped. Grenade fuzes are easy to modify. The fuzes may have a zero time delay.

SPECIFIC SAFETY PRECAUTIONS

Beyond general safety precautions, certain items require specific precautions. These specific precautions are due to type of employment or design of function. The following paragraph addresses specific safety precautions for major categories of ordnance.

High Explosive Anti-Tank (HEAT) Munitions

Common HEAT munitions include tank rounds, the M-72 LAW, the VIPER, the TOW/TOW-2, and most of the Soviet-made rocket propelled grenades (RPGs). These munitions have a cone in the front of the item. The explosive is cast or impacted around the cone that forms a shape charge. When the round explodes, most of the energy is focused forward in the form of a jet. This jet can cover great distances. All HEAT munitions require special safety precautions described below

- Avoid the area in front of a HEAT round.
- Assume the HEAT round has a piezoelectric firing system.
- Do not touch or move any munition that may have a fired or armed piezoelectric fuze.
- Place the disposal charge next to the item, never on top of or in contact with the round.
- Avoid changing the temperature of the item. Casting a shadow over the munition may cause the item to function.
- If possible, dispose of HEAT munitions in small quantities in a pit or hole or place one or two sandbags in front of the item to reduce the possibility of damage to personnel or equipment by the shape charge jet.
- Carefully fire RPG weapons during heavy rain or snowfall. These weapons have been known to function upon contact with the rain during flight.

Land Mines

Mine warfare has made distinct changes in the last few years. Technological advances have been applied to common mines encountered on today's battlefield. Simple pressure-activated fuzes are still in inventories of all armies. However, fuzes that are magnetically-influenced or seismic-fuzed mines controlled by central sensors are being manufactured and exported to all nations that can afford to purchase them. These developments have made countermine operations even

more hazardous. Even with these advances, the hazards associated with mines can be lessened by taking the safety precautions described in the following paragraphs.

If passing through a suspect area, take time to do a visual check of the area and route of march. Look for mines lying on the ground, discolored soil, unexplained wires, dead vegetation, or anything that looks out of place. Look not only on the ground but also on the sides of trees or at tree branches.

Assume all mines to be booby-trapped and armed. Check and probe the area around a mine for secondary devices or other mines. Probe only with nonmetallic items. Branches, plastic MRE spoons, or other like items are acceptable. Never probe with a knife or bayonet. If the tactical situation permits, detonate all mines in place.

Do not approach suspected or known mines while wearing or carrying metal objects. Weapons, helmets, LBE, radios, and like items should be left at a secure location no closer than 50 meters to the item.

All initial movement of mines must be done remotely. (See Figure I-1.) If possible, neutralize external fuzes before lifting a mine. Most external fuzes have more than one safety pin position. If possible, re-pin both the positive safety (hole closest to the mine) and the secondary safety position (hole farthest away from the mine). The safety pins found in a standard issue triangular bandage, paper clips, or thin nails make ideal items to neutralize fuzes. **Never force anything into a fuze.** If the first hole does not accept the safety pin freely, look for another hole.

After remotely removing a mine from the ground, wait 60 seconds in a secure area. Modern mines often use delayed fuzing. After pulling a mine out of the ground, check the hole for secondary devices. Antilift devices have a history of malfunctioning when left underground for extended periods of time. If encountered, they must be blown in place due to their extreme sensitivity.

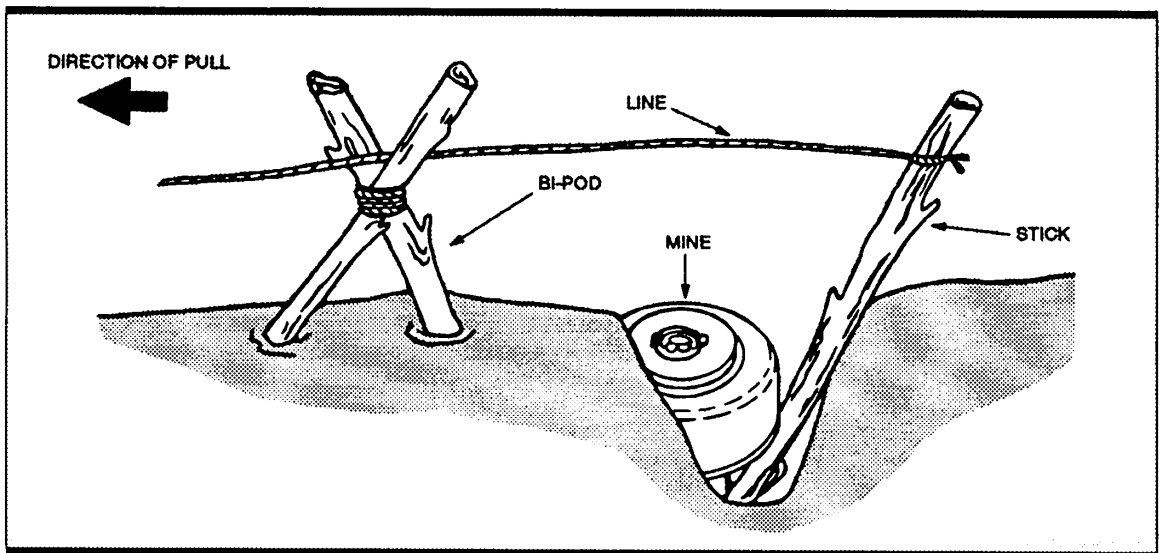

Figure I-1. Remote removal techniques.

If a trip wire is encountered, trace it to both ends and check for secondary devices or other mines before cutting or removing the wire. If thin hair-like wires are encountered, search the area for enemy soldiers. Brake wire systems or clasp circuits are being used as both a command detonation device and booby traps.

Chemical Munitions

Chemical munitions will present a very hazardous situation if encountered by SFODs in the field. Most of the armies of the world can hand place, air drop, or fire these munitions. The best course of action for SFODs encountering chemical munitions is to mark the item or area, report what was found, and by-pass the hazard. Specific safety precautions for chemical munitions are as follows:

- Bypass the suspect item by taking an upwind route.
- Maintain an exclusionary zone of 2,000 meters downwind from all known chemical munitions.
- Avoid all unknown liquids, smoke, or fumes in areas where chemical munitions have been or maybe used.
- Assume ammunition supply points (ASPs) contain chemical munitions.
- Assume all modified ordnance contain booby traps, toxic chemicals, or both.

Pyrotechnic Munitions and Incendiaries

Smoke grenades, artillery simulators, trip flares, star clusters and parachute flares, and other like items present special problems for SFODs. Described below are specific safety precautions for these items.

Do not inhale the smoke from any pyrotechnic or incendiary munition or source. Damage to the respiratory system will result. Some smoke compounds and incendiaries are toxic.

Never use water to smother a burning pyrotechnic or incendiary device. This action may result in a violent reaction or detonation of the munition. Sand or dirt may be used to fight fires or smother the munition. Wait for 30 minutes after all burning has stopped before approaching any pyrotechnic or incendiary munition.

Dispose of incendiary or pyrotechnic munitions by detonation only. Never try to bum these items as a detonation may result.

WP or plasticized white phosphorus (PWP) munitions bum on contact with air. If damaged, these items bum until a crust is formed over the crack or hole in the case of the munition. Removal of an impacted round from the ground may remove this crust and reignite the leaking phosphorus. This action may, in turn, activate the burster charge and result in damage to personnel or equipment. Remove all white phosphorus (WP), red phosphorus, or PWP rounds from the ground by remote means only. If possible, detonate the item in place. If WP comes into contact with skin, place a wet field dressing over the wound and seek medical help.

Wear a protective mask when working around or passing through smoke screens. WP, red phosphorus, white smoke, and other agents are harmful to the respiratory system.

Grenades

Broken down into two main groups, rifle or hand, grenades are normally described by their means of delivery. These grenades can be charged with numerous fillers,

such as high explosives (HEs), riot control agents, smoke, or other compounds. The following are specific safety precautions applicable to grenades:

- Do not drop or jar a misfired grenade. This action may cause the fuze to function as designed.
- Wait 30 minutes before approaching a misfired grenade. These grenades may function longer than normal due to damage, moisture, or modifications.
- Do not attempt to remove the fuze from a misfired grenade. This action may cause its detonation.
- Do not replace the safety pin into a misfired grenade. This action may result in a detonation.
- Never approach a smoking WP grenade. The grenade may function as designed as the heat builds up around the burster charge.
- Do not dispose of grenades by causing them to function as they were designed. Grenades are often booby-trapped for instantaneous firing.
- Take cover at a distance of more than 650 meters when disposing of unwanted grenades.

Rockets

Rockets may be subsurface, surface, or air launched. Rockets may have a warhead with HEs as the main filler or a variety of other fillers. Rocket motors are normally solid-fuel type. Hazards are associated with both the warhead and the propulsion system. The following are safety precautions that are applicable to rockets:

- Approach all rockets from the side. Accidental activation of the reactor may happen at any time.
- Do not strike or jar an armed rocket.
- Wait for 1 hour before approaching an impacted rocket.
- Never remove a fired rocket from, or reinsert it into, a launcher.
- Wear a protective mask when working on any rocket motor. Wash your hands with soap and water after handling rocket motor propellant.
- Avoid long-time exposure to the toxic propellant, which may be caustic to the skin, eyes, and lungs if inhaled.
- Approach all rockets from upwind. They may contain NBC agents.
- Do not operate a radio close to rockets, which may be electrically fired. If the rocket is damaged, operating a radio may cause it to fire the motor.
- Avoid all liquids around a missile. Liquid fuels and oxidizers or NBC agents may be present. Liquid rocket fuels and oxidizers are extremely caustic.
- Avoid excessive movement around areas containing spilled liquid fuels and oxidizers. Contaminated footwear can cause agents to mix, which will result in a fire or explosion.

Guided Missiles

Like rockets, guided missiles may be delivered by many different means. All of the safety precautions that apply to rockets apply to missiles. These precautions are described below.

Avoid entanglement with wires. Many missiles have a wire guidance system. Pulling on these wires may cause a misfired missile to explode.

Avoid the front of a missile. Many missiles are fuzed with a proximity fuze. This fuze may function if anything is passed in front of the nose.

Submunitions

These items may be delivered by missiles, rockets, bombs, artillery rounds, ground or airmounted dispensers, or by hand. Submunitions are delivered by a single round and cover a large area. They resemble a small bomb, or they may be in the form of a small metal or plastic disk or ball. If passing through an area where submunitions were used, determine the type of ordnance used, and expect special features such as self-destruction or antihandling devices. These self-destruct features can be incorporated in even the smallest submunition. The following are safety precautions associated with submunition:

- Do not disturb any metallic or plastic object encountered on the battlefield where submunitions may have been used.
- Do not transport submunitions. The command detonation feature may function at any time.
- Take shape charge precautions for all submunitions.
- Watch for **very** thin trip wires around submunitions.
- If submunitions are still in the dispenser, do not get in front of the submunitions or fuze of the dispenser. They may be forced out under high pressure.

Poststrike Reconnaissance Safety Precautions

When movement is required in an area where ordnance was recently used, special precautions are required for unexploded munitions. The following paragraphs describe some of the hazards and safety precaution associated with a poststrike reconnaissance.

Dud Ordnance. When munitions do not function as designed, they are considered "duds." These items have been subjected to shock, heat, spin, and the most damaging of all, impact. These forces make the ordnance much more hazardous. The safety precautions described in the following paragraphs must be observed when dealing with dud ordnance.

In all but the most extreme conditions, dud rounds must not be disturbed. Do not remove, reinsert, turn, bend, or move anything around the nose, midsection, or tail of the item. This action may release a jammed spring or stress an internal component, resulting in a detonation.

Take NBC precautions for all ordnance encountered in the field. Approach the ordnance from upwind. Avoid all unknown liquids.

If transportation of a dud round is mandatory, remove the item in the same attitude as it was found. This action will aid in reducing the movements of internal components.

Active Ordnance. If an item of ordnance has a fuze, then expect the item to have a delay feature. These delays can range from milliseconds today or longer. Some items, particularly land mines, have magnetic, seismic, acoustic, and infrared-influence detonation capabilities with a command-detonation back-up. These munitions can sit in the ground undisturbed, counting or waiting for the target to get within range.

If an area or item is suspected to contain active ordnance, avoid suspected areas or items. Other than possibly an NBC item, these munitions are the most dangerous. If operating around these items, remove metallic items from the body to reduce the magnetic signature.

NOTE: Expect detonations. Seek as much cover as possible.

These items are often susceptible to small arms fire. If trapped in an area such as a minefield where these mines are being used, an emergency path may be cleared by firing.

Most of these items have a self-destruct feature incorporated. If these items are suspected in a future area of operation, learn what was dropped, and what the self-destruct timer was set for. Then wait for the self-destruct feature to function before conducting operations in the area.

Expendable Ordnance. NBC contamination is not the only hazard associated with expended ordnance. The blast can damage structural integrity of buildings and loosen soil. Ordnance designed to function below the surface of the ground has a tendency to produce cavities known as camouflets. The formation of a camouflet is caused by the absorption of the explosive pressure into the soil as shown in Figure I-2. The round may travel so deep that the force of the explosive cannot rupture the soil covering it. This failure to rupture the surface may not seem very important; however, these camouflets contain concentrated carbon monoxide gas capped by an unstable layer of dirt. A soldier walking over a camouflet can fall through the crust and die from inhaling the toxic gases. Identification of a possible camouflet is the best safety. Look for—

- Unexplained mounds.
- Cracks in the soil.
- Discolored soil or vegetation.

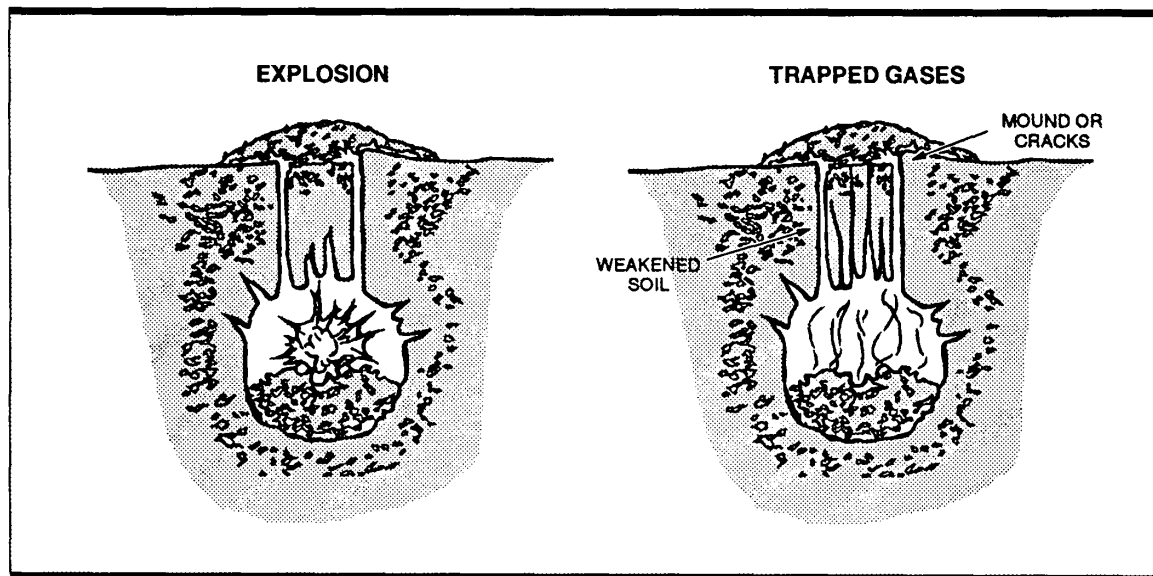

Figure I-2. Typical camouflet.

Crash Sites

Aircraft have numerous hazards. The safety precautions described below are associated with crashed aircraft. Approach the craft from a 45-degree angle from the upwind side. Approach all crash sites in the highest MOPP level available. Modern aircraft have numerous toxic items on board. Battery fluids are very caustic, and their fumes may be encountered in concentrated, toxic levels.

Never stand directly in front of or behind the aircraft. Gun systems, radars, and engines may still be functional.

Never stand in the path of a bomb rack. Ordnance stations under the wings of fast moving aircraft don't simply drop the bombs; they are expelled under pressure. At the crash site, these pressure cartridges can still throw a 250-pound bomb about the length of a football field. Because these cartridges are electrically primed, exercise electro-magnetic radiation (EMR) precautions. These precautions include ensuring no radio messages are transmitted from the site and that static-electricity-causing clothing is removed.

Be careful when moving around the pilot's and copilot's seats. Do not touch yellow, red, or boldly striped levers, handles, or control knobs. This action will result in the expulsion of a functional ejection seat or canopy.

APPENDIX



MISSION-SPECIFIC CLOTHING AND EQUIPMENT

While in isolation, the SFOD carefully prepares clothing and equipment for its mission. They should be appropriate for the season, environment, and mission requirements. The clothing and equipment requirements vary widely from operation to operation whether the mission is under battlefield conditions or not. Discussion of each type of operation is beyond the scope of this manual. However, if SFODs conduct R&S, the information contained in this appendix provides overall considerations for mission-specific clothing and equipment.

CLOTHING

NOTE: After completing a mission, the detachment sergeant checks clothing and equipment using his premission clothing and equipment checklist, accounts for equipment, and notes where restocking and replacement are needed.

Prepare clothing to be used on the mission during isolation and have the SFOD operations sergeant check it. If the mission requires deniability, he should ensure that all uniform items are sterile, with all tags, labels, and identifying marks removed. Uniforms that are sun faded with fresh patch marks on them should not be used. Uniforms should be comfortable and serviceable. A flop brim bush cover with mosquito net helps break up the outline of the head and shoulders and offers protection. Wear jacket with the sleeves down and buttoned at the cuff and gloves. Doing so provides protection from thorns, bushes, and insects and camouflages the arms. Blouse trousers unless traveling through water. Most standard-issue U.S. combat boots leave a distinctive imprint, so consider wearing nonstandard footwear that leaves prints common to the operational area. Resoled boots can also serve this purpose.

WEARING AND CARRYING MISSION-ESSENTIAL EQUIPMENT

Use standard equipment so that if it becomes necessary to retrieve a particular item, time is not lost in searching for it. If possible, carry essential mission and survival gear in the pockets of the uniform. Arrange noncritical equipment carried to permit comfort and ease of access and handling. The actual items worn or carried vary widely with mission type and duration and climate.

Layering

While operating in a temperate or tropical battlefield environment, wear and carry equipment in layers: an outer layer, a middle layer, and an inner layer. This system can be adapted to other environments as dictated by METT-T.

Outer Layer. The outer layer is the rucksack, normally packed with the least essential items. If abandoned in a hurry, survival is still possible and the mission can

continue. In some cases, mission-essential equipment is too big and/or bulky to be carried elsewhere and must be carried in rucksacks (for example, radios, laser range finders, laser target designators, and like items). Items contained in or on the rucksack may normally include but are not limited to the following:

- Ponchos and/or rain jacket.
- Small camouflage net.
- Entrenching tool.
- Collapsible weed saw.
- Section of VS-17 panel, 1/3 meter by 2/3 meter.
- Poncho liner or sleeping bag.
- Ground pad (cold weather operations).
- Canteens.
- 550 cord and/or bungee cords.
- Rations.
- Insect repellent.
- Pursuit deterrent munitions (PDM) and claymore mines.
- Extra clothing.
- Extra ammunition and grenades (under the top flap of the rucksack).
- Smoke and CSN grenades (tied on the rucksack between the pockets).

NOTE: For noise discipline, tape web gear at the buckles and other noisy spots.

Middle Layer. The middle layer comprises the utility belt and/or LBE and weapon. Items contained in this layer include—

- Weapons. Weapons should be compatible with the AO and missions.
- Ammunition. Carry a basic combat load for each weapon. If the mission requires enemy contact, the load may be heavier.
- Grenades. Carry a mix of grenades for various purposes: fragmentation, CS, WP, thermite, and smoke.
- Pursuit deterrent munitions.
- Radio. Carry a radio for emergency contact (AN/PRC-1 ½). Each MSS, R&S site, or commo site should have at least one radio compatible with the rest of the SFOD's radios.
- Weapons cleaning kit. It should be compatible with weapons used by threat forces in the AO.
- Compass.
- Knife.
- Wire cutters.
- First aid pack. It contains two field dressings, one intravenous (IV) fluid set, and nonnarcotic pain killer (at a minimum).
- Poncho (if not carried in rucksack).
- Matches (in a waterproof container).
- Survival pouch. It should be mission-tailored and secured to the LBE to prevent loss if pockets become torn.
- Canteens. The number and capacity will depend on the weather and availability of water in the AO.

- Rations (for example, long-range reconnaissance patrol [LRRP] or MRE).
- Suspension line.
- Strobe light with infrared capability.
- Colored chemical lights.
- Flashlight with extra batteries.
- Night vision goggles with spare battery.
- Camera for the designated SFOD photographer.
- Small, tripod-mounted telescope or binoculars.
- Plastic flexicuffs (for securing prisoners).
- Extra socks.
- Cough suppressant (if operating in cold or wet environments).

Inner Layer. This layer comprises the hat and pockets of the uniform. It may also include—

- Lightweight battle-dress uniform (BDU) or the type of clothing customary to the AO.
- BDU cap or jungle hat.
- Map in waterproof container. The map should be unmarked so that if captured or compromised, it will not identify the detachment's AO.
- Wristwatch.
- Full-size and/or miniature compass.
- Notebook and mechanical pencil in a waterproof container. Ink notes and sketches can smear if they get wet, pencil carbon will not.
- Pen flare launcher with six flares of predetermined colors.
- A survival pouch, tailored to the area, containing such items as fish line and hooks, pocket knife, matches in a waterproof case, and/or a magnifying glass.
- Spare eyeglasses, if worn.
- Identification tags and medical tags (for emergency treatment, if an SFOD member is found unconscious). Tape these tags together so that they do not make noise.
- One pair of extra socks.
- Water purification tablets.
- Insect repellent in a leak-proof container.
- Cravat (may be worn around the neck).
- Gloves.

Items Not To Be Taken on a Mission. The following items should not be taken on an SR mission:

- Identification card (identification tags are sufficient, less compromising, and of less utility to threat forces).
- Official documents, including passes, memoranda, and the like.
- Personal letters, diaries, or notes.
- Tobacco products. Discarded cigarette butts, tobacco smoke, or stains on a trail can compromise the SFOD.

- Metal-capped cigarette lighters that make noise when opened or closed.
- Luminous tape. It is easily spotted for long distances at night with NVGs. In some situations, luminous tape can be used, but it should be attached with Velcro so it can be removed when not needed.
- Rings or ether jewelry with insignias.
- Weapons or equipment banned by the law of war.
- Any products not indigenous to the area or for which packaging is different from that found in the AO (for example, products packaged for U.S. sale).

APPENDIX



COMMAND AND CONTROL

SOF have unique C mechanisms. The following is a brief explanation of the current SOF C structure and its application to SR missions. The end of this appendix addresses operations conducted in conjunction with coalition or GP forces. C operations and organizations are addressed in depth in Joint Publication 3-05 and FMs 100-25 and 31-20.

JOINT FORCE SPECIAL OPERATIONS COMPONENT COMMANDER (JFSOCC)

The JFSOCC within a unified command, subordinate unified command, or joint task force is responsible to the establishing commander, who is normally the theater or regional CINC. The JFSOCC makes recommendations on the proper employment of SOF and their assets and the planning, coordination, and execution of SO.

SPECIAL OPERATIONS COMMAND (SOC)

The SOC is a subunified command whose commander serves as the JFSOCC for the theater CINC. The SOC is responsible to the theater CINC for the planning and conduct of SO and the employment of assigned SOF. This responsibility does not include CA or PSYOP forces normally tasked to support GP forces.

JOINT SPECIAL OPERATIONS TASK FORCE (JSOTF)

A JSOTF is a JTF established to plan, conduct, and support joint SOF employed with a specific mission or in a specific region. The JSOTF may be under the direct operational control (OPCON) of the CINC or other component commander or serve as a JFSOCC for a joint task force (JTF) commander.

JOINT FORCE SPECIAL OPERATIONS AIR COMPONENT COMMANDER (JSOACC)

As a functional component of the JSOTF/SOC the JSOACC has OPCON of all special operations aviation (SOA) regardless of service. The JSOACC is normally formed only during large operations.

SPECIAL OPERATIONS COMMAND AND CONTROL ELEMENT (SOCCE)

The SOCCE is a C² element based on an SFOD B augmented with a special communications package and selected personnel. It may include LNOs for such supporting units as Rangers, PSYOP, CA, SOA, or other joint SOF units.

SPECIAL FORCES OPERATIONAL BASE (SFOB)

The SFOB is a command, control, and support base established and operated by an SF group. The SFOB synchronizes FOB and AOB activities.

FORWARD OPERATIONAL BASE (FOB)

The SF battalion establishes and operates the FOB as a command, control, and support base. The FOB commander is responsible for training, deploying, controlling, and supporting SF teams in specified areas.

ADVANCED OPERATIONAL BASE (AOB)

AOBs are formed and operated by augmented SFODs B. AOBs are capable of providing communications and sustainment support to deployed SFODs. When employed as a launch and recovery site, the AOB can extend the range of infiltration platforms and reduce response time it would take to get an SFOD to the target area.

THEATER ARMY SPECIAL OPERATIONS SUPPORT COMMAND (TASOSC)

The TASOSC facilitates fulfillment of service requirements. As a subordinate command of the theater Army, the TASOSC is responsible for planning and coordinating CSS and limited combat support to Army special operations forces (ARSOF). The TASOSC has no operational function or responsibility.

JOINT TARGETING COORDINATION BOARD (JTCCB)

The JTCCB performs targeting at the joint level. It validates, prioritizes, and assigns targets to various components to plan and execute in accordance with the CINC's directions.

SPECIAL OPERATIONS COORDINATION ELEMENT (SOCOORD)

The SOCOORD is the functional staff cell within the corps G3 responsible for coordinating SO requirements. As an integral part of the corps staff, the SOCOORD provides a focal point to the SOF C²I structure for synchronizing SO activities in support of corps missions.

SR C² PROCEDURES DURING SUPPORT OF GP FORCES

When an SFOD conducts SR missions that support GP units or operates within a GP unit's area, the JSOTF commander normally directs the Army special operations task force (ARSOTF) to activate and place a SOCCE with the GP units. The SOCCE performs a vital function during the conduct of an SR mission that supports or potentially operates in the path of a tactical unit. SOCCE functions are described below.

Coordination

The SOCCE provides operational liaison between the supported GP commander and the supporting FOB or SFOB. The SOCCE synchronizes and deconflicts SO at the supported headquarters.

Communications

If OPCON is passed from the SFOB or FOB to the SOCCE, then the SOCCE terminates employed SFOD's transmissions. This action provides "real time" data to the supported commander for immediate and/or initial analysis. The SOCCE also passes all terminated data through to the FOB to ensure that it reaches the Joint Information Center (JIC) for full analysis and distribution. Before OPCON is passed, the SFOB/FOB passes all message traffic from the employed SFODs to the SOCCE for possible use by the GP force commander.

Advisor

The SOCCE, when activated, serves as the "de facto" SO staff advisor to the supported commander. In this function, the SOCCE must educate the supported commander and staff on SOF capabilities and limitations. This education process also encompasses advising on the proper employment considerations for the effective use of the allocated SOF within the charter of the ongoing or planned missions.

Command and Control

When OPCON of employed SFOD passes to the supported commander, the SOCCE exercises the OPCON for that commander. This action becomes critical when the GP maneuver force advances and/or approaches the deployed SFOD. Linkup coordination is effected by the SOCCE to prevent possible fratricide between the merging forces. C² will normally pass from the SFOB and/or FOB to the SOCCE at the GP force headquarters but only for specific actions such as impending linkup.

Special Operations Command and Control Element

The SFOD B employed in a SOCCE role will not perform any other operational function. SOCCE functions will require all the assets available to the SFOD B.

Linkup Operations with GP Forces

Termination of all missions must be preplanned. This action is especially critical during the conduct of SR. As the eyes of the commander, the employed SFODs ask themselves: Why are we being asked to gather information on a target? What is the CINC's goal for the target? Will GP forces be employed during the execution of the campaign plan? If GP forces are to be tasked, a plan for linking up

must be established and practiced to reduce the risk of “friendly fire” incidents during this very dangerous time. Elaborate plans for linkup must be avoided. Standardized linkup execution as taught in most leadership schools will produce the best results. The following must be included in the linkup plan:

- Unit location.
- Size of unit (number of teams deployed).
- Unusual features of the team (weapons, clothing, equipment).
- Far-recognition signal (flares, mimers, activity).
- Near-recognition signal (activities, arm bands, hand and arm signals).
- Challenge and password.
- Running password.
- Duress signals.

Before infiltration, postmission employment is clearly addressed during mission planning. Not all SFODs will be extracted after linkup. Aircraft or other exfiltration vehicles may not be available. Also GP commanders often want to keep the SFOD as guides or to assist them with the SFOD’s area-oriented skills such as language and cultural training.

APPENDIX



SPECIAL OPERATIONS LEGAL CONSIDERATIONS

DA requires that all Army SO comply with U.S. law, national policy, DOD directives and ARs. This requirement exists regardless of whether SO are conducted during conflict or during peace.

LEGAL PRINCIPLES

Seven legal principles apply to all U.S. Army SO. They are distilled from the Hague Convention, the Geneva Conventions, the International Declaration of Human Rights, and the customary laws of war (Figure F-1).

THE ROLE OF THE LEGAL ADVISOR

DA directives require that a staff judge advocate (SJA) be consulted throughout the operational planning process to ensure SO plans comply with United States law and to provide maximum protection to SO personnel in the event of their capture or detention.

- Human rights violations and violations of the law of war are not tolerated, and all U.S. soldiers will report such violations as soon as they are made aware of such occurrences.
- Civilians are not used to shield military operations.
- Enemy PWs and civilian detainees are entitled to humane treatment.
- U.S. soldiers are entitled to similarly humane treatment should they become prisoners of war.
- Orders to commit violations of the law of war must ultimately be disobeyed.
- Superiors who order violations of the law of war to be committed are criminally responsible for such orders as are subordinates who carry out such orders.
- Employment of operational techniques designed to cause unnecessary suffering, destruction of property, or death not related to mission accomplishment is forbidden.

Figure F-1. Laws of war.

Responsibilities

SJAs assigned to ARSOF provide the legal advice an SO unit commander needs to perform his assigned mission. SO missions are politically sensitive, particularly in a peace or low intensity conflict environment, and fraught with potential legal pitfalls. During mission planning, the commander must consider.—

- Traditional law of war requirements.
- U.S. law (such as security assistance and intelligence statutes.)
- International law in the form of mutual defense treaties and host nation support (HNS) agreements.

Failure to comply with legal and policy demands could result in embarrassment. Such failure could even result in criminal investigation and prosecution.

Qualifications

The JA must have a working knowledge of the structure, mission, doctrine, and tactics of the ARSOF he advises. This knowledge should come from prior ARSOF training and experience and/or close working relationships with ARSOF commanders and staffs. In most situations, the SJA should be at least a senior captain or major. He should be SF qualified. He should be at least a Top Secret clearance and access to the information he needs to do his job effectively even if it is at the sensitive, compartment level.

Incidental Roles

The JA should serve on the unit's targeting panel to review—

- Legitimacy of the target.
- Proportionality of the methods to be used against the target.
- The legal implications of collateral damage.

He should participate in traditional staff functions. He should also observe or participate in training to gain the best possible understanding of the unit, its mission, and the personalities and capabilities of its men and their leaders. He must demonstrate to the command that he is a soldier as well as an attorney and that he can carry his own weight as a member of the ARSOF team. At the same time, however, he must guard against the danger of losing sight of the fact that he is an attorney with a special obligation and responsibility—to dispense objective and well-reasoned legal advice. He must not fall into the "can do" syndrome that ultimately ill-serves the commander.

LEGAL ISSUES MOST COMMON TO SO

The SF planner and the SJA must understand common legal issues so they can assess the effects of laws on operations. The following paragraphs describe legal issues common to U.S. Army SO.

Host Nation Law

All laws of the HN, whether at the national or local level, apply to U.S. forces in that country unless an international agreement provides otherwise. The types of law that may inhibit SO are in the areas of immigration, labor, currency

exchange, procurement of goods and services, customs and taxes, intelligence activities, and criminal and civil liability. When the local laws conflict with the operation in permissive or semipermissive environments, negotiating assistance may be available through the local embassy.

Use of Force in General

The use of force, including the commitment of ARSOF to combat is governed in international law by the United Nations Charter (Figure F-2, page F-4).

“Force” means physical violence, such as terrorist strikes or conventional invasion, not other forms of coercion. The International Court of Justice in *Nicaragua v. United States* has also ruled that a state is not permitted to resort to “self-defense” against aggression short of armed attack, but it may be able to take “proportionate countermeasures.” It is U.S. policy that once an attack occurs or is anticipated, the U.S. can use force against those responsible. Force is used to prevent or deter further attacks. The U.S. is committed to using force in its self-defense only when necessary and only to the extent it is proportionate to the threat defended against.

Abductions

An abduction is the forcible, unconsented removal of a person by agents of one state from the territory of another state. American law enforcement officials refer to such abductions as “arrests.” To be acceptable under international law, an abduction must satisfy far more exacting standards than the mere availability of an arrest warrant issued by the state responsible for the action. Those arrests done by the U.S. to date have been in international airspace and in international waters.

The forcible removal of a person, especially one being protected by a state hostile to the agency conducting the abduction, will be treated as criminal conduct, amounting at least to kidnapping. In the course of such an operation, individuals may be killed, leading to charges of murder. Where the state from which the person is taken is not hostile but refuses for reasons of policy to extradite the person seized, an abduction is likely to cause a severe strain in relations. However, the U.S. reserves the right to engage in nonconsensual abductions in three limited circumstances:

- For internal political reasons, a state may be unwilling to extradite a target or give its explicit, public consent to the target’s removal.
- Abduction may be necessary where the target is an extremely dangerous individual accused of grave violations of international law.
- The U.S. retains the option of abducting terrorists and other extremely dangerous individuals to prevent them and their state supporters from assuming that they are safe from such unilateral action.

Assassination

Presidential Executive Order 12333 states that “no person employed by or acting on behalf of the United States Government shall engage in, or conspire to engage in, assassination.” Article 23b of the Hague Conventions of 1907 essentially prohibits wartime assassination, outlawing the “treacherous wounding or killing” of the enemy.

HISTORICAL REFERENCE: A 1989 abduction of a Mexican national from Mexico by other Mexican nationals in response to an offer by the U.S. to pay a bounty upon his delivery to the U.S. has been found by the U.S. Supreme Court to be a proper acquisition of jurisdiction. Caution is in order because under U.S. law, custody of the accused cannot be obtained in such a way as to shock the sensitivities of the court.

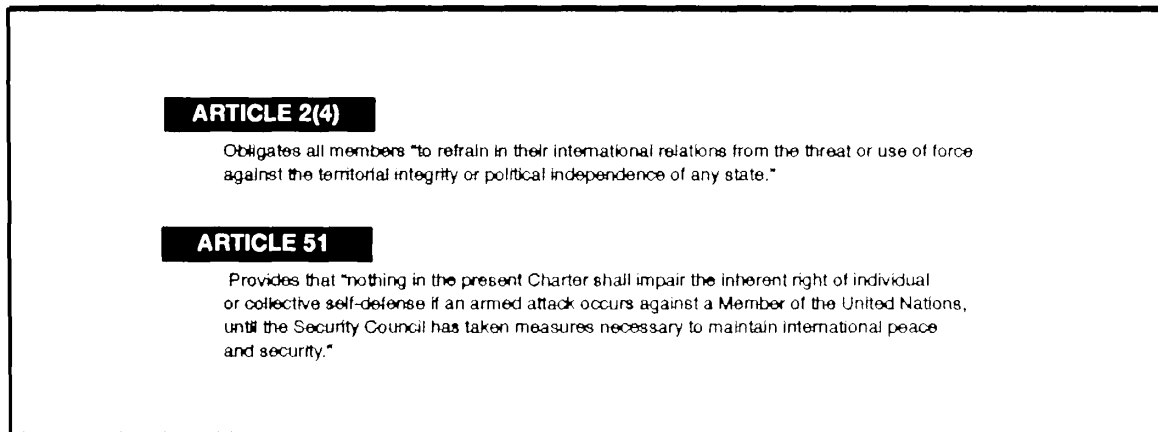

Figure F-2. Articles of the United Nations Charter.

DA guidance states that Article 23b does not prohibit an attack on individual soldiers or officers of the enemy, wherever they may be located. Essentially, combatants are subject to attack at any time or place, regardless of their activity when attacked. An individual combatant can be targeted lawfully whether he or she is directly involved in hostilities, providing logistical support, or acting as a staff planner.

A harsh but accepted consequence of such military operations is the collateral death of noncombatants pursuant to lawful attacks. Thus, a head of state has no legal immunity from being attacked when present at a proper military target. U.S. Army General Order No. 100 (Paragraph 148), published in 1863, however, defines "assassination" to prohibit making any particular person in a hostile country an "outlaw" to be killed without the benefit of ordinary limitations. Similarly, enemy combatants who fall into U.S. hands may not be summarily executed.

Attacks on Terrorists and Terrorist Camps

The U.S. recognizes and strongly supports the principle that a state subject to continuing terrorist attacks may respond with appropriate use of force to defend against further attacks. This principle is an aspect of the inherent right of self-defense recognized in the United Nations Charter. In contrast to an attack on a terrorist base in self-defense, the U.S. opposes peacetime attacks on a state's facilities on the mere possibility that they may someday be used against the attacking country.

Handling PWs

An SFOD A on an operation deep inside denied or contested territory would likely be small, consisting of 12 men or less. An SFOD A that captures a prisoner is substantially disadvantaged. One or two men have to be dedicated to guard the prisoner, which would detract from the SFOD's capability to perform its mission. Moreover, the prisoner would eventually hamper the movement of the team and increase the likelihood of the detachment's detection by the enemy. Even under such conditions, prisoners may not be executed by their captors. Such killing

would constitute a grave breach of the Geneva Convention on Prisoners of War, and U.S. doctrine clearly states that PWs cannot be killed under such circumstances. Instead, the time legally permissive choices for the SFOD are to—

- Evacuate the PW (prior to completing the mission) to a prisoner of war camp under U.S. control.
- Bind or confine the PW and gag him to suppress sound.
- Release the PW. If wounded, provide medical care as available and leave the enemy soldier where he would be found.

Hostage Rescue

The U.S. recognizes its right to use limited force for the protection of its own nationals from an imminent threat of injury or death in a situation where the state in whose territory they are located either is unwilling or unable to protect them. The right, flowing from the right of self-defense, is limited to such use of force as is necessary and appropriate to protect threatened nationals from injury.

Use of the Enemy's Uniform

Article 23f of the 1907 Hague Conventions prohibits the improper use of the enemy's uniform. The difficult issue, however, is that of determining a proper use of the enemy's uniform. Wearing of the enemy's uniform while engaged in actual combat is unlawful. Nevertheless, the enemy's uniform may be used by soldiers to facilitate movement into and through the enemy's territory. If the soldier is captured while wearing the enemy's uniform, he will very likely be denied the status of a PW. While it is U.S. policy that the enemy's uniform may be used properly for infiltration of an enemy's lines, Article 39 of Protocol I to the Geneva Conventions prohibits this use of the enemy's uniforms and most other uses of the enemy's uniform. Thus, an enemy nation, party to Protocol I, may consider the use of its uniform by U.S. forces as a war crime.

Use of Chemical Riot Control Agents

Chemical riot control agents used by ARSOF include CS ("tear") gas and CN powder. Presidential Executive Order 11850, dated 8 April 1975, prescribes U.S. policy for the use of chemical riot control agents. It states in part:

"The United States renounces, as a matter of national policy...first use of riot control agents in war except in defensive military modes to save lives such as:

"...in riot control situations in areas under direct and distinct U.S. military control, to include controlling rioting prisoners of war.

"...in situations in which civilians are used to mask or screen attacks and civilian casualties can be reduced or avoided.

"...in rescue missions in remotely isolated areas, of downed aircrews and passengers, and escaping prisoners.

"...in rear echelon areas outside the zone of immediate combat to protect convoys from civil disturbances, terrorists, and paramilitary organizations.

"... The Secretary of Defense shall take all necessary measures to ensure that the use by the Armed Forces of the United States of any riot control agents...in war is prohibited unless such use has Presidential approval, in advance"

The routine carrying and planned use of CS grenades and other riot control agents requires National Command Authorities (NCA) approval in accordance with this Executive Order.

APPENDIX



NUCLEAR, BIOLOGICAL, AND CHEMICAL RECONNAISSANCE

Because SF units have a limited organic chemical infrastructure, they rely heavily on detection and contamination avoidance during normal operations. In an NBC environment, mission planning and execution factors may differ. Mission execution will often require more time, equipment, personnel, and drinking water. Avoidance may not be applicable during NBC reconnaissance. To be successful in such an environment, deploying SFODs require extensive training. Training alone may still not fill all the mission requirements. Augmentation may be the only choice available to the commanders involved.

ORGANIC NBC ASSETS

Limited organic NBC assets are available to support SR operations. These assets are located at the group, battalion, and support company. Personnel and information can be requested from any of the units listed below.

Group Chemical Officer and NCO

Each SF group has a chemical officer and NCO assigned as part of the S3 staff. This section is the focal point for all NBC-related matters at the group level. This section is normally tasked to provide commanders from the SFOD C level through the SFODs A COAs the enemy may employ using NBC weapons.

Group Chemical Detachment

The group chemical detachment is comprised of one chemical officer, one chemical operations NCO, one computer/plotter NCO, one NBC NCO, three decontamination NCOs, and three decontamination specialists. The SF group chemical detachment operates the NBC warning and reporting system, provides decontamination support, and performs tactical NBC reconnaissance in permissive environments.

Chemical Reconnaissance Team "LB"

This SF organic team is a five-man unit comprised of a commander, one NBC operations sergeant, and three chemical operations specialists. Although the LB team is comprised of soldiers who are not SF qualified, these soldiers do receive extensive training in SF-specific and other field skills. As the primary NBC reconnaissance unit for each SF group, this team is referred to for questions dealing with NBC-related SR operations. The LB team is under the control of the group commander but may be attached to other units in the SF group. The LB team will be employed as described below.

Bilateral Employment. LB teams may augment SFODs to provide technically qualified personnel and portable equipment for collecting, examining, and identifying contaminants and toxicological agents. C² and mission planning normally remain the responsibility of the SFOD, however, the LB team must be integrated into all aspects of the plan.

Unilateral Employment. In permissive environments, the LB team provides NBC reconnaissance and takes samples of suspected agents in peace and war. They can support commanders by—

- Identifying NBC agent use.
- Conducting collection and/or sampling missions for suspected chemical or biological agents.
- Ensuring training areas and proposed base camps are contamination free.
- Identifying the type of contamination and determining extent, within equipment limitations.
- Providing NBC munitions identification.
- Providing NBC SR-specific training.

NBC Mission Training. The LB team also provides technical NBC training to the deploying SFOD. This training may include NBC countermeasures, sample collecting techniques, or chemical agents effects.

Battalion Chemical Officer and NCO

This section is the focal point for all NBC matters that affect the battalion. Unit training on matters of NBC defensive procedures and chemical defensive equipment is the responsibility of this section.

Battalion Support Company

This section is tasked to provide organic equipment maintenance and company and detachment training. Training includes NBC defense, use of organic equipment, and common task NBC skills.

NONORGANIC NBC ASSETS

The U.S. Army has three types of chemical companies and two detachments. The chemical companies are normally assigned to a division or corps. The chemical detachments are assigned to nondivisional units such as the Berlin Brigade. Other nonorganic NBC assets found at the corps level are explosive ordnance disposal detachments. Each of these units is discussed below.

Mechanized/Motorized Smoke Company

This unit provides screening smoke for battlefield positions, flanks, river crossings, and deception operations.

Decontamination Company

This unit provides equipment decontamination support to elements at the corps or division level. This unit conducts decontamination operations as close to the original contamination site as possible. These operations require huge amounts

of water. If the exact location of this unit is unknown when its support is required, look for the unit around the water sources.

Dual-Purpose Company

This unit is organic to light divisions, such as the 7th Infantry Division or the 82d Airborne Division. This unit has the ability to set up equipment decontamination sites in support of brigade and division elements or provide operational smoke support.

Decontamination Team FA

This unit contains a command section and three decontamination squads. It is capable of decontaminating vehicles or personnel.

NBC Operations Team JB

This staff unit operates the NBC warning and reporting system. It most often can be found at the SOC level.

Explosive Ordnance Disposal Detachment

All the military services have explosive ordnance disposal (EOD) detachments. These detachments are task organized to the division level. The Army EOD wartime mission is to perform render-safe procedures (RSP) on ordnance items. These munitions range from nuclear or chemical weapons to standard military ordnance of all types and origins and also include commercial dynamite or homemade bombs. This detachment has a very limited decontamination capability but may be able to provide support to returning SFODs. Commanders may request this detachment to provide premission training for SFODs expecting to encounter specific ordnance hazards. For safety reasons, SFODs who have captured ordnance or munitions pass these items to an EOD detachment.

PLANNING CONSIDERATIONS

Three basic principles apply to all NBC defensive operations. They are avoidance, protection, and decontamination. These principles are fully explained in the chemical field manuals. During SR mission planning, for SR operations where the threat of chemical use is possible, the areas shown in Figure E-1 must be addressed.

INDIVIDUAL CHEMICAL EQUIPMENT (ICE) RESUPPLY PROCEDURES

In an NBC environment, chemical defensive equipment that has been contaminated requires replacement. Most supply units provide this equipment in two different forms: bulk or prepackaged. Bulk issue often results in both overwhelming logistical and transportation problems. Prepackaged "ICE Packs" are compiled by the SFOD during isolation. In most situations, a well-planned, on-call bundle will sustain the deployed SFOD encountering NBC agents. The bundle contains one small packet of the following NBC equipment for each SFOD member:

- One complete mission-oriented protective posture (MOPP) ensemble.
- One set of filters for the protective masks used by the teams on the ground.

NOTE: One protective mask should also be included in the resupply bundle to replace battle-damaged or grossly contaminated masks. The extra mask can also be rotated among the SFOD members while they exchange the filters in their own mask. It should be a medium-sized mask that fits all SFOD members.

- One personal decontamination kit.
- One package of chemical detection and agent identification paper.
- One protective mask hood.
- One chemical agent identification kit.
- Three nerve agent antidote injectors.

NONSTANDARD DECONTAMINATION

When using nonstandard decontamination procedures, training is mandatory. The users must understand specific safety considerations for each chemical. Many common chemicals and off-the-shelf items provide the deployed SFODs with limited decontamination capabilities. Pool chlorine (known as HTH), household bleach, and sodium hypochlorite are just a few of the available compounds that can effectively counter differing NBC agents. Washing with hot soapy water is the preferred technique for decontamination for many items. SFODs seek training and guidance for the mixtures, safety, and effectiveness through the group chemical officer and NCO. If they are unavailable, most of the units listed in this appendix can provide detailed information.

THREAT

- Type and effect of agents used in past operations
- Method of delivery
- Location of NBC capable units and facilities
- Location of suspected contaminated areas

EFFECTIVE COUNTERMEASURES

- Organic and nonorganic decontamination site locations
- Medical support facility locations
- Chemical equipment replacement procedures
- Deliberate personal and equipment decontamination procedures
- Hasty decontamination procedures
- Field expedient decontamination procedures

SUPPORT PROCEDURES

- Technical augmentation
- Technical training
- Exfiltration and chain of custody procedures for agent samples
- QRF procedures in an NBC environment
- Exfiltration of contaminated personnel
- Equipment support

Figure E-1. Planning considerations for NBC defensive operations.

PROTECTIVE MEASURES

When operating in a possible NBC environment, SFODs can take protective actions to counter much of the NBC threat. These actions are described below.

Protective Clothing

When MOPP gear is either not available or prevents the team from carrying out the mission as planned, other steps can be taken to protect team members. This is not a proposal to eliminate the MOPP ensemble. The current MOPP gear is the best equipment to use for most operations. However, Gore-Tex and the standard U.S. Army rain suit can afford limited protection in emergency situations.

M8 and M9 Chemical Detection Paper

Each SFOD member on the mission pins M8 and M9 paper to his lower pants leg. SFOD members can also attach detection paper to the sleeves of the battle dress jacket. This paper turns different colors when contamination is encountered. SFOD members must make frequent checks of the paper during the operation. The first member to notice any change in the paper must sound the alarm of "Mask." Members can confirm or reject the NBC presence by using an NBC detector kit.

Suspect Liquids

Puddles, oily liquids, and discolored plants, or water can indicate the presence of NBC agents. The SFOD avoids standing water and must not use it for water re-supply. When moving through an area that is wet from dew or rain, wet weather gear, such as Gore-Tex, is worn with the M8 and M9 paper exposed.

NBC Indicators

Dead animals, discolored plants, or the general lack of wildlife in areas can indicate NBC agent presence. The lack of normal sounds in an area, such as birds and frogs, should alert the SFOD to a problem. Also, due to the caustic nature of most NBC agents, plant leaves that are exposed often turn black, brown, red, or yellow.

APPENDIX



REPORT AND SURVEY FORMATS

The standard and nonstandard reports and formats found in this appendix are not designed to replace those found in the SOI issued during mission preparation. This appendix contains report and survey formats developed by both the U.S. Army and North American Treaty Organization (NATO). See Figures D-1 through D-12. This mixture of formats provides mission planners an expanded reference.

SPOTREP (REPORT OF ENEMY SIGHTING) FORMAT

Line

Content

SPOTREP

Include the subject line of message, DTG, and map series, sheet number, and edition, in that order.

ALPHA Units of Measure.

BRAVO Size. Give the number and type of threat forces using the following letter code:

<u>Type Forces</u>	<u>Number Code</u>
Infantry	A
Armored Personnel Carrier (APC)/Infantry	B
Fighting Vehicle (IFV)	
Tank	C
Field artillery	D
Antitank weapon	E
Antiaircraft weapon	F
Military truck	G
Light military vehicle	H

Figure D-1. Sample SPOTREP (report of enemy sighting) format.

<u>Type Forces</u>	<u>Number Code</u>
Helicopter	J
Aircraft	K
Radar	L
Command post	M
Minefield	N
Other tank obstacles	P
Other (followed by description)	Q

To pass the information, prefix the letter with the number of items. In the case of infantry, give the number of personnel seen; in the case of minefields, give the number of fields. Give the dimensions of minefields in DELTA. However, do not merely specify quantity. If reporting physical structures such as bunkers or trenches, specify the types of construction materials used and/or the structure's dimensions. If the amount cannot be determined, state "approximate number" before reporting the item in question.

CHARLIE Activity. Describe the activity of the threat force using the following numerical scale:

<u>Type Activity</u>	<u>Number Code</u>
On the move (followed by direction and speed)	1
Stationary but not dug in	2
In prepared positions	3
Other	4

State the items of equipment or machinery with which the threat is conducting the activity (for example, "Defensive positions being built with bulldozers").

DELTA Location. Identify the position of threat forces using grid reference or other agreed on system of reference. Use of the grid zone designator is important in eliminating confusion if the AO encompasses multiple grid zones. State if the target is in bunkers, caves, trenches, or thick brush.

ECHO Unit. Identify the threat force if it can be determined; if not, provide a description that might be helpful to the tasking agency. If a positive identification is made, indicate how identification was achieved. Describe the uniform (for example, note whether the uniform is brown spotted camouflage, black, or plain green, and with a helmet, soft cap, or beret (give the color)). Describe the patches on the uniform. If possible, describe any vehicle, aircraft, or watercraft markings, numbers,

Figure D-1. Sample SPOTREP (report of enemy sighting) format (continued).

or symbols (for example, an animal or other symbol that would indicate organization to intelligence analysts).

FOXTROT Time (DTG of sighting). Use local time and the standard 24-hour military clock. Do not convert to ZULU time.

GOLF Equipment. Identify or describe any weapons or equipment seen. If reporting on threat personnel with mixed types of small arms and/or other equipment, give the type and amount of each in BRAVO.

HOTEL Remarks. List any additional details that might help an intelligence assessment.

NOTE: The SPOTREP is a tactical intelligence report normally used in battlefield environments but useful in other environments as well. It is useful for reporting tactical information through the SOCCE when GP forces are closing with the SFOD and/or the SFOD and GP forces are integrated into the same operation.

Figure D-1. Sample SPOTREP (report of enemy sighting) format (continued).

TGTRECONREP (TARGET RECONNAISSANCE REPORT) FORMAT

1. **GENERAL.** One of the SFOD's most important products is the reconnaissance report on a specific target. Preparation of the report begins with the warning order and is completed as soon as the reconnaissance is complete. Format and composition of the report are described below. SFODs are often tasked with conducting a detailed reconnaissance in support of sabotage or other DA against a specific target. Usually, such targets are fixed industrial or military installations, but other types of targets can be surveyed as well.
2. **INFORMATION GATHERING AND PLANNING.** The first and probably most important part of a target reconnaissance report is information gathering and planning. Use the following sources to gather information:
 - a. Latest edition maps:
 - 1:250,000 scale of the region where the target is located.
 - 1:50,000 scale covering a 20-NM radius around the target.
 - 1:25,000 scale of the target and surrounding area.

Figure D-2. Sample TGTRECONREP (target reconnaissance report) format.

- 1:12,500 scale of the target and specific points of interest.
 - City maps, tactical commander's terrain analysis (TACCTA) maps, sketches, and special maps (if relevant and available).
- b. Aerial and satellite photography.
- c. Previous reports (for example, reconnaissance reports, agent reports, PW interrogation reports, open source literature, captured documents, area studies, and detailed installation analyses).
- d. Personnel (for example, prisoners deliberately captured for information on the target and local inhabitants of the area).
- e. OB, installation data, and overlays covering a 20-NM radius around the target. Minimum data required include-
- Ground OB.
 - Air OB.
 - Naval OB.
 - Missile OB.
 - Electronic OB.
- f. When planning the reconnaissance, consider the following points:
- Time limitations.
 - Time of the year.
 - Weather (wetness in particular).
 - Light data (including moon phase, first and last light).
 - Route study to and from the target.
 - Threat forces (in detail).
 - Locals (hostile, friendly, and nonbelligerent).
 - Friendly forces in the area.
 - General and specific technical detail to be collected.
 - Casualty handling procedures.
- g. When planning the specific target surveillance, consider special equipment necessary for mission accomplishment. Examples include:
- Amphibious equipment.
 - Binoculars.
 - Camera (still, movie, video).
 - Climbing and scaling aids.
 - Night vision devices.
 - Engineer's notebook.
 - Writing utensil.
 - Ruler and/or measuring tape.

Figure D-2. Sample TGTRECONREP (target reconnaissance report) format (continued).

3. TARGET RECONNAISSANCE REPORT PREPARATION. A target reconnaissance report is divided into seven parts. The first three parts contain sketches as part of the data and should be in sequence. All the information needs to be neatly and systematically recorded. Only by following this system will the information be detailed and accurate. Blanks are not filled in with guesswork, but are marked with a query (for example, "50 meters?" or "50 to 60 meters?").

PART ONE: Sketch Map (Situation Sketch). Include the following information in the sequence shown below:

- a. Coverage of 500 square meters.
- b. Name of reporter, unit, north magnetic arrow, grid reference, map sheet number, type of target, DTG, and scale used.
- c. Other information:
 - Wooded area (coniferous and/or deciduous).
 - Rivers (direction, speed, and obstacles).
 - Hills (severity of climbs).
 - Habitation.
 - Fences, hedges, ditches, gates.
 - Ground conditions.
 - Civilian and military vehicle movement (times, directions, and types).
 - Threat forces locations.
 - Target to be surveyed or attacked.
 - Indication from which direction the target was observed before a detailed reconnaissance.
 - Suggested patrol base and/or MSS.
 - Any other pertinent information.

PART TWO: Side Elevation of Target. Include the following information:

- a. Straight line diagram showing side elevation, plan, and end view of the target.
- b. Scale used.
- c. Side elevation diagram label to indicate the direction from which the target was viewed.
- d. All relevant dimensions.
- e. Estimates marked with a query.
- f. Color of the target.
- g. Access to the target.

Figure D-2. Sample TGTRECONREP (target reconnaissance report) format (continued).

h. Proposed charge placement and (if applicable) angle of cuts to be made.

i. Number of components.

j. Location of components (if not in plain view).

PART THREE: Cross-Sectional Diagram of Components to Be Attacked. Include the following information:

a. Diagram of all components.

b. Dimensions.

c. Components labelled by quantity.

d. Type of construction materials (wood, steel, plastic, or masonry).

PART FOUR: Explosives and Accessories. List any explosives, incendiaries, other devices, and accessories necessary for destruction or degradation of the target.

PART FIVE: Special Equipment. List any special equipment required (for example, boats, rope, ladders, and wire).

PART SIX: Security. Include the following information:

a. Strength of threat forces.

b. Alertness of threat forces.

c. Changing of guard times.

d. Communications (for example, telephone and radio).

e. Transport.

f. Weapons positions and command bunkers.

g. Fortifications, barrier scheme, and construction details.

h. Alarms and surveillance devices.

i. Dogs.

PART SEVEN: Unusual Occurrences. List all unusual and/or unexplained occurrences observed during the target reconnaissance. Include the presence of an unusually large guard force or the appearance of new structures at the target site.

Figure D-2. Sample TGTRECONREP (target reconnaissance report) format (continued).

ROUTEREP (ROUTES AND ROADS REPORT) FORMAT

<u>Line</u>	<u>Content</u>
ROUTEREP	Include the subject line of message followed by serial number and map series, sheet number, and edition, in that order.
ALPHA	Units of Measure.
BRAVO	Location. Give the location of the start and finish of that part of the route actually reconnoitered.
CHARLIE	Type. Indicate the type of route by the following letter code:
<u>Type Route</u>	<u>Letter Code</u>
All-weather route	X
Limited all-weather route	Y
Fair-weather route	Z
Type X	has the following characteristics:
	- Is passable to all traffic in any weather except deep snow or flood.
	- Has waterproof surfaces only.
Type Y	has the following characteristics:
	- Is limited to the volume of traffic in bad weather (for example, muddy shoulders).
	- Does not have waterproof surfaces. These surfaces are considerably affected by rain, frost, thaw, or heat.
NOTE:	Heavy unrestricted use during adverse weather may cause complete breakdown of these surfaces causing roads to be closed for short periods.
Type Z	has the following characteristics:
	- Is passable only in fair weather.
	- Is impassable in bad weather.
	- Cannot be kept open by maintenance short of major construction.
DELTA	Military Classification. The SFOD engineers make this assessment using the following information as a guide:
	Class 50 - Average traffic routes
	Class 80 - Heavy traffic routes
	Class 120 - Very heavy traffic routes

Figure D-3. Sample ROUTEREP (routes and roads report) format.

ECHO Width. Report the average width of a travelled way followed by the average width of grading. The "travelled way" is the hard surface of the road. The "width of grading" is the width of the travelled way plus the width of the hard shoulders. (For diagram see STANAG 2174.)

FOXTROT Route Constriction. List these routes individually and describe in the following order:

First: Nature of constriction.

Second: Location of constriction.

Third: Type of constriction shown as letter in the following letter code:

<u>Type Constriction</u>	<u>Letter Code</u>
Height of constriction	A
Width of constriction	B
Radius of curve of constriction	C
Gradient	D

Fourth: Dimensions of constriction using length/height unit of measure given in ALPHA.

Fifth: Bypass potential at constriction using the following letter code:

<u>Type Bypass</u>	<u>Letter Code</u>
Bypass easy. Local detour possible without engineer effort.	P
Bypass difficult. Bypass possible after engineer improvement.	Q
Bypass impossible.	R

NOTE: The critical heights, widths, radii of curvature, and gradients to be reported must be given in the SFOD's collection plan.

GOLF Concealment. Use the following numerical code to categorize the availability of concealment from the air:

<u>Type Concealment</u>	<u>Number Code</u>
Good concealment available at regular intervals along route.	1
Some concealment available.	2
Little or no concealment possible.	3

Figure D-3. Sample ROUTEREP (routes and roads report) format (continued).

HOTEL Special Considerations. Describe any other factors that may have to be considered by a force intending to use a route. The main meteorological obstacles are snow, flooding, and ice. Include other problems such as refugees and local traffic. Use the following numerical code to list hazards:

<u>Type Hazard</u>	<u>Number Code</u>
Snow (see below).	1
Flood (see below).	2
Ice. Ice conditions are present and may restrict movement.	3
Other. These hazards should be briefly described.	4

Use the following letter codes and suffixes to qualify snow and flood conditions:

Snow:

<u>Qualification</u>	<u>Letter Code</u>
No hindrance to wheeled vehicles.	P
Movement difficult for wheeled vehicles.	Q
Some digging or other route preparation may be necessary in places. Movement impossible for wheeled vehicles.	R

NOTE: The letter is followed by depth of snow in unit of measure given in ALPHA.

Flood:

<u>Qualification</u>	<u>Letter Code</u>
No hindrance to wheeled vehicles.	P
Movement difficult for wheeled vehicles.	Q
Some route preparation may be necessary in places. Waterproofing or fording gear is advisable. Movement impossible for wheeled vehicles.	R

NOTE: The letter is followed by depth of flood water over roads in unit of measure given in ALPHA.

Figure D-3. Sample ROUTEREP (routes and roads report) format (continued).

TACBEREP (TACTICAL BEACH REPORT) FORMAT

<u>Line</u>	<u>Content</u>
TACBEREP	Include the subject line of message and serial number followed by code name, map series, sheet number, and edition, in that order.
ALPHA	Units of Measure.
BRAVO	Offshore Obstructions. Include previously unknown offshore obstructions showing above water at low water. Give a description of their positions using grid references or bearings and ranges from known landmarks or charted reference points.
CHARLIE	Littoral Drift. When the littoral drift significantly differs in velocity or direction from earlier estimations, indicate the new velocity in knots to the nearest 1/10 knot (one knot equals approximately 31 meters per minute). Littoral drift is current moving generally parallel and adjacent to the shoreline. Express the direction of the current flow as the LEFT or RIGHT. Direction always refers to the beach area viewed from seaward.
DELTA	Datum Point(s) (DP). Indicate the DPs as required by the existing situation. These points are fixed position(s) to which sounding lines are related. The existing situation will dictate whether one or more DPs will be required. DPs are designated by letters, (for example, DP A, DP B, DP C). Each DP must be "fixed" and reported by grid references (8 digits if possible), or by bearings and ranges, or by cross bearings from known landmarks or charted reference points.
ECHO	Sounding Interval. Give the distance between each sounding on a sounding line. The sounding interval may be varied by particular units, specific conditions, or the requirements of the command employing the SFOD.
FOXTROT	Sounding Lines. Use the following information to indicate sounding lines:
	1. Each sounding line is numbered: F1, F2, and F3. The information relating to these sounding lines is provided in five subparagraphs (a through e), each reporting separate types of information. The sounding line designation consists of three characters. The first character is the letter designating the DP to which the sounding line is related. The second and third characters are two digit numbers that designate the sequential number of individual sounding lines (for

Figure D-4. Sample TACBEREP (tactical beach report) format.

example, A01, A02, A03, B01, and B02). The subparagraphs a through e provide the following information:

- a. Locates the water line at the time of sounding (WLTS) in relation to the applicable DP and is expressed as bearing range from the DP. (The DP will always be on the bearing of the first sounding line).
- b. Indicates the bearing of the sounding line as viewed from seaward.
- c. Indicates the DTG (the month and year are not required).
- d. Indicates the distance (in the unit of measure selected in ALPHA) and WLTS to the back of beach (BOB) and the vertical rise over this distance along the bearing of the sounding line. BOB is that part of the shoreline, normally well defined, where extreme stormwave action ends and hinterland vegetation begins. Where there are cliffs or walls and other man-made barriers, they will normally be designated the BOB. If the vertical rise cannot be established, then the gradient should be estimated using the following letter code:

	<u>Gradient</u>	<u>Letter Code</u>
Flat	Flatter than 1:20	V
Mild	1:61 to 1:20	W
Gentle	1:31 to 1:60	X
Moderate	1:15 to 1:30	Y
Steep	Steeper than 1:15	Z

- e. Indicates each sounding to the nearest 1/5 meter. The soundings must be reported in linear sequence commencing from WLTS and working seaward.
2. For the second and subsequent sounding lines, the report will show similar data except that, under subparagraph a, the WLTS may be expressed by-
- a. Indicating the bearings and distance from the WLTS of previous sounding line.
 - b. Indicating the bearing and distance from the DP.
 - c. Using the same procedure as in FOXTROT 1.a if any sounding line is to be based on a new DP.

GOLF Underwater Obstacles. Indicate the underwater obstruction relative to sounding lines by naming the type of obstruction.

HOTEL General Beach Composition. Describe the beach as a whole. The beach is divided into two parts: the foreshore (mean low water [MLW] to mean

Figure D-4. Sample TACBEREP (tactical beach report) format (continued).

high water [MHW]) and the backshore (MHW to BOB). Include an assessment of underwater composition. Use the following letter code:

<u>Beach Composition</u>	<u>Letter Code</u>
Mud	A
Clay	B
Sand - up to pinhead size	C
Gravel (shingle) - up to top of thumb size	D
Pebbles - up to clenched fist size	E
Cobbles - up to human head size	F
Boulders - larger than human head	G
Rock	H
Coral	J

NOTE: If there is marked variation in composition along the beach, this fact is to be reported using code by reference to designated sounding line numbers (for example, H.I.A08 to B02E, that is, foreshore line A08 to B02 now composed of pebbles).

JULIET General Trafficability of Beach. Indicate the general trafficability of the beach. Consider only the following two areas of the beach: the portion between WLTS and MHW and the backshore. The color of soil and vegetation often gives an indication of the trafficability in an area. Some examples follow:

- a. Light colored soils usually indicate good drainage. Examples are chalk (unless badly broken up), gravel, and sand. These soils usually provide good going for vehicles.
- b. Brown soils generally provide good going unless wet. Dark brown soils, in particular, tend to be sticky and heavy when wet and often have a treacherous surface crust.
- c. Red soils are uncertain. Those derived from sandstone or limestone usually provide good going, although dull red or purple clay soils are almost impassable when wet.
- d. Grey slate-colored soils are typical of clay. They provide generally good going except if wet, when they may be impassable to heavy vehicles.
- e. Black soil usually denotes bad going. It can indicate peat or boggy ground; such ground should be avoided until a safe route has been reconnoitered.
- f. Bright green patches or grass or vegetation in an otherwise uniform tract usually gives warning of soft areas that are to be avoided.

Figure D-4. Sample TACBEREP (tactical beach report) format (continued).

Use the following letter code:

<u>Trafficability Code</u>	<u>Letter Code</u>
Firm - can be used by 2-wheel drive vehicles or 4-wheel drive vehicles and trailers, unless heavy and continuous use is intended.	W
Moderate - can be used by military 3-or 4-ton vehicles which should be able to start from rest using 4 wheel drive. Beach matting and/or roadway is recommended.	X
Soft - cannot be used by 4-wheel drive vehicles to start from rest but might be able to cross a soft patch if already moving. Beach matting and/or roadway is recommended.	Y
Very Soft - cannot be passed with wheeled vehicles. Tracked vehicles may experience difficulty. Beach matting and/or roadway is required (for example, J.1.X2Z).	Z

NOTE: If there are marked differences in trafficability along the beach, they are to be reported in a similar manner to HOTEL, above (for example, J.1.A08 and B02 Y, that is, foreshore trafficability now assessed at SOFT between lines A08 and B02). Trafficability can only be assessed as above WLTS. It must be clearly understood that a correct assessment of trafficability cannot be guaranteed, bearing in mind conditions under which the reconnaissance party may be working.

KILO Exits. Describe any new exit(s) or exit(s) that have changed. Describe the beach exit point only where it meets BOB. Use the following letter code to describe exits:

<u>Exit Code</u>	<u>Letter Code</u>
Infantry - if the exit is usable by infantry only, the width is given.	A
Tracked - if the exit is usable by both infantry and tracked vehicles then the width is given followed by the appropriate trafficability code in JULIET above.	B
Wheeled - if the exit is usable by infantry and other vehicles then the width is given followed by the appropriate trafficability code.	C

Figure D-4. Sample TACBEREP (tactical beach report) format (continued).

<u>Exit Code</u>	<u>Letter Code</u>
<p>Unusable - if the exit is unusable then a new exit that would take both wheeled and tracked vehicles 10 meters wide and assessed as SOFT would be signalled as follows: K.1.2782418C 10Y D</p>	
<p>LIMA Position of Beach Reconnaissance Team. Give the position of an SFOD after completing its reconnaissance as a 6-digit grid reference or by some other previously arranged system of reference.</p>	
<p>MIKE Enemy. Indicate if the enemy has been seen or contacted stating YES in the unit report and submit a detailed SPOTREP separately. State NIL if no enemy has been seen or contacted.</p>	
<p>NOVEMBER Remarks. List any additional relevant information.</p>	
<p>NOTE: If there is a preexisting beach survey report and no change is found in the information, the relevant paragraph or subparagraph heading followed by no change (NC) is sent (for example, J.1.XZNC).</p>	

Figure D-4. Sample TACBEREP (tactical beach report) format (continued).

SURFREP (SURF REPORT) FORMAT	
<u>Line</u>	<u>Content</u>
<p>SURFREP</p> <p>Include the subject line of message and serial number followed by code name and map series, sheet numbers, and edition, in that order.</p>	
<p>ALPHA Units of Measure.</p>	
<p>BRAVO Time. State DTG of completion of surf observation.</p>	
<p>CHARLIE Significant Breaker Height. State the average height observed in unit of measure shown in ALPHA of the highest one third of all breakers observed in a 10-minute period (expressed to the nearest 1/5 meter).</p>	
<p>DELTA Maximum Breaker Height. State the largest breaker observed expressed in unit of measure shown in ALPHA.</p>	
<p>ECHO Period. State the time between breakers to nearest second.</p>	

Figure D-5. Sample SURFREP (surf report) format.

FOXTROT Breaker Types. Show the number of each type of wave followed by the letter code of that type of wave as indicated below:

<u>Breaker Type</u>	<u>Letter Code</u>
Spilling: The wave becomes unstable and forms white water at the crest. The white water (foam) expands slowly down the front face of the breaker. Breaking action is mild.	A
Plunging: The wave crest advances so much faster than the base of the wave that it falls almost into the trough with a violent action. The resulting foam appears almost instantly over the complete front. At times, air is caught in the breaker as it tumbles forward, creating a type of explosion.	B
Surging: The wave crest tends to advance faster than the base of the wave, suggesting the formation of a plunging breaker. However, just before breaking completely, the base advances faster than the crest and the plunging is arrested. These crests are generally found at steep gradients.	C

GOLF Angle and/or Direction. State the acute angle that forms between the breaker lines and the shoreline (expressed to the nearest 5 degrees). Express the breaker direction as the direction towards which the breaker is moving as R (right) or L (left) of the observer when he is facing from seaward.

HOTEL Littoral Drift (Inshore Current). Express the speed of the current moving generally parallel and adjacent to the shoreline in the velocity unit of measure specified in ALPHA. This number is followed by the letter R (right) or the letter L (left) to indicate the set (direction) of this current. This set is expressed as the direction towards which the current is flowing (as observed from seaward).

JULIET Lines of Breakers and Width of Surf Zone. Express the number of well defined breaker lines in the surf zone using length unit of measure specified in ALPHA. The width is the distance from the outermost breaker to the extreme uprush of water on the beach.

KILO Remarks. Include special factors that could affect the above report (for example, strong winds and restricted visibility).

Figure D-5. Sample SURFREP (surf report) format (continued).

DELTREP (RIVER/ESTUARY REPORT) FORMAT

<u>Line</u>	<u>Content</u>
DELTREP	Include the subject line of message and serial number followed by map series, sheet numbers, and edition, in that order.
ALPHA	Units of Measure.
BRAVO	Location (area covered by report). Use grid references.
CHARLIE	Main Channel. Show in the following numbered sequence:
1.	Location. Give the grid reference of the entrance to the main channel.
2.	Seaward Approach. State the bearing from seaward of approaches to the main channel.
3.	Reference Points. "Fix" the entrance to the main channel by means of transits and/or bearing of prominent features from seaward. These features must be recognizable on a map or chart. Report as follows:
a.	Prominent Features. Describe and give the position of the feature followed by its bearing from seaward. If more than one, number them 1, 2, and 3.
b.	Transits. Describe and give the position of first point followed by a description and position of second point. If more than one set, number them 1, 2, and 3.
DELTA	Buoys. Show local system of buoys (if any) or markings placed by the SFOD as follows:

<u>Buoy Number</u>	<u>Code</u>
Starboard buoys - shape and color (if any).	1
Port buoys - shape and color (if any).	2
SFOD placed markers - description and location.	3

ECHO Hazards. Tabulate in the following numerical code:

<u>Hazard</u>	<u>Number Code</u>
Sandbars	1
Wrecks	2
Rocks	3
Tidal races	4
Other obstacles	5

NOTE: Locate the hazards with a 6- or 8-digit grid reference and briefly describe them.

Figure D-6. Sample DELTREP (river/estuary report) format.

FOXTROT Navigable Limits. Give the limits that are the highest points upstream in the main channel with the following depths at low water:

<u>Depth</u>	<u>Number Code</u>
2 meters	1
1 meter	2
1/2 meter	3

GOLF Beaching and Landing Points and Their Exits. Describe these points in the following order:

First: Grid reference.

Second: Indicate the type of craft that can use the landing point by the following number code:

<u>Type Vessel</u>	<u>Number Code</u>
Landing Craft Medium/Utility	1
Landing Craft Personnel	2
Shallow draft boats with outboard motors	3

Third: Indicate the overall trafficability of the beaching point and exit by using the following letter code:

<u>Trafficability</u>	<u>Letter Code</u>
Firm - can be used by 2-wheel drive vehicles or 4-wheel drive vehicles and trailers, unless heavy and continuous use is intended.	W
Moderate - can be used by military 3-or 4-ton vehicles that should be able to start from rest using 4-wheel drive. Beach matting and/or roadway is recommended.	X
Soft - cannot be used by 4-wheel drive vehicles to start from rest, but might be able to cross a soft patch if already on the move. Beach matting and/or roadway is recommended.	Y
Very Soft - cannot be used by wheeled vehicles. Tracked vehicles may experience difficulty. Beach matting and/or roadway is required.	Z

NOTE: If the beaching or landing point or its exit is unsuitable for any vehicles, no trafficability code letter is passed.

HOTEL Current. Indicate the speed of the current and/or tidal stream in the unit of measure shown in ALPHA as follows: velocity,

Figure D-6. Sample DELTREP (river/estuary report) format (continued).

direction in which flowing (by use of letters indicating one of the eight points of the compass, for example, SE or W), DTG, and location (grid reference). If necessary to show variation, give several of these units of measure.

JULIET Texture of River Bed. Give this information in the following order:

First: Grid reference.

Second: Letter code indicating composition of river bed as follows:

<u>Texture</u>	<u>Letter Code</u>
Mud	A
Clay	B
Sand (up to pinhead size)	C
Gravel (up to top of thumb size)	D
Other (followed by description)	E

KILO Remarks. Give any other important information in this paragraph.

Figure D-6. Sample DELTREP (river/estuary report) format (continued).

BRIDGEREP (BRIDGE REPORT) FORMAT

<u>Line</u>	<u>Content</u>
BRIDGEREP	Include the subject line of message followed by serial number and map series, sheet numbers, and edition.
ALPHA	Units of Measure.
BRAVO	Location. Give the grid reference of the bridge followed by engineer classification, if known.
CHARLIE	Horizontal Clearance. State the minimum clear distance between the inside edges of the bridge structure beginning at 30 centimeters above the road and continuing upwards.
DELTA	Under Bridge Clearance. Give the height of clearance in unit of measure in ALPHA. State the maximum clear distance between the underside of the bridge and the surface of the ground or of the water. If the water is tidal, include the DTG of measurements.

Figure D-7. Sample BRIDGEREP (bridge report) format.

ECHO Spans.

First: Show the number, material, and type of span construction for each span by number and letter symbols.

Second: List spans in sequence starting from the west. If the bridge is running close to north-south, list the spans from the north and insert the letter N before the numbers and letters.

Third: Show material of span construction in the following letter code:

<u>Material</u>	<u>Letter Code</u>
Steel or other metal	A
Concrete	K
Reinforced concrete	AK
Prestressed concrete	KK
Stone or brick	P
Wood	H
Other types	O

Fourth: Show the type of span construction for each span in the following numerical code:

<u>Span Type</u>	<u>Number Code</u>
Truss	1
Girders	2
Beams	3
Slab	4
Arch (closed spandrel)	5
Arch (open spandrel)	6
Suspension	7
Floating	8
Swing	9
Bascule	10
Vertical lift	11
Others	12

FOXTROT Length and Condition of Spans. List and number length of individual spans in order reported in ECHO above. If any spans are damaged, classify them in the following letter code:

<u>Type Damage</u>	<u>Letter Code</u>
May be significantly damaged but probably capable of supporting light vehicles.	A

Figure D-7. Sample BRIDGEREP (bridge report) format (continued).

<u>Type Damage</u>	<u>Letter Code</u>
Impassable to traffic but span not totally destroyed.	B
Span destroyed.	C

GOLF Overall Length. Give the length in units of measure shown in ALPHA (it may be different from the sum of the span lengths).

HOTEL Roadway Width. Give the width in units of measure shown in ALPHA.

JULIET Overhead Clearance. Give the clearance in units of measure shown in ALPHA at the following points in this order:

- Left shoulder.
- Center of roadway.
- Right shoulder.

NOTE: If all clearances are equal, report figure once only. If there is unlimited clearance, omit this paragraph.

KILO Bridge Bypass. Give the information in the following sequence:

First: State overall potential in the following letter code:

<u>Type Bypass</u>	<u>Letter Code</u>
Bypass easy. The obstacle can be crossed within the immediate vicinity of the bridge without work to improve the bypass.	P
Obstacle can be crossed within the immediate vicinity of the bridge but some work will be necessary to prepare the bypass.	Q
Bypass impossible. Crossing of the obstacle is only possible by a detour some distance from the original site.	R

Second: Show location by grid reference.

Third: Give a brief description of the nature of bypass.

Fourth: List any restrictions including dimensions in units of measure shown in ALPHA.

LIMA Remarks.

Figure D-7. Sample BRIDGEREP (bridge report) format (continued).

TECHNICAL INTELLIGENCE EXPLOITATION PLAN AND CATEGORY REQUIREMENTS FORMAT

This report includes an exhaustive listing of exploitation categories and collection requirements regarding items of interest to battlefield TECHINT units. This report shows how TECHINT requirements are generated. SFODs engaged in SR need to be prepared to submit TECHINT reports on modified or new items encountered.

PRELIMINARY REQUIREMENTS FOR EXPLOITATION

The preliminary requirements for exploitation are:

- Determining safety requirements.
- Examining additional information requirements.
- Determining intended recipient of intelligence.
- Formulating detailed project timeline for assessment format.
- Conducting a leader's reconnaissance of subject to be assessed and the area of the assessment.

GENERAL EXPLOITATION PLAN

The general exploitation plan covers—

- Initial photography. Preliminary photographs of outside and inside (show status of equipment before assessment).
- Inventory.
 - Examine system for any written information (documents, operator manuals, maps), data plates, or operating instructions.
 - Identify all individual components requiring separate analysis.
- If equipment requires further analysis, determine exploitation category and proceed.

EXPLOITATION CATEGORY REQUIREMENTS

Mobility Requirements

Track Vehicles

List of subcategories.

- Infantry fighting vehicles.
- Cargo or transport.
- Armored personnel carrier.
- Tank chassis.
- Self-propelled howitzer.
- Self-propelled rocket launcher.
- Tank destroyer.
- Self-propelled antiaircraft.

Figure D-8. Sample technical intelligence exploitation plan and category requirements format.

Main category requirements.

- Type of vehicle.
- Engine type.
- Cooling system.
- Power train description.
- Brake system.
- Suspension system.
- Steering system.
- Vehicle description.
- Electrical system.
- Physical dimensions.

Subcategory requirements.

- Infantry fighting vehicle:
 - Type of armor.
 - Armor thickness.
 - Maximum personnel seating capability.
 - Location and number of firing ports.
 - Location of hatches.
- Cargo or transport:
 - Cargo compartment size.
 - Maximum height carrying capability.
 - Maximum personnel seating capability.
 - Type of cargo vehicle is designed for.
- Armored personnel carrier:
 - Type of armor.
 - Armor thickness.
 - Maximum personnel carrying capability.
 - Location and number of firing ports.
 - Location of hatches.
- Tank, howitzer, self-propelled rocket launcher, or tank destroyer:
 - Type of armor.
 - Armor thickness.
 - Body design.
 - Number of road wheels and support rollers.
 - Turret location.
 - Type of track.
 - Location of hatches.
 - Power pack location.

Figure D-8. Sample technical intelligence exploitation plan and category requirements format (continued).

Wheeled Vehicles

List of subcategories.

- Reconnaissance vehicles.
- Cargo or transport vehicles.
- Armored personnel carrier.
- Infantry fighting vehicles.

Main category requirements.

- Type of vehicle.
- Vehicle description.
- Physical dimensions.
- Engine type.
- Cooling system.
- Power train description.
- Electrical system.
- Brake system.
- Suspension system.
- Steering system.

Subcategory requirements.

- Reconnaissance vehicles:
 - Maximum personnel seating.
 - Armor thickness.
 - Special exhaust system.
- Cargo or transport vehicles:
 - Cargo compartment size.
 - Maximum weight-carrying capability.
 - Maximum personnel seating compartment.
 - Type of cargo vehicle is designed for.
- Armored personnel carrier:
 - Armor thickness.
 - Maximum personnel seating capability.
 - Location and number of firing ports.
 - Location of hatches.
 - Type of armor.
- Infantry fighting vehicle: Same as above.

Figure D-8. Sample technical intelligence exploitation plan and category requirements format (continued).

Engineer Equipment

List of categories.

- Clearing equipment.
- Ditching equipment.
- Water and/or gap crossing equipment.
- Air compressor.
- Power supply equipment.
- Special purpose equipment.

Main category requirements.

- Type prime mover.
- Vehicle description.
- Physical dimensions.
- Engine type.
- Cooling system.
- Power train description.
- Brake system.
- Suspension system.
- Electrical system.
- Steering system.

Subcategory requirements.

- Clearing equipment:
 - Type.
 - Crew.
 - Power.
 - Capabilities.
- Ditching equipment: Same as above.
- Water and/or gap crossing equipment:
 - Crew.
 - Capacity.
 - Power.
 - Type.
 - Width of bridge.
 - Height of bridge.
 - Length of bridge.
 - Spanning length.
- Power supply equipment.
 - Type.
 - Power.
 - Capabilities.

Figure D-8. Sample technical intelligence exploitation plan and category requirements format (continued).

Subcategory requirements (continued):

- Air compressor: Same as above.
- Special purpose equipment: Same as above.

Rotary Wing Aircraft

List of subcategories.

- Cargo and/or transport.
- Attack and/or assault.

Main category requirements.

- Body type.
- Main rotor system.
- Tail rotor system.
- Landing gear.
- Fuel system.
- Engines.
- Cooling system.
- Electrical system.
- Cargo compartment size.
- Cargo loading and/or unloading system.
- Maximum personnel seating.
- Maximum weight-carrying capability.
- Flight controls.
- Armor.
- Internal weapons mounts.

Subcategory requirements.

- Cargo and/or transport: External winch platform.
- Attack and/or assault:
 - Weapons mounts.
 - Machine guns.
 - Rockets.
 - Bombs.
 - Antitank guided missiles.
 - Target acquisition.

C-E REQUIREMENTS

Communications

List of subcategories.

- Radio.
- Line equipment.

Figure D-8. Sample technical intelligence exploitation plan and category requirements format (continued).

Main category requirements.

- Size.
- Weight.
- Documents and manuals.
- Vehicular mounted or manpack.
- Location found (building, van, field, or house).
- Data plate information (nomenclature, serial number, year of manufacture).
- Power requirement.
- Planning range and/or range of operation.

Subcategory requirements.

- Radios:
 - Radio frequency power output.
 - Types of antennas used.
 - Modes of operation.
 - Frequency range.
 - Tuning method (continuous or detent).
 - Preset frequencies (yes or no, how many).
 - Batteries.
 - External antenna matching unit.
 - Number of power supplies.
 - Remote capability.
 - Retransmission capability.
 - Type of radio (transceiver, receiver, or transmitter).
 - Types of modulation (AM or FM).
 - Morse code capability.
 - Frequency hopping capability.
- Line equipment:
 - Wire thickness.
 - Ringer capability.
 - Line handling capability.
 - Motor speed.
 - Words per minute transmission.
 - Line current.
 - Size of paper used.
 - Reperforator capability.
 - Built-in operator pack.
 - Length and diameter of patch cord.

Figure D-8. Sample technical intelligence exploitation plan and category requirements format (continued).

Radar

List of subcategories.

- Air traffic control.
- Weather.
- Ground surveillance.
- Fire control.

Main category requirements.

- Size.
- Weight.
- Documents and manuals.
- Location found (airport, battlefield, house, van).
- Data plate information.

Electronic Warfare

List of subcategories.

- Jammers.
- Direction finders.

Main category requirements.

- Size.
- Weight.
- Documents and manuals.
- Location found.
- Vehicular mounted or manpack.
- Data plate information.
- Power requirements.
- Frequency range.
- Frequency hopping capability.

Subcategory requirements.

- Jammers:
 - How many bandwidths can they jam at one time?
 - What is strength of jamming signal?
 - Can it jam radars and communications?
- Direction finders:
 - Can it locate a target alone?
 - How long does it take to locate a target?
 - Is it an automatic or manual direction finding unit?

Figure D-8. Sample technical intelligence exploitation plan and category requirements format (continued).

Electronic Devices

List of subcategories.

- Searchlights.
- Starlight scopes.
- Mine detectors.
- Distance measuring devices.
- Wind and/or weather measuring devices.

Main category requirements.

- Size.
- Weight.
- Documents and manuals.
- Location found.
- Data plate information.
- Power requirement.
- Vehicular mounted or manpack.

Subcategory requirements.

- Searchlights:
 - What is the candlepower rating?
 - What is the range of the light?
- Starlight scopes:
 - What is the range it can detect someone or something?
 - What is the minimum amount of light required to operate?
 - Is it a transmitter and a receiver?
 - Can it be mounted on a weapon as well as handheld?
- Mine detectors:
 - What is the depth it can detect items in soil?
 - What is the depth it can detect items in water?
 - Can it detect metallic and/or nonmetallic mines?
 - How many transmitters does it have?
 - How many receivers does it have?
- Distance measuring devices:
 - What is the maximum distance it can measure?
 - What is the minimum distance it can measure?
 - Can it measure in metric and American standards?

Figure D-8. Sample technical intelligence exploitation plan and category requirements format (continued).

- Wind and/or weather measuring devices:
 - What is the maximum wind speed it can measure?
 - What is the minimum wind speed it can measure?
 - What type of weather measurements will it give?
 - Does it give a printout of the weather report?

CHEMICAL, MEDICAL, AND LOGISTIC (CML) REQUIREMENTS

Detectors

List of subcategories.

- Chemical and/or biological detection and identification kits and sets.
- Radiation detection and measuring instruments.

Main category requirements.

- Size.
- Weight.
- Documents and manuals.
- Vehicular or manpacked.
- Location found (building, van, field, house).
- Data plate information (nomenclature, serial number).
- Planning range and/or range of operation.
- Power requirements.
- Inventory.
- Photographs.

Subcategory requirements.

- Chemical and/or biological detector and identification kits and sets:
 - What agents will they detect or identify?
 - Do they have remote capabilities?
 - How easy are they to use?
 - How effective are they?
 - What levels of agents can they detect?
 - Can detectors distinguish agents?
 - Can kits identify multiple agents at the same time?
 - Will they sample air, soil, water (which one or ones)?
- Chemical or biological detectors and alarms:
 - What agents will they detect?
 - Do they have remote capabilities?
 - How easy are they to use?
 - How effective are they?

Figure D-8. Sample technical intelligence exploitation plan and category requirements format (continued).

- Chemical or biological detectors and alarms (continued):
 - Type of alarm (audio or visual).
 - Time of contact between sampling and alarm.
- Radiological dosimeters and dosimeter sets:
 - What equipment is required?
 - What is the total dose measured?
 - Do they measure present or total doses?
 - What type of radiation is measured?
- Radiological area survey meters:
 - What type of radiation is measured?
 - Are they manpack, aircraft, or vehicle mounted?
 - How is equipment operated?
 - What type of radiation is detectable?
- Radiological low-level radiation detection meters:
 - What type of radiation is detectable?
 - What level is measureable?
 - How does equipment measure radiation?

Decontamination Equipment

List of subcategories.

- Individual decontamination kits.
- Portable decontamination apparatuses.
- Vehicle mounted decontamination apparatuses.

Main category requirements.

- Size.
- Weight.
- Documents and manuals.
- Location found (building, van, field, house).
- Data plate information.
- Power requirement.
- Inventory.
- Photographs.

Subcategory requirements.

- Individual decontamination kits:
 - How many times can they be used?
 - What type of decontaminants do they use?
 - What agents are they used against?

Figure D-8. Sample technical intelligence exploitation plan and category requirements format (continued).

- Individual decontamination kits (continued):
 - How easy are they to use?
 - How effective are they?
- Portable decontamination apparatuses:
 - How is equipment transported?
 - What type of decontaminants are used?
 - What agents are they used against?
 - How easy are they to use?
 - How effective are they?
 - What amount of equipment can they decontaminate?
 - Is extra equipment needed to support operation?
- Vehicle mounted decontamination apparatuses:
 - Where are they mounted?
 - What type of decontaminants are used?
 - What agents are they used against?
 - How many crew members are required?
 - How effective are they?
 - What amount of equipment can they decontaminate?
 - Is extra equipment needed to support operation?

Protection Equipment

List of subcategories.

- Individual protection.
- Collective protection.

Main category requirements.

- Size.
- Weight.
- Documents and manuals.
- Location found.
- Data plate information.
- Power requirement.
- Inventory.
- Photographs.

Subcategory requirements.

- Individual protection:
 - What protection is afforded?
 - How is equipment used?

Figure D-8. Sample technical intelligence exploitation plan and category requirements format (continued).

- Individual protection (continued):
 - How effective is equipment?
 - What type of filter is used, if any?
 - How easy is it to maintain?
- Collective protection:
 - What protection is afforded?
 - How is equipment used?
 - How effective is equipment?
 - What type of filtering system is used?
 - How easy is it to maintain?
 - How many personnel can system accommodate?

Smoke Systems

List of subcategories.

- Hand grenade.
- Smoke pot.
- Smoke drum.
- VESS.
- Smoke generator.

Main category requirements.

- Size.
- Weight.
- Documents and manuals.
- Location found.
- Data plate information.
- Power requirement.
- Inventory.
- Photographs.

Subcategory requirements.

- Hand grenade:
 - Is it signaling smoke?
 - What is the duration of smoke?
 - How effective is the smoke?
 - Does the smoke contain any additives?
- Smoke pot:
 - What is the burn time?
 - How effective is the smoke?

Figure D-8. Sample technical intelligence exploitation plan and category requirements format (continued).

- Smoke pot (continued):
 - Can the pots be stacked?
 - Is it a floating smoke pot?
 - Does the smoke contain any additives?
- Smoke drum:
 - What is the burn time?
 - How effective is the smoke?
 - Is it a floating drum?
 - Does the smoke contain any additives?
- VESS:
 - How effective is the smoke?
 - How much of the vehicle fuel supply is required?
 - Does the smoke contain any additives?
- Smoke generator:
 - How effective is the smoke?
 - How is it supplied with fuel?
 - What fuel is used?
 - What maintenance is required?
 - Does the smoke contain any additives?

NBC Vehicles

List of subcategories.

- Reconnaissance vehicles.
- Area marking.

Main category requirements.

- Size.
- Weight.
- Documents and manuals.
- Location found.
- Data plate information.
- Power requirement.
- Inventory.
- Photographs.

Subcategory requirements.

- Reconnaissance vehicles:
 - Are they wheeled or tracked?
 - Are they equipped with overpressure?

Figure D-8. Sample technical intelligence exploitation plan and category requirements format (continued).

- Reconnaissance vehicles (continued):
 - What chemical detectors are used?
 - What radiological detectors are used?
 - What miscellaneous NBC equipment is used?
- Area marking vehicles:
 - Are they wheeled or tracked?
 - Are they equipped with overpressure?
 - What chemical detectors are used?
 - What radiological detectors are used?
 - What type of marking sets are used?
 - What miscellaneous NBC equipment is used?

Medical Kits

List of subcategories.

- Personal kits.
- Medical kits.
- Specialized kits.

Main category requirements.

- Size.
- Weight.
- Manuals.
- Location found.
- Data plate information.
- Power requirement.
- Photographs.
- Inventory.

Subcategory requirements.

- Personal kits:
 - How and where are they carried?
 - What type of injuries and ailments can be treated?
- Medical kits:
 - How are they issued?
 - How and where are they carried?
 - What type of injuries and ailments can be treated?
- Specialized kits:
 - How are they issued?
 - How and where are they carried?
 - What type of injuries and ailments can be treated?

Figure D-8. Sample technical intelligence exploitation plan and category requirements format (continued).

Hospitals

List of subcategories.

- Aid stations.
- Mobile hospitals.
- Permanent hospitals.

Main category requirements.

- Size.
- Documents, manuals, and forms.
- Location found.
- Power requirements.
- Treatment capabilities.
- Personnel required to operate.
- Number of personnel that can be treated.
- Photographs.
- Inventory.
- Adjacent hospital activities (labs, clinics).
- At which level of command controlled.

Subcategory requirements.

- Aid stations:
 - Amount of time required to become operational.
 - Logistic support needed for movement.
 - Time required for evacuation.
- Mobile hospital:
 - Amount of time required to become operational.
 - Logistic support needed for movement.
- Permanent hospital:
 - Amount of time required to become operational.
 - Logistic support needed for movement.

Medical Vehicles

List of subcategories.

- Ambulances.
- Aircraft.

Main category requirements.

- Documents and manuals.
- Inventory.
- Photographs.
- Crew members required.

Figure D-8. Sample technical intelligence exploitation plan and category requirements format (continued).

Main category requirements.

- Personnel transport capability.
- On-board treatment capability.
- On-board NBC protection capability.

Subcategory requirements.

- Ambulances:
 - Wheeled or tracked vehicles.
 - Type fuel used.

Messing

List of subcategories.

- Field utensils.
- Portable pots and pans.
- Portable immersion heater.
- Field rations.

Main category requirements.

- Size.
- Weight.
- Documents and manuals.
- Location.
- Data plate information.
- Inventory.
- Photographs.

Subcategory requirements.

- Field utensils (material used).
- Portable pots and pans (types of material).
- Portable immersion heater (fuel used).

Field rations:

- Types.
- Preparation method.
- Number of servings per pack.

Camouflage and Concealment

List of subcategories.

- Camouflage netting.
- Camouflage screening.
- Camouflage clothing.

Figure D-8. Sample technical intelligence exploitation plan and category requirements format (continued).

Main category requirements.

- Size.
- Weight.
- Documents and manuals.
- Location found.
- Data plate information.
- Inventory.
- Photographs.
- Colors.
- Pattern.
- Type of material used.
- Radar reflective (Y/N).
- Infrared reflective (Y/N).
- Serviceability and durability.

Subcategory requirements.

- Camouflage netting.
- Camouflage screening.
- Camouflage clothing.

Body Armor

List of subcategories.

- Body vest.
- Helmets.

Main category requirements.

- Size.
- Weight.
- Documents and manuals.
- Location found.
- Data plate information.
- Inventory.
- Photographs.
- Type of protection given.
- Type of material used.

Subcategory requirements.

- Body vests.
- Helmets.

Missiles, Rocket, and Munitions

List of subcategories.

- Artillery.
- Mortars.

Figure D-8. Sample technical intelligence exploitation plan and category requirements format (continued).

List of subcategories (continued):

- Bombs.
- Mines.
- Booby traps.
- Grenades.
- Missiles.
- Rockets.

Main category requirements.

- Size.
- Type and use.
- Filler.
- Fuze.
- Markings.
- Color code.
- System used in.

Subcategory requirements.

- Artillery and missiles:
 - Propellant and rocket motor.
 - Guidance.
- Mortars, grenades, and rockets (propellant).
- Mines (additional fuze wells).

Artillery

List of subcategories.

- Tube artillery.
- Antiaircraft guns.

Main category requirements.

- Towed or self-propelled:
 - Self-propelled (cab or turret, opened or closed).
 - Towed (type of prime mover).
- Caliber.
- Type of recoil (spring, hydraulic, pneumatic).
- Length of recoil movement.
- Type of elevation system (manual or power) and limit.
- Type of traverse system (manual or power) and limit.
- Muzzle brake and flash suppressor.

Figure D-8. Sample technical intelligence exploitation plan and category requirements format (continued).

Subcategory requirements.

- Tube artillery:
 - Type of breech mechanism (sliding wedge).
 - Type of ammunition (fixed, semifixed, separate).
 - Rifled or smooth bore.
 - Bore evacuator.
 - Fire control (direct or indirect).
- Antiaircraft guns:
 - Single or multiple barrels.
 - Type of fire control.
 - Type of loading mechanism.
 - Type of firing mechanism (percussion, electric).
 - Gun drive system (manual, electric, mechanical).

Small Arms

List of subcategories.

- Pistols.
- Rifles.
- Machine guns.
- Cannons.

Main category requirements.

- Caliber.
- Type of feeding and quantity.
- Single shot or automatic.
- Smooth bore or rifled.
- Fixed or adjustable sights.
- Heavy or light weapon.
- Muzzle brake or flash suppressor.
- Type of ammunition used.
- Type of locking system.
- Gas or recoil operated.

Subcategory requirements.

- Pistols:
 - Revolver or semiautomatic.
 - Rimmed cartridge.
 - Last round stop.

Figure D-8. Sample technical intelligence exploitation plan and category requirements format (continued).

Subcategory requirements (continued):

- Rifles:
 - Carbine, assault, or sniper.
 - Steel sights or scope.
 - What power scope.
 - Last round stop.
 - Fixed or removable bayonet.
 - Fires from open or closed bolt.
- Machine guns:
 - Heavy or light.
 - Vehicle mounted or handcarried.
 - Stock or spade grips.
 - Last round stop.
 - Fixed or adjustable bipod or tripod.
- Cannons:
 - Ground and antiaircraft capabilities.
 - Manual and electric fire.
 - Type of fire control.
 - Fires from open or closed bolt position.

Grenade Launchers

List of categories

- Handheld.
- Tripod mounted.
- Vehicle mounted.

Main category requirements.

- Caliber.
- Rifled or smooth bore.
- Method of loading.
- Firing method.
- Type of round.

Subcategory requirements.

- Handheld (attached to another weapon).
- Tripod mounted (crew served, number of members).
- Vehicle mounted (single or multitubed).

Figure D-8. Sample technical intelligence exploitation plan and category requirements format (continued).

Fire Control

List of subcategories.

- Off carriage.
- On carriage.

Main category requirements.

- Use (observation, target destination, aiming, range).
- Type (night vision, laser, optic).
- Style (periscope, telescope, stereoscope) and power.
- Reticle (type, quantity, stability).

Subcategory requirements.

- Off carriage:
 - Weight.
 - Tripod use.
 - Day or night use.
 - Durability.
- On carriage:
 - Location of mount.
 - Type of power for operation.

Recoilless Rifles

List of subcategories.

- Ground mounted.
- Vehicle mounted.
- Shoulder fired.

Main category requirements.

- Caliber.
- Smooth bore or rifled.
- Breech type.
- Type of firing mechanism.
- Spotting gun.
- Fire control.
- Type of round.

Subcategory requirements.

- Ground mounted:
 - Type of mount.
 - Elevation and traverse (methods and limits).
 - Crew served (number of members).

Figure D-8. Sample technical intelligence exploitation plan and category requirements format (continued).

Subcategory requirements (continued):

- Vehicle mounted:
 - Type of vehicle.
 - Elevation and traverse (methods and limits).
 - Type of mount (Can it also be used in ground role?).
 - Crew served (number of members).
- Shoulder fired:
 - Weight.
 - Pistol or grip.
 - Bipod.

Turret and Cupola Mounted Weapons

List of subcategories.

- Tanks.
- Infantry fighting vehicles.

Main category requirements.

- Type of vehicle.
- Location.
- Size.
- Weapons.
- Viewing and fire control.
- Method of operation (power, manual or stabilized).
- Ammunition storage (quantity, type, location).
- Attachments (lights, antennas, grenade projectors).

Subcategory requirements.

- Tanks:
 - Main gun:
 - Caliber.
 - Smooth bore or rifled.
 - Bore evacuator and muzzle flash suppressor.
 - Breech type.
 - Recoil type.
 - Elevation and traverse (method and limits).
 - Firing mechanism.
 - Ammunition types.
 - Method of firing.

Figure D-8. Sample technical intelligence exploitation plan and category requirements format (continued).

- Tanks (continued):
 - Coaxial weapons:
 - Caliber.
 - Type.
 - Ammunition.
 - Method of firing.
 - Cupola:
 - Weapons.
 - Traverse and elevation (method and limits).
 - Fire control.
 - Method of firing.
 - Crew compartment:
 - Number of stations.
 - Firing ports.
- Infantry fighting vehicles:
 - Main guns:
 - Caliber.
 - Type.
 - Method of loading.
 - Method of firing.
 - Fire control.
 - Elevation and traverse (method and limits).
 - Coaxial weapons:
 - Caliber.
 - Type.
 - Method of loading.
 - Method of firing.
 - Crew compartment:
 - Number of stations.
 - Firing ports.
 - Ammunition storage (quantity and type)

Mortars

List of subcategories.

- Manpack.
- Towed.
- Self-propelled.

Figure D-8. Sample technical intelligence exploitation plan and category requirements format (continued).

Main category requirements.

- Caliber.
- Recoil type (if any).
- Traverse mechanism and limits.
- Elevation mechanism and limits.
- Type of firing mechanism.
- Type of ammunition (fixed or separate loading).
- Fire control.

Subcategory requirements.

- Manpack:
 - Mount type (base plate, tripod).
 - Number of crew members required and their mission (two for the tube, one for the base plate, three for the tripod).
 - Capable of mounting on a vehicle.
- Towed:
 - Prime mover.
 - Type of carriage (single or multiple axle).
- Self-propelled:
 - Type of vehicle.
 - Dismountable.

Figure D-8. Sample technical intelligence exploitation plan and category requirements format (continued).

STRUCTURES SURVEY FORMAT

1. Identification.
 - a. Local and Official Name (from map study).
 - b. General Location and Address.
 - c. Map References. Identify by map series, sheet number, and edition.
 - d. Coordinates. State in UTM.
 - e. Additional Information. Indicate any peculiar information, date of original survey, and any updates if applicable.
2. Surrounding area.
 - a. General Information.
 - (1) General overview. Include aerial photograph(s).
 - (2) Map references.
 - (3) Additional information.
 - b. Tactical Considerations.
 - (1) Command posts (CPs). Include the following information:
 - (a) Entrance(s) and approach routes.
 - (b) Security, cover, and concealment.
 - (c) Provisions for water, electricity, telephone, ventilation, rest rooms, adequate working space, and a secure area to install satellite communications (SATCOM) antennas.
 - (d) Building and area recommended for the OPCEN, who owns the building, the address, the point of contact (POC), facilities available in the OPCEN area, and vehicle and foot approach routes to the building. (Ensure the CP is shown on the surrounding area sketch, and if possible, show photographs of the building and area.)
 - (2) Surveillance positions. Include the following:
 - (a) An overwatch of the area.
 - (b) Concealed access routes to the CP and staging areas.
 - (c) Secured and concealed accesses and/or entrances to the surveillance position.
 - (d) Cover and concealment of the surveillance position from observation by personnel located on the site.
 - (e) Provisions for water, electricity, and rest room facilities.
 - (f) The location of the surveillance position on the surrounding area sketch. (Show photographs of the building in which the surveillance position is located, the surveillance position

Figure D-9. Sample structures survey format.

in the building, the view from the surveillance position to the site, and the view from the site to the surveillance position.)

- (g) A description of the following:
 - 1. Type of building.
 - 2. Number of stories.
 - 3. Location of surveillance position in relation to the site.
 - 4. The area to be used by the observer.
 - 5. Who owns the building, address, POC(s), and their telephone numbers.
 - 6. Access routes to the area.
- (3) Staging areas. Include the following:
 - (a) Whether the structure has a basement or other large area concealed from outside view.
 - (b) If the staging area is in the vicinity of the site, preferably in the surrounding area.
 - (c) Suitability for holding 30 to 40 men for 2 to 3 days.
 - (d) Provisions for water, electricity, and rest rooms available, if possible.
 - (e) Whether routes to the CP are concealed from observation by personnel located on the site.
 - (f) Concealment of accesses (for example, underground parking lot).
 - (g) The location of the staging area in relationship to the site, who owns the building, POC for access and his telephone number, recommended approaches to the area, and recommended entrances. (Show the location of the staging area on the surrounding area sketch and photographs of the building and the area.)
- (4) Recommended approaches. Include the following:
 - (a) Main direction from the staging area to the site and surveillance positions.
 - (b) Whether approach is by air, land, or water.
 - (c) Whether it is by vehicle or foot.
 - (d) Any unusual circumstances about the approach (for example, an approach over rooftops of surrounding buildings, facilities such as banks located near the approach that may have 24-hour guards).

Figure D-9. Sample structures survey format (continued).

- (e) Blind or unsecure spots on the approaches.
 - (f) If possible, photographs of the route from the staging area to the site along the recommended approach.
- (5) Sanctuaries. Include the following information:
- (a) Friendly government embassies, churches, and American facilities or residences in the area.
 - (b) The building and the area to be used as the sanctuary.
 - (c) Who owns the building, the address, the POC and telephone number(s), location in relation to the site, and what the facility is normally used for.
 - (d) Location of the sanctuary in relation to helicopter landing zones (HLZs) and evacuation routes.
 - (e) Location of the structure on the surrounding area sketch. (Show photographs of the building and, if possible, of the area to be used as sanctuary.)
- (6) Obstacles and/or danger areas. Include the following information:
- (a) Vegetation and terrain surrounding the site.
 - (b) Open areas (for example, large avenues adjacent to the site).
 - (c) Locations of guarded banks or other guarded facilities, hostile country embassies, and threat group offices.
 - (d) High crime areas and the most common type of criminal occurrence in these areas.
 - (e) Roadways or avenues recommended for approaches that are affected by rush hour traffic.
 - (f) Checkpoints, curfews, police or security patrols, universities, construction areas, police or military installations.
 - (g) Exceptionally well illuminated areas around the site.
3. Grounds description.
- a. General Description. Always orient the direction of the survey to main directions. Pay particular attention to basic locations, type of construction, distances from perimeter barriers to principal structures and then structures of a secondary nature to the principal structures.
 - b. Perimeter Barrier. Total information coverage is required. Emphasize heights, widths, and thicknesses. Zero in on weak spots and describe them in detail.
 - c. Entrances to Grounds. Examine points of normal or prepared access, style of construction, security and/or locking devices, closed-circuit televisions (CCTVs), and guards.
 - d. Structures. Include any additional structures located on the grounds.

Figure D-9. Sample structures survey format (continued).

- e. Terrain and Vegetation. Provide a very simple description (for example, height and type of trees).
- f. Additional Information. Include possible routes of access and masking effect of vegetation.

4. Building description.

- a. Exterior. Give a general description to include basic style of construction. Make reference to aerial photographs, if available.
- b. Entrances to Building. Give a detailed description including names of entrances, if applicable.
 - (1) Main entrances. Working from outside to inside, describe the entrance and any entrance procedures, if applicable. Describe hinges from the top down.
 - (2) Other entrances. Describe the same as above.
 - (3) Emergency entrances and exits. Describe the same as above.
 - (4) Additional information. Include grates, air conditioning ducts, fans, and trap doors.
- c. Interior Description of Building.
 - (1) General description.
 - (2) Floor plans. Refer to attached floor plans and floor plan sketches.
 - (3) Floors. Include type of construction of the floors from the basement up.
 - (4) Corridors. State width, height, type of lighting, type of floor covering, depths of doorways, and general information.
 - (5) Stairways. Describe by name if possible, and describe the locations of landings and banisters. Give the number of stairs.
 - (6) Elevators. Include mechanism, escape hatch, and other contents of the elevator (off the data plate) including any limitations of the elevator (for example, that it does not service the top floor).
 - (7) Doors and locks. Refer to a specific industry or professional standard door/lock/key chart available to all participating organizations.
 - (8) Windows and locks. Describe standard type(s) for the specific structure and any exceptions.
 - (9) Physical barriers. Describe any barrier system that will be used during an emergency.
 - (10) Hardened areas. Describe in detail.

Figure D-9. Sample structures survey format (continued).

- (11) Weak points. Describe in detail.
- (12) Additional information. Describe in detail.
- d. Roof.
 - (1) General description. List antennas, elevator rooms, and type of construction.
 - (2) Entrances and exits. Describe in detail, with emphasis on areas of weak construction.
 - (3) Fire escapes and ladders. Describe in detail.
- 4. Common systems.
 - a. Security.
 - (1) Personnel.
 - (a) Marine security guards. Give the numbers and types of weapons carried.
 - (b) Security detail and/or bodyguard. Describe the same as above.
 - (c) Contract watchmen. Give the numbers, types of weapons, and times of shift changes.
 - (d) National policemen. Give the numbers and affiliation with the facility.
 - (2) Total security equipment. Include a total inventory of all security equipment.
 - (3) Sensors and alarms.
 - (a) Location outside.
 - (b) Location inside.
 - b. Communications.
 - c. Organic Transportation.
 - d. Medical Equipment.
 - e. Power.
 - (1) Explain primary, normal system (for example, source and shutoff data).
 - (2) Explain backup and emergency system(s) (for example, source, shutoff data, and duration capability).
 - (3) Provide additional information.
 - f. Air Conditioning and Ventilation. Explain the air conditioning system, with special emphasis on vents and air intakes.
 - g. Sewage and Drainage. Explain the sewage system that services the structure with a special emphasis on access to the structure, if any.
 - h. Additional Information.

Figure D-9. Sample structures survey format (continued).

5. Personnel structure.

a. Staffing Pattern.

b. Key Personality Data.

c. Additional Information.

- (1) Draw north arrows on the photographs and annotate items of importance on them. Do not annotate on a photograph an item indicated on the legend and/or label, unless necessary.
- (2) Assemble finished product in the following order:
 - (a) Table of contents.
 - (b) Narrative description.
 - (c) Surrounding area sketch.
 - (d) Photograph and/or slide index.
 - (e) Photographs with labels, north arrows and annotations.
 - (f) Slides.
- (3) Have another person check for accuracy.

NOTE: Attached as an enclosure should be the door/lock/key reference information. The standard format for the door system should be very simple and not require a great deal of time either to collect information against or to produce a survey from. The preparer should specifically—

1. List all doors.
2. Note whether they are standard or not, giving a definition of what a "standard door" for that particular structure is.
3. Describe any door that is not standard.

Figure D-9. Sample structures survey format (continued).

BEACH SURVEY FORMAT

1. General information. Include the following:
 - a. The date(s) the survey was conducted.
 - b. The date the report was prepared.
 - c. The code identity of the unit conducting the survey.
 - d. The code identity and location of the beach surveyed. Also include the following:
 - (1) Reference maps or charts used.
 - (2) Code designation or name of the beach.
 - (3) Coordinates of the beach flanks.
 - (4) Landmarks used for identification and their position relative to the center of the beach (as seen from seaward).
 - e. The datum plane used to determine the shoreline.
 - f. A brief description of the conditions under which the survey was conducted to include weather, visibility, and threat interference.
 - g. A list of items appended to the report.
2. Beach description. Provide detailed description of the beach, including:
 - a. Beach length and configuration.
 - b. Usable beach length.
 - c. Beach interruptions and obstacles.
 - d. Subsurface hazards (for example, rocks, shipwrecks, dragon's teeth, and mines).
 - e. Type of coastline.
 - f. Foreshore description.
 - (1) Width.
 - (2) Gradient.
 - (3) Composition.
 - g. Backshore description.
 - (1) Width.
 - (2) Gradient.
 - (3) Composition.
 - (4) Vegetation.
 - (5) Exits.
 - (6) Trafficability.

Figure D-10. Sample beach survey format.

3. Threat activity. Describe observed threat or nonbelligerent third party situation. Include a precise description of all man-made objects on the beach, whether or not obviously erected for beach defense. Do not limit the focus to the beach itself, but cover all activities observed.

NOTE: Sketches, photographs, and videotapes are normally attached to the beach survey. TACBEREPs and SURFREPs may also be attached.

Figure D-10. Sample beach survey format (continued).

HYDROGRAPHIC SURVEY FORMAT

1. General information. Include the following:
 - a. The date(s) the survey was conducted.
 - b. The date the report was prepared.
 - c. The code identity and mission of the unit conducting the survey.
 - d. The code identity and location of the area surveyed. Also include the following:
 - (1) Reference maps or charts used.
 - (2) Code designation or name of the beach.
 - (3) Coordinates of the beach flanks.
 - (4) Landmarks used for identification and their position relative to the center of the beach.
 - e. The datum plane used to determine the shoreline.
 - f. A brief description of the conditions under which the survey was conducted to include weather, visibility, and threat interference.
 - g. A list of items appended to the report.
2. Hydrographic description.
 - a. Provide a detailed hydrographic description of the area, including-
 - (1) Beach length and configuration.
 - (2) Usable beach length.
 - (3) Beach interruptions and obstacles.
 - (4) Type of backshore.
 - (5) Surf characteristics.

Figure D-11. Sample hydrographic survey format.

- (6) Inshore currents.
 - (7) Tidal ranges and times.
 - (8) Nearshore description.
 - (a) Distance from the shoreline to the 1-, 2-, and 3-fathom curves.
 - (b) Gradient.
 - (c) Bottom composition.
 - (d) Reefs, bars, shoals, or seaweed.
 - (e) Other obstacles.
 - (9) Foreshore description.
 - (a) Width.
 - (b) Gradient.
 - (c) Composition.
 - (d) Runnels (rivulets), cusps (points), or scarps (steep slopes or cliffs).
 - (e) Other obstacles.
3. Threat activity. Describe observed threat or nonbelligerent third party situation. Include a precise description of all man-made objects in the area surveyed, whether or not obviously erected for defense. Do not limit the focus to the beach itself, but cover all activities observed.
4. Hydrographic sketch (attached). Provide a graphic presentation of the nearshore and foreshore areas. (It is a 1:1,000 or 1:2,500 scale drawing that shows the shoreline; the 1-, 2-, and 3-fathom curves; the foreshore; obstacles; cultural features; beach flanks; and beach interruptions as seen from above). Depict the nearshore and foreshore gradients by showing three cross sections taken at the beach center and in the middle of the left and right sections of the beach. (The vertical scale of the cross sections is usually larger than the horizontal scale of the cross sections). All soundings by the survey party are shown on the sketch.
- NOTE: A beach survey, TACBEREP, SURFREP and/or DELTREP can be attached to this report. See Chapter 4.**

Figure D-11. Sample hydrographic survey format (continued).

DEBRIEFING FORMAT

NOTE: This format follows the postmission report (Annex L of SODARs) and is used as a guide for debriefing SFODs. Refer to the SODARs procedural handbook for format instructions. SODARs is available through USSOCOM's SOCRATES that is available to units within the USSOCOM.

(CLASSIFICATION)

1. () Mission data:
 - a. Mission number:
 - b. Specific type mission:
 - c. Unit:
 - d. Exercise/operation name:
2. () Countries:
3. () Unified command/higher headquarters:
4. () Summary statement of mission:
5. () Date of deployment:
6. () Date of return:
7. () Maps used: (series, sheet, edition, classification, scale)
8. () Task:
9. () Size and composition of SFOD for mission:
10. () Mission members: (Name, position, and duty)
11. () Time of departure:
12. () Time of return:
13. () Ingress/egress:
14. () Terrain:
15. () Enemy:
16. () Map corrections:
17. () Results of enemy encounters:
18. () Actions at the target:
19. () Communications:

Figure D-12. Sample debriefing format.

- 20. () Weapons:
- 21. () Demolitions:
- 22. () Medical information:
- 23. () Lessons learned:
- 24. () Were U.S. human rights policies adhered to?
- 25. () Miscellaneous information:
- 26. () Authentication data:
 - a. Reviewed by mission support unit (MSU)____ Forwarded to mission support center (MSC)____
 - b. Reviewed by MSC____ Forwarded to component (DTG)____
 - c. Reviewed by component____ (DTG)____
- 27. () Report incorporated into annex____
 - a. () DTG:
 - b. () POC:

(CLASSIFICATION)

Figure D-12. Sample debriefing format (continued).



OPERATIONAL TECHNIQUES

All means of movement must be considered during the planning stage of an SR mission then redefined during mission rehearsals. A key to a successful SR operation is the ability to conduct an undetected movement into and out of the target area. Successful SR operations depend on the teamwork of confident, well-trained SFODs. The SFOD leader is responsible for getting the SFOD to and from the objective safely. If the threat force is alerted that an SFOD has arrived into an area, it will make every effort to track the SFOD down.

INFILTRATION AND EXFILTRATION

Infiltration and exfiltration planning is critical in SR operations. Exfiltration should be given the same planning emphasis as infiltration. Methods of movement depend on what the mission requires, terrain analysis, and what support materials are on hand. The following paragraphs discuss the basic considerations for air, water, and land infiltration and exfiltration. Although each method is discussed separately, some SR missions may require a combination of means.

Airborne Operations

Airborne operations fill the modern battle requirements of rapid deployment of personnel and equipment. Static-line and free-fall parachuting operations have different advantages and disadvantages and give commanders a wide range of options.

Static-Line Operations. Low-level, static-line operations provide the SFOD A with access to most operational areas without intermediate staging bases (ISB). Primary considerations for infiltration by static-line (SL) operations are the air defenses along the flight route and weather and terrain factors. The main advantage of SL operations is that extensive training is not required for an SFOD A to execute this means of infiltration. A negative factor associated with SL operations is the signature of the infiltration platform. The infiltration is enhanced by the tight physical grouping on the DZ in normal situations. The ability to group in the air and on the ground depends on the level of experience and the amount of training the SFOD was afforded before the hostilities. Rapid grouping enhances internal security and accountability of both equipment and personnel. To conceal the destination of the SFOD, include multiple direction changes and false insertions in the flight route. However, even with the best information on threat force locations, multiple false insertions, and a detailed analysis of the terrain and weather,

a cargo aircraft draws attention to the SFOD. For reasons of security, remote DZs are required. Maps are a good place to start the process of DZ selection, but review the most current information such as high-level photographs and recent after-action reports from the area. The final planning step must address the air items. SOPs must address caching or submersion of the parachutes. Problems can be avoided by planning the DZ in an area with expected soft soil. Valleys, swamps, and wooded areas afford the the best opportunity to conceal the parachutes. Ridge lines, mountains, and slopes leading to rivers are some of the least desired areas. Rocks prevent digging an acceptable storage hole and alert the threat force by the sounds of the entrenching tools.

Military Free Fall (MFF) Operations. HALO and high altitude high opening (HAHO) operations can provide one of the most concealed means of infiltration when properly used. Because MFF is a perishable skill, train before hostilities to ensure the desired results can be met on the battlefield. Insertion of a small team in a specific area can be performed using standoff operations with the aircraft flying in a known civilian flight route or above normal ADA and small arms ranges. HAHO and HALO operations can afford the planners of an SR mission the ability to insert the team quietly with little or no light or radar signatures. These operations do, however, have a few disadvantages such as weather requirements, special aircrews, supplemental oxygen requirements, and the low amount of accompanying equipment that can exit with the MFF jumpers.

Airmobile Operations. Rappelling, fast rope, helocast, or air-land operations using helicopter support are viable infiltration procedures for an SR mission. The main disadvantages are the limited range of the aircraft, noise of the aircraft, and the signatures left after landing. Grasses are matted and surface sands are discolored. Exact ranges for the available aircraft are obtained from the aircrews during the initial stages of mission planning. Often limiting factors change with the level of the experience of the crews, usable hours of darkness, and modifications to the helicopter itself.

Staff Functions. The battalion S3 air operations section is the primary point of contact for all levels of planning an airborne or airmobile operation. This section must coordinate mission requirements such as Air Force oxygen technicians, organic rigger support, and crew briefing times.

Land Infiltration

Movement by vehicle, foot, or pack animal is limited only by the specific mission requirements and the assets available. For further information on land infiltration, refer to TC 31-29.

Water Infiltration

Over five-eighths of the surface of the earth is covered by water. With the ever increasing radar coverage and limited air assets, waterborne operations become an even more viable means of getting into the target area. Organic waterborne support available is at the battalion level. This support ranges from Zodiac rubber boats, to sea kayaks, to swim fins. It aids flexibility, surprise, and speed of both infiltration and exfiltration. Waterways can increase SFOD load-carrying capacity. The value of small boat operations can be measured by their use historically. During World War II, small boats and kayaks were used with wide-ranging successes in all

theaters by most of the services and nations involved. Today, virtually all major armed forces employ small boat operations. The main disadvantage for small boat operations is what to do with the boat after successful infiltration.

Common Organic Equipment

SF organizations have special equipment to support their operations. Some of the major items of common organic equipment are described below.

F-470 Zodiac Inflatable Boat (Figure C-1). Some of the primary advantages of this boat are that—

- It can be launched from submarines and mothercrafts. It can also be air dropped from various fixed- and rotary-wing aircraft.
- When using the outboard motor, the Zodiac is fast and quiet. Each fuel bladder allows the boat about one hour of operation with an average load of six men with equipment.
- The low profile and fabric used in the construction provide little or no radar signature to threat force shore facilities.

Klepper Arius 2 Military Canoe (Figure C-2, page C-4). This canoe, commonly called a sea kayak, has many of the same advantages as the Zodiac, with two major exceptions—air drop and motor operations. However, some of the features of this craft are speed and stealth. Using the paddles, a crew of two can travel extended distances in a short amount of time. This watercraft gives the lowest signature of all the commonly used boats available to SOF units. Crew members sit just below sea level with only their upper torsos elevated above the sleek boat.

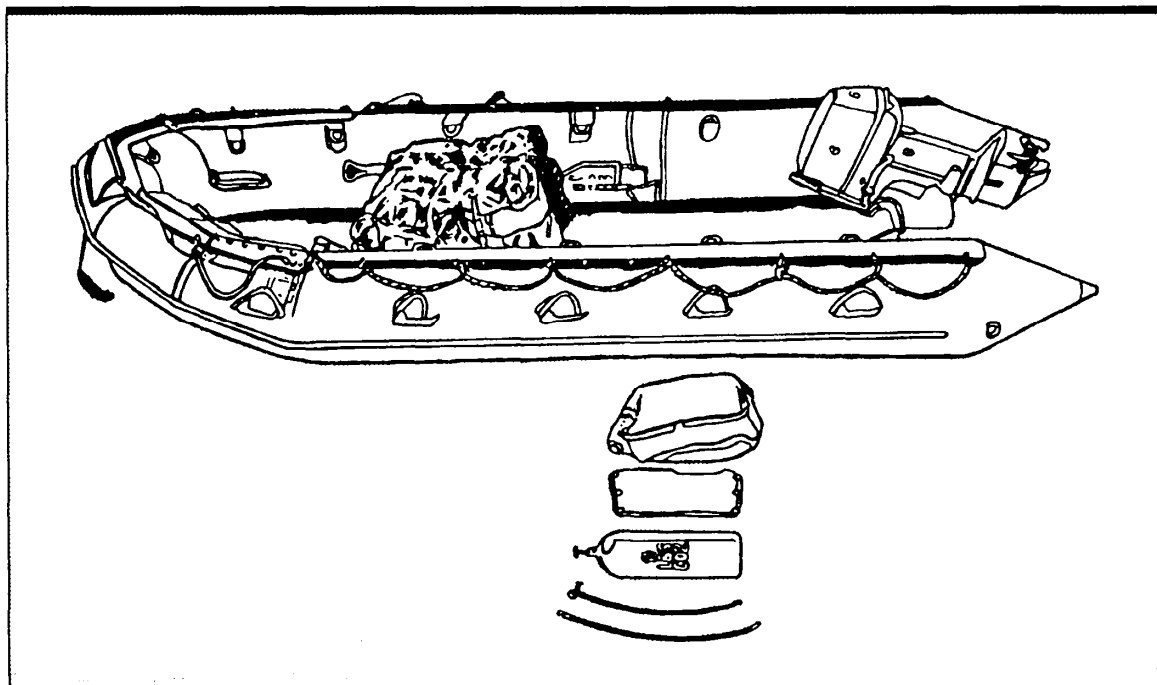

Figure C-1. F-470 Zodiac inflatable boat.

Scuba and Scout Swimming Gear. Fins, masks, wet suits, and scuba tanks are maintained in scuba lockers at group or battalion levels. Water infiltration is an extremely secretive way of entering an area. To expand capabilities and experience levels using the water infiltration techniques of scout swimming and scuba diving, prehostility training is a must.

Staff Functions. Both the battalion and group staffs must address certain items during daily operations:

- Training should address qualification and training on the organic equipment available.
- Future equipment needs are based on normal wear and tear of equipment *and* advancements in tactics and technologies.
- The S2s must compile nautical charts and hydrographic surveys for projected areas of interest. The charts and surveys must be continually updated.

Exfiltration Techniques

There are two methods of exfiltration available when conducting an SR mission normal and emergency.

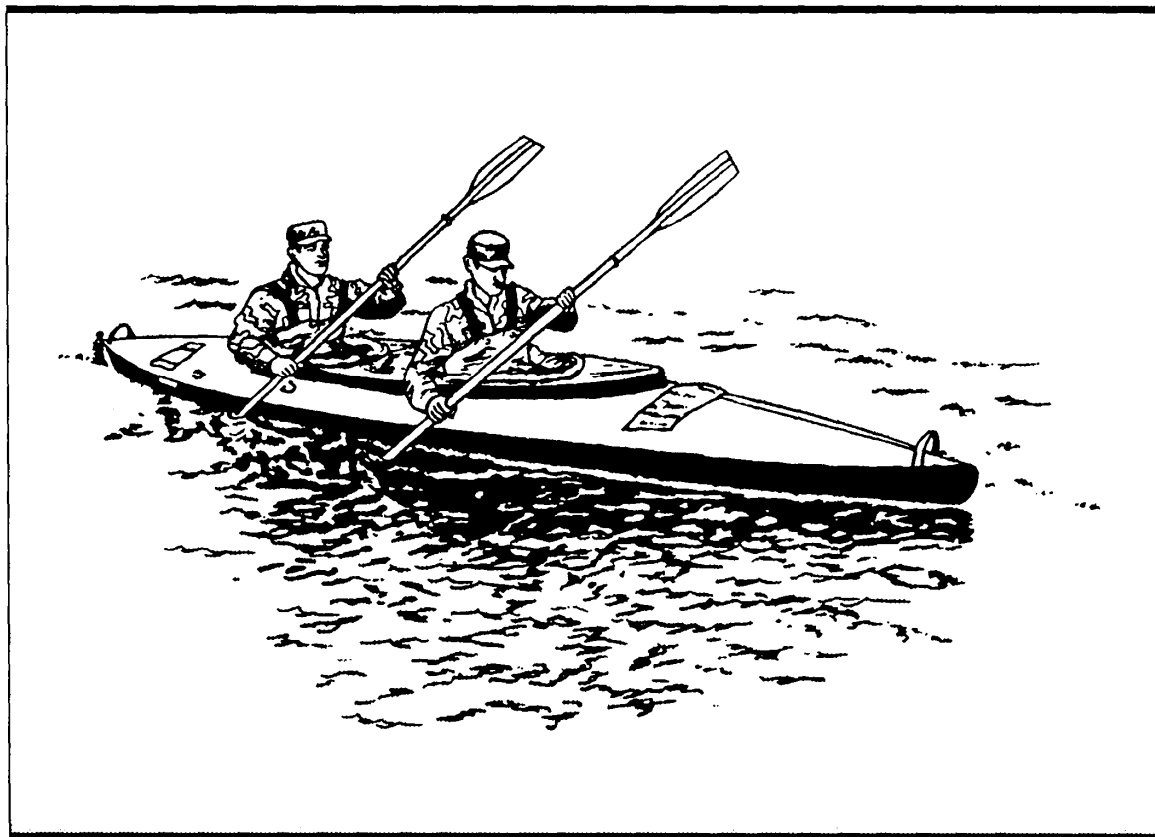

Figure C-2. Klepper Arius 2 military canoe.

Normal Exfiltration. After the successful completion of the SR mission, activate the planned exfiltration plan. Little is gained if the detailed information gathered can't get out of the operational area. Likewise, if you are compromised by the threat force or it discovers abandoned observation sites overlooking a complex, it will change the target's structure. Then when the friendly attacking force arrives, it will find an alert that force ready to do battle. This type of situation works in favor of the threat force and must be avoided at all cost. The following paragraphs outline the rules that must be followed when writing a normal exfiltration plan.

Ensure pick up points are far enough away from the target to mask the sounds and lights of the exfiltration vehicle. Use mountains, dense foliage, and other like terrain features to your advantage. Under normal conditions, in open, flat terrain, on a calm night, rotary-wing aircraft lose most of their audible signature at about 5 kilometers.

While exfiltrating, use obstacles to your advantage. Move so that ridge lines, rivers, and other like areas are between the target or reactionary forces and the planned pickup points. Avoid areas with roads or trails.

Plan for extra movement time in the exfiltration order. If forced to break contact with a threat force, or the maps used for movement planning were wrong, pickup time could be missed and jeopardize the SFOD and the mission. Plan to move off target the night before exfiltration. Such movement gives the extra time to pass around unforeseen danger areas. It also ensures you are in fact at the correct place for pickup on time.

Primary and alternate pickup points are never on a single azimuth away from the target. If arriving at the first pickup point, but exfiltration is not effected, ensure the alternate pickup point is in a different direction to avoid trackers and possible threat force contact.

Take care to avoid detection during the mission and after exfiltration. Take out everything brought into the area. Bum trash such as meals, ready-to-eat (MREs) wrappers using a heat tab, which produces very little light or smoke with only the tin foil remaining. The tin foil, when compressed, can form a small ball, reducing the overall bulk greatly. Replace, compact, and camouflage soil from all digging. Before departing the positions, make a final check of the area. Check for even the smallest details.

Emergency Exfiltration. If detected or engaged by a threat force unit, exfiltrate by preplanned emergency means. This exfiltration requires either activation of the E&E plan or the deployment of a QRF. Special coordination with the QRF is required before SFOD infiltration. OPLANs for the use of QRF assets must stress C². Know what signals are going to be used as the QRF exits the helicopters ready to engage in a fire fight. Linkup procedures require extensive planning and practice to avoid friendly units engaging one another.

Exfiltration of Information. When time-critical information needs to be passed to the rear, you can pass to the rear in several ways.

Radio transmissions. You can send short messages to the supporting base station by many means. Burst transmissions are the best method for countering threat force direction finding, jamming, or monitoring efforts. Masking the radio sites behind hills or mountains prevents some of the same problems.

Message pickup (MPU) operations. With the MPU apparatus (Figure C-3) and fixed- or rotary-wing aircraft, support information can be sent to the rear. Some examples of the type of information that may need to be sent back by MPUs are exposed rolls of film, blueprints and technical drawings, or fingerprint cards. For a successful MPU operation, security of the information is a must. If it is important enough for the SFOD to mount an MPU operation and request an aircraft, it must be well guarded. The size and weight of the message container is important. TC 31-24 states that the weight of the container must not exceed 2.2 kilograms. Ensure the container is not so light that during extraction it becomes entangled with the rear of the aircraft. Figure C-4 shows a 2.2 kilogram weight attached to the pickup line as described in TC 31-24. Common sense dictates the need for this device. If a weighted boat anchor is used, the extra weight can be omitted. The container may be a section of plastic pipe or an empty smoke grenade shipping container. Prepare the container during normal training with the required line attached. For more information on MPU operations, see TC 31-24.

RECORDS, LOGS, AND NOTES

While surveilling, maintain an accurate log that captures all relevant information (Figure C-5, page C-8). Watch the target as you talk into a tape recorder (if the threat permits use of such equipment) or to a fellow observer who keeps notes.

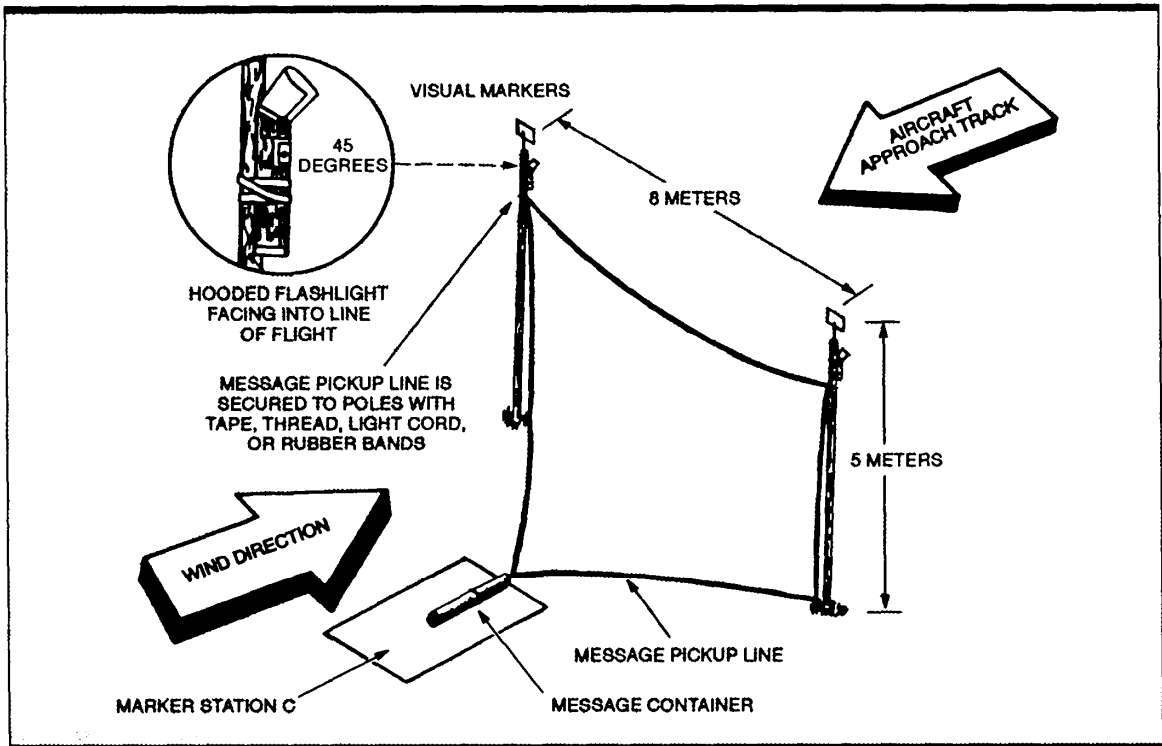

Figure C-3. Message pickup apparatus.

The observation log is a record of what was seen and is not an analysis. Fill out the log using the key word "SALUTE" for threat force activity and "OCOKA" for terrain. When using these key words to make log entries, do not waste time on generalities but be very specific (for example, exact number of troops, exact location, exact disposition). The log is always used in conjunction with a field sketch, and the field sketch supports data entered into the log. Also keep supplemental notes. The log is an important source of operational information and, at a minimum, should include—

- Call sign of the observer or SFOD.
- Observer or site code location.
- Visibility/night.
- Time of observation (DTG group in local time).
- Grid coordinates or reference of observation.
- Event or activity observed.
- Action taken.

SKETCHING, MAPPING, AND PHOTOGRAPHY

The goal of SR is to produce useful information. Sketches, maps, and photography techniques aid in the storage, production, and transmission of this information.

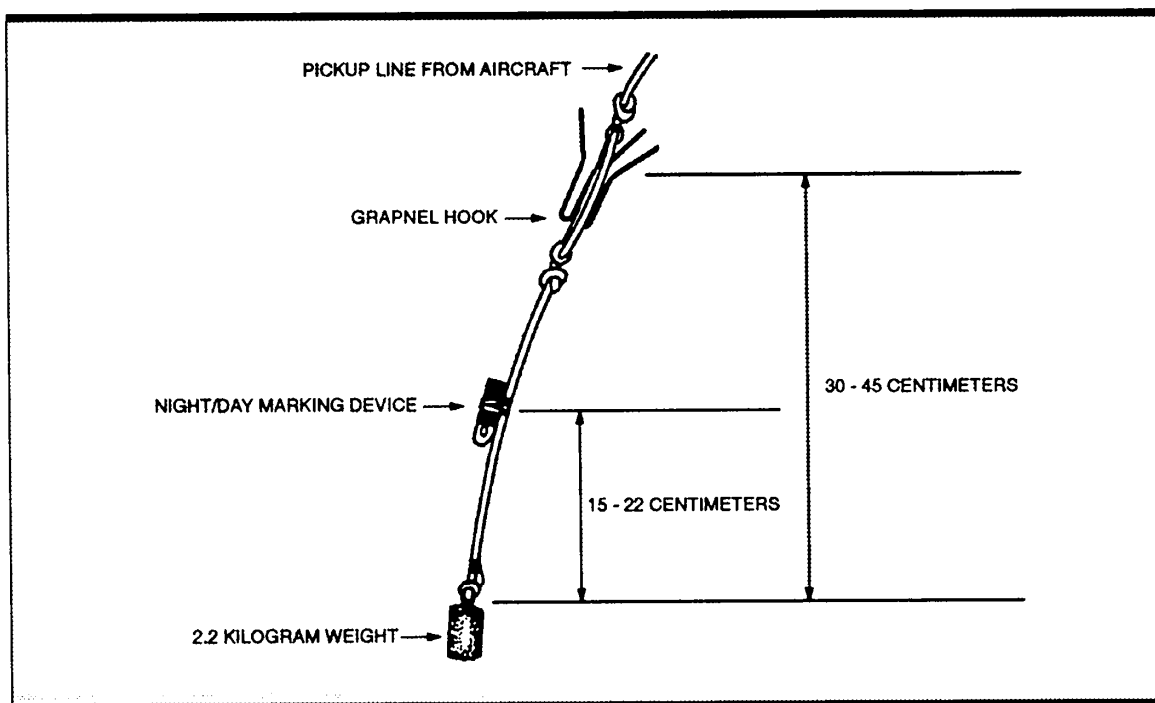

Figure C-4. Aircraft pickup line assembly.

**Month: NOV 90
DTG**

**LOCATION: JERICHO 3
OBSERVERS: TM RED/TM BLUE**

ENTRY	FROM	TO	WHAT NOTED AND WHERE	ACTION TAKEN/VISIBILITY
1	260001		OP activated by Team Blue.	Logged/Low overcast 500m
2	260430	260550	RP 3, right 50 M, 3 men burying sacks.	Observed, photo'd/Clear 5 mi
3	260930		RP 2 to RP 7, 1 semitrailer passed on Rte 101.	Logged/Clear 10 mi
4	261340	261345	RP 4, 200 m right, military UH-1 flying low level.	Logged/Clear 5 mi
5	261713		RP 7 to RP 2, two cars passed on Rte 101, appeared at RP 3, 10-20 m right.	Observed, photo'd/Lt drizzle
6	261800		Shift change. OP relieved by Team Red.	Logged/Rain 2 mi
7	270530	270640	RP 1, 10 m right, lone man on bicycle placing soft drink can on side of road.	Observed, photo'd/Fog 300 m
8	270600		Shift change. OP relieved by Team Blue.	Logged/Fog 400 m
9	271045	271120	RP 5, 50 m left, two men moving SW toward road.	Observed, logged/Fog 1 mi
10	271315		RP 1, 150 m NNE, two men sitting in bush, facing road.	Photo'd, logged/Clear 10 mi
11	271430		RP 2, 25 m left, pickup truck pulled off road on south side.	Infrmd tm ldr, logged/clear
12	271445	271520	RP 2, right 25 m, lone occupant of truck walking SE along S side of road.	Photo'd, logged/Cr 15 mi
13	271520	271530	RP 1, 10 m right, truck occupant picking up soft drink can, returning on foot to truck.	Photographed, logged, infrmd Tm ldr/low overcast
14	271530	271540	RP 2, 25 m left, truck U-turns, departs NW Rte 101	Logged/Mist 1 mi

Figure C-5. Sample observation log.

Sketching

Always use a sketch as a backup. Prepare panoramic and topographic sketches of the targets. These sketches are excellent supplemental or backup material for written logs. Accuracy, detail, and scale are vitally important. Graph paper, blueprints, fire plans, photographs, and other aids may be used in the preparation of the sketch. Ensure all sketches are in proportion, use correct terminology (for example, types of windows), use standard terminology and symbols, and have a north arrow.

Panoramic Sketching. A panoramic sketch depicts terrain in elevation and perspective as seen from the point of observation. It can also be a sketch of a specific building, item of equipment, or other object of interest. One method of panoramic sketching is to establish a scale on the paper on which the sketch is to be drawn, draw the horizon of the terrain or outline of the object, and then fill in the details. When drawing terrain, focus on observation and fields of fire, cover and concealment, obstacles, key terrain, and avenues of approach (OCOKA). When making the sketch, carefully depict fields of observation and fire from the target outward as well as from suitable points facing in toward the target. When drawing an object, such as a building or item of equipment, focus on such factors as windows, doors, intakes, obstacles, barriers. When sketching personnel, focus on the size, activity, location, unit, time, and equipment (SALUTE) factors. When adding details to a sketch, use a system to ensure thoroughness. For example, when sketching individuals, draw the outline of the individual and then fill in details from top to bottom, left to right.

Topographic Sketching (Mapping). A topographic sketch is an overhead representation similar to a map. It can be of a geographic area or it can be a floor plan of a building. One method of topographic sketching is to establish a scale on the paper on which the sketch is to be drawn, draw a grid and magnetic north arrow, establish grid lines, draw the outline of the building and/or other objects of interest in the sector, and then fill in the details. Accuracy, detail, and scale are vitally important. When drawing terrain, focus on the OCOKA factors. When drawing a building or facility (for example, a weapons emplacement or base) focus on such factors as doors, windows, composition and thickness of walls, layout of obstacles and barriers. Where human activity is represented in the text, the focus is on the SALUTE factors. When adding details to a sketch, use a system to ensure thoroughness, for example, top to bottom and left to right.

Photography

A well-taken picture is truly worth a thousand words. In the conduct of SR, SF photography is often an invaluable skill.

IMINT Collection. IMINT collection is an extremely important task for an SFOD A in its operational area. The SFOD can collect, confirm, or reinforce technical information through on-the-ground photographic surveillance, which cannot be done by more technical means. Consider the IMINT principles discussed in the following paragraphs.

Practice makes perfect. Consistently practice photographic techniques. Rehearse these techniques under the light and weather conditions that are expected in the operational area. Lack of adequate practice could result in overexpose, underexposure, or wasted shots, which may cause mission failure.

An unloaded camera shoots blanks. Always keep the camera loaded and readily accessible. Before departure, check the camera to ensure it is loaded with the proper film. Immediately after exposing a roll of film, reload the camera.

Film is cheap. Carry several rolls of film of various capabilities. When lighting conditions are questionable, bracket exposures. It is better to have too many photographs of the target than to be missing the one critical photograph. When in doubt, shoot the picture.

NOTE: *Never photograph SFOD members on a mission. If threat forces capture film with images of the SFOD on it, they can determine the SFOD's strength and capabilities.*

When taking photographs of more than one target on a mission, do not carry the film of the previous target(s) to the next target. Cache previously exposed film. Pick up the exposed film when it leaves the AO. The capture of multiple rolls of film with pictures of several targets could seriously compromise U.S. intentions in the area.

Always photograph an object of identifiable size (such as a cartridge or a military pen) with the subject to help identify its dimensions. If operating in an urban environment or other area where military items should not be carried, an indigenous coin or a 15-centimeter plastic or wood ruler may suffice to show size.

Types of Photography. There are five types of special purpose photography applicable to SR missions.

Identification photography deals with photographing personnel or groups of personnel to identify and record the identity of the subject(s). The subject may or may not be aware that he is being photographed. Examples of identification photography include—

- Photographing indigenous personnel for pay and/or service records.
- Photographing threat personnel, dead or alive, to obtain OB information.
- Clandestinely photographing drug traffickers in support of HN counterdrug (CD) operations.

Documentation photography is used to record printed material or other photographs. Examples of documentation photography include—

- Photographing base camp records to be cached.
- Photographing captured or acquired maps and overlays.
- Photographing documents that would compromise a sensitive operation if they were removed.

Technical photography is the photographing of equipment or mechanical or electrical items so that the photograph may be analyzed in lieu of the actual item. Include a measurement scale in technical photographs. A 15-centimeter ruler is an excellent scale for most small items such as individual weapons and radios. Expedient scales such as currency, a like item of U.S. manufacture, or a known round of ammunition may be used. Examples of technical photography include—

- Photographing an item of equipment that is too large for exfiltration.
- Making a photographic inventory record.
- Photographing a piece of equipment that would compromise a sensitive operation if removed.

Surveillance photography is an advanced technique used for obtaining information about an individual or an installation under a full range of threat, weather,

and terrain conditions. See AR 381-10 and FMs 34-60A and 31-26(U) for detailed information about personnel surveillance. Surveillance photography implies that the target is unaware it is being photographed. Surveillance photography may require the use of spotting scopes, telephoto lenses, and binoculars. Take photographs of stationary subjects at night through a combination of American Standards Association (ASA) compensation and "push processing."

Photography that is purely of the identification, documentation, technical, or surveillance type is seldom used. Most SR photography combines some principles from all of them. For example, photography of an industrial site for technical evaluation may require the following types of photography:

- **Surveillance** —to provide an overview of the target area, its perimeter, avenues of approach, access, egress, fields of fire as seen from particular vantage points.
- **Identification** —to identify key individuals.
- **Documentation** —to obtain copies of access documents, duty rosters, wiring diagrams, and flow charts.
- **Technical** —to picture circuit boards, pipe fittings, switch panels, or gears.

Equipment. Collect IMINT with the KS-99 series camera system, the electronic filmless camera system, and various off-the-shelf still and motion photographic systems.

The KS-99 series camera system is based on a single-lens reflex (SLR) 35-mm self-contained, portable, hand-operated camera. The camera can be used to photograph most still and moving subjects under various lighting conditions. It is used mainly for black and white or color photography under conditions where small, readily portable equipment is desired and small picture format may be used. The KS-99 series cameras may vary in body type. Refer to the manufacturer's handbook for specific information and STP31-18F4-SM-TG for further information and functions of the KS-99.

A wide variety of off-the-shelf, small, lightweight, battery-operated, hand-held videocamera systems can be used. These systems include a camera, recorder, and lighting equipment. Some of these cameras are comparable in size and weight to an SLR camera body with a lens. All offer the advantage of being able to take motion pictures with sound. Most modern systems also can record the date-time group (DTG) on the film as the pictures are being taken, which aids in the accurate timing of events or activities being recorded. Disadvantages of these systems are that they do not perform well in below-freezing environments and their acuity is not as great as with a 35-mm camera system under most circumstances. They also generally do not perform as well in low light conditions without the use of NVD type lenses. More advanced technology can also be used. The electronic filmless camera system (EFCS) records still images and motion pictures electronically instead of using the standard photographic process. The EFCS stores information and converts it to a digital data stream for transmission via secure or nonsecure radio and/or satellite on command. The primary advantage of the EFCS over 35-mm and videotape photography is its NRT image transmission capability. The most important limiting factor of the EFCS is light conditions. Other limitations include transmission times, size of the equipment, weather, and other factors that would limit normal 35-mm photography.

Photographic Techniques. Techniques for taking a useful photograph depend on many considerations. Photography can be planned as an operation using METT-T.

Sequence. When taking a series of photographs of a complex item or area, use a logical sequence. Normally, Americans view subjects from left to right and from top to bottom. Also, when photographing an installation, it is good to go from the broad to the narrow, or from outside to inside, along the same or a similar path that would be viewed by other forces. When multiple, closely sequenced moving or still photographs are taken along such a path, as in moving along streets and inside buildings, the effect of “surrogate travel” can be created. Photograph technical items from the general to the specific and from the whole to individual pieces.

Subjects. Generally, threat force activity has the most intelligence value in SR operations. Terrain and weather information can also be important. What will or will not be photographed is largely determined by PIR, IR, SIR, and METT-T.

You may find yourself photographing the following types of subjects:

- Installations.
- Equipment.
- Caches.
- Roads.
- Communications and power transmission lines.
- Personnel.
- Terrain.
- Moving subjects.

Installations include military fortifications, terrorist safe houses, and drug laboratories. Photograph installations to show location, security, dimensions, construction, accesses, and other features. Photograph the entire installation using a wide-angle lens or by using panoramic photography. Note on the photo log the direction (in degrees, 3 digits) in which the photo was taken and the location from which it was taken. Overlap panoramic frames to prevent the loss of any details. Then join these photographs to create a photomosaic. Shoot key emplacements using a telephoto lens, a spotting scope, or binoculars.

Shoot equipment, including weapons systems, vehicles, industrial machinery, and ammunition stocks to show dimensions, capabilities, identifying markings, and other features. Place small equipment on a flat surface and photograph it from above. Photograph large items as they are found. Use technical photography techniques. When possible, first photograph the subject in its original position to establish place. Next, if time permits, photograph the item whole. Then disassemble the item and photograph the components in relation to one another. Finally, photograph each piece. If the item is to be retrieved, reassemble the item.

Shoot caches to record their location and contents. Photograph the cache site as it is approached to establish place. If time permits, use technical photography to photograph the containers and their contents, paying particular attention to any markings.

Shoot roads, trails, vehicle tracks, and any paths for movement from each direction (noted on photo log) to establish place. Use technical photography to photograph details such as road surface, shoulder, footprints, or vehicle tracks.

Shoot all poles, wires, or cables found. Photograph the cleared right-of-way in both directions and the adjacent terrain to determine place. Also shoot key items such as insulators, transformers, and cable supports, using technical photography if possible. Use a telephoto lens to obtain close-ups of those components situated above the ground.

Unless a telephoto lens is used, photographs of personnel at ranges in excess of 100 meters do not show enough detail to be useful for identification purposes. In most SR situations, close-up photographs are difficult (but not impossible) to take. Take most identification photographs at intermediate ranges with a telephoto lens. When gathering information on personnel in general, concentrate on identifiable uniform or clothing items. When the subject is a specific individual or group of individuals, concentrate on facial features or any other identifiable features instead of clothing and equipment. When conducting surveillance, concentrate on behavior of those located near the target.

You may be tasked to photograph representative terrain in an AA or terrain in and around a specific target. When shooting terrain, concentrate on the OCOKA factors.

Under favorable light conditions, capture moving subjects with a fast shutter speed and stop action. Under low light, shoot moving subjects with longer shutter speeds by "panning" the camera.

Taking the photograph. After a general plan for taking the required photographs is established, it is time to push the shutter. Bear the following in mind when taking photographs:

- Camera support.
- Composition.
- Focus.
- Exposure.

Hold the camera as steady as possible. With slow shutter speeds or during telephoto photography, use a tripod or field-expedient steadying device such as a rock or a tree. To determine the slowest shutter speed for hand-held cameras, use the reciprocal of the lens focal length, for example, a 50-mm lens becomes 1/50. Since there is no 1/50 shutter speed, round up to 1/60. When taking photographs from aerial platforms, however, do not brace the camera against the aircraft frame. The speed and vibrations of the aircraft create movement of the camera in relation to the target and blur the image on the film, even with a fast shutter speed.

Center the subject in the viewfinder to assure maximum detail is obtained. If the subject does not fit the frame, switch to a wide-angle lens or use panoramic photography. The size of the image in the viewfinder is not proportionate to a 20- by 25-centimeter enlargement. The image should not be crowded horizontally when the camera is held normally or approximately 15 percent of the image will be lost when an enlargement is made.

Get a sharp image in the viewfinder before exposing the film. Focusing aids located in the viewfinder are used for proper focus. Because of possible image deterioration, do not attempt to shoot through glass or plastic windows. Under low light conditions when the target cannot be seen in the viewfinder, preset the estimated range based on the distance scale of the focusing ring.

Use the light meter in the camera to determine the correct exposure. Follow instructions for the camera and the film to ensure the film is neither overexposed nor underexposed. The exposure is either aperture or shutter priority. Most SR photography is aperture priority, emphasizing the maximum depth of field. Shutter priority is used to obtain photographs of moving targets. In night photography, the degree of illumination (moonlight, ambient man-made light) determines aperture and shutter settings. Take test photographs during isolation, under the same or similar conditions expected during the mission (for example, moon phases, risings, and settings). If more than one camera is available and/or multiple photographs will be taken, "bracket" the aperture and shutter settings to increase the probability of good, clear photographs.

Making a record. Document all photographs on a photography log. This record greatly enhances the information value of the photographs. Document photographs with a log shown in Figure C-6. Record the following information in the log as soon as the photograph is taken, or as soon as practical thereafter

- Type of camera (make and model).
- Number of the exposure.
- Target or subject designation.
- Azimuth and/or distance from the photographer to the target.
- DTG of photograph.
- F/number.
- Shutter speed.
- Lens used.
- Remarks, including pertinent information such as universal transverse mercator (UTM) grid and/or geographic coordinates, direction, and number of the target.
- Roll number of the film (for example, 1 of 2).
- Type of film (for example Tri-X Pan).
- ASA number of the film and the ASA number at which it was exposed (for example, ASA 400 ei 1600 ["ei" being the abbreviation of exposure index on the camera]).

Field development. Where possible, bring a compact field development kit to the surveillance site. Such kits for 35-mm color slide film are particularly compact and quick. The advantage of having such a kit is that you can quickly check the results of your work and, if the subject is still in sight, take more photographs as needed. Field development may also be done in the ORP and/or MSS, from where, if not compromised, you may return to the target area if the photographs taken do not meet mission requirements. Film taken in the field and field-developed photographs can also be evacuated via aerial message pickup, if the situation dictates.

SURVEILLANCE TECHNIQUES

Surveillance techniques include the systematic observation of aerospace, surface or subsurface areas, places, persons, or things. Visual, aural, electronic, photographic, or other means are used for these surveillance techniques.

PHOTOGRAPHY LOG							
EXP.	SUBJECT OF PHOTO	DIST/AZM TO TGT	Nov 92 DTG (LOCAL)	F/STOP	SHUTTER SPEED	LENS	REMARKS
1	Main Entrance	200m- 210°	191015R	16	500	200mm	210mm
2	Secondary Ent.	150m- 85°	191017R	16	250	200mm	210mm
3	W Side of Bldg.	200m- 50°	191019R	16	250	200mm	70mm
4	N. Side of Bldg.	25m- 100°	191030R	8	250	200mm	70mm - Rear Ent.
5	E Side of Bldg.	75m- 200°	191114R	16	250	200mm	70mm - Comm. Dish
6	Comma Dishes	60m- 175°	A1120R	16	250	200mm	185mm
7	N.E. Ent.	10m- 250°	191129R	8	250	200mm	70mm
8	N.E. Ent.	5m- 240°	191132R	4	250	200mm	MACRO of lock
9	W. Ent.	100m- 70°	1111 P	8	125	50mm	
23	Jason Russell	5m	201145R	5.6	60	50mm	I.D. w/Flash
24	David Cypert	5m	201150R	5.6	60	50mm	I.D. w/Flash
ROLL NUMBER: 4045		FILM TYPE: Tri-X			ASA: 400		
CAMERA: KS99		PHOTOGRAPHER: LOUIS					

Figure C-6. Sample photography log.

Routine

Operation of an observation or surveillance site can produce very important and high-quality information, but it is normally extremely boring work. Even under best conditions, for example, the concentration of the average observer looking at the same piece of ground seldom lasts more than 30 minutes. If two observers are on duty for 2 hours, they alternate as observers every 15 minutes. The man who is not observing acts as a sentry and observes the area around the site to prevent surprise attack or discovery.

Viewing Techniques

When viewing from all urban and rural buildings, avoid windows and door openings that attract the attention of threat observers and snipers. Depending on the situation and your imagination, a wide variety of viewing techniques may be used against an urban target.

Window (Any Opening) Viewing. Where a window (opening) is being used for viewing a target, lower the risk of compromise by erecting a flat black background screen just inside the windows and wearing the same flat black clothing. If the

screen is properly erected and you remain still, you will blend in with the normal shadow inside the window. This technique works better in a window with glass. Where the site is overt, as in some counterinsurgency (COIN) operations, you can cover the viewing ports with black Hessian screen that allows movement and observation without giving a sniper a clear target. To lower the vulnerability to grenade attack, cover the viewing ports with screens. Avoid grenade attacks by using the upper floors for the site.

Acoustic and Laser Monitoring. Where the target is a person or persons on the other side of a pane of glass, you may be able to hear and record conversations with off-the-shelf directional sound amplification devices and/or laser eavesdroppers. In either case, the window acts as a modulator, vibrating in sympathy with the speech in the room. With sound amplification equipment, you can retrieve audible sounds from the glass surface. With laser eavesdropping, a laser beam is reflected off the window to a receiver, which electronically converts the pulses made by the window to audible speech. Either technique may be defeated by thick curtains and recorded background chatter or music directed toward the window. These items are available to both friend and foe alike. Take countermeasures when talking or conducting meetings in a possible threat area. Simple steps, such as holding the conversations in a low voice, hinder threat force monitoring.

Fixed Site Equipment

You must have several items with you in the site: personal weapon, individual NBC protective equipment, optical instruments for observation, compass, watch, map, observation log, communications equipment, and all the food and water you will need for the duration of the mission (unless resupply is feasible). The principal documents are a diagram of reference points and the observation log. The diagram of reference points is similar to a range card, and in fact, a DA Form 5517-R can be adapted to this purpose. Figure C-7 is an example of a diagram of reference points. On the diagram, depict reference points by sketching those terrain features that correspond to the reference points in question. Other terrain features (for example, hills, woods, rivers) are shown by conventional topographic symbols, while the point of observation is shown by a tactical symbol. See FM 101-5-1. The observation log is a written record of what was observed, where it was observed, and when the observation took place. Use this log in conjunction with other observer notes, sketches, and photographs. See Page C-6 for a discussion of SFOD record-making techniques and procedures.

Organization of Surveillance Sectors

Have the SFOD leader ensure the entire sector is covered. Review reporting procedures with the observer prior to occupation of the observation site. Ensure that stable and reliable communications means exist between the observation site and the communications site, patrol base, or main body. In the observation site, conduct observation according to a given sequence.

The observer sector is divided into near, far, and middle zones, designated by arbitrary lines on the basis of terrain features, illumination, and/or reference points. The near zone includes the terrain area within which small targets can be seen with the naked eye. The middle zone is within the limits of visibility of prominent terrain features. The far zone takes in the rest of the expanse to the limits of visibility with optical instruments. When dividing an observation sector

into zones, at the same time determine the dead ground, i.e., unobservable sectors of terrain, and give them special attention since these sectors can be used by the threat force as concealed approaches.

As a rule, first inspect the terrain with the naked eye and then, using the optical instruments, inspect those areas in which threat targets may be positioned. Observation with an instrument alternates with observation with the naked eye to alleviate the potential for eye fatigue.

Look for indicators, spot threat targets and activities, and determine their locations. Record positions of targets in relation to known reference points. If possible, note the estimated coordinates of the targets. Use range-finding instruments and a compass to pinpoint target locations through modified resection.

During mission execution, you will need to be relieved. At the time of relief, inform the relieving observer of the mission assigned. Give him the observation sector on the terrain and to what he is to give special attention. Also give him the reference points, all targets discovered, the disposition of any friendly units in the area, and the location and nature of threat activity in the area. Report on the relief to the SFOD leader.

NOTE: Observation of the target must not be interrupted while the observers are changing shifts.

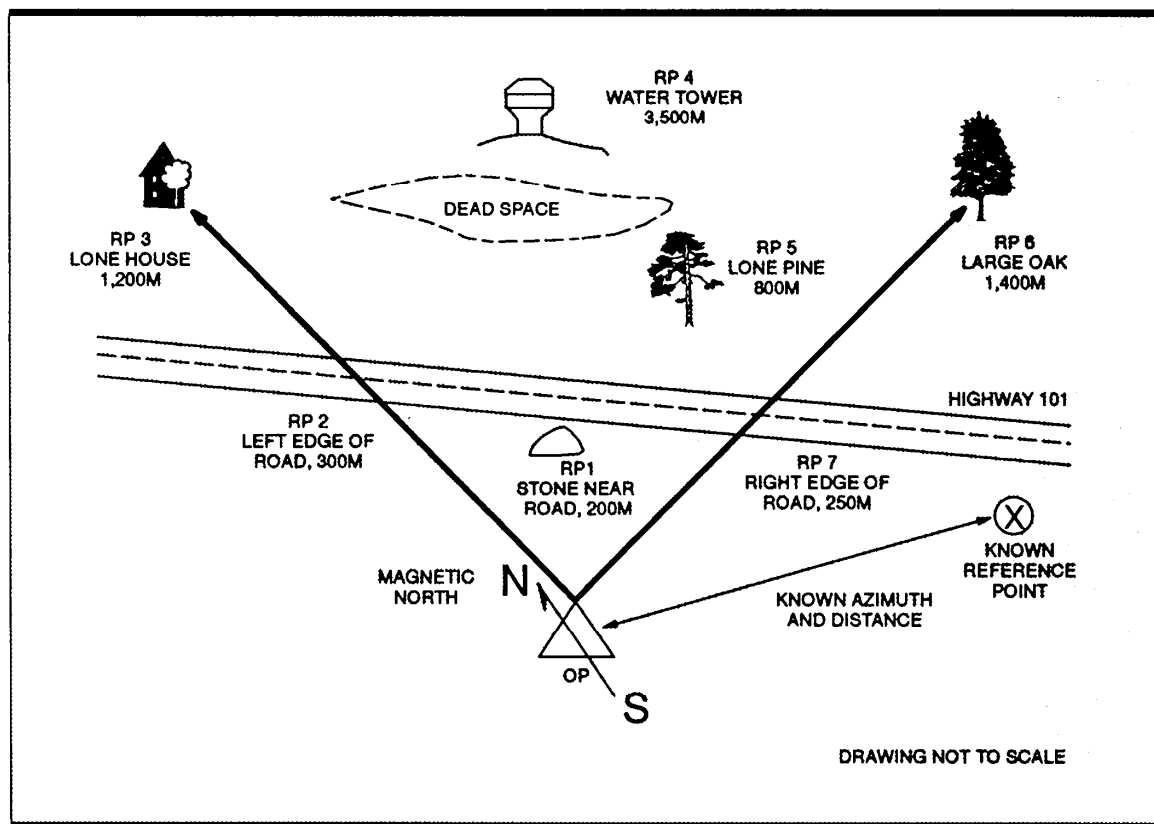

Figure C-7. Reference point diagram.

Night Observation

Darkness limits visibility, changes the outlines of objects, and distorts perceptions of distance. Dark objects seem farther away, while light ones seem closer. Therefore, orientation on the terrain and the detection and identification of objects is more difficult at night than during the day. Night observation is conducted with the naked eye and, for particular applications, night vision devices. Plan and organize night observation during the daylight period before the onset of darkness. Have the SFOD leader verify the location of observation sites and the readiness of the observers for night work.

Techniques. Military operations are often conducted during the hours of darkness. Some techniques for night observation are described below.

Dark adaptation. The exposure to light directly affects night vision. Repeated exposure to bright sunlight has an increasingly adverse effect on dark adaptation. Exposure to intense sunlight for 2 to 5 hours causes a definite decrease in visual sensitivity, which can persist for as long as 5 hours. This effect can be intensified by reflective surfaces such as sand and snow. At the same time, the rate of dark adaptation and degree of night vision capability are decreased. Since these effects are cumulative and may persist for several days, use military neutral-density sunglasses or equivalent falter lenses in bright sunlight when night operations are anticipated.

Night vision scanning. Dark adaptation or night vision is only the first step toward maximizing the ability to see at night. Night vision scanning can enable you to overcome many of the physiological vision limitations and can reduce the visual illusions that so often confuse the observers. The technique involves scanning from right to left or left to right using a slow, regular scanning movement (Figure C-8). Although both day and night searches employ scanning movements, at night avoid looking directly at a faintly visible object when trying to confirm its presence.

Use of off-center vision. Viewing an object using central vision during daylight poses no limitation, but this technique is ineffective at night. Limited night vision is due to the night blind spot that exists during periods of low illumination. To compensate for this limitation, use off-center vision. This technique requires you to view an object by looking 10 degrees above, below, or to either side of it, rather than directly at the object. This procedure allows the peripheral vision to maintain contact with an object (Figure C-9).

Countering the bleach-out effect. Even when off-center viewing is practiced, the image of an object viewed longer than 2 or 3 seconds tends to bleach out and become one solid tone. As a result, the object is no longer visible and can produce a potentially unsafe operating condition. To overcome this limitation, be aware of the phenomenon and avoid looking at an object longer than 2 or 3 seconds. By shifting your eyes from one off-center point to another, you can continue to pick up the object in your peripheral field of vision.

Shape or silhouette. The ability to visually make out shapes is significantly reduced at night; consequently, you must identify objects by their shape or silhouette. They must become familiar with the architectural design of structures, vehicles, equipment, and like objects, common to your AO to maximize information collection. Your success using this technique comes from extensive drill and practice.

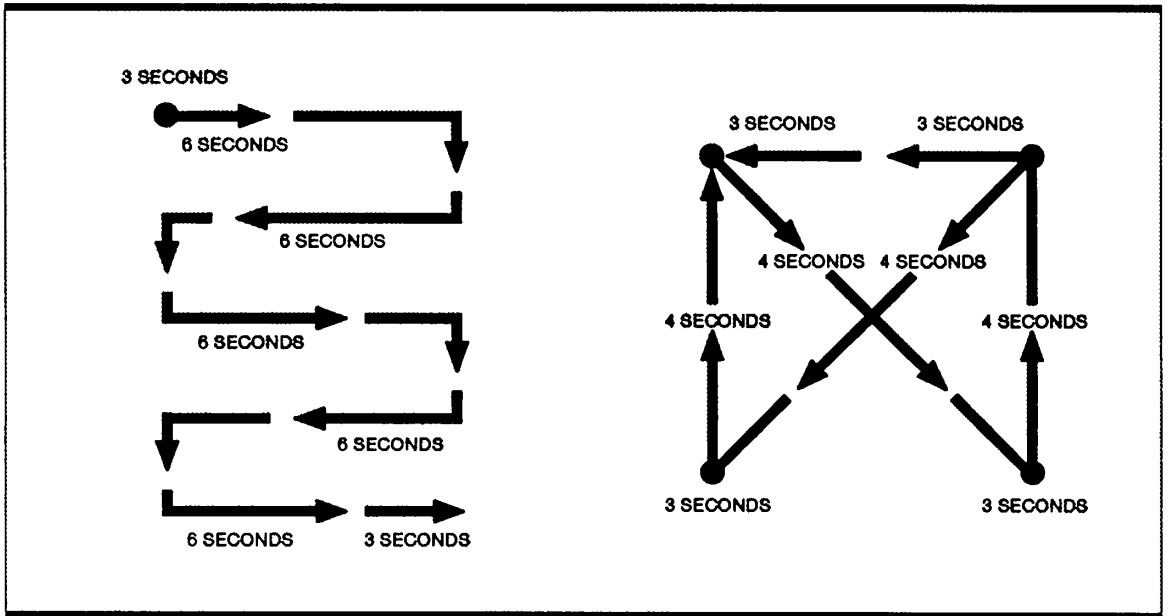

Figure C-8. Night vision scanning techniques.

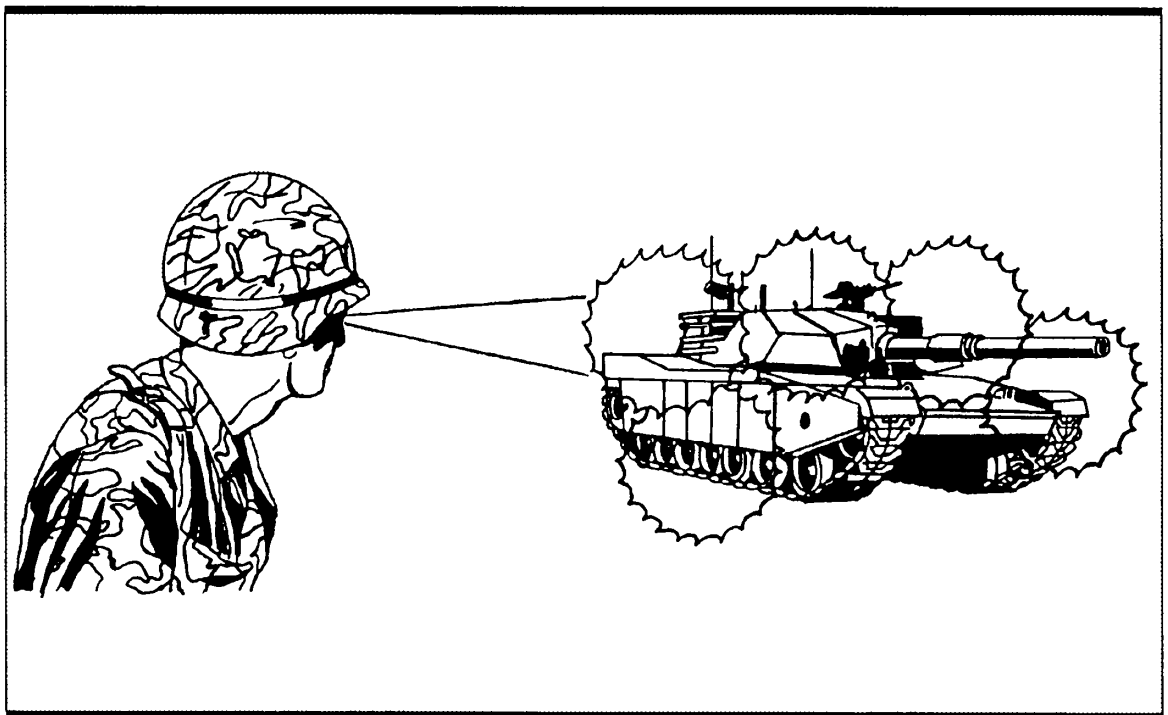

Figure C-9. Off-center vision techniques.

Light Sources and Distances. During periods of limited visibility, be cognizant of the types and ranges of different light sources. Figure C-10 lists typical light sources and the distances they are visible to the naked eye in clear, cool air.

Night Vision Devices. Because of their harmful effect on your night vision, use electronic NVDs for special applications and not for routine observation. Scan with NVDs only for a few moments using the same pattern used with the naked eye. To avoid detection, use all NVDs in the passive mode in all but the most extreme cases.

Vulnerabilities to Detection

Fixed sites are vulnerable to a wide range of compromising factors. Compromise generally results from poor site selection; faulty camouflage; poor light, noise, and smell discipline and sometimes by effective search patterns on the part of the threat force. Most compromises due to these factors occur—

- When an infiltration platform is observed.
- During movement to target area.
- When the site is being set up or occupied.
- When observers are changing shifts.
- Where the vision slit appears as a dark horizontal strip in some terrain feature.
- Where a dark spot occurs in a tree against a background of surrounding trees.
- When light reflects from the glass of optical instruments.
- When threat forces notice changes in the shape or color of terrain features and vegetation.
- When threat forces detect small groups of people appearing at approximately the same time and place (for example, for relief of observers, the serving of food, and the like).
- When a source of infrared radiation, thermal radiation, or electronic emission is detected.
- In winter, where there is an absence of frost or snow on certain tree branches.
- When there is movement of a tree in still air and nervousness on the part of birds and other animals in the area.
- In cold weather, where a wisp of smoke or steam appears from the heating of a fixed site.

Departure

When departing the site, leave quickly, quietly, and thoroughly remove all equipment, notebooks, trash, and like items. Pack ponchos and camouflage netting and, if practicable, fill in excavations. If you can fill in your excavation, carefully replace the original topsoil and original vegetation that was preserved on the site. Cover your tracks and otherwise leave the site in as close to original condition as possible. If you do not, and the site is subsequently discovered by threat forces, your presence will have been compromised. Knowing the location of the site may permit threat forces to surmise what information has been gathered. This compromise, in turn, may inhibit subsequent surveillance operations against the target. When departing the site, as a countertracking and security means, do not move directly to its ORP, patrol base, or rally point. Make frequent listening halts

en route to these locations, taking advantage of cover and concealment and making several changes in direction during movement.

CAMOUFLAGE AND CONCEALMENT TECHNIQUES

Concealment from observation is one of the main conditions for successful reconnaissance. If fixed site construction requires excavation, the principal problems are observer concealment during construction, removal of dirt, camouflage of leftover dirt, camouflage of the site during construction, and waste removal.

Concealment of Observers

In almost every case, construct an observation site at night, which affords significant concealment of your activities. The first stage of construction is the erection of a black Hessian net or other camouflage screen for you to work behind. When working on the site, do not rise above the screen. This net or screen is secured to local cover with bungee cords or 550 cord. Then emplace a poncho or other cover on which a pre-cut camouflage net is attached, which is then erected as overhead cover. Ensure no branches are broken and no other marks are left on the local vegetation.

LIGHT SOURCES AND DISTANCES OF VISIBILITY IN CLEAR, COOL AIR

SOURCE	DISTANCE
VEHICLE HEADLIGHTS 4-8 KM	4-8 KM
MUZZLE FLASHES FROM SINGLE CANNONS	4-5 KM
MUZZLE FLASHES FROM SMALL ARMS	1.5-2 KM
BONFIRE	6-8 KM
FLASHLIGHTS (WHITE LIGHT)	1.5-2 KM
LIGHTED MATCH	UP TO 1.5 KM
LIGHTED CIGARETTE	0.5-0.8 KM

NOTE: For observation from elevated positions or the air, these distances are increased by a factor of two or three.

Figure C-10. Light visibility chart.

Removal of Dirt

Carefully outline the dimensions of your excavation and remove the topsoil and vegetation to a poncho or other material from which it may later be used to camouflage the site. Transport excess dirt from the site in anything that can be used as a container, such as sandbags and empty rucksacks. In an underground site, most of the excavated dirt is placed back on top.

Camouflage of Leftover Dirt

During construction, remove the left-over dirt so it will not attract the attention of threat forces and can easily be retrieved when the excavation is being filled in. One method of hiding the dirt is to scrape the surface underneath brush, spread the fill, and then cover it with the scrapings (being careful to present as natural an appearance as possible). Another method is to look for a natural depression, remove the top cover, fill in the depression with the dirt, and replace the top cover. During heavy rains, when runoff naturally stains surface waters, dirt can also be dumped into streams and/or other waterways.

Camouflage of the Observation Post During Construction

While constructing an observation site, maintain camouflage discipline. Work diligently to minimize exposure to the threat. Minimize disruption of the surrounding terrain. Use the dirt and topsoil that was placed on a poncho or plastic sheeting for camouflage of the site. Maintain individual camouflage to the extent possible, for example, by donning gillie suits during construction. Use natural vegetation and/or other camouflage to conceal parts of the site already completed. Continue to camouflage the site to the extent possible through its completion.

Waste Removal

For health and security reasons, maintain a high state of personal hygiene while on surveillance operations. Human waste, in particular, presents a problem. Retain the dirt from excavations to fill over in layers the human waste deposited in the excavations. Waste can be deposited in zip-leek plastic bags, MRE bags, and trash bags (that are afterward sealed). To minimize odor, use lime, baking soda, or formaldehyde. Before leaving, remove all waste or bury it so that it is not detected by personnel or dug up by animals.

DETECTION AVOIDANCE TECHNIQUES

Avoiding compromise is a prime concern of every soldier. SF soldiers have developed techniques that assist in avoiding detection. Some examples are discussed in the paragraphs below.

Stealth and Movement Techniques

Drill and practice a variety of stealth and movement techniques. Drill and practice are especially critical for reconnaissance. Basic movement techniques, including immediate action drills, are covered in TC 31-29. Stealth techniques are important for the reconnaissance of defended targets, where you may have to take up to several days to move a few hundred meters up to and around a target. Use basic stealth techniques, including any movement techniques that allow low profile, slow movement, stealth, and the use of a gillie suit. You can develop and train for many other stealth techniques on the basis of METT-T.

Tracking and Countertracking

Another set of basic SR mission skills is in tracking and countertracking. Tracking is used to acquire a moving target. Countertracking is used to avoid compromise and capture.

Tracking. Personnel, animals, and machines leave signs of their presence as they move through an area. Detection and identification of these signs may yield valuable information in and of themselves or may lead to the acquisition of even more valuable information. Visual tracking is the art of following such signs. This skill is best acquired through intense study and practice under operational conditions. The six concepts of tracking are displacing, staining, weathering, littering, camouflaging, and interpreting. See FM 21-76.

Countertracking. Countertracking techniques can minimize telltale signs that the threat force can use against you. Observation of the mistakes being made by the threat force enables the SFOD more carefully. Be conscious of the way you exit a stream, cross a trail, or move cross-country. Be security conscious at all times. Basic countertracking techniques you may employ include scent masking and direction changing.

Scent masking. Before starting an operation, follow the dietary and personal hygiene practices of the people in the area in which you are operating so that you smell as the locals do. Further masking may be accomplished by standing in smoke from a wood fire, particularly if fires are common to the AO. As an added precaution, attempt to approach the target from downwind and avoid populated areas.

Direction changing. To find out if you are being followed, circle back and observe your trail for pursuers. To shake off trackers—

- Make sudden, random changes in direction of 90 degrees or more.
- Walk several meters downstream before emerging from streams that must be crossed.
- Walk over hard bare ground, or in areas of drifting sand or snow, walk into the wind before making a radical change in direction.

Detection by Animals

In most areas of the world, dogs and other inquisitive animals can be found. A small pellet or BB gun can scare away these pests quietly; however, the weight of the gun and the space it takes up may not justify the benefits it provides.



RECONNAISSANCE METHODS

When conducting SR operations, SFODs may employ patrols, establish observation or listening posts, emplace sensors or other special equipment, or conduct clandestine target penetration directly or through surrogates based on the IPB processes and overlays. SR is used to locate high-value military targets accurately for deep-attack weapons systems; to assess friendly, hostile, and uncommitted third-party strengths and weaknesses; and to perform other collection tasks that are beyond the capabilities of traditional military reconnaissance and surveillance units, creating windows of opportunity for decisive action. In performing their missions, SFODs employ two methods of reconnaissance— zone and area reconnaissance.

ZONE RECONNAISSANCE

Zone reconnaissance includes operations conducted to obtain information on the threat, terrain, and routes within an area. The principal purpose of using SFODs against such targets as industrial facilities or LOC is to monitor their status and activities for use in a follow-on or standoff attack. SR targets are normally located beyond the capabilities of conventional reconnaissance means. Zone reconnaissance teams reconnoiter one specific objective and its immediate surrounding area using long- and short-range surveillance and/or vantage points. An SFOD may conduct one or more area reconnaissances within its zone based on its mission analysis. Zone reconnaissance missions may require more than a single SFOD. When two or more SFODs are used in a zone, close coordination is required. Mission planners should consider splitting the zone into smaller sections. If such a split is not feasible, the planners should clearly define boundaries. Zone reconnaissance includes use of the fan, converge, successive-sector, and “L,” “U,” “W,” and “Z” techniques.

Fan

In the fan technique, SFODs leave an objective rally point (ORP) and return to the same ORP. As shown in Figure B-1, page B-2, SFODs move out of and enter the ORP at opposite sides and move in the same clockwise direction to eliminate the chances of accidental contact between the elements. They may survey their routes singularly or simultaneously. The routes must be planned so that SFODs do not converge and interfere with one another. This method tends to compromise the location of the ORP after a time because of frequent movement into and out of the ORP. Therefore, SFODs should relocate the ORP often. They must ensure enemy trackers don't follow them back to the ORP.

Converge

In the converge technique, SFODs move through areas on converging routes. Beginning at an ORP where elements are briefed, they move on separate routes through the area and converge at the end of the area at a rendezvous point. The SFOD leader briefs each element on the route it is to take, the location of the rendezvous point, and the linkup time at the rendezvous point. As shown in Figure B-2, the SFODs start their sector reconnaissance in the same relative direction from their rally points (RPs) and move in the same counterclockwise direction to prevent chance contact.

Successive Sector

In the successive sector technique, SFODs may divide the objective area into segments and assign each element a segment. As each element moves at its own pace until it completes its part of the reconnaissance, no time is wasted in waiting. It also allows element leaders more freedom of action. The SFOD leader may only dictate the general direction of movement the elements will take in their AC, the time for completion, and the linkup or rally point. Figure B-3 shows the use of two techniques and an optional third that may be used by reconnaissance elements.

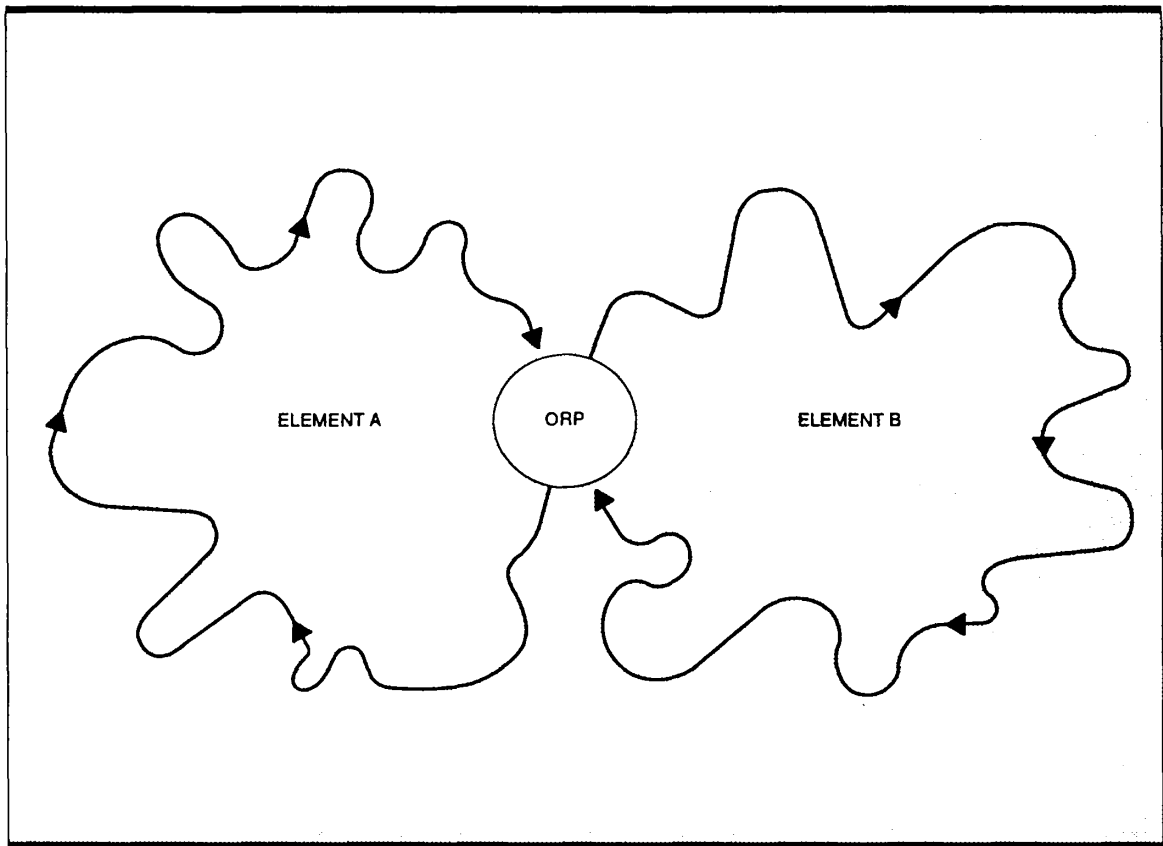

Figure B-1. Fan technique.

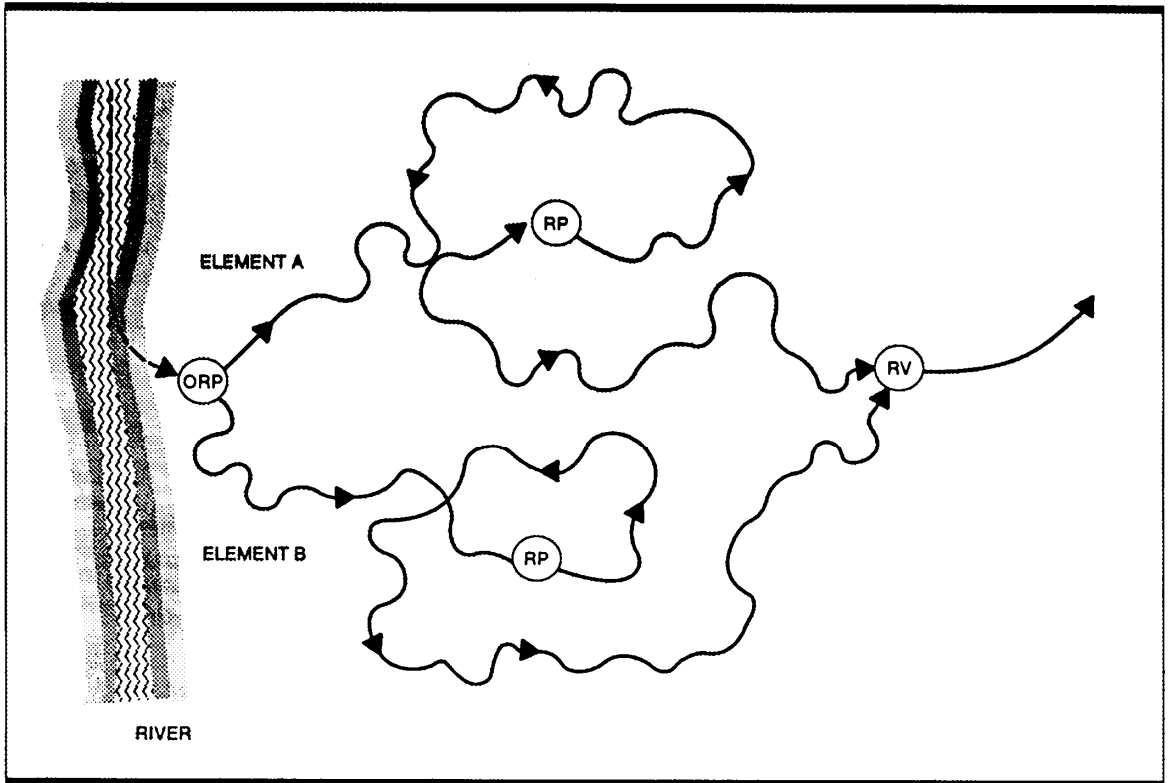

Figure B-2. Converge technique.

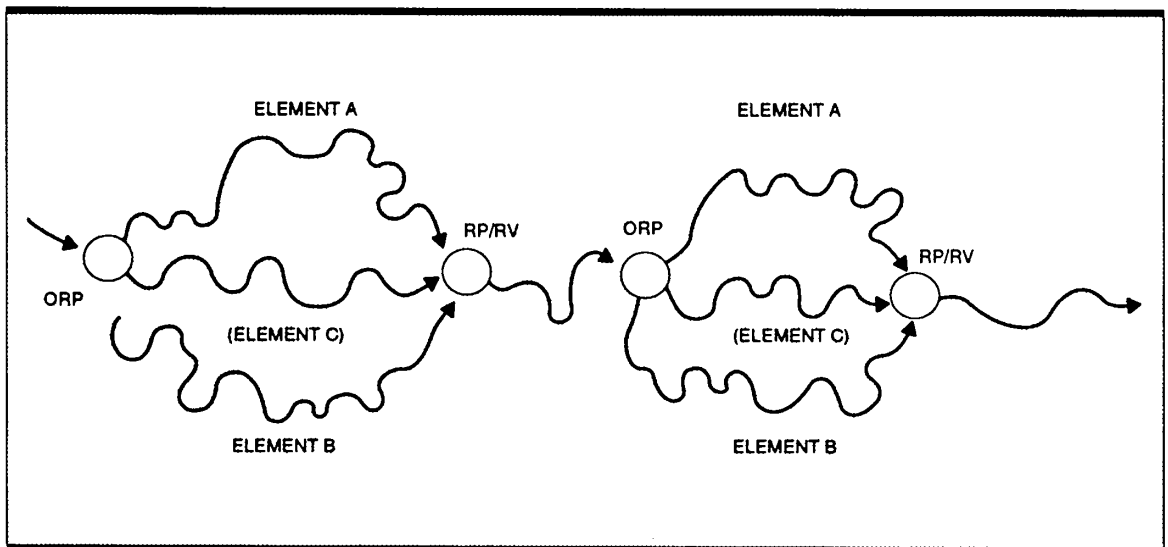

Figure B-3. Successive sector technique.

“L” “U,” “W,” and “Z” Techniques

It is generally impossible to completely survey over-sized patrol sectors. In such situations, the SFOD must therefore plan to employ a technique of cross-country movement that will provide the best coverage consistent with the mission, threat force disposition, weather, and terrain. It is important that the SFOD move in a way that will permit it to intersect LOC, linear obstacles, and that forces, especially in an area about which little is known of the threat and/or terrain. Basic movement techniques used for surveying specific patrol sectors in such situations include the “L,” “U,” “W,” and “Z” techniques as illustrated in Figure B-4. In all cases, the patrol inserts at one point in its sector and is picked up at another distant point. In most cases, threat forces, weather, and terrain preclude following a model pattern, but the principle remains valid.

Route or Corridor Reconnaissance

A variation of zone reconnaissance is route or corridor reconnaissance. Route or corridor reconnaissance obtains information on the targeted activity, obstacles, route conditions, and key terrain features (Figure B-5). Reconnaissance and classification of existing vehicular routes can be of great importance in determining the mission capabilities of the target complex and taking appropriate follow-on actions. SFODs normally generate ROUTEREPs and BRIDGEREPs in route or corridor reconnaissance. See Appendix D. For more information on route reconnaissance, refer to STP 31-18C34-SM-TG.

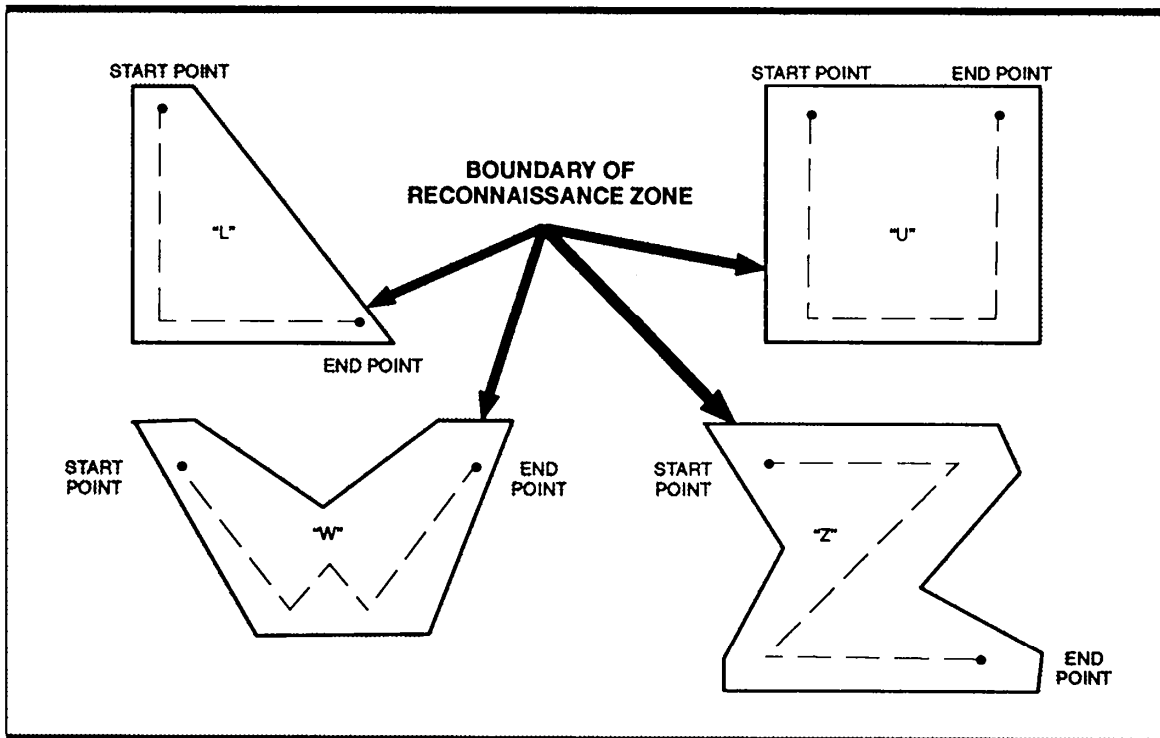

Figure B-4. "L," "U," "W," and "Z" techniques.

AREA RECONNAISSANCE

An area reconnaissance is a survey of a specific location such as LOC choke, special weapons storage sites, launch sites for such weapons, industrial plants, or terrorist safe houses (see Figure B-6, page B-6). The basic purpose of using SFODs in this context is to provide real-time and NRT information on status, disposition, and significant activity to predict threat activities and/or generate enough information for a friendly reaction.

As in Figure B-7, page B-6, area observation is accomplished by maintaining OP surveillance on the target, usually a known or suspected choke point, position or activity. When SOT A augmentation is available, there may also be an additional SIGINT OP surveying the target.

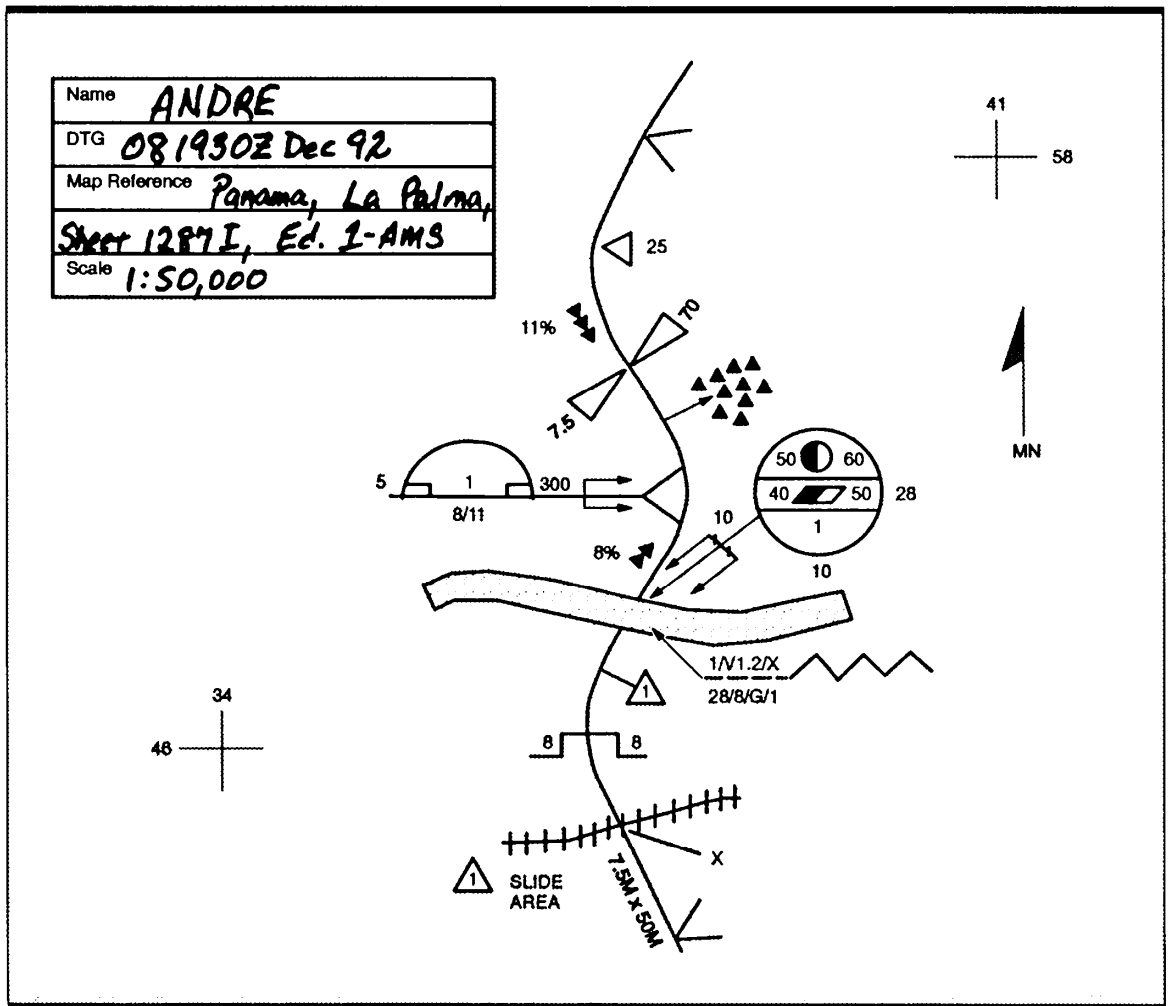

Figure B-5. Route and/or corridor reconnaissance.

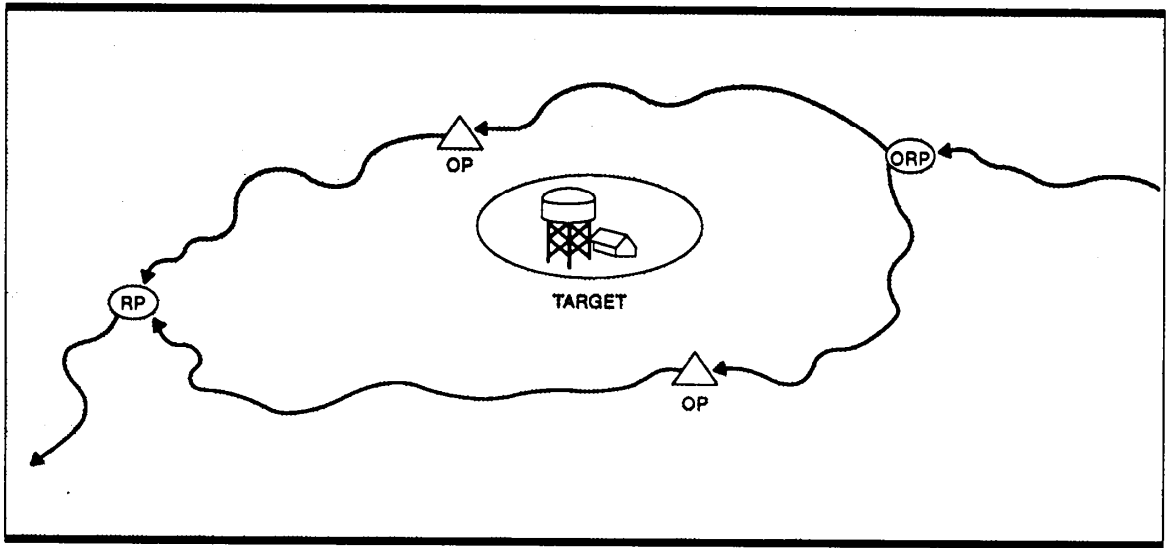

Figure B-6. Observation of a specific point.

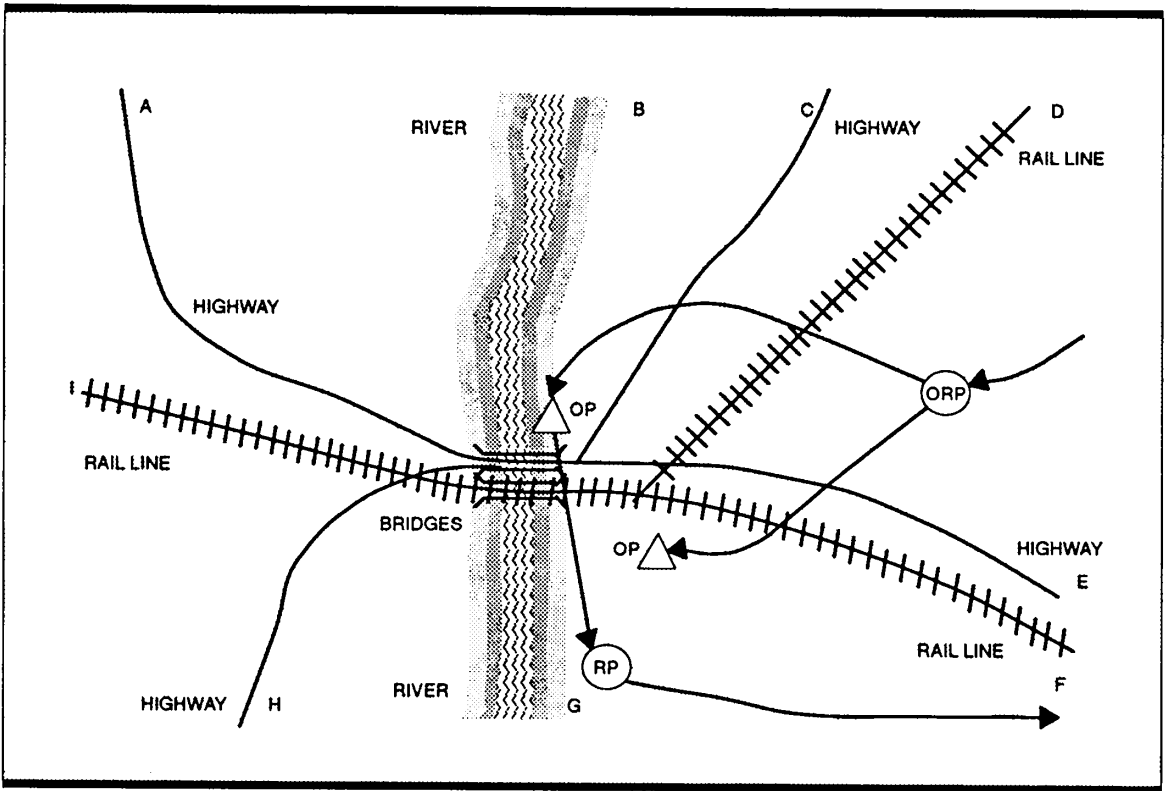
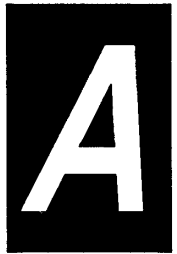

Figure B-7. Choke point observation.

APPENDIX

FIXED OBSERVATION AND SURVEILLANCE SITES



An observation and surveillance site can be a prone soldier in a defensive position. The site might also be an elaborate underground complex constructed with polyvinyl chloride (PVC) pipe and canvas with connecting transmission sites. The type, location, and operation of the site depend mainly on METT-T factors. If during mission planning, the SFOD determines that fixed site is required, then site selection, security, construction, and occupation must be planned in detail, and practiced. The variables associated with fixed SR sites are the geographic regions in which the operation will take place. This appendix addresses the process of selection, construction, and occupation of fixed observation and surveillance sites used in permissive and nonpermissive areas around the world. During this process, the SFOD should apply the acronym "BLUES" (Figure A-1).

URBAN SURVEILLANCE SITE

An urban or built-up area forms the economic and cultural focus for the surrounding area. It is characterized by a concentration of man-made structures, facilities, and a population. SFODs may conduct fixed and mobile surveillance in urban areas. Because of the generally limited fields of vision, urban operations normally require more sites than rural operations. See FM 90-10.

- B**lend in with the surrounding area. Does the site look natural? Does it attract unwanted attention?
- L**ow to the ground construction techniques must be used. Does the site provide protection against small arms and direct weapons fire?
- U**nexpected sites should be used. Will the threat forces expect you to look out the window or the small hole in the wall?
- E**vacuation routes must be planned during site selection. Where will you go to link up with the remaining SFOD members if you are discovered or overrun?
- S**ilhouetting the site is avoided by using the sides not the crests of hills. Can the sniper see you silhouetted against the skyline, wall, or other object?

Figure A-1. "BLUES" application.

Site Selection

METT-T dictate urban site selection as with other observation and surveillance sites. SFODs can construct fixed urban sites in occupied and abandoned buildings, water tanks, shrubbery, on factory chimneys, or in the attics of multistory buildings or other tall structures. If possible, SFODs should avoid wooden buildings and buildings in a significantly deteriorated condition because of the risk of injury from fire and/or structural failure.

Permissive and Semipermissive Environments. If operating in urban areas in a permissive or semipermissive environment, surveillance teams may be mobile, using indigenous transport such as taxicabs, military vehicles, trams, bicycles, and subways. Taxicabs often have the advantage of having two-way radios. In such environments, fixed and overt sites may be emplaced to serve as a deterrent by virtue of their mere presence. Where sites are overt, they must be mutually supporting and hardened enough to withstand threat attacks.

Nonpermissive Environments. If operating in a nonpermissive environment, fixed sites should not be in buildings that attract the threat's attention but should be in rubble, yards, and gardens. If the site is to be set up in an undamaged part of the urban area, the SFOD should select buildings of solid construction with serviceable stairs and basements that can be equipped for the rest and shelter of personnel during artillery bombardment.

Construction

Site construction may consist simply of taking a position by a suitable viewing port, or it can be much more elaborate. If the SFOD plans to use the site for an extended time, it must take steps to improve site survivability and its ability to fight fires. Windows, doors, and other openings (like bullet holes not used for observation) are filled with bricks, fragments of building materials, or sand bags if available. Flammable objects are removed from the premises. The SFOD performs all construction while keeping in mind operational security. Supplies of water and sand are assembled for fighting fires. If the threat has previously occupied the building, the SFOD takes precautions against booby traps and mines. Where the threat is near, several places in the building are prepared for observation and departure. Interbuilding monitoring and SFOD communications are hard wired if wire is available although fiber optic cables, if available, offer better security.

Vulnerabilities to Detection

The higher concentration of people, security forces, lighting, and movement in urban areas require SFOD members to take additional precautions to avoid detection during their surveillance activities. SFODs in such situations may comprise teams of as few as two people, working in civilian attire and employing safe houses. Intra-team communications may require very low-power radios and the use of specialized technical and nontechnical communications means as a last resort when other means are inadequate or impractical. If operating from an occupied dwelling in a denied or contested area, the SFOD must be careful not to consume more electric power or water than usual or more heating fuel or focal

than average for the normal occupants. Security forces have been alerted to the presence of SFODs by such minor indicators as sudden increases in milk deliveries. Electronic countermeasures (ECM) technology has also advanced to a point where mobile units operating from the street can electronically survey a building and detect and identify very small sources of energy. This type of ECM intensifies if the presence of an SFOD is suspected. Such capabilities are increasingly widespread and are often found in built-up areas of even marginally developed countries, especially in the "security states" of the Third World. As a result, urban operations require extremely detailed planning in electronic counter-countermeasures (ECCM).

MOUNTAINS

Mountainous areas are characterized by rugged, poorly trafficable terrain, steep slopes, and elevations above surrounding areas. The number of observers and sites required may be increased in mountainous terrain due to the relatively limited fields of vision compared to flat terrain. However, in areas above the tree line, or when lower elevations lack vegetation, the number of observers may be decreased. A careful study of the target area will give a good indication of the requirements. For a general discussion of operations in mountainous areas, see FM 90-6.

Site Selection

Mountain terrain provides many places for cover and concealment. Site selection is not guided by the height of a given mountain but by the irregular fields of observation, dead spaces, cover and concealment, and the limits of the observation equipment used by the SFOD. The SFOD may employ a circular, multitiered system of observers. To increase the daytime viewing capability, the SFOD situates sites not only laterally but also with vertical dispersion. This layering of sites also reduces the need for movement when changing from daytime to nighttime operations. Since movement is the main cause of compromise, layering sites also adds to the security effort of the deployed SFOD. (See Figure A-2).

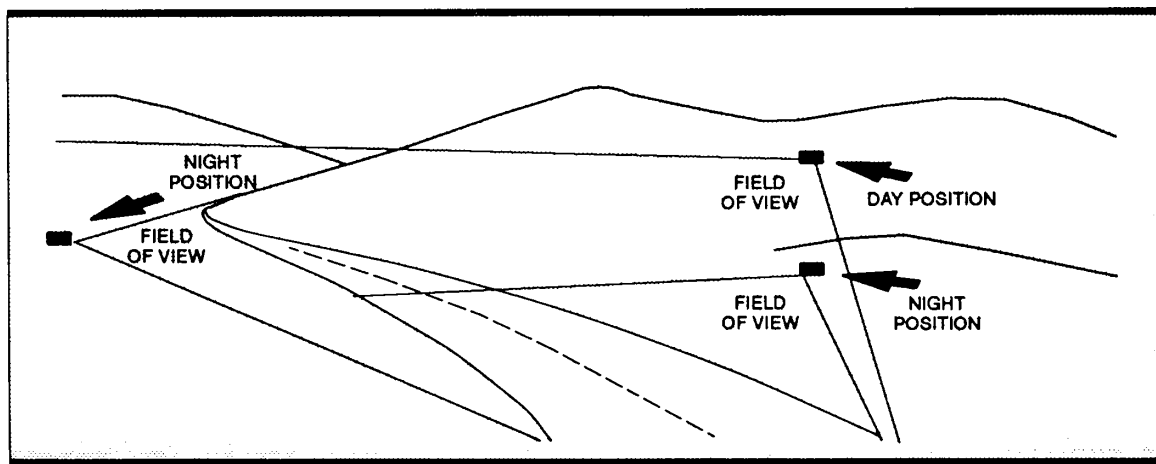

Figure A-2. Overlapping mountain observation sites.

Construction

Irregular terrain in mountains often affords natural hiding places for observers. In most mountainous areas, the rocky nature of the ground makes it difficult and often impossible to dig below-ground sites. In those cases, the SFOD may use boulders and loose rocks in above-ground construction of low-walled sites called "scrapes." When these sites are constructed, SFOD members use the same degree of care in camouflage as they use in the case of all other types of construction. The site must blend in with its surroundings and not be detectable from any angle. Fields of view can often be enhanced if the lower branches on the undergrowth are trimmed back with a wire saw, shears, or knife.

Night Observation

At night, the SFOD may enhance observation in mountainous areas by sending out additional observers into valleys and hollows. Observation from below upward against the background of the sky often gives better results. Moreover, the SFOD should supplement night observation by monitoring. Monitoring is more effective in mountainous areas than on flat terrain, since sounds are often funneled to the head of valleys and are perceptible at great distances. However, sounds in the mountains can be deceptive. Various obstructions can reduce their volume and change their direction.

Snow

In mountainous areas, where snow is expected or known to be on the ground, SFODs can use certain tactics to reduce the problems associated with operations in the snow. Some of those tactics are discussed in the following paragraphs.

Fixed Site Selection. While conducting a map reconnaissance of the AO in isolation, the SFOD chooses sites that are in shaded areas, on slopes facing away from the equator (north in the Northern Hemisphere, south in the Southern Hemisphere). This preliminary site works to the advantage of the SR mission as described below.

In moderate temperatures, the heat generated from the observer's bodies melts the snow on the cover of the site. The result is an unexplainable muddy area in snow. Such melting is, however, common around trees. The melting snow during the heat of the day often falls to the ground and, in turn, melts the snow on the ground. The melting snow falling off the trees often can be used as a water source. Unlike snow, this water source does not require melting over a heat source. The shadows found around rock outcropping and trees also aid in hiding the foot trails leading to the work area and site. The shade aids in an even melt. Even melting helps prevent compromise. Walking compresses snow under each footprint. The compressed snow melts at a slower rate than the surrounding snow. This effect is like comparing the difference between crushed ice and cubed ice in a drink. The loose, crushed ice melts faster than the dense cubes. In areas where the snow melts fast, such as a sunny side of a hill, the compressed snow will leave footprints or trails leading to the site.

The constant daytime melting and nighttime refreezing of snow on slopes often results in avalanches. Reducing the risk of avalanches can be done by using shadows and shaded slopes. Most danger areas are well known and are often plotted on military and civilian maps.

Mission planners consider the advantages and disadvantages of using the infiltration aircraft very close to the target area. In remote areas of hard packed snow, the rotor wash left from a low-hovering helicopter may be more desirable than long trails that can be easily tracked.

Information on Snow Conditions. Multiple sources are often available for obtaining information about the snow conditions in different areas of the world. One of the most often overlooked is area tourist information services. In many countries, these services are often free and available to everyone. Also, information on areas susceptible to avalanches is often available through maps, national or state forest services, or other government services. The SFOD may also get information on daily snow conditions from area ski resorts. Combining this information with that obtained from the regular weather services can provide the mission planners with a detailed picture of the area.

DESERT

Deserts have a low-average rainfall and a lot of sunshine. Plants and discernible terrain features are scarce in these regions. Deserts are characterized by sand storms, dust, fog, and haze. The temperature may change 100 degrees Fahrenheit (48 degrees Centigrade) between the hot days and the cold nights. These are but a few of the problems that an SFOD will face when employed in the desert.

Navigation

Determining the exact position of an SFOD or target on the ground is very difficult. Only distant terrain features, mirages, and the changing climatic situation hinder navigation. Recently, however, global positioning systems have been developed to locate positions through the use of satellites. All units employed in desert regions should obtain one or more of these invaluable tools.

Observation Techniques

Mirages will affect observation in desert country. Frequently checking the terrain against the map aids the observer. However, training and experience play a critical part in accurately reporting the activities of the target. The SFOD pays special attention in the still, early-morning hours when targets are not concealed by clouds of dust close to the ground. During the day, however, the wind may disrupt or destroy camouflage completed during the night and make identification of threat positions considerably easier. Routine "stand to" actions during sunrise may provide the best information of the day.

Optical Aids

Optical aids play a big part in mission success in desert regions. These aids may range from binoculars to high-powered night vision telescopes. Standard binoculars prove effective, even during the hours of darkness. Optical aids must hold a special place in the unit's METL and be used routinely during training.

Desert Vehicles

Vehicles are normally used for desert observation and surveillances due to the vast distances covered. However, fixed sites may be used as well. Where fixed

sites are used, the positions are normally buried or semiburied because of the lack of cover and concealment. Often these positions are as much as 15 degrees Fahrenheit (8 degrees Centigrade) cooler than the surrounding terrain and permit the SFOD to operate for a longer time in the area.

Site Construction

Deserts often have rocky soil or “surface chalk” soil, which makes digging difficult. Disturbing this “chalk” is a major concern when digging subsurface sites. In most desert areas, rocks and boulders are often used in site construction. Underground sites are also difficult to construct in soft, sandy areas because of sidewall instability during construction, occupation, and use. Sidewall reinforcement is almost always required. Sandbags, plastic sheeting, and sand filled boxes may also be used for containing backsliding soil. For a general discussion of operations on desert terrain, see FM 90-3.

FOREST

Forested terrain is characterized by dense foliage, shrubs, and other vegetation, with limited fields of observation and fire. Because of the limited fields of vision, observation site selection is very important. During site selection, the SFOD considers all the options available. Surface or subsurface sites or observers in trees all have different advantages. A careful analysis of the terrain is important to the success of the mission. Old-growth and new-growth forests have different characteristics. The main difference is the height of the limbs and undergrowth. Such information is required for both site selection and planning movement times.

Ground Observation Sites

Sites on the ground are camouflaged to resemble stumps, fallen trees, bushes, and like features. For increased surveillance, the SFOD locates the site to overlook the intersection of fire lanes, roads, and footpaths on the edge of sparsely wooded areas and natural clearings. When available, obstacles such as creeks, ditches, or steep slopes should be between the site and the probable route of security forces. At night, even a small creek causes a threat force to make noise, disrupt formations, and generally slows its progress. All of these actions are to the advantage of the SFOD.

Observation Sites In Trees

A variety of skills are required for observation from sites in trees. The equipment requirements and planning considerations are different from those of ground sites. Observers for tree sites choose trees that are situated well within the forest. They should never stand out in height, shape, or color. Observers are well camouflaged in the crown of a tree. The primary disadvantage is getting into and out of the site. Special skills and equipment are required for operations in trees. Further, the observer in the tree must be covered by fire that permits him to exit his location if detected or engaged by hostile forces. On the other hand, trees provide an advantage of a long-range view in open areas. In heavy-growth areas, the view may be nothing more than the tops of trees. This consideration can be addressed through area studies and debriefing assets during mission planning. Another advantage of tree observation sites is that most people don't look more than 2 to 3 feet above their heads when walking. When a traveler is carrying a load on

his back, he often bends forward at the waist. Both of these actions prevent him from doing little more than looking at the ground at his feet to maintain his footing. With one key exception, trees will provide good concealment for the observer even if the threat force is trying to look in the trees for him. The one key exception is when the observer is moving about in the site. Slight movements in trees can be seen and heard for vast distances. Employed SFODs consider providing the observer with a small piece of flat wood to stand or sit on. In a forest, an observer often sees less than he hears, especially at night. Monitoring the target area is critical to accomplishing the mission and providing the SFOD with operational security. The observer can monitor the target in several ways. He can sit quietly listening to sounds with his eyes closed, or he can record the sounds of the area on a tape recorder and play the sounds back at a louder volume into headphones. Remote sensors often play a key role in monitoring the target. Each SF group has sensors assigned to its MI detachment. These sensors normally are easy to use and provide outstanding results.

JUNGLE AND SWAMP

SFODs often conduct SR operations in humid, tropical areas with dense growths of trees and vegetation that reduce visibility to less than 30 meters. This thick growth provides the SFOD excellent concealment; however, movement through dense jungle terrain is impeded by a time multiplication factor of 2 or 3. For a general discussion of operations on jungle terrain, see FM 90-5.

Observation Site Construction

Most jungle sites used by SFODs are unimproved. The observers may do little more than lay on a poncho to keep dry and minimize disruption of their site. More developed jungle sites are quickly constructed using easily procurable items such as ponchos or natural materials. Planning considerations, such as high water tables, dense undergrowth, and tree roots often require above-ground construction. SFODs give primary consideration to drainage, waterproofing, and the avoidance of poisonous insects and reptiles. This technique not only prevents flooded positions but, in areas of standing water, will provide the observer the ability to listen and watch for movements in the target area.

Hammocks. Lightweight, compact nylon hammocks are invaluable in jungle regions. The hammocks can be used for sleeping or for storage of equipment. The primary advantage is that the soldier or equipment is elevated off the ground. Unlike the "swamp bed" the hammock does not require a lot of work to erect and is temporary in nature. For more information on swamp beds, read FM 21-76.

Floating Platform. The floating observation platform is a structure used in areas where ground water is high or where there is a low-pressure resistance soil. This platform provides a floating base or floor where wet or low-pressure resistance soil precludes standing or sitting. The platform is constructed of small branches or timber layered over cross-posts, thus distributing the floor load over a wider area (see FM 5-103).

NORTHERN AREAS

Observation in northern areas requires a number of special considerations. Observers must contend with extended light in summer and extended darkness in winter, along with the cold, snow, ice, fog, rain, and sleet. In most cases, operations

require at least six men to ensure continuous observation and security. Shelter is critical for protection of the men and their equipment from the elements. When using northern sites, observers must take advantage of wind breaks, such as densely wooded areas, downwind sides of terrain elevations, and depressions. Where these features are not present or their use is infeasible, observers use other expedients, such as snow caves. In general, the four basic construction materials available in cold region terrain are snow, ice, frozen soil, and timber. For a general discussion of operations on northern terrain, see FM 31-71. For a discussion of shelter construction in northern areas, see FMs 21-76 and 5-103.

PLANNING

Surveillance planning is a vital part of the SR mission. Based on the analysis of the mission and target(s) during isolation, the SFOD intelligence NCO develops a tentative reconnaissance and surveillance plan for placing the target under observation. The plan addresses the location of observation sites, the duration of surveillance, the number of personnel to be employed, and the items of special equipment to be used. Planners consider the use of sensors to expand the sector of surveillance, provide security to observers, and cover dead space. When covering a point target, 360-degree coverage is ideal but not necessary if the critical node can be observed from one site. All-around coverage may require the use of multiple sites, which, in turn, may require the SFOD to be augmented with additional personnel. However, when more personnel are involved in surveillance, the chance of mission compromise is greater. Once surveillance is established, it should be continuous; however, continuous surveillance may not always be feasible.

CONFIRMATION OF THE SITUATION

Upon arriving at the target area, the SFOD must conduct a preliminary reconnaissance to confirm the situation. The goal is to confirm the targets' exact location, ensure the maps used during planning were correct, and be the basis for selecting the actual locations of the observation and surveillance sites. Other items of interest addressed at this time include indications of threat security patrols, population control measures, LZ and DZ locations, and the best routes for movement in the area. Major changes to the situation may require revamping of the plan. If major changes to the coordinated plan are required, the new information must be passed to all supporting agencies through the SFOD's higher headquarters.

SURVEILLANCE SITE SELECTION

Surveillance sites are used for observation and monitoring. They are a vantage point from which visual, audible, olfactory, and electronic data on a target is collected. Selection of the sites is based on METT-T factors, but several general planning considerations apply. The sites—

- Afford adequate visual and electronic line-of-sight target observation and security for the observers.
- Have as wide a field of view and as little dead space as possible.

- Are not near natural lines of drift or in terrain that would naturally draw the attention of threat forces, such as atop a flat rock face on a hill.
- Have covered and concealed exit and entry points.
- Are far enough downwind from the target and inhabited areas to minimize the olfactory detection of the site by dogs or people. Keep in mind that wind directions often change at various times of the day.
- In general, are as close or distant to the target as mission and security considerations dictate.
- Have good overhead and side cover and concealment.
- Are capable of enacting battle drills to break threat contact.
- Afford reliable communications between the observers and their main body, security element, and/or communications element.
- Are, above all, in a location that is not obvious to threat forces.

If all these features cannot be found in a single site (for example, daytime versus nighttime requirements), separate sites suited to the type of surveillance performed may be necessary. Multiple sites are mutually supporting if one site is compromised, members of the other site are able to continue the surveillance mission and/or warn the rest of the SFOD. Further, if the sites are not being used during the day, they should be kept under observation. If the sites can't be secured by observation, they should not be reused the following night. This practice prevents the SFOD from walking into an ambush while trying to reoccupy the position. The SFOD avoids establishing patterns and trails while moving to and from the different sites. In all cases, the SFOD selects alternate locations for its sites if the primary sites selected on the basis of map reconnaissance prove unsuitable.

SURVEILLANCE SITE CONSTRUCTION

Surveillance sites can be surface, underground, or elevated. The SFOD designs these sites for a specific purpose, mission, or target. The primary rule for building the site is that construction must be done during darkness and the site must be occupied before sunrise. Based on METT-T, occupation before sunrise may not be practical. An overt site in a permissive environment could very well be built in daylight, or a complex site may require more than one night to build. Other planning factors such as illumination and current weather conditions also play a major role in construction and occupation of a fixed site. When all factors are considered and the final location of the site is selected, then the priority of work is the external features of the site. After occupation of the site, the SFOD can improve internal features. While planning the construction of the site, the SFOD keeps in mind that everything used for the site must be removed or replaced so that the terrain is returned to its natural state. The SFOD keeps threat forces from gaining information about the extent of the operation, possible target location, and even the fact that it was in the area. Not enough can be said of the importance of site construction rehearsals under similar conditions to the target's. When possible, the same type soil, construction materials, and planned techniques are used. During rehearsals, fellow unit members try to compromise the SFOD that has occupied the site. Weaknesses in construction or occupation plans will quickly become apparent.

Types of Observation or Surveillance Sites

When fixed sites are required for mission execution, METT-T factors determine the extent of the construction. In all cases, camouflage and concealment, as well as light and noise discipline, are important considerations during the construction of observation or surveillance sites. The following paragraphs describe different types of site construction commonly used.

Above Ground Sites. Above ground sites are the most common type of fixed observation and surveillance sites. The advantages of selecting an above ground site are the ease and speed of which the site can be selected and occupied and the simplicity of construction. The primary disadvantages in these type sites are easy detection and little protection from small arms fire compared to below ground sites.

Spider hole. This type of site is similar to a fighting position with overhead cover. The dimensions are normally about 0.75 meters wide by 1.2 meters long and 1 to 1.5 meters deep. The observer can adjust the dimensions to meet his needs. This one-man site is normally established on a line or ring to provide support and enhance security (see Figure A-3).

Scrape. A scrape is the enlargement of a depression in the ground to allow for one man to take up a position. Scrapes are hasty in nature and require little preparation. Often used during darkness, scrapes provide the observer with a position where he can better use his optical devices. The observer removes as much of the signs of occupation as possible when he leaves. He obscures the area by brushing matted grasses, displaced dirt, and footprints. Overhead cover such as a poncho provides limited protection from the elements. (See Figures A-4 and A-5.)

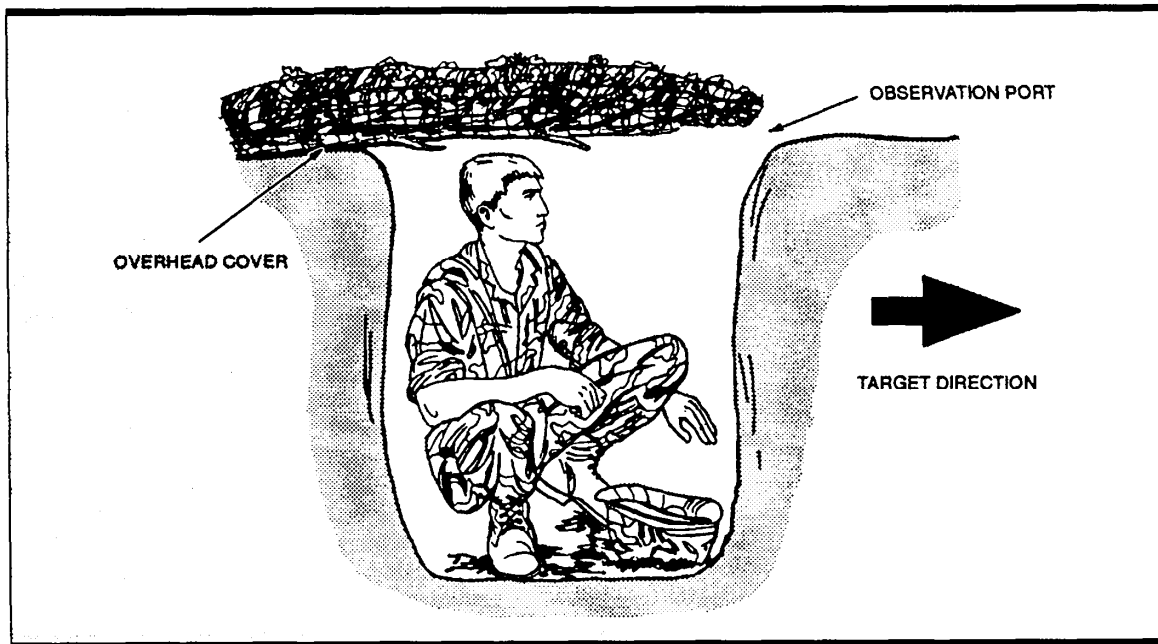

Figure A-3. Spider hole observation site.

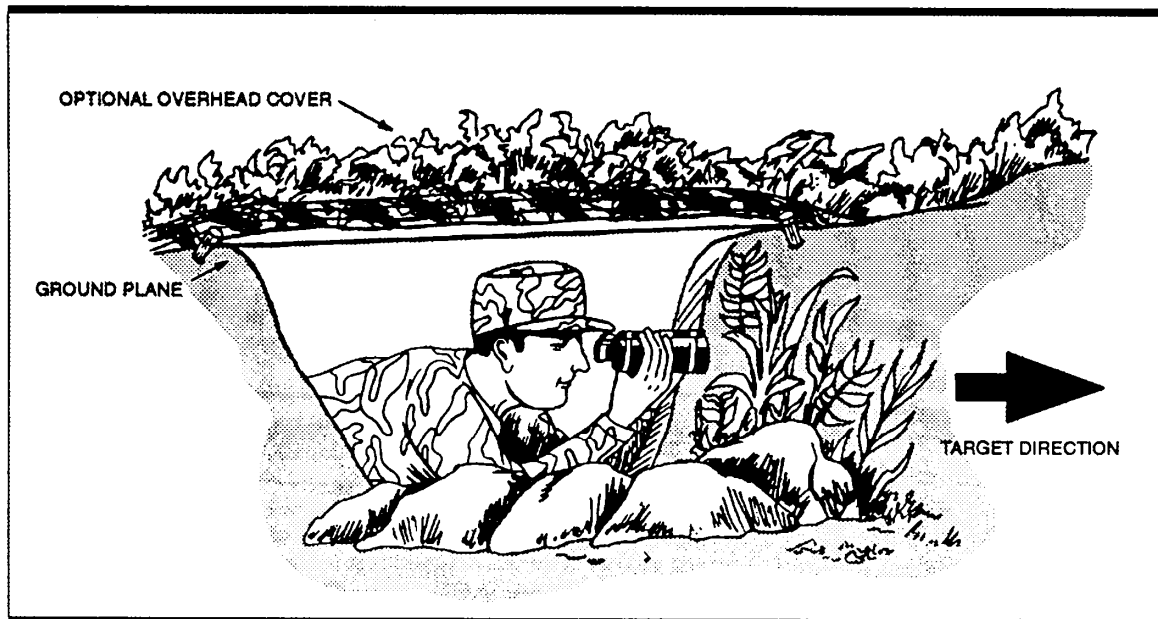

Figure A-4. Scrape-type observation site.

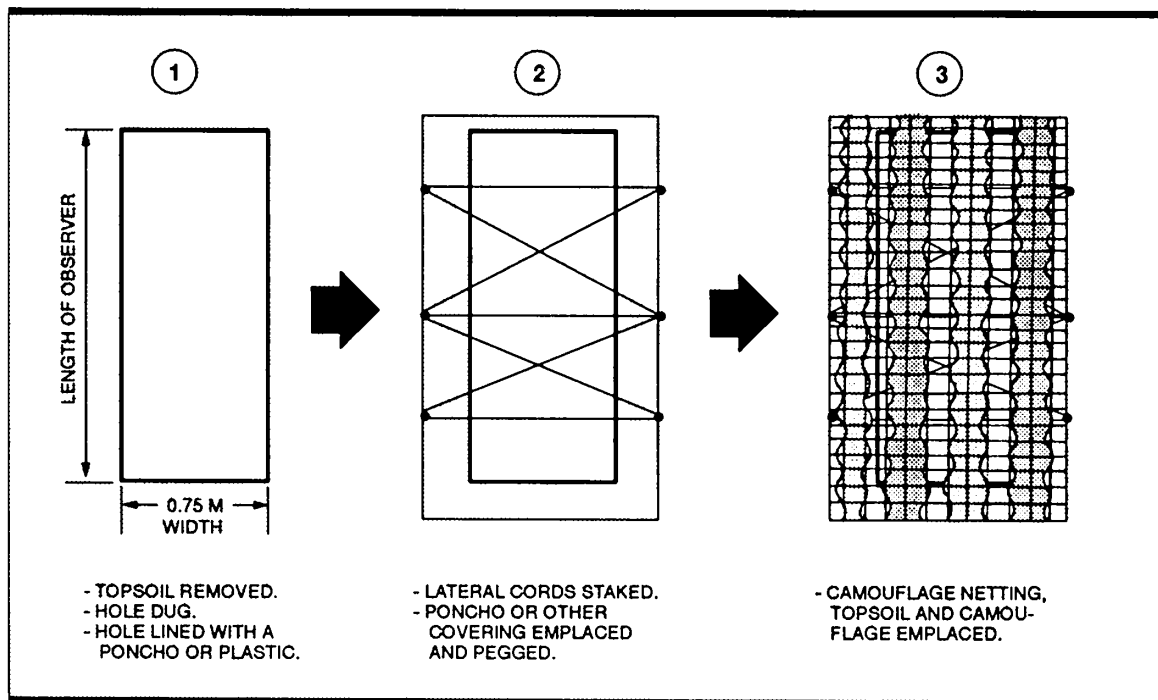

Figure A-5. Scrape plan example.

Tent-type site. Larger than a spider hole, this site is constructed for more than one observer. Supports for the overhead cover are made from a variety of material. Branches, aluminum conduit, parachute suspension line, or fiberglass rods all work well as a frame for the cover. A slight arch in the cover multiplies the available space on the inside of the site. The observer avoids grossly breaking the ground plane with the apex of the site. (See Figure A-6.)

Underground Site. The safest type of observation site for the observer to use is the underground site. The complexity of design and the effort required to construct the site are the primary detractors. When using light equipment such as shovels and entrenching tools, underground sites can only be constructed in loose soils. Soil type is a very important planning consideration that must not be overlooked during mission preparation.

Bunker-type site. This site requires extensive construction time and material to complete. The observer can construct the underground bunker-type site using a prefabricated kit. This kit includes the tools needed to excavate and cut local materials such as trees and logs. The kit also contains plastic sheeting for waterproofing the roof, walls, and floor. The sheeting can also be used to reinforce loose soil in the site. However, depending on the soil in the area, sandbags are often required to shore up the sides of the site. Also, sandbags lessen the accumulation of condensation produced when plastic sheeting is used. (See Figure A-7.)

Caves. Caves can provide the observer with a ready-made observation site. However, caves present special problems. First, caves attract attention. They are often shown on maps or are known to the local populace. Locals often use caves for shelter and sometimes for storage. Caves also attract animals. Bats, birds, snakes, and larger animals use caves for shelter. The presence of these animals presents medical risks to the SFOD members. Also, early warning devices may be activated and attract the attention of local threat forces. Using caves increases the chance of discovery and is avoided in all but emergency situations.

Construction Techniques

Several construction techniques are common to all observation and surveillance sites. These techniques are included in SOPs and practiced during normal training.

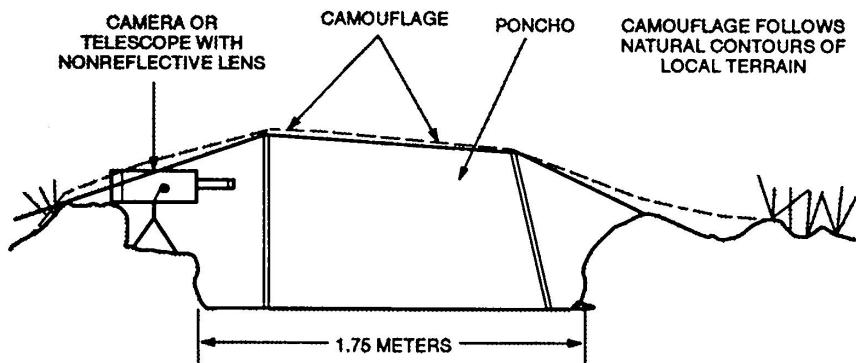

Figure A-6. Tent-type observation site.

Dirt Removal. The primary problem in constructing any site is the removal of excess dirt. Excavated soil expands in volume. In dry climates, the subsurface soil contains the most water. This water content causes the soil to be a different color. This soil must be camouflaged. The SFOD constructs underground sites before the early morning dew develops. Discarding excess soil before the dew sets in aids in the camouflage process. The SFOD also considers the effect of the sun drying out the excess soil. This dried soil may need to be recamouflaged. The main technique for camouflaging soil involves the use of plastic sheeting or a poncho. The steps are as follows:

- Lay out the sheeting alongside the site position.
- Place the topsoil to one side of the sheeting. Remember that the topsoil only extends a few centimeters below the surface. Save as much of the vegetation as possible. (See Vegetation, page A-14.)
- Dig out the remaining soil. Do not mix the topsoil with subsoil from hole.
- Fill sandbags with the (loose) soil dug from the hole and use them to reinforce the sides of the site.
- Fill surrounding depressions, ruts, or ditches with the remaining excess soil. If this procedure is not possible, spread the soil lightly on the surface in an area away from the site. Avoid putting the excess soil in creeks or streams that may wash the dirt down the waterway and attract unwanted attention.
- After the overhead cover is constructed and waterproofed, replace the topsoil. Place vegetation, leaves, deadfall, or other local materials about the area to complete the camouflage of the site.
- The final step in the process is to recover the sheeting used to contain the soil. Check the vegetation under the sheeting to ensure that it was not matted down under the weight of the soil. If matting has occurred, take the time to brush it with a branch to return it to its natural state.
- As time passes, continually check the vegetation and soil around the site to ensure that they appear natural. Loose soil often falls through small holes and results in a strange-looking, funnel-shaped hole. Check vegetation to ensure it blends with the surrounding area. Remove or replace dead vegetation.

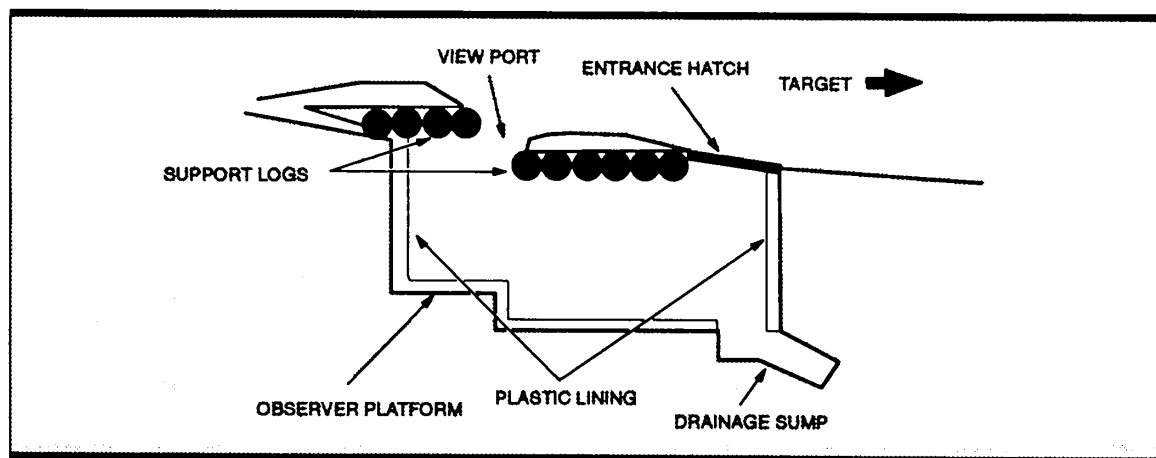

Figure A-7. Underground observation site plan.

Vegetation. When applying the B in the BLUES acronym to the SR site, remember vegetation is critical. Replanting and watering vegetation during initial site construction can eliminate the need to continually replace wilted plants.

Grasses. When removing topsoil, save the grass. Remove the grass in clumps by cutting a circle about 5 to 15 centimeters around the section to be saved with an entrenching tool or shovel, then pry the roots and soil up from the bottom. When replacing the grass around the site, pattern the placement after the natural design. Shake the grass slightly to loosen the roots, then replace at ground level. If water is available, a small amount placed on the grass will lessen the shock of replanting and extend the life of the camouflage.

Plants and bushes. Medium-sized plants or bushes will aid the security of the site. Not only will the plants add to the camouflage of the site, but they will also discourage vehicle and foot movements over the top of the site. The main disadvantage to using plants on top of the site is that the plants may die or fall over due to the shallow depth of the overhead cover. Also, if close quarters battle develops between a member of the SFOD moving outside the site and a threat element, the threat may take cover behind the plant and thus discover the actual location of the site.

Deadfall. Deadfall can restrict movement in much the same way as the plants and bushes discussed above. However, the use of deadfall as part of the overall camouflage effort presents several disadvantages. The main disadvantage is that in most regions of the world, deadfall is used for home heating, cooking, and construction. If the site has this fuel near it, the risk of discovery is increased. The SFOD members have limited options available to them if discovered by a — nonhostile civilian: emergency exfiltration or activation of the E&E plan. Either course of action will result in the mission being terminated. Cover from small arms fire is very limited when using deadfall. Most trees rot quickly when on the ground. Modern small arms fire will easily pass through these rotten trees. For this reason, the SFOD avoids using deadfall for cover. If it must be used, it is reinforced with dirt.

Sidewall Support. Depending on the soil condition in the AO, the sidewall of the site may require some type of shoring or support to prevent cave-ins. The SFOD can use a variety of material for support of the walls. Local timber, branches, deadfall, plastic sheeting, and ponchos all work well. However, the primary means for supporting the sides is by using sandbags. These lightweight bags serve a variety of uses and conform to almost any shape required. The exact number of bags required depends on the size and overall design of the site. The SFOD determines this variable by practicing the construction of the proposed site. After the SFOD has tested the design and determined the number of required bags, it figures a 10 percent overage into the packing list. The few extra bags add flexibility for unforeseen factors such as replacements for damaged bags. The bags can also be used for transportation purposes. When cross bracing sandbagged walls, the SFOD must use freshly cut green timber or something prefabricated, such as PVC pipe, conduit, or other like items. Examples of cross bracing and revetments can be found in FM 5-34.

Observation Site Kits. When possible, the SFOD assembles prefabricated kits to aid in the construction of the required site. These kits need not be taken into the

operational area but are assembled as a stockpile. This stockpile can then be drawn upon for mission-specific equipment during isolation. Some of the items in these kits are—

- Schedule 80 PVC pipe, elbows, straight connectors, 3- and 4-way connectors, and PVC cement. This strong, lightweight material can be formed into a multitude of shapes and designs. It can be used to form the frame of the overhead cover or to form cross bracing.
- Parachute suspension line. This material serves many uses. It can also be interwoven to produce a frame for overhead cover.
- Sandbags.
- Assorted tapes, cords, and ropes.
- Plastic Zip-Lot bags. These items can be used for general storage.
- 0.5-meter x 0.5-meter squares of 1-centimeter plywood. This lightweight material is excellent for constructing overhead cover, platforms for use in trees, and insulation when operating on ice and snow. The squares are painted to match the terrain in which they are used.
- Plastic sheeting. Heavy-gauge plastic sheeting fills many roles. If plastic sheeting is not available, the heavy-duty plastic bags used to cover pallets work well.
- Hand tools. (D-handle shovels, hack saws, hammers, small bow saws, and like items.)
- Plastic or aluminum tent stakes. These items save time during construction of the site.
- Canvas and camouflage netting.
- Plastic buckets with formaldehyde.
- Mirrors or periscopes.

COMMUNICATIONS SITE

Like the observation and surveillance site, the communications site can be a fixed position or part of a patrol. If the communications site is to be a fixed position, the SFOD may select and construct it in the same basic fashion as it does an observation and surveillance site. This site provides HP, satellite, and other types of communications between the SFOD and its SFOB. Conducting SR communications between the SFOD and its supporting SFOB is critical. SFODs are required to pass timely information to the SFOB and to receive instructions and information. Communications between the communications site and outlying sites may be by buried wire, low-power FM radios with directional antennas, or messenger. Based on METT-T factors, a communications site is routinely separate for technical and security reasons. The advantages of a separate communications site are the reduced risk of detection of direction and location through radio direction finding (DF) and reduced number of personnel at any one location. The disadvantage of a separate communications site is the increased risk of detecting messengers moving between sites (Figure A-8, page A-16).

SURVEILLANCE SITE OCCUPATION

Occupation of the surveillance site is basically the same as an occupation of a patrol base (see TC 31-29 for information on patrol bases). The main difference is that the main body of the SFOD may not occupy the site. Part of the element may remain in the ORP and establish communications, cover the route taken into the ORP, or gather the local material needed to construct the site. The primary or first shift of observers moves to the selected site only after the SFOD leader has established security. After an appropriate listening halt has detected no activity in the area, SFOD members may begin work on the site. After the construction is completed, all SFOD members should know the exact location of the site, routes to and from the site, and time of shift changes. Before the SFOD leader returns to the ORP, he reviews the completed site from the threat side to ensure the site is completely camouflaged. He then obscures all signs of occupation as he and the security element return to the ORP.

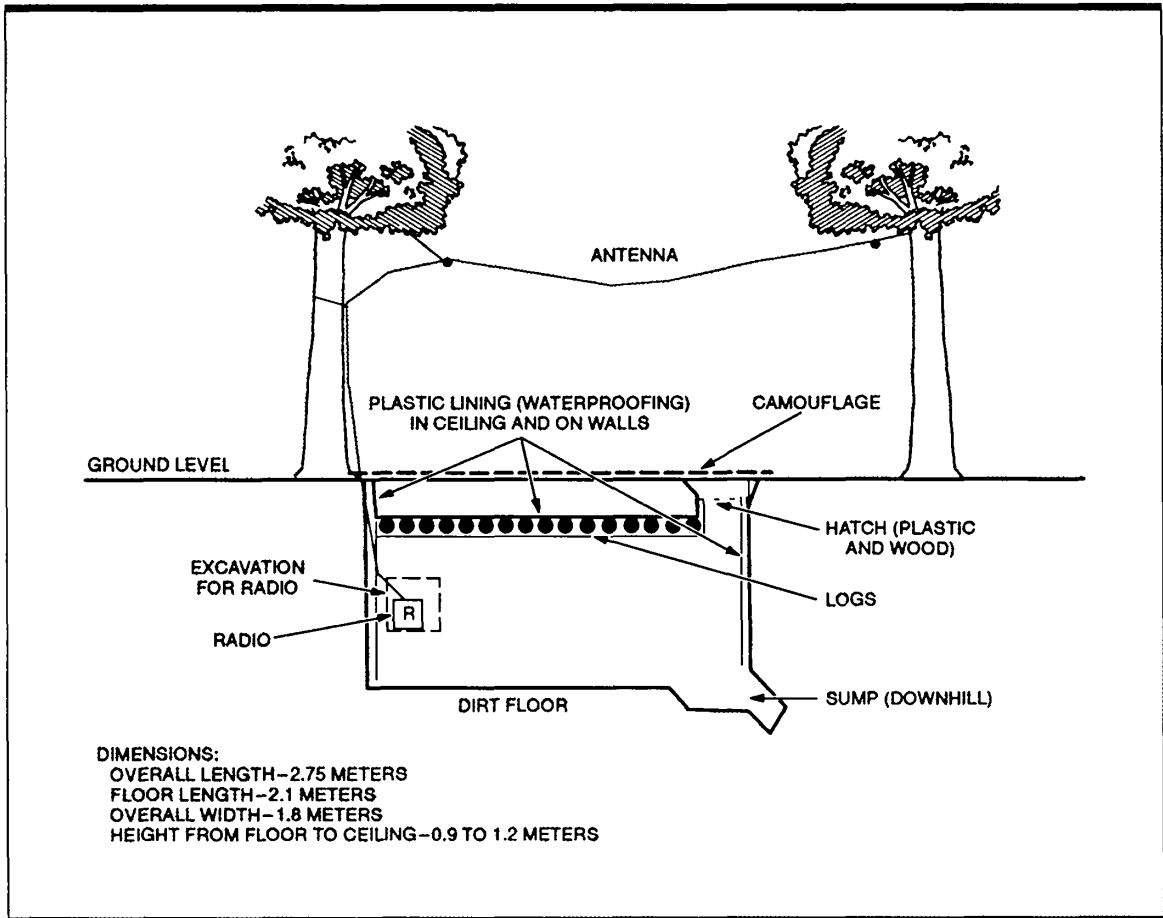

Figure A-8. Communications site.

Emerging Missions	2-23
Combat Patrolling	2-24
CHAPTER 3. Employment	3-1
Area Assessments	3-1
Target Acquisition	3-2
Hydrographic Reconnaissance	3-2
Meteorological Reconnaissance	3-10
Geographic Reconnaissance	3-10
Poststrike Reconnaissance	3-10
Target Analysis	3-13
Nuclear, Biological, and Chemical Reconnaissance	3-19
Specific Information and Other Collection Requirements	3-21
Incidental Information Collection	3-23
CHAPTER 4. Postmission Activities	4-1
Mission Debriefing	4-1
Follow-On Missions	4-4
Written Reports	4-4
APPENDIX A. Fixed Observation and Surveillance Sites	A-1
APPENDIX B. Reconnaissance Methods	B-1
APPENDIX C. Operational Techniques	C-1
APPENDIX D. Reports and Formats	D-1
APPENDIX E. Nuclear, Biological, and Chemical Reconnaissance	E-1
APPENDIX F. Special Operations Legal Considerations	F-1
APPENDIX G. Command and Control Element	G-1
APPENDIX H. Mission-Specific Clothing and Equipment	H-1
APPENDIX I. Explosives and Munitions Safety	I-1
GLOSSARY	Glossary-1
REFERENCES	References-1
INDEX	Index-1