

Alternator Secrets

Copyright 1977, 1986 Lindsay Publications Inc
PO Box 12, Bradley IL 60915

INTRODUCTION

In the last two decades alternators have replaced generators in motor vehicles. The reasons are many: output current can be produced at lower rpm, voltage can be more accurately controlled with solid state regulators, alternators need less maintenance, and they cost less to manufacture.

When modified, auto alternators can provide variable direct current at 0 to 120 volts for battery charging, hot charging, light arc welding, or for running AC-DC appliances and lights. Another simple modification provides AC power to run some transformer-operated appliances. If you know the secrets of its operation and the modifications possible, the small low-cost alternator can become a versatile power plant.

BASIC CONSTRUCTION

The old-fashioned generator contains a wound stator which produces a constant magnetic field in which a revolving coil of wire, called an armature, turns. A commutator on one end of the armature made up of many individual brass segments passes the generated current to the outside world through carbon brushes.

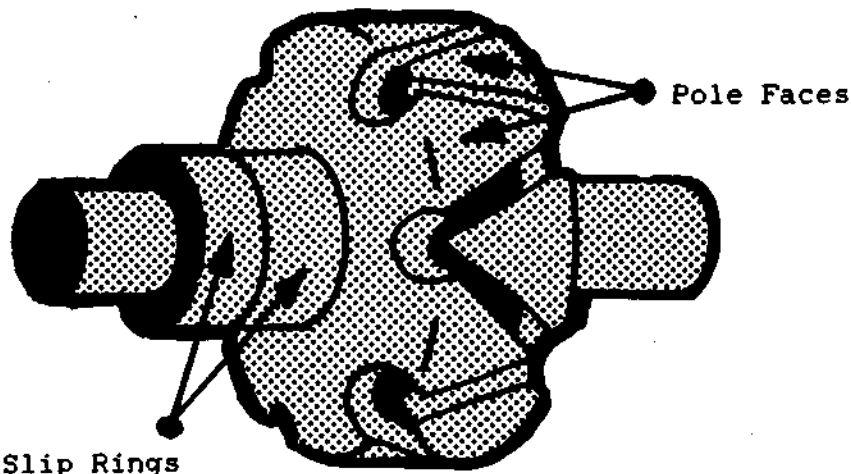

TYPICAL ALTERNATOR ROTOR

Because commutator segments must be electrically insulated from one another, they can not be fabricated from a single block of metal. Each commutator segment must be individually attached to the armature shaft. This is a source of mechanical weakness. When the armature is rotated at high RPM, centrifugal force can cause the commutator to explode, throwing segments in all directions.

To prevent explosions, the generator is usually driven at less than engine speed. An auto engine may turn 5000 RPM, but the generator must be geared to a maximum 2500 rpm for safety's

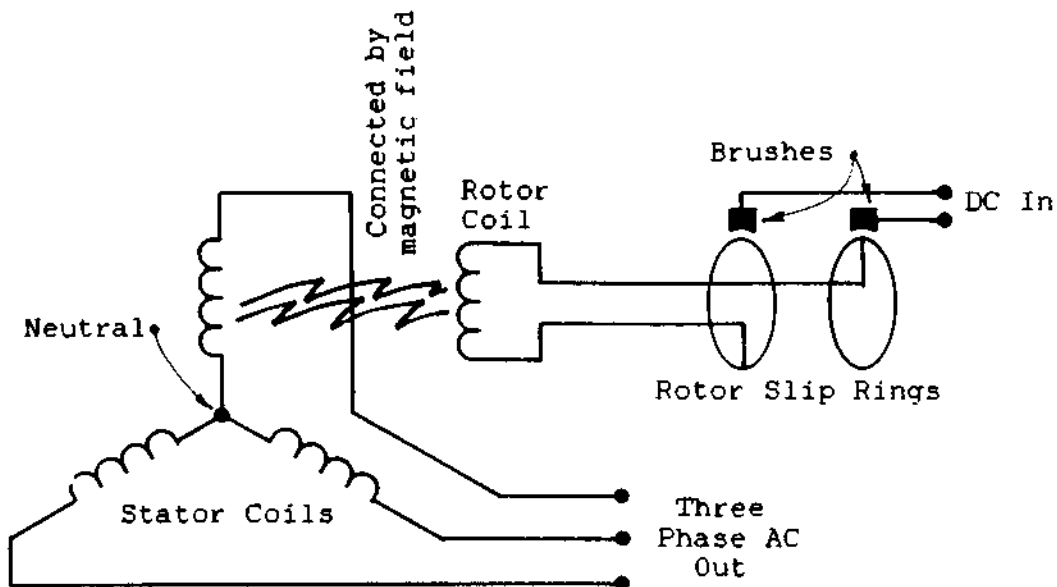

ELECTRICAL SCHEMATIC OF
A TYPICAL ALTERNATOR

sake. As a result, the generator turns so slowly at low engine rpm that it produces little or no current.

A modern alternator, like the generator, contains both moving and stationary coils of wire. In the alternator, however, the moving coil, called the rotor, uses current supplied through slip rings to generate a moving field. Power is extracted from the stationary field coils.

Slip rings replace the weak generator commutator. The rotor coils themselves are encased in a strong soft iron shell making the whole assembly much stronger than the generator armature. The net result is that alternators can be driven to much higher speeds without danger of explosion. In fact, alternators are usually driven at up to twice engine speed some running at 8000 rpm or more. At low engine rpm the geared up alternator turns much faster than a comparable geared down generator. The net result is that the alternator can begin producing useful charging current at lower engine rpm than can the generator.



SOLID STATE DIODE

A coil of wire rotating in a magnetic field produces an alternating current with a frequency dependent on how fast the coil turns, one cycle being produced per revolution. A generator armature uses a commutator to mechanically switch rotating windings in and out of automobile's electrical system to produce direct current.

The three separate stationary windings of the typical auto alternator produce three-phase alternating current. Rather than use a commutator to mechanically convert AC to DC, the alternator uses six diodes in a full-wave bridge rectifier circuit. In essence the diodes are solid state switches with no moving parts, making them maintenance-free and explosion proof.

The alternator output voltage can be controlled or regulated by varying the rotor current. Regulators sample the output voltage and automatically change the intensity of the rotating magnetic field by adjusting the current fed to the rotor through the slip rings. The adjustments are made in such a way so as to bring the output voltage to the desired level.

THREE-PHASE POWER

Surprisingly, alternators are constructed with three sets of field windings positioned evenly at 120 degree intervals inside the frame. Such construction produces three-phase AC. But why three-phase?

If we look at the effect of diodes on a single-phase AC current, we see that the output is a series of DC pulses. True direct current is completely smooth. The output of the diodes (rectified AC) is bumpy, and is said to possess ripple.

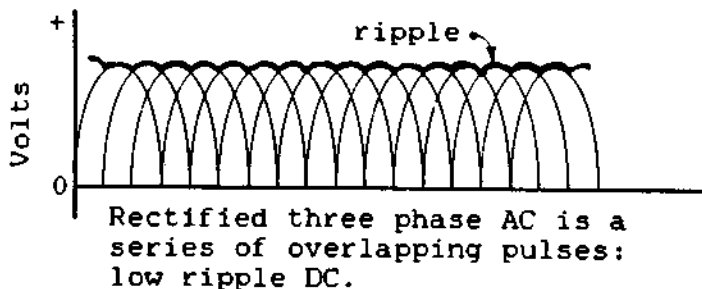
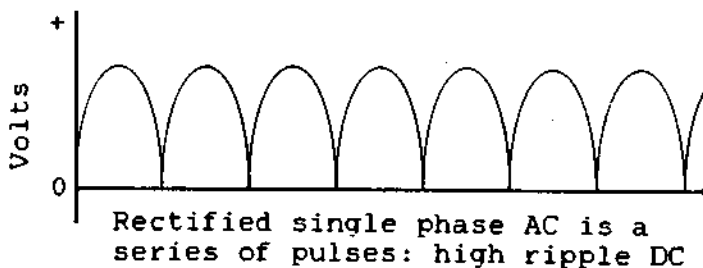
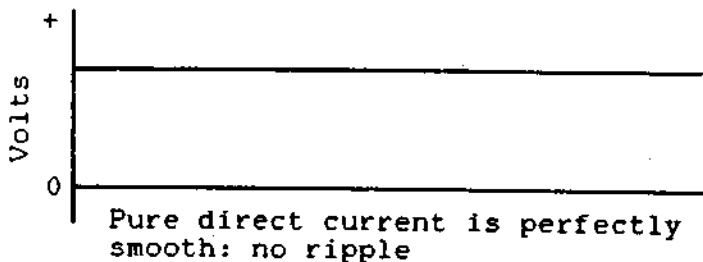

When the rectified DC from each of the three-phase windings is added together or superimposed, the peaks overlap to produce a much cleaner DC with much less ripple. Lead-acid auto batteries last longer when charged with pure DC than high ripple rectified DC. Generators may be a mechanical and electrical nightmare, but they put out very clean DC. Three-phase windings were designed into alternators to produce DC of great purity.

Many alternators connect one lead of winding to a common point called a neutral. The other lead of each winding is connected to a pair of diodes. Three windings each using two diodes accounts for the six diodes found on most alternators.

Newer alternators particularly high current models, use two additional diodes on the neutral connection to sample alternator output voltage for use by the regulator.

In the future internal mechanical construction, electrical circuits, regulator operation and physical location will probably change somewhat. But basic alternator theory will not change. The exact details for the alternator you have can usually be found in a standard auto repair manual such as Motor's or Chilton's. Often you'll get instructions on dismantling and repairing alterators as well.

The diagrams in this booklet are general and should

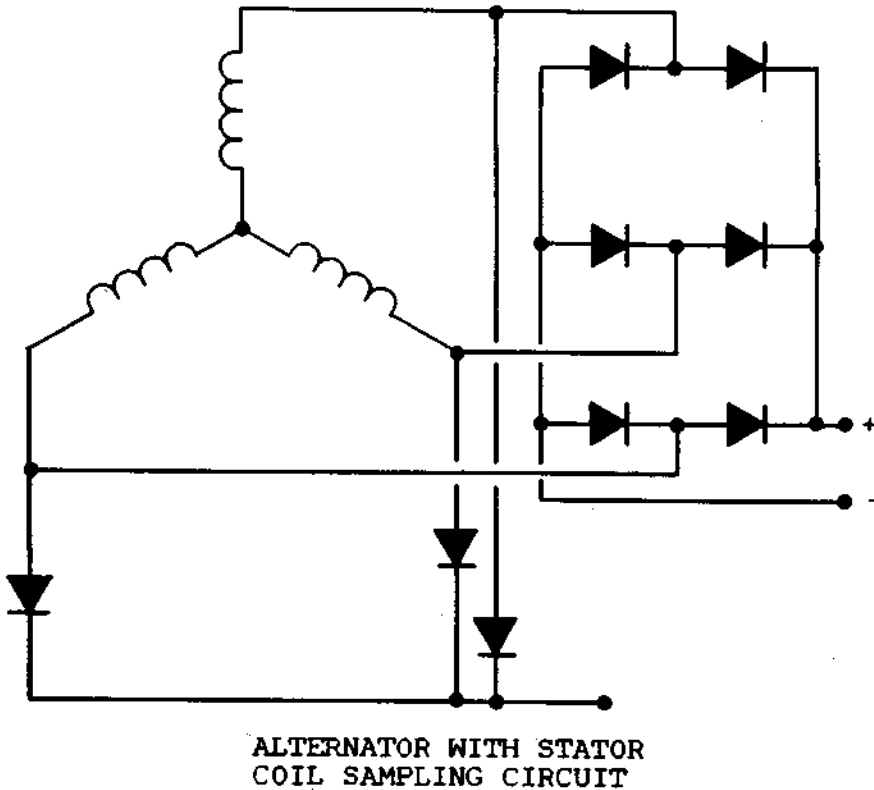
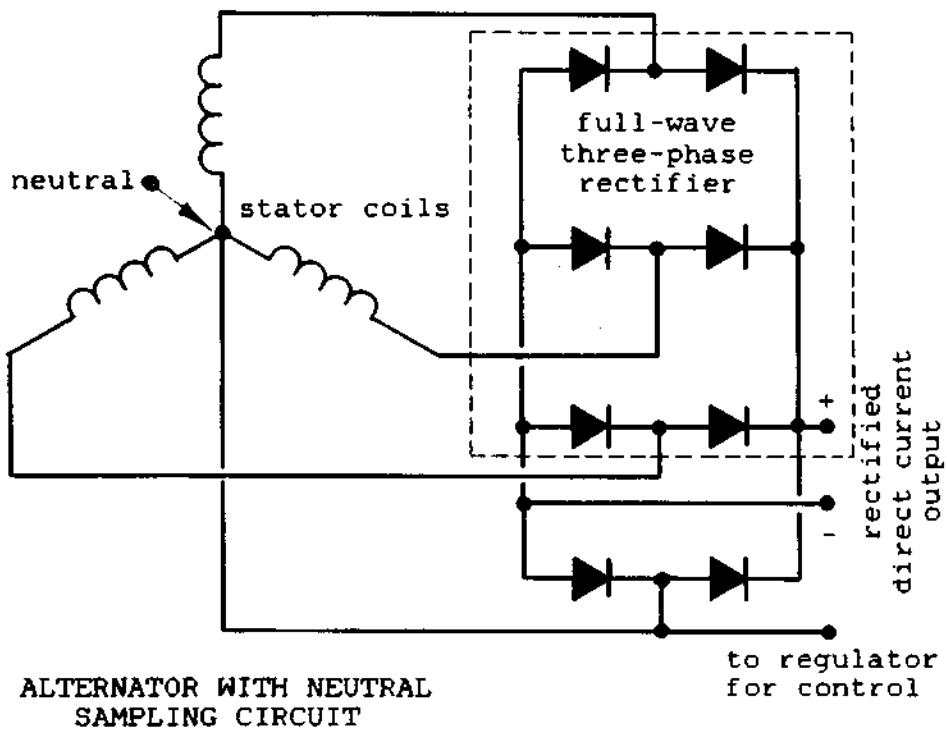

apply to all alternators. Again, refer to a recent auto manual for details on your particular alternator should you have problems.

REGULATORS

Early alternators used relays to regulate their output voltage much like those used on generators. When lower cost, more reliable solid state devices became available, electronic regulators became standard.

Although most regulators are factory set to force an alternator to produce 12 to 14 volts, they can be modified or new regulators custom built to provide almost any voltage up to 130 volts once their operation is understood.

If we were to run an alternator at some fixed rpm, we would find that changing the intensity of the rotating magnetic field would change the output voltage of the alternator. We can change that magnetic field by changing the amount of current flowing through the slip rings into the rotor. Since the resistance of the rotor windings is constant, merely changing the input voltage to the rotor will change the current flowing into the rotor by a proportionate amount.

Suppose we have alternator spinning at 2000 rpm. We have it attached to some electrical load drawing say 10 amps at 12 volts. Let's assume that the rotor is using 1 amp at 4 volts. Suppose we increase the electrical load so that we now need 15 amps. Due to internal electrical resistance of the whole system, the voltage falls to 11 volts. To get the output voltage back up to 12 volts we must increase the rotor magnetic field intensity. So we adjust the rotor voltage up to 6 volts, and in doing so, we find the rotor now drawing 1.5 amps of current. This increased current results in increase magnetic field which at 2000 rpm gives us an output of 15 amps at 12 volts. It is the job of the regulator to make these adjustments, quickly and automatically.

Let's suppose that we set the rotor current at its maximum value, say 3 amps at 12 volts, and varying the rpm. At low rpm, the output voltage might be only five volts. As the rpm comes up, the output voltage would hit 12 volts then 25, then 50, and at top end, over 100 volts. Alternators can sometimes put out 140 volts when driven at top rpm.

As you can imagine, when the alternator is running at low rpm, the alternator is putting maximum voltage and current into the rotor so that the alternator output voltage will come up to 12 volts. When the rpm starts to pick up so that the voltage starts to climb above 12, the regulator starts cutting back the voltage and current into the rotor. At very high rpm, the regulator is supplying the rotor with very little current, so that the output voltage remains at a constant 12 volts.

An electronic regulator provides continuous and instantaneous adjustment of rotor current by sampling the alternator output voltage and by comparing it against a internal standard reference. When output falls, a small current is sent to transistor B which amplifies it and sends it to transistor A which acts as a valve in controlling the heavy current flow from the battery to the rotor.

Input voltage to the regulator is usually a steady 12 volts whereas output to the rotor varies from zero to 12 volts to control rotor current. Many rotors have a winding resistance of about 3 or 4 ohms, which causes a current of 3 to 4 amps to flow at 12 volts (calculated with Ohm's law)..

Suppose that to get 12 volts out of an alternator we need to pump 2 amps of direct current into the alternator's rotor which has an internal resistance of 3 ohms. What would the rotor voltage have to be? We can calculate it with Ohm's law:

$$\begin{aligned} \text{volts} &= \text{amps} \times \text{ohms} \\ &= 2 \quad \times 3 \\ &= 6 \end{aligned}$$

The regulator passes 2 amps but has to eat up the difference between supply voltage, 12 volts, and rotor voltage, 6 volts or 6 volts. How much power is this? We can do another simple calculation:

watts = amps x volts

= 2 amps rotor current x 6 volts difference

= 12

This 12 watts of power is turned into heat, and if the regulator is to be kept cool and working properly, it must have heat-dissipating fins or should be mounted to a large heat sink such as a fender or firewall where destructive heat can be carried away.

Regulators use Zener diodes to provide a stable reference voltage. A voltage divider - the three resistors labeled C - extracts a preset fraction of the voltage for comparison against the Zener. For example, a regulator might have a 6 volt Zener in its circuit. To provide a regulated 12 volts, the resistive voltage divider is set to extract 1/2 of the sample voltage. When 12 volts is produced, half of 12, or six, is compared against the 6 volt Zener. They are equal; no change is made in rotor current. If output voltage falls to 8, the Zener is compared to 1/2 of 8, or 4 volts, and the regulator output current is increased to compensate. If output rises above 12, the regulator transistor is shut down enough to bring the output voltage back down.

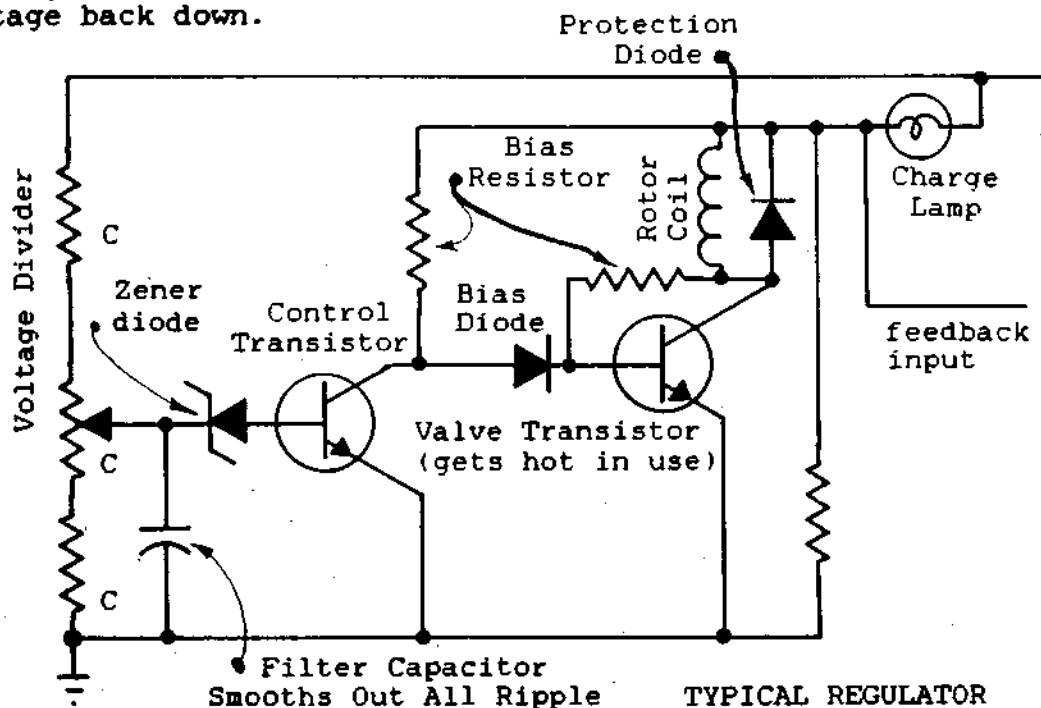

Electronic regulators are superior to the old triple relay regulators used on generators. Obviously, there are no contacts to burn. While the older regulators would click in and out at the rate needed to hold output fairly steady, the solid-state regulators provides smooth quiet service, providing small continuous changes in rotor current. As long as the electronic unit kept cool, it should never need any service.

Alternator rotors are usually very rugged. Specially shaped poles create multiple magnetic poles from a single rotor winding. For instance, some Delco alternator have 8 alternating pairs of poles folded back from either end. With a single revolution of the rotor, the stator windings are hit with eight magnetic fields, producing eight cycles of alternating current. This is probably done to increase alternator output at very low rpm with limited rotor current. At normal running speeds the frequency of the alternating current fed to the diodes is usually several hundred cycles per second in frequency ---

HUNDREDS --- anything but the 60 cycles you get from a wall outlet.

Again, alternators are exceptionally strong allowing them to be overdriven at high rpm. They will produce usable current at lower rpm, and high voltage at high rpm if the rotor current is turned to maximum. High frequency three-phase AC is fed to solid state diodes to produce low ripple DC.

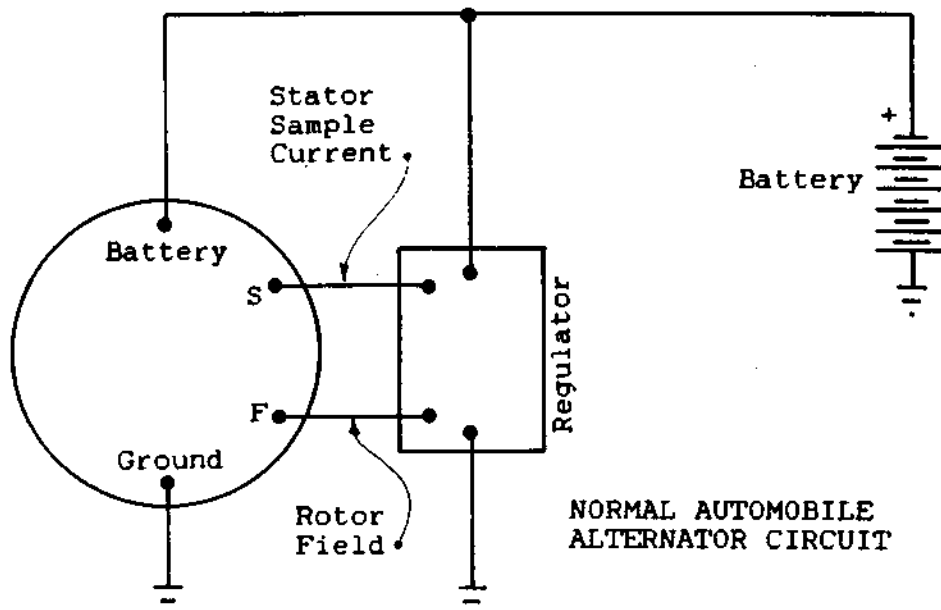

MODIFICATIONS

You'll see ads in many magazines promoting a simple device which when added to an auto alternator will allow you to get 3000 watts of DC to run AC-DC type appliances such as power drills, saws, and lights. This so-called wonder has been sold at prices from a few dollars to more than \$25. You can build one for a couple dollars.

The secret of this magical little box is extremely simple. A switch puts bypasses the regulator putting 12 volts into the alternator rotor while transferring the alternator output from the auto circuit to an outlet installed in the box. When the auto engine rpm is increased, the voltage comes up to 120 volts. The device, therefore is nothing more than a switch and an outlet.

As we just discussed, alternator output voltage increases as the rpm goes up. It is the job of the regulator to cut back rotor current as rpm increases so that alternator output voltage stays at a constant 12 to 14 volts. The switch in the wonder box prevents the regulator from doing its job. As rpm increases so does the alternator output voltage. Some of the more expensive boxes have a volt meter to monitor voltage.

The diodes, also called rectifiers, are solid state devices which have low internal resistance --- that is, they eat up very little of the current flowing through them. These days solid state diodes are easy to build and therefore, low cost.

Diodes have two ratings: PIV and amperage. Amperage rating tells you how much current the diode can handle continuously. All diodes have some resistance, and at high current levels some power is converted to heat by this resistance. The ability to get rid of the waste heat determines how much current the diodes can handle. Remember, waste heat is determined by the current flowing. It has nothing to do whatsoever with voltage.

PIV, peak inverse volts, tells you how much voltage the diode can withstand before its internal insulation breaks down.

A diode rated at 100 PIV can be used in circuits to 100 volts. A voltage of 200 volts at a tiny fraction of an amp for even a thousandth of a second (a voltage spike) can destroy the diode.

It's usually a good idea to overrate diodes. If you want a diode to handle 10 amps at 100 volts, it would be wise to use a diode rated at 15 amps and 200 PIV. Diodes used on modern alternators can usually handle the high voltage. It is entirely possible, however, that in bringing the alternator voltage up that you could blow the diodes in the alternator. This means having to replace the diodes. They're not expensive, but it can be a hassle pressing out old diodes and putting in new ones. Refer to an auto manual for detailed information.

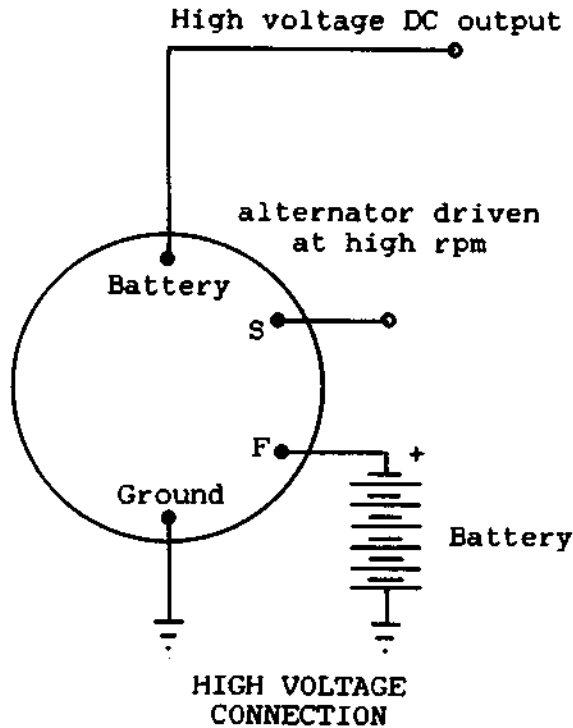

If we have a 30 amp alternator and we've revved it up to get 120 volts we can calculate the power available:

$$\begin{aligned}
 \text{watts} &= \text{volts} \times \text{amps} \\
 &= 120 \times 30 \\
 &= 3600
 \end{aligned}$$

The \$25.00 control box that you must buy (so the ads say) consists of a four-pole double-throw switch, a 30 amp fuse, an outlet, and an optional 0-150 volt DC meter. Throwing the switch puts 12 volts into the alternator rotor through one set of contacts, cuts the regulator out of the circuit, and switches the alternator output from the auto electrical system through a 30 amp fuse to a standard outlet. A meter can be connected across the outlet to show how fast the engine must turn to give 120 volts.

When producing the higher voltage, the battery supplies 3 to 4 amps to the alternator but receives no charge in return. Even with this drain, the unit can be run for many hours before the battery comes noticeably discharged. But remember! You cannot run the system this way indefinitely. An 80 amp-hour battery would become fully discharged in 20 hours with a 4 amp draw. At some point you'll have to switch back to normal operation to recharge the battery. And! Auto batteries can be seriously damaged if allowed to become fully discharged.

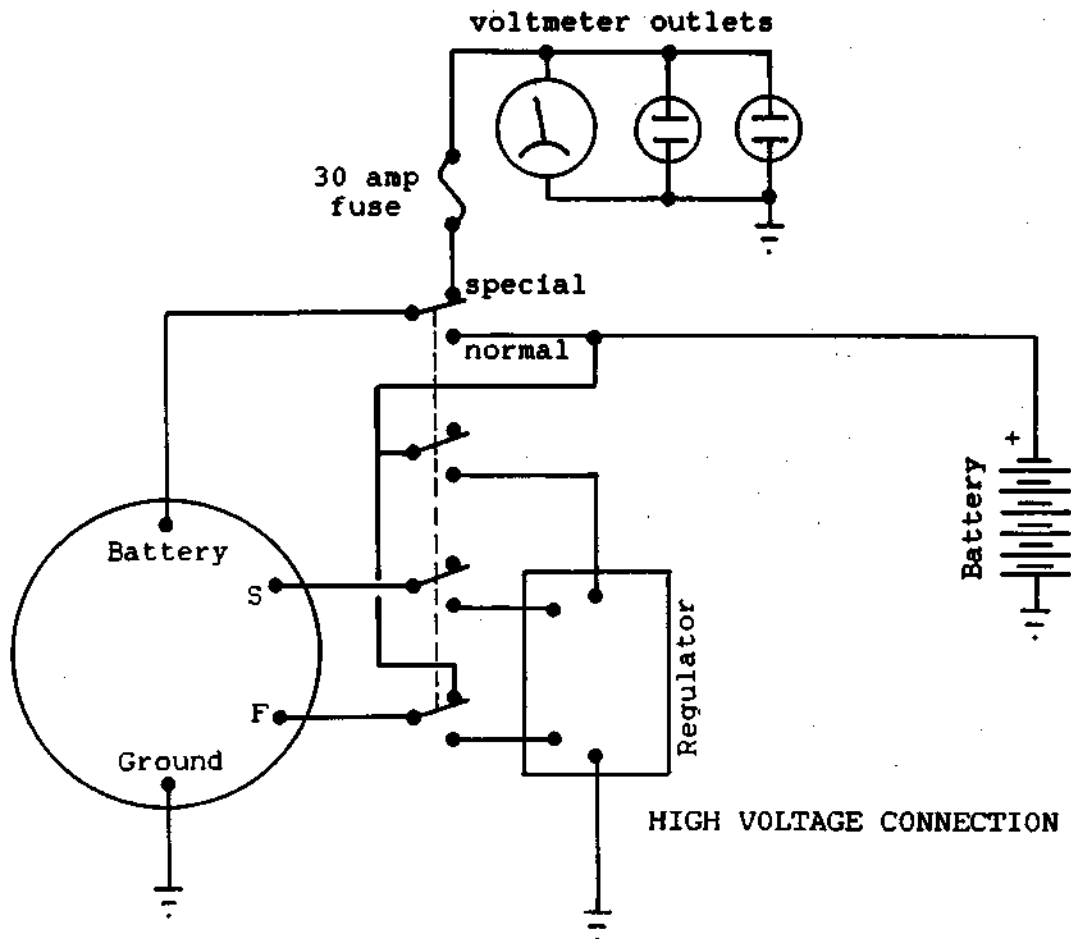

Suppose we're producing 3600 watts. Since 746 watts equals one horsepower, it's a simple matter to calculate the mechanical power needed:

$$\begin{aligned}
 \text{horsepower} &= \text{watts} / 746 \\
 &= 3600 / 746 \\
 &= 4.8
 \end{aligned}$$

By the time you add power lost in bearings and fan windage, you'll probably need 5 1/2 horsepower.

Revving up an auto engine just to produce 5 horsepower is wasteful. Many people have found that a small power plant can be built from a 5 to 8 horsepower engine, an alternator, a regulator, a motorcycle battery, switches, etc. The engine's governor can be set to hold a steady rpm, and for longer periods of use, this small powerplant should use less gas since it is running closer to full load.

When building a powerplant, it is advisable to get an alternator from a large late-model air-conditioned automobile. Many of these units can produce 50 to 60 amps which can be used for light arc-welding. It is best to include a 0-60 ammeter in your power plant circuit to be sure you come close to but do not exceed the alternator's capacity. While it is possible to burn out the alternator windings, the diodes usually melt first.

Since gas engines seldom run above 3500 RPM and since an alternator must turn about 5000 RPM to produce 120 volts, the unit must be geared up. Putting a larger pulley on the engine will achieve a gearup whose ratio is proportional to the ratio of the pulley diameters. For instance, an engine running at 2600

RPM must be geared to run the alternator at 5200 RPM; We need to gear the alternator up by

$$\begin{array}{r} 5200 \\ \text{----} = 2 \\ 2600 \end{array}$$

a factor of 2. Therefore, the pulley on the engine should be twice the diameter as the pulley on the alternator.

The whole powerplant can be built on a plywood base, and if a motorcycle battery is used to save weight, the unit can be quite small and easily portable. When the unit is producing the higher voltages, the battery provides the necessary rotor current. After a few hours of operation, it is advisable to throw the regulator back into the circuit and recharge the battery.

With simple modifications it is possible to use an alternator to charge 12 volt batteries, hot charge batteries at 30 to 40 volts and high current, arc-weld at 50 to 60 volts, and run AC-DC appliances at 120 volts.

SPECIAL REGULATORS

You may be interested in using an alternator to convert wind or water power to electricity. In such systems it is common practice to charge a bank of storage batteries, so that power is available even when the wind isn't blowing, or water levels are low.

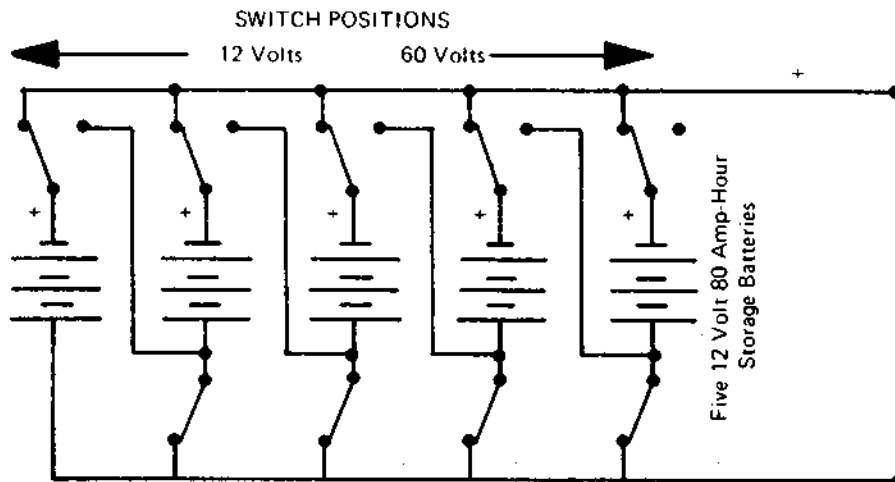

This arrangement allows five storage batteries to be charged as a single 60 volt 80 amp-hour battery, but provides 12 volt 400 Amp-hour to drive inverters or appliances. Knife switches should be used to switch the bank. All switches should be brought to the open position, and then all switches should be moved to their new position. Most toggle switches will not work because they have no neutral position, and cannot handle heavy currents.

Most of these systems use a standard 12 volt system which works well for average service, but seldom allows conversion of large amounts of available rotational energy.

Suppose, for example, our windmill, waterwheel, or treadmill provides one horsepower of mechanical power to our 60 amp alternator. At 12 volts and 60 amps we get 720 watts out -- almost one horsepower.

Now suppose that more energy is available because of high winds or higher water head. The mill or wheel can now provide two horsepower, but because we cannot exceed 60 amps out without overheating windings or popping diodes, we can only

provide the maximum 720 watts at 12 volts. The additional horsepower is available, but not convertible.

Most storage banks are built from many batteries in parallel to provide 12 volts with at least 200 amp-hour capacity. Suppose that for those periods of high wind or water, that the batteries are connected into a 36 volt battery pack and that the alternator is regulated by a special 36 volt regulator. Suppose, too, that we run the current all the way up to 60 amps output. Now we are converting 36 volts X 60 amps, or 2160 watts -- almost 3 horsepower. If the voltage could be run up to 120 volts, total watts at 60 amps would be 7200, ten times that available at 12 volts from the very same alternator.

At first impression you might think that the alternator could never handle it, but it can. Voltage is limited by the thickness of insulation on the windings and breakdown (PIV--peak inverse volts) voltage of the diodes. Current through the windings and diodes produces heat. As long as the manufacturer's rated maximum current is not exceeded, the windings and diodes will not overheat and melt. If you can provide the mechanical power at an excess of 5000 shaft RPM, you can extract the 7200 watts without electrical damage. REMEMBER! The waste heat generated in both the diodes and windings is proportional to the current being produced whether it be at 12 or 120 volts.

Mechanical damage is another consideration. Since 7200 watts is almost 10 horsepower, we must question the ability of the alternator bearings to handle this much power.

At this power level, V-belt drive will not work for two reasons. First, the usual auto fanbelt is too small to handle the strain of 10 horsepower. It would snap under the tension. Second, V-belts require much friction on the sides of the pulley to transfer power, and this means the bearings are heavily loaded with a pull to one side. At 10 horsepower, they would probably wear out in a hurry. For these high power levels you'll have to consider chain and sprocket drive which can handle the higher power levels more efficiently with much less bearing loading.

High voltage regulators can be built with little difficulty. If it were not for the fact that most auto regulators are sealed, they could be simply modified. Nevertheless, the regulator circuits used on low-voltage hobbyist power supplies will do the job. Schematics can be found in the electronics

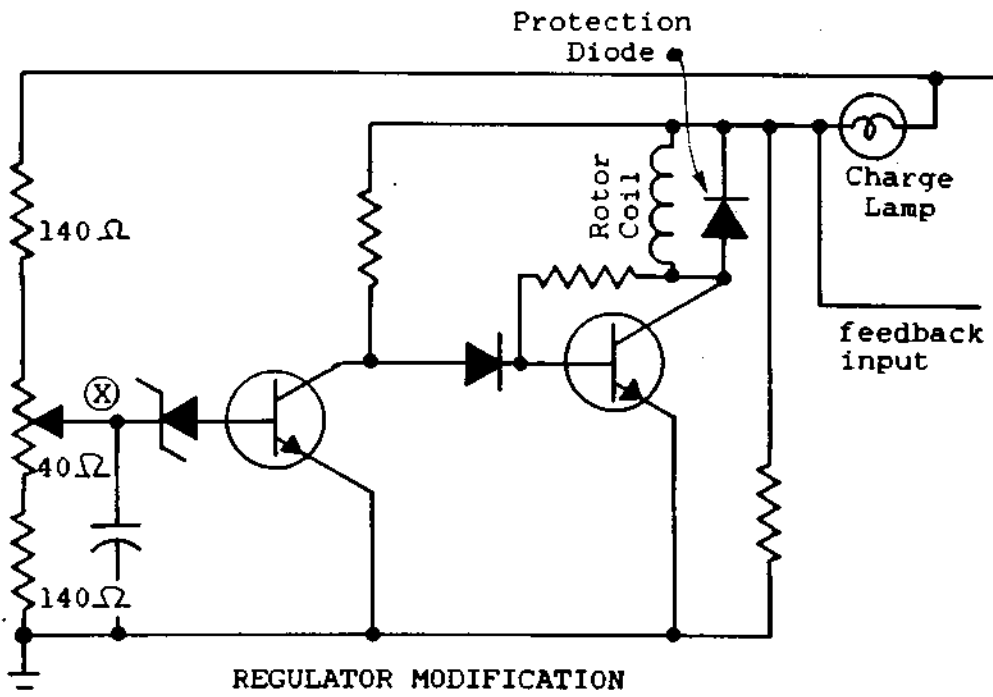

magazines, Radio Amateur's Handbook, and books on electronic power supplies. The basic design has been around for years.

In the typical regulator circuit shown, the resistors A, B and C make up a circuit called a voltage divider. Its function is to extract a fraction of the alternator output voltage and compare it against an internal voltage reference.

From ground to the high side in the diagram we have 140 + 40 + 140 ohms or 320 ohms total. If we assume that variable resistor B is set to 20 ohms, we see that from ground to line X we have 140 + 20 ohms or 160 ohms. Therefore, on line X we will see 160/320 or 1/2 of the high side voltage. In other words, if the high side had 12 volts on it, measured from ground, we would see 6 volts on line X measured from ground. Moving the variable resistor arm closer to ground would lower the voltage on line X. The variable resistor selects the exact fraction or percentage of voltage that is to be compared with the internal reference.

Let's suppose the Zener diode, our internal reference, produces 6 volts. And let's assume that our voltage divider is set at 50%. When the high side is at 12 volts, the divider takes 50% or half, 6 volts and compares with the Zener. Since the Zener is at 6 volts, there is no difference, and the regulator takes no action.

If high side drops to, say, 10 volts, the divider takes half or 5 volts. Now we have a one volt difference when compared to the unchanging 6 volt Zener voltage. This one volt drop causes the transistors in the rest of the circuit which act as valves to open a little more and let more current into the rotor to increase the revolving magnetic field and bring output voltage back up. This continues until the high side voltage comes back up to 12.

If output voltage goes up, much the same thing happens. The difference between the voltage sample and the Zener is of opposite polarity, so the transistors shut off to the degree necessary to force alternator voltage back down.

In practice these actions take place smoothly and continuously. Our explanation is simplified, but fairly accurate.

If you change the percentage setting of voltage divider resistors, you can change the alternator voltage. Suppose you change the divider setting so that 20% of voltage is extracted. What would the output of the alternator be? To find out divide the Zener reference voltage by the percentage:

$$\begin{aligned} \text{output volts} &= \text{zener} / \text{percentage} \\ &= 6 \text{ volts} / .20 \\ &= 30 \end{aligned}$$

The regulator will take 30 volts, extract 20% with the voltage divider which comes to 6 volts. Compared with the Zener 6 volts, no corrective action will be taken. Any change from 30 volts will create a correction voltage that cause the transistors to open or close as necessary until voltage comes back to 30.

Suppose we set the voltage divider at 80%. What output voltage would we get from the alternator?

$$\begin{aligned} \text{output volts} &= \text{zener} / \text{percentage} \\ &= 6 \text{ volts} / .80 \\ &= 7.5 \end{aligned}$$

In this case we've dropped from 12 to 7 1/2 volts.

The practical percentage ranges of voltage dividers usually run from 40% to 60%. This might translate into settings of 10 to 15 alternator output volts:

To get beyond this range we need to change the Zener and perhaps the divider range as well. Consider for a minute if we installed a 50 volt Zener diode. At 50% divider setting output voltage would be:

$$\begin{aligned} \text{output volts} &= \text{zener / percentage} \\ &= 50 / .50 \\ &= 100 \end{aligned}$$

And if we again consider a practical 40% to 60% range, the alternator could be regulated to produce a constant voltage in the 83 to 125 volt range.

The same resistors used for the 12 volt regulator could not be used in a high voltage regulator. At 120 volts, you'd be putting 10 times as much voltage across them, causing 10 times as much current to flow. Since power through a resistor is equal to the square of the current times ohms of resistance, you'd be putting 100 times more power into the resistors. In other words, they'd smoke and burn! In practice you'd probably want to increase the resistance 100 times. That would limit the current flow and power into resistors to its original value when run at 12 volts.

It is not the purpose of this manual to be a course in electronics design. The principles involved in designing and building a basic electronic regulator can be found in a great many books on electronics and power supply design. You should read up on the subject before designing a regulator.

One good book worth consulting is Regulated Power Supplies by Irving M Gottlieb, published by Howard W Sams, Indianapolis IN. There are many others.

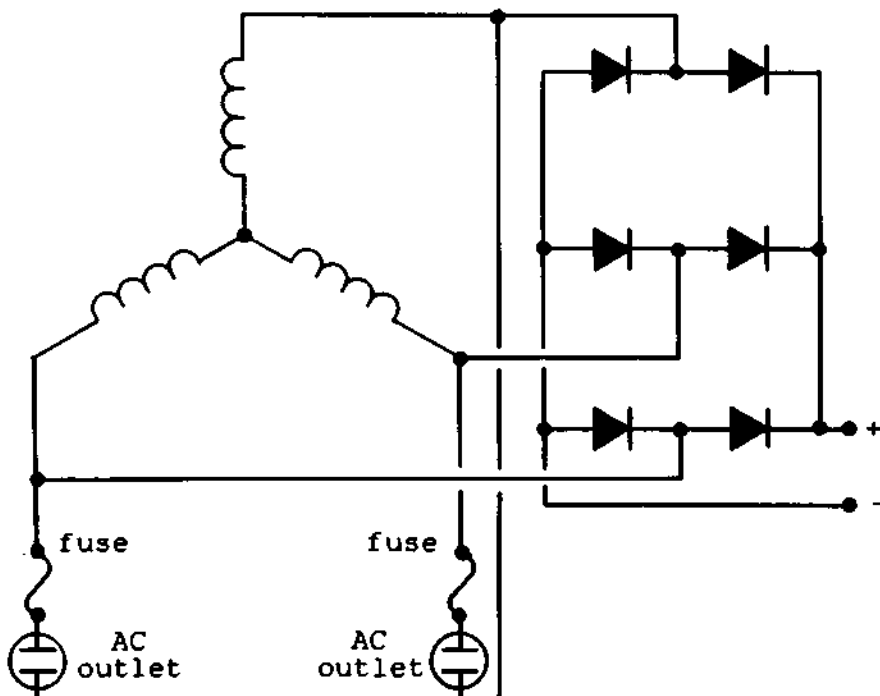

MODIFICATION TO GET AC OUTPUT

MODIFICATION FOR 110 VOLT AC

Alternators produce rectified DC power. If we tap the leads attached to the diodes, we can obtain 120 volt AC power. Some, but not all transformer operated appliances such as TV's, radio's, fluorescent lights might be possibly be run on this AC.

AC coming from the alternator is very high frequency and a great many transformers will overheat at the high frequency. The only way to tell is to plug the device in for a few seconds, unplug it, and then feel the transformer or ballast to see if it is overheating. Even this is risky. Unless you're willing to take the chances involved, you might be better off converting an induction motor to provide pure 60 cycle AC, described later on.

If you'd still like to give it a try, conversion is a simple matter of removing diodes, and connecting leads. In most alternators two wires are soldered to each of the diodes. Remove both from the diode and attach it to one of three leads. When wired as shown, two outlets with a common ground can be powered.

Forget about running motor-driven appliances unless they use universal AC-DC brush type motors. Ordinary induction motors are designed for 60 cycles AC. At different frequencies they will run at different rpm if at all, and will quite possibly overheat or be destroyed.

REWINDING THE WINDMILL USE...

Alternators usually loaf along at low RPM, and do not usually begin to produce a lot of power until they exceed about 1000 RPM. This lower RPM limit can be dropped by rewinding the alternator's stationary coils. An alternator modified in this way used on a windmill, for instance, can begin producing power at a lower windspeed, realizing greater total power output over a period of time.

For example, a 45 amp Chrysler alternator can be modified by removing each of the 16 turn coils, and by replacing them with a smaller diameter wire so that each coil is made up of more turns. Number 20 plastic coated wire (such as Belden polythermaleze) obtained from a motor shop can be used to wind coils of 25 to 26 turns before all available slot space is used. Coils are set by dipping in motor varnish and baking with low heat until hardened. Small diameter wire reduces maximum current available. Here, No. 20 will handle only about 25 amps with good cooling, but the extra windings allow the alternator to begin charging at a much lower RPM.

One good reference on motor and generator rewinding is Armature Winding and Motor Repair by Daniel Breymer available from Lindsay Publications.

BUILDING A 60 CYCLE ALTERNATOR

Theory says that any generator can be used as a motor and vice-versa. If this is so, could we take a common 1/3 hp induction washing machine motor and use it to produce 120 volts 60 cycle power? The answer is yes!

But we have two problems to solve. First, we must drive the motor faster than its nameplate rpm to get 60 cycle. Second, when we start the unit, we may have to hit the coils with a DC pulse to start it generating.

Induction motors have no physical connection between the stationary winding and the squirrel cage rotor. The electricity flowing in the rotor is created by transformer action because the magnetic field in the stator winding is revolving at 1800 rpm while the rotor is revolving at 1725 rpm. The 75 rpm

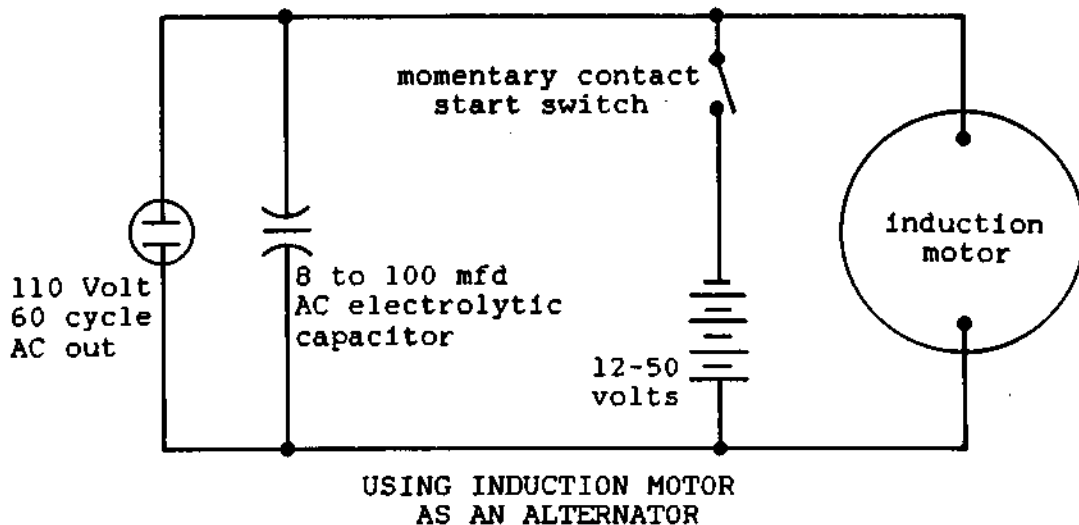

difference (4 to 5%) causes a current to be induced into the rotor.

When used as an alternator, the motor must be driven 4-5% faster than the 1800 rpm synchronous speed. This comes to about 1880 rpm, faster or slower depending on alternator loading. When the driving speed is exactly right, the alternator will be producing exactly 60 cycle power.

Some motors will begin generating power as soon as they're driven because there's a small amount of residual magnetism remaining in the rotor and windings. If generation doesn't begin by itself, you'll probably have to hit the windings with a pulse of DC current to get it started. A switch connected to a 12 volt battery will probably be adequate, although in some cases you may need as much as 60 volts to do the job.

A split-phase capacitor-run motor can be used as is. But other motors will probably need a capacitor in the 8 to 100 mfd range. Trial and error will determine the exact size. Make sure the capacitors are rated at 250 to 300 volts AC.

Not all motors will work properly, and we don't really know why. Fortunately, most do.

You won't be able to get as much power out of the motor as the nameplate indicates. To find exactly how much power you can get, connect ordinary light bulbs to your new alternator one after another. At some point the alternator will suddenly

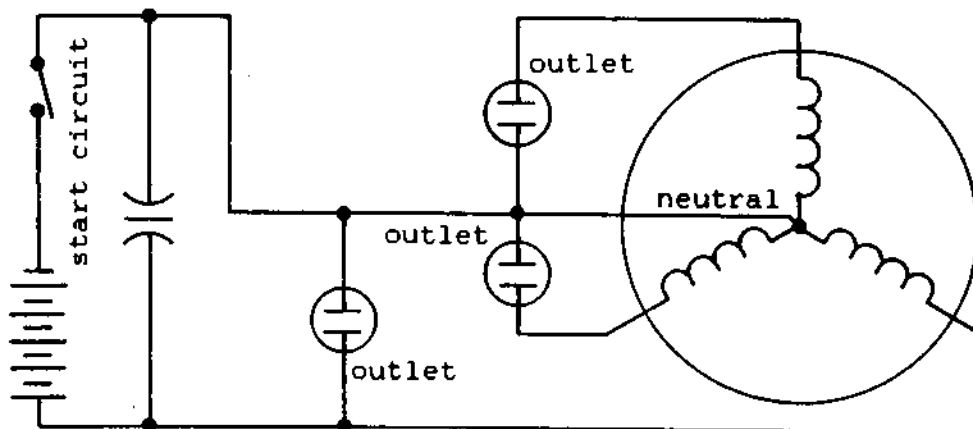

THREE PHASE STAR MOTOR WITH NEUTRAL
each outlet delivers 220 VAC at 60 Htz

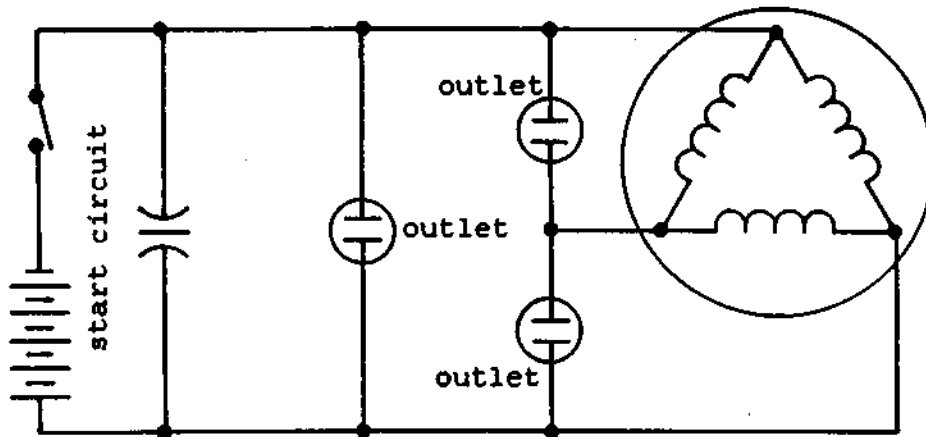

THREE PHASE DELTA MOTOR
 each outlet delivers
 208 or 220 VAC at 60 Htz

stop working, indicating that it is overloaded. This response can sometimes be a hassle, but it makes the alternator burn-out proof.

To get large amount of AC out, you will need a large motor --- over a horsepower. You may be able to find a large single phase motor on a table saw or on farm machinery. But you may have to use a three-phase motor. With a three-phase machine you'll need a capacitor across one of the legs, but not on all three. Remember though! Three-phase motors will generate power from 208 volts on up. To get 110 volts you'll have to use a large transformer to step the 208 down to 110, and that's not very practical.

The frequency of the AC out will vary as the engine rpm varies. How are you going to know when you have 60 cycle? One easy way is to use a motor driven clock. Plug it into the circuit and leave it there. It only draws a few watts. Compare the second hand with the seconds counter on a quartz wrist watch. If the motor clock is running slow, the AC is less than 60 cycle. Adjust engine rpm until the clock is keeping accurate time.

In conclusion, you can generate small amounts of 120 volt 60 cycle that will drive anything from your TV to your refrigerator using an induction motor as an alternator. It will take experimentation. When it works (which is most of the time), it works very well. It's certainly worth trying.

Rewinding Generators/ Alternators For Wind Systems

Mick Sagrillo

© 1990 Mick Sagrillo

Wind generators run at fairly slow speeds: usually 250 to 600 rpm. Most people who design their own wind systems are stymied by the unavailability of slow speed generators. They usually choose to use an off-the-shelf generator that is stepped up to operating speed from the relatively slow propeller speed of a wind generator. But stepping up with gears, chains or belts introduces large inefficiencies, not to mention more moving components that need maintenance. There is another way around this problem: rewinding the alternator or generator for slow speed operation.

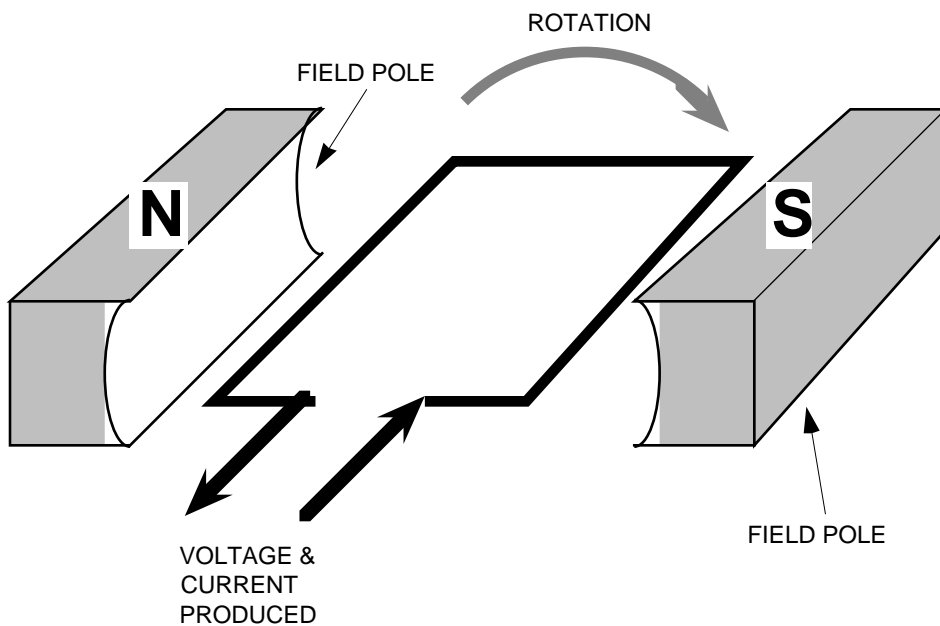

Figure 1. A generator is really wire moving within a magnetic field.

BASIC ANATOMY

In its simplest form, a generator or alternator is merely a coil of wire passing through a magnetic field, see Figure 1, above.

When our coil of wire passes through a magnetic field, voltage is induced in that coil (suffice it to say that this is something akin to magic). The voltage induced in the coil is proportional to the number of turns in that coil, the flux density of the magnetic field, and how rapidly the coil passes through the magnetic field.

The current generating coils of wire are called the armature in a generator and the stator in an alternator. The magnetic field poles are called the field in either device. In a generator, the armature rotates in the stationary field. because it is rotating, heavy-duty brushes must be used to carry the current produced from the armature. An alternator is an inside-out generator: the field, or rotor, rotates in the stationary generating coils, or the stator. Because an alternator's field uses very little current, the rotor needs much smaller brushes than does a generator armature.

RELATIONSHIPS

The design and construction of an alternator or generator is a considerable undertaking that could easily fill several volumes. However, there are several basic principles governing generators

and alternators that we can use to our advantage in order to rewind an existing device for use at a slower speed. These principles incorporate the following generator characteristics:

- the RPM (speed)
- the number of poles
- the number of turns in a coil
- the magnetic flux density of the field
- the length of the armature or stator stack
- the airgap
- the current handling capacity of the wire

RPM & NUMBER OF POLES

All generators and alternators are designed to operate at a fixed optimum speed, called the operating RPM. This speed is what we wish to change to better match the operation of the wind generator propeller. One way of reducing the speed of a generating device is to increase the number of field poles. If you double the number of poles in a given generator, you will: (1) cut its operating speed in half for a given voltage: or (2) double the voltage output of that device at its operating speed. Unless you are building a generator from scratch, this is usually quite difficult to do. One exception is in a generator with main poles and interpoles. The interpoles can sometimes be converted over to main poles.

RPM & TURNS/COIL

The voltage induced in a coil of wire passing through a magnetic field is proportional to the number of turns in that coil. If we can double the number of turns in the armature/stator coils, we can either (1) double the operating voltage at a given RPM or (2) halve the operating speed of the generator at a given operating voltage.

RPM & FLUX DENSITY

Another way of increasing induced voltage in the armature/stator coils is to increase the magnetic field through which those coils pass. Field strength is related to the amount of current passing through the field relative to operating voltage; the more current you can push through the field coils (up to a certain point called saturation) the greater the flux density of the field. If we can increase the flux density of the field, the induced voltage of the generating coils will increase. Field strength can be increased by decreasing the number of turns in the individual field coils. The field coil uses up some of the electricity produced by the generating device. The ideal generator will use about five percent of its rated capacity in the field. Beyond this amount it becomes less efficient

to the point where saturation is reached and the field becomes parasitic. Field coils are usually connected in series in a generating device. One easy way to increase the current draw in a set of field coils without rewinding them is to divide them in parallel. This series/parallel arrangement still allows for north and south oriented poles.

INDUCED VOLTAGE AND ARMATURE/STATOR LENGTH

Yet another way of increasing induced voltage is by making the coils that pass through the magnetic field longer. Doubling the armature/stator stack results in a doubling of induced voltage.

AIRGAP

The amount of space between the field coils and armature/stator coils is known as the airgap. The airgap is necessary to prevent the coils from rubbing on the fields after both have expanded due to the heat given off by the electrical generating process. However, the airgap works against the flux density of the field: the greater the airgap, the greater the current needed by the field to overcome the airgap. Most alternators and generators have much larger airgaps than necessary due to sloppy construction. The airgap can be lessened by shimming the field poles with ferrous shimstock. The only way to do this is on a trial & error basis in small increments.

WIRE AMPACITY

The current output of the armature/stator is entirely dependent upon the current carrying capacity, or ampacity, of the wire used. Ampacity is related to wire size. Comparing relative wire sizes can be accomplished by comparing the wire's circular area (called circ. mils), unit weight, unit length, or unit resistance. The following chart

FIGURE 2: COPPER WIRE TABLE

Wire Gauge	Circular Mils	Pounds/ 1000 feet	Feet/ Pound	Ohms/ 1000 feet
10	10380.0	31.430	31.82	0.9989
11	8234.0	24.920	40.13	1.2600
12	6530.0	19.770	50.58	1.5880
13	5178.0	15.680	63.77	2.0030
14	4107.0	12.430	80.45	2.5250
15	3257.0	9.858	101.40	3.1840
16	2583.0	7.818	127.90	4.0160
17	2048.0	6.200	161.30	5.0640
18	1624.0	4.917	203.40	6.3850
19	1288.0	3.899	256.50	8.0510
20	1022.0	3.092	323.40	10.1500
21	810.1	2.452	407.80	12.8000
22	642.4	1.945	514.10	16.1400
23	509.5	1.542	648.50	20.3600
24	404.0	1.223	817.70	25.6700

lists these relationships for wire sizes used in generators & alternators: Note that half sizes exist for most wire gauges but in the interest of clarity are not listed.

We have been talking about doubling the voltage or halving the RPM of a generating device by doubling the number of turns of wire in the coils. These coils fit into slots on the armature or stator. The slots have a given physical size that cannot be changed. Obviously, you can't fit more wire into a slot than it was designed for unless you use a lighter gauge wire. This is where the Copper Wire Table comes into use. If you wish to double the number of turns in a coil, you must halve the size of the wire. This corresponds to three steps down on the wire chart. For example, say we have armature

coils with 7 turns of #15 wire. The circ. mil area is 3.257. One half of this would be about 1.6. This area is equal to #18 wire. The new coils made from 14 turns of #18 wire would fit into the existing slots.

Note, however, that by halving the size of the wire, you also halve the current carrying capacity of that wire. There is no free lunch! If you want a slower speed, you have to give up something. This new wire size will limit the power output of the rewound generator.

FER INSTANCE...

Let's say that we have a 1200 RPM, 32 VDC motor that we want to make into a wind generator, (DC motors & generators are more or less interchangeable). The motor draws 30 amps. We want it to run at a maximum speed of 300 RPM, and we'd like to power our hot water heater with the wind generator. The heating elements in the water heater are rated at 120 volts. We take the motor apart and discover that it has two main poles and two interpoles of the same physical size as the main poles. The wire in the interpole coils is finer than that of the main poles. We have pulled the armature apart and find that we have coils made of #10 wire with 4 turns/coil. What to do? Let's begin with the interpoles. If we rewind them to the same number of poles with the same gauge wire as the main poles, we have just doubled the number of poles in the generator. This has the effect of cutting the speed of the generator to 600 RPM, but still at 32 VDC. In order to get the speed down to 300 RPM, we need to double the turns of wire in the armature coils, from 4 to 8. Wire size is reduced from #10 to #13. But we're still at 32VDC! If we halve the wire size again, we're up to 64 VDC. one more time and we finally get to 128VDC, close enough! But we've taken two more jumps in wire size, from #13 to #16 to #19, and doubled the turns twice, from 8 to 16 to 32. Our final armature coils would then be 32 turns of #19 wire. What kind of current can we expect out of this generator? Doubling the field poles has no effect (in this case) on current. However, going to smaller wire gauge in the armature does. Going from #10 to #13 cut our current production from 30 amps to 15 amps. Two more jumps to #19 wire cuts our current output to 3 3/4 amps. Our wind generator will put out 4 amps intermittently at 120 volts with a top propeller speed of 300 RPM. This same process can be used in reverse to rewind a generator for lower voltage & higher current.

ANOTHER APPROACH

We have several old 12 volt, 100 amp Chrysler alternators in the scrap heap. We need an alternator for our hydro plant or wind genny to put out 24 VDC to match the PV array and inverter. New 24 volt alternators cost \$400! What to do?

Car alternators possess several interesting features that can be used to our advantage. First, since we have several of these things, we have several lamination stacks at our disposal. If we take two of these cores, strip the wire and pop the rivets out, we can bolt them back together for rewinding. Since the lamination stack is doubled in size, we just doubled our voltage, from 12 volts to 24, without changing wire size. The same thing can be done with the rotor by merely feeding 24 volts into it. We'd need to use a 3-phase bridge rectifier in place of the usual voltage regulator. We can then proceed to rewind with different wire gauges to meet the RPM specs of our hydro or wind plant.

FOR THE LIBRARY

Anyone wishing more detailed information on rewinding can order the following republished out-of-print books from Lindsay Publications, POB 12, Bradley IL 60915. Both books cost \$11.90 postpaid. Autopower, by S.W. Duncan, 1935 (Catalog #4791) LeJay Manual, by Lawrence D. Leach, 1945 (Catalog #20013)

ACCESS

Mick Sagrillo, Lake Michigan Wind & Sun, 3971 E. Bluebird Rd. Forestville, WI 54213 • 414-837-2267.



How Electric Motors Work

Amanda Potter

© 1993 Amanda Potter

We use electric motors everyday. They are in our refrigerators, washers, stereos, computers, power tools, water pumps and electric cars — to name just a few. Electric motors use the relationship between electricity and magnetism to transform electrical energy into mechanical motion. Understanding how they work helps us determine the best motors for our applications. In renewable energy systems, motors and inverters can be a quarrelsome combination. Knowing how motors work helps you understand the motor's electrical needs.

Magnetic Fields

Magnetic fields exert a force on ferrous metals (like iron) and magnets as well as on electric currents without any physical contact. Lines of force or flux were invented to help us visualize the magnetic field. Stronger magnetic fields are shown with more lines of flux. Magnetic flux density is proportional to the number of flux lines per unit area. See Figure 1.

DC Motor Action

An electric current produces a magnetic field. The flux lines of a straight, current carrying conductor are concentric rings around the conductor. See Figure 2. The direction of the magnetic field lines are determined by the direction of the current. Your right hand can be used to show this relationship. Your thumb points in the direction of current and your fingers curl in the direction of magnetic field.

Current flowing through a conductor in a magnetic field exerts a sideways force on the conductor. In Figure 3, the

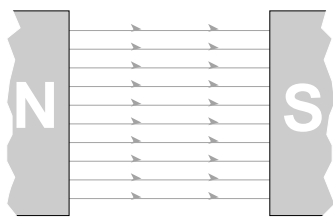

Figure 1

permanent magnetic field and the induced magnetic field oppose each other in the region above the wire, reducing the total flux. Below the wire, the two fields are in the same direction and the total flux is increased. The resulting magnetic force causes the conductor to move upwards into the area of the weaker magnetic field.

If an armature loop is placed in a magnetic field, the field around each conductor is distorted. See Figure 4.

These repulsion forces are proportional to the flux density and the current in the armature loop. The repulsion forces push the armature upwards on the left and downwards on the right. These forces are equal in magnitude and opposite in direction and produce a torque which causes the armature to rotate clock-wise.

Commutation

The magnitude of this torque is equal to the force multiplied by the perpendicular distance between the two forces. It is maximum when the conductors are moving perpendicular to the magnetic field. When the loop is in any other position, the torque decreases. When the plane of the loop is perpendicular to the magnetic flux (we call this the neutral plane), the torque equals zero. As soon as the armature passes this point, it experiences a force pushing it in the opposite direction and is eventually magnetically held at the neutral position. In order to maintain the motion of the armature, the battery connections to the armature loop must be reversed as the loop rotates past the neutral plane. This is the basic principle behind a DC electric motor. Electrical energy (current) supplied to the armature is transformed into mechanical motion (the loop rotates).

With the type of motor described above, the torque varies from zero to its maximum twice in each revolution. This variation in torque can cause vibration in the motor and the

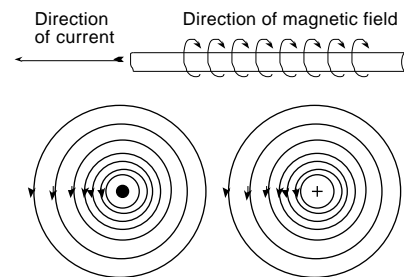

Figure 2 : Flux flow of current flowing a) out of the page
b) into the page

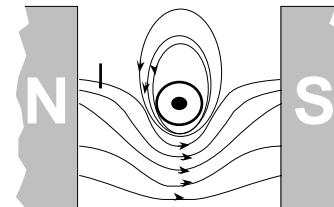

Figure 3

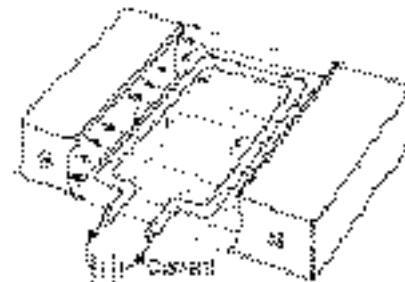

Figure 4

equipment it drives. Also, a motor stopped with the armature in the neutral plane is very difficult to start. Additional armature coils solve both of these problems. Figure 5 shows a motors with one coil, two coils, and 16 coils. The more coils that an armature has

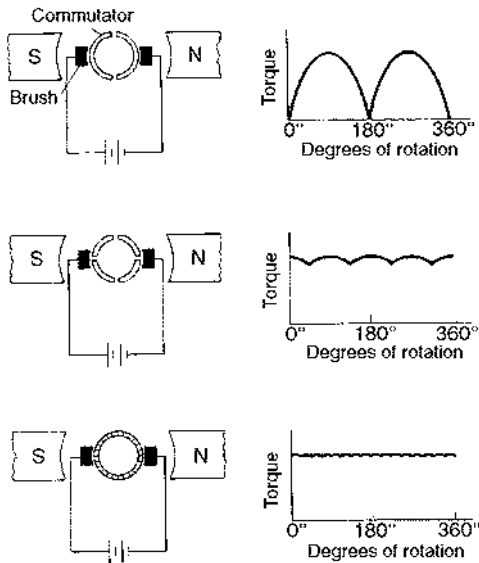

Figure 5

(each with two commutator segments), the smoother the torque output. Torque never drops to zero when there are two or more coils.

Back EMF

Whenever a conductor moves through magnetic lines of flux, voltage (emf) is induced in the conductor which is opposite to the voltage you applied to the motor to make it spin. The magnitude of this emf depends on the speed of rotation. It is called the back emf or contervoltage. The difference between the applied voltage and the back emf determines the current in the motor circuit. So, the back emf helps to limit the current flowing in the armature.

DC Motor Types — Permanent Magnet Motors

Permanent magnet (PM) motors are comparably small, light, efficient motors. Their high efficiency and small size are due to the use of permanent magnets to produce the magnetic field. They do not have the added bulk and electrical losses of the field windings normally required to produce the magnetic field.

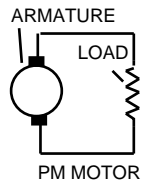

Permanent magnets are produced by ferromagnetic materials that have been magnetized by an external magnetic field. Ferromagnetic materials can produce magnetic fields several times greater than the external field and will remain magnetized even after the applied magnetic field is removed.

Speed Regulation

Speed regulation is easily accomplished in a PM motor because the speed is linearly related to the voltage. The speed can be increased simply by increasing the voltage. The speed is inversely proportional to the torque. This

means that the torque increases as the motor slows down for heavy loads. See Figure 6. The torque a motor can apply at start up (starting torque) and the torque which causes the motor to breakdown (breakdown torque) are the same for these motors. PM motors have a high starting torque for starting large loads. This torque results from a high starting current, 10 to 15 times normal running current. PM motors cannot be continuously operated at these currents, though, since overheating can occur. Runaway in a motor occurs when the motor builds up speed under no load until its bearings or brushes are destroyed. Runaway is unlikely in PM motors.

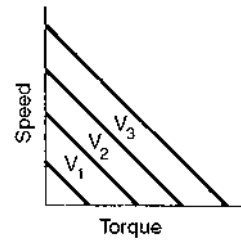

Figure 6

Dynamic Braking

Sometimes it's necessary for a motor to stop rotating quickly after power is disconnected from the motor. This can be achieved by mechanical braking (friction) or electrical braking (dynamic braking). Dynamic braking is accomplished in a PM motor by shorting the armature connections and converting the motor into a generator. The rotational mechanical energy is converted to electrical energy and then to heat. PM motors can be braked very quickly using this method without the use of brake shoes which wear out. PM motors are also be easily reversible when the motor is running or stopped.

The most serious disadvantage of PM motors is that the PM fields can be demagnetized by the high armature currents that result from stalling or "locked rotor operation." This problem becomes more of a concern at temperatures below 0°C. Also, permanent magnet motors are normally small motors because permanent magnets can't supply enough magnetic field to produce large PM motors.

PM motors can be used for applications requiring small, efficient motors which have high starting torques and low running torques (inertial loads). They are commonly used in well pumps and appliances in RV systems. Jim Forgette of Wattevr Works uses PM motors in his washing machine retrofit kits.

Shunt Motors

In shunt motors, the magnetic field is supplied by an electromagnet which is connected in parallel with the armature loop. The primary advantage of shunt motors is good speed regulation. Variations in torque by the load do not have a big effect on the speed of the motor unless it is overloaded. Shunt motors have lower starting torques and

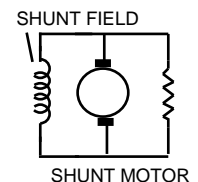

lower starting currents (three times running currents) than other motors of same horse power. See Figure 7.

The National Electrical Manufacturer's Assn has agreed on four standard speeds for shunt motors: 1140, 1725, 2500, and 3450 rpm. The speed is normally controlled by varying the armature supply voltage. Speed varies linearly with armature supply voltage and torque is unaffected.

Shunt motors are typically used for loads which require good speed regulation and fair starting torque. If very heavy loads are to be started, a starting circuit may be required. Starting circuits connect progressively smaller resistances in series with the armature. Runaway can occur in shunt motors if the field current is interrupted when the motor is turning but not loaded. Dynamic braking and reversibility are both options with shunt motors.

Series Motors

In series motors, the field coil is connected in series with the armature loop. The field coil has a large current (the full armature current). Heavier copper is used for the field coil but not many turns are needed. Series motors are usually less expensive and smaller in size than other motors of the same horsepower because less copper is used.

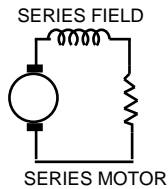

Due to the small number of turns and the resulting low inductance, series motors can operate on both ac and DC power. For this reason, series motors are often called universal motors. Power to both the field and armature loops reverses at the same time when operated on ac power and so the resulting magnetic force remains the same. Series motors may perform differently on ac than DC because of the difference in impedance of the windings. One shouldn't assume all series motors are universal. Some may be optimized for a particular power supply and perform poorly or fail prematurely if not operated on the correct supply.

As the motor's speed is decreased by heavy loads, the motor supplies high torque to drive the load. This helps prevent stalling and provides high starting torque. Starting currents are also high but are not usually a problem because series motors are normally small motors. See Figure 8. The speed of series motors can be adjusted by varying the supply voltage with a rheostat, variable

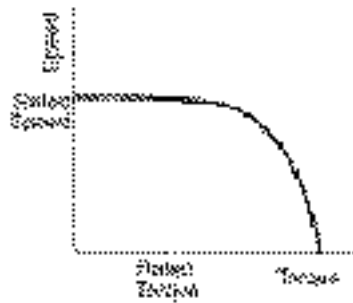

Figure 7

transformer or electronic controls. Series motors are not normally used if constant speed over a range of loads is required.

Series motors are very common

motors in household appliances and power tools. They are used in blenders, juicers, food processors, and hand power tools such as drills. They are very versatile and have the highest horsepower per pound and per dollar of any motor that operates on standard single phase ac power. They deliver high motor speed, high starting torque and wide speed capability. Series motors are usually operated at speeds over 7000 rpm or more. In routers, small grinders and sanders, speeds of 25,000 rpm are not uncommon. Series motors are often connected to a built-in gear train to reduce shaft speed and/or provide more torque. Gear trains also provide loading which prevents runaway.

Series motors have comparatively high maintenance. Brushes and bearings need to be regularly replaced. They are the only motors that are usually given an intermittent duty rating. Other disadvantages of series motors are that they are not usually designed for dynamic braking and reversibility. They should not be run without a load as runaway can occur.

Series motors have a moderately low power factors — normally between 0.5 and 0.7. Resistors have a power factor of one. The more reactive a component, the lower its power factor. Low power factors can be a problem for modified sine wave inverters. Appliances with low power factors may run three quarter speed. Sine wave inverters do not have trouble with power factors less than one. Series motors are typically small motors and so their high starting currents are not usually a problem for inverters.

Compound Motors

A compound motor provides a mixture of the characteristics of both shunt and series motors. Its field coil is split into a series field which is connected in series with the armature and a shunt field which is connected in parallel with the armature. The magnetic fields can either aid (cumulative compound) or oppose each other (differential compound).

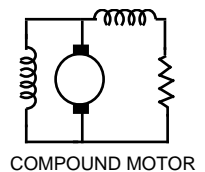

Cumulative and differential compound motors have different speed/torque characteristics. Cumulative compound motors provide more torque than shunt wound motors and better speed regulation than series wound motors. Differential

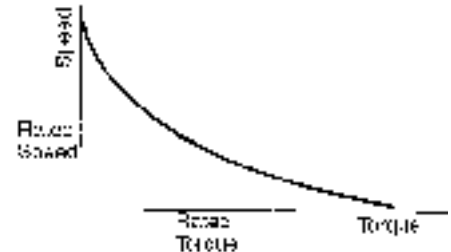

Figure 8

compound motors have almost perfect speed regulation but lower starting torque. See Figure 9.

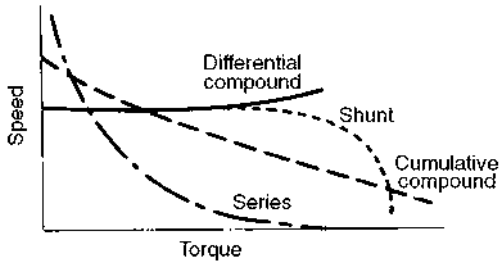

Figure 9

Compound

Compound motors were often used in the past. Inexpensive electronic controls has made it possible to replace them in many cases with lower cost series and shunt motors. They are still used sometimes in large DC equipment which require high torque and good speed regulation.

Brushless DC Motors

Brushless DC motors are actually not DC motors at all. They are ac motors with built-in micro inverters to change the DC supplied to the motor into ac to be fed to the field windings. A logic circuit senses the position of the permanent magnet rotor and controls the distribution of current to the field windings. Field windings are energized in sequence to produce a revolving magnetic field.

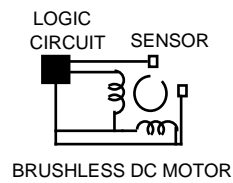

The greatest advantage of brushless DC motors is the replacement of carbon graphite brushes and commutators with long life solid state circuitry. They provide low maintenance, low electrical noise motors with good speed control and constant torque. They cannot, however, be easily reversed and are not easily adaptable to dynamic braking. They are also more expensive than conventional DC motors. They are used frequently in audio-visual equipment and "muffin" cooling fans, such as the ones found in inverters, charge controllers, and computer equipment. They are also used in Sun Frost refrigerators.

AC Motors — Induction Motors

The majority of motors in service today are ac motors. Many of these are universal motors. Induction motors,

though more expensive, are also very common due to their high reliability. Polyphase induction motors are cheaper, more efficient, more reliable, and have a higher starting torque than single phase induction motors. We are only discussing single phase induction motors here though because only single phase power is available to most homes.

Induction motors use a squirrel cage rotor construction. This means that the rotor is made of thick aluminum or copper that is one turn only and is joined at each end by an aluminum or copper ring. This frame is then filled in with laminated iron to provide a low reluctance magnetic path. The bars of the rotor are angled with respect to the shaft to provide a smoother output torque and more uniform starting performance.

Voltage is induced in the rotor when it is placed in a rotating magnetic field. The induced voltage produces a high current because of the rotor's very low resistance. This high current flowing in the rotor produces its own magnetic field. The magnetic interaction of the rotor and the rotating stator field exerts a torque on the rotor, making it follow the magnetic field. Thus an induction motor produces a torque on the rotor without any electrical connections to the rotor. This eliminates the use of brushes and bearings and is the reason for the induction motor's high reliability.

Normally, the rotating magnetic field in induction motors is produced with three-phase power. A magnetic field established with single phase power will pulse with intensity but will not rotate. A squirrel cage rotor placed between the poles of a single phase motor will therefore not rotate either. Once the rotor begins rotating, however, it will continue to rotate. Thus some means must be employed to create a rotating magnetic field to start the rotor moving. This method determines the type of single phase ac induction motor.

Split-phase Motors

In split-phase motors, a rotating magnetic field is produced with a start winding and a run winding. The start winding is made of smaller gauge wire. The resulting higher

DC Motor Characteristics

Motor Type	Starting Torque	Starting Current	Reversibility	Speed	Dynamic Braking	Size/Weight	Cost	Horsepower Range
PM	high	high	easy	varying	yes	smallest	low	under 1
Shunt	low	low	easy	constant	yes	normal	moderate	any
Series	high	very high	not usually	high & varying	no	small	low	under 2
Compound (Dif)	low	low	easy	very constant	yes	large	high	any
Compound (Cum)	high	high	easy	fairly constant	yes	large	high	any
Brushless	high	high	difficult	constant	no	small	high	low

resistance and lower reactance produces an approximately 60° phase difference between the currents in the two windings. This phase difference produces a rotating magnetic field which causes the rotor to start rotating. See Figure 10 below. The start winding is disconnected from the circuit when the motor reaches 70% of operating speed. The start winding will overheat if it conducts current continuously. Once the rotor begins turning, the distortion of the stator magnetic field by the rotor's magnetic field produces enough magnetic field rotation to keep the rotor turning.

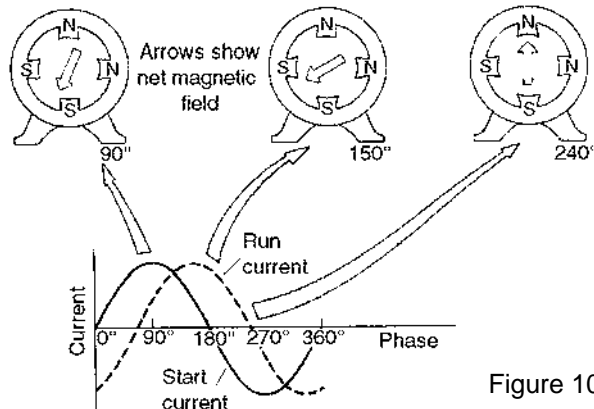
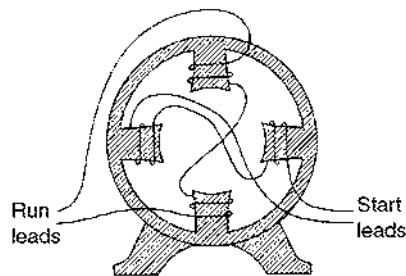
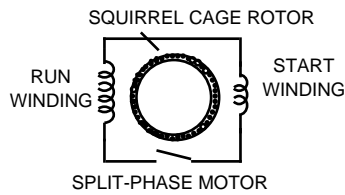

Figure 10

Split-phase motors are very common and not very expensive. Oxidation of centrifugal switches was once the most common type of failure. Solid state devices have improved the motor's reliability. They have a moderate starting torque and a high starting current (8–10 times running current). They are a good choice for easy to start application such as large fans, blowers, washing machines and some power tools, including bench grinders and large table saws. Overheating can occur if the motor is heavily loaded and the speed kept too low for the switch to open. Heat builds up with the high starting current and the high start winding resistance. Overheating can also result from frequent starting and stopping.

Split-phase motors operate at practically constant speed and come up to rated speed very quickly. The motor's speed varies from 1780 rpm at no load to 1725–1700 rpm at full load for a 4 pole 60 Hz motor. Split-phase motors can be reversed while at rest but not during operation. Dynamic braking can be accomplished by supplying DC power to the field coils via either an external DC supply or a rectifier, resistor and charging capacitor.

Split-phase motors can cause problems on inverters because of their very high starting currents. Richard learned a trick after damaging many inverters trying to start his bench grinder. If you start the wheel turning with your finger, you can get the grinder started with a lower current. Be sure to get your finger out of the way before you turn the switch on.

Capacitor-Start Motors

Capacitor-start motors have a higher starting torque and lower starting current than split-phase motors. They do this by connecting a capacitor in series with the start winding which increases the phase difference between the start and run fields. Low cost ac electrolytic capacitors are normally used since they are only used for a few seconds when starting. Capacitor-start motors are used to start very heavy loads such as refrigerators, pumps, washing machines and air compressors. The starting currents can be quite high when the motor is operated with large loads. This much current is hard on centrifugal switch contacts and so many capacitor-start motors use a current or potential relay instead of a centrifugal switch.

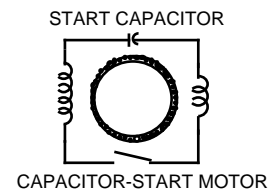

Capacitor-start motors often have problems on modified sine wave inverters. The field coils and the capacitor make up a tuned circuit which requires 60 Hz frequency for proper operation. Although modified sine wave inverters have an average 60 Hz frequency, the instantaneous frequency is sometimes much, much higher. Richard's found in his experience that substituting the capacitor for a higher or lower value may solve the problem. It's a matter of testing different values. Sine wave inverters do not have any problems starting capacitor-start motors.

Permanent-Split-Capacitor (PSC) Motors

Centrifugal switches and relays are the most likely part of the capacitor-start motor to fail. They can be removed if slightly larger wire is used for the start windings so that they can be left connected without overheating. A higher capacitor value is required to compensate for the higher

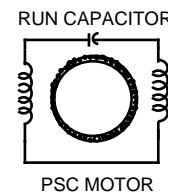

AC Motor Characteristics

Motor Type	Starting Torque	Starting Current	Reversibility	Speed	Dynamic Braking	Cost	Horsepower Range
Split-phase	moderate	high	easy, at rest	relatively constant	yes	normal	up to 2
Capacitor-start	high	medium	easy, at rest	relatively constant	yes	high-normal	up to 5
PSC	mod. high	med. low	easy	relatively constant	yes	high-normal	up to 5
Two-capacitor	high	medium	easy, at rest	relatively constant	yes	high-normal	up to 5
Shaded-pole	low	low	not reversible	relatively constant	yes	low	up to 1/2

inductance of the larger windings. Oil-bath type capacitors are usually used because the capacitor is now used during start and run operation.

PSC motors operate in much the same way as a two phase ac motor. The capacitor ensures that the capacitor winding is out of phase with the main winding. There is now a rotating magnetic field during start and run operation. This gives the motor greater efficiency and quieter and smoother operation than ac induction motors that only have a rotating magnetic field during start operation. The capacitor value is a compromise between the optimum value for starting and running. This results in a lower starting torque than the capacitor-start motor.

PSC motors are used in applications where frequent starts and stops and quiet smooth operation is required. Examples are instrumentation and low noise equipment fans.

Two-Capacitor Motors

Two capacitor start, one capacitor run motors use an electrolytic capacitor for starting and an oil-type capacitor for starting and running. The two capacitors are connected in parallel. This motor type preserves the efficiency and smooth, quiet operation of PSC motors while running and provides the high starting torque characteristic of the capacitor-start motors. Optimum starting and running characteristics are obtained at the expense of using some sort of switch again.

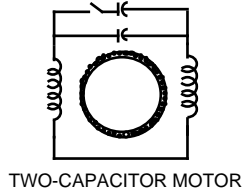
**Shaded-Pole Motors**

Shaded-pole motors' magnetic fields are made to rotate by the inductive effect of two or more one-turn coils next to the main windings in the stator. The time varying magnetic field set up by the alternating current in the main winding induces current in the shading coils. The induced current in turn establishes a

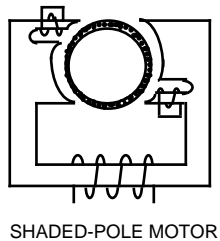

magnetic field in the shading coils which lags behind the main field by about 50°. This sets up a rotating magnetic field in the stator.

Shaded-pole motors are simple in design and construction. They have no internal switches, brushes, or special parts. These motors offer substantial cost savings in applications which require constant speed and low power output.

Shaded-pole motors are inefficient, have low starting torque and can have unsmooth running torque. They are nonetheless cheap and reliable and are used in countless consumer applications ranging from inexpensive blowers to room air conditioner fans. Shaded-pole motors run without problems on sine wave inverters but may run slow on modified sine wave inverters.

Speed Control of ac Motors

Speed control of ac series motors can be accomplished by using SCR's and triacs to turn ac power on for only part of each cycle, reducing the average voltage to the motor without dissipating large amounts of power.

Induction motors are usually designed to run at a single speed controlled by the frequency of the ac power supply driving them (which is usually a constant 60 Hz). At a higher cost, they are sometimes specially designed to provide speed variations. This is usually accomplished by changing the number of poles. A motor with two coils per phase will run half as fast as a motor with one coil per phase. Thus a motor can be made with two or three coils per phase and the number of coils can be switch selected.

Energy Efficient Electric Motors

Split-phase, capacitor-start, PSC and two-capacitor motors are all available in energy efficient models. Improvements in efficiency are mainly due to increased conductor and rotor areas, improved grade of steel and improved ventilation. These motors are beginning to be found in larger home appliances and may make these appliances an option for RE systems.

Access

Amanda Potter, c/o Home Power Magazine, POB 520, Ashland, OR 97520 • 916-475-3179

