

Agrodok 20

**Backyard rabbit farming in
the tropics**

J.B. Schiere

© Agromisa Foundation, Wageningen, 2004.

All rights reserved. No part of this book may be reproduced in any form, by print, photocopy, microfilm or any other means, without written permission from the publisher.

First English edition: 1983

Third (revised) edition: 1999

Fourth edition: 2004

Author: J.B. Schiere

Translation: Sara van Otterloo-Butler

Printed by: Digigrafi, Wageningen, the Netherlands

ISBN: 90-77073-74-4

NUGI: 835

Foreword

Two years ago I started rabbit farming in my small scale backyard with little knowledge of the matter. Through two years of teaching myself, reading books, consulting people, coaching students on rabbit research, and writing scientific papers on rabbits, it has been a pleasure to sit down and write this booklet. It is not meant to be comprehensive and on purpose it is kept very simple. The basic for “tropical backyard rabbit farming” are included. Only those things which can be understood by common sense and which require no specialized knowledge, laboratory work etc. are discussed. Difficult words in the text have been marked (*) and are explained in the glossary.

After reading this booklet you will certainly want to know more about breeding, nutrition, breeds, diseases and so on. To compile more detailed information on that would be a duplication of other excellent books about rabbits. Therefore the literature list also gives some details of the most important publications which are to my knowledge easily available.

Hans Schiere, Malang, Indonesia, December 1982

Foreword to the third revised edition

Within the Agrodok Series this booklet on rabbit keeping has proven to be very popular. We are grateful to Mr Gerd de Lange, of the IPC Livestock - Barneveld College, who has carried out a general check up of the contents, added a few improvements and updated the list of recommended literature. Gert Jan Veltwisch improved the pictures and Pepijn Dengerink took care of the lay out.

We hope that many people will make use of this booklet to increase their income or meat supply by rabbit farming.

Marg Leijdens, Agromisa, 1999

Contents

1	Introduction	6
1.1	Some reasons for keeping rabbits	6
1.2	General husbandry and handling	8
1.3	Structure of this agrodok	9
2	Types of animals: breeds	10
2.1	Fancy and fur breeds	10
2.2	Meat breeds	10
3	Selecting your animals: breeding stock	12
3.1	Health	12
3.2	Sex	12
3.3	Risks	13
4	Reproduction	14
4.1	The male	14
4.2	The female	14
4.3	Mating of buck and doe	15
4.4	Pregnancy-control	16
4.5	Kindling and mothercare	17
4.6	When to mate the doe again	18
5	Housing: the stable	20
5.1	General advice before you start building	20
5.2	Important features	22
5.3	Conclusions	28
6	Housing: the individual hutches	29
6.1	A favourable microclimate	30
6.2	Predators	30
6.3	Doors, hinges and feeding troughs	31
6.4	Sizes of hutches	34
6.5	Hygiene and building materials	35

6.6	The maternity hutch and the nest box	37
6.7	Conclusions	39
7	What feed to give	40
7.1	Water requirements	40
7.2	Feed	41
7.3	Growth rates of rabbits	42
7.4	Some practical remarks	43
8	Sick animals	44
8.1	Prevention of diseases	44
8.2	Intestinal problems	46
8.3	Problems of the respiratory tract	48
8.4	External parasites	48
8.5	Other diseases and health problems	49
9	Proper administration	51
9.1	Identification methods	51
9.2	The record-book	53
9.3	The calendar	53
10	The process of tanning	56
Appendix 1: Recommended chemical composition of feeds for intensively reared rabbits of different categories		59
Appendix 2: Common diseases of rabbits, their symptoms, causes, treatment and control		61
Further reading		65
Useful addresses		68
Glossary		70

1 Introduction

People keep rabbits for many different reasons. The main aim of this booklet is to give some reasons for small farmers, low income families or children to do so, and to discuss management, breeding, nutrition, veterinary, and other problems for this type of backyard farming.

1.1 Some reasons for keeping rabbits

- The meat is tasty, good quality and similar to chicken meat. This is known in many rural, tropical communities.
- There are few religious or other taboos on rabbit meat (except in vegetarian cultures). Islam does not prohibit eating rabbit meat, for example.
- Initial capital outlay is minimal. With some scrap wood or bamboo, a hutch can be constructed.
- Animals all over the tropical world are often used as a savings account. When a small amount of money is needed it is easier to sell a small animal than for example the hind leg of a goat.
- The quantity of meat provided by a rabbit is big enough for a small party or a family dish (comparable to the size of a chicken). On the other hand a rabbit is small enough to eat all the meat at once without the need for refrigeration or other conservation.
- To start a rabbit “business” one does not need a large initial investment. A few does (females) with a ram or buck (male) is enough to start, once the kindling begins the herd rapidly increases in size (if done well and with no bad luck) so that very soon one can slaughter the young males.
- If one starts a rabbit “business” with borrowed animals, within half a year the initial “credit” can be returned as live animals.
- Because the does produce offspring regularly they form a regular source of income instead of a large amount at once.
- Feeding rabbits can be very cheap. Even though supplementation with concentrate or grain is sometimes necessary and definitely will

increase growth rates, roadside grass, kitchen offal, garden leaves, etc. can provide the main feed at almost no cost.

- Rabbits can be tended by women, children or men and unlike bigger animals need no force to be restrained.
- The manure can be used for vegetable growing.
- The manure does not smell too much, and rabbits do not make much noise therefore the neighbours will not complain.
- The skin is valuable if there is a market for it, possibly in local handicrafts (see Chapter 10 for tanning)
- Children learn to tend for and appreciate animals.
- A rabbit is a nice present for a child on a birthday, for a neighbour who will marry or for a servant who wants to go home to his village.

No doubt this long list could be extended to include many more reasons for keeping rabbits.

Some difficulties of keeping rabbits

- Most important in a situation where one is the first to start with rabbits is that often people are reluctant to accept something new. Whereas in Europe and the U.S. there is a well established market for rabbit meat, in the tropics the market becomes more and more organized for chickens; there are few countries with a ready market for rabbit meat. This reduces potential money income, but it should be no problem where the intention is to raise rabbits as a family enterprise, mainly to provide meat for the family where the diet may be lacking in protein.
- Diseases are common and unlike chickens, specific rabbit medicines are not easily available. Moreover veterinarians (even in Europe and the U.S.) do not usually have much experience in the diagnosis and treatment of rabbit diseases. On the other hand, with good hygiene and common sense, added to information found in this booklet one should not have too many worries about diseases. Most animals get sick once in a while, and a dead rabbit is less of a worry than a dead goat or cow.

- Keeping rabbits will certainly take up some of your time. In general it is hard to say how much. It depends on the number of animals you keep, the housing system and the way you are able to obtain feed. For example keeping 5 to 10 rabbits will take you about 1 to 2 hours a day for cleaning, managing and feeding.

1.2 General husbandry and handling

Like all animals, rabbits require proper care if they are to (re)produce well. Before going to sleep at night one should check them, and during the day one should keep a close eye on them. It is not enough to see that the animal is sick, one should learn to see whether the animal will be sick, it is not enough to see that the doe has made a nest and kindled, one should know beforehand that she will make a nest and will kindle. Animals have no holidays, even on Christmas Eve they need feed, they will kindle during Easter week, or they may get sick during Id'ul fitr or Ramadan.

Like your own children, give your young rabbits the best quality food and drinking water (Chapter 7). Clean the hutches every day with water. If you take care, it is not necessary to take the animals out. Always handle the rabbits in the proper way. Lift them as shown in figure 1.

Those animals you want to use for further breeding should be given identification (Chapter 9). Keep a close watch on their performance, do not kill the fast growers but use those for further upgrading your stock. Separate the males and females that you want to keep at early time, before they become sexually active (females 4 months, males 2 months later).

Of those animals that you want to sell, males and females should be separated only if you keep them as long until they become sexually active. It is better not to put several litters together in one hutch, in order to prevent fighting. After mating the first time, you should give the young doe's separate hutches and then the whole cycle starts again.



Figure 1: Handling rabbits

1.3 Structure of this agrobook

There are many aspects to general rabbit husbandry. In this booklet we describe the most important things you need to know to start keeping rabbits: the different breeds, how to select breeding stock, mating and kindling, rearing the young, housing, feeding, illnesses, good administration practices, process of tanning the skin.

In the appendices additional information is also given, including a glossary of technical terms used, more detailed information on feed and disease as well as a list of useful books.

2 Types of animals: breeds

Just as there are many different types of cattle, it is not surprising to know that there are many types of rabbits. As with cattle, very often crosses occur between one race and another (crossbreeds), not to mention all the local varieties, often called “local rabbits”, “native breeds” and so on. Here breeds will be grouped in two for practical purposes without trying to make scientifically correct distinctions.

2.1 Fancy and fur breeds

Fancy and fur breeds differ from meat breeds in that the fancy types are not necessarily good meat producers, do not have large litters nor are they resistant/tolerant to diseases. They have nice skins, nice colours, funny ears and so on.

One of these types which deserves attention is the angora. The hair can become very long and provides a very valuable fibre for spinning and weaving. The value of the angora should not be overlooked for small home industries even though not much information is available. The hair seems to grow better in colder climates which might reduce the value of the angora in the tropical lowlands.

2.2 Meat breeds

Utility breeds are producers of meat, either by a fast growth rate (needs good feeding) or large and frequent litters. It is necessary to make a further distinction here in weight:

- light breeds (up to 2-3 kg adult weight)
- medium breeds (3-5 kg)
- heavy breeds (more than 5 kg)

When choosing the right breed keep a few things in mind:

- One should remember that very often local crosses seem to be of the lighter breeds. They may have the genetic potential to grow big but due to poor feeding, disease, mating too early and too often and suboptimal care, they do not get the chance to do so.
Before considering nice looking large animals which are imported one might do well to try the local breeds giving them proper feeding and care. Imported breeds all too often involve loss of face, prestige, money and effort because the animals may not grow either under the poor local circumstances, they are susceptible to diseases, and they are expensive; the stress of transport will cause diseases and mortality.
- Even though big animals look nice and impressive it is not always advantageous to have large animals. They mature later so they will start to produce offspring, let us say, at 9 months whereas the lighter breeds do so at 6 months. Your choice may be between 3 does of 3 kg producing 3 litters earlier whereas 1 doe of 9 kg (3 x 3 kg) produces 1 litter later. What family can eat 4 kg of meat at once (resulting from a 9 kg animal).
- A special word of caution should be made against the Flemish giant. It is a very good show animal and does well for public relations (around 9 kg is not uncommon). But fertility is not very good, litter size is not high, quite a few disease problems (sore hocks) occur and it has a lot of bone and intestine compared with medium breeds like the New-Zealand (white) and the Californian.
- Do not forget that you have to choose a breed which is suitable for your local conditions. It is impossible to give generalized advice. If two candidates for meat production in backyards had to be mentioned, I would recommend the New-Zealand (white) and the Californian. But let your choice depend on local availability and your preferences; you will give the best care to what you like the best.

The important thing is to get rabbit-minded with as little risk as possible. That does not usually imply the use of expensive, fancy, large animals.

3 Selecting your animals: breeding stock

When you cannot buy animals from a reliable source and you have to buy from an unknown person or market there are some things to keep in mind.

3.1 Health

The animals have to be healthy. The main signs are a smooth skin, standing ears, clear eyes, quiet breathing, no mange (scabies) forming crusts around the nose, eyes, at the edges of the ears or inside the ears as a dirty mass. Put them on the ground and let them jump to watch for irregular legs, inspect the anus to see whether it is dirty from diarrhoea (should not be!) which is often the case in young rabbits. Check the stomach (abdomen) of the animal. It should feel soft but smooth; a spongy feeling may indicate some intestinal troubles (see Chapter 8 on sick animals). Watch for sneezing rabbits. Dirty front legs and/or dirty nose may indicate a coughing disease (pasteurellose), because the animals “wash” their nose with their front legs.

3.2 Sex

The sexing of very young animals is not so easy. The older males have two big testes. If only one testis shows do not use him for breeding even though he is fertile, because it is a hereditary defect. If you are still not sure, which is often the case with young rabbits, hold the rabbit on its back, put one finger on the tail side of the genital apparatus and one on the abdominal side. Press down gently and stretch the organ; if it is a doe a long slit will appear, if it is a buck a small curved penis will show (figure 2). Do not confuse two small glands about the size of a pinhead on either side of the sexual organ with the testes.

Buying rabbits, sexing and judging their quality can only be learned by making mistakes first and thereby gathering experience. However, it is by no means an impossible or difficult task.

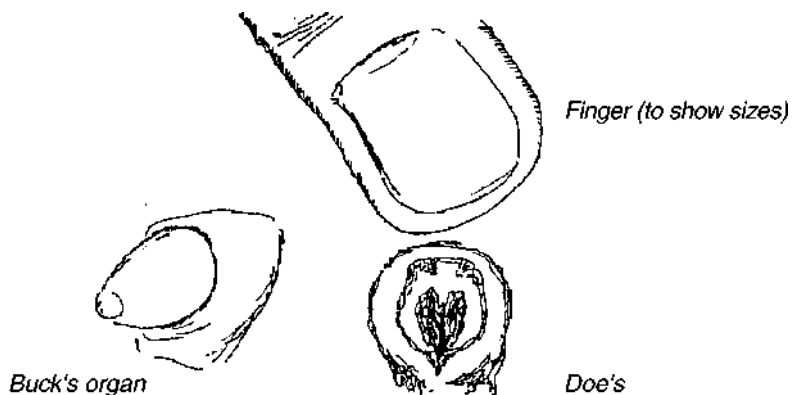

Figure 2: Sexual organs of the doe and the buck

3.3 Risks

Buying at a market implies risks and no guarantee can be given. A market is gathering and meeting place for diseases and in general farmers are unlikely to take their best animals to the market to sell there. The salesman often does not keep rabbits himself so he is also a poor adviser, moreover he will not know anything of the history of the rabbit, or he will only pretend to know. For example if you buy a reasonable-looking rabbit, who will tell you whether she is pregnant (if you cannot feel it yourself), whether she is infertile or should be bred, or whether she is actually still too young to be mated?

4 Reproduction

4.1 The male

The male story is easiest to be told. The proper age for the first mating depends on the breed and individual development. For small breeds it is 4-5 months, for large breeds 9-12 months. One male can easily handle up to 10 or more does, but this depends on mating intensity, heat, stress, age of the male, nutrition and so on. It is not a bad practice to have two males around because it is easier to prevent inbreeding.

Another reason is that by breeding in turns you will more easily be able to detect if the results of one are better than the other. You will not so easily blame infertility on the does but you can detect the effect of the male.

Sometimes the male is given a round hutch/stable so the doe cannot sit with her hind end in a corner which makes mating a little bit difficult.

4.2 The female

The female story is not difficult or complicated either, but she does require more care and attention. Like the males the proper age of first mating depends on the breed and individual development. Mate females (does) when they reach 75-80 % of mature body weight (4-5 months of age for the lighter breeds, 7-9 months for the heavy breeds). Does mature earlier than bucks.

Rabbits have no clear reproductive cycle. Nevertheless they do exhibit periods of greater willingness. They do refuse the buck sometimes! Signs of greater willingness are restlessness, noisiness (she will scratch the hutch), rubbing her chin on the feeding tray or drinking dish, the genital area will have a redder colour than usual. To mate the rabbit you do not have to wait until these signs show; she can be put with the buck at any time, as the egg will come free after mating. However, she may not always accept the buck. Does that are main-

tained in good physical condition should produce litters until they are 2 1/2 to 3 years old.

4.3 Mating of buck and doe

Mating should be carried out during the cooler times of the day, early morning or late afternoon.

Always bring the doe to the buck and not the other way round. If you put the buck in the hutch of the doe she is liable to defend her territory and fighting can start. On the contrary, by bringing her to him she will smell the male and will not defend the territory. She may do some initial running around but will eventually accept the buck.

If she accepts the buck she will sit down in his hutch and raise her rear end. Mating has taken place when the male falls aside or backwards after mounting the doe. Often he (and not she) utters a characteristic cry of pain or pleasure (difficult to make out which!). He may mount again immediately and mate again as before or he will run around, stamp his feet, and after some time do it again! If the doe is willing to be mated, effective mating takes place twice within the first 5-15 minutes.

After a successful first mating a second is not necessary. The second mating can even be used for another doe if the buck is very busy. If the buck does not have too busy a schedule there is of course nothing against a second time. If the mating was successful put the doe back in her hutch.

If the female starts to run or fight it is better to try it again after a few hours, the next morning or evening. Do not leave the doe with the buck overnight or for a few days. You will not know then whether mating actually took place, fighting might injure either the doe or the buck and stress will be the result. Instead keep watching the mating without disturbing it.

If a buck shows no interest within the first few minutes, it is virtually no use leaving them together. In this case also try again later.

What do you do if she does not accept the buck? In the first place she might be pregnant (see pregnancy-control). She will almost certainly refuse the buck then, and every time she is bothered it will reduce the chances of a good litter. In the second place there might be antipathy between the buck and the doe. In this case try another buck.

Sometimes it may help to hold the doe while she is in the buck's hutch. One hand to hold her head and body from running away, the other hand under her body, raising her hind a little bit, thus initiating a posture which she should naturally or automatically take. Matings can be successful this way but probably are not as good as spontaneous matings.

If none of these suggestions work, you may want to use her for meat.

4.4 Pregnancy-control

A week or two after mating you will notice that the doe has become quieter, seems to eat less, and sits with her abdomen resting nicely on the floor. She will start pulling out her hair to make a nest at about 30-32 days after mating, soon followed by producing a litter. Sometimes she fails to produce a litter after making a nest. If this happens approximately 2 weeks after mating it is called pseudo-pregnancy. Don't be disappointed. This is a perfect time to breed her, she is willing and fertile right at the time of pseudo-pregnancy.

To check sooner whether the mating was successful you will have to check for pregnancy. Pregnancy-control requires some practice but there are some fairly clear signs. Her hair can easily be pulled out if she is pregnant (later on she will make the nest with her own hair which she pulls with her mouth from her body). During the last days of pregnancy the teats become harder and somewhat red, and the udder will then begin to swell.

The best method of checking is palpation, but this requires practice. Palpation is possible from 10 days and onwards after mating. Place the doe facing you on a table, a bench or the floor. Put both hands on the sides and a little under the belly, gently pressing them towards each other and upwards. Of course you can feel a lot in the belly. Amongst others, right behind the left ribs you can feel the liver; all the way up in the abdomen on both sides and just under the spine, halfway back you will feel the kidneys. You may also feel the small faecal pellets and the guts. If she is pregnant after two weeks you will start to feel hard things like marbles, also in the upper side of the abdomen. These become progressively larger until you might even be able to feel the form of an embryo. Do not worry if you cannot feel all these things at first. After some practice you will be able to identify the embryos with little effort.

If this sounds too difficult it is also possible to check for pregnancy by putting the doe with the buck again 12 days after mating. If she refuses, the first mating has almost certainly worked out well. If she is willing again, the buck can repeat his work. This method has the very small risk that an already pregnant doe gets mated again with the possibility of starting another pregnancy halfway through the first. This super-pregnancy occurs occasionally.

4.5 Kindling and mothercare

When the doe is almost ready for kindling (about 4 weeks after mating) you can put a nest box in the maternity cage (for designs see Chapter 6). Kindling can then take place in this nest box. Kindling can take place at any time of the day but morning seems to be the most popular time. All she needs now is rest and feed. A scared doe may eat her young. Cannibalism may occur for other reasons too, such as no drinking water, lack of minerals and sometimes for no apparent reason. However, unrest is likely to be a main cause. If a doe, especially after the second litter, keeps eating or biting her young it is better to kill her and eliminate this bad characteristic. Most does, however, have no problems and distinguish easily between the newly born

young and the afterbirth: they lick the first and eat the second, although smell and taste can not be so different.

Do not handle the kindles more than is absolutely necessary, but check the newborn trying not to disturb them too much. Wash your hands first, as the smell of dogs, cats or rodents may upset the mother. Check the kindles for full bellies and for dead ones. The smell of the nest will soon tell you if it is dirty. Does with diarrhoea cause a distinct smell.

“The doe does not take care of her kindles” is a common complaint from beginners. In fact the doe only allows her kindles to suckle one or two times a day, and even then only for a short period. So the doe will rarely be seen with the kindles. Do not worry too much!

The hutch/cage should be large enough for the nest box and leaving space for the doe. If it is too small she might accidentally hurt the kindles by sitting on them.

After two weeks they will start to come out of the box, depending on the size of the box, the amount of milk the mother has and other factors such as the temperature in the box. After about 3 weeks the nest box can easily be removed. If the floor of the maternity cage is of wire or has big holes which make it difficult for the kindles to put their feet down, give them a piece of plywood or something similar in a corner so they can sit easily. At this time they will also suckle (or seem to) more often in a day.

Weaning usually takes place after about 4 weeks but should not be later than 6 weeks. Milk production seems to stop at that time, so there is no use for the young being with the mother any longer.

4.6 When to mate the doe again

Like rats, the rabbit can be mated the very day of kindling and she is likely to become pregnant. However, results might be disappointing. The litters will be smaller, lighter and with a higher rate of mortality,

not forgetting the stress on the mother, being pregnant and lactating at the same time. Even where feeding and other conditions are optimal it is common to mate again only after 3-4 weeks. In backyard farming practice feeding can be assumed to be less than very good. Therefore giving the doe more time between matings (10-12 weeks) will probably be better and result in larger and healthier (although fewer) litters.

Sometimes the doe will not accept the buck right after weaning, it may take quite a few days (weeks) to get her willing. What can you do? Just wait and keep trying to mate! Willingness seems less of a problem right after birth or during lactation than later on around or after weaning!

One more thing: there are advantages in mating two does at the time, if one of them does refuse to suckle the kindles or dies or whatever, you always have a foster mother at hand.

5 Housing: the stable

The easiest way to keep rabbits is to let them run around, find their own feed, mate as they want and when you are hungry you just try to catch one. Catching a loose (tame!) rabbit might not be so difficult, it will however prove far more difficult to catch a good number of good and healthy animals if you keep them that way. You will not know who is the father of who, you will not know which does have turned infertile, rats might get the best part of your rabbit crop, diseases can go unobserved or in any case untreated. To prevent diseases, inbreeding, too early mating or to be able to slaughter the right animal at the right time etc, we make stables and hutches. In this way we can manage our rabbits and get some profit from them.

We will discuss the following types of housing:

- The stable, which is a main building in which or under which you place the individual hutches (Paragraph 6.2). To build a stable is not always necessary, you might have a suitable place under the roof of your own house already (figure 3).
- The individual hutches, which you will always need (Paragraph 6.3). You can place them in a stable or not.
- The construction of a nest box will also be discussed (Paragraph 6.6).

5.1 General advice before you start building

Before going into the actual construction let us consider some general rules:

- One thing to be said here is that although initial expenses for stables seem high, they are really relatively low. A good building lasts for several generations, so the costs per generation are low. The real high costs are feed, labour, dead or stolen animals, care for sick animals and so on. If you start with a bad stable design it will force you day after day to duck if the door is too low, to do unnecessary

walking, awkward cleaning, catch extra rats, and that is a low initial cost but a high recurring cost.

- The main advice is, do not start too big, but do not waste time on clumsy designs either, do not try to spare a small amount of money on time saving devices. (This is not an argument to do people out of work but to give you more time for useful and necessary work.)

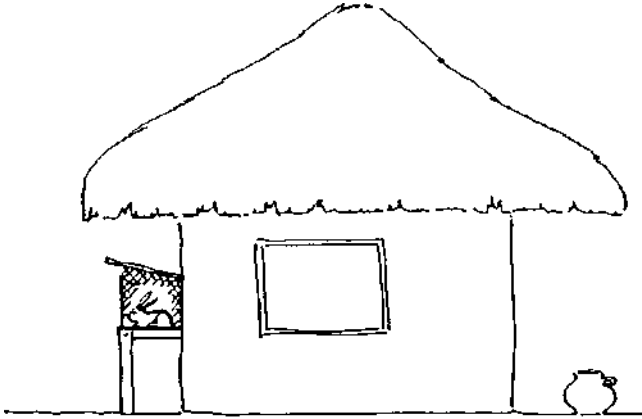

Figure 3: An example from Indonesia: the hutches are placed under the back roof of the family house

- Watch and ask your neighbours, study local buildings, ask why they use grass roofs and not galvanized iron, ask why they use bamboo instead of bricks, ask why they put the roof at 60° instead of 40° and so on. Do not forget that local people distinguish between bamboo for roofs, bamboo for bridges and bamboo for mats. Why do they tie the constructions with wire and not use nails? A multitude of these and other questions can be asked. Do people consistently build the roof in one direction, is there a difference in soil types influencing the use of wooden posts, sandy soil absorbs moisture and does not always need cement, clay becomes dirty very soon and it is better to put on cement, or wooden racks, etc. What do people do to prevent termites or other insects, do they have specific ways to keep out rats?

- Buildings should be constructed in such a way that working is not too difficult. Do not try to save money on design that will be a constant headache and bother. Keep the does separate, keep the growers together, keep everything clean and dry. Try to make the hutches in such a way that you can easily divide them into two or even three. If you want to keep quite a lot of rabbits put the storage space for feed, medicine and administration in one place in the middle of the main building (figure 4).

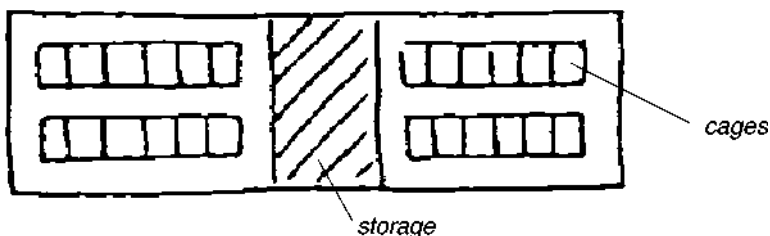

Figure 4: Ground plan of main building with cages, the storage of feed, medicine and administration is in the middle of the building.

5.2 Important features

Let us now discuss some features of your stable, assuming that you need such a building. You can construct your stable, keeping in mind the following guidelines.

Going into the matter systematically, we have to consider the following points. In fact, all the following points are inter-related, so read it through thoroughly first and then decide how, what and where to build.

Rain, wind and sunshine

To prevent rain coming in, give the roof an overhang (eave) (figure 5). Designs depend among others on the wind direction. If the wind is always from one direction it is easy, if the wind comes from different directions (also the rain) you might have to construct walls.

A large overhang also prevents sunshine from coming in. But do not make the overhang so low that you have to stoop every time you enter.

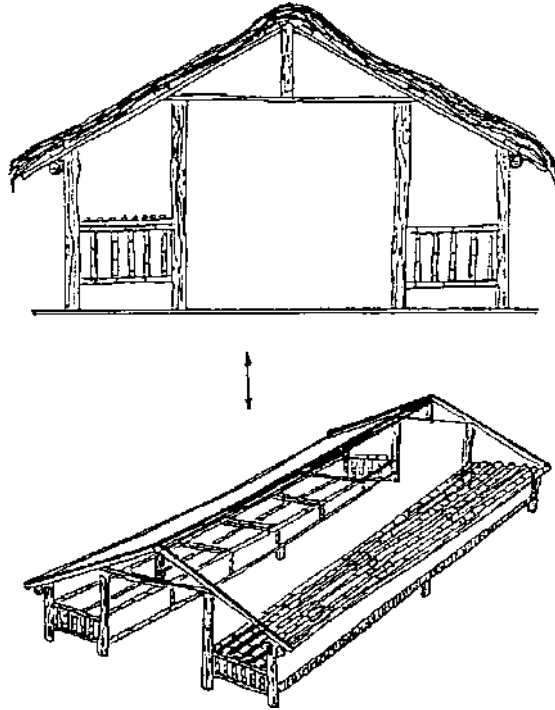

Figure 5: Example of main building with cages of bamboo. Note the high roof, the overhang of the roof and the well ventilated construction. This is often used in hot climates.

The height of a building is a compromise between freshness of the air, the problem of allowing too much rain in from the sides, and last but not least, the building costs.

Walls may be closed or open. Besides climatic conditions (rain, draft, cold wind, fresh air), theft and expense play an important role in this decision.

A note on straw, grass or leaf roofs: they need a steeper slope (implying a larger roofing area, thus greater expense) than tiles, and very much larger than the minimum necessary for galvanized iron sheets. If

the slope is too small, water will not run off but will come through the roof.

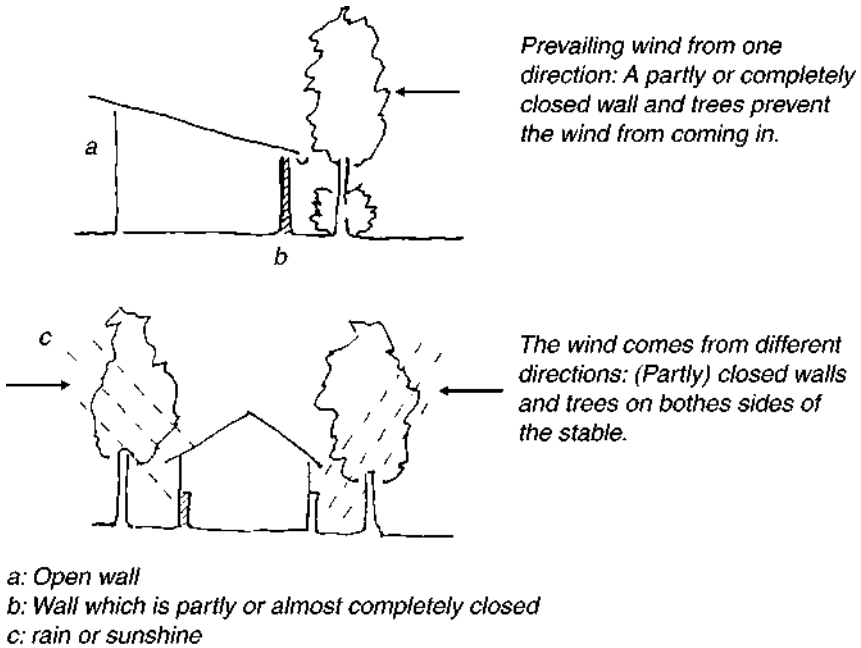
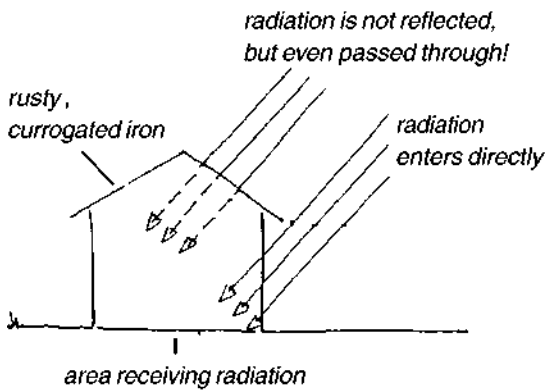

Figure 6: Roof and trees as protection against rain, wind and sunshine

Temperatures

Extreme temperatures can be tempered by different measures. Trees around the building decrease the amount of heat that enters during the day, by providing shade, and somewhat decrease the amount of heat that escapes during the night through radiation. They also lessen the impact of wind and rain (figure 6 and figure 7). Some fast growing legume trees include *Leucaena*, *Gliricidia*, *Sesbania*, *Erythrina*, and might even provide some feed for the animals. Besides trees, the roofing material greatly influences the heat inside. Use your own judgment: corrugated iron is hotter than a straw, grass or tile roof (especially if the roof starts to become rusty).



HOT
 rusty curroged iron
 small eaves
 no trees

TWO EXTREMES

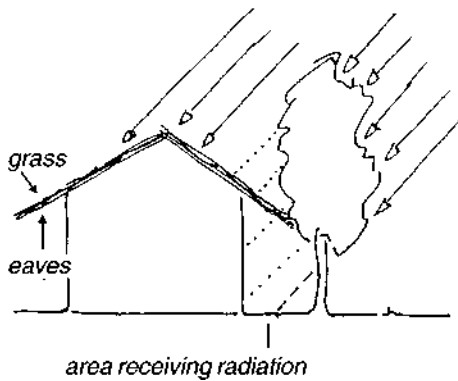

COOL
 grass / straw roof
 broad eaves
 trees

Figure 7: Roof material and construction in relation with temperature

Humidity and fresh air

A stable on a sandy soil with good drainage around, and good ventilation will be better than a badly ventilated stable on a moist soil. Animals also produce moist air! Good ventilation is helped by open walls (you can use wire, bamboo mats, or whatever to keep out thieves if necessary). Also, a high building is better than a low building; a tile roof (with many holes) allows for more ventilation than a corrugated iron roof or a grass roof (figure 8 and 9).

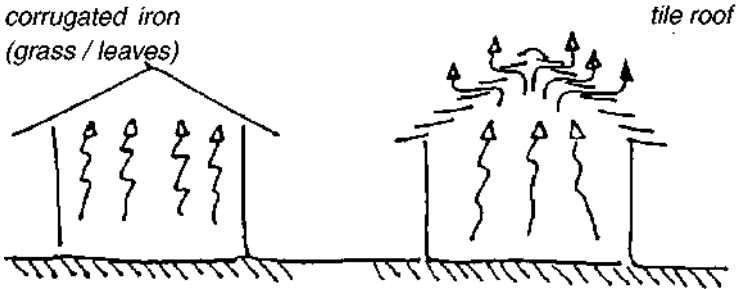
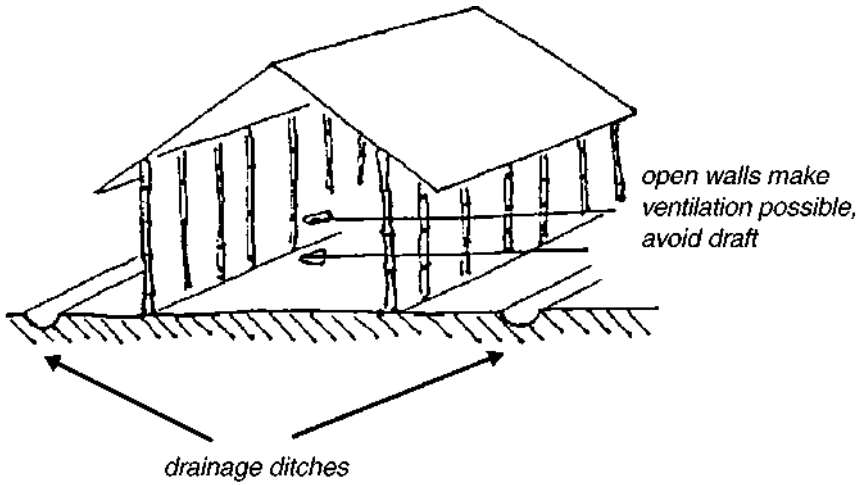

Figure 8: Ventilation through open walls and roof

If you do not have much wind blowing through the stable, warm air ventilation holes might be necessary. Avoid piling up manure and urine in the stable. That will cause ammonia to fill the air and affect the animals.

The best judge of the microclimate in the stables is you yourself. If you are bothered by heat, humidity or ammonia smell, you may be pretty confident that the animals have a similar sensation!

Protection

Protection from predators and theft will be discussed further when dealing with individual hutch design. Common sense is your best guide, rats will come in anyway, cats can be kept out, dogs are easy to keep out and thieves that's up to you to decide.

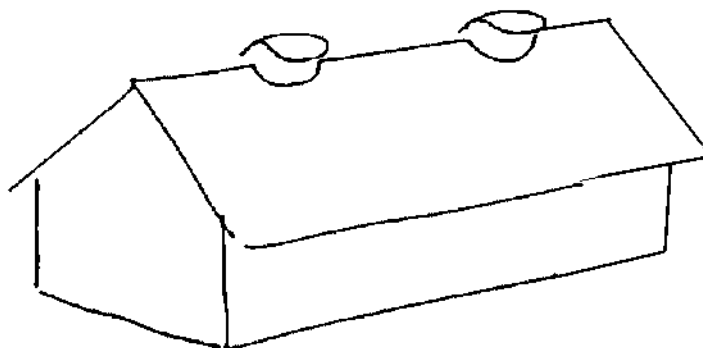
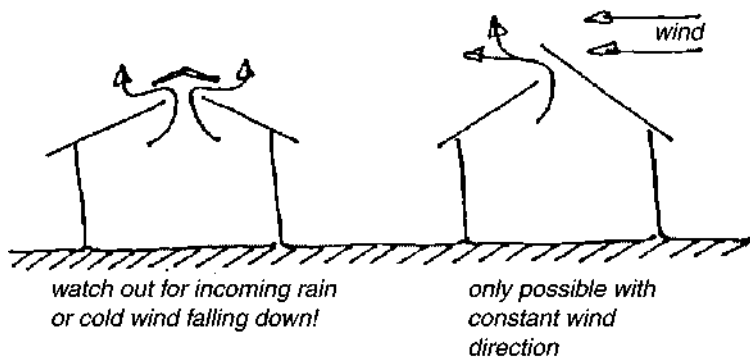

several holes in the top
cheaper / easier construction
easy to close if necessary!

Figure 9: Ventilation through ventilation holes

5.3 Conclusions

How, where and what to build you will have to decide for yourself. The decision will always be a result of weighing various factors that are of importance, like choosing between the material for the roof: a grass/leaf roof is cool, well known, cheap and easy to produce locally but it will need regular maintenance; a corrugated iron roof is hotter, more expensive, badly ventilated but it is longer lasting and definitely cleaner (no rats or birds).

If we talk about small scale rabbit husbandry a main stable probably will not be necessary, because a hutch can be placed under an overhanging roof, in the kitchen or under a tree with some plastic to prevent rain coming in (depends on climate). Rabbits do not like direct sunlight, shade will keep heat away and generally also prevent rain from falling in. Therefore let us talk about the requirements for individual cages.

6 Housing: the individual hutches

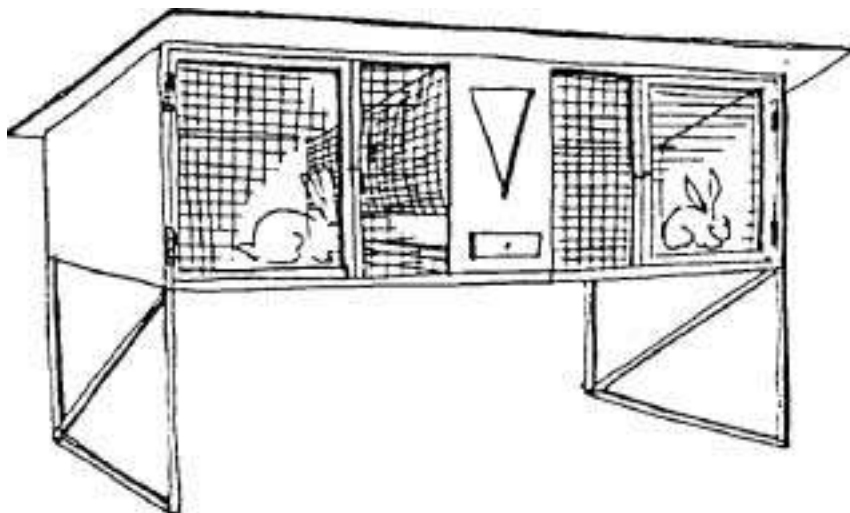

Figure 10: A two compartment hutch. Note the hay through between the compartments. For these cages a main building is not necessary.

You will always need individual hutches (figure 10), whether you have a stable or not. Many designs are possible but you should take the following factors into account:

- A favourable microclimate (Paragraph 6.1)
- Protection from predators (Paragraph 6.2)
- Doors, hinges and feeding troughs (Paragraph 6.3)
- Sizes of hutches (Paragraph 6.4)
- Hygiene and building materials (Paragraph 6.5)
- Maternity hutch and the nest box (Paragraph 6.6)

We shall discuss each of these points separately.

6.1 A favourable microclimate

Much has been said about rain, temperature, wind and sunshine when discussing the stable. By now, you will know what is desirable and what is harmful. For a hutch there are many more building materials which can be used. You can work with plastic, bamboo mats, corrugated iron, cardboard, wood etc. Even though some materials will not last long, they require little investment for the small farmer.

Remember: fresh air is necessary; draught is harmful; direct sunlight is unnecessary; a more or less stable temperature is best.

6.2 Predators

Predators are probably the most important matter. Too often rats, cats or dogs scare the rabbits by walking over the cage. They will eat young rabbits if they manage to enter the cage. Even if they do not enter the cage, the does may be so scared that they even eat their own young.

To make a cage rat-proof is very difficult but especially useful for the maternity cages. A rat will not easily attack a litter of 4-week old rabbits. You can use either wire, bamboo, wood, (galvanized) iron sheets according to availability and price (iron material has the definite disadvantage of rusty pieces falling off and hurting the animals either by cuts and wounds or after they have accidentally eaten it). Bamboo is not readily chewed upon by rats or rabbits (especially the hard side) but they do get through.

For the sake of hygiene the hard outside of the bamboo is best to be placed to the inside of the cage so that it is easier to clean (figure 11). This means that the soft side is left to the rat to eat from outside. Regular inspection is necessary, rats get through small holes, and once they smell blood.

If you place the bamboo splits close together no rat will get in but neither will light and fresh air get in, so sometimes wire may be better. Once again, especially poor quality wire, (common in the tropics) is not ideal for animal housing.

Another predator can be ants which reportedly can feast on a newborn litter. The only solution is to put the legs of the cage in cans filled with oil or kerosene.

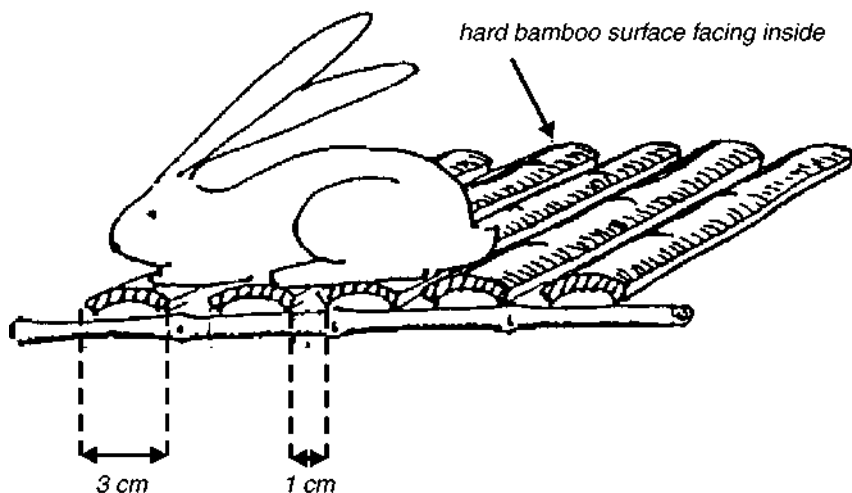

Figure 11: Use of bamboo as a building material

6.3 Doors, hinges and feeding troughs

Handling must be easy, this means that the door should open easily, cleaning must be easy (see next section on hygiene), the rabbit can be seen easily without having to open the cage, feeding should be easy, cleaning of feed and drinking water equipment should be easy, etc.

Doors

Besides swing hinges one can use a variety of other door designs such as the loose door (figure 12).

A door opening all cages at once is a possibility either as a loose frame or using hinges (figure 13).

If the doors swing sideways they will usually disturb the door of the neighbour's cage, especially if feeder troughs are at the outside. If you do not like the loose type, the upswinging type is probably the most

convenient. Another type is the door which opens from the top, but this is only practical if the cage does not have to be cleaned (pellet feeding on a wire cage).

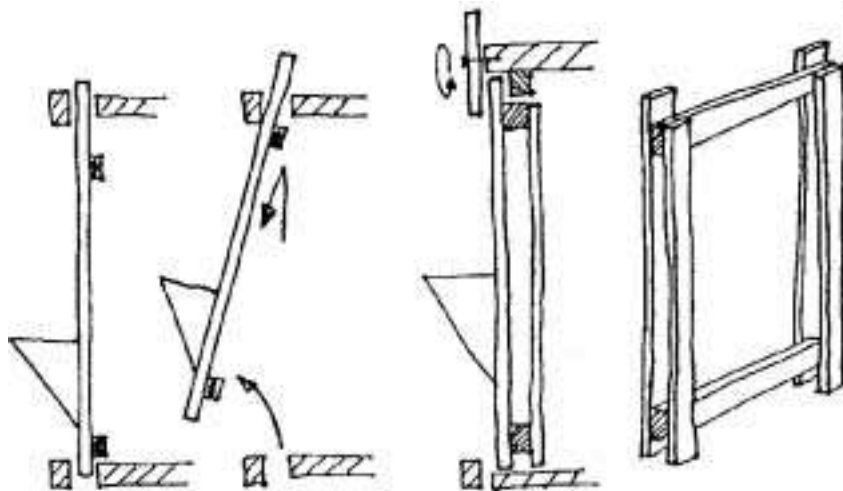

Figure 12: The use of loose doors

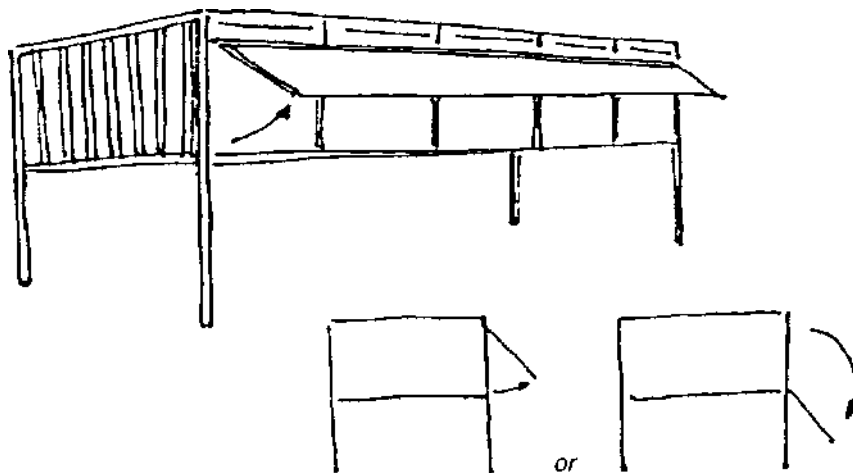

Figure 13: The use of one door for all cages together

Hinges

Hinges will usually not last long, in figure 14 you can see a cheap way of making strong hinges. Rubber, old chunks of leather or skin are used, an alternative is rope or twine and wire.

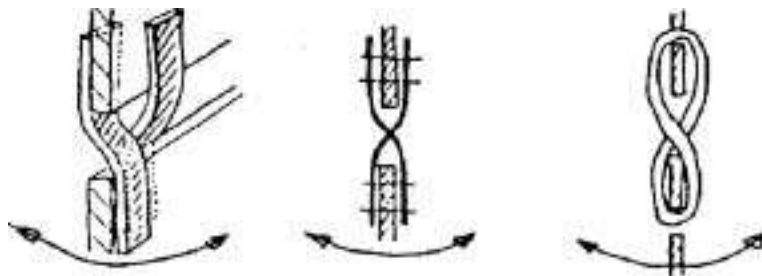

Figure 14: Cheap and strong hinges

Feeding troughs

The placing of the feeder: some have the trough for greens inside; this is not very practical. It is better to have it outside.

Four useful suggestions:

- 1 Do not put the trough loose inside because it will be knocked over, carried away etc.
- 2 Make a construction that lifts off easily (figure 15)
- 3 Make them easy to clean but so that ...
- 4 Spilling is reduced

Fixing them to the wall is best done with hooks (figure 15).



Figure 15: Hooks for fixing feeding equipment to the wall.

6.4 Sizes of hutches

Hutches should be about 0.75 m deep. Make the hutches 0.8 m long for small breeds (figure 16), 1.00 m for medium breeds and 1.20 m for large breeds. A height of 0.6-0.7 m is good, you might even make it a bit higher especially in the maternity cages where the doe likes to sit on the nest box.

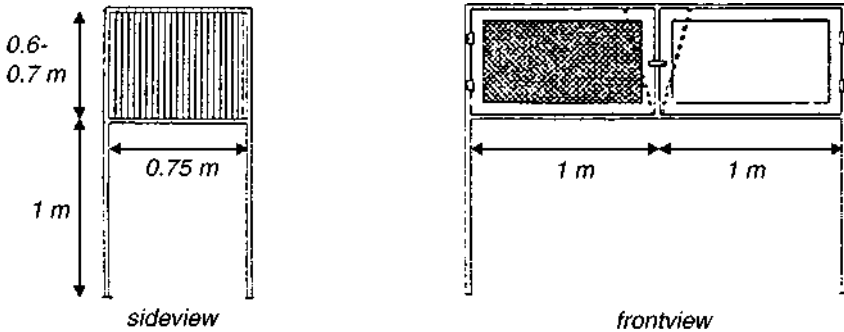

Figure 16: Size of the cage for a small breed

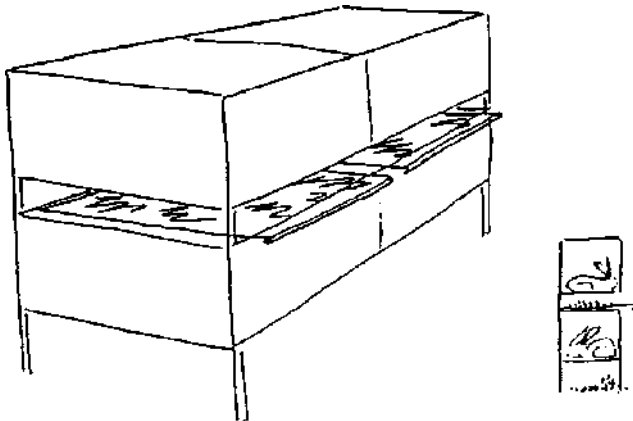

Figure 17: Two layer system using galvanized iron trays to catch manure from the top. Needs to be cleaned every day, saves space, costs, labour.

Where space is limited, it is possible in the tropics to keep two layers of cages (figure 17); for smaller animals (young and growing) three might be possible. But watch out, the hotter and the more humid it gets, the more space you will require to keep a good micro climate.

6.5 Hygiene and building materials

Let us now consider aspects concerning hygiene of the various materials you can use to construct the hutch. Most attention should be paid to the construction of the floor.

Wire for the floor has advantages, provided the maze is large enough to let the droppings fall through, it is probably the cleanest which is very important. However, watch the quality, do not get wire which easily rusts; it will break and may wound the animal. Do not use chicken wire, it is too sharp. Use holes large enough to let the droppings through, but small enough to make it possible for 3-week old rabbits to walk on (about 1.5 cm).

Wire floors may lead to sore hocks, a disorder to which larger (heavier) breeds are especially susceptible.

You may decide to put wire on the walls where animals do not step on it, corrosion will be slower, etc. It might also make the place a little lighter and easier to check besides being cleaner.

If you do not use wire, you can just as well use wood or bamboo. The bamboo or wooden slats should be close enough together to allow rabbits to walk on it, but wide enough to let the droppings fall through easily (figure 18). Clean the cage everyday thoroughly.

Try to make a construction where you have no “dead ends” to clean. Let the wooden slats or bamboo pieces run from the rear to the front, that is easier to clean than from the right to the left.

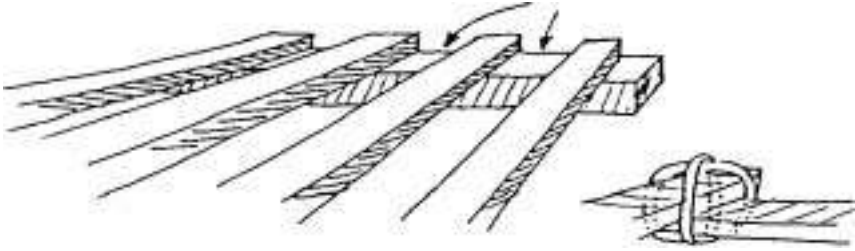

Figure 18: Dead ends in a cage constructed with wood.

One way of preventing floors from becoming increasingly dirty is to give every stable a loose floor which can be taken out once in a while, cleaned, disinfected (by the sun) and put back in. Another way is the one shown in figure 19: the back wall keeps the dead ends outside the cage.

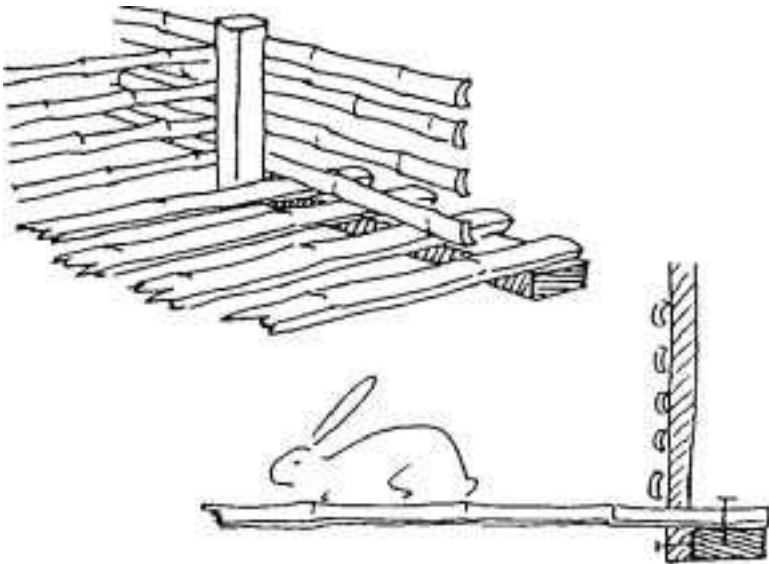

Figure 19: A way of construction to avoid dead ends in a cage.

6.6 The maternity hutch and the nest box

The maternity hutch is just an ordinary cage as described above. You could make it a bit bigger so that you can place a nest box in it. The nest box can be placed in the back of the maternity cage. You can also attach the nest box to the outside of the maternity cage, which makes for easier control of the newly born, but also needs a somewhat more complicated design (figure 20).

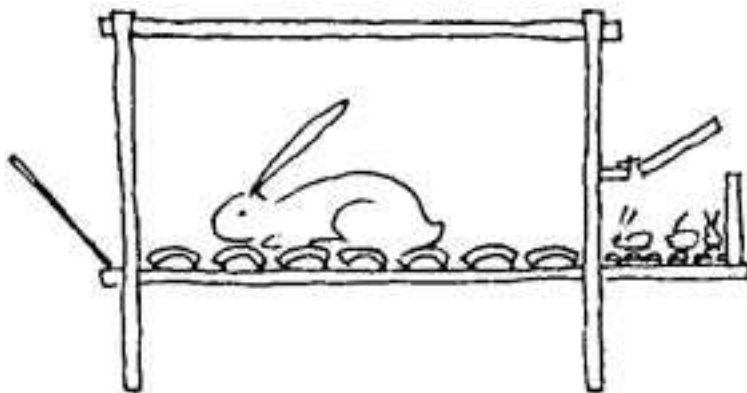
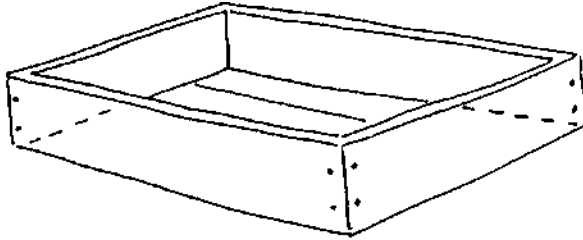

Figure 20: Nest box outside the maternity cage

There are many designs available for nest boxes. Its main function seems to be to give the doe a specific place to make a nest.

The drawings in figure 21 and figure 22 show there are open types and closed types.

- The advantages of open types are: easy checking of the litter and cheap and easy construction; the main disadvantage is the fact that they are so exposed (figure 21).
- The advantages of closed types are that they are not exposed and the doe has room to sit on top in a small hutch. The disadvantages are the complicated design which also makes it more difficult to check the litter (figure 22).



A. Open type nest box

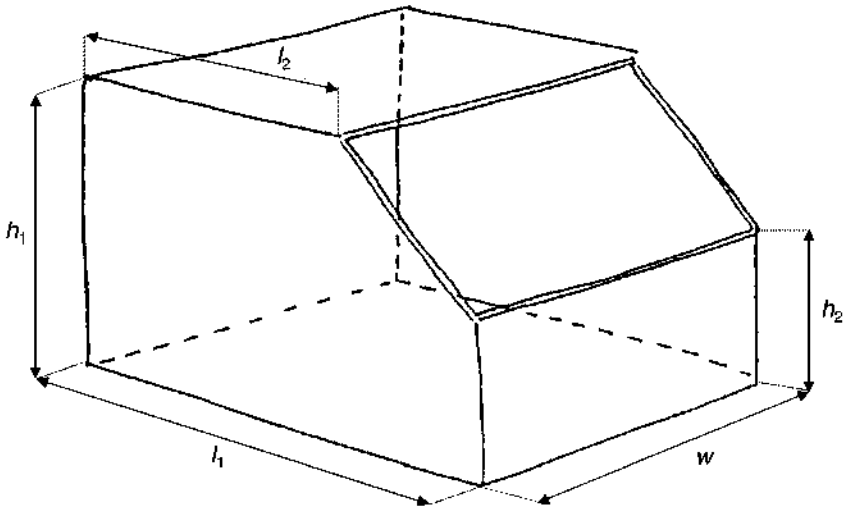

B. Half-open type nest box

Figure 21: Nestbox

Sizes vary with the size of the breed. The table provides some guidelines:

	l_1	l_2	w	h_1	h_2
medium breeds (cm)	40	25	30	25	10
large breeds (cm)	45	30	35	25	15

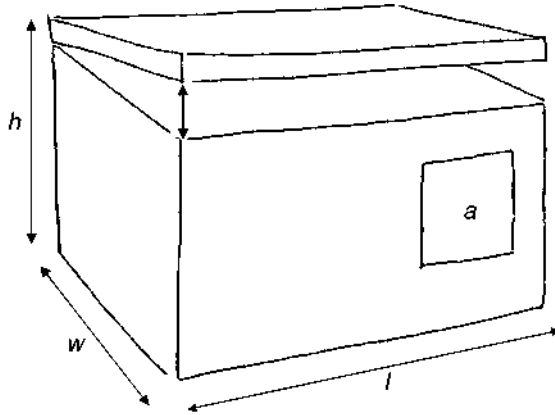

Figure 22: Close type nest box

6.7 Conclusions

It is perfectly possible to construct the whole stable including posts, supporting layers, etc. from bamboo. However, the whole construction is somewhat easier, neater, straighter, stronger and longer lasting if you use wood for the frame and use bamboo for the “closing up”.

Maybe you have no bamboo or scrap iron, no wire but a lot of wood, maybe you have mud only and some thick sugar cane stalks, or you can use teakwood since you have a teakwood sawmill as a neighbour.

Do not make a large outlay at once, try one, two or three models first, after a month you will know a lot more, and you will not buy a 100 rabbits the first time either. There is no perfect model, everything has advantages and disadvantages. Keep in mind economy and hygiene (slatted floors, no straw if not necessary).

Nest boxes can be made from all kinds of materials. Remember however that hygiene is of utmost importance. Use smooth or easy to clean materials (bamboo can certainly be used), watch out for nails or sharp edges and make the bottom with holes so urine can escape. Plywood is a good material to use with wooden ribs (corners). The bottom should be made slatted, e.g. using small (bamboo) sticks.

7 What feed to give

It is beyond the scope of this booklet to explain the basics of animal nutrition. There are enough other practical booklets to help the interested reader (see the literature list at the back). Here we just outline some main principles. For those who already have some training in nutrition, we include a list of feeding requirements of rabbits in Appendix 2. However, if you know the requirements of the rabbits, but you do not know the feeding value of the feed available, you will not be able to use this information. Laboratories are not always available and, moreover, a laboratory analysis does not say much if you do not know the digestibility of the feed, which is difficult to measure. Books will show rations as used in country A or B, but this is not very useful either. For example: ricebran in Sri Lanka is not the same as ricebran in Zaïre (although similar) or, ricebran may be cheap in Thailand but very expensive in Tanzania. For real advice about your specific feed situation, it is better to contact local specialists at universities or experimental stations. Do not forget to take into account prices, seasonal availabilities, possibilities of storage, etc.

7.1 Water requirements

Before we deal with feeding requirements, let us first have a look at the need for water. Water is not considered a nutrient. But this does not mean that the rabbit does not need water. Many people claim, that a rabbit does not need drinking water, because food like grass, cassava leaves or sweet potato tubers contain water already. Indeed in quite a few places rabbits do not regularly receive drinking water and still others never receive drinking water but they still reproduce, grow and seem to go unharmed. In fact, it may be difficult to get those animals used to drinking water. But general advice has to be: give them clean water. They may do without, but they will do better with water. Expense is nil; work of course is added and sometimes the water gets dirty and starts to smell. With proper care and equipment, clean water

should, and can become a routine. In figure 23 some drinking equipment designs are given.

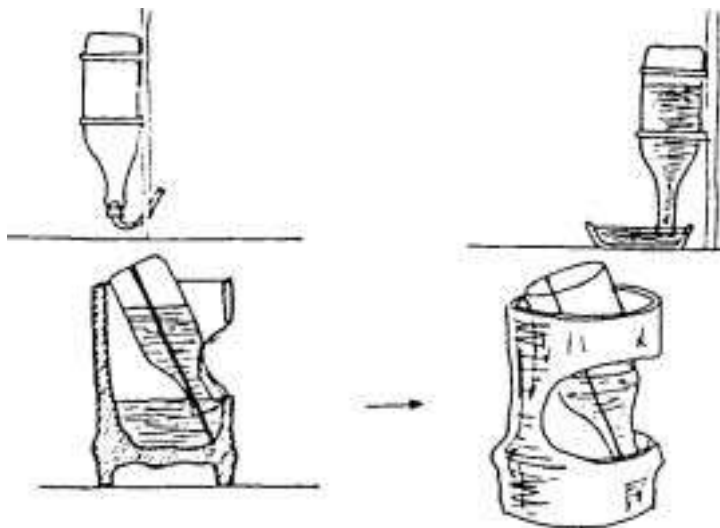

Figure 23: Designs of drinking equipment

7.2 Feed

Proper feeding will influence the rabbit's growth, fertility and health. Some foodstuffs contain a lot of protein (especially fresh greens), some are sources of energy (like ricebran, tubers, etc). Both protein and energy, as well as minerals are of importance.

To start with, a rabbit will benefit from greens. These are grass, leaves, vegetables, etc. Watch out for possible poisoning like from cassava leaves or other plants. Usually the local population is aware of which plants are poisonous. But leaves or grass are not all the same. Young (4-weeks old) grass is easier to digest and contains almost twice as much protein as 8-weeks old grass. Leaves are much more nutritious than stems. Try to find grass with a lot of leaves therefore. However succulent the stem may seem, feeding value is low generally.

You are lucky if you live close to a market where cabbage leaves, carrots, bananas may be thrown away (watch out for herbicide/pesticide residues). It is also possible to feed rabbits left-overs from the kitchen or the local restaurant. Watch out for glass and other impurities! If you have a lot of that kind of feed, you might consider buying a small pig.

Just like humans, rabbits also need variety in their diet. It is better to add something starchy (contains much energy) to their feed. Good candidates for this are: ricebran, (cassava) tubers, waste carrots, corn (expensive!), rice left over from the kitchen.

The amount of feed to give a rabbit depends very much on the state of production. A lactating mother needs a lot of concentrate feed (grain, tubers) besides greens, to maintain her bodyweight and produce milk for her young. Young rabbits also need some concentrated feed for growing, as we have seen recently in a simple experiment. We had four groups of six animals each, that were just weaned. One group received grass only (of doubtful quality) and all the rabbits died. The other 3 groups received supplements and none died. It may pay to give sick animals some commercial pelleted broiler or chicken feed. If you feed meal it is better to moisten this a little bit, otherwise the rabbit will not eat it.

Apart from energy and protein, minerals are also an important ingredient in the diet. Greens and concentrates contain a lot of minerals. Nevertheless it is advisable to add some minerals in the form of salt to the food. For example, when feeding ricebran, one spoon of salt mixed with 1 kg of bran will be sufficient.

If there is a local specialist or experienced breeder around ask them what they advise about the supply of minerals.

7.3 Growth rates of rabbits

It is a good idea to weigh your animals regularly (for example every week). By measuring growth you have a much better idea of the well being of your animals than by visual observation only. Growth rates of around 15-20 grams per day are common in the tropics even though it is possible to obtain 30-40 grams per day on very good food. Don't

forget that the animal reaches highest growth rates in the first months. After becoming mature the body weight will remain constant. So if your animals start growing less, besides diseases or bad feed, age might be the factor!

Do not feed for the fastest growth but try to find a balance between growth and general health, perfect feed and less than perfect feed. Even though rabbits may subsist on greens alone, young growing animals and does especially need supplements with preferably some grain (corn, ricebran), to stay healthy, grow and reproduce.

7.4 Some practical remarks

- Do not change feed suddenly.
- Do not get desperate if animals don't like seemingly good feed at first glance. Try it for a few days, if necessary starve them a little. The rabbit is notorious for its likes and dislikes which are difficult to predict.
- Greens should not be too wet, because it will upset the stomach and cause trouble, diarrhoea and death.
- Do not feed more than they will eat; remove old (mouldy, dusty) feed. Ricebran and oil seed cakes in particular have the tendency to become rancid, so do not feed that too much. Give the leftovers to other animals.
- Cooking the feed will probably not justify the effort (in general).
- A good feeding method is to give concentrate (ricebran, corn, roots) during the day and feed greens overnight. This is also done to avoid attracting rats during the night time.
- Did you know that the rabbit practices coprophagy or pseudo-rumination? That is the consumption of faeces and thus the rabbit recirculates a part of the feed through the body. During the night the rabbit produces a soft faecal pellet, not like the well known small dry "marbles", but more like a longer shaped wet sausage. The rabbit eats these again but will not touch the dryer pellets. Coprophagy occurs also with other animals to a lesser or a greater extent (e.g. monkeys).

8 Sick animals

The main causes of mortality in rabbits are probably intestinal problems. Second are diseases of the respiratory organs. These are sometimes an indirect consequence of intestinal problems causing lower resistance. Third are a whole group of diseases of which myxomatosis is probably the most well known but least occurring disease. Problems of skin parasites are bothersome but hardly ever fatal and are easily cured. In the list of literature you will find some references to excellent literature dealing specifically with rabbit diseases. There is also a list of most common diseases, causes, diagnoses and cures in Appendix 2.

The emphasis of this present chapter will however be on the prevention of disease. Prevention is easier, cheaper, and it is the most logical thing to do. Only if “bad luck” strikes, does curing come in, but success even then is far from guaranteed and medicine is often not easy to get and may cost you a lot of money.

8.1 Prevention of diseases

Some steps to prevent disease problems in your herd are:

- 1 Try to avoid buying at the marketplace where many unknown germs come together. Try to buy from respected breeders, or farmers with clean housing and healthy looking animals. Inspect the animals anyway and after bringing them home keep them separated from your other animals (quarantine) for at least 2 weeks.
- 2 Make routine checks on the health of your animals on the following points:
 - Check nose, eyelids, ear edges for mange (little crusts), inside the ear for ear mite.
 - Check the manure, is it dry or somewhat pasty.

- Feel the stomach, to check that it is not spongy. This requires some practice.
 - Check nose and front legs, certain coughs produce a kind of snot which then makes the front legs dirty.
 - Check for the smell in the hutch, diarrhoea/enteritis often causes a dirty smell. When the doe is lactating she is under stress and more liable to suffer an attack from intestinal germs (always present) such as coccidiosis. Sometimes the nest box needs cleaning.
- 3 Make a hutch design and use materials which permit easy cleaning. In this respect bedding (straw, etc.) has more disadvantages in the warm tropics than advantages. So do not use bedding although in Europe or USA that is the way it is (or was) done.
- 4 Clean the hutches every day, keep them dry.
If you suspect disease, disinfect! Certainly you will have all kinds of local disinfectants like carbol, creoline, lye solutions (lime, sodium), Teepol, formaline or formol (watch out; very strong); if necessary you can use kerosene if nothing else is available. Do not forget soap or bleaching agents like soaps containing chlorine. Not all, but most of these disinfectants have a strong smell which hurts the respiratory tract of man and animal alike. Keep the animal away if you are cleaning with the stronger agents and do not put it in a cage which still smells. A good and harmless disinfectant, always cheap but not always available is sunshine. Fire (a small gas flame) is okay but has obvious disadvantages.
- 5 Keep animals away from their manure; slatted floors and no (deep) litter are to be preferred.
- 6 Separate animals you suspect are ill so they do not infect healthy animals.
- 7 If you want to be really careful, do not let visitors get close, have a bath with disinfectant at the doorstep and add your own variations on this road to 100% infection prevention.

8 Clean fresh air in the stable is essential, a strong manure smell is no good, even though there are large differences between individual noses, your own nose is your best measuring guide. If you cannot stand it, the rabbits probably cannot either.

8.2 Intestinal problems

One expert notes that instead of talking about coccidiosis, bloat, enteritis, diarrhoea, etc. it is better to talk of the “enteritis complex”. For our practical purposes this is quite sufficient.

➤ *Prevention*

This is almost the same for all of the subcauses. Keep the animals away from their manure. Clean the stables every day. Do not give excessive wet feed. (Note, however it is probably not the wet feed alone causing the “enteritis complex”. Rather, the intestine gets so disturbed by feed that is too wet that the disease agents have more opportunity to attack.) Give the animals good quality feed.

➤ *Causes*

There are a variety of intestinal parasites besides bacteria. Specific feed factors can cause a lot of gas to be developed (bloat) or reduce the rabbit’s resistance.

➤ *Symptoms*

Diarrhoea, no appetite (anorexia), listlessness, loss of weight (check the two bones at the end of the back beside the spine), wet or dirty rear, blown up and/or spongy feeling abdomen.

Not necessarily all of these symptoms show up clearly or at the same time! A fatal liver coccidiosis for example hardly ever gives diarrhoea. After slaughtering some animals you’ll soon get an idea of what is a normal intestinal mass and what is abnormal. A large liver with white spots is caused by liver coccidiosis. To determine other causes some laboratory equipment is needed, for example a microscope, which is beyond the scope of this booklet.

➤ *Treatment*

Give good quality, drier feed to help to rearrange the intestines. Treatments with sulfa medicine can be very helpful, especially as a preventive measure. Severely dehydrated (skinny) animals, as a result of diarrhoea, should be forced to drink by “injecting” water or milk, etc. in the mouth. The water should preferably contain some salt and sugar (9 g salt + 9 g sugar/litre water). A quantity of water of 10-20% of body weight gives you an idea of how much liquid to give. There is a variety of sulfa medicines available; doses you will find in the appendix of this booklet. Literature recommendations usually suggest mixing these sulfas or other medicines with drinking water or concentrate. This does not help a sick animal which has already stopped eating and drinking. Use the injection needle to drench the animal (see figure 24).

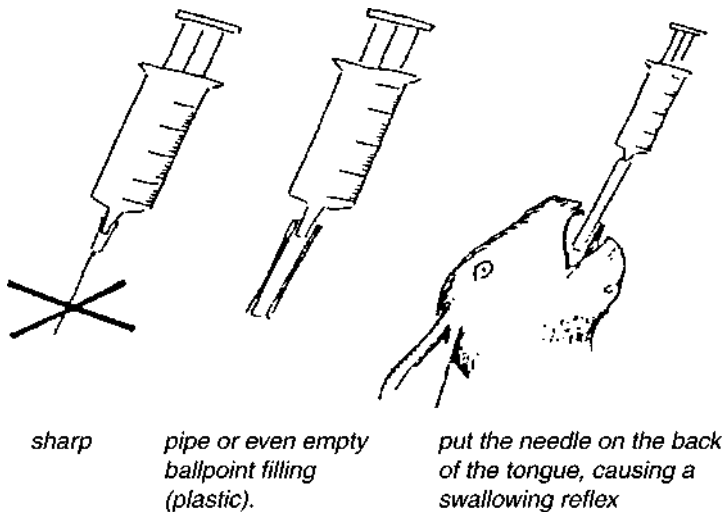

Figure 24: Drenching an animal with an injection needle

Lactating does are especially likely to develop “enteritis complex” (mainly coccidiosis) thereby infecting their young at the difficult start of their existence. Therefore many young will have severe troubles at 4-7 weeks with “enteritis complex”.

Advice: after kindles leave the box, give doe and kindles a preventive cure with sulfa. Sulfa given to prevent coccidiosis also significantly impedes the occurrence of other intestine problems!

8.3 Problems of the respiratory tract

There is a variety of coughs, sneezes, pneumonia, causing sudden deaths which are difficult to distinguish for a non-expert. They are not always caused by bacteria like pasteurellosis, and medicinal cures are rarely successful.

➤ *Prevention*

Ensure fresh air, dustfree and clean surroundings; separate sneezing animals and slaughter them or sell them to the butcher if you think that you have a good replacement.

➤ *Symptoms*

Sneezing, coughing, dirty front legs because they are used as a “handkerchief”, noisy respiration. Not all cases die, some live and kindle as they are supposed to; sometimes death occurs quite unexpectedly. On opening the dead animal you’ll see that “healthy” and “sick” animals are alike, there will be few with 100% clean lungs. Nevertheless there are cases in which the lungs are so bad that one wonders why the animal did not die a long time before.

➤ *Treatment*

Besides some antibiotic treatments, not much can be done which has not been described in the section on prevention.

8.4 External parasites

A few pages back we discussed coccidia as part of the enteritis complex. There is no doubt that coccidia should be considered a parasite. The same is true of all kinds of worms such as tapeworms and roundworm which occur in rabbits but are rarely mentioned as important causes of mortality. Therefore let us turn to two kinds of really harm-

ful species which are not internal (inside) like worms and coccidia but which are external parasites; skin mange (scabies) and ear mite.

➤ *Prevention*

Do not bring in dirty animals from other places, clean the stables throughout, keep careful watch on nose, ears (inside and edge), eye lids and sexual organs for infected skin.

➤ *Symptoms*

These parasites rarely cause death but are a bother. Sometimes they may heal spontaneously. The scabies/skin mange gives a flaky appearance (usually white) starting at the nose, and then onto eye lids, ear edges, sexual organs, under the forelegs and other hidden places. The ear mite forms a more blood coloured, pasty, dirty mass inside the ear, which may sometimes cause other ear infections.

➤ *Treatment*

This can be completely effective if the instructions going with the medicine are followed carefully. With good insecticides like NEGUVON or ASUNTOL (also other tick medicines either for cattle, dogs or cats) bathe the animal completely to eradicate the parasites. You should keep the nose and mouth above surface. Make sure to use the right concentrations, and do not use cold water in a cold place. The animals will dry off by themselves (sunshine or other warmth will help). If you do not bathe them completely, the parasite will keep coming back from its hiding place. Use the bathing water to clean the stable walls and floor to kill the parasites there. Often other local medicines can be effective (like sulphur solutions). A definite disadvantage of oil (although effective) is its dirtiness. Moreover, just like kerosene it gives a burning sensation. If you do not believe that, put some gasoline or kerosene on your upper lip!

8.5 Other diseases and health problems

Use common sense. The most common problems are: sore hocks (appears to be hereditary), lame animals (variety of causes), injuries, sore

breasts, mastitis. Do not waste too much time waiting to see what will happen. Use your time and energy for more relevant matters, eat the animal or let somebody else eat the animal. Besides being practical, you will save the animal a lot of suffering. In the long run you are selecting the best and healthiest animals for your further breeding.

9 Proper administration

Many things need to be taken into account with rabbit keeping: expenses for stable building, feed prices, purchase price of animals, etc. But let us not talk about bookkeeping although important! Most important from the management point of view is the registration of your animals: when they mate, when they kindle, who is their father or their mother, do they show disease, how fast do they grow, and so on and so on. In order to keep track of this information, proper administration is very useful.

9.1 Identification methods

First it is important to give your individual animals identification:

colour patterns and size is one way to do it but if you have 5 white does you might lose track. You can make a tag (piece of plywood, cardboard, or from a tin can which is flattened out) to hang on the cage of each animal. Either you give them names, numbers or both. At the same time you can write on this “tag” the date of mating and the date of kindling (figure 25).

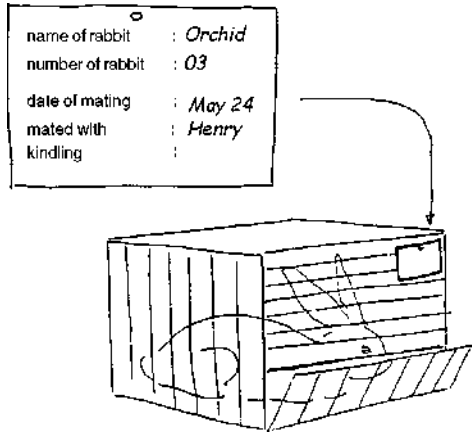
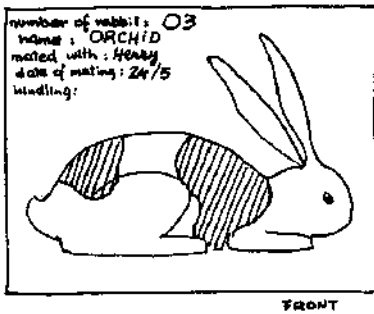
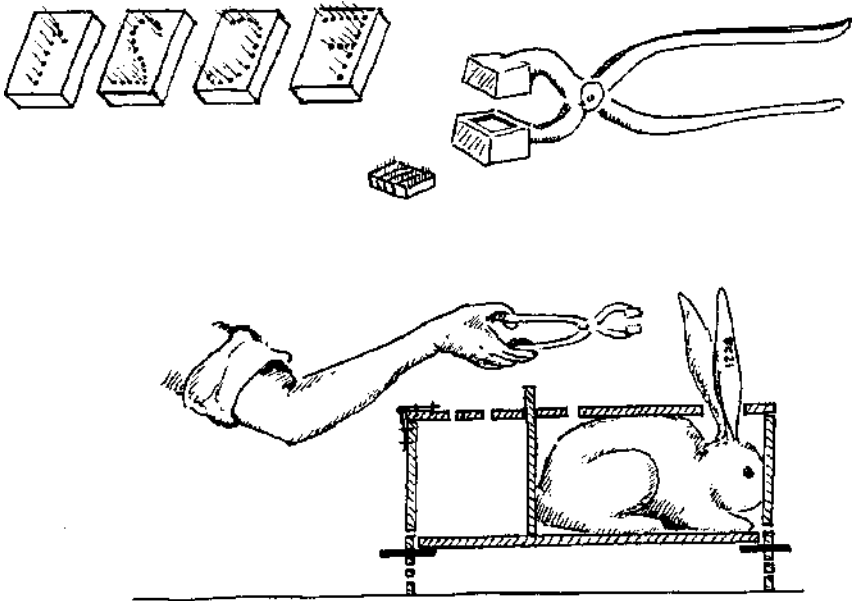

Figure 25: Cage tag with details of the rabbit

If you use blackboard paint you can use regular chalk, which later can be cleaned and used again once you have shifted the data to the special book. Every time you move the rabbit to another hutch, the identification tag accompanies him or her, with the risk of getting confused!

The best system is to use a tattoo with which numbers are punched in the ear. This number can also be written on the tag outside the door.

If you don't have too many rabbits it is easy enough to identify them individually especially if you have spotted animals. A simple drawing of each animal can help you to identify them (figure 26).



FRONT

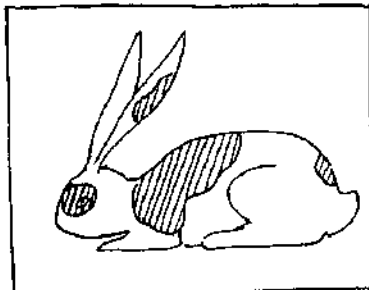

BACK

Figure 26: Identification of the rabbit

9.2 The record-book

It is a good idea to keep a book with information on each of the rabbits. Even better are cards or a book with loose pages so you can rearrange the pages if necessary (figure 28).

It is important that you know what happens to which animal at which time, if only to prevent inbreeding. Young rabbits intended for breeding can be given an ear number or simply a card or board on their cage when they start breeding.

At that time you give them a page in your book or a card in the box. Another important thing which you might consider noting is the individual weight of each rabbit.

9.3 The calendar

By watching the animals closely you can check daily if some are ready to be mated or to litter, or to wean and so on. However you may also devise a calendar to keep watch on the daily happenings (figure 27).

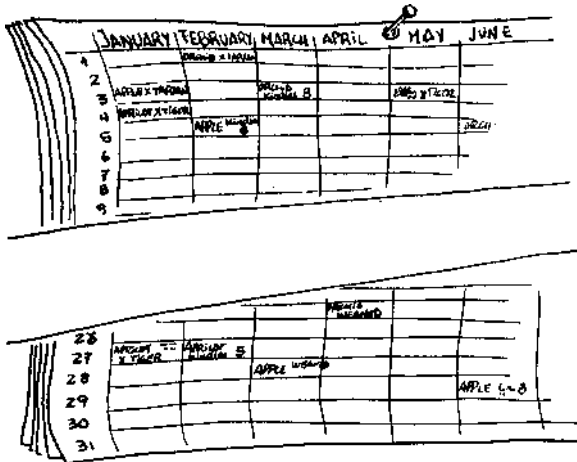
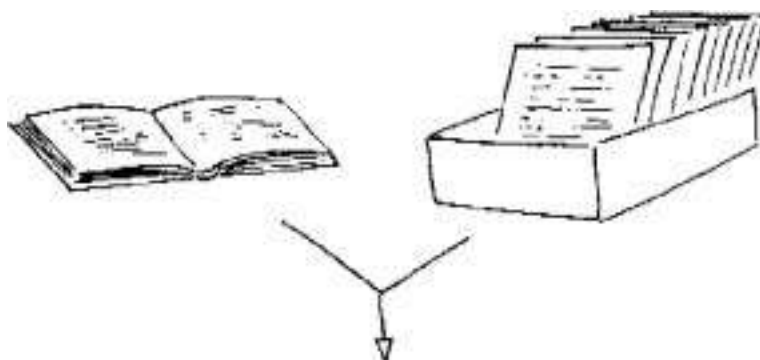

Figure 27: A calendar with important data



HUTCH CARD								
Animal No. W5		Born 12/12/81		Breed NZ White				
Sire W1		Dam W4		Litter No. W6				
Date bred	Buck No.	Date kindling	No. kids alive	No. kids dead	Number young retained	Litter No.	Date weaned	Number weaned
6/1/82	W18	7/2	11	0	8	W9	8/27	8
8/24/82	W18	9/24	9	0	8	W10	11/49	8
11/16/82	W18	Passed	11/30					
11/30/82	W21	12/30	9	1	8	W16	2/24/83	8
2/2/83	W21	3/24	11	0	8	W18	5/19	7

Front

PRODUCTION RECORD				
Litter No.	WEANING			NOTES:
	Number	Age	Weight	
W9	8	56	30.2	
W10	8	56	31.0	
Passed	11/30			
W16	8	56	32.0	
W18	7	56	28.0	

Back

Figure 28: Record keeping with cards

Explanation to figure 27:

Let us say that if your doe APPLE mates on 3/1 with male TARZAN you write that down. Since she will be pregnant for just about one month, the next month, 3/2 you will expect her to kindle. So by checking the date on your calendar you know what to expect on that day. If you want to write more on your calendar, make the boxes bigger. An alternative system is that shown in figure 29.

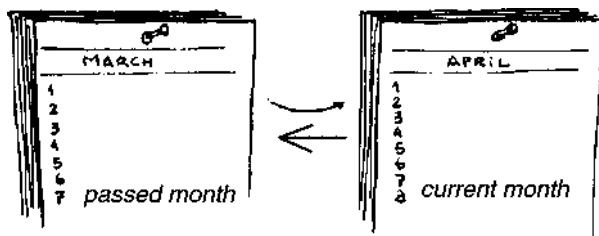

Figure 29: Calendar cards with important data

10 The process of tanning

The commercial demand for the pelts from homestead livestock is in many countries very low. The prices are low because of the small quantity and high transport prices. It is generally more economical to use the skins in the compost heap rather than sell them because they are high in both nitrogen and phosphorus.

However, this does not mean that pelts from the homestead herds are useless. On the contrary, anyone who is interested can do an acceptable job of tanning these skins for use in a variety of craft projects.

Tanning can be a quite complicated and tedious job, and there are many tanning solutions that are difficult to obtain. Quite a few tanning techniques are described in “Rural Tanning Techniques”, a FAO publication which is for sale in many countries.

Here we will describe a method which has been used by many homesteaders with great success, and which calls for ingredients that are readily available.

While this solution can be used for any type of fur, we are concerned here with rabbit skins. If you are tanning for the first time you will feel more at ease with a rabbit skin than with something large like a cow hide.

The tanning agent in this method is sulphuric acid. To make it even simpler, use battery acid, available from any garage or auto supply store. Battery acid is dilute sulphuric acid. Be careful with acid because it is very dangerous. If you get it on your skin you will be badly burned. When it is diluted with water it is less dangerous. Never pour the water in the acid but always pour the acid into the water carefully.

This is what you need:

- 60 g of sulphuric acid or 240 g of battery acid
- 1 kg of salt (any cheap kind)
- A 10-20 litre crock or similar non-metallic container, a plastic bucket will do.

- 7 litres of water
- A weight (non-metallic) to hold down the skin in the solution: a glass jug filled with water, a brick or rock or anything similar.

Add the salt to the water. Then tip your container and let the acid dribble down the side into the water. Never add water to acid and be careful not to let it splash because it is a very dangerous liquid. Stir the solution with a wooden stick. At this point the acid is diluted enough so it is quite safe, even if it touches your skin. Keep the temperature as close as possible to 21°C. Higher temperatures can damage pelts and lower temperatures slow down the tanning process. Now you are ready to tan.

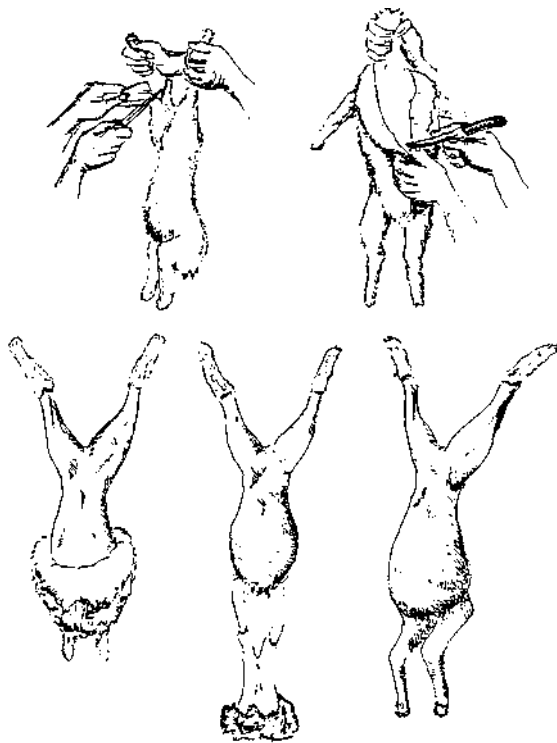

Figure 30: Skinning a rabbit

Time consuming steps such as fleshing, stretching and drying are eliminated with home tanning.

- Rinse the skins in a bucket of cold water with one cup of salt to two litres of water. According to some people the salt seems to aid in the fleshing process described later.
- Wash the skin in warm water and detergent and squeeze out the excess water. Never wring a fur, always squeeze it out gently.
- Finally put the hide into the tanning solution (be sure the salt has dissolved), swish it around a little with a wooden stick and weight it down to keep it from floating.
- A small hide will be ready in about 3-4 days. It does not matter if you leave the pelts in the solution for more than 4 days, as long as they are stirred from time to time.
- When the skin is ready it is taken out, washed in detergent and rinsed in cold water. At this point the fat and flesh should separate from the hide easily. If it is really good and you are very careful, you can separate the flesh from the hide in one single piece.
- After fleshing, wash and rinse again and return to the tanning container for another week or longer.
- Finally, run it through a wash-rinse-squeeze process. Hang it in a shady place to drip dry. While it is still damp and limp, put it in a tumbling container, like a clothes-dryer. If the skin is too wet, it will not tumble properly. Tumbling is important to 'break' the skin. Breaking is gently pulling and stretching small areas of the skin in different directions (figure 31). The stiff brown hide will turn white and soft. If a tumbling container is not available the breaking of the skin will be a little more difficult and will take more time.

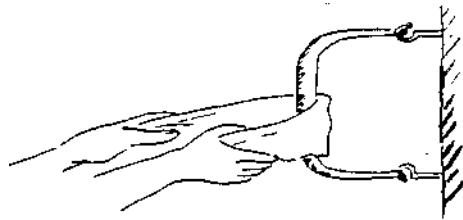

Figure 31: Breaking of the skin

Appendix 1: Recommended chemical composition of feeds for intensively reared rabbits of different categories

Components of feed, assumed to contain 89% dry matter	Unit	Growing rabbits (4-12 weeks)	Lactating doe + young under mother	Pregnant doe, not lactating	Resting adults (males)	Mixed breeding does + fatteners
Crude proteins	%	16	18	16	13	17
Amino acids:						
Methionine + Cystine	%	0.60	0.60	-	-	0.60
Lysine	%	0.65	0.75	-	-	0.70
Arginine	%	0.90	0.80	-	-	0.90
Threonine	%	0.55	0.70	-	-	0.60
Tryptophane	%	0.18	0.22	-	-	0.20
Histidine	%	0.35	0.43	-	-	0.40
Isoleucine	%	0.60	0.70	-	-	0.65
Phenylalanine + Tyrosine	%	1.20	1.40	-	-	1.25
Valine	%	0.70	0.85	-	-	0.80
Leucine	%	1.05	1.25	-	-	1.20
Crude fiber	%	14	12	14	15-16	14
Indigestible crude fiber	%	12	10	12	13	12
Digestible energy	Kcal/Kg	2 500	2 600	2 500	2 200	2 500
Metabolizable energy	Kcal/Kg	2 400	2 500	2 400	2 120	2 410
Fats	%	3	3	3	3	3
Minerals:						
Calcium	%	0.40	1.10	0.80	0.40	1.10
Phosphorus	%	0.30	0.80	0.50	0.30	0.80
Potassium	%	0.60	0.90	0.90	-	0.90
Sodium	%	0.30	0.30	0.30	-	0.30
Chlorine	%	0.30	0.30	0.30	-	0.30
Magnesium	%	0.03	0.04	0.04	-	0.04
Sulphur	%	0.04	-	-	-	0.04
Cobalt	ppm	0.1	0.1	-	-	0.1
Copper	ppm	5	5	-	-	5
Zinc	ppm	50	70	70	-	70
Iron	ppm	50	100	50	50	100
Manganese	ppm	8.5	2.5	2.5	2.5	8.5
Iodine	ppm	0.2	0.2	0.2	0.2	0.2
Fluorine	ppm	0.5	-	-	-	0.5

Components of feed, assumed to contain 89% dry matter	Unit	Growing rabbits (4-12 weeks)	Lactating doe + young under mother	Pregnant doe, not lactating	Resting adults (males)	Mixed breeding does + fatteners
Vitamins:						
Vitamin A	UI/Kg	6,000	12,000	12,000	6,000	10,000
Vitamin D	UI/Kg	900	900	900	900	900
Vitamin E	ppm	50	50	50	50	50
Vitamin K	ppm	0	2	2	0	2
Vitamin C	ppm	0	0	0	0	0
Vitamin B1	ppm	2	-	0	0	2
Vitamin B2	ppm	6	-	0	0	4
Vitamin B6	ppm	2	-	0	0	2
Vitamin B12	ppm	0.01	0	0	0	0.01
Folic acid	ppm	5	-	0	0	5
Pantothenic acid	ppm	20	-	0	0	20
Niacin	ppm	50	-	-	-	50
Biotin	ppm	0.2	-	-	-	0.2

Source: Lebas, 1979; Lang, 1981, The Rabbit: husbandry, health and production

Appendix 2: Common diseases of rabbits, their symptoms, causes, treatment and control

Diseases and symptoms	Cause	Treatment and control
Ear mange or Canker: Shaking of head, scratching of ears, brown scaly crusts at base of inner ear	Ear mites: <i>Psoroptes cuniculi</i> (rabbit and goat ear mite) and <i>Notoedress cati</i> (cat ear mite)	Into each ear, pour 1 oz. of a 5 percent limesulphur solution (prepared by mixing commercial 30% limesulphur concentrate: 1 part with 5 parts of water)
Skin mange: Reddened scaly skin, intense itching and scratching, some loss of fur	Mites: <i>Cheyletiella parasitivorax</i> (rabbit fur mite) and <i>sarcoptes scabiei</i> (scabies or itch mite)	Dip entire animal in a 1.75% limesulphur bath (prepared by mixing commercial 30% limesulphur concentrate, 8oz. laundry detergent: 1 tablespoonful per gallon tepid water). Repeat in 2 weeks if necessary. Rubber gloves advisable.
Favus or ringworm: Circular patches of scaly skin with red elevated crusts. Usually starts on head. Fur may break off or fall out.	Fungus: <i>Trichophyton</i> and <i>Microsporum</i>	Griseofulvin given orally at the rate of 10 milligrams per pound body weight for 14 days. Combine this treatment with dusting nest boxes with industrial fungicidal sulphur. Can also be treated with a brand of hexetidine. Apply to infected area for 7-14 days.
Sore hocks: Bruised, infected or abscessed areas on hocks. May be found on front feet in severe cases. Animal shifts weight to front feet to help hocks.	Bruised or chafed areas become infected. Caused by wet floors, irritation from wire or nervous "stompers".	Small lesions may be helped by placing animal on lath platform or on ground. Advanced cases are best killed. Medication is temporarily effective.
Urine-hutch burn: Inflammation of external sex organs and anus. Area may form crusts and bleed and, if severely infected, pus will be produced	Bacterial infection of the membranes.	Keep hutch floors clean and dry. Pay particular attention to corners where animals urinate. Daily applications of lanolin may be of benefit.
Spirochellosis or vent disease: Similar lesions as produced by urine or hutch burn. Raw lesions or scabs appear on sex organs, transmitted by mating.	Spirochete: <i>Treponema cuniculi</i> .	Inject intramuscularly 100,000 units of penicillin. Do not breed until lesions heal. If only a few animals are infected, it is easier to kill than to treat. Do not loan bucks.

Diseases and symptoms	Cause	Treatment and control
<p>Conjunctivitis or weepy eye: Inflammation of the eyelids. Discharge may be thin and watery or thick and purulent. Fur around the eye may become wet and matted.</p>	<p>Bacterial infection of the eyelids. Also may be due to irritation from smoke, dust, sprays or fumes.</p>	<p>Early cases may be cleared up with eye ointment, argyrols, yellow oxide of mercury or antibiotics. A combination of 40,000 units of penicillin and 0.5 grams of streptomycin to each 2 ml. For eye infections drop directly into eye. Protect animals from airborne irritants.</p>
<p>Heat prostration: Rapid respiration, prostration, bloodtinged fluid from nose and mouth. Does that are due to kindle are most susceptible.</p>	<p>Extreme outside temperature. Degree varies with location and humidity.</p>	<p>Reduce temperature with water sprays, foggers. Place wet burlap in hutch or wet the animal to help reduce body temperature.</p>
<p>Coccidiosis, intestinal: Mild cases, no symptoms; moderate cases, diarrhea and no weight gain. Severe cases have pot belly, diarrhea with mucus and pneumonia is often secondary.</p>	<p>Parasitic infection of the intestinal tract caused by coccidia (<i>Eimeria perforans</i>, <i>E. magna</i>, <i>E. media</i>, <i>E. irrisidua</i>).</p>	<p>Keep floor clean and dry, remove droppings frequently. Prevent fecal contamination of feed and water. Add feed grade sulfaquinoxaline so that level will be 0.025%, feed 3-4 weeks. Water soluble sulfaquinoxaline can be added at level of 0.025% and fed 2-3 weeks. These treatments combined with sanitation will greatly reduce numbers of parasites and animals infected.</p>
<p>Enteritis, bloat or scours: Loss of appetite, little activity, eyes dull and squinted, fur rough and animals may appear bloated. Diarrhea or mucus droppings, animals may grind teeth. Stomach content fluid, gaseous or filled with mucus.</p>	<p>Unknown. Never has been shown to be infectious or transmitted to other animals.</p>	<p>Add 0.5 gr. Furazoladine per ton of feed to give final concentration of 0.0055%. Feed intermittently or continuously. Water soluble chlor-tetracycline at a level of 1 pound to 100-150 gal. of water may be used for treating individual cases, too costly for herd control.</p>
<p>Caked breasts: Breasts become firm and congested, later hard knots form at sides of nipples. Knots may break open, showing dried milk.</p>	<p>Milk not drawn from glands as fast as formed, because too few young or young not nursing sufficiently. Usually a management problem with high milk producing does.</p>	<p>Do not wean young abruptly. If litter is lost rebreed doe and protect doe from disturbance so young can nurse properly. Correct faulty nest boxes that injure breasts.</p>
<p>Mastitis or blue breasts: Breasts become feverish and pink, nipples red and dark. Temperature above normal, appetite poor, breasts turn black and purplish.</p>	<p>Bacterial infection of the breasts: <i>Staphylococcus</i> or <i>Streptococcus</i>.</p>	<p>Inject 100,000 units of penicillin intramuscularly twice a day for 3-5 days. Disinfect hutch and reduce feed concentrates. If severe case, destroy. NEVER transfer young from infected doe to another doe.</p>

Diseases and symptoms	Cause	Treatment and control
Snuffles or cold: Sneezing, rubbing nose; nasal discharge may be thick or thin. Mats fur on inside of front feet. May develop into pneumonia. Usually chronic type of infection.	Bacterial infection of nasal sinuses: <i>Pasteurella multocida</i> or <i>Bordetella bronchiseptica</i> .	Individual animals may be treated with a combination of 400,000 units of penicillin and 0.5 gr. streptomycin to each 2 ml. Give intramuscularly 1 ml. for fryer size, 2 ml. for mature. Repeat on third day.
Pneumonia: Labored breathing with nose held high, bluish color to eyes and ears. Lungs show congestion, red, mottled, moist, may be filled with pus. Often secondary to enteritis.	Bacterial infection of the lungs. Organisms involved may be <i>Pasteurella multocida</i> , <i>Bordetella bronchiseptica</i> , <i>Staphylococcus</i> and <i>Streptococcus</i> .	If the above treatment is started early, it is effective. For control in herds add feed grade sulfaquinoxaline so that level will be 0.025%, feed 3-4 weeks. Water soluble sulfaquinoxaline can be added at a level of 0.025% and fed 2-3 weeks.
Fur block: Animals reduce feed intake or stop eating completely, fur becomes rough and weight is lost. Stomach filled with undigested fur blocking passage to intestinal tract. Pneumonia may become secondary.	Lack of sufficient fiber, bulk or roughage in the diet. Junior does or developing does most susceptible.	Increase fiber or roughage in the ration. Feed dry alfalfa or timothy hay.
Tapeworm larvae: White streaks in liver or small white cysts attached to membrane on stomach or intestines. Usually cannot detect in live animals.	Larval stage of the dog tapeworms (<i>Taenia pisiformis</i>) or of the cat tapeworm (<i>T.taeniaeformis</i>)	No treatment. Keep dogs and cats away from feed, water and nest box material. Eggs of tapeworm occur in droppings of dogs and cats.
Pinworms: No specific symptoms in live animals. White threadlike worms found in cecum and large intestine cause slight local irritation.	Pinworms: <i>Passalurus ambiguus</i> .	None. Infection not considered one of economic importance.
Metritis or white discharge: White sticky discharge from female organs, often confused with sediment in urine. Enlarged uterus detected on palpitation, or both uteri filled with white purulent material.	Infection of the uterus by a variety of bacteria, nonspecific.	Dispose of infected animals and disinfect hutches. Infected area difficult to medicate. When both uteri are infected animal is sterile.

Diseases and symptoms	Cause	Treatment and control
<p>Pasteurellosis: May be an acute or chronic infection. Nasal discharge, watery eyes, weight loss or mortality without symptoms. Inflammation of lungs, inflammation of bronchi and nasal sinuses.</p>	<p>Bacterial infection: <i>Pasteurella multocida</i>.</p>	<p>Individual animals may be treated with a combination of 400,000 units of penicillin and 0.5 gr. streptomycin to each 2 ml. Give intramuscularly 1 ml. for fryer size, 2 ml. for mature. Repeat on third day. For herd control, add feed grade sulfaquinoxaline at level of 0.025%, feed 3-4 weeks. Save replacement stock from clean animals and cull out chronically infected animals. Use good sanitary measures to reduce transmission to new animals.</p>
<p>Paralyzed hindquarters: Found in mature does. Hind legs drag, cannot support weight of pelvis or stand. Urinary bladder fills but doesn't empty.</p>	<p>Injury, resulting in broken back, displaced disc, damage to spinal cord or nerves.</p>	<p>Protect animals from disturbing factors, predators, night prowlers and visitors or noises that startle animals, especially pregnant does.</p>
<p>Wry neck: Head twisted to one side. Animals roll over, cannot maintain equilibrium.</p>	<p>Infection of the organs of balance in the inner ear. May be parasitic or bacterial.</p>	<p>None. Eliminate ear canker from herd. Some cases result from nest box injuries.</p>

Further reading

Allen, T., **Housing, husbandry and welfare of rabbits**, January 1979-January 1994. Quik bibliography series, 1994, pp. 45, National Agricultural Library (NAL), Beltsville: USA. ISBN: 1052-5378-94-16.

Blas, C.de ; Wiseman, J., **The nutrition of the rabbit**. 1998, pp. 344, CAB International, Wallingford. ISBN: 085199279X.

Fielding, D.; Matheron, G., **Rabbits**. 1991, pp. 106, CTA, Wageningen, The Netherlands. ISBN: 0-333-52311-3.

Fenner, F.J. ; Fanitini, B. **Biological control of vertebrate pests: the history of myxomatosis, an experiment in evolution**. 1999, pp. 339, CABI publishers, New York, USA. ISBN: 851993230.

Rommers, J.M., **Strategies for rearing of rabbit does**. 2003, Department of Animal Sciences, WUR, Wageningen, The Netherlands. ISBN: 90-5808-934-7.

Rafats, J., **Rabbit production for food, fur, and fun** : January 1979-December 1989. Quik bibliography series, 1990, pp. 25, National Agricultural Library (NAL), Beltsville: USA.

Sandford, J.C., **The domestic rabbit**. 1996, pp. 278, Blackwell Science, Oxford, UK. ISBN: 0-632-03894-2.

references

Anonymous. **Commercial rabbit production**. 1974. Bulletin 50, Ministry of Agriculture, Fisheries and Food, Her Majesty's Stationery Office, London, U.K.

Arrington, L.R. and Kelley, K.C. **Domestic rabbit biology and production**. 1976. The University Press of Florida, Gainesville, U.S.A.

BASF. **Pocketbook for the leather technologist**. Badische Anilin Soda Fabrik AG 6700 Ludwigshafen, Germany

Belanger, J.O. **Raising small livestock.** 1974. Rodale Press Inc., Emmaus, Pennsylvania 18049

Casady, R.B., Savin, P.B. and Van Dam, J. **Commercial rabbit raising.** 1971. Agriculture Handbook No. 309, U.S.D.A. U.S. Govt. Printing Office, Washington D.C. 20402

Fielding, D. **Rabbits.** 1991. MacMillan/CTA. London. Series: "The Tropical Agriculturalist"

F.A.O. A manual for small-scale rabbit production.

F.A.O. **Raising Rabbits.** 1990. Better Farming series.

Part I: **Learning about rabbits, building the pens, choosing rabbits**

Part II: **Feeding, raising baby rabbits, further improvement.**

Jouffroy d'Abbans, I., Mondet, R. 12 **Petits Elevages** de rapport. 1979. Maison Rustique, libraire de l'Académie d'Agriculture, 26 Rue Jacob, 75006 Paris

Lang, J. **The nutrition of the commercial rabbit.**

Part I: **Physiology, digestibility and nutrient requirements**

Part II: **Feeding and general aspects** 1981. Nutrition Abstracts and Reviews, Series B, April/May 51 (4/5)

Leach, J. **Preparation and alum dressing of rabbit pelts on small scale.** 1981. Report of the Trop. Prod. Inst., G 156, VI + 50 pp. (TPI, 56/62 Gray's Inn Rd. London WC1 8LU

Lebas, F., Coudert P., Rouvier R. and De Rochambeau H. **The rabbit, husbandry, health and production.** 1986. F.A.O., Animal Production and Health Series, No. 21, FAO, Rome

Merck. **The Merck veterinary manual.** 1979. 5th edition, Rahway, NJ. U.S.A.

N.R.C. **Nutrient requirements of rabbits.** 1977. 2nd rev. ed. National Academy of Sciences, National Research Council

Owen, J.E., Morgan, D.J. and Barlow, J. **The rabbit as a producer of meat and skins in developing countries.** 1977. Rep. Trop. Prod. Inst. G 108, V + 31 pp, London U.K.

Portsmouth, J.I. **Commercial rabbit meat production.** 1979. 2nd edition Saiga Publ., Hindhead, Surrey, England

Rougeot, J. and Thébault R.G. **Le lapin angora, sa toison, son élevage.** 1984. Les Editions du point vétérinaire, 25 Rue Bourgelat, 94700 Maisons Alfort, France.

Sandford, P.C. and Woodgate, F.G. **The domestic rabbit.** 1979. 3rd ed. Granada Publishing, London, U.K.

Useful addresses

FAO, Food and Agricultural Organization of the

The Food and Agriculture Organization of the United Nations leads international efforts to defeat hunger. Serving both developed and developing countries, FAO acts as a neutral forum where all nations meet as equals to negotiate agreements and debate policy. FAO is also a source of knowledge and information. We help developing countries and countries in transition modernize and improve agriculture, forestry and fisheries practices and ensure good nutrition for all

Viale delle terme di carcalla 100, Rome, Italy

Telephone: (+39) 06 57051; Fax: (+39) 06 570 53152

E-mail:FAO-HQ@fao.org; web-site: www.fao.org

ILRI, International Livestock Research Institute

ILRI helps the world's poor people build and protect their livestock-based assets so that these, not poverty, are passed on to the next generation

P.BOX 5689, Addis Ababa, Ethiopia

Telephone: 251-1 463 215; Fax: 251-1461 252

E-mail:ILRI-Ethiopia@cgiar.org; web-site: www.ilri.cgiar.org



PTC+, Practical Training Centre

PTC+ is a leading, highly innovative international training centre with five training sites in the Netherlands, which focus on all the links in the production chain of plant and animal commodities, agricultural- and food technology and natural areas

PO.BOX 64, , 3770 AB, Barnveld, The Netherlands

Telephone: +31 342 406500; Fax: +31 342 406 501

E-mail:barneveld@ptcplus.com; web-site: www.ptcplus.com

Zodiac, Animal science department, WUR

Zodiac; is the Animal science of the Wageningen University and research centre. The core-business of the department is scientific education and research in the area of animal sciences. The department aims to contribute to a sustainable animal husbandry, aquaculture and fisheries

Marijkeweg 40, 6700 PG, Wageningen,

Telephone: +31 317 483952; Fax: +31 317 483962

E-mail: info@animalsciences.nl; web-site: <http://www.zod.wau.nl/>

ITDG, Intermediate Technology Development Group

ITDG helps people to use Technology in the fight against poverty.

Bourton Hall, Bourton on Dunsmore, CV23 9QZ, Rugby, Warwickshire, United Kingdom

E-mail: infoserv@itdg.org.uk; web-site: <http://www.itdg.org/>

CABI, Common wealth Agricultural Bureaux

P.O.Box 633, Icraft complex, Nairobi, Kenya

E-mail: cabi-arc@cabi.org; web-site: www.cabi.org

DIO, Foundation for veterinary Medicine for development cooperation.

The DIO foundation gives support and advice in the field of animal health and production to the poorer people of the world, irrespective of country of origin, beliefs or political interests. The main tool in our efforts is the Veterinary Information Service (V.I.S.), which is free to our target group. Furthermore, we try to help by giving advice on animal diseases and other veterinary issues. Secondly we want to promote awareness in The Netherlands of the importance of animal health in development co-operation. Our motto is: healthy animals, healthy people!

Yalelaan 17, 3584 CL, De Uithof, The Netherlands

E-mail: dio@dio@dio.nl; web-site: www.dio.nl

Glossary

Abdomen:	Belly
Bloat:	Intestinal gas that cannot escape causing the animal to be “blown up”
Buck:	Male rabbit (also: male goat)
Coccidiosis:	Intestinal parasites which occur quite frequently but which cannot be seen without a microscope
Concentrates:	High quality feed, like grains, tubers or mixed meals
Coprophagy:	Eating the droppings
Doe:	Female rabbit
Drenching:	Giving medicine to the animal by pouring it down its throat
Gestation:	Pregnancy
Hocks:	”heels” of the rabbit’s hind legs. “sore hocks” is a disease that may also affect the paws.
Hutch:	Cage, house, here used to mean the individual house of the rabbits
Inbreeding:	The mating of close relatives (e.g. Father and daughter, mother and son, etc). Inbreeding may result in abnormalities such as reduced litter sizes, weak young, deformed animals
Kindling:	Giving birth to young
Kitten:	Young rabbit
Lactation:	Period of time in which the doe produces milk for her young
Litter:	All the young animals produced in one gestation
Manger:	Construction in a cage or stable, used to contain roughage, easily accessible for the rabbit
Palpation:	Examination of doe to check for pregnancy
Pelt:	Skin of the rabbit

Pseudo-pregnancy:	If the ram has mated with the doe but the doe has not become pregnant, she will sometimes make a nest after 14-18 days after mating, without really having a litter
Ram:	Buck, male animal
Reproduction:	The ability of a male and female animal to produce young
Roughage:	Grass, leaves, other greens, also hay and straw
Scabies:	Mange, a small insect causing the skin to become flaky, crusty and sick
Stable:	Larger building containing many hutches
Stress:	A condition where the animal is under pressure from many negative factors. In this situation diseases will easily attack the animal.
Sulfa:	A name used for a whole group of medicine containing sulphur in one way or another, similar to antibiotics
Tanning:	Processing the skin, including or excluding the fur, to make leather from it trough manger
Weaning:	The act of separating the young from their mother permanently; stopping them drinking the mother's milk