



This is a digital copy of a book that was preserved for generations on library shelves before it was carefully scanned by Google as part of a project to make the world's books discoverable online.

It has survived long enough for the copyright to expire and the book to enter the public domain. A public domain book is one that was never subject to copyright or whose legal copyright term has expired. Whether a book is in the public domain may vary country to country. Public domain books are our gateways to the past, representing a wealth of history, culture and knowledge that's often difficult to discover.

Marks, notations and other marginalia present in the original volume will appear in this file - a reminder of this book's long journey from the publisher to a library and finally to you.

Usage guidelines

Google is proud to partner with libraries to digitize public domain materials and make them widely accessible. Public domain books belong to the public and we are merely their custodians. Nevertheless, this work is expensive, so in order to keep providing this resource, we have taken steps to prevent abuse by commercial parties, including placing technical restrictions on automated querying.

We also ask that you:

- + *Make non-commercial use of the files* We designed Google Book Search for use by individuals, and we request that you use these files for personal, non-commercial purposes.
- + *Refrain from automated querying* Do not send automated queries of any sort to Google's system: If you are conducting research on machine translation, optical character recognition or other areas where access to a large amount of text is helpful, please contact us. We encourage the use of public domain materials for these purposes and may be able to help.
- + *Maintain attribution* The Google "watermark" you see on each file is essential for informing people about this project and helping them find additional materials through Google Book Search. Please do not remove it.
- + *Keep it legal* Whatever your use, remember that you are responsible for ensuring that what you are doing is legal. Do not assume that just because we believe a book is in the public domain for users in the United States, that the work is also in the public domain for users in other countries. Whether a book is still in copyright varies from country to country, and we can't offer guidance on whether any specific use of any specific book is allowed. Please do not assume that a book's appearance in Google Book Search means it can be used in any manner anywhere in the world. Copyright infringement liability can be quite severe.

About Google Book Search

Google's mission is to organize the world's information and to make it universally accessible and useful. Google Book Search helps readers discover the world's books while helping authors and publishers reach new audiences. You can search through the full text of this book on the web at <http://books.google.com/>

UC-NRLF



\$B 311 170



EX LIBRIS

The Automobile Storage Battery

Its Care and Repair

American Bureau of Engineering, Inc.
1018-1024 So. Wabash Avenue, Chicago, Ill., U. S. A.

-TL272
44

Copyright, 1918, by the
American Bureau of Engineering, Inc.

70 VMD
ANSON LAD

PREFIX.

Many books have been written on Storage Batteries used in stationary work, as in electric power stations. These books cover the subject thoroughly. The storage battery, as used on the modern gasoline car, however, is subjected to service which is radically different from that of the battery in stationary work. It is true that the chemical actions are the same in all lead-acid storage batteries, but the design, construction, and operation of the starting and lighting battery are unique, and require a special description.

This book therefore refers only to the lead-acid type of starting and lighting battery used on the modern gasoline automobile. It is divided into two sections. The first section covers the theory, design, operating conditions, and care of the battery. The Willard Battery Company, the Electric Storage Battery Company, and the U. S. Light and Heat Corporation kindly contributed most of the illustrations for this section.

The second section deals with the actual work of repairing and rebuilding the storage battery. Much of the material for the text in this section was furnished by Mr. H. E. Peers of Topeka, Kansas, who also supplied most of the photographs from which the illustrations were made for this section. Mr. Peers is a practical battery man, and has been engaged in actually repairing and rebuilding batteries for many years.

The second section will be especially valuable to the battery repairman. All the instructions given have been in actual use for years, and represent the accumulated experiences of one of the most up-to-date battery repair shops in the United States.

Information concerning any of the tools and appliances may be obtained from the American Bureau of Engineering.

O. A. WITTE,
Chief Engineer, American Bureau of Engineering.

CONTENTS

SECTION 1.

| Chapter | Page |
|--|------|
| 1. INTRODUCTORY | 1 |
| 2. BATTERIES IN GENERAL..... | 5 |
| 3. CHEMICAL ACTIONS WHICH PRODUCE ELECTRICITY..... | 11 |
| 4. HOW CHEMICAL ACTIONS PRODUCE ELECTRICITY..... | 17 |
| 5. LOSS OF CHARGE IN AN IDLE BATTERY..... | 26 |
| 6. THE DISCHARGE PHENOMENA..... | 29 |
| 7. THE CHARGE PHENOMENA..... | 37 |
| 8. CAPACITY OF STORAGE BATTERIES..... | 40 |
| 9. INTERNAL RESISTANCE | 48 |
| 10. BATTERY DISEASES | 51 |
| 11. CONDITIONS OF OPERATION..... | 61 |
| 12. HOW TO TAKE CARE OF BATTERY ON THE CAR..... | 68 |
| 13. MANUFACTURE OF STORAGE BATTERIES..... | 89 |

SECTION 2.

| | |
|---|-----|
| 14. THE WORK SHOP. GENERAL INSTRUCTIONS..... | 102 |
| The Workshop. Shop Equipment. Special Work Bench. Shelving. Concerning Light. Charging Methods. Charging Equipment. Double Charging Bench. Motor-Generator Sets. Mercury Arc Rectifier. Electrolytic Rectifier. Discharge Board. Tools and Equipment. The Battery Steamer. The Battery Plate Press. Battery Turntable. The Burning Lead Mold. Tagging Batteries. Precautions to Be Taken by the Repairman. Lead Burning. Saving the Sediment. Mixing Electrolyte. | |
| 15. ANALYSIS OF THE CONDITION OF THE BATTERY..... | 162 |
| What Is the Trouble? Cutout Adjustments. Battery Trouble Charts. Summary of Work to Be Done on the Battery. When May a Battery Be Left on the Car? When Should a Battery Be Removed from the Car? When Is It Unnecessary to Open the Battery? When Must a Battery Be Opened? | |
| 16. WORK ON THE BATTERY..... | 182 |
| Charging Batteries Before Rebuilding. How to Open a Battery. What Must Be Done with the Opened Battery? When to Put in New Plates. When the Old Plates May Be Used Again. Separators. Freeing Shorts. Charging, Washing and Pressing. | |

CONTENTS

| Chapter | | Page |
|---------|---|------|
| | Burning on Plates. Reassembling the Elements. Repairing the Case. Putting in New Jars. Putting Elements in Jars. Filling Jars with Electrolyte. Putting on the Covers. Sealing Compounds. Sealing the Battery. Burning in the Connecting Straps with Hydrogen and Oxygen Flame. Burning in the Connecting Straps with Soldering Irons. Cleaning and Painting the Case. Charging the Rebuilt Battery. Discharging and Testing. | |
| 17. | SPECIAL INSTRUCTIONS | 250 |
| | Willard Type S Batteries. Exide Batteries. Prestolite Batteries. U. S. L. Batteries. | |
| 18. | CADMIUM TEST. STORING BATTERIES..... | 266 |

Section I

Theory and Practice

The Automobile Storage Battery

CHAPTER 1.

INTRODUCTORY.

Gasoline and electricity have made possible the modern automobile. Each has its work to do in the operation of the car, and if either fails to perform its duties, the car cannot move. The action of the gasoline, and the mechanisms that control it are comparatively simple, and easily understood, because gasoline is something definite which we can see and feel, and which can be weighed, or measured in gallons. Electricity, on the other hand, is invisible, cannot be poured into cans or tanks, has no odor, and, therefore, nobody knows just what it is. We can only study the effects of electricity, and the wires, coils, and similar apparatus in which it is present. It is for this reason that an air of mystery surrounds electrical things, especially to the man who has not made a special study of the subject.

Without electricity, there would be no gasoline engine, because gasoline itself cannot cause the engine to operate. It is only when the electrical spark explodes or "ignites" the mixture of gasoline and air which has been drawn into the engine cylinders that the engine develops power. Thus an electrical ignition system has always been an essential part of every gasoline automobile.

The next step in the use of electricity on the automobile consisted in the substitution of an electric lighting system for the inconvenient oil or gas lamps which were satisfactory as far as the light they gave was concerned, but which had the disadvantage of requiring the driver to leave his seat, and bring

each lamp into life separately, often in a strong wind or rain which consumed many matches, time, and frequently spoiled his temper for the remainder of the evening. Electric lamps have none of these disadvantages. They can be controlled from the driver's seat, can be turned on or off by merely turning or pushing a switch-button, are not affected by wind or rain, do not smoke up the lenses, and do not send a stream of unpleasant odors back to the passengers.

The apparatus used to supply the electricity for the lamps consisted of a generator, or a "storage" battery, or both. The generator alone had the disadvantage that the lamps could be used only while the engine was running. The battery, on the other hand, furnished light at all times, but had to be removed from the car frequently, and "charged." With both the generator and battery, the lights could be turned on whether the engine was running or not, and, furthermore, it was no longer necessary to remove the battery to "charge," or put new life into it. With a generator and storage battery, moreover, a reliable source of electricity for ignition was provided, and so we find dry batteries and magnetos being discarded in a great many automobiles and "battery ignition" systems substituted.

The development of electric lighting systems increased the popularity of the automobile, but the motor car still had a great drawback—cranking. Owing to the peculiar features of a gasoline engine, it must first be put in motion by some external power before it will begin to operate under its own power. This made it necessary for the driver to "crank" the engine, or start it moving, by means of a handle attached to the engine shaft. Cranking a large engine is difficult, especially if it is cold, and often results in tired muscles, and soiled clothes and tempers. It also made it impossible for the average woman to drive a car because she did not have the strength necessary to "crank" an engine.

The next step in the perfection of the automobile was naturally the development of an automatic device to crank the engine, and thus make the driving of a car a pleasure rather than a task. We find, therefore, that in 1912, "self-starters" began to be used. These were not all electrical, some used tanks of com-

pressed air, others acetylene, and various mechanical devices, such as the spring starters. The electrical starters, however, proved their superiority immediately, and filled such a long felt want that fully 98% of the various makes of automobiles now have electric starters. The present day motor car, therefore, uses gasoline for the engine only, but uses electricity for ignition, starting, lighting, for the horn, cigar lighters, hand warmers on the steering wheel, gasoline vaporizers, and even for shifting speed changing gears, and for the brakes.



Fig. 1. The Battery

On any car that uses an electric lighting and starting system, there are two sources of electricity, the generator and the battery. These must furnish the power for the starting, or "cranking" motor, the ignition, the lights, the horn, and the other devices. The demands made upon the generator are comparatively light and simple, and no severe work is done by it. The battery, on the other hand is called upon to give a much more severe service, that of furnishing the power to crank the engine. It must also perform all the duties of the generator when the engine is not running, since a generator must be in motion in order to produce electricity.

A generator is made of iron, copper, carbon, and insulation. These are all solid substances which can easily be built in any size or shape, and which undergo very little change as parts of the generator. The battery is made mainly of lead, lead compounds, water and sulphuric acid. Here we have liquids as well as solids, which produce electricity by changes in their composition, resulting in complicated chemical as well as electrical actions.

The battery is, because of its construction and performance, a much abused, neglected piece of apparatus which is but partly understood, even by many electrical experts, for to understand it thoroughly requires a study of chemistry as well as of electricity. Knowledge of the construction and action of a storage battery is not enough to make anyone an expert battery man. He must also know how to regulate the operating conditions so as to obtain the best service from the battery, and he must be able to make complete repairs on any battery no matter what its condition may be.

In the following chapters we shall treat in detail the subjects of electrical and chemical reactions, construction, operation, maintenance, and repair, with the object of making the reader familiar with all phases of battery work, and to lift the veil of mystery from the "giant who lives in a box."

CHAPTER 2.

BATTERIES IN GENERAL.

There are three ways of "generating" electricity; 1. Magnetically, 2. Chemically, 3. Thermally. The first method is that used in a generator, in which wires are rotated in a "field" in which magnetic forces act. The second method is that of the battery, and the one in which we are now interested. The third method consists of heating a joint of two different metals and is of no practical importance.

If two unlike metals or conducting substances are placed in a liquid which acts chemically upon one of the substances more than upon the other, an electrical pressure, or "electromotive" force is caused to exist between the two metals or conducting substances. The greater the difference in the chemical activity on the substances, the greater will be the electrical pressure, and if the substances are connected together outside of the liquid by a wire or other conductor of electricity, an electric current will flow through the path or "circuit" consisting of the liquid, the two substances which are immersed in the liquid, and the external wire or conductor.

As the current flows through the combination of the liquid, and the substances immersed in it, which is called a voltaic "cell," one or both of the substances undergo chemical changes which continue until one of the substances is entirely changed. These chemical changes produce the electrical pressure which causes the current to flow, and the flow will continue until one or both of the substances are changed entirely. This change due to the chemical action may result in the formation of gases, or of solid compounds. If gases are formed they escape and are lost. If solids are formed, no material is actually lost.

Assuming that one of the conducting substances, or "electrodes," which are immersed in the liquid has been acted upon

by the liquid, or "electrolyte," until no further chemical action can take place, our voltaic cell will no longer be capable of causing a flow of electricity. If none of the substances resulting from the original chemical action have been lost as gases, it may be possible to reverse the entire set of operations which have taken place. That is, suppose we now send a current through the cell from an outside source of electricity, in a direction which is opposite to that in which the current, which was produced by the chemical action between the electrodes and electrolyte, flowed. If this current now produces chemical actions between electrodes and electrolyte which are the reverse of those which occurred originally, so that finally we have the electrodes and electrolyte brought back to their original composition and condition, we have the cell just as it was before we used it for the production of an electrical pressure. The cell can now again be used as a source of electricity as long as the electrolyte acts upon the electrodes, or until it is "discharged" and incapable of any further production of electrical pressure. Sending a current through a discharged cell, so as to reverse the chemical actions which brought about the discharged condition, is called "charging" the cell.

Cells in which an electrical pressure is produced as soon as the electrodes are immersed in the electrolyte are called "primary" cells. In these cells it is often impossible, and always unsatisfactory to reverse the chemical action as explained above. Cells whose chemical actions are reversible are called "storage" or "secondary" cells. In the "storage" cells used today, a current must first be sent through the cell in order to cause the chemical changes which result in putting the electrodes and electrolyte, in such a condition that they will be capable of producing an electrical pressure when the chemical changes caused by the current are complete. The cell now possesses all the characteristics of a primary cell, and may be used as a source of electricity until "discharged." It may then be "charged" again, and so on, the chemical action in one case causing a flow of current, and a reversed flow of current causing reversed chemical actions.

We see from the above that the "storage" battery does not

“store” electricity at all, but changes chemical into electrical energy when “discharging,” and changes electrical into chemical energy when “charging,” the two actions being entirely reversible. The idea of “storing” electricity comes from the fact that if we send a current of electricity through the cell for a certain length of time, we can at a later time draw a current from the cell for almost the same length of time.

Three things are therefore required in a storage cell, the liquid or “electrolyte” and two unlike substances or electrodes, through

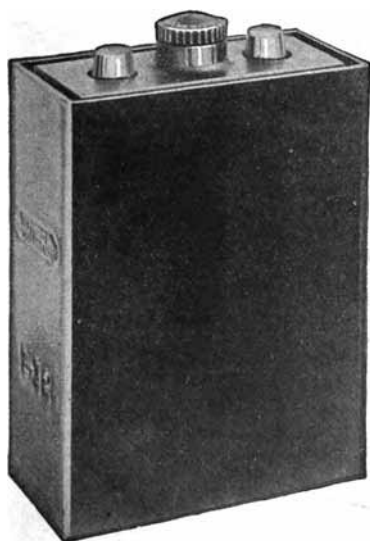

▲ Complete Cell

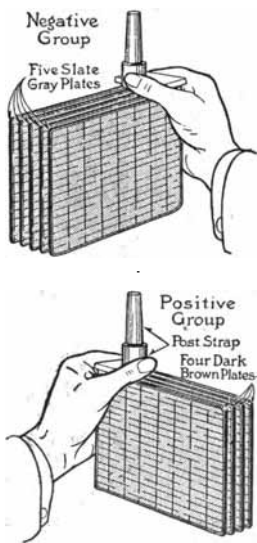

Fig. 2

which a current of electricity can pass and which are acted upon by the electrolyte with a chemical action that is greater for one substance than the other. In the storage cell used on the automobile to-day for starting and lighting, the electrodes are lead and peroxide of lead, and the electrolyte is a mixture of sulphuric acid and water. The peroxide of lead electrode is the one upon which the electrolyte has the greater chemical effect, and it is called the positive or “+” electrode, because when the battery is sending a current through an external circuit, the current

flows from this electrode through the external circuit, and back to the lead electrode, which is called the negative, or "—" electrode.

When starting and lighting systems were adopted in 1912, storage batteries had been used for many years in electric power stations. These were, however, large and heavy, and many difficult problems of design had to be solved in order to produce a battery capable of performing the work of cranking the engine, and yet be portable, light, and small enough to occupy only a

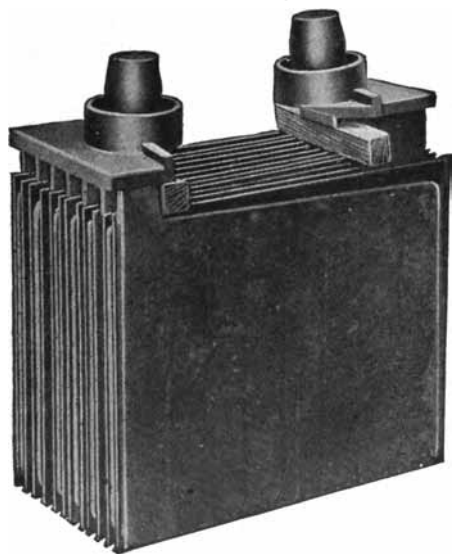

Fig. 3. A complete element, consisting of a positive and negative group of plates, hold-down blocks and separators ready for placing in the hard rubber jars

very limited space on the automobile. As a result these conditions governing the design, the starting and lighting battery of to-day is in reality "the giant that lives in a box." The Electric Storage Battery Company estimates that one of its types of batteries, which measures only $12\frac{3}{8}$ inches long, $7\frac{3}{8}$ wide, and $9\frac{1}{8}$ high, and weighs only $63\frac{1}{2}$ pounds, can deliver enough energy to raise itself to a height of 6 miles straight up in the air. It must be able to do its work quickly at all times, and in all sorts of weather, with temperatures ranging from below 0° to 100° Fahrenheit.

The starting and lighting battery has therefore been designed to withstand severe operating conditions. Looking at such a battery on a car we see a small wooden box in which are placed three or more "cells," see Fig. 1. Each "cell" has a hard, black rubber top through which two posts of lead project. Bars of lead connect the posts of one cell to those of the next. To one of the posts of each end cell is connected a cable which leads into the car, and through which the current leaves or enters the battery. At the center of each cell is a removable rubber plug covering an opening through which communication is established with the inside of the cell for the purpose of pouring in water, removing some of the electrolyte to determine the condition of the battery, or to allow gases formed within the cell to escape. Looking down through this opening we can see the things needed to form a storage battery: the electrolyte, and the electrodes or "plates" as they are called. If we should remove the lead bars connecting one cell to another, and take off the black cover, we shall find that the posts which project out of the cells are attached to the plates which are broad and flat, and separated by thin pieces of wood or rubber. If we lift the plates out of the jar we find that they are connected alternately to the two lead posts, and that the two outside ones have a gray color. If we pull the plates out from each other, we find that the plates next to the two outside ones, and all other plates connected to the same lead post as these have a chocolate-brown color. If we remove the jar of the cell, we find that it is made of hard rubber. Pouring out the electrolyte we find several ridges which hold the plates off the bottom of the jar. The pockets formed by these ridges may contain some soft, muddy substance. Thus we have exposed all the elements of a cell,—posts, plates, "separators," and electrolyte. The gray colored plates are attached to the "negative" battery post, while the chocolate-brown colored ones are connected to the "positive" battery post. Examination will show that each of the plates consists of a skeleton metallic framework which is filled with the brown or gray substances. This construction is used to decrease the weight of the battery. The gray filler material is pure lead in a condition called "spongy lead." The chocolate-brown filler substance is peroxide of lead.

We have found nothing but two sets of plates,—one of pure lead, the other of peroxide of lead, and the electrolyte of sulphuric acid and water. These produce the heavy current necessary to crank the engine. How this is done, and what the chemical actions within the cell are, are described in the next chapter.

CHAPTER 3.

CHEMICAL ACTIONS WHICH PRODUCE ELECTRICITY.

Before explaining what happens within one storage cell, let us look into the early history of the storage battery, and see what a modest beginning the modern heavy duty battery had. Between 1850 and 1860 a man named Plante began his work on the storage battery. His original cell consisted of two plates of metallic lead immersed in dilute sulphuric acid. The acid formed a thin layer of lead sulphate on each plate which soon stopped further action on the lead. If a current was passed through the cell, the lead sulphate on the "anode" or lead plate at which the current entered the cell was changed into peroxide of lead, while the sulphate on the other lead plate or "cathode" was changed into pure lead in a spongy form. This cell was allowed to stand for a couple of days and was then "discharged," lead sulphate being again formed on each plate. Each time this cell was charged, more "spongy" lead and peroxide of lead were formed. These are called the "active" materials, because it is by the chemical action between them and the sulphuric acid that the electricity is produced. Evidently, the more active materials the plates contained, the longer the chemical action between the acid and active materials could take place, and hence the greater the "capacity," or amount of electricity furnished by the cell. The process of charging and discharging the battery so as to increase the amount of active material, is called "forming" the plates.

Plante's method of forming plates was very slow, tedious, and expensive. If the spongy lead, and peroxide of lead could be made quickly from materials which could be spread over the plates, much time and expense could be saved. It was Faure who first suggested such a plan, and gave us the "pasted" plate of to-day, which consists of a skeleton framework of lead, with the sponge lead and peroxide of lead filling the spaces between the

“ribs” of the framework. Such plates are known as “pasted” plates, and are much lighter and satisfactory than the heavy solid lead plates of Plante’s. Chapter 13 will describe more fully the processes of manufacturing and pasting the plates.

We know now what constitutes a storage battery, and what the parts are that “generate” the electricity. How is the electricity produced? If we take a battery which has been entirely discharged, so that it is no longer able to cause a flow of current, and examine and test the electrolyte and the materials on the plates, we shall find that the electrolyte is pure water, and both sets of plates composed of white lead sulphate. On the other hand, if we make a similar test and examination of the plates and electrolyte of a battery through which a current has been sent from some outside source, such as a generator, until the current can no longer cause chemical reactions between the plates and electrolyte, we will find that the electrolyte is now composed of water and sulphuric acid, the acid comprising about 30%, and the water 70% of the electrolyte. The negative set of plates will be composed of pure lead in a spongy form, while the positive will consist of peroxide of lead.

It is evident that the chemical changes which have taken place in totally discharging the battery consisted in taking all the acid out of the electrolyte, changing the material of the positive plates from lead peroxide to lead sulphate, and changing the material of the negative plates from pure spongy lead to lead sulphate. Both plates are now composed of the same material, and they are immersed in pure water, which has no chemical action upon either plate. Such a combination cannot produce electricity, as explained previously.

The foregoing description gives the final products of the chemical changes that take place in the storage battery. To understand the changes themselves requires a more detailed investigation. The substances to be considered in the chemical actions are sulphuric acid, water, pure lead, lead sulphate, and lead peroxide. With the exception of the pure lead, each of these substances is a chemical compound, or composed of several elements. Thus sulphuric acid is made up of two parts of hydrogen, which is a gas; one part of sulphur, a solid, and four parts of oxygen,

which is also a gas; these combine to form the acid, which is a liquid, and which is for convenience written as H_2SO_4 , H_2 representing two parts of hydrogen, S one part of sulphur, and O_4 four parts of oxygen. Similarly, water a liquid, is made up of two parts of hydrogen and one part of oxygen, represented by the symbol H_2O . Lead is not a compound, but an element whose chemical symbol is Pb, taken from the Latin name for lead. Lead sulphate is a solid, and consists of one part of lead, a solid substance, one part of sulphur, another solid substance, and four

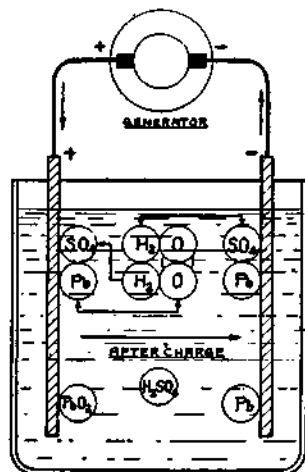

Chemical Action in a Storage Cell During Charge

Fig. 4

parts of oxygen, a gas. It is represented chemically by $Pb SO_4$. Lead peroxide is also a solid, and is made up of one part of lead, and two parts of oxygen. In the chemical changes that take place, the compounds just described are to a certain extent split up into the substances of which they are composed. We thus have lead (Pb), hydrogen (H), oxygen (O), and sulphur (S), four elementary substances, two of which are solids, and two gases. The sulphur does not separate itself entirely from the substances with which it forms combination of H_2SO_4 and $Pb SO_4$. These compounds are split into H_2 and SO_4 and Pb and SO_4 respectively.

That is, the sulphur always remains combined with four parts of oxygen.

Let us now consider a single storage cell made up of electrolyte, one positive plate, and one negative plate. When this cell is fully charged, or in a condition to produce a current of electricity, the positive plate is made up of peroxide of lead (PbO_2), the negative plate of pure lead (Pb), and the electrolyte of sulphuric acid (H_2SO_4). This is shown diagrammatically in figure 4. The chemical changes that take place when the cell is discharging and the final result of the changes are as follows:

(a). At the positive plate: Lead peroxide (PbO_2) and sulphuric acid (H_2SO_4) and two parts of hydrogen (H_2) produce two parts of water ($2\text{H}_2\text{O}$) and one part of lead sulphate (PbSO_4). This may also be represented in this way: $\text{PbO}_2 + \text{H}_2\text{SO}_4 + \text{H}_2 = \text{PbSO}_4 + 2\text{H}_2\text{O}$.

(b). At the negative plate: Lead (Pb) and Sulphate (SO_4) produce lead sulphate PbSO_4 . This may again be represented by $\text{Pb} + \text{SO}_4 = \text{PbSO}_4$.

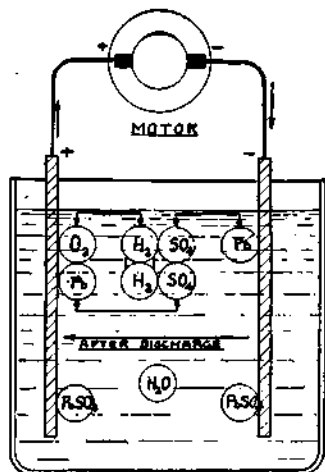

Chemical Action in a Storage Cell During Discharge

Fig. 5

From (a) and (b), above, we see that at the positive plate the chemical changes during discharge produce water and lead sulphate, whereas only lead sulphate is produced at the negative plate, showing that the positive plate is acted upon to a greater extent by the acid than the negative plate is. The storage cell therefore fulfills the condition necessary to have a current produced, namely, that we must have two unlike substances immersed in a liquid, the chemical action of which is greater upon one substance than upon the other.

The chemical changes described in (a) and (b) are not instantaneous.

That is, the lead, lead peroxide, and sulphuric acid of the fully charged cell are not changed into lead sulphate and water as soon as a current begins to pass through the

cell. This action is a gradual one, small portions of these substances being changed at a time. The greater the current that flows through the cell, the faster will the changes occur. The changes will continue to take place as long as any lead, lead peroxide, and sulphuric acid remain. The faster these are changed into lead sulphate and water, the shorter will be the time that the storage cell can furnish a current, or the sooner it will be discharged. When the cell is completely discharged, we will have the conditions shown in the lower part of the cell of figure 5.

Taking the cell in its discharged condition, let us now connect the cell to a dynamo and send current through the cell from the positive to the negative plates. This is called "charging" the cell. The lead sulphate and water will now gradually be changed back into lead, lead peroxide, and sulphuric acid. The lead sulphate which is on the negative plate is changed to pure lead; the lead sulphate on the positive plate is changed to lead peroxide, and sulphuric acid will be added to the water. The changes at the positive plate may be represented as follows:

Lead sulphate (PbSO_4) and water ($2\text{H}_2\text{O}$) and sulphate (SO_4) produce sulphuric acid ($2\text{H}_2\text{SO}_4$) and lead peroxide (PbO_2), or

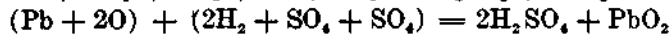
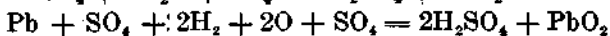

The changes at the negative plate may be expressed as follows:

Lead sulphate (PbSO_4) and hydrogen (H_2) produce sulphuric acid (H_2SO_4) and lead (Pb), or

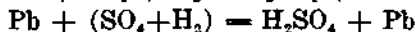
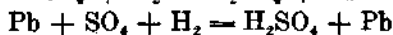

These changes produced by sending a current through the cell are also gradual, and will take place faster as the current is made greater. When all the lead sulphate has been used up by the chemical changes caused by the current, no further charging can take place. If we continue to send a current through the cell after it is fully charged, the water will continue to be split up into hydrogen and oxygen. Since, however, there is no more lead

sulphate left with which the hydrogen and oxygen can combine to form lead, lead peroxide, and sulphuric acid, the hydrogen and oxygen rise to the surface of the electrolyte and escape from the cell. This is known as "gassing," and is an indication that the cell is fully charged.

CHAPTER 4.

HOW CHEMICAL ACTIONS PRODUCE ELECTRICITY.

In Chapter 3 we studied the chemical changes that occurred in the cell both when the cell was producing a current, and when a current was sent through the cell from a dynamo. But we have not as yet learned how these chemical actions produce electricity. The fact that the chemical actions produce electricity, and that, on the other hand, electricity produces chemical changes shows that electricity and chemical changes are closely associated.

A complete study of the electricity which chemical changes make available would furnish material for a book many times

thicker than this one, as it forms a distinct branch of science known as Electro-Chemistry. A general investigation will be made, however. No chemical change, or chemical reaction is supposed to produce electricity, but merely to make it available for use. Thus the storage battery contains the electricity before any chemical change takes place. As soon as the battery circuit is closed through the lamps or starting motor, however, the electric current flows out of the battery at the

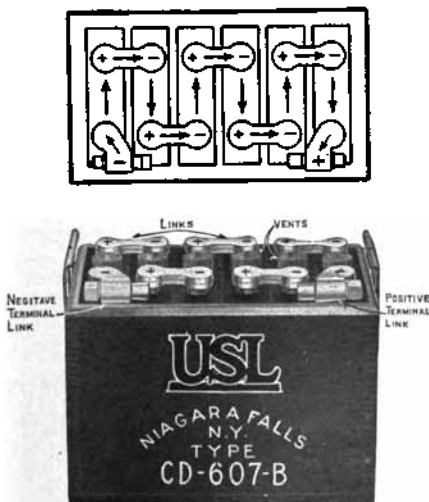

Fig. 6. Direction of Current Flow from Cell to Cell During Discharge

positive terminal, and back into the battery at the negative terminal. Where is the electricity, and in what form, and how does the mere closing of the battery circuit cause it to appear?

When we think of an electric current flowing through a wire, we take it for granted that at any point in the wire the current is flowing in one direction only, just like water flowing through a pipe. When, however, a current flows through a liquid, like the battery electrolyte, it is supposed to be flowing both from the positive to the negative, and from the negative to the positive. These currents are carried by the sulphuric acid. As long as this acid is not mixed with water, it cannot carry any current. When the acid is poured into the water, it is partly divided into hydrogen (H_2) and sulphate (SO_4). This happens as soon as the acid and water are mixed. The hydrogen has a certain amount of positive electricity attached to it, and the sulphate a certain amount of negative electricity. Where did the electricity come from? It was in the acid in the first place, but as long as the acid was not separated into hydrogen and sulphate, the positive electricity of the hydrogen neutralized that of the sulphate. The particles which have the electricity attached to them are called "ions." They are extremely small, and the electricity they carry is spoken of as a positive or a negative "charge" of electricity, or simply "charge." We then have a quantity of hydrogen ions which are carrying positive electricity or have a positive "charge." Similarly the sulphate ions carry a certain amount of negative electricity, or have a negative "charge." The ions are entirely unlike the substances as we see them and have different characteristics.

Leaving the acid with its "charges" of electricity, let us consider the electrodes or plates. Like the acid, the lead and lead peroxide contain certain amounts of electricity, both positive and negative. When the electrodes are immersed in the electrolyte these amounts of positive and negative charges are made available.

At the negative plate, which is composed of pure lead, some of the lead separates from the plate, and mixes with the acid in the form of "ions," each ion carrying a small amount, or charge of electricity. The lead ion leaves a similar and equal amount negative electricity on the lead plate. Only a very few of these lead ions are formed as long as no current passes through the

battery. This is due to the fact that the positive charge on the lead ion and the negative charge on the lead plate have a strong attraction for each other. After a few ions have been formed, the attraction is so strong that no more are formed. Similarly, for the positive plate, small particles of the lead peroxide enter

CHARGED CELL ON OPEN CIRCUIT

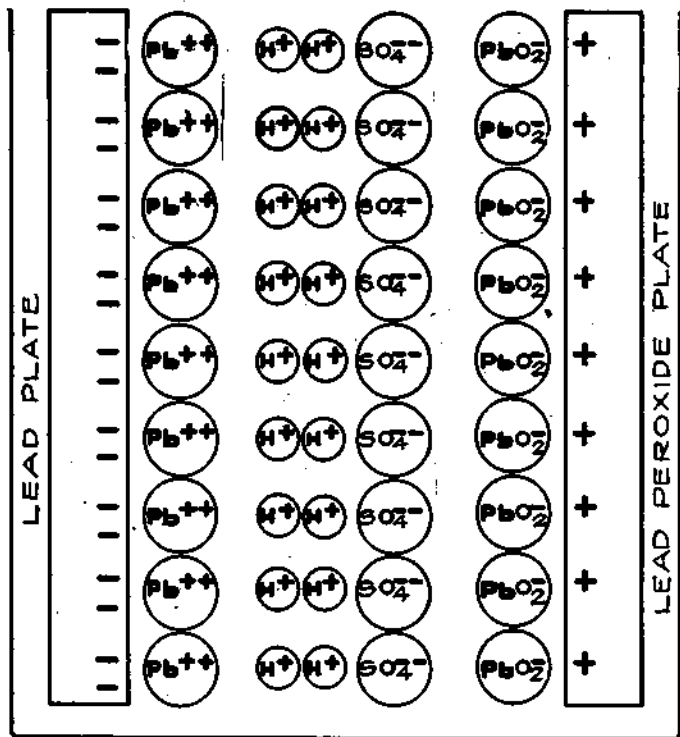

Fig. 7

the electrolyte, and take with them certain quantities of negative electricity, or negative charges, leaving the plate with an equal positive charge. As long as the circuit outside the battery is open, no current can flow, because the negative and positive quantities of electricity, or "charges" on the plates are kept there by the opposite charges on the ions that have entered the

acid. The fact that the minute particles called "ions" carry with them certain quantities of electricity is indicated by writing the signs "+" and "-" after them. Thus, a lead ion is written (Pb^{++}), and a lead peroxide ion PbO_2^- .

Figure 7 shows the conditions described above. At the negative plate is a layer of lead ions which have gone into the acid, carrying positive charges and leaving an equal number of nega-

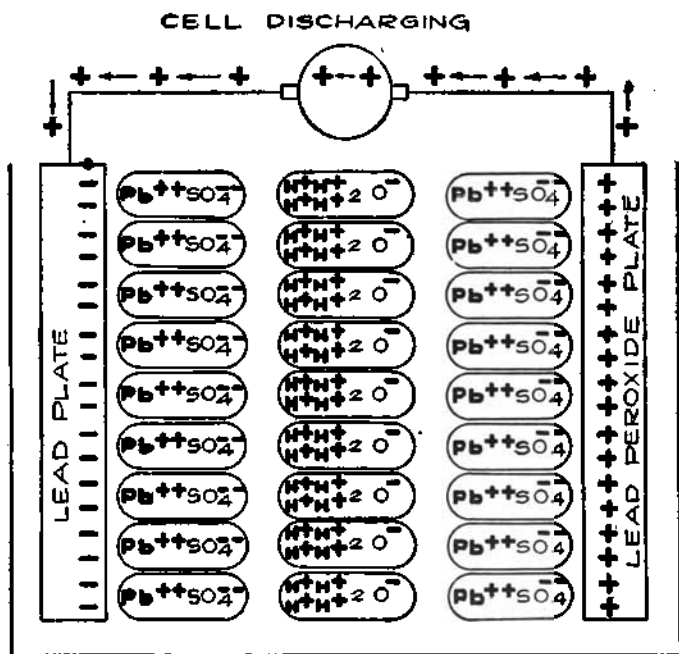

Fig. 8

tive charges on the lead plate. Similarly, at the positive plate is a layer of lead peroxide ions which have entered the acid, carrying negative charges, and leaving an equal number of positive charges on the positive plate. The acid itself has been split by the water, into hydrogen ions and sulphate ions, the hydrogen ions carrying positive charges, and the sulphate ions carrying negative charges. The ions of the acid are distributed throughout the electrolyte. As the figure shows, the number of positive

and negative ions are equal, and as they attract each other strongly, they cannot move away from each other, and hence no current can flow.

If we now connect the positive and negative plates together through a starting motor, as shown in figure 8, conditions will be changed. The positive charges on the positive plate will move

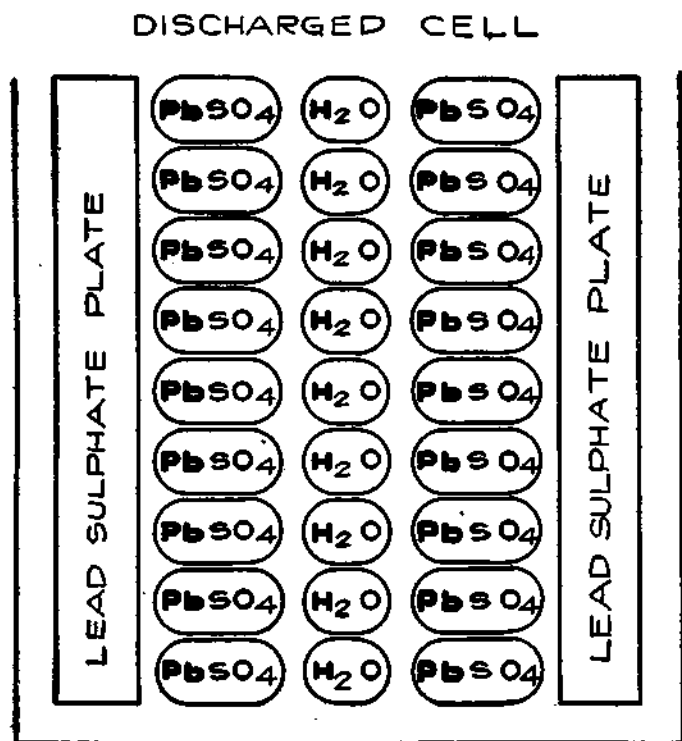

Fig. 9

along the wire and through the motor to the negative plate. There they will meet the negative charges. In order that the positive and negative charges on the plates may send a current through the starting motor, the lead ions and the lead peroxide ions must be removed from the surfaces of the plates. Otherwise the attraction of the lead and lead peroxide ions for the charges

on the plate will hold the latter on the plate. Now, each ion has a tendency to move through the acid. As soon as some of the negative charges start to leave the lead plate to go through the motor, the lead ions start to move toward the lead peroxide plate. They have hardly started to move, however, before they meet sulphate ions from the acid. The sulphate ions and the lead ions combine and form lead sulphate. Similarly, the lead peroxide ions begin to leave the positive plate. They are then split up into lead ions (Pb^{++}) and oxygen ions (O^{2-}). This leaves hydrogen ions from the acid, and oxygen ions from the lead peroxide unaccounted for. The two have opposite charges, and hence attract each other, uniting to form water. This gives us lead sulphate and water as the final products of discharging a battery, which agrees with the equation on page 14.

The lead of a negative plate, and the lead peroxide of the positive plate are called "active" materials. They are not the only substances which can be used for storage batteries. Many combinations for electrolyte and plates have been tried, but the lead, lead peroxide, and sulphuric acid combination has worked out to be the best combination for practical use. They do not create electricity, as was explained above, but the chemical changes that take place in the battery readjust the small quantities of electricity or "charges" which are carried by the "ions" so that we are able to force the charges to move through the starting motor, lamps, or other apparatus. The water in the battery causes the "ions" to form as separate particles carrying "charges." Without water we could not have a battery, as the electricity bound up in the active materials would never be available, because the negative and positive charges neutralize each other ordinarily, and must be separated from each other long enough to be forced to run the starting motor, light the lamps, and furnish current for the ignition. Once the charges are separated, they have a tendency to unite with those of opposite sign. The water prevents a complete reunion of the ions carrying the charges, but the tendency they have to unite gives the voltage, or electromotive force of the battery. When a current is made to flow through the motor, charges are uniting, and a current will continue to flow as long as there are charges available. As soon

as charges unite through the motor, more are formed in the electrolyte from the lead, lead peroxide, and sulphuric acid. When these materials have all been used so that we have only lead sulphate and water in the battery, no more charges are available, and the battery can no longer produce a current.

In practice, a battery is never discharged until all the lead, lead peroxide, and sulphuric acid are changed into lead sulphate and water. As lead sulphate is formed, it fills up the pores in the plates, and covers the remaining lead and lead peroxide so that they are practically sealed in and made useless. The removal of the sulphate becomes increasingly difficult as more is formed, and, therefore, a battery should not be discharged entirely. This subject will be treated more completely later.

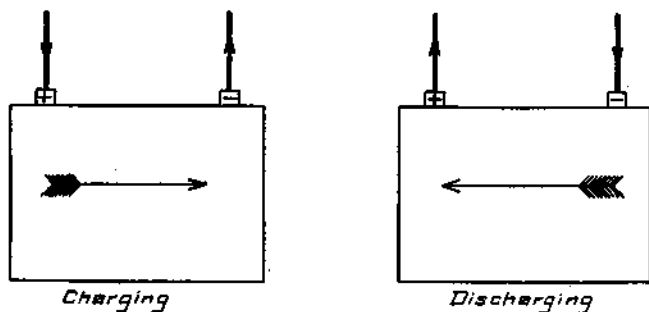

Fig. 10

The battery is now completely discharged. We now send a continuous current through it so that the current enters through the positive terminal, and leaves through the negative terminal, Fig. 10. This direction of flow is just the reverse of the current produced by the battery in discharging. The current we are sending through the battery gradually puts it in a condition in which it can again furnish a current. We saw how the battery produces a current when it is fully charged, that is, when we had a plate of pure lead, a plate of lead peroxide and an electrolyte of acid and water. Now we are starting with two plates of lead sulphate immersed in water. How does a current charge the battery?

When a battery is completely discharged, we have lead sul-

phate at each plate, and water. The water has the power to split the lead sulphate into lead (Pb), and sulphate (SO_4). The water itself is separated, to a slight extent, into hydrogen (H_2), and oxygen (O). These parts into which the lead sulphate and water separate each carry a "charge" of electricity, some positive, and some negative. The lead and hydrogen are positive, and the sulphate and oxygen negative. We thus have lead "ions" (Pb^{++}), sulphate ions (SO_4^{-}), hydrogen ions (H_2^{+}), and oxygen ions (O^{-}). As long as the battery is not being charged, the + and - charges attract each other, and no chemical changes occur. When the battery is connected to a generator for charging, the generator produces positive charges on the positive plate, and negative charges on the negative plate. The positive charges on the positive plate will attract all the negatively charged ions, while the negative charges on negative plate will attract all the positively charged ions. As a result, the lead and hydrogen ions start to move toward the negative plate, and the sulphate and oxygen ions toward the positive plate. The Pb^{++} which begins to move from the positive to the negative plate meets immediately with the 2O^{-} and PbO_2 is formed. This seems to then become PbO_2^{-} . The positive charges on the positive plates attract the PbO_2^{-} , and the latter is deposited on the plate as ordinary lead peroxide. The Pb^{++} at the negative plate, is attracted by the negative charges on the negative plate, and since the Pb^{++} is on the negative plate it is immediately deposited as metallic lead, since the negative and positive charges neutralize one another and take the charge away from the lead. This gives us the changes which occur at the plates so as to give us the lead and lead peroxide of a charged battery. We still need sulphuric acid however. At the positive plate, the sulphate ion meets the hydrogen ion, which is free to travel toward the negative plate, and sulphuric acid is formed. At the negative plate, the sulphate ion starts to move toward the positive plate, but meets the hydrogen ion which is moving toward the negative plate, and sulphuric acid is formed, although half of the acid is always separated into hydrogen and sulphate. This accounts for all the materials.

We have thus taken the battery through a charge and discharge, both chemically, and electrically. The actions described for discharge take place faster when a heavy current is drawn from the battery. The speed of the charge actions depends upon the voltage of the generator, the motions of the ions being increased in speed as the voltage is increased. As far as current flow in and out of the battery is concerned, this depends upon the positive and negative charges on the positive and negative plates. When the battery is discharging, these charges will pass into the external circuit with increasing speed as the resistance of the circuit decreases. When the battery is being charged, the charges on the plate attract the charges on the ions, and when the charges reach the plates, the opposite charges on ion and plate neutralize one another. The result of the ions travelling in opposite directions in the electrolyte is to produce a current which seems to flow in only one direction in the external circuit. The ions of the lead, lead peroxide, and lead sulphate all tend to move toward one or the other battery plate, but because they are so few in number, and because there are so many hydrogen and sulphate ions in the electrolyte, they have hardly begun to move before they combine with the ions of the acid to form lead sulphate and water. Hence, the ions of the active plate materials move exceedingly minute distances. Those of the acid, especially the hydrogen ion, move through all parts of the electrolyte. The chemical actions take place not only at the outside surfaces of the plates, but wherever acid, lead or lead peroxide, or lead sulphate come in contact with each other. We know that the acid soaks in to all parts of the plates, and therefore the actions take place throughout the entire plate. The materials on the plates must therefore be porous in order to allow the acid to soak into them easily.

The "pasted" plate is used almost entirely for starting and lighting service. The plates are not made entirely of the spongy lead and lead peroxide. Neither of these substances are tough enough to be made into plates. They must, therefore, be held in place. We thus find that each plate consists of a skeleton framework of lead, the pastes filling up the spaces between the ribs.

CHAPTER 5.

LOSS OF CHARGE IN AN IDLE BATTERY.

Before taking up the study of discharge by drawing a current from the battery, let us see what happens if a fully charged battery is allowed to stand idle on open circuit, that is, with no wires or cables attached to its terminals. It has been found that such a battery will gradually become discharged and that it must be given an occasional "freshening" charge.

Now, as we have learned, when a battery discharges lead sulphate forms on each plate, and acid is taken from the electrolyte as the sulphate forms. In our idle battery, therefore, such actions must be taking place. The only difference in this case is that the sulphate forms without any current passing through the battery. The actions at the lead and lead peroxide must, therefore, be independent of each other. At the lead peroxide plate we have lead peroxide paste, lead grid, and sulphuric acid. These are all the elements needed to produce a storage battery, and as the lead peroxide and the lead are touching each other, each lead peroxide plate really forms a short circuited cell. Why does this plate not discharge itself completely? A certain amount of discharge does take place, and results in a layer of lead sulphate forming between the lead peroxide and the grid. The sulphate, having high resistance then protects the lead grid and prevents any further action. This discharge action therefore does not continue, but causes a loss of a certain part of the charge.

At the negative plate, we have pure spongy lead, and the grid. This grid is not composed entirely of lead, but contains a percentage of antimony, a metal which makes the grid harder and stronger. There is but very little difference of potential between the spongy lead and the grid. A small amount of lead sulphate does form, however, on the surface of the negative plate. This is due to the action between the spongy lead and the electrolyte.

Some of the lead combines with the acid to form lead sulphate, but after a small amount has been formed the action is stopped because a balanced chemical condition is soon obtained.

Thus only a small amount of lead sulphate is formed at each plate, and the cell thereby loses only a small part of its charge. In a perfectly constructed battery the discharge would then stop. The only further action which would take place would be the slow evaporation of the water of the electrolyte. As the level of the electrolyte dropped below the tops of the plates, crystallization and sulphation would take place on the part of the negative plate above the electrolyte. The loss of charge which actually occurs in an idle charged battery is greater than that due to the formation of the small amounts of sulphate on the plates, and the evaporation of the water from the electrolyte.

Does an idle cell discharge itself by decomposing its electrolyte? We have a difference of potential of about two volts between the lead and lead peroxide plate. Why is the electrolyte not decomposed by this difference? At first it might seem that the water and acid should be separated into its parts, and hydrogen liberated at the negative plate. As a matter of fact, very little hydrogen gas is set free in an idle charged cell because to do so would require a voltage of about 2.5. At two volts, so little gas is formed that the loss of charge due to it may be neglected entirely.

The greatest loss of charge in an idle battery results from conditions arising from the processes of manufacture, internal troubles, and leakage between terminals. The grids of a cell are an alloy of lead and antimony. These are mixed while in a molten condition, and are then allowed to cool. If the cooling is not done properly, or if a poor grade of antimony is used, the resulting grid is not a uniform mixture of antimony and lead. There will be areas of pure lead, with an air hole here and there. The lack of uniformity in the grid material results in a local discharge in the grid. This causes some loss of charge.

If the active material completely fills the spaces between the grids, the acid formed as the cell is charged may not be able to diffuse into the main body of the electrolyte, but forms a small pocket of acid in the plate. This acid will cause a discharge between

paste and grid and a coating of lead sulphate forms on the grid, resulting in a certain loss of charge.

In the process of manufacturing and "forming" plates, graphite is sometimes used to give porosity to the paste, resulting in local action which causes a loss of charge. In general any metallic impurity in a cell will cause a loss at the lead plate. When a cell is charged, the current causes the metals to deposit on the lead plate. Local cells are formed by the metallic impurity, the lead plate, and the acid, and these tiny cells will discharge completely, causing a loss of charge. Such metals include iron, copper, tin, arsenic, antimony, and platinum. Of these, iron is perhaps the most destructive, as it travels back and forth from plate to plate, causing a loss of charge. The ions of this metal absorb an additional amount of electricity at the peroxide plate which they carry to the lead plate and there lose it. This action is continuous, and even a small amount of iron in an idle cell can cause an appreciable loss of charge in one day.

Incomplete removal of forming agents causes some local action in an idle cell which results in a loss of charge. Such substances are supposed to have been removed automatically as the forming process is completed, but some may remain and cause trouble.

Another cause of loss of charge in an idle cell is leakage of current between the terminals on the outside of the battery. During charge, the bubbles of gas which escape from the electrolyte carry with them minute quantities of acid which may deposit on the top of the battery and gradually form a thin conducting layer of electrolyte through which a current will flow from the positive to the negative terminals. This danger may be avoided by carefully wiping any moisture from the battery. Condensation of moisture from the air, on the top or sides and bottom of a battery will cause the same condition. This will be especially noticeable if a battery is kept in a damp place.

Impurities in any form are therefore to be guarded against. The use of impure acid or water will introduce objectionable substances. Every impurity causes local actions which cause a loss of charge and shorten the life of the battery.

CHAPTER 6.

THE DISCHARGE PHENOMENA.

Considered chemically, the discharge of a storage battery consists of the changing of the spongy lead and lead peroxide into lead sulphate, and the abstraction of the acid from the electrolyte. Considered electrically, the changes are more complex, and require further investigation. The voltage, internal resistance, rate of discharge, capacity, and other features must be considered,

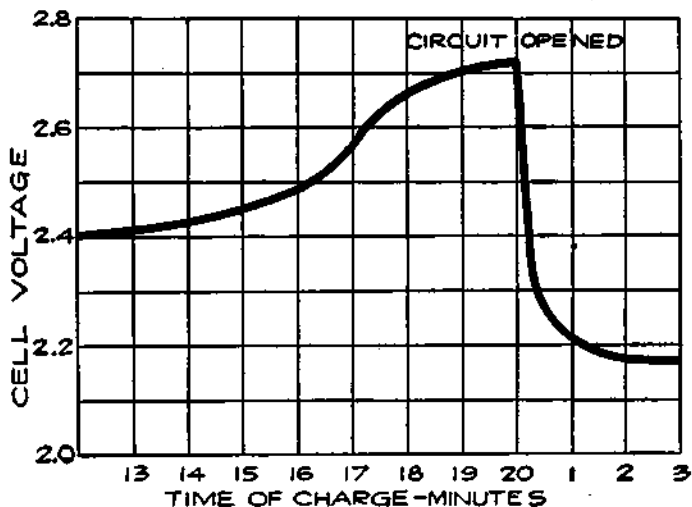

Fig. 11

and the effects of changes in one upon the others must be studied. This proceeding is simplified considerably if we consider each point separately. The abstraction of the acid from the electrolyte gives us the most reliable method of determining the condition of charge or discharge in the battery, and must also be studied.

Voltage Changes During Discharge. At the end of a charge, and before opening the charging circuit, the voltage of each cell is about 2.6 to 2.7 volts. As soon as the charging circuit is opened, the cell voltage drops rapidly to about 2.1 volts, within three or four minutes. This is due to the formation of a thin layer of lead sulphate on the surface of the negative plate and between the lead peroxide and the metal of the positive plate. Figure 11 shows how the voltage changes during the last eight minutes of charge, and how it drops rapidly as soon as the charging circuit is opened. The final value of the voltage after the charging circuit is opened is about 2.15-2.18 volts. This is more fully explained in Chapter 7. If a current is drawn from the battery at the instant

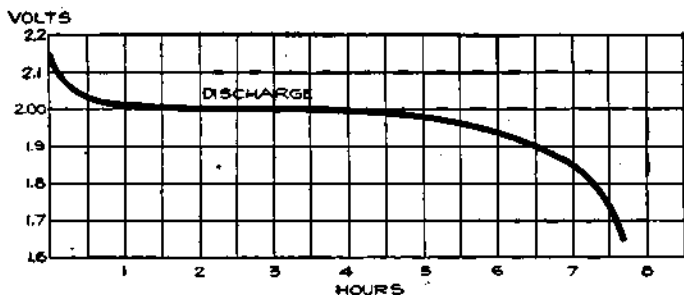

Fig. 12

the charge is stopped, this drop is more rapid. At the beginning of the discharge the voltage has already had a rapid drop from the final voltage on charge, due to the formation of sulphate as explained above. When a current is being drawn from the battery, the sudden drop is due to the internal resistance of the cell, the formation of more sulphate, and the abstracting of the acid from the electrolyte which fills the pores of the plate. The density of this acid is high just before the discharge is begun. It is diluted rapidly at first, but a balanced condition is reached between the density of the acid in the plates and in the main body of the electrolyte, the acid supply in the plates being maintained at a lowered density by fresh acid flowing into them from the main body of electrolyte. After the initial drop, the voltage decreases more slowly, the rate of decrease depending on the

amount of current drawn from the battery. The entire process is shown in figure 12. Lead sulphate is being formed on the surfaces, and in the body of the plates. This sulphate has a higher resistance than the lead or lead peroxide, and the internal resistance of the cell rises, and contributes to the drop in voltage. As this sulphate forms in the body of the plates, the acid is used up. At first this acid is easily replaced from the main body of the electrolyte by diffusion. The acid in the main body of the electrolyte is at first comparatively strong, or concentrated, causing a fresh supply of acid to flow into the plates as fast as it is used up in the plates. This results in the acid in the electrolyte growing weaker, and this, in turn, leads to a constant decrease in the rate at which the fresh acid flows, or diffuses into the plates. Furthermore, the sulphate, which is more bulky than the lead or lead peroxide fills the pores in the plate, making it more and more difficult for acid to reach the interior of the plate. This increases the rate at which the voltage drops.

The sulphate has another effect. It forms a cover over the paste which has not been acted upon, and makes it practically useless, since the acid is almost unable to penetrate the coating of sulphate. We thus have quantities of active material which are entirely enclosed in sulphate, thereby cutting down the amount of energy which can be taken from the battery. Thus the formation of sulphate throughout each plate and the abstraction of acid from the electrolyte cause the voltage to drop at a constantly increasing rate.

Theoretically, the discharge may be continued until the voltage drops to zero, but practically, the discharge should be stopped when the voltage of each cell has dropped to 1.7. If the discharge is carried on beyond this point all the spongy lead and lead peroxide have either been changed into lead sulphate, or have been covered up by the sulphate so effectively that they are almost useless. Plates in this condition require a very long charge in order to remove all the sulphate. Another danger arises if the discharge is continued. The lead of the grid is gradually changed to lead sulphate, and when the cell is recharged, the sulphate will be changed to spongy lead and lead peroxide, and the grid is consequently weakened.

The cell voltage will rise somewhat every time the discharge is stopped. This is due to the diffusion of the acid from the main body of electrolyte into the plates, resulting in an increased concentration in the plates. If the discharge is continuous, especially if at a high rate, this rise in voltage will bring the cell up to its normal voltage very quickly on account of the more rapid diffusion of acid which will then take place.

The voltage does not depend upon the area of the plate surface but upon the nature of the active materials and the electrolyte. Hence, although the plates of a cell are gradually being covered with sulphate, the voltage measured when no current is flowing, will fall slowly, and not in proportion to the amount of energy taken out of the cell. It is not until the plates are pretty thoroughly covered with sulphate, thus making it difficult for the acid to reach the active material, that the voltage begins to drop rapidly. This is shown clearly in figure 12, which shows that the cell voltage has dropped only a very small amount when the cell is 50% discharged. With current flowing through the cell, however, the increased internal resistance causes a marked drop in the voltage. Open circuit voltage is not useful, therefore to determine how much energy has been taken from the battery.

Acid Density. The electrolyte of a lead storage battery is a mixture of chemically pure sulphuric acid, and chemically pure water, the acid forming about 30 per cent of the volume of electrolyte when the battery is fully discharged. The pure acid has a "specific gravity" of 1.835, that is, it is 1.835 as heavy as an equal volume of water. The mixture of acid and water has a specific gravity of about 1.300. As the cell discharges, acid is abstracted from the electrolyte, and the weight of the latter must therefore grow less, since there will be less acid in it. The change in the weight, or specific gravity of the electrolyte is the best means of determining the state of discharge of a cell, provided that the cell has been used properly. In order that the value of the specific gravity may be used as an indication of the amount of energy in a battery, the history of the battery must be known. Suppose, for instance, that in refilling the battery to replace the water lost by the natural evaporation which occurs in the use of a battery, acid, or a mixture of acid and

water has been used. This will result in the specific gravity being too high, and the amount of energy in the battery will be less than that indicated by the specific gravity. Again, if pure water is used to replace electrolyte which has been spilled, the specific gravity will be lower than it should be. In a battery which has been discharged to such an extent that much of the paste has been covered by a layer of tough sulphate, or if a considerable amount of sulphate and active material has been loosened from the plates and has dropped to the bottom of the

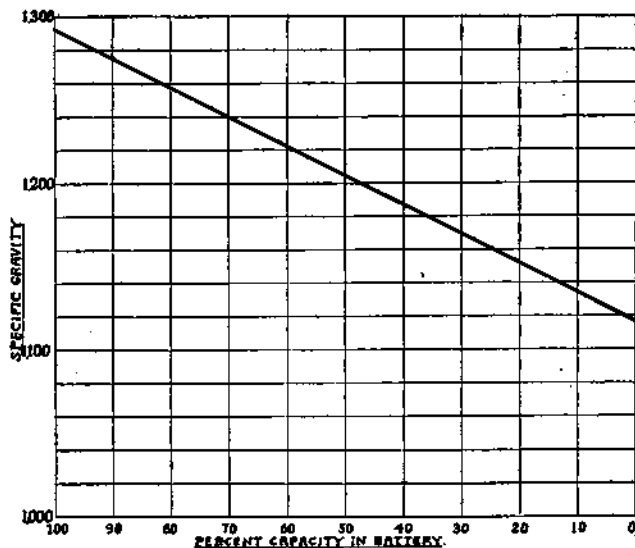

Fig. 13

cells, it will be impossible to bring the specific gravity of the electrolyte up to 1.300, even though a long charge is given. There must, therefore, be a reasonable degree of certainty that a battery has been properly handled if the specific gravity readings are to be taken as a true indication of the condition of a battery. Where a battery does not give satisfactory service even though the specific gravity readings are satisfactory, the latter are not reliable as indicating the amount of charge in the battery.

As long as a discharge current is flowing from the battery, the

acid within the plates is used up and becomes very much diluted. Diffusion between the surrounding electrolyte and the acid in the plates keeps up the supply needed in the plates in order to carry on the chemical changes. When the discharge is first begun, the diffusion of acid into the plates takes place rapidly because there is little sulphate clogging the pores in the paste, and because there is a greater difference between the concentration of acid in the electrolyte and in the plates than will exist as the discharge progresses. As the sulphate begins to form and fill up the pores of the plates, and as more and more acid is abstracted from the electrolyte, diffusion takes place more slowly.

If a battery is allowed to stand idle for a short time after a partial discharge, the specific gravity of the electrolyte will decrease because some of the acid in the electrolyte will gradually flow into the pores of the plates to replace the acid used up while the battery was discharging. Theoretically the discharge can be continued until all the acid has been used up, and the electrolyte is composed of pure water. Experience has shown, however, that the discharge of the battery should not be continued after the specific gravity of the electrolyte has fallen to 1.150. As far as the electrolyte is concerned, the discharge may be carried farther with safety. The plates determine the point at which the discharge should be stopped. When the specific gravity has dropped from 1.300 to 1.150, so much sulphate has been formed that it fills all the pores in the active material on the plates, and is beginning to form a tough covering over the paste. Figure 13 shows the change in the density of the acid during discharge.

Changes at the Negative Plate. Chemically, the action at the negative plate consists only of the formation of lead sulphate from the spongy lead. The lead sulphate is only slightly soluble in the electrolyte and is precipitated as soon as it is formed, leaving hydrogen ions, which then go to the lead peroxide plate to form water with other hydrogen ions and oxygen ions released at the peroxide plate. The sulphate forms more quickly on the surface of the plate than in the inner portions because there is a constant supply of acid available at the surface, whereas the formation of sulphate in the interior of the plate requires that acid diffuse into the pores of the spongy lead to replace that already used

up in the formation of sulphate. In the negative plate, however, the sulphate tends to form more uniformly throughout the mass of the lead, because the spongy lead is more porous than the lead peroxide, and because the acid is not diluted by the formation of water as in the positive plate. When the discharge has proceeded until the specific gravity of the electrolyte has decreased to 1.150, the sulphate has formed a tough coating over the surface of the plate and has filled the pores of the lead to such an extent that most of the spongy lead that remains is prevented from reacting with the acid because of the high resistance of the sulphate covering it. If the discharge is continued beyond this point, the acid begins to attack the grids and form a layer of sulphate on them. Subsequent charge will change this sulphate to spongy lead, thus making the grids weaker by the amount of the lead which formed the sulphate.

The sulphate has a greater volume than the lead from which it is formed and there is, therefore, an actual increase in the volume of the paste during discharge. The spongy lead being tough and coherent, this expansion does not cause the paste to fall from the plate, but simply results in a bulging out of material between the grid bars.

Changes at the Positive Plate. In a fully charged positive plate we have lead peroxide as the active material. This is composed of lead and oxygen. From this fact it is plainly evident that during discharge there is a greater chemical activity at this plate than at the negative plate, since we must find something to combine with the oxygen in order that the lead may form lead sulphate with the acid. In an ideal cell, therefore, the material which undergoes the greater change should be more porous than the material which does not involve as great a chemical reaction. In reality, however, the peroxide is not as porous as the spongy lead, and does not hold together as well.

The final products of the discharge of a positive plate are lead sulphate and water. The lead peroxide must first be reduced to lead, which then combines with the sulphate from the acid to form lead sulphate, while the oxygen from the peroxide combines with the hydrogen of the acid to form water. There is, therefore, a greater activity at this plate than at the lead plate, and the forma-

tion of the water dilutes the acid in and around the plate so that the tendency is for the chemical actions to be retarded. When the discharge has just begun, the positive plate grows darker in color, showing that the lead sulphate at first forms a definite compound with the lead peroxide. As the discharge progresses, the sulphate begins to form in white scales on the surface of the plate.

The sulphate causes the active material to bulge out because it occupies more space than the peroxide. This causes the lead peroxide at the surface to begin falling to the bottom of the jar in fine dust-like particles, since the peroxide here holds together very poorly.

The abstraction of acid from the electrolyte takes place at both plates, of course, but the positive has an additional handicap on account of the water formed in its pores. Experiments have shown that in order to have the peroxide plate working at its greatest capacity, the density of the electrolyte should be more than 1.300, while the negative has the greatest capacity when the electrolyte has a density of 1.220. The discharge of the battery, therefore, tends to have the negative operating at its greatest capacity, while the conditions at the positive are just opposite from what they should be in order to obtain the greatest capacity from this plate.

CHAPTER 7.

THE CHARGE PHENOMENA.

Voltage. Starting with a battery which has been discharged until its voltage has decreased to 1.7 per cell, we pass a current through it and cause the voltage to rise steadily. Figure 14 shows the changes in voltage during charge. Ordinarily the voltage begins to rise immediately and uniformly. If, however, the battery has been left in a discharged condition for some time, or has been "over discharged," the voltage rises very rapidly for a fraction of the first minute of charge and then drops rapidly to

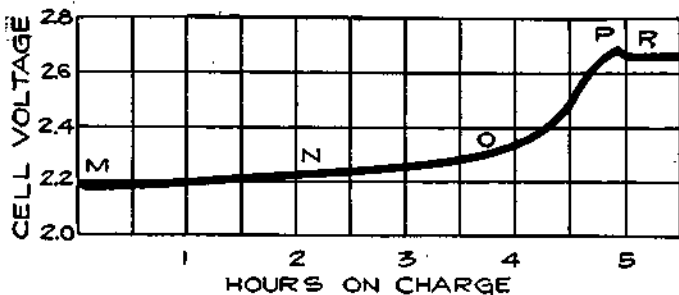

Fig. 14

the normal value and thereafter begins to rise steadily to the end of the charge. This rise at the beginning of the charge is due to the fact that the density of the acid in the pores of the plates rises rapidly at first, the acid thus formed being prevented from diffusing into the surrounding electrolyte by the coating of sulphate. As soon as this sulphate is broken through, diffusion takes place and the voltage drops.

As shown in Figure 14 the voltage remains almost constant between the points M and N. At N the voltage begins to rise because the charging chemical reactions are taking place farther and farther in the inside parts of the plate, and the concentrated acid formed by the chemical actions in the plates is diffusing

into the main electrolyte. This increases the battery voltage and requires a higher charging voltage.

At the point marked O, the voltage begins to rise very rapidly. This is due to the fact that the amount of lead sulphate in the plates is decreasing very rapidly, allowing the battery voltage to rise and thus increasing the charging voltage. Bubbles of gas are now rising through the electrolyte.

At P, the last portions of lead sulphate are removed, acid is no longer being formed, and hydrogen and oxygen gas are formed rapidly. The gas forces the last of the concentrated acid out of the plates and in fact, equalizes the acid concentration throughout the whole cell. Thus no further changes can take place, and the voltage becomes constant at R.

Density of Electrolyte. Discharge should be stopped when the density of the electrolyte, as measured with a hydrometer, is 1.150. When we pass a charging current through the battery, acid is produced by the chemical actions which take place in the plates. This gradually diffuses with the main electrolyte and causes the hydrometer to show a higher density than before. This increase in density continues steadily until the battery begins to "gas" freely. "Gassing" causes the electrolyte in the plates to mix thoroughly with that surrounding the plates and also increases the volume of the electrolyte and consequently decreases its density.

The progress of the charge is always determined by the density of the electrolyte. For this purpose in automobile batteries, a hydrometer is placed in a glass syringe having a short length of rubber tubing at one end, and a large rubber bulb at the other. The rubber tube is inserted in the cell and enough electrolyte drawn up into the syringe to float the hydrometer so as to be able to obtain a reading. This subject will be treated more fully in a later chapter.

Changes at Negative Plate. The charging current changes lead sulphate into spongy lead, and acid is formed. The acid is mixed with the diluted electrolyte outside of the plates, resulting in a rise in temperature. This is not objectionable unless the temperature rises to more than 105° F., since the concentrated acid formed in the plates diffuses into the electrolyte more rapidly

as the temperature is increased, thus hastening the charging actions. As the charging proceeds the active material shrinks or contracts, and the weight of the plate actually decreases on account of the difference between the weight and volume of the lead sulphate and spongy lead. If the cell has had only a normal discharge and the charge is begun soon after the discharge ended, the charge will proceed quickly and without an excessive rise in temperature. If, however, the cell has been discharged too far, or has been in a discharged condition for some time, the lead sulphate will not be in a finely divided state as it should be, but will be hard and tough and will have formed an insulating coating over the active material, causing the charging voltage to be high, and the charge will proceed slowly. When most of the lead sulphate has been reduced to spongy lead, the charging current will be greater than is needed to carry on the chemical actions, and will simply decompose the water into hydrogen and oxygen, and the cell "gasses." Spongy lead is rather tough and coherent, and the bubbles of gas which form in the pores of the negative plate near the end of the charge force their way to the surface without dislodging any of the active material.

Changes at the Positive Plate. When a cell has been discharged, a portion of the lead peroxide has been changed to lead sulphate, which has lodged in the pores of the paste and on its surface. During charge, the lead combines with oxygen from the water to form lead peroxide, and acid is formed. This acid diffuses into the electrolyte as fast as the amount of sulphate will permit. If the discharge has been carried so far that a considerable amount of sulphate has formed in the pores and on the surface of the plate, the action proceeds very slowly, and unless a moderate charging current is used, gassing begins before the charge is complete, simply because the sulphate cannot absorb the current. The gas bubbles which originate in the interior of the plate force their way to the surface, and in so doing cause numerous fine particles of active material to break off and fall to the bottom of the jar. This happens because the lead peroxide is a granular, non-coherent substance, with the particles held together very loosely, and the gas breaks off a considerable amount of active material.

CHAPTER 8.

CAPACITY OF STORAGE BATTERIES.

The capacity of a storage battery is the amount of electrical energy which can be obtained from it. The unit in which capacity is measured is the ampere-hour. Theoretically, a battery has a capacity of 40 ampere-hours if it furnishes ten amperes for four hours, and if it is unable, at the end of that time, to furnish any more current. If we drew only five amperes from this battery, it should be able to furnish this current for eight hours. Thus, theoretically, the capacity of a battery should be the same, no matter what current is taken from it. That is, the current in amperes, multiplied by the number of hours the battery furnished this current should be constant.

In practice, however, we do not discharge a battery to a lower voltage than 1.7 per cell, on account of the increasing amount of sulphate and the difficulty with which this is subsequently removed and changed into lead and lead peroxide. The capacity of a storage battery is therefore measured by the number of ampere hours it can furnish before its voltage drops below 1.7 per cell. This definition assumes that the discharge is a continuous one, that we start with a fully charged battery and discharge it continuously until its voltage drops to 1.7 per cell.

The factors upon which the capacity of storage batteries depend may be grouped in two main classifications:

1. Design and Construction of Battery.
2. Conditions of Operation.

Each classification may be subdivided. Under the Design and Construction we have:

- (a) Area of plate surface.
- (b) Quantity, arrangement, and porosity of active materials.

(c) Quantity and strength of electrolyte.

(d) Circulation of electrolyte.

These sub-classifications require further explanation. Taking them in order:

(a) Area of Plate Surface. It is evident that the chemical and electrical activity of a battery are greatest at the surface of the plates since the acid and active material are in intimate contact here, and a supply of fresh acid is more readily available to replace that which is depleted as the battery is discharged. This is especially true with high rates of discharge, such as are caused in starting automobile engines. Therefore, the capacity of a battery will be greater if the surface area of its plates is increased. With large plate areas a greater amount of acid and active materials are available, and an increase in capacity results.

(b) Quantity, Arrangement, and Porosity of Active Materials. Since the lead and lead peroxide are changed to lead sulphate on discharge, it is evident that the greater the amount of these materials, the longer can the discharge continue, and hence the greater the capacity.

The arrangement of the active materials is also important, since the acid and pastes must be in contact in order to produce electricity. Consequently the capacity will be greater in a battery, all of whose active material is in contact with the acid, than in one in which the acid reaches only a portion of the active materials. It is also important that all parts of the plates carry the same amount of current, in order that the pastes may be used evenly. As a result of these considerations, we find that the active materials are supported on grids of lead, that the plates are made thin, and that they have large surface areas. For heavy discharge currents, such as starting motor currents, it is essential that there be large surface areas. Thick plates with smaller surface areas are more suitable for low discharge rates.

Since the inner portions of the active materials must have a plentiful and an easily renewable supply of acid, the active materials must be porous in order that diffusion may be easy and rapid.

(c) Quantity and Strength of Electrolyte. It is important that there be enough electrolyte in order that the acid may not become exhausted while there is still considerable active material left.

An insufficient supply of electrolyte makes it impossible to obtain the full capacity from a battery. On the other hand, too much electrolyte, due either to filling the battery too full, or to having the plates in a jar that holds too much electrolyte, results in an increase in capacity. There is a danger present however, because with an excess of electrolyte the plates will be discharged before the specific gravity of the electrolyte falls to 1.150. This results in overdischarge of the battery with its attendant troubles as will be described more fully in a later chapter.

It is a universal custom to consider a battery discharged when the specific gravity of the electrolyte has dropped to 1.150, and that it is fully charged when the specific gravity of the electrolyte has risen to 1.300. The condition of the plates is, however, the true indicator of charged or discharged condition. With the correct amount of electrolyte, its specific gravity is 1.150 when the plates have been discharged as far as it is considered safe, and is 1.300 when the plates are fully charged. When electrolyte is therefore poured into a battery, it is essential that it contains the proper proportion of acid and water in order that its specific gravity readings be a true indicator of the condition of the plates as to charge or discharge, and hence show accurately how much energy remains in the cell at any time.

A question which may be considered at this point is why in automobile work a specific gravity of 1.300 is adopted for the electrolyte of a fully charged cell. There are several reasons. The voltage of a battery increases as the specific gravity goes up. Hence, with a higher density, a higher voltage can be obtained. If the density were increased beyond this point, the acid would attack the lead grids and the separators, and considerable corrosion would result. Another danger of high density is that of sulphation, as explained in a later chapter. Another factor which enters is the resistance of the electrolyte. It is desirable that this be as low as possible. If we should make resistance measurements on various mixtures of acid and water, we should find that with a small percentage of acid, the resistance is high. As the amount of acid is increased, the resistance will grow less up to a certain point. Beyond this point, the resistance will increase again as more acid is added to the mixture. The resistance is

lowest when the acid forms 30% of the total weight of the electrolyte. Thus, if the electrolyte is made too strong, the plates and also the separators will be attacked by the acid, and the resistance of the electrolyte will also increase. The voltage increases as the proportion of acid is increased, but the other factors limit the concentration. If the electrolyte is diluted, its resistance rises, voltage drops, and the amount of acid is insufficient to give much capacity. The density of 1.300 is therefore a compromise between the various factors mentioned above.

(d) Circulation of Electrolyte. This refers to the passing of electrolyte from one plate to another, and depends upon the ease with which the acid can pass through the pores of the separators. A porous separator allows more energy to be drawn from the battery than a non-porous one.

Considering now the operating conditions, we find several items to be taken into account. The most important are

(e) Rate of discharge.

(f) Temperature.

(e) Rate of Discharge. As mentioned above, the ampere hour rating of a battery is based upon a continuous discharge, starting with a specific gravity of 1.300, and finishing with 1.150. The end of the discharge is also considered to be reached when the voltage per cell has dropped to 1.7. With moderate rates of discharge the acid is abstracted slowly enough to permit the acid from outside the plates to diffuse into the pores of the plates and keep up the supply needed for the chemical actions. With increased rates of discharge the supply of acid is used up so rapidly that the diffusion is not fast enough to hold up the voltage. This fact is shown clearly by tests made to determine the time required to discharge a 100 Amp. Hr., 6 volt battery to 4.5 volts. With a discharge rate of 25 amperes, it required 160 minutes. With a discharge rate of 75 amperes, it required 34 minutes. From this we see that making the discharge rate three times as great caused the battery to be discharged in one fifth the time. These discharges were continuous, however, and if the battery were allowed to rest, the voltage would soon rise sufficiently, to burn the lamps for a number of hours.

The conditions of operation in automobile work are usually

considered severe. In starting the engine, a heavy current is drawn from the battery for a few seconds. The generator starts charging the battery immediately afterward, and the starting energy is soon replaced. As long as the engine runs, there is no load on the battery, as the generator will furnish the current for the lamps, and also send a slight charge into the battery. If the lamps are not used, the entire generator output is utilized to charge the battery, unless some current is furnished to the ignition system. Overcharge is quite possible.

When the engine is not running, the lamps are the only load on the battery, and there is no charging current. Various drivers have various driving conditions. Some use their starter frequently, and make only short runs. Their batteries run down. Other men use the starter very seldom, and take long tours. Their batteries will be overcharged. The best thing that can be done is to set the generator for an output that will keep the battery charged under average conditions.

From the results of actual tests, it may be said that modern lead-acid batteries are not injured in any way by the high discharge rate used when a starting motor cranks the engine. It is the rapidity with which fresh acid takes the place of that used in the pores of the active materials that affects the capacity of a battery at high rates, and not any limitation in the plates themselves. Low rates of discharge should, in fact, be avoided more than the high rates. Battery capacity is affected by discharge rates, only when the discharge is continuous, and the reduction in capacity caused by the high rates of continuous discharge does not occur if the discharge is an intermittent one, such as is actually the case in automobile work. The tendency now is to design batteries to give their rated capacity in very short discharge periods. If conditions should demand it, these batteries would be sold to give their rated capacity while operating intermittently at a rate which would completely discharge them in three or four minutes. The only change necessary for such high rates of discharge is to provide extra heavy terminals to carry the heavy current.

The Society of Automotive Engineers, in January, 1914, adopted

a standard method of rating, starting and lighting batteries, as follows:

“Batteries for combined lighting and starting service shall have two ratings, of which the first shall indicate the lighting ability, and the capacity in ampere hours of the battery when discharged continuously at a 5 ampere rate to a final voltage of 1.8 per cell, the temperature of the battery beginning such discharge being 80°F. The second rating shall indicate starting ability and shall be the rate in amperes at which the battery will discharge for twenty minutes continuously to a final voltage of not less than 1.65 per cell. The temperature of the battery beginning such discharge to be 80°F.”

The discharge rate required under the average starting conditions is higher than that specified above, and would cause the required drop in voltage in about fifteen minutes. In winter, when an engine is cold and stiff, the work required from the battery is even more severe, the discharge rate being equivalent in amperes to probably four or five times the ampere-rating of the battery. On account of the rapid recovery of a battery after a discharge at a very high rate, it seems advisable to allow a battery to discharge to a voltage of 1.0 per cell when cranking an engine which is extremely cold and stiff.

(f) **Temperature.** Chemical reactions take place much more readily at high temperatures than at low. Furthermore, the active materials are more porous, the electrolyte lighter, and the internal resistance less at higher temperatures. Opposed to this is the fact that at high temperatures, the acid attacks the grids and pastes, and lead sulphate is formed, even though no current is taken from the battery. Other injurious effects are the destructive actions of hot acid on the wooden separators used in most starting and lighting batteries. Greater expansion of paste will also occur, and this expansion is not, in general, uniform over the surface of the plates. This results in unequal strains and the plates are bent out of shape, or “buckled.” The expansion of the paste will also cause much of it to fall from the plates, and we then have “shedding.”

When sulphuric acid is poured into water, a marked temperature rise takes place. When a battery is charged, acid is formed.

and when this mixes with the diluted electrolyte, a temperature rise occurs. In discharging, acid is taken from the electrolyte, and the temperature drops. On charging, therefore, there is danger of overheating, while on discharge, excessive temperatures are not likely. Fig. 15 shows the temperature changes on charge and discharge.

Another factor which should be considered in connection with capacity is the age of the battery. New batteries will seldom

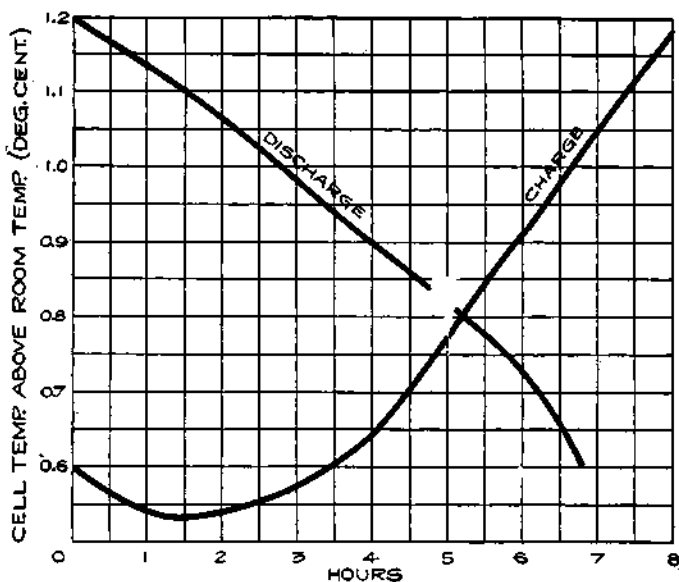

Fig. 15

give their rated capacity when received from the manufacturer. This is due to the methods of making the plates. The "paste" plates, such as are used in automobiles, are made by applying oxides of lead, mixed with sulphuric acid, to the grids. These oxides must be subjected to a charging current in order to produce the spongy lead and lead peroxide. After the charge, they must be discharged, and then again charged. This is necessary because not all of the oxides are changed to active material on one charge, and repeated charges and discharges are required

to produce the maximum amount of active materials. Manufacturers do not charge and discharge a battery a sufficient number of times before sending it out, and after a battery is put into use, its capacity will increase for some time, because more active material is produced during each charge.

When a battery has been in use for some time, a considerable portion of the paste will have fallen from the positive plates, and a decrease in capacity will result. Such a battery will charge faster than a new one because the amount of sulphate which has formed when the battery is discharged is less than in a newer battery. Hence, the time required to reduce this sulphate will be less, and the battery will "come up" faster on charge.

CHAPTER 9.

INTERNAL RESISTANCE.

The resistance offered by a storage battery to the flow of a current through it results in a loss of voltage, and in heating. Its value should be as low as possible, and, in fact, it is almost negligible even in small batteries, seldom rising above 0.05 ohm. On charge, it causes the charging voltage to be higher and on discharge causes a loss of voltage. Figure 16 shows the variation in resistance.

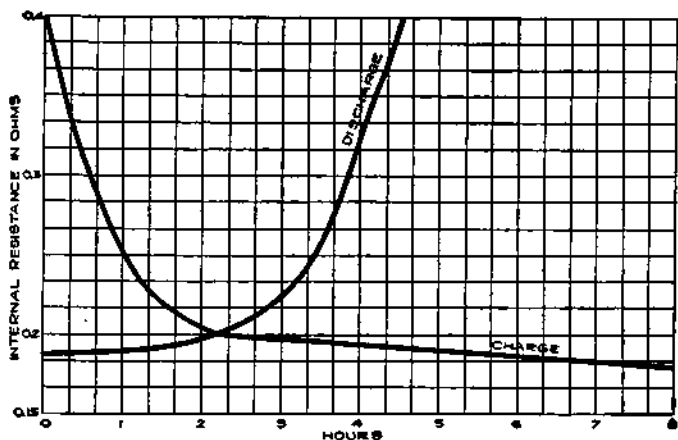

Fig. 16

The resistance as measured between the terminals of a cell is made up of several factors as follows:

- 1. Grids.** This includes the resistance of the terminals, connecting links, and the framework upon which the active materials are pasted. This is but a small part of the total resistance, and does not undergo any considerable change during charge and discharge. It increases slightly as its temperature goes up.

2. Electrolyte. This refers to the electrolyte between the plates, and varies with the amount of acid and with temperature. As mentioned in the preceding chapter, a mixture of acid and water in which the acid composes thirty per cent of the total weight of electrolyte has the minimum resistance. Diluting or increasing the concentration of the electrolyte will both cause an increase in resistance from the minimum value. The explanation probably lies in the degree to which the acid is split up into "ions" of hydrogen (H), and sulphate (SO_4). These "ions" carry the current through the electrolyte. Starting with a certain amount of acid, let us see how the ionization progresses. With very concentrated acid, ionization does not take place, and hence, there are no ions to carry current. As we mix the acid with water, ionization occurs. The more water used, the more ions, and hence, the less the resistance, because the number of ions available to carry the current increases. The ionization increases to a certain maximum degree, beyond which no more ions are formed. It is probable that an electrolyte containing thirty per cent of acid by weight is at its maximum degree of ionization and hence its lowest resistance. If more water is now added, no more ions are formed. Furthermore, the number of ions per unit volume of electrolyte will now decrease on account of the increased amount of water. There will therefore be fewer ions per unit volume to carry the current, and the resistance of the electrolyte increases.

With an electrolyte of a given concentration, an increase of temperature will cause a decrease in resistance. A decrease in temperature will, of course, cause an increase in resistance. It is true, in general, that the resistance of the electrolyte is about half of the total resistance of the cell. The losses due to this resistance generally form only one per cent of the total losses, and are a practically negligible factor.

3. Active Material. This includes the resistance of the pastes and the electrolyte in the pores of the active materials. This varies considerably during charge and discharge. It has been found that the resistance of the peroxide plate changes much more than that of the lead plate. The change in resistance of the positive plate is especially marked near the end of a discharge. The composi-

tion of the active material, and the contact between it and the grid affect the resistance considerably.

During charge, the current is sent into the cell from an external source. The grids therefore carry most of the current. The active material which first reacts with the acid is that near the surface of the plate, and the acid formed by the charging current mixes readily with the main body of electrolyte. Gradually, the charging action takes place in the inner portions of the plate, and concentrated acid is formed in the pores of the plate. As the sulphate is removed, however, the acid has little difficulty in mixing with the main body of electrolyte. The change in resistance on the charge is therefore not considerable.

During discharge, the chemical action also begins at the surface of the plates and gradually moves inward. In this case, however, sulphate is formed on the surface first, and it becomes increasingly difficult for the fresh acid from the electrolyte to diffuse into the plates so as to replace the acid which has been greatly diluted there by the discharge actions. There is therefore an increase in resistance because of the dilution of the acid at the point of activity. Unless a cell is discharged too far, however, the increase in resistance is small.

If a battery is allowed to stand idle for a long time it gradually discharges itself, as explained in a previous chapter. This is due to the formation of a tough coating of crystallized lead sulphate, which is practically an insulator. These crystals gradually cover and incapsulate the active material. The percentage change is not high, and generally, amounts to a few per cent only. The chief damage caused by the excessive sulphation is therefore not an increase in resistance, but consists chiefly of making a poor contact between active material and grid, and of removing much of the paste from action by covering it.

CHAPTER 10.

BATTERY DISEASES.

Storage batteries have their own peculiar troubles which produce injuries that are not always curable. The chief troubles met with are as follows:

1. Sulphation.
2. Loss of capacity.
3. Buckling of plates in battery.
4. Hardening of negative plates when exposed to air.
5. Buckling of positive plates when exposed to light.
6. Internal discharge.

These troubles are not entirely independent of one another, since the causes of one of them may include some of the others.

1. Sulphation. Many battery men say a battery is sulphated whenever anything is wrong with it. Sulphation is the formation of lead sulphate on the plates. As a battery discharges, it is entirely natural and normal for lead sulphate to form. When the voltage of a battery has dropped to about 1.7 per cell, there is still a considerable portion of active material left, but much of it is covered by sulphate and thus made useless. A normal charge will change this sulphate to active material. If the discharge is continued after the voltage has dropped to 1.7 per cell, so much sulphate has been formed that it is difficult to change it to active material. Moreover, the expansion of the paste which takes place when lead sulphate is formed may be so great that it causes the paste to break off from the plate and fall to the bottom of the jar.

If a battery is charged and discharged intermittently, and the discharge is greater than the charge, the battery may never be fully charged, and there will always be sulphate present. If a battery which has been discharged is allowed to stand idle for several months, the sulphate which was formed during the dis-

charge changes. Instead of being finely divided, it now forms crystals which grow by the addition of sulphate from other parts of the plates. These crystals can be reduced to active material only with the greatest difficulty, and often it is impossible to do so.

Another factor which aids in the "sulphation," is the self-discharge caused by impurities. These cause local actions which partly discharge the battery and add their quotas of sulphate. A completely charged battery can, in an emergency, be left idle for six months without causing an excessive amount of sulphate to form and crystallize.

Usually, most of the sulphate is formed by the chemical actions which produce the electrical energy. Useless chemical action occurs however between paste and electrolyte which result in the formation of lead sulphate even though no current is taken from the battery. Thus a certain amount of sulphate forms on the surface of the spongy lead and between the lead peroxide and the positive grids. Since these are entirely normal actions, they can hardly be classified as diseases. If there is too much acid in the electrolyte, or its temperature is allowed to become too high, an abnormal amount of sulphate is formed, because hot concentrated acid is more active chemically than the normal electrolyte.

Over-sulphation is often caused by the loosening of the active material and consequent short circuit between the plates. Sulphation from any cause may result in shedding, buckling, loss of capacity, loss of efficiency and an increased temperature while charging and discharging. The voltage of a sulphated battery will be below normal on discharge and above normal on charge.

If the electrolyte is allowed to fall below the tops of the plates, so that the pastes are exposed to the air, the parts thus exposed will gradually sulphate, especially on the negative plates. Some of the sulphate is formed because the current heats up those parts of the grids which are not covered by acid. This heats the pastes and any acid in them. The sulphate which has been formed by normal discharge will be dissolved on account of the heat, and will then form in crystals as the heat dries up the acid. This will take place on both positive and negative plates. After sulphate has been formed in this way, no more is formed on the positive

plate. On the negative plate, however, the sulphate continues to form. This is explained as follows:

The negative paste is spongy lead, which is in an unstable chemical condition. The dry spaces between the plates and above the surface of the electrolyte contain definite amounts of sulphur dioxide (SO_2), and sulphur trioxide (SO_3), liberated during the chemical reactions of the cell. These unite with the spongy lead to form lead sulphate. The spongy lead first absorbs oxygen from the air and becomes oxidized, then combines with the dioxide and trioxide to form lead sulphate. Gradually the entire negative active material becomes sulphated in this way. The lead peroxide does not sulphate when dry because it is in a stable condition.

Lead sulphate does not form uniformly over the surfaces of the plates as a battery discharges. At the beginning of a discharge it is supposed that the lead sulphate forms chemical compounds. The reason for this belief is that a peroxide plate grows darker at first instead of lighter as we should expect, since lead sulphate is white, and a mixture of lead peroxide and lead sulphate should be lighter than the peroxide alone. After a time, however, patches of the white sulphate appear on the plate surfaces. If only a normal discharge is given, it is not difficult to change this sulphate to active material. If the sulphate is allowed to crystallize, however, it is a very difficult matter. The crystallized sulphate is tough, and is a good insulator. Such a plate must be charged at a low rate, because so much of the active material is covered with the sulphate that the current cannot reach it. Only a small portion of the active material is uncovered and hence in contact with the acid. These parts must carry all the charging current, and if this current is not low, the small patches of active material which must carry the current become very hot, resulting in serious injury to them. Furthermore, if a large charging current is used, the water of the electrolyte is split into hydrogen and oxygen, and gassing results. This causes chips of the sulphate to break off and fall to the bottom of the cell, and thus be removed from action.

Another danger from large charging currents in sulphated plates is that the parts carrying the current will become hotter

than other parts. This results in an unequal expansion of paste and grids, and the plate may be warped and bent out of shape.

We see, therefore, that the presence of lead sulphate is objectionable only when an excessive amount is formed, or when it becomes crystallized. A small amount of sulphate in the positive plate is desirable, in fact. Lead peroxide does not hold together well, but a small amount of sulphate acts as a cement and binds the particles of the paste together. At the surface of the plate, the sulphate is almost completely removed on charge, and some of the peroxide loses its hold on the plate and falls to the bottom of the cell. This is called "shedding" of the active material. A battery which is kept slightly undercharged will have a longer life than one which is continually overcharged.

The best remedy for a sulphated battery is to pass a charge of low amperage through the cells for a long time. The charge rate should not be much above $1/25$ of the capacity of the battery in ampere-hours and should be continued until the specific gravity has risen to its normal value of 1.280-1.300 and has remained constant for three or four hours. At this time all of the cells should be gassing rather freely. The length of time required may be from one day to one week of continuous charging or a succession of charges of equivalent time.

2. Loss of Capacity. This subject may be again subdivided, as quite a number of factors must be considered. Some of them are given under the main headings at the beginning of this chapter. They are as follows:

(a) **Impurities in Electrolyte.** These result in local action and self-discharge. They can sometimes be removed by giving the battery a complete charge, discarding the electrolyte, and putting in new electrolyte of the proper specific gravity to bring it to 1.280-1.300 when fully charged.

(b) **Low Gravity of Electrolyte.** Low gravity may result from lack of charge, replacing spilled electrolyte or electrolyte which has leaked out through a cracked jar, with water. This condition may be remedied by charging until the cells are gassing freely and no further increase in specific gravity occurs, and then removing some of the electrolyte and adding electrolyte of

1.400 gravity. Then give battery a full charge. It may be necessary to empty out the old electrolyte and put in new electrolyte. If the maximum specific gravity of the old electrolyte was 1.200, use 1.400 electrolyte, and if the old electrolyte has a different strength, vary the specific gravity of the new accordingly.

(c) High Gravity of Electrolyte. This is caused by incorrect mixtures of acid and water in preparing electrolyte, and by adding raw acid or electrolyte in making up for loss of electrolyte by evaporation. It results in sulphation, burned separators, or corroded plates, all of which cause a loss of capacity.

(d) Sulphation. This has already been explained.

(e) Pores of Separators Filled With Impurities or Active Material From Bulged Plates. This prevents circulation of electrolyte, which hinders chemical action and thus reduces capacity. Generally, a battery in this condition has been neglected or abused. The plates will probably be found to be in need of repairs, a subject which will be discussed more fully later.

(f) Bulged Active Material on Negative Plates, Causing Poor Contact Between Paste and Grid. If the lead does not have a granular appearance, or if active material has not been shed to any considerable extent, pressing the plates in a vise or press (see page 215) will remedy the trouble. When the bulged paste has been pressed back into the grids, it will be necessary to charge and discharge the battery several times in order to put the spongy lead in an active condition.

(g) Lack of Sufficient Charging and Discharging of New Batteries, Batteries Which Have Been Sulphated, and Rebuilt, Batteries With New Plates. This can be remedied generally by charging and discharging two or three times, and adjusting electrolyte so as to have proper specific gravity by removing some of old electrolyte and adding water or 1.400 electrolyte, as the case may be.

If in doubt as to the battery's condition, charge it until it gasses freely, and the specific gravity of the electrolyte does not increase over several hours. Now discharge the battery at one fourth to one fifth of its ampere hour capacity. If, when the battery voltage has dropped to 1.7 per cell, the battery has de-

livered fifty to sixty per cent of its ampere hour capacity, based on its eight hour rate, the battery should give reasonable service. If convenient, make the cadmium test (see page 266). If this test shows that the plates of any cell are in a poor condition, the battery must be opened and the trouble found and repaired (see page 187).

(h) Corroded Grids. Caused by nonuniform mixture in alloy of which grids are made, by the chemical action resulting from electrolytic decomposition of highly dilute acid in the pores of the active material, and by the presence of lead dissolving acids or their compounds in the electrolyte. The first condition is hopeless. The second is also, as it occurs in every cell if the discharge is carried too far, or if the plates have a thick layer of active material when the rate of discharge is high. If the electrolyte contains impurities which attack the lead, the remedy is to pour out the old electrolyte, and put in fresh, which is known to be chemically pure.

Corrosion is also the natural result of the action of the acid on the plates, and is the natural depreciation occurring in the plates. This can be retarded by keeping the specific gravity of the electrolyte slightly below that for full charge. This corrosion tends to take place most rapidly at the surface of the electrolyte, and the damage at this point can be lessened by keeping the plates covered with electrolyte, and making the terminal bars and lugs extra large in cross section.

(i) Reversal of Negative Plates. If one cell of a battery has an internal short circuit, or some other defect which causes it to lose its charge, the cell will be discharged before the others which are in series with it, and when this cell is completely discharged, the other cells will send a current through it in a discharge direction, and the negative plates will have a coating of lead peroxide formed on them, and will assume the characteristics of positive plates.

This reversal may also be the result of charging a battery in the wrong direction, on account of reversed charging connections. The remedy is to charge the battery for a long time in the proper direction. If the reversal was caused by some defect within the cell itself, the cause of the defect should be found and removed.

Such defects may be internal short circuit, local action caused by impurities, loss of active material, sulphation, etc.

(j) **Loss of Active Material, or Shedding.** This is a natural action for positive plates, since the lead peroxide is not coherent, and as it expands, on discharge, outer layers are forced off, and fall to the bottom of the jar. Internal short circuits, sulphation, or buckling of the grids will also cause shedding. The positive plate becomes extremely thin and gradually wears out, or ages. Excessive charging rates resulting in violent evolution of gas. This loosens some of the active material and causes it to drop to the bottom of the jar. Normal charging rates will cause shedding in sulphated plates because gassing will take place due to the fact that the plates do not have enough active material exposed to the current to use all the current in producing chemical action. A current which is normal for a battery in good condition is therefore excessive for a sulphated battery.

Should the active material be loosened from the grids and fall to the bottom of the cell in large quantities, it will not only result in short circuiting the plates but will also result in a loss of capacity because of the decreased volume of material remaining in the grids. Shedding is usually the result of overcharge or buckling. It is also caused by the addition of raw acid or electrolyte in place of water. The remedy is to have the plates repasted in a battery repair depot that is equipped for such work. A certain amount of space is left between the bottom of the plates and the bottom of the cells to care for this sediment but if the collection is allowed to grow until it touches the plates, short circuiting will result. The remedy is to have the plates removed and the cells cleaned at intervals of nine months to one year.

(k) **Negative Plates Granulated.** The spongy lead tends to become granulated and dense in structure, and to lose its porosity so that it resembles ordinary lead. This is a natural and unavoidable condition, and is simply the natural ageing of the spongy lead.

The remedy for this condition is to discharge the battery, remove the negative plates, place them in a bath of electrolyte of 1.200 specific gravity sulphuric acid, in which sheets of ordinary lead, 1/16 inch thick are also placed. Current is sent through

the combination, entering at the negative plates and leaving at the "dummy" electrodes of ordinary lead. The spongy lead first turns into lead monoxide (PBO), and then lead peroxide (PBO₂). When all the spongy lead has been changed to lead peroxide, the current is reversed. Before reversing the current, however, the electrolyte is poured out and new electrolyte used, in order that any impurities in the old electrolyte may not be redeposited on the negative plates. The lead peroxide now changes back to spongy lead, and when the plates are replaced and the battery reassembled, it will be found to have regained the capacity which was lost by the ageing of the spongy lead.

(1) Improperly constructed battery, or one which has been poorly designed. Inferior materials and poor workmanship result in a battery of low capacity.

3. Buckling. This is the bending or twisting of plates, and is caused by unequal expansion of the various parts of the active material. Buckled plates are saucer shaped, the center portions expanding more than the edges on account of being less firmly braced and supported. Any conditions of operation which will cause excessive or non-uniform expansion of active material will result in buckling. These conditions are as follows:

(a) Overdischarge. If discharge is carried too far, the expansion of the active material on account of the formation of lead sulphate will bend the grids out of shape, and may even break them.

(b) Continued Operation With Battery In a Discharged Condition. When a considerable amount of lead sulphate has formed, and current is still drawn from the battery, those portions of the plate which have the least amount of sulphate will carry all the current, and will therefore become heated and expand. The parts covered with sulphate will not expand, and the result is that the parts that do expand will twist the plate out of shape. A normal rate of discharge may be sufficient to cause buckling in a sulphated plate.

(c) Charging at High Rates. If the charging rate is excessive, the temperature will rise so high that excessive expansion will take place. This is usually unequal in the different parts of the plate, and buckling results. With a battery that has been

over-discharged, the charging current will be carried by those parts of the plates which are the least sulphated. These parts will therefore expand while others will not, and buckling results.

(d) **Non-Uniform Distribution of Current Over the Plates.** In a battery which has not been over-discharged, buckling may result if the current carried by the various parts of the plate is not uniform on account of faulty design, or careless application of the paste. This is a fault of the manufacturers, and not the operating conditions.

(e) **Defective Grid Alloy.** If the metals of which the grids are composed are not uniformly mixed throughout the plate, areas of pure lead may be left here and there, with air holes at various points. The electrolyte enters these air holes, attacks the lead and converts the grid partly into active material. This causes expansion and consequent distortion and buckling.

Buckling will not necessarily cause trouble, and batteries with buckled plates may operate satisfactorily for a long time. If, however, the expansion and twisting has caused much of the active material to break away from the grid, or has loosened the active material from the grids, much of the battery capacity is lost. Another danger is that the lower edges of a plate may press against the separator with sufficient force to cut through it, touch the next plate, and cause a short-circuit, and the battery fails.

If buckling is caused by defective plates, there is no remedy except to avoid discharging the plate very far, and protect the battery from the effects of light and heat. If over-discharge, or other conditions not resulting from defective plates have caused buckling, and if the active material has not been loosened from the grids, or has not dropped to the bottom of the cell, it is possible to remove the separators, put in boards having same thickness as the separators, and then slowly and carefully compress the plates in a vise until restored to shape. If the buckling has been so excessive that parts of the grids have broken, much paste has been lost, or a short circuit has resulted, the only remedy is to install new plates.

4. **Hardening of Negatives.** When negative plates are exposed to air, the spongy lead, instead of being soft and finely divided,

crystallizes and oxidizes, and becomes hard. This causes the paste to become heated. The acid which remains in the plate will also heat, and attack the spongy lead. Negative plates should therefore always be immersed in water or weak electrolyte when removed from a battery.

5. Buckling of Positive Plates When Exposed to Light. A phenomenon for which no explanation has been found is that positive plates buckle when exposed to light, the side toward the light becoming concave. The positive plates should therefore be kept in a dark box or cupboard when removed from the battery.

6. Internal Discharge. This shows itself by the gradual loss of charge when a fully or partly charged battery is allowed to stand idle. The causes are:

(a) Formation of layer of sulphate between the lead peroxide and the grid.

(b) Formation of a layer of sulphate on the surface of the negative plate.

(c) Impurities in plates which form small cells with the active materials and by their discharge take away some of the battery capacity.

These points have already been explained. See page 26.

CHAPTER 11.

CONDITIONS OF OPERATION.

The starting and lighting equipment of a gasoline automobile consists of three principal parts.

1. The Battery.
2. The Starting Motor.
3. The Dynamo or Generator.

The normal course of operation of this system consists of

(a) **Cranking the Engine With the Starting Motor.** A switch is operated whereby the battery is connected to the starting motor, causing the latter to put the engine in motion. As soon as the gasoline has begun to vaporize, and is mixed with the correct amount of air, the sparks at the spark plugs ignite the mixtures of air and gasoline which are drawn into the engine cylinders. The engine then operates under its own power. The starting switch is then opened, disconnecting the motor from the battery. As long as the engine now continues to run under its own power, the starting motor is not used.

(b) **Charging the Battery.** The current taken by the starting motor is a heavy one, and discharges the battery to a considerable extent. The energy taken out must therefore be replaced. This is done by the dynamo. It is important, however, that the dynamo should not be connected to the battery until the engine is operating above a certain minimum speed. This is necessary because a dynamo must develop a voltage which is greater than that of the battery before it can send a current through the battery so as to charge it. In order to develop this voltage, the speed of the dynamo must reach a certain value. Should the dynamo be connected to the battery at a lower speed, its voltage would be less than that of the battery, and instead of the dynamo sending a current through the battery, the battery

will send a current through the dynamo, and thus lose more energy.

In most cars, the switch which connects the dynamo to the battery operates automatically, and does not operate until the voltage of the dynamo is slightly greater than that of the battery. It is known as the "circuit breaker," "cutout relay," or simply the "cutout." When the speed of the engine decreases, the voltage developed by the dynamo also decreases, and it becomes necessary to disconnect the dynamo from the battery when the dynamo voltage begins to drop below that of the battery. This is also done by the cutout. The construction cutouts will be explained more fully later. Some cars have no automatic cutout, but use a hand operated switch. Others have both the automatic and the hand operated switches.

(c) **Furnishing Current to the Lamps.** When the engine is not running, the battery is the only source of electricity on the car, and therefore operates the lights. When the engine is in operation, and the dynamo is sending a current through the battery, or is "charging" it, the dynamo also supplies the current to operate the lamps.

These conditions of operation seem to be simple enough, and as long as all parts work as they should, no difficulties are encountered. In order to obtain satisfactory service, however, a number of things must be considered.

Normal Conditions of Operation, Engine Idle.

When the engine is idle and the lamps and all other electrical equipment on the automobile are entirely disconnected from the battery by means of their controlling switches, there should be no current delivered by the battery. When there is no current delivered by the battery under the above conditions, it indicates that there are no shorts or grounds connecting the positive and negative terminals of the battery or between the battery and the terminals of the various switches. It also indicates that the cutout, whether it be mechanical, electro-magnetic or manual, is open and no current is being delivered by the battery to the dynamo armature. When the battery shows a discharge with

all the various controlling switches open, it may be due to grounds, short circuits or improper operation of the cutout. An inspection of the cutout will soon tell whether it is closed or not, and thus eliminate this possible cause of trouble, which reduces the difficulty to a short circuit or ground. A thorough inspection of the circuit will be necessary in order to determine the exact location of this kind of trouble.

It is not advisable to equip an automobile with lamps whose candlepower exceeds that recommended by the manufacturer of the car or equipment maker. If the current delivered by the battery with the lamps turned on exceeds the normal value for that particular car, it may be due to lamps of higher candlepower having been substituted for the standard equipment, or shorts and grounds. A short or ground may also be thrown onto the battery circuit when the switches controlling special electrical equipment, such as electric gear shifts, horns, trouble lamps, etc., are closed. It is always advisable to test each of these different circuits separately in order to make sure that they are free from shorts and grounds and not drawing an excessive current from the battery when in operation.

Normal Conditions of Operation, Engine Running.

When a manual type of cutout is used the battery and dynamo are connected together through a switch whose operation is controlled by the driver of the car. These switches are of different forms and arrangements, some being combined with the ignition switch, some with the starting switch, while some may operate to a certain extent independent of either the starting or ignition switches. With this type of cutout the operation of the dynamo and the adjustment of the regulator controlling the output of the dynamo should be such that the battery will be charging when the engine is running at very low speeds. If this adjustment is not made, it is advisable not to run the engine at very low speeds at any time with the cutout closed, as the voltage of the dynamo will be lower than the voltage of the battery and, hence, the battery will discharge back into the

dynamo. A condition of this kind may be the cause of a discharged battery. The car speed at which the battery starts to discharge may be determined by connecting an ammeter in series with the battery and observing its indication as the speed of the engine or car is decreased. The speedometer indication, when the car is running and the ammeter indicating zero current, corresponds to what might be called the neutral speed; that is, the voltage of the generator and battery are equal and the battery is neither charging nor discharging. This neutral speed should not be excessive, as a high neutral speed means a relatively low dynamo voltage, and hence a corresponding decrease in output of the dynamo.

If a mechanical cutout is used its adjustment should be such that the circuit connecting the dynamo and battery is not closed until the speed of the dynamo is sufficient to cause a generated voltage in its armature winding greater than the voltage of the battery. If this cutout closes too soon the battery will discharge when the circuit is first closed and will continue to do so until the speed of the dynamo is ample to cause the generated voltage in its armature winding to be equal to or greater than the voltage of the battery. This type of cutout may be tested by observing the indications of an ammeter connected in series with the battery while the speed of the engine is gradually increased. If the voltage of the dynamo is less than the voltage of the battery when the cutout closes, the ammeter will indicate a discharge from the battery. If the voltage of the dynamo happens to be equal to the voltage of the battery when the circuit is closed, there will be no indication on the ammeter, but as the speed of the engine is increased, the ammeter will show a gradually increasing charge. If the voltage of the dynamo exceeds the voltage of the battery when the cutout closes, the charging current, as indicated on the ammeter will not gradually rise from zero to a maximum value with increase of engine speed, but the indication of the ammeter will suddenly jump from zero to a certain value when the cutout closes, depending upon how much the voltage of the dynamo exceeds the voltage of the battery and the resistance of the entire circuit. The indicator

then gradually increases from this value to a maximum value with increase in engine speed.

The operation of the electromagnetic cutout should be such that the dynamo and battery are connected together when the voltage of the dynamo is high enough to cause a charging current to pass through the battery when the voltage of the battery is at its maximum value or the battery is practically fully charged. The value of the charging current at the instant the circuit is closed will depend upon the difference between the voltage of the dynamo and the voltage of the battery. This difference will be greatest when the battery is practically or completely discharged and a minimum value when the battery is fully charged. The operation of the cutout may be determined as described on page 169.

The charging rate must be sufficiently high so that with all lamps turned on and the car running at a speed of about fifteen miles per hour, an ammeter connected at the battery will show some charge in spite of the current being drawn for lighting (lamp load). This does not mean, however, that the charge rate with the lamps turned off should always be equal to the lamp load, because of the variations in dynamo control.

The charge rate with the lamps turned off should never exceed in amperes one-sixth of the total ampere-hour capacity of the battery, and except at extreme high speeds should never exceed one-eighth of this capacity.

General Operating Conditions Which Govern the Action of a Battery.

The greatest drain on the storage battery is the operation of the starting motor. Under no conditions should the starting motor be used to propel the car, as there will undoubtedly be permanent damage done to the battery. Damage due to such treatment may not appear for some time, but it is sure to come if the practice be followed to any extent.

The starting motor should be used as economically as possible, and the engine started only when it is necessary to do so. Care should be exercised in the adjustment of the carburetor and

ignition system so that it will not be necessary to crank the engine for a considerable period before it will start. A great many drivers have a habit of holding their foot on the starting switch after the engine starts to fire, which results in an unnecessary discharge of the battery.

The adjustment of the output of some dynamos is such that the dynamo very seldom reaches its maximum output due to the fact that the driver may not ordinarily operate the car at a high enough speed, on account of traffic regulations or road conditions, to enable the dynamo to develop its maximum voltage. In such cases the output of the dynamo should be increased when such an adjustment is possible.

In some cases a car may be used almost entirely at night or at least a large part of the time that it is in use may be at night, and in such cases the drain on the battery may be excessive for the amount of charge put into it. The driver should use his starting motor as sparingly as possible, substitute lamps of lower candle power for the ones regularly supplied if such substitution gives ample light for driving purposes, and be careful in the use of the electric horn and other electrical accessories. In no case should the charging rate be increased to such an extent by adjusting the regulator that the dynamo or battery will be damaged.

The efficiency of a storage battery is considerably less in cold weather than it is in warm weather, and this, coupled with the fact that the number of hours of darkness during which the car is likely to be used is greater in cold weather than in warm, often results in the battery becoming discharged, or failing to carry the load imposed upon it during the winter, even though it operated very satisfactorily during the warm summer months. The engine is always harder to start in cold weather than it is in warm weather, due to the fact that the gasoline does not vaporize as readily and the oil in all the bearings and around the pistons is stiff, making the engines much harder to turn over. In such cases it is often necessary to increase the output of the dynamo during certain months of the year in order to make up for the loss in efficiency and increase in output the battery is called upon to supply.

The condition of operation during the warm summer months and long days may on the other hand result in serious damage to the battery on account of excessive charging in proportion to discharge. During the summer the engine turns over more easily, the battery is much more efficient, the gasoline vaporizes more easily, and the lamps are not used nearly as much as they are in the winter. This condition of over-charging can be relieved to a certain extent by means of a touring switch, by means of which the driver may disconnect the battery from the dynamo, or by turning on all of the lamps with the engine idle and allowing the battery to discharge for a few hours at certain intervals, depending upon the speed at which the car is driven when in use, that is, upon the amount of charge put into the battery.

CHAPTER 12.

HOW TO TAKE CARE OF THE BATTERY ON THE CAR.

The manufacturers of Starting and Lighting Equipment have designed their generators, cutouts, and current controlling devices so as to relieve the car owner of as much work as possible in taking care of batteries. The generators on most cars are automatically connected to the battery at the proper time, and also disconnected from it as the engine slows down. The amount of current which the dynamo delivers to the battery is automatically prevented from exceeding a certain maximum value. Under the average conditions of driving, a battery is kept in a good condition. It is impossible, however, to eliminate entirely the need of attention on the part of the car owner, and battery repairman.

The repairman, especially, should know what charging currents the various makes and types of generators with which the automobiles are equipped should produce. It is a good plan always to put an ammeter in series with the battery, run the engine with the lamps turned off, and measure the charging current which is being delivered to the battery. This should be done on every car that is brought in for repairs. The charging current actually received by the battery should be checked with the current the generator is intended to deliver, and for which the generator is adjusted before the car leaves the factory. If the generator is not delivering the proper current, find out why, and remedy the trouble. Otherwise the battery cannot be expected to do its work satisfactorily, and be fully charged.

The storage battery requires but little attention, and this is the very reason why many batteries are neglected. Motorists often have the impression that because their work in caring for a battery is quite simple, no harm will result if they give the battery no attention whatever. If the battery fails to turn over the engine when the starting switch is closed, then instruction

books are studied. Thereafter the motorists pay more attention to the battery. The rules to be observed in caring for a battery on a car are given in the remainder of this chapter. Some of them apply to car owners alone, while the others are intended for garagemen.

Preparing Battery for Use.

1. Unpacking. If the battery arrived packed, unpack it carefully, being careful to keep it right side up. Brush off all dirt, excelsior, etc.

2. Inspect for Leakage. Remove the vent plugs and see that the electrolyte covers the plates. Rough handling in shipping

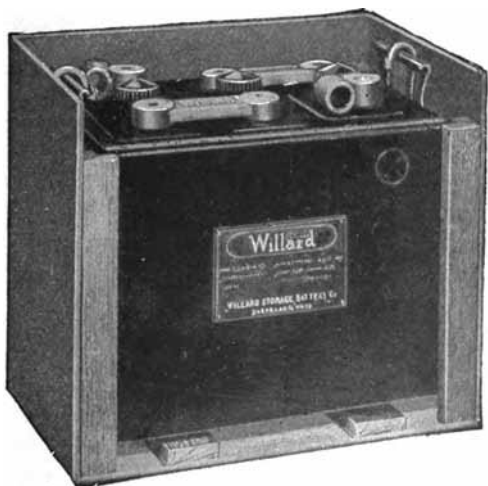

Fig. 17. The Battery Installed

may have cracked one of the jars. If the electrolyte does not cover the plates, or if there is electrolyte around the jars or at the joints in the box, one or more of the jars are probably broken. In this case, take the matter up with the transportation company, or party from whom the battery was received.

3. Installation of the Storage Battery. A special battery compartment is provided on the automobile in the majority of cases which provides both an electrical and mechanical protection. The

battery must be firmly fastened in a definite position in the battery box or compartment, so as to prevent any movement due to the vibration of the car. Special hooks are usually provided for holding the battery in place by fastening their upper ends in openings or handles on the wooden containing case, their lower ends passing through the bottom of the battery compartment. See Figure 17. A thumb-nut or other adjustment is provided on these hooks by means of which they may be drawn up. It is advisable to place the battery on several small wooden cleats laid on the bottom of



Fig. 18. Battery Short Circuited by a Pair of Pliers

the battery compartment unless such cleats are provided, and then place the battery in such a position in the compartment that there will be an air space on all sides as well as top and bottom. This arrangement gives the maximum mechanical and electrical protection as well as the best ventilation. It is not advisable to use any packing of any kind about the battery, but depend entirely upon the hooks to hold it firmly in place. Lack of care in properly securing the battery will undoubtedly result in broken battery jars, broken electrical connections or cracked sealing compound, any one of which may result in serious damage to the

battery and at the same time make the electrical system inoperative. Under no conditions use the battery compartment in storing tools, oil cans, pieces of wire, etc., as they are likely to jolt around and short circuit one or more of the cells.

The leads coming into the battery compartment should be long enough so that the terminals on their ends may be easily attached to the terminals of the battery and still have ample slack in the leads so as to prevent the terminals or connections being broken should the battery happen to move. Care should be exercised in making the electrical connections to the battery to see that the surfaces coming into contact are thoroughly cleaned and the area of the contact is as large as possible, which means a minimum resistance. Under no condition connect a copper wire directly to the terminal of a storage battery, as the acid fumes will attack the copper and start corrosion, which will eventually result in the end of the wire being eaten off entirely and at the same time a badly corroded battery terminal. If such connections are necessary in order to take care of additional circuits and equipment other than the regular equipment, connection may be made to the leads from the battery some distance from the battery or preferably at a terminal block when one is provided.

There is room for great improvement in the design of battery terminals and cable connections. The best method has the cables burned directly to the battery posts. This eliminates the possibility of corrosion at the connection between the cable and the post. The burned-on cables should be fastened to a terminal block placed on the side of the box. The cables and wires leading to the starting motor and other parts of the car should be fastened to these terminal blocks also. If all batteries were connected in this fashion, much of time spent in the cleaning of terminals, and charging made necessary by loose or corroded connections would be saved.

4. Connection of Battery. The cables attached to the battery lead to the starting motor, dynamo, lighting system, and very frequently the ignition system also. As far as the starting, lighting, and ignition systems are concerned, it makes no difference which cable is connected to the positive (marked "P," "Pos," or "+") battery terminal post and which cable is attached to the

negative (marked "N," "Neg.," or "-") battery terminal post. With some dynamos this is also true. With most dynamos, however, the cable which is attached to the positive battery terminal must lead to the positive dynamo terminal, and the cable which is attached to the negative battery terminal must lead to the negative dynamo terminal. On many cars, one battery terminal is connected to the iron car frame. In this case the corresponding terminal on the dynamo must also be connected to the iron car frame. The other battery terminal is connected to the remaining dynamo terminal. If it is not known which cable leads to the positive and which to the negative dynamo terminal, the following test may be made:

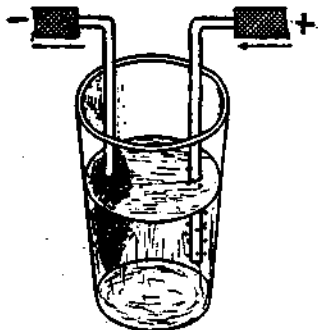

Fig. 19

Fill a tumbler with electrolyte or salt water. Fasten a wire to each cable, insert the wires in the tumbler, keeping them at least one inch apart. Now start the engine, and run it at a speed corresponding to a car speed of not less than 20 miles per hour. Fine bubbles of gas will collect at one of the wires, and the cable to which this wire is attached leads to the negative dynamo terminal, and should be connected to the negative battery terminal. See Figure 19.

5. Freshening Charge. Battery should be given a charge just before installing on car, or immediately after, at the charging rate stamped on the nameplate. Directions for charging will be given later.

6. Keep Battery and Interior of Battery Box Wiped Clean and Dry. For this purpose use a rag dipped in ammonia or baking soda. Do not bring an open flame near the battery vent holes. The reason for this is that bubbles of hydrogen and oxygen escape from the electrolyte, and the mixture is very explosive.

In case the electrolyte or water has been spilled on top of the battery, the surface should be rubbed off with a cloth that has been moistened with ammonia water and should then be wiped with a dry cloth.

The battery terminals and other connections must be clean and free from corrosion. Should crystals or cakes of blue-green copper sulphate be found the parts should be washed with a solution of baking soda in hot water and should then be covered with vaseline to prevent further action by the acid.

7. Inspect the Battery Twice a Month in Winter, and Once a Week in Summer, to Make Sure That the Electrolyte Covers the Plates. To do this, remove the filling plugs and look down through the opening, as shown in Figure 20. If a light is necessary for this purpose, use an electric lamp. **Never use an open flame, such as a match or candle.** An

explosion may result from the gases of the battery. During the normal course of operation of the battery, water from the electrolyte will evaporate. The acid never evaporates. The surface of the electrolyte should be not less than one half inch above the tops of the plates. A convenient method of measuring the height of the electrolyte is shown in Figure 21. Insert one end of a short piece of a glass tube, having an opening not less than one-eighth inch diameter, through the filling hole, and allow it to rest on the upper edge of the



Fig. 20. Examining the Inside of Battery Through the Vent Hole in Top to See the Height of Solution

plates. Then place your finger over the upper end, and withdraw the tube. A column of liquid will remain in the lower end of the tube as shown in the figure, and the height of this column is the same as the height of the electrolyte above the top of the plates in the cell. If this is less than one-half inch, add enough distilled water to bring the electrolyte up to the proper level. Never use well water, spring water, water from a stream, or ordinary faucet water. These contain impurities which will damage the battery if

used. If no distilled water is available, clean rain water, if collected in the country, or melted artificial ice may be used. Rain water in the city is seldom pure enough. City atmospheres usually contain ammonia, and other gases which the rain absorbs in falling, making it unfit for use. In winter time, if the air temperature is below freezing (32°F), start the engine before adding water, and keep it running for about one hour after the battery begins to "gas." A good time to add the water is just before starting on a trip, as the engine will then usually be run long enough to charge the battery, and cause the water to mix thoroughly with the electrolyte. Otherwise, the water, being lighter than the electro-

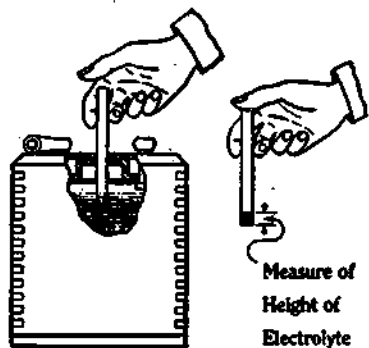

Fig. 21

charge the battery, and cause the water to mix thoroughly with the electrolyte. Otherwise, the water, being lighter than the electro-

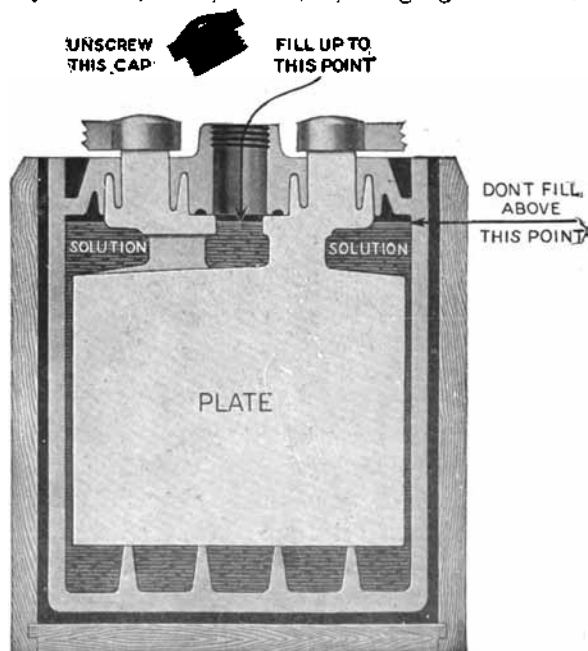

Fig. 22. Cross Section of Battery, Showing Correct Level of Water.

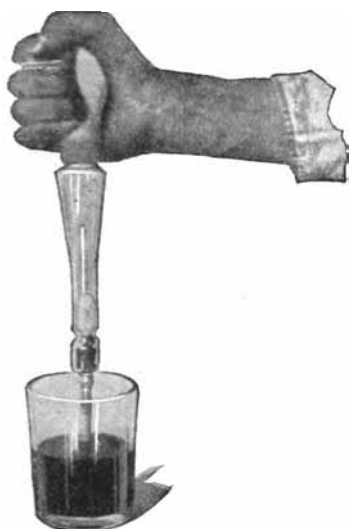

Fig. 23. Pour Some of the Distilled Water into a Glass. Squeeze the Air Out of the Bulb of the Hydrometer. Put Rubber Tip in the Glass



Fig. 24. Release the Pressure on the Bulb, Thus Drawing Water Up into the Hydrometer



Fig. 25. Insert the Tube in Vent Hole in Center of Battery, and Squeeze the Hydrometer Bulb Until the Cell is Filled to the Proper Level



Fig. 26. Release the Pressure on the Bulb and Hold Syringe in a Horizontal Position to Prevent Water from Dripping on Battery. Return Excess Water to Glass

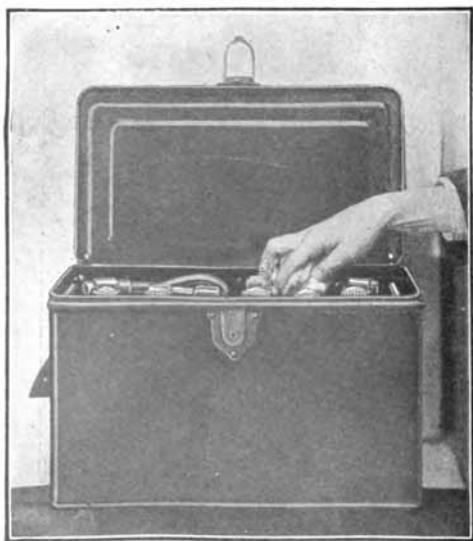

Fig. 27. Replace the Screw Plugs and Wipe Dirt and Moisture from Top of Battery

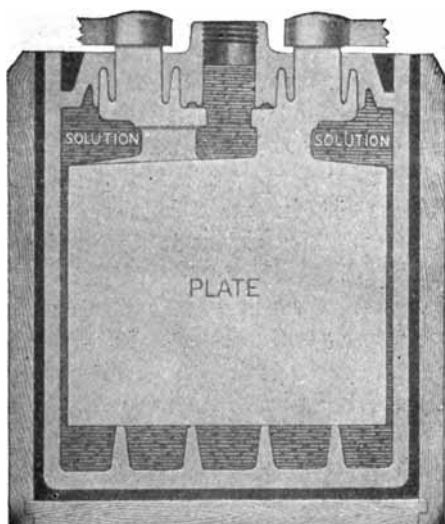

Fig. 28. Showing Battery with Electrolyte too High

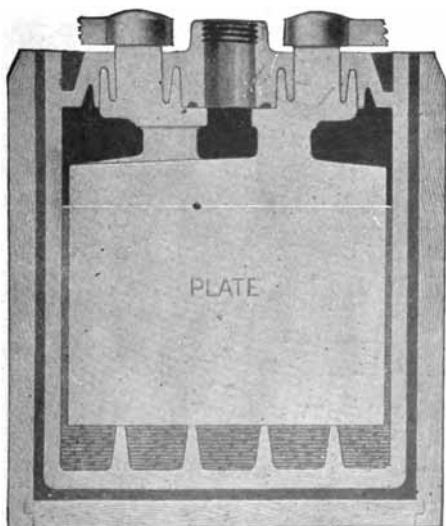

Fig. 29. Showing Battery with Electrolyte too Low

lyte, will remain at the top and freeze. Be sure to wipe all water from the battery top after filling. It is essential that distilled water be used for this purpose, and it must be handled carefully so as to keep impurities of any kind out of the water. Never use a metal can for handling water or electrolyte for a battery, but always use a glass or porcelain vessel. The water should be stored in glass bottles, and poured into a porcelain or glass pitcher when it is to be used. A convenient method of adding the water to the battery is to draw some up in a hydrometer syringe and add the necessary amount to the cell by inserting the rubber tube which is at the lower end into the vent hole and then squeezing the bulb until the required amount has been put into the cell. This is shown pictorially in Figures 22 to 29 inclusive.

The acid in the electrolyte does not evaporate, and it is very seldom necessary to add acid. Acid is lost when a cell gasses; electrolyte may be spilled; a cracked jar will allow electrolyte to leak out; if too much water is added, the expansion of the electrolyte when the battery is charging may cause it to run over and be lost, or the jolting of the car may cause some of it to be spilled; if a battery is allowed to become badly sulphated, some of the sulphate is never reduced, or drops to the bottom of the cell, and the acid lost in the formation of the sulphate is not regained. Thus it is seldom necessary to add acid. If acid or electrolyte is added instead of water, when no acid is needed, the electrolyte will become too strong, and sulphate plates will be the result. If a battery under average driving conditions never becomes fully charged, it should be removed from the car and charged from an outside source as explained

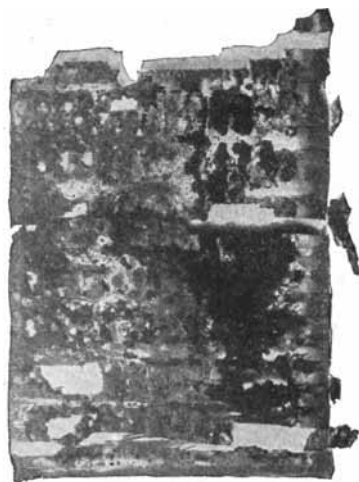

Fig. 30. This Shows How Plates and Separators Are Destroyed by Using Acid Solution Instead of Water for Filling

later. If, after a long continued charge, the battery is still not fully charged, some of the electrolyte should be removed, fresh electrolyte having a specific gravity of 1.400 should be added instead of water. This should preferably be done by an experienced battery man.

Care must be used not to fill the battery cells too far above the plates. By looking down through the opening left when the filler plug is removed a second opening may usually be seen, between a half inch and one inch below the top. The level of the liquid should be at this lower hole but should not be brought above it. See Figure 28.

If the battery is filled above this point, the electrolyte will run over the top of the tube, cause a short circuit between the battery terminals, and run down the sides of the box. It may get into the metal battery box and eat out the bottom, as well as rot the wooden battery case.

8. The specific gravity of the electrolyte should be measured every two weeks and a permanent record of the readings made for future reference.

As already explained, the specific gravity of the electrolyte is the ratio of its weight to the weight of an equal volume of water. Acid is heavier than water, and hence the heavier the electrolyte, the more acid it contains, and the more nearly it is fully charged. In automobile batteries, a specific gravity of 1.300-1.250 indicates a fully charged battery. Other readings are as follows:

- 1.300-1.250—Fully charged.
- 1.250-1.200—More than half charged.
- 1.200-1.150—Less than half charged.
- 1.150 and less—Completely discharged.



Fig. 31

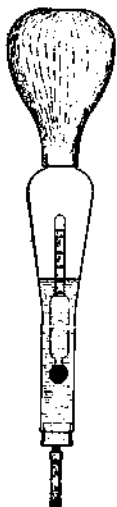

Fig. 32

For determining the specific gravity, a hydrometer is used. This consists of a small sealed glass tube with an air bulb and a quantity of shot at one end, and a graduated scale on the upper end. This scale is marked from 1.100 to 1.300, with various intermediate

markings as shown in Figure 31. If this hydrometer is placed in a liquid, it will sink to a certain depth. In so doing, it will displace a certain volume of the electrolyte, and when it comes to rest, the volume displaced will just be equal to the weight of the hydrometer. It will therefore sink farther in a light liquid than in a heavy one, since it will require a greater volume of the light liquid to equal the weight of the hydrometer. The top mark on the hydrometer scale is therefore 1.100 and the bottom one 1.300.

For convenience in automobile work, the hydrometer is enclosed in a large glass tube having a short length of rubber tubing at its lower end, and a large rubber bulb at the upper end. The combination is called a hydrometer-syringe, or simply hydrometer. See Figure 32. In

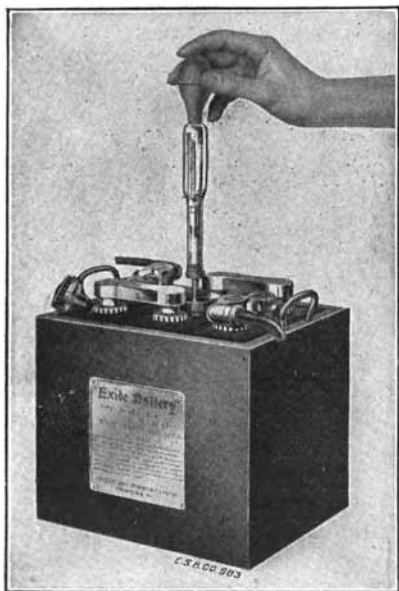

Fig. 33. Taking a Specific Gravity Reading

measuring the specific gravity of the electrolyte, the filler plug is removed, the bulb is squeezed so as to expel the air from it, and the rubber tubing inserted in the hole from which the plug was removed. The pressure on the bulb is now released, and electrolyte is drawn up into the glass tube. The rubber tubing on the hydrometer should not be withdrawn from the cell. When a sufficient amount has entered the tube, the hydrometer will float. In taking a reading, there must be no pressure on the bulb, and the hydrometer should be floating freely and not touching the walls of the tube. The tube

must be held in a vertical position, and the stem of the hydrometer must also be vertical. The reading will be the number on the stem at the surface of the electrolyte in the tube. Thus if the hydrometer sinks in the electrolyte, until the electrolyte comes up to the 1.150 mark on the stem, the specific gravity is 1.150.

Having taken a reading, the bulb is squeezed so as to return the electrolyte to the cell.

Care should be taken not to spill the electrolyte from the hydrometer syringe when testing the gravity. Such moisture on top of the cells tends to cause a short circuit between the terminals and to discharge the battery.

In making tests with the hydrometer the electrolyte should always be returned to the same cell from which it was drawn. Failure to do this will finally result in an increased proportion of acid in one cell and a deficiency of acid in others.

The specific gravity of all cells of a battery should rise and fall together, as the cells are usually connected in series so that the same current passes through each cell both on charge and discharge. Some batteries are divided into two or more sections which are connected in parallel while the engine is running, and in such cases the cables leading to the different sections should all be of exactly the same length, and the contacts in the switch which connect these sections in parallel should all be clean and tight. If cables of unequal length are used, or if some of the switch contacts are loose and dirty, the sections will not receive equal charging currents, because the resistances of the charging circuits will not be equal. The section having the greatest resistance in its circuit will receive the least amount of charge, and will show lower specific gravity readings than for other sections. In a multiple section battery, there is therefore a tendency for the various sections to receive unequal charges, and for one or more sections to run down continually. An ammeter should be attached with the engine running and the battery charging, first to one section and then to each of the others in turn. The ammeter should be inserted and removed from the circuit while the engine remains running and all conditions must be exactly the same, otherwise the comparative results will not give reliable indications. It would be better still to use two ammeters at the same time, one on each section of the battery. In case the amperage of charge should differ by more than 10% between any two sections, the section receiving the low charge rate should be examined for proper height of electrolyte, for the condition of its

terminals and its connections at the starting switch as described. Should a section have suffered considerably from such lack of charge its voltage will probably have been lowered. With all connections made tight and clean and with the liquid at the proper height in each cell this section may automatically receive a higher charge until it is brought back to normal. This high charge results from the comparatively low voltage of the section affected.

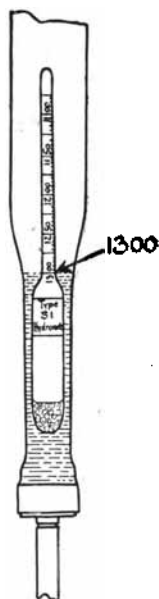

Fig. 34
Hydrometer Reading, 1.300

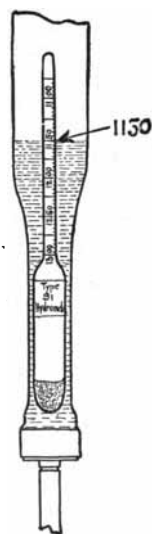

Fig. 35
Hydrometer Reading, 1.150

In case the car is equipped with such a battery, each section must carry its proper fraction of the load and with lamps turned on or other electrical devices in operation the flow from the several sections must be the same for each one. An examination should be made to see that no additional lamps, such as trouble finders or body lamps, have been attached on one side of the battery, also that the horn and other accessories are so connected that they draw from all sections at once.

Some starting systems now being used have not been designed carefully in this respect, one section of the battery having longer cables attached to it than the others. In such systems it is impossible for these sections to receive as much charging current as others, even though all connections and switches are in good condition. In other systems, all the cells of the battery are in series, and therefore must receive the same charging current, but have lighting wires attached to it at intermediate points, thus dividing the battery into sections for the lighting circuits. If the currents taken by these circuits are not equal, the battery section supplying the heavier current will run down faster than others. Fortunately, multiple section batteries are not being used to any great extent at present, and troubles due to this cause are disappearing.

If one cell of a battery shows a specific gravity which is decidedly lower than that of the other cells in series with it, and if this difference gradually increases, the cell showing the lower gravity has internal trouble. This probably consists of a short circuit. If the electrolyte in this cell falls faster than that of the other cells, a leaky jar is indicated. The various cells should have specific gravities within twenty-five points of each other, such as 1.250 and 1.275.

If the entire battery shows a specific gravity below 1.200, it is not receiving enough charge to replace the energy used in starting the engine and supplying current to the lights, or else there is trouble in the battery. The troubles which cause low gravity are given on pages 172 to 174. It is often difficult to determine what charging current should be delivered by the generator. Some generators operate at a constant voltage slightly higher than that of the fully charged battery, and the charging current will change, being higher for a discharged battery than for one that is almost or fully charged. Other generators deliver a constant current which is the same regardless of the battery's condition. To give data on this subject is beyond the scope of this book. Complete information is given in the *Ambu Charts* published by the American Bureau of Engineering, Inc.

In the constant voltage type of generator, the charging current automatically adjusts itself to the condition of the battery. In the constant current type, the exact value of current for which

the generator is designed and adjusted is determined by the manufacturer, and is intended to keep a battery charged under the average driving conditions. Individual cases often require that another current value be used. In this case, the output of the generator must be changed. With most generators, a current regulating device is used which may be adjusted so as to give a fairly wide range of current, the exact value chosen being the result of a study of driving conditions and of several trials. The charging current should never be made so large that the temperature of the electrolyte in the battery is above 90° Fahrenheit. A dairy thermometer is very useful in determining the temperature. See Figure 36. The thermometer bulb is immersed in the electrolyte above the plates through the filler hole in the tops of the cells. Complete information on generators is given in the Ambu Charts referred to above.

Specific gravity readings should never be taken soon after distilled water has been added to the battery. The water and electrolyte do not mix immediately, and such readings will give misleading results. The battery should be charged several hours before the readings are taken. It is also a good plan to take a specific gravity reading before adding any water, since accurate results can also be obtained in this way.

If the gravity, before filling, was below 1.150, the battery should be removed from the car and fully charged from an outside source. If the gravity was 1.150 or above the engine should be run at a speed that corresponds to 15 to 20 miles per hour, without any lamps turned on, for a total of at least twelve hours. This treatment should be continued until the specific gravity of the battery does not show any further rise for two hours. If the gravity was 1.100 or below the charging must be continued for a total of sixty hours or more. If the battery is recharged on the car, it will be best to substitute lamp bulbs of lower candle power than those regularly used until the gravity comes up to 1.275.

A completely discharged battery will ordinarily take about twenty hours' charging to bring it up, but if the battery has stood for a considerable length of time in a discharged condition or has been reversed it may take several days to bring the gravity up to normal.

The temperature of the electrolyte affects the specific gravity, since heat causes the electrolyte to expand. If we take any battery or cell and heat it, the electrolyte will expand and its specific gravity will decrease, although its actual strength will be the same, because the actual amount of acid is the same. The change in specific gravity amounts to one point, approximately, for each degree Fahrenheit change. If the electrolyte has a gravity of 1.250 at 70°F, and the temperature is raised to 73°F, the specific gravity of the battery will be 1.249. If the temperature is decreased to 67°F, the specific gravity will be 1.251. Since the change of temperature does not change the actual strength of the electrolyte, the gravity readings as obtained with the hydrometer syringe should be corrected one point for every three degrees change in temperature. Thus 70°F is considered the normal temperature, and one point is added to the electrolyte reading for every three degrees above 70°F. Similarly, one point is subtracted for every three degrees below 70°F. For convenience of the hydrometer user, a special thermometer has been developed by battery makers. This is shown in Figure 36. It has a special scale mounted beside the regular scale. This scale shows the corrections which must be made when the temperature is not 70°F. Opposite the 70 point on the thermometer is a "0" point on the special scale. This indicates that no correction is to be made. Opposite the 67° point on the regular scale is a -1, indicating that 1 must be subtracted from the hydrometer reading to find what the specific gravity would be if the temperature were 70°F. Opposite the 73° point on the regular scale is a +1, indicating that 1 point must be added to reading on the hydrometer, in order to reduce the reading of specific gravity to a temperature of 70°F.

9. Operating Temperatures. Storage batteries are strongly affected by changes in temperature. Both extremely high, and very low temperatures are to be avoided. At low temperatures the electrolyte grows denser, the porosity of plates



Fig. 36
Special
Thermometer

and separators decreases, circulation and diffusion of electrolytes are made difficult, chemical actions between plates and acid take place very slowly, and the whole battery becomes sluggish, and acts as if it were numbed with cold. The voltage and capacity of the battery are lowered.

As the battery temperature increases, the density of the electrolyte decreases, the plates and separators become more porous, the internal resistance decreases, circulation and diffusion of electrolyte take place much more quickly, the chemical actions between plates and electrolyte proceed more rapidly, and the battery voltage and capacity increase. A battery therefore works better at high temperatures.

Excessive temperatures, say over 100°F, are, however, more harmful than low temperatures. Evaporation of the electrolyte takes place very rapidly, the separators are attacked by the hot acid and are ruined, the active materials and plates expand to such an extent that the active materials break away from the grids and the grids warp and buckle. The active materials themselves are burned and made practically useless. The hot acid also attacks the grids and the sponge lead and forms dense layers of sulphate. Such temperatures are therefore extremely dangerous.

A battery that persistently runs hot, requiring frequent addition of water is either receiving too much charging current, or has internal trouble. The remedy for excessive charge is to decrease the output of the generator, or to burn the lamps during the day time. Motorists who make long touring trips in which considerable day driving is done, with little use of the starter, experience the most trouble from high temperature. The remedy is either to install a switch with which the generator may be disconnected from the battery, or to use the lamps as mentioned above.

Internal short-circuits cause excessive temperature rise, both on charge and discharge. Such short circuits usually result from buckled plates which break through the separators, or from an excessive amount of sediment. This sediment consists of active material or lead sulphate which has dropped from the positive plate and fallen to the bottom of the battery jar. All battery jars are provided with ridges which keep the plates raised an inch

or more from the bottom of the jar, and which form pockets into which the materials drop. See Figure 22. If these pockets become filled, and the sediment reaches the bottom of the plates, internal short circuits result which cause the battery to run down and cause excessive temperatures.

If the electrolyte is allowed to fall below the tops of the plates, the parts of the plates above the acid become dry, and when the battery is charged grow hot. The parts still covered by the acid also become hot because all the charging current is carried by these parts, and the plate surface is less than before. The electrolyte will also become hot and boil away. A battery which is thus "charged while dry" deteriorates rapidly, its life being very short.

Sulphated plates will also grow hot, even with a normal charging current, because only those parts of the active material which are not covered by lead sulphate carry the current, and therefore heat up. This results in buckling and fracture of plates.

If a battery is placed in a hot place on the car, this heat in addition to that caused by charging will soften the plates and jars, and shorten their life considerably.

In the winter, it is especially important not to allow the battery to become discharged, as there is danger of the electrolyte freezing. A fully charged battery will not freeze except at an extremely low temperature. The water expands as it freezes, loosening the active materials, and cracking the grids. As soon as a charging current thaws the battery, active material is loosened, and drops to the bottom of the jars, with the result that the whole battery may disintegrate. Jars may also be cracked by the expansion of the water when a battery freezes.

To avoid freezing, a battery should therefore be kept charged. The temperatures at which electrolyte of various specific gravities freezes are as follows:

| Specific Gravity | Freezing Pt. | Specific Gravity | Freezing Pt. |
|------------------|--------------|------------------|--------------|
| 1.020 | 30°F. | 1.170 | 0°F. |
| 1.060 | 26°F. | 1.220 | -28°F. |
| 1.100 | 21°F. | 1.260 | -65°F. |
| 1.140 | 12°F. | 1.290 | -98°F. |

No anti-freeze solution of any kind is required for use in the battery. The addition of alcohol or anything else except pure water to the cells will result in internal damage.

10. Care of Storage Battery When Not in Service. A storage battery may be out of service for a considerable period at certain times of the year, for example, when the automobile is put away during the winter months, and during this time it should not be allowed to stand without attention. When the battery is to be out of service for only three or four weeks, it should be kept well filled with distilled water and given as complete a charge as possible the last few days the car is in service by using the lamps and starting motor very sparingly. The specific gravity of the electrolyte should be tested in each cell, and it should be somewhere between 1.270 and 1.300. All connections to the battery should be removed as any slight discharge current will in time completely discharge it, and the possibilities of such an occurrence are to be avoided. If the battery is to be put out of service for several months, it should be given a complete charge by operating the dynamo on the car or by connecting it to an outside charging circuit. During the out-of-service period, water should be added to the cells every six or eight weeks and the battery given what is called a refreshing charge; that is, the engine should be run until the cells have been gassing for perhaps one hour, and the battery may then be allowed to stand for another similar period without further attention. Water should be added and the battery fully charged before it is put back into service. It may be necessary to charge the battery for 40 or 50 hours at one-half the normal rate before it will be fully charged if it has stood for five or six months without being charged. It is desirable to have the temperature of the room where the battery is stored fairly constant and as near 70 degrees Fahrenheit as possible.

CHAPTER 13.

MANUFACTURE OF STORAGE BATTERIES.

To supply the great number of batteries needed for gasoline automobiles, many large companies have been formed and huge factories erected. Each company has its special and secret processes which it will not reveal to the public. Only a few companies supply batteries in any considerable quantities, the great majority of cars being supplied with batteries made by not more than five or six manufacturers. This greatly reduces the number of possible different designs in general use today.

The design and dimensions of batteries vary considerably, but the general constructions are similar. The special processes of the manufacturers are of no special interest to the motoring public, and only a general description will be given here.

A starting and lighting battery consists of the following principal parts:

1. Plates.
2. Separators.
3. Electrolyte.
4. Jars.
5. Top connectors and covers.
6. Case.

Plates. Of the two general types of battery plates, Faure and Plante, the Faure or pasted plate type is used on the great majority of automobiles. In the manufacture of the Faure or pasted plates there are several steps which we shall describe in the order they are carried out.

Moulding the Grid. The grid is a casting made of lead and antimony, about 6 to 10% of antimony being used. This gives a grid which is harder and stronger than pure lead, less liable to deformation, and one which is not affected by the battery acid to any appreciable extent. On the other hand, the grid is more brittle, and more liable to be fractured or broken if the active materials should expand abnormally.

The lead and antimony are melted together, thoroughly mixed,

and then poured into the molds. The Willard Co. makes two plates in one casting. The mold resembles a waffle-iron, the plates being molded bottom to bottom. The casting therefore has a lug at each end, and is thus easily handled, the lugs being used to hold the casting in racks during the various processes through which it passes. The casting is not split into two plates until the paste has been

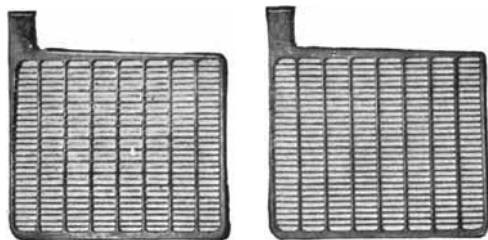
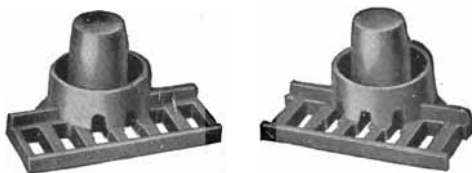

Fig. 37. A Pair of Grids Trimmed and Ready to be Pasted. The Lugs at the Top Are for Burning in to the Connector Straps to Make a Group

applied, and the plates formed and dried. The two parts of the casting are, of course, made into plates of the same polarity. After cooling, the grids are removed from the molds, and cleaned. The rough edges are trimmed off, and the parts polished. The grid is now ready for pasting.

Figure 37 shows a Willard grid ready for pasting. It will be noticed that a heavy lug is at the upper left hand corner. This



Pos. Connecting Strap Neg. Connecting Strap

Fig. 38

is later burned into a cross bar, together with other plates, and from this cross bar extends the outer battery terminal to which a battery cable or connecting link is attached. (See figure 38.) Seven vertical stiffening ribs, together with the four heavy ribs at the tops and side, serve to make the plate strong and rigid. It will be noticed that the top and left hand side piece taper away

from the lug. This gives strength and also provides a greater current carrying area near the lug. The amount of current carried by these ribs is greatest near the lug, and grows less toward the right hand end and bottom of the grid.

In the Willard Battery the ribs all run at right angles to one another. This is true of most of the different makes. In the Philadelphia Diamond grid, these ribs are arranged at smaller angles to each other, so as to form diamond shaped openings. The purpose of the ribs in any grid is to form a rigid supporting frame for the paste, and to distribute the current uniformly to all parts of the paste. The pastes used are weak mechanically, and could not be made into plates without the supporting grids, especially in automobile service, where batteries are often subjected to severe jolting.

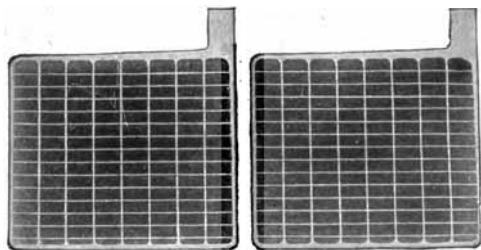

Fig. 39. A Pair of Formed Plates Ready to be Burned to the Connecting Straps

Pastes. There are many formulas for the active materials. For the positive plates, litharge (PbO), or red lead, (Pb_3O_4), or a combination of the two is mixed with dilute sulphuric acid. A paste is made which is just thick enough to make it easy to work it into the spaces between the ribs of the grid. For the negative plates litharge (PbO) is generally made into a paste with dilute sulphuric acid.

Various methods and machines are used for making the pastes. Some manufacturers use mixers which resemble the ordinary cement mixer and which are power driven. The lead compounds and acid are dumped into the mixers and the latter are then set in motion. Hand rotated drums are also used.

Applying the pastes. This may be done with the bare hands, or with wooden paddles, or with machines, as in the USL Machine

Pasted Plate. In hand pasting the pastes are worked first into one side of the grid, and then into the other. In machine pasted plates, both sides are filled with the pastes simultaneously. Figure 40 shows a pasting room in a Willard factory. The pastes begin to harden from the time they are mixed, and the pasting is done quickly so as to apply the pastes before they are too stiff to be worked into spaces of the grids.

The freshly pasted plates are now allowed to dry in the air, are put into drying ovens and dried by a hot air blast, or are

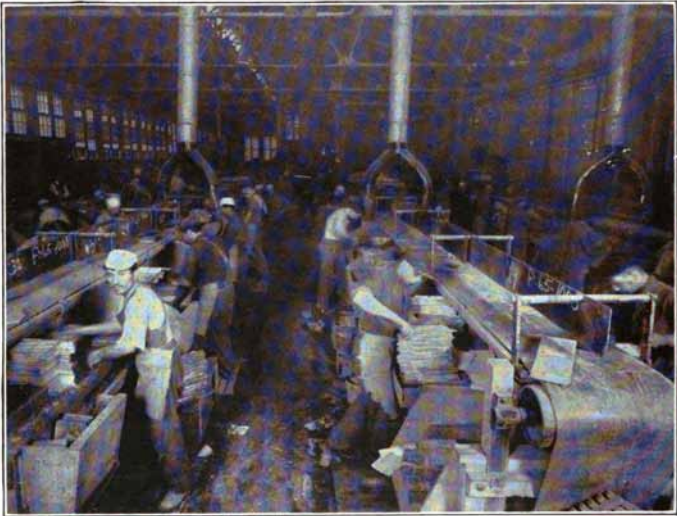

Fig. 40. Pasting Room in the Willard Storage Battery Co. Factory

immersed in dilute sulphuric acid for several days. In either case, the pastes set to a hard mass, this being due to the formation of lead sulphate, which hardens, and cements the particles of the paste. This sulphate becomes crystallized into a firm binding mass without which the pastes would soon fall from the grids. The plates become so hard that they may be pounded on the floor without losing any paste. Both positive and negative plates are allowed to sulphate in this way.

Forming. After the sulphation, or cementing process is completed, the plates are brushed clean, and sent to the forming

room. This is usually a large room containing a number of acid filled tanks, into which the plates are placed. Figure 41 shows a forming room in the Willard factory. Negative and positive plates are arranged very much as they appear in the finished battery. All positives are connected together, as are also the negatives. Current is then passed through the plates for from three to six days so as to change the pastes into sponge lead and lead peroxide; the process being called "forming" the plates. The forming current used varies with the size, design, and make,



Fig. 41. Forming Room in the Willard Storage Battery Co. Factory

the Willard Co. using a current of one-half ampere per plate. The pastes as applied to the grids could not enter into chemical actions with the electrolyte so as to provide electricity for operating a starting motor, or lamps. They must be changed considerably before becoming "active" material. The changes they undergo must be produced mainly by an electric current.

At the beginning of the "forming" process, the positive plate contains about 55% of litharge (PbO), 25% of lead peroxide, (PbO_2) and 20% of lead sulphate (PbSO_4). The lead oxide begins to change to lead peroxide as soon as the forming current is started. The amount of lead sulphate begins to increase, and

continues to do so for several hours. This is probably caused by the plate becoming more porous, so that the acid is able to reach more oxide, which it changes to sulphate. The sulphate soon changes to lead peroxide, however, and when the forming is completed, the positive plates contain nine per cent of litharge (PbO), 88% of lead peroxide (PbO_2), and 3% of lead sulphate ($PbSO_4$). This 3% of lead sulphate probably is never changed into lead peroxide if a battery is used normally, but it remains and acts as a cement to bind the particles of lead peroxide together.

The negative plate cements until it contains 30% of lead sulphate. As soon as the forming current is passed through the negatives, lead begins to form immediately, but the amount of sulphate also increases. The amount of sulphate reaches a maximum and turns into spongy lead quite rapidly. The fully formed plate contains but a very small amount of lead sulphate, being composed of 98% of metallic lead and 2% of litharge. Very little lead sulphate is left, but the spongy lead is itself a tough, coherent substance, which sticks together all over the plate surface. When the forming current is turned off, the positive grids have a chocolate brown color, and negative plates have a slate gray color.

Manufacturers have more complicated methods and formulas in mixing pastes for the plates. Some add organic acids, salts or sugar. These are mixed with the pastes, and are used either to increase the hardness of the paste, or to increase its porosity. Magnesium sulphate is also used for this purpose. These "forming" agents generally disappear after the battery has been used for some time.

The sulphate which remains in the positive plate at the surface is soon changed to lead peroxide when the battery has been charged several times. The lead peroxide then drops to the bottom of the jars, and the plates are said to be "shedding."

In mixing the paste for the negative plates, magnesium sulphate, or graphite are added to make the plate more porous. The value of these porosity agents is questionable, and they may, in fact, have a harmful effect upon the plate.

As the forming progresses, the plates are tested from time

to time with a voltmeter, and the cadmium test is also made. (See Page 266.) In this way, the conditions of positive and negative plates are determined separately.

When the forming process is complete, the positive plates are rinsed in warm water and allowed to dry in the air. The negative plates are also dried in the air. This results in the spongy lead on the negative plates changing back to litharge (PbO). The plates are now ready to be assembled into cells.

Separators.

In batteries used both for starting and for lighting, separators made of specially treated wood are largely used. Lately, however, the Willard Company has adopted an insulator made of

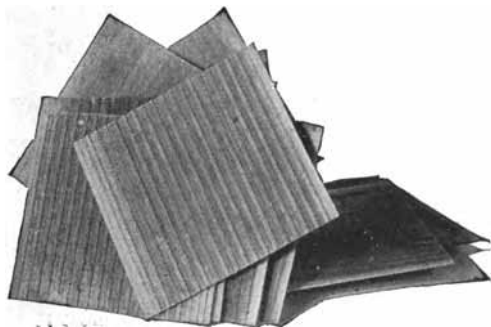

Fig. 42. A Pile of Prepared Wooden Separators Ready to be Put Between the Positive and Negative Plates to Form the Complete Element

a rubber fabric pierced by thousands of cotton threads, each thread being as long as the separator is thick. The electrolyte is carried through these threads from one side of the separator to the other by capillary action, the great number of these threads insuring the rapid diffusion of electrolyte which is necessary in batteries which are subjected to the heavy discharge current required in starting.

In batteries used for lighting or ignition, sheets of rubber in which numerous holes have been drilled are also used, these holes permitting diffusion to take place rapidly enough to perform the required service satisfactorily, since the currents involved are much smaller than in starting motor service.

For the wooden separators, porous wood, such as basswood,

cypress, or cedar are used. Redwood has been used to some extent. The wood is cut into strips of the correct thickness. These strips are passed through a grooving machine which cuts the grooves in one side, leaving the other side smooth. The strips are next sawed to the correct size, and are then put in a warm alkaline solution to neutralize any organic acid, such as acetic acid, which the wood naturally contains. Such acids would cause unsatisfactory battery action and damage to the battery. The alkali is finally washed out, and the separators given a final trimming. They are now ready for assembling.

Electrolyte.

Little need be said here about the electrolyte, since a full description is given elsewhere. Acid is received by the battery manufacturer in concentrated form. Its specific gravity is then 1.835. The acid commonly used is made by the "contact" process, in which sulphur dioxide is oxidized to sulphur trioxide, and then, with the addition of water, changed to sulphuric acid. The concentrated acid is diluted with distilled water to a specific gravity of 1.300.

Jars.

The jars are made of vulcanized rubber. The complete jars are inspected carefully for flaws which might result in a leaky, short lived battery. Across the bottom of the jar are several stiff ribs which extend up into the jar so as to provide a substantial support for the plates, and at the same time forming several pockets below the plates in which the sediment resulting from shedding of active material from the positive plates accumulates.

Top Connectors and Covers.

The connectors with which the cells are connected to each other are castings of lead, which, in batteries used for starting motors are made extra heavy so as to carry the heavy starting current without overheating. The covers are made of vulcan-



FIG. 43

ized rubber, and various manufacturers have developed special designs, their aims being to so construct the covers as to facilitate the escape of gases which result from charging, to provide space for the expansion of the electrolyte, to simplify filling with distilled water, to make leak-proof joints at the terminals and jars, and to simplify the work of making repairs.

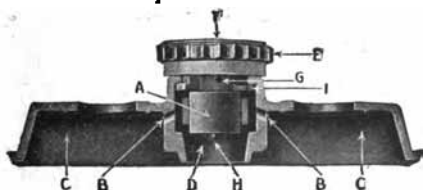

Fig. 44. Between Cell Link

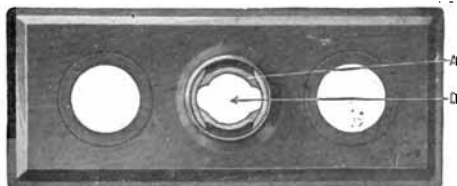
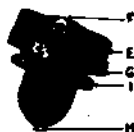

Fig. 45. Term. Link in Perspective

Several designs are shown below. Figure 22, page 74, shows a Willard construction. The rubber cover is shown in gray at the top of the cell. It is made in one piece, and contains the expansion chamber. The method of obtaining a leak-proof joint at the terminals is clearly shown. The sealing compound with which the joint between the cover and jar is made is shown in black at the top.



Sectional View of Cover, Plug in Place. Air Lock (A) in Position to Allow Free Escape of Gas Through Passages (BB)



Top View of Cover and Filling Plug, Plug Removed



Sectional View of Cover, Plug Removed. Air Passages (BB) Closed and Air Lock (A) in Position to Prevent Overfilling

Fig. 46

Figure 46 shows the Non-Flooding Vent and Filling Plug used in the "Exide" Battery. This is described by the Electric Storage Battery Company as follows, in one of its bulletins:

From the illustrations of the vent and filling plug, it will be seen that they provide both a vented stopper (vents F, G, H) and an automatic device for the preventing of overfilling and flooding. In a simple and effective manner, the amount of water that can be put into the cells is limited to the exact amount needed to replace that lost by evaporation. This is accomplished by means of the hard rubber valve (A) within the battery cover and with which the top of the filling plug (E) engages, as shown in the illustrations. The action of removing the plug (E) turns this valve (A), closing the air passage (BB), and forming an air tight chamber (C) in the top of the cell. When water is poured in, it cannot rise in this air space (C) so as to completely fill the cell. As soon as the proper level is reached, the water rises in the filling tube (D) and gives a positive indication that sufficient water has been added. Should, however, the filling be continued, the excess will be pure water only, not acid. On replacing the plug (E), valve (A) is automatically turned, opening the air passages (BB), leaving the air chamber (C) available for the expansion of the solution, which occurs when the battery is working.

Sectional Views of Cover

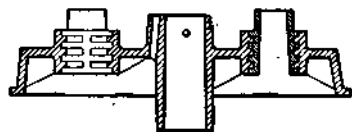

with Bushings

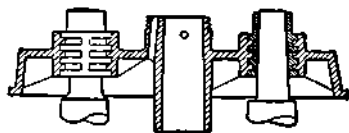

with Bushings and Post Straps

Fig. 47

Fig. 47 shows the top construction, and Figure 48 the method of filling USL batteries. The top is in one piece, and dome shaped so as to give strength, and to provide for an expansion chamber large enough to allow for the greatest expansion of electrolyte which is likely to occur, even in the severest charge. The holes through which the terminals posts pass each have a lead-antimony bushing which is flanged and molded in with the rubber so as to form a leak-proof joint. In assembling the battery,

the cover is placed over the posts, and both the post and flange lead-burned to the connecting links. Figures 47 and 48 show clearly the large expansion chamber and the method of filling with distilled water. This is done as follows:

A finger is placed over the vent tube shown in Figure 48. The water is then poured in through the filling tube. When the water reaches the bottom of the tube, the air imprisoned in the expansion chamber can no longer escape. Consequently the water can rise no higher in this chamber, but simply fills up the tube. Water is added till it reaches the top of the tube. The finger is then removed from the vent tube. This allows the air to escape from the expansion chamber. The water will therefore fall in the filling tube, and rise slightly in the expansion chamber. This construction makes it impossible to overfill the battery, provided that the finger is held on the vent tube as directed.

Cases.

The wooden case in which the battery cells are placed is usually made of the best grade of white oak, which is kiln dried before being used to make it as nearly acid proof as possible. The wood is inspected carefully, and all pieces are re-

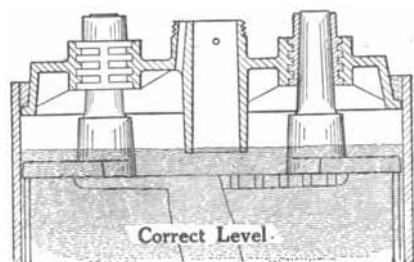
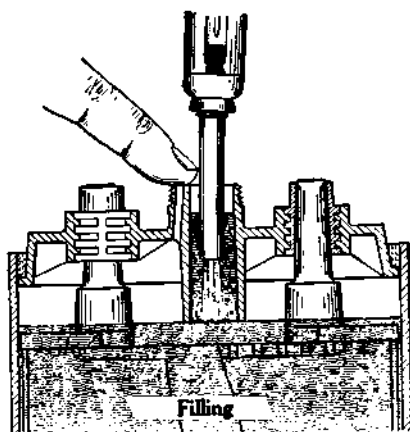
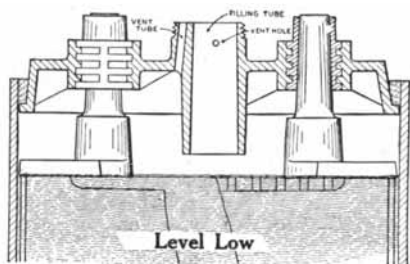

Fig. 48

jected that are weather-checked, or contain worm-holes or knots. The wood is sawed into various thicknesses, and then cut to the proper lengths and widths. The wood is passed through other machines that cut in the dovetails, put the tongue on the bottom for the joints, stamp on the part number, drill the holes for the screws or bolts holding the handles, cut the grooves for the sealing compound, etc. The several pieces are then assembled and glued together, this being done, in the Willard factory, by one



Fig. 49. Battery Box or Case with Handles. It Is Made from Kiln-Dried Oak Lumber and Thickly Coated with Acid-Proof Paint. All Metal Parts, Other Than Lead, Are Lead-Coated to Keep Them from Corrosion by the Acid in the Battery Solution.

machine. The finishing touches are then put on, these consisting of cutting the cases to the proper heights, sandpapering the boxes, etc. The cases are then inspected and are ready to be painted.

Asphaltum paint is generally used, the bottoms and tops being given three coats, and the sides two. The handles are then put on by machinery, and the box is complete, and ready for assembling.

Assembling and Finishing.

The first step in the assembly of a battery is to burn the correct number of positive and negative plates to their connecting straps,

thus forming the positive and negative "groups" or "elements." The "burning" consists of melting the straps and lugs on the plates together with an oxygen-hydrogen, or oxygen-acetylene flame so as to form one solid mass of lead. Positive and negative groups are next put together, with the separators between them. The completed groups are placed into the jars which are filled with electrolyte up to the proper points. The covers are put in position on the jars and the sealing compound poured over the joint between cover and jar so as to make a leak-proof joint. Figure 50 shows a cross-section of a completed cell.

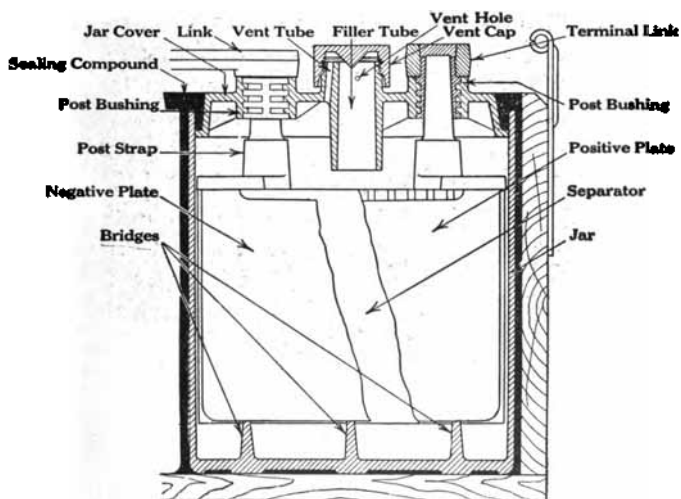

Fig. 50

The completed cells are now "formed" again, a current of about one-half ampere per plate being sent through the cell for six to seven days. When the plates have thus been formed again, the negative plate again consists of pure spongy lead, and the positive of lead peroxide. When the second forming is finished, the cells are put in the wooden case, the connecting links burned to the strap posts, nameplate put on, date stamped on, a careful general inspection given, specific gravity again measured, and the battery is ready for use on the car.

CHAPTER 14.

THE WORK SHOP. GENERAL INSTRUCTIONS.

The degree of success which the battery repairman attains depends to a considerable extent upon the workshop in which the batteries are handled. It is, of course, desirable to be able to build your shop, and thus be able to have everything arranged as you wish. If you must work in a rented shop, select a place which has plenty of light and ventilation. The ventilation is especially important on account of the acid fumes from the batteries. A shop which receives most of its light from the north is the best, as the light is then more uniform during the day, and the direct rays of the sun are avoided. Figure 51 shows a light,

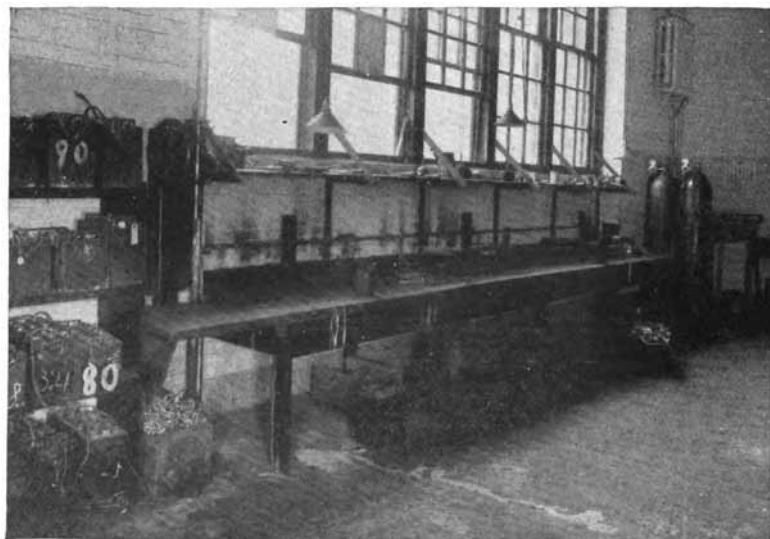

Fig. 51. Typical Work Room Showing Bench About 34 Inches High, Tanks of Hydrogen and Oxygen for Lead Burning, Hot Plates for Melting Sealing Compound and Hand Drill-Press for Drilling off Top Connectors

well ventilated workroom. At least 600 square feet of floor surface are needed, a shop 25 feet square being well suited for a small repair business.

The floor should be in good condition, since acid rots the wood and if the floor is already in a poor condition, the acid will soon eat through it. A tile floor, as described below, is best. A wooden floor should be thoroughly scrubbed, using water to which washing soda has been added. Then give the floor a coat of asphaltum paint, which should be applied very hot so as to flow into all the cracks in the wood. When the first coat is dry, several more coats should be given. Whenever you make a solution of soda for any purpose, do not throw it away when you are through with it. Instead, pour it on the floor where the acid is most likely to be spilled. This will neutralize the acid and prevent it from rotting the wood.

If you can afford to build a shop, make it of brick, with a floor of vitrified brick, or of tile which is not less than two inches thick, and is preferably eight inches square. The seams should not be less than one-eighth inch wide, and not wider than one-fourth. They should be grouted with asphaltum, melted as hot and as thin as possible, (not less than 450°F). This should be poured in the seams. The brick or tile should be heated near the seams before pouring in the asphaltum. When all the seams have been filled, heat them again. After the second heating, the asphaltum may shrink, and it may be necessary to pour in more asphaltum.

If possible, the floor should slope evenly from one end of the room to the other, with a drop of about one inch to the foot. A lead drainage trough and pipe at the lower end of the shop will carry off the acid and electrolyte.

It is a good plan to give all work benches and storage racks and shelves at least two coatings of hot asphaltum paint. This will prevent rotting by the acid.

Shop Equipment.

The exact equipment of any shop will be governed by the size and shape of the shop, and the amount of money available for fitting it up. Six things are absolutely essential. These are:

1. Work benches with vise.
2. Lead burning outfit.
3. Sink with water supply.
4. Charging bench and equipment.
5. Shelving, for storing boxes, plates, jars, tools, burning lead, etc.
6. Stove for heating sealing compound.

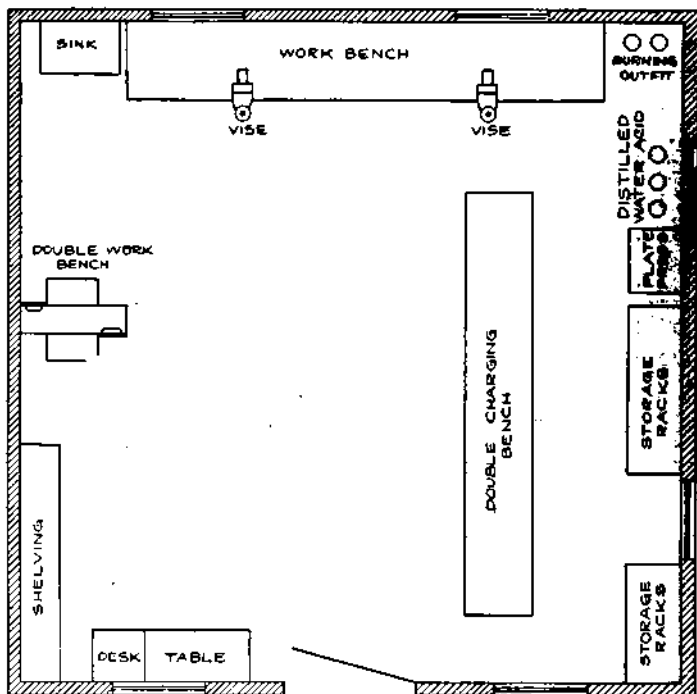

Fig. 52. Suggested Layout for a Small Battery Repair Shop

The arrangement of these parts will depend upon the size and shape of the workshop, and the ideas of the repairman. Figure 52 shows a convenient design for a shop 25 feet square, and figure 53 is from an actual photograph of an up-to-date, progressive small repairshop. Near the door is the desk where the

book-keeping is done. A table is placed next to it for catalogues, magazines, etc., and for eating lunch.

The work bench extends across one end of the shop, and is sixteen feet long. At one end is a sink, in which the sediment may be washed out of the jars. Figure 54 is a photograph. The bent pipe extending upward is perforated with a number of 1-16 inch holes. In cleaning out jars, the battery box is inverted over the



Fig. 53. Corner of Workshop, Showing Burning Outfit, Burning Bench and Vises

pipe. The water supply is controlled by a foot operated valve, so that the box may be held in both hands while it is washed. At the other end of the bench is the lead burning outfit, the use of which is explained later. The bench should be made of lumber two inches thick, and given several coats of hot asphaltum paint.

Special Work Bench.

The cross-shaped, double work bench shown at the left in Figure 52 is of a special design, and requires a detailed explanation. The bench is to be used by two men, one sitting at each end, and with the following explanation, you should have little difficulty

in constructing one. Figure 55 is a photograph of this bench, as it has been used for several years. Figure 56 is a drawing giving dimensions. Give the various parts of the bench a good coat of asphaltum paint, not too thick, as you assemble it so as to cover the surfaces which will later be covered by other parts

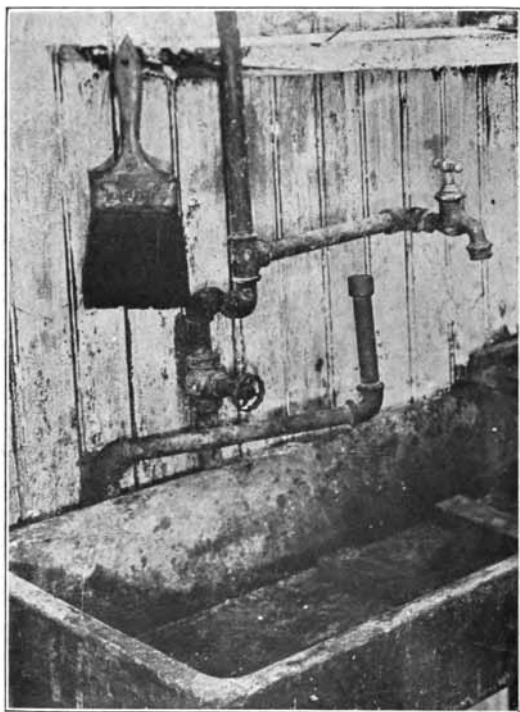

Fig. 54. Sink with Faucet, and Extra Swinging Arm Pipe for Washing Out Jars.
Four Inch Paint Brush for Washing Battery Cases

and thus be impossible to paint. When completed, give the bench a second coat of asphaltum, and let it dry thoroughly before using.

The bench should have a permanent location so that gas, if available, can be piped to it. Otherwise, a gasoline torch may be used. It is a good plan to have it near a wall or partition where each workman may have, within easy reach, shelves on

which are kept labeled boxes with parts for different batteries in process of repair and rebuilding. You will note that there are in middle of bench, directly in front of each workman, elevated shelves, one for each workman, forming two pockets for tools, so that each may keep his own tools separate, with very little chance of becoming mixed. On the edge of shelves you can put several nails and hang any special wrenches, such as Exide lead nut wrench, monkey wrench, a pair of snips, a lead funnel, and

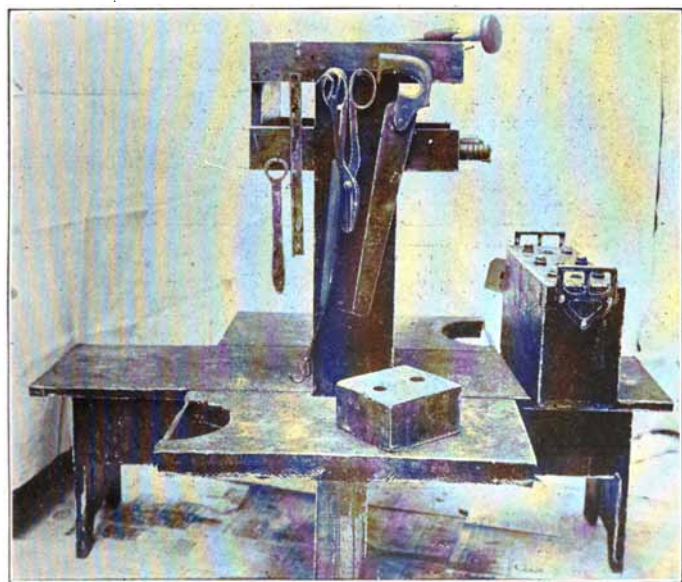
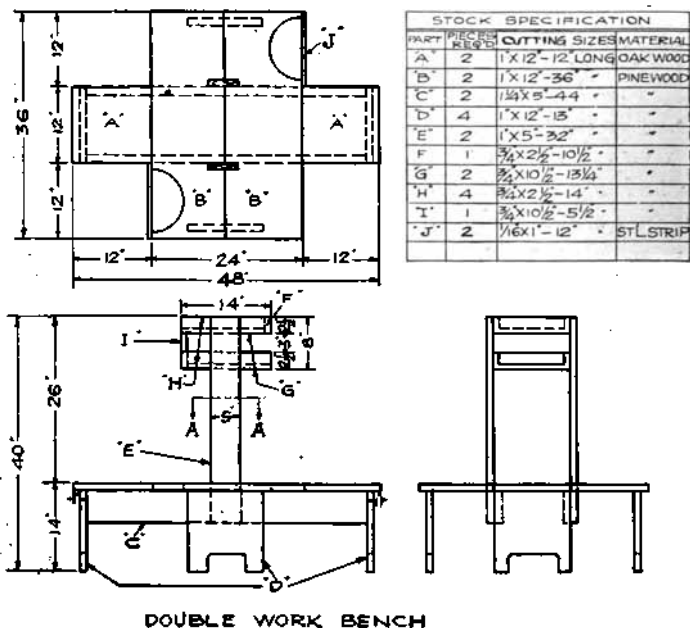

Fig. 55. Double Work Bench

a hammer or two, (bore holes in handles so you can hang up.) In each workman's separate pocket there should be a pair of rubber gloves, four screw drivers, four putty knives, $\frac{1}{8}$ and $\frac{1}{2}$ inch chisels, 2 pairs bent nosed pliers, 2 or 3 pairs different sizes of gas pliers, a good knife, a wire brush, a lead pencil, some good rags and an assortment of pieces of boards $1\frac{1}{2} \times \frac{7}{8}$ inches, and just long enough to go in between the handles of the different standard makes of batteries. These should be oiled, or a thin film of vaseline spread over them. They are used to even up

the separators in assembling, and also in pressing down the top covers when finishing rebuilding of batteries, as described later. You should also have one piece $1\frac{1}{2} \times 3\frac{3}{8}$ inch and one piece $1\frac{1}{2} \times 1\frac{1}{4}$ inch, each 8 or 10 inches long.

You will find the tool scraper (shown at J in figure 56) to the right of each workman very convenient for removing the



DOUBLE WORK BENCH

Fig. 56

compound sticking to your tools. Always have a box under it to catch the compound. When a battery is on the bench and the workman sitting up to it, straddling battery and bench, he is in the best possible position to open it.

A gas, gasoline, or oil pilot light should be mounted on one side of the two uprights. By using two screw drivers in opening a battery, one can be warming in the flame, while you are using the other.

Shelving.

The dimensions of the shelving depend upon the nature of the material to be stored. For miscellaneous parts, such as empty jars, empty boxes, groups of plates, tools, separators, cans of grease, bottles of ammonia, or soda solution, and so on, one inch stock is strong enough. For storing completely assembled batteries, two inch lumber should be used as they must carry



Fig. 57. Typical Stockroom Showing Heavy Shelving Necessary for Storing Batteries

loads of hundreds of pounds. The vertical distance between shelves should be two feet if there is sufficient space, in order to be able to take specific gravity readings without removing the batteries from the shelves. A space should be left between batteries for ventilation. Figure 57 shows the type of shelving required.

Concerning Light.

Many battery shops are unfortunately situated in basements. Light is essential to good work, so you must have plenty of

good light and at the right place. For a light that is needed from one end of a bench to the other, to look into each individual battery, or to take the reading of each individual battery, there is nothing better than a 60 Watt tungsten lamp under a good metal shade, dark on outside and white on inside.

A unique way to hang a light and have it movable from one end of the bench to the other, is to stretch a wire from one end of the bench to the other. Steel or copper about 10 or 12 B & S gauge may be used. Stretch it about four or five feet above top of bench directly above where the light is most needed. If you have double charging bench, stretch the wire directly above middle of bench. Before fastening wire to support, slip an old fashioned porcelain knob (or an ordinary thread spool) on the wire. The drop cord is to be tied to this knob or spool at whatever height you wish the light to hang (a few inches lower than your head is the right height).

Put the ceiling rosette above middle, endwise of bench; cut your drop cord long enough so that you can slide the light from one end of bench to the other after being attached to rosette. Put vaseline on the wire so the fumes of gas will not corrode it. This will make the spool slide easily. This gives you a movable, flexible light, with which you will reach any battery on bench for inspection. The work bench light can be rigged up the same way and a 75 or 100 Watt nitrogen lamp used.

Charging Methods.

A man must have food and exercise to retain his health and strength. Moreover, there must be a proper balance between the food and exercise. Unused muscles become stiff and weak, and food alone will not restore their strength. A man who takes more food than his body needs becomes fat, sluggish and diseased. If, on the other hand, he works hard, and does not eat a sufficient amount of food, his body becomes exhausted, and he is sick, and unable to work. Even when no exercise is taken, the man must have food, or he will die of starvation.

The storage battery is quite human in many respects. It must have the proper amount of food and exercise in order to be

in the best of health. It must have food, even though it may be idle; but, on the other hand, it must not have too much food at any time, even though it may be working regularly and using up energy supplied by the food.

A battery, unlike a man, has no mind to enable it to regulate its food and exercise, and is entirely at the mercy of the car owner and garage battery man. When called upon it must work as long as a bit of energy remains, and until it is completely exhausted and often hopelessly injured. It must also accept all the food offered to it, even though the amount is far in excess of that needed to restore the amount of energy used up in doing its work. Since the battery is thus unable to defend itself against any abuse and mistreatment to which it may be subjected, it becomes necessary for the car owner and repairman to think for the battery, and to treat it as he does his own body, giving it the proper amount of food and exercise.

Electricity is the battery's food, and you feed the battery when you charge it. The electricity must be digested just as our own food is. The process of digestion in the battery consists of the formation of spongy lead and lead peroxide from the lead sulphate. When all the sulphate has been thus changed, the battery has received as much food as it can digest, and if it is given more, the energy of the food will be wasted.

The battery works by using the energy resulting from the digestion of the electricity, and it should not be forced to work until its energy is completely exhausted, any more than a man should work until he drops from weariness. A man in such an overworked condition is sick, and requires careful nursing and feeding to restore his health. An overworked battery or starved battery requires slow feeding, because its weakened elements cannot absorb the food or charging current quickly, but must be charged at a low rate.

The feeding of a battery is in the repairman's hands, and he must see that the battery is not overworked or starved any more than he overworks or starves himself. Thus, charging the battery means more than simply sending a current through it. The current must not be supplied faster than the battery can absorb

it. Batteries of different sizes must not be given the same amount of food any more than men of different sizes must be.

The great majority of battery men have adopted the plan of connecting batteries in series while charging them. This is undoubtedly the cheapest and most convenient method, but has several disadvantages.

Batteries which have different voltages and capacities require different charging currents, and great care should be taken that the batteries which are connected in series require approximately the same charging currents, and are of the same voltage. Garage-men are often careless in this respect, and the smaller batteries are

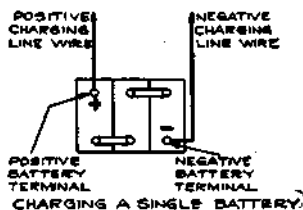

Fig. 58

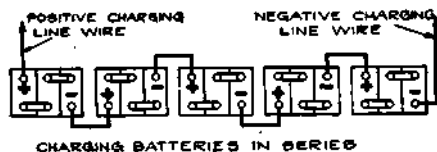

Fig. 59

greatly overcharged and literally "boiled to death." In charging, therefore, do not connect batteries of various sizes in series and send the same charging current through them. The smaller batteries will heat up in their attempt to absorb the heavier current required by the larger batteries, and may be permanently injured.

Furthermore, the batteries should be in approximately the same state of discharge, as shown by the specific gravity readings. If these readings differ considerably among the various batteries, those with the highest readings should be watched carefully, and removed from the circuit when there is no further rise in specific gravity after all cells are gassing freely. Never start a charge

at such a high rate that gassing takes place immediately, or before the specific gravity stops rising.

In connecting a battery to a charging line, always connect the positive battery to the positive line wire, and connect the negative battery terminal to the negative line wire, figure 58. If you connect a number of batteries in series for charging, connect the positive terminal of one battery to the negative terminal of the next, figure 59.

Instead of connecting all the cells in series, it is a good plan to have several charging circuits in parallel, and connect enough batteries in series on each circuit to obtain the correct charging current. In this way, batteries of various capacities may be charged at once, each circuit being composed of batteries of approximately the same capacity.

The sum of the voltages of the batteries which are connected in series should never be greater than the voltages of the charging circuit. This would result in the batteries discharging back into the line, instead of being charged.

Charging Equipment.

The apparatus to be employed in charging starting and lighting batteries depends largely upon the source of electricity which is available. If a 110 volt, direct current supply is used, the simplest and cheapest apparatus is the charging bench with lamps for resistance, which will be described. Instead of the lamps, a motor-generator set may be used, which has a 110 volt, direct current motor, and a low voltage generator. Such an outfit is far more expensive than the lamps, however, and has no marked advantages to justify its installation.

Where only alternating current is available, a rectifier or motor-generator must be installed. The rectifier changes the alternating current into a direct current. It may do this by means of a mechanical device, an electrolytic cell, or a tube of mercury vapor. The motor-generator set consists of an alternating current motor driving a direct current generator. Both the Mercury Arc Rectifier and the Motor-Generator are efficient.

Double Charging Bench.

The charging bench, as shown in Figures 60 and 61 is designed to accommodate thirty-two batteries. The bench shown in Figure 60 has been in actual use for several years. The wiring shown in Figure 62 is somewhat different from that of the bench shown in the photograph, and is intended to furnish any current up to about 30-36 amperes. This type of bench has several advantages.

1st. It occupies a minimum amount of floor space.

2nd. Any number of batteries from 1 to 32 may be charged at

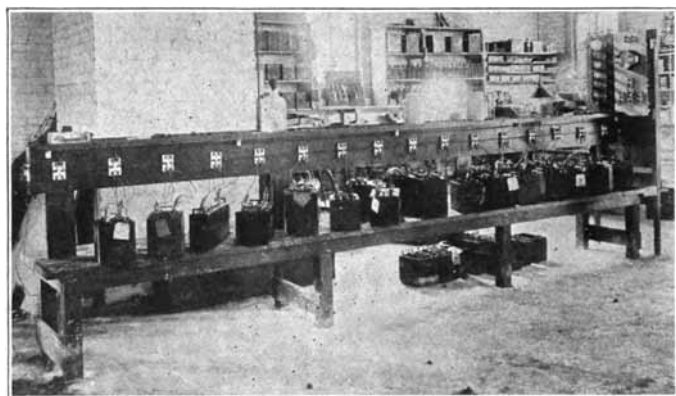

Fig. 60. Double Charging Bench

the same time. Any battery may be disconnected from the charging circuit by throwing up the knife switch for that battery. This will allow the other batteries to continue charging.

3rd. To each switch are attached two 18 inch flexible, No. 8 rubber covered wires, each of which has a hold-fast clip at the free end. These clips are snapped on the battery posts in an instant. This arrangement does away with the unsightly, time-consuming, inefficient method of tying batteries in series with any odd bits of wire which may be at hand, and after you once use this bench, you will never go back to the old, untidy, haphazard way of charging.

4th. The elevated shelf extending down the center of the bench is convenient for holding jars of distilled water, chalk for

ful to thoroughly cover all parts. If you want to charge more than 32 batteries at one time extend the bench so as to make it wider, and add more switches.

To do this use lumber of the same thickness as the top, and twelve inches wide. Brace with two by fours nailed to the side of the bench.

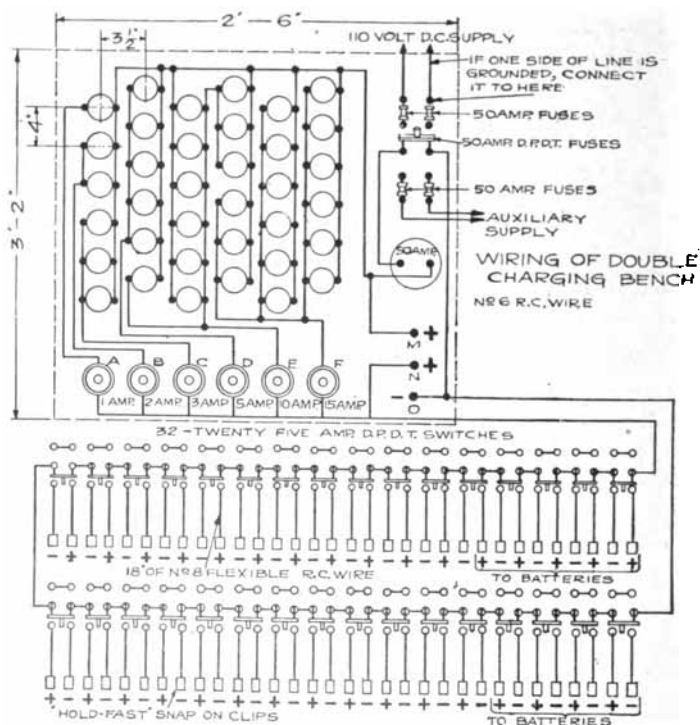

Fig. 62

Figure 62 shows the wiring diagram, using 36 thirty-two candle power, carbon filament lamps. These give one ampere each on 110 volts. Other sized lamps may be used, depending on the amount of current desired. The switches shown at A, B, C, D, E and F control the various groups of lamps. These may be the ordinary 10 ampere snap switches, or 10 ampere, single pole, single throw knife switches. Any current from 1 to 36 amperes may be

obtained in one ampere steps by turning on one or more of these switches as needed. The snap switch covers should be dipped in hot asphaltum paint, and the current carrying contacts covered with vaseline or grease.

The board carrying the lamps should be mounted at one end of the bench, as shown in figures 60 and 61. It should be of one-inch stock, which has been given two coats of asphaltum paint. The porcelain sockets should be the "Edison cleat receptacle" or of similar design. These sockets have two screw holes in front for fastening to the board. They also have the binding posts in front. The wire connections for the whole board should be made on the front. For the connections to the sockets, use No. 12 rubber covered wire. For all other connections, including the two feed wires to the battery switches on the bench, use No. 6 rubber covered wire or cable. No. 10 wire may be used if the No. 6 cannot be obtained. Keep all metallic parts covered with vaseline or grease to prevent corrosion from acid fumes.

The double pole, double throw switch with fuse extensions should have a capacity of 50 amperes. This may be bought mounted on a slate base, or the various parts may be bought unmounted, and then mounted directly on the board. Use 50 ampere enclosed fuses or 50 ampere fuse links for this switch. The lower studs are to be used for an auxiliary source of power, such as a rectifier, motor generator, or a shop dynamo driven by a gas or gasoline engine. These will be described later. The ammeter should be of the round, iron-clad switch board type, with a scale reading up to 50 amperes. The connections to this meter will probably have to be made in back of the board.

Terminals M, N, and O are provided for the purpose of using the lamp bank for tests on anything in other parts of the shop which may require an adjustable current. If two wires are attached to terminals N and O, the current will first pass through the lamps, and it may be adjusted to any value within the range of the lamp bank. If the wires are attached to M and O, the full line voltage will be available for test purposes. The binding posts on the board should be made of heavy brass, with knurled heads about three-fourths of an inch in diameter.

Instead of lamps, you may use Ward Leonard Enameled Re-

sistance Units, "EB" size. These are fitted with standard Edison bases for screwing into the lamp bases. These units are made in various capacities from 0.24 to 71 amperes each. The units listed as EB 90 will each give approximately one ampere, which is the current obtained through one 32 candlepower, carbon filament lamp.

If you can afford it, make two lamp and switch boards, putting one at each end of the bench, and connecting sixteen of the battery switches to each board. Such a bench is more useful than one having only one lamp board and charging line. The reason is that the majority of batteries have a "starting" and a "finishing" rate of charge. That is, when these batteries are first put on charge, a rather high rate is used until the cells are gassing. Then, the current is lowered to the "finishing" rate. All batteries in the charging line will not in general begin to gas at the same time, because the internal condition varies among the batteries, and some will begin to gas much more quickly than others. Since the current must be reduced in the gassing cells, it is convenient to disconnect these batteries from the line which is still carrying the "starting" current, and connect them to a second line carrying the "finishing" current.

The pivot screws, switch blades, spring contacts the blades enter should be kept covered with graphite and oils or vaseline to keep them from corroding from the acid fumes. For the same purpose, the hold-fast clips, after they are connected to the drop cord or flexible wire should be dipped in hot thin asphaltum paint together with several inches of the drop cord to keep them from being attacked by acid. It is well to make up a few extra cords 18 inches or 2 feet long, with hold-fast clips at each end, as they are handy in connecting two or more batteries in series and in paralleling batteries. It is well to make two charging benches while you are at it, instead of just one, and not mount the center shelf on one of them until really needed, but use the bench as a convenient place to keep charged batteries. Always keep your batteries in an orderly way on this bench, and whenever you put one on it, be sure and have the positive end in so that the tag, which should always be attached to the negative handle, will hang out. Then you can readily find any battery you are looking for.

In Figures 63 and 64 are shown the wiring diagrams for other charging boards to be used on a 110 volt, direct current circuit.

The connections shown may be made by any automobile repairman or by any electrician. In Figure 63 the necessary resistance

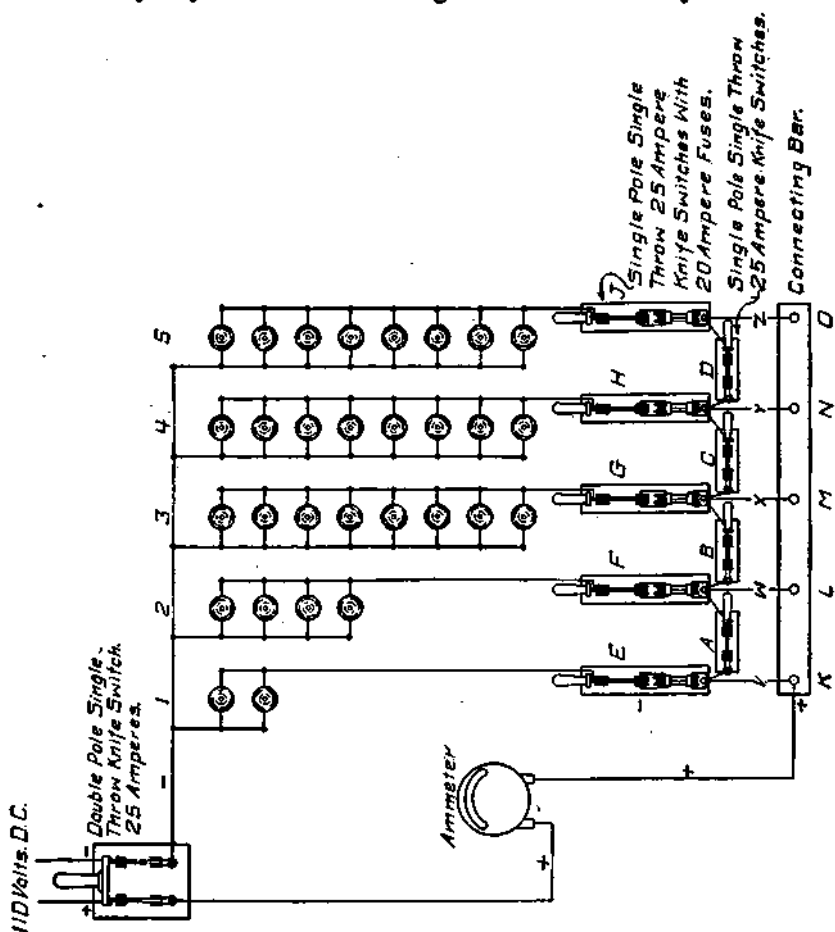

Fig. 63. Another Type of Charging Board

is supplied by means of five banks of incandescent lamps, one bank carrying two bulbs, one carrying four and the remaining three carrying eight bulbs, each. At the left is shown a double pole, single throw knife switch of 25 amperes capacity to one side

of which the supply line is attached. From one blade on the other side of the switch a line leads to one side of each of the lamp banks, and from the other blade a line leads through the ammeter

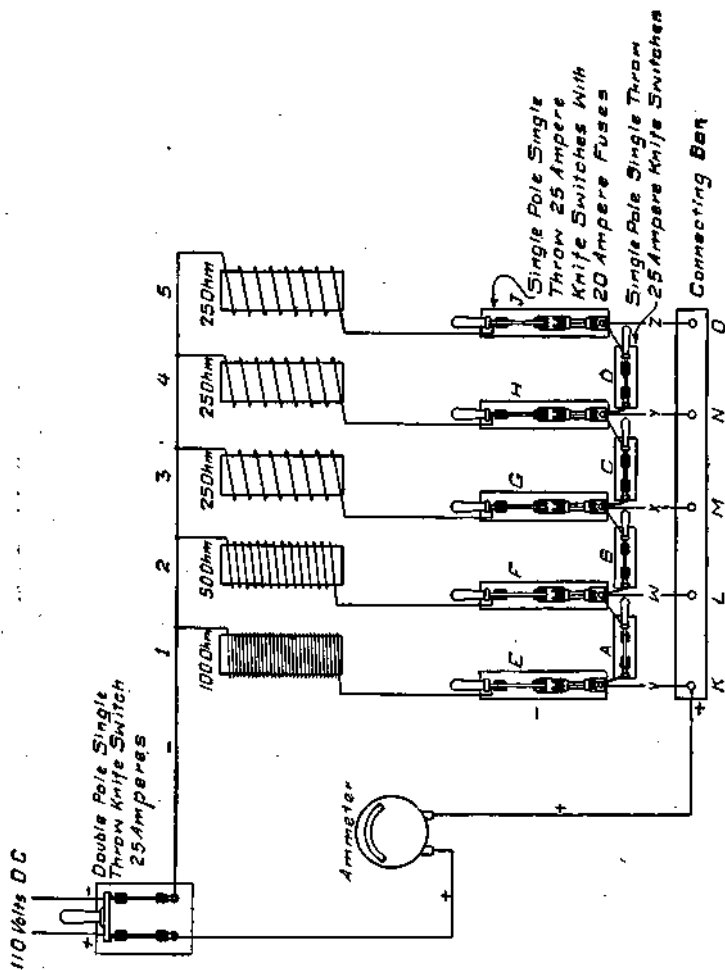

Fig. 64. Resistance Coils for Charging Batteries

to the bus-bar shown at K-L-M-N-O. From the other side of lamp bank number 1 a wire leads to the single pole, single throw, 25 ampere knife switch which carries a 20 ampere fuse, this switch being marked E. From the bank of four lamps a line leads to a

similar switch, F, and from the banks of eight lamps each, lines lead to the switches G, H and J. These lines may be connected with each other by means of the single pole, single throw, 25 ampere knife switches A, B, C and D. Batteries to be charged are attached between the fused switches and the bus-bar at the points marked V, W, X, Y and Z.

Carbon bulbs of 50 watt or 16 candle power capacity should be used in each of the thirty lamp sockets. One bulb of this size allows a current flow of approximately $\frac{1}{2}$ ampere. With the arrangement shown, batteries of five different ampere-hour capacities may be charged at the same time, each capacity at its proper amperage. The various amperages may be obtained according to the following instructions, all switches being left open except those you are directed to close. The main line switch should, of course, be closed for all the combinations given:

- 1 ampere—Attach battery at V, close switch E.
- 2 amperes—Attach battery at W, close switch F.
- 3 amperes—Attach the battery at W and close switches A, E, and F.
- 4 amperes—Attach the battery at X, Y or Z and close switches G, H or J, respectively.
- 5 amperes—Attach the battery at X and close switches A, B, E and G.
- 6 amperes—Attach the battery at X and close switches B, F and G.
- 7 amperes—Attach the battery at X and close switches A, B, E, F and G.
- 8 amperes—Attach the battery at Y and close switches C, G and H.
- 9 amperes—Attach the battery at Y and close switches A, B, C, E, G and H.
- 10 amperes—Attach the battery at Y and close switches B, C, F, G and H.
- 11 amperes—Attach the battery at Y and close switches A, B, C, E, F, G and H.
- 12 amperes—Attach the battery at Z and close switches C, D, G, H and J.

- 13 amperes—Attach the battery at Z and close switches A, B, C, D, E, G, H and J.
- 14 amperes—Attach the battery at Z and close switches B, C, D, F, G, H and J.
- 15 amperes—Attach the battery at Z and close all switches.

With the positive and negative wires connected as shown, the positive terminals of the battery should always be connected to the bus-bar and the negative terminals to the switch leads. In case it is desired to charge two or more batteries requiring the same current they should first be placed in series with each other by connecting the positive terminal of one to the negative terminal of the next one, thus leaving one positive and one negative terminal, the positive to be connected to the bus-bar and the negative to the switch lead. It will be seen that this method allows you to handle any number of batteries at any rate of charge from one to fifteen amperes. For connecting batteries in series in this way, make about two dozen lengths of No. 12 flexible lamp cord, each about one foot long, and having a "hold-fast" snap on terminal on each end. By using 100 watt or 32 candle power bulbs with carbon filaments the charging rate will be exactly doubled for each connection; that is, where one ampere was given two will be secured, where two amperes were given four will be secured, etc. In this case the switch and fuse capacities must be doubled.

In Figure 64 is illustrated a system similar to that described with the exception that coils of resistance wire are used in place of the lamp banks. The connections for various currents will be exactly the same as in the lamp system and the explanation using the reference letters will be the same in all particulars. The coil windings from number one to number five may be made up as follows:

- Coil 1—With German Silver wiring, 75 feet of 28 gauge. With Nichrome wiring, 30 feet of 28 gauge.
- Coil 2—With German Silver wiring, 38 feet of 28 gauge. With Nichrome wiring, 15 feet of 28 gauge.
- Coils 3, 4 and 5—With German Silver wiring, 19 feet of 28 gauge. With Nichrome wiring, 8 feet of 28 gauge.

Motor-Generator Sets.

Small motor-generator sets with control panels may be purchased from any of the larger electrical manufacturers and supply houses. A list of such companies is given in Chilton's Automobile Trade Directory. In selecting a motor-generator set, the voltage of the supply circuit, the maximum and minimum charging rates, the voltage of the batteries, and the number of batteries to be charged at one time determine the size and type of the motor and generator. The current which the generator is capable of delivering depends upon the maximum and minimum charging rates. The charging rates recommended by battery manufacturers vary from a minimum of about 3 amperes to a maximum of approximately 25 amperes. The average length of time required for a normal complete charge varies from eight to twelve hours, but in charging sulphated batteries, a much longer time, at a low rate is required. The charging voltage is from 2.6 to 2.7 volts per cell. Multiplying this by the total number of cells in the batteries which are to be connected in series on the charging circuit gives the generator voltage.

The motor-generator sets include the necessary voltmeter, ammeter, and rheostat. Motor and generator shafts are coupled directly together, and are mounted on solid timbers. The meters and rheostat are usually mounted on the frames of the two machines, and the entire set may be mounted on a bench. Charging current is regulated by varying the generator voltage with the rheostat, which changes the resistance of the generator field circuit.

Mercury Arc Rectifier.

The operation of the mercury arc rectifier depends upon the fact that a tube containing mercury vapor under a low pressure and provided with two electrodes, one of mercury and the other of some other conductor, offers a very high resistance to a current tending to pass through the tube from the mercury electrode to the other electrode, but offers a very low resistance to a current tending to pass through the tube in the opposite direction. The low resistance offered when the current tends to pass through the

tube toward the mercury electrode depends upon the formation of an arc in the tube by tilting it so the mercury bridges the gap between the two electrodes just for an instant, as will be explained more fully later on.

Mercury arc rectifiers find their chief application as a means of charging storage batteries. They are used to some extent in

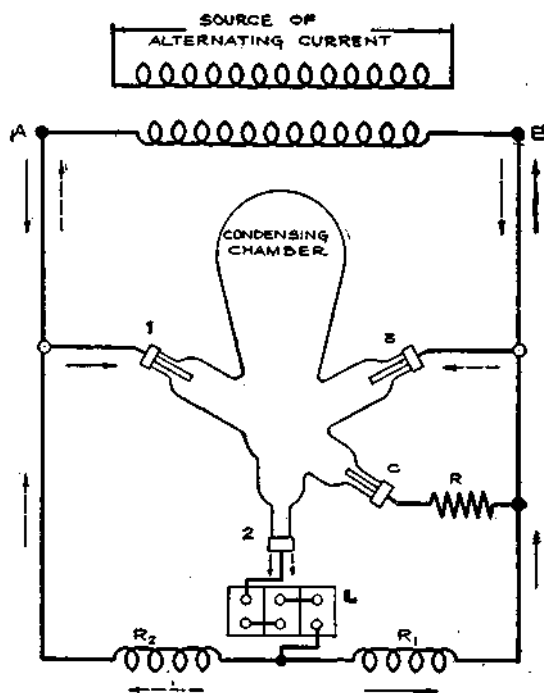

Fig. 65. Mercury Arc Rectifier

supplying current to certain types of direct-current arc lamps from an alternating current supply circuit. Some very large mercury arc rectifiers have been constructed and used on electric cars and locomotives, power being supplied to the car or locomotive from a high-voltage alternating current trolley, the pressure being reduced on the car or locomotive by means of static transformers and then converted into a low voltage direct current suit-

able for the direct current motors. This scheme promises to work out quite well with the higher voltage direct-current motors, such as 1,000 or 1,200 volt kind. The chief objection to this application of the mercury arc rectifier lies in the difficulty of producing a tube of rugged construction and lasting qualities.

The outline of a mercury arc tube is shown in Figure 65. It is made of glass in the smaller sizes used in charging storage batteries. It is exhausted to a high degree of vacuum and contains a small quantity of mercury in the bottom. The upper part of the tube is used only as a condensing chamber wherein the heated mercury-vapors are cooled and condensed so they may again settle at the bottom. The cathode, or negative electrode is always at the bottom and two or more anodes, or positive poles, are arranged around the side of the tube. Two anodes are required for a single-phase operation and three for three-phase operation. There is also a small starting electrode, "C," connected to one side of the alternating-current circuit through a resistance and used for starting the arc. When the rectifier tube is rocked so as to form and break a bridge of mercury between the mercury cathode at the bottom and the starting anode "C," a small arc is formed. This small arc produces mercury vapor in the tube and the arc immediately jumps to one or the other of the main anodes and then alternates on these during regular operation.

The operation of the mercury arc rectifier may be analyzed as follows: Let us assume an instant where the point "A" is positive and the point "B" is negative in Figure 65. Current will then flow from anode "1" at the left to cathode "2," through the load "L," which in this case is a storage battery, through the reactance "R₁," and back to the negative terminal of the source at "B." The current cannot jump from anode "1" to anode "3" on account of the high counter-electromotive force of the arc. The full line arrows show the direction of the current for the half cycle of the alternating current wave when the terminal "A" is positive and the terminal "B" is negative. During the next half cycle the terminal "B" is positive and the current flows from "B" to the anode "3," to the cathode "2," through the load "L," and the reactance "R₂" back to the negative terminal of the source which in this case is the terminal "A." The dotted arrows show

the path of the current during this half of the cycle. During a whole cycle the cathode "2" is continuously negative, but first one anode and then the other is active. Should the voltage and current become zero at exactly the same time the arc would become extinguished and operation cease. In order to prevent an

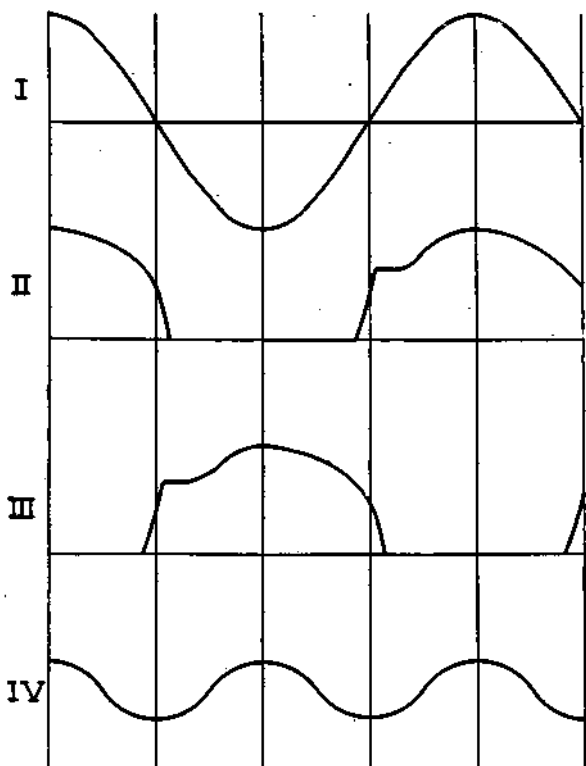

Fig. 66. Wave Form of Mercury Arc Rectifier

occurrence of this kind the reactances " R_1 " and " R_2 " are introduced. At the end of the first half cycle described above when the line voltage has dropped to zero, the reactance " R_2 " maintains the current and a local circuit is formed through " R_2 " anode "1," cathode "2" and load "L," which maintains the arc until the voltage at "B" has increased to a value that will main-

tain the arc. The rectifier thus makes use of both half waves, or the entire alternating current, and the result is quite a uniform pulsating unidirectional current. On account of the reactance in the circuit the current in the load never falls to zero value and, in fact, with sufficient resistance, may be made very nearly constant. This condition is not always desirable as it produces a very bad distortion of the alternating current wave.

The general form of the waves produced by a mercury arc rectifier are shown in Figure 66. The upper wave represents the alternating voltage wave.

The second and third waves are those of the currents in the two positive electrodes. The fourth wave is a combination of the second and third and it represents the current in the load "L."

At present mercury arc rectifiers are generally used with auto-transformers, and these transformers are usually designed in such a manner as to make the reactances " R_1 " and " R_2 ," as shown in Figure 65 unnecessary, sufficient reactance being provided in the auto-transformer to accomplish the desired results. A proper proportion of reactance may be made to stop the action of the rectifier when the current falls to a certain value. This arrangement is particularly useful in connection with storage battery charging.

The resistance "R" connected in series with the starting electrode "C," as shown in Figure 65, is to prevent an excessive current passing through the circuit when the tube is tilted for starting.

The temperature of a tube must never be allowed to rise too high as the life of the tube is greatly reduced. Some of the larger tubes are immersed in oil to facilitate cooling. The vacuum in the tube may be tested by removing the tube from its supports and shaking it, if the vacuum is good, the mercury will give out a metallic sound. If the tube is dirty on the inside and there is a tendency for the mercury to stick to the sides, the vacuum is poor.

An average life of over 600 hours is claimed for the sizes commonly used in charging the batteries in electric automobiles and in some cases a useful life of 5,000 hours has been obtained. The

average life of small tubes used in charging ignition batteries is much greater.

The efficiency of the rectifier varies with the voltage used on the direct-current side, as there is always a drop in voltage through the mercury vapor, which is practically independent of the current used. For rectifiers of 30 to 50 ampere capacity, the drop in voltage across the rectifier terminals is equal to about 15 volts. The lower the direct-current voltage therefore, the greater the percentage of loss. This loss is in addition to the losses in the auto-transformer and brings the average efficiency down to 75 or 80 percent for a direct current voltage of about 80 volts.

When used for charging storage batteries, rectifiers require considerable variation of the direct current voltage, and for this reason are usually provided with variable reactance in the primary circuit of the transformer, also with taps in the secondary winding. They are, as a rule, specially designed for the class of work for which they are intended.

The Electrolytic Rectifier.

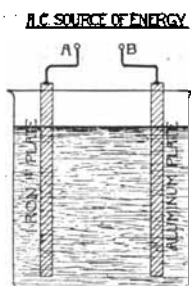

Fig. 67

The action of the Electrolytic Rectifier is explained by the fact that certain electrolytic cells having electrodes of different metals will allow a current to pass through them in one direction only. Thus, if a plate of iron and a plate of aluminum be immersed in a solution of ammonium phosphate as shown diagrammatically in Figure 67, and the two plates connected to a source of alternating current, the following results will be obtained.

The alternating pressure between the terminals A and B tends to send a current through the cell first in one direction and then in the other direction, and if the resistance of the cell was independent of the direction of the current, there would be an alternating current produced and this current would be represented by a curve of the form shown in Figure 68, with the distance of the curve above or below the line MN corresponding to the value of the current, the current being in one direction when it is

above the line MN and in the opposite direction when it is below the line MN. There is, however, quite a high resistance offered by the electrolytic cell when an attempt is made to send a current through it in a direction from the aluminum to the iron plate, and as a result of this high resistance to the current, there is in reality practically no current through the cell in one direction

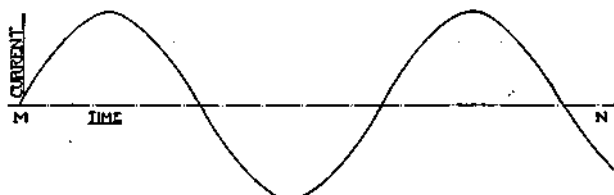

Fig. 68

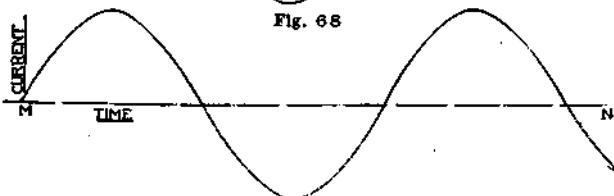

Fig. 69

as compared with the current through it in the opposite direction. This results in the current curve being of the general form shown by the full line in Figure 69. The dotted line represents the part of the current curve shown in Figure 68, which must be reduced to zero by the action of the electrolytic cell.

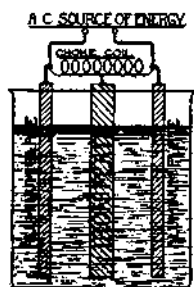

Fig. 70

This resistance offered by the cell is supposedly due to a high resistance film being formed at the surface of the aluminum when the current is in a direction from the aluminum to the electrolyte or iron plate. In the case just described, use is made of the available pressure just one-half of the time and hence there is current in the circuit only half of the time. A storage battery connected in such a circuit could not be charged very satisfactorily or efficiently.

A better arrangement of the cell may be made as shown diagrammatically in Figures 70 and 71. Two aluminum plates

are used instead of one and they are connected to the source of alternating current through a choke coil as shown in Figure 71. The operation of this arrangement may be followed briefly, as follows: Let us assume there is a current in the alternating current line in the direction indicated by the arrows marked 1 and 2. The current meets with a high opposition in

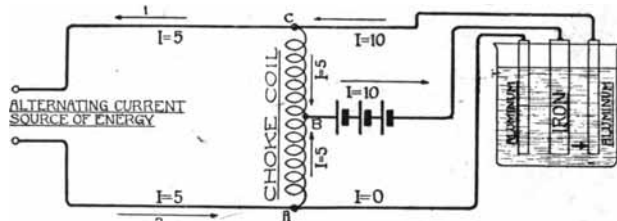

Fig. 71

trying to pass from the left-hand aluminum plate to the iron plate and as a result, the current in this circuit is practically zero. There is, however, a path of relatively low resistance from the point A to the point B through the battery to the iron plate through the cell to the right-hand aluminum plate and then to the point C. As a result of this current passing through the

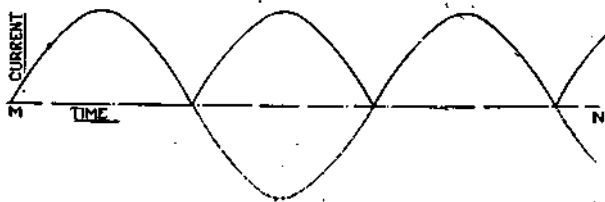

Fig. 72

choke coil from the point A to the point B, there will be a current induced, due to transformer action, in the part of the winding between the points B and C, and its direction will be from the point C toward the point B where it combines with the current from the point A, and gives the total current through the battery. This results in the current in the battery being 10 amperes when

the current in each of the two sections of the choke coil is approximately 5 amperes.

Now when the current in the alternating current circuit reverses, there will be no change in the direction of the current in the two sections of the choke coil, but both will still be toward the point B and through the battery, which results in the battery current being of the general form shown in Figure 72. The dotted section of the curve which was wiped out entirely by the arrangement shown in Figure 67, is now reversed in the direction relative to the other loops of the current curve and as a result, all of the loops are now in the same direction, which gives a much better charging current for the battery.

If the electrolytic cell is to be self cooling, the aluminum plates should be of such a size that there are about 7 square inches of surface per ampere direct current, and the iron plate should be at least twice this size and better still if it is three times the area of the aluminum plates. The distance between the aluminum plates should be about one-half inch. The containing vessel should be of such a size that there is approximately one square foot of radiating surface per ampere direct current. An ordinary granite-ware bucket may be used as a containing vessel. The plates may be mounted on one-half inch strips of wood of ample length to reach across the top of the containing vessel. The dimensions of the plates may be made such that they will best fit in the containing vessel and small ears may be left on their corners to be used in attaching them to the wooden supporting strips. The electrolyte should consist of a saturated solution of pure neutral ammonium phosphate. The size of the plates and the volume of the electrolyte required to fill the large containing vessel in order to give ample radiating surface may be greatly reduced by using some artificial means of cooling. Cold water may be circulated through pipes placed in the electrolyte or the electrolyte itself may be made to circulate through outside cooling coils.

The direct current voltage is roughly one-half of the alternating current voltage and this relation is not fixed but depends upon the temperature of the electrolyte and the condition of the surface of the plates.

With the arrangement shown in Figure 71, it will be necessary to reduce the direct current voltage in order to charge a six-volt battery, if the source of alternating current is a 110-volt circuit. This reduction can be made by means of a resistance in series with the choke coil, or better still, by means of a small transformer with several secondary taps so that current at several different voltages may be taken from the secondary winding. A resistance may be placed in series with the battery and the charging current regulated by varying the amount of this resistance. The transformer is, of course, the most efficient means of bringing about the desired voltage reduction.

The construction of the choke coil will depend upon whether it is to be connected directly to the 110-volt circuit or to the secondary terminals of a transformer. If used directly connected to the alternating current circuit, it may be made by winding 300 turns of No. 18 B. & S. cotton covered wire on an iron ring 5 inches in diameter. This iron ring may be made by winding a quantity of small soft iron wire in a form until the area of the cross section of the ring is about $\frac{7}{8}$ sq. in.

Remember that your direct current is not steady in value and as a result direct-current and alternating current instruments will not indicate the same value of current, as the direct-current instrument gives an indication of the average current and the alternating current instrument gives an indication of the effective current.

Other Charging Equipment.

If there is no electric lighting in the shop, it will be necessary to install a generator and a gas, gasoline, or steam engine, or a water-wheel installed to drive it. The generator should, of course, be a direct current machine, and large enough to furnish lights for the shop in addition to charging the batteries. The size of the generator will depend upon the average number of batteries to be charged, and the amount of money available. Any of the large electrical manufacturers or supply houses will give any information necessary for the selection of the type and size of the outfit required.

If an old automobile engine, and radiator, gas tank, etc., are on hand, they can be suitably mounted so as to drive the generator.

Discharge Board.

It is often desirable to make discharge tests on a battery. A good way to determine the condition of the battery is to draw current of several values from it, and then measure the battery

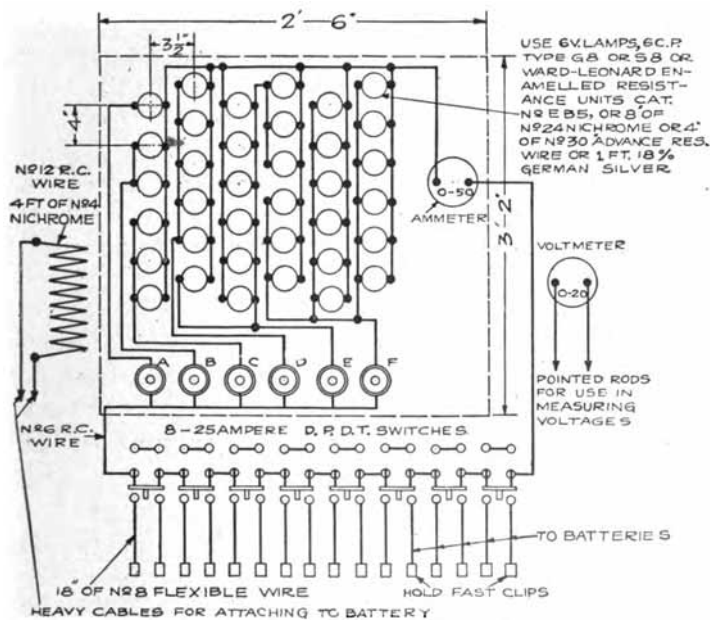

WIRING FOR DISCHARGE BOARD

Fig. 73

voltage and the number of ampere hours it will deliver before discharged. Trouble in a battery or cell is indicated by its voltage dropping to a low value while the current is passing through it. If it is desired to draw a current of approximately 100 amperes from a 6-volt battery, a special resistance is necessary. For this purpose, four feet of No. 4 Nichrome wire may

be used. Mount this on the discharge board, fit it with terminals, and attach two cables to it which may be connected to the battery which is to be tested. Measure the voltage of the battery while discharging it through the Nichrome wire.

Another use of the discharge board is in connection with charging and discharging a battery which has been badly sulphated.

Figure 73 shows the wiring for the discharge board. The size and type of resistances or lamps is shown. To discharge a bat-

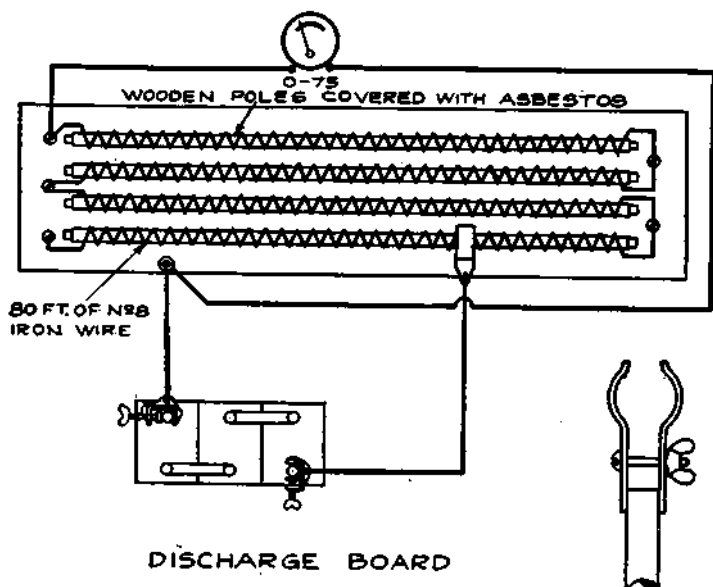

Fig. 74

tery, snap a pair of the hold-fast clips on the battery terminals, throw the double-pole switch for that battery down, and throw all other double-pole switches up. Then throw the snap switches on so as to obtain the desired discharge. The drawing shows eight switches, for discharging eight batteries in series, or any number from one to eight.

For the bench, use the dimensions of Figure 61, but make the length six feet instead of sixteen.

A simpler discharge resistance is shown in Figure 74. The

terminal on the end of the cable attached to the right hand battery post is movable, and may be clamped on any part of the resistance wire to obtain various currents. A detail of the terminal is shown at the right in figure 74.

Tools and Equipment.

Do not attempt to handle battery repair work until you have provided yourself with the proper tools. A good workman with poor tools cannot do better work than an average workman with good tools. The tools listed below are those recommended by three of the largest battery manufacturers in the United States.

Tools recommended and sold by the U. S. Light and Heat Corporation of Niagara Falls, New York:

- (1). Gas still for distilling water, in capacities of $\frac{1}{2}$, 1, and 5 gallons per hour.
- (2). Plate burning rack for holding connecting strap and plates while burning.
- (3). A plumber's or tinner's triangular scraper for scraping posts, lugs on plates, etc.
- (4). Steel wire brush, for cleaning terminals, etc.
- (5). Putty knife for removing sealing compound.
- (6). Two combination pliers for pulling out elements, etc.
- (7). One pair long flat nosed pliers for pulling out jars and separators.
- (8). One pair end cutting nippers for cutting connectors, posts, plates, lugs, etc.
- (9). One coarse bastard file for cleaning lead parts, and a file brush.
- (10). One ladle for sealing compound.
- (11). One Syringe hydrometer for measuring specific gravity, drawing off electrolyte, or adding distilled water.
- (12). One lead lined acid box, 24 inches by 36 inches by 24 inches high, for storing acid or separators.
- (13). Bottle of 1.300 Specific gravity electrolyte.
- (14). Bottle of 1.400 Specific gravity electrolyte.
- (15). Rods of lead-antimony for burning plates to straps.
- (16). Rods of pure lead for burning in top connectors.

(17). Sealing compound.

The above list of tools may be obtained by communicating with the U. S. L. factory at Niagara Falls, New York.

The next list is that recommended by the Gould Battery Company:

- (1). 1 pair rubber gloves, to protect the hands from acid.
- (2). 1 7-inch end cutting nippers, for cutting connectors, posts, plate lugs, etc.
- (3). 2 combination pliers, for pulling elements, etc.
- (4). 1 triangular lead scraper, for scraping burning lead, plate lugs, etc.
- (5). 1 putty knife for removing sealing compound.
- (6). 1 $\frac{1}{2}$ -inch wood chisel for removing sealing compound.
- (7). 1 5-inch screw driver for removing sealing compound and covers.
- (8). 1 single end wrench for removing taper terminals.
- (9). 1 10-inch file and handle, for filing plate lugs, lead, etc.
- (10). 1 steel wire brush, for cleaning terminals, etc.
- (11). 1 ball point hammer for general work.
- (12). 1 10-inch ratchet brace, for drilling connecting links loose from posts.
- (13). 1 $\frac{5}{8}$ -inch bit stock drill for removing $\frac{5}{8}$ -inch connectors.
- (14). 1 $\frac{7}{8}$ -inch bit stock drill for removing $\frac{7}{8}$ -inch connectors.
- (15). 1 center punch, for centering terminals to drill.
- (16). 1 adjustable hack saw frame for general work.
- (17). 3 hack saw blades, 8 inches, for the above.
- (18). 1 Iron ladle for pouring sealing compound.
- (19). 1 pair blue glasses, for use when operating burning outfit.
- (20). 1 soft rubber bulb syringe, for flushing and equalizing electrolyte.
- (21). 1 steel file brush for cleaning lead parts and file.
- (22). 1 burning rack with extra guides, for holding plates and connecting straps in place while burning.
- (23). 1 hydrometer for mixing electrolyte.
- (24). 1 thermometer to determine the temperature of the cell.

(25). 1 lead burning outfit.

Prices on above repair kit in box, including burning rack with one spacing guide, but not including lead burning outfit, \$17.85 f. o. b. Depew, New York. Price in force November, 1917.

The Willard Storage Battery Company of Cleveland, Ohio, recommends the following tools and equipment:

- (1). 1 lead burning outfit.
- (2). Carboy of Sulphuric Acid for generating gas for lead burning outfit, and for making electrolyte.
- (3). Granulated Zinc for making Hydrogen Gas for lead burning outfit.
- (4). Burning rack for holding connecting strap and plates while burning.
- (5). 2 pairs Gas pliers for removing top connectors, taking out elements, etc.
- (6). Pair of flat nose pliers for removing jars and separators.
- (7). A plumber's or tinner's triangular scraper for scraping posts, lugs on plates, etc.
- (8). A putty knife for removing the sealing compound from between the top and inside covers; also the excess on top, around outside and between covers.
- (9). An 8-inch screw driver for removing compound, or a $\frac{1}{2}$ -inch wood chisel.
- (10). A ten-quart iron kettle for melting sealing compound.
- (11). A long handled ladle with extra large spout for pouring sealing compound.
- (12). Single burner gas stove for heating sealing compound.
- (13). A porcelain pitcher for handling and pouring sulphuric acid and electrolyte.
- (14). A 10-lb. bundle of lead and antimony burning bars for burning plates to connecting straps.
- (15). A 10-lb. bundle of pure lead burning bars for burning in top connectors.
- (16). Brace and $\frac{3}{4}$ -inch drill for drilling out top connectors and terminal posts.
- (17). Hydrometer Syringe for testing specific gravity of solution in battery cells.
- (18). Lead funnel for filling batteries.

(19). Aluminum nipple for holding tapered connectors while burning in cable. This is to prevent cable from becoming too hot. One end is tapered to fit positive, and one to fit negative terminal.

(20). Gas still for distilling water for refilling batteries and making electrolyte.

(21). Wire brush for cleaning off top of connectors after they are burned in.

(22). Wood form with holes to fit over posts while pressing down the top covers with a heavy weight.

(23). Sealing Compound.

(24). Dairy thermometer for measuring temperature of electrolyte.

(25). Hand punch for punching out connector straps where plate lugs have been broken off.

(26). Iron nipple made from a piece of gas pipe 1 inch long, reamed out with a tapered reamer so that large end fits over top of post which has been drilled off.

(27). Lead lined wooden tank for storing wood separators. Should also have a second tank for mixing electrolyte.

(28). Lead cup for soldering acid. (A glass bottle or jar will serve the purpose equally well, although more easily broken.)

In addition to these tools and equipment recommended by the above manufacturers, the following will be found very useful:

- (1). Gasoline torch.
- (2). Two-way burner if natural or ordinary illuminating gas is used for lead burning.
- (3). Screw drivers;
 - Two with 10-inch blades.
 - One with 8-inch blade ground rather narrow.
 - One with small 6-inch blade.
- (4). Several wood chisels, $\frac{1}{8}$ to $\frac{1}{2}$ -inch wide.
- (5). Piece of 1-inch angle iron about 8 inches long to place on top edge of battery when prying off the covers with screw drivers.
- (6). Several old stew pans to be used for boiling connectors in soda water to remove acid.
- (7). Coffee pot for heating and pouring compound.

(8). A number of pieces of wood $\frac{7}{8}$ -inch thick, $1\frac{1}{2}$ inches wide, and just long enough to fit between the handles of the various sized batteries.

(9). Metal stamps for stamping date, repairman's initials, and "+" and "-" or "P" and "N" on top connectors.

(10). Cans of asphaltum paint for painting battery boxes, work bench, etc.

(11). Plate press for straightening buckled plates, and for forcing bulged active material back into the grids. (See page 142.)

(12). Steam boiler and steaming box for softening sealing compound preparatory to opening battery. (See page 140.)

(13). Molds for making burning lead. (See page 146.)

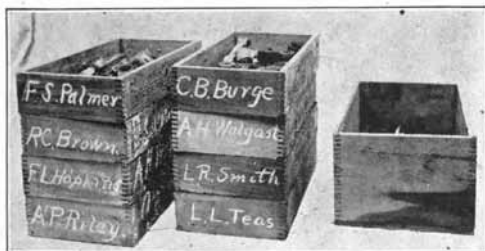

Fig. 75. Handy Boxes for Keeping Covers, Plugs, Connectors, Etc. The Smaller Boxes are Horseshoe Plug Tobacco Boxes

(14). Battery turntable, to be used when painting battery, burning on the top connectors, pouring compound, etc. (See page 144.)

(15). Two pairs bent nose pliers.

(16). A good pocket knife.

(17). Lead pencil, and chalk for marking batteries.

(18). Monkey wrench.

(19). Clean Rags.

(20). For convenience in keeping track of tops, stoppers, wells, connecting and terminals, you should procure a number of shallow boxes, as shown in figure 75. A card holder should be placed on one end. The name of owner of battery, also diagram of connections of battery and date letter or number are to be put on the card. With this card in holder, no mistakes are likely to occur. These boxes should be 12 inches long, 8 inches wide, and

4 inches deep. Gather up the long lead drillings and put in a box procured for this purpose, about 9 inches by 14 inches by 6 inches in size. Figure 75 shows both kinds of boxes. The boxes shown at the left may be used if you can get them, and card holder put on one end. The box shown at the right is for the lead scraps. If you have old battery cases the bottom portions of which are sound, these may be cut down and used for this purpose.

(21). The large Exide vehicle hydrometer, type V-2A, is a most excellent one for general use. It has a round bulb, straight barrel, with projections on the enlarged portion of the float which make the latter keep an upright position when taking readings of specific gravity. This eliminates the annoying sticking of the float to the sides of the barrel. This hydrometer may be obtained from the Electric Storage Battery Co.

The Battery Steamer.

The Battery Steamer is an apparatus for softening the sealing compound on starting and lighting batteries, by means of steam, so that the battery may be opened easily and quickly, and without the use of a gas flame or blow torch. It consists of only three parts, as shown in Figure 76:

1. The Steam Generator.
2. The Steaming Box.
3. The Water Supply Tank.

When a battery is to be opened, the connectors are first removed and the battery then placed in the Steaming Box and steam passed into the box for about half an hour. This makes the sealing compound so soft that it can be removed readily with the point of a screw driver, the entire operation of opening the battery being performed within five minutes after the battery is removed from the steaming box.

The Steam Generator, or Boiler, is made of heavy, galvanized iron, and furnishes the steam. Water enters the generator through the cover which is connected to the Water Supply tank by a rubber hose. The amount of water in the generator is always the same, and is regulated by the motion of a float. When the water reaches a height of about three inches, the float rises and

closes the valve through which the water enters. The generator is set on a gas, oil, or gasoline stove, and because of the small amount of water in it, steam is produced very quickly. As the water boils away, the float lowers, opens the valve, and allows more water to enter. Thus the level of the water is maintained constant as long as the supply in the tank lasts, and a continuous supply of steam is available in several minutes after the heat is applied to the bottom of the generator. For the average repair

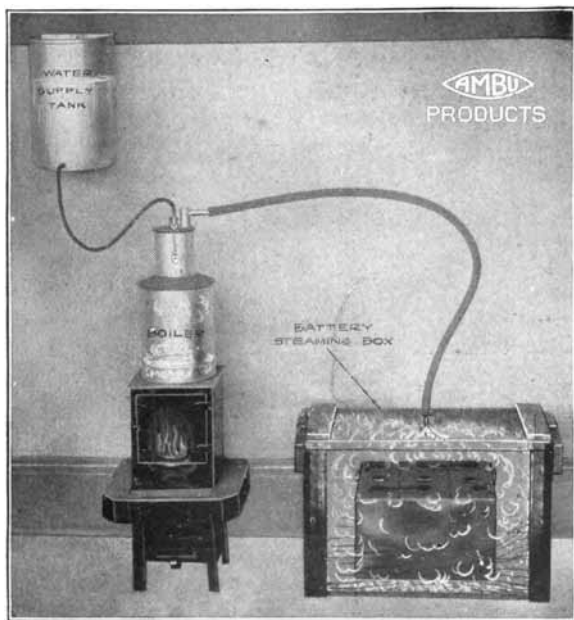

Fig. 76. Battery Steamer

shop, the supply tank need not be filled but once a day, and the entire apparatus requires absolutely no attention after the stove is once lighted.

The supply tank is also made of galvanized iron, and is connected to the generator by means of a small hose. It is placed a foot or two higher than the generator so that the water will flow into the latter by gravity. The steaming box is a stout wooden box, and is steam tight throughout. Steam is introduced

through a connection in the cover by a steam hose which leads to the generator. The box is made acid proof both inside and outside, so that it is not damaged if acid should be spilled on it accidentally. When the apparatus is assembled, the box is placed on the floor, or raised several inches above the floor. The batteries are placed in the box, the lid put on, and the repairman then does some other work for a half hour or so. At the end of this time the battery is lifted out, and the softened compound removed with the point of a screw driver. If it is desired to remove jars from an old case, the top, plates, and acid are removed, the jars washed out with a stream of water, and the box then placed in the steaming box for fifteen minutes. The jar can then be lifted out easily with two pairs of pliers.

To remove one jar, insert the end of the hose directly in the jar, and pack old rags or paper around the hose to hold the heat, or cut a board to fit the top of the jar, and drill a hole in it for the hose.

If there are any old covers, jars or battery boxes which have compound sticking to them, these may also be placed in the steaming box and the compound then removed easily with a putty knife. A further advantage of this apparatus is that the steaming loosens all dirt which may be on the battery box, so that it may be wiped off and make the battery look like new, if the wood is in good condition.

The Battery Plate Press.

Every battery repair shop must have some means of pressing plates, especially the negative plates. In "pressing" plates, transite boards of the proper thickness are placed in each space between successive plates, with two boards on the outside of the end plates. The group of plates is then put under pressure, either to straighten the plates, or to force the active materials back into the grid, flush with the surfaces of the grids. A large majority of negative plates require such pressing, as the most common fault with negative plates is the bulging out of the active material, thus causing a poor contact with the grids and consequently resulting in a loss of battery capacity.

Never put negative plates into service if the active material is bulged. Such plates will never give good service, and will cause the battery to be sluggish. Always press the active materials of such plates back into place. This will give the battery its approximate normal capacity, and will lengthen its life.

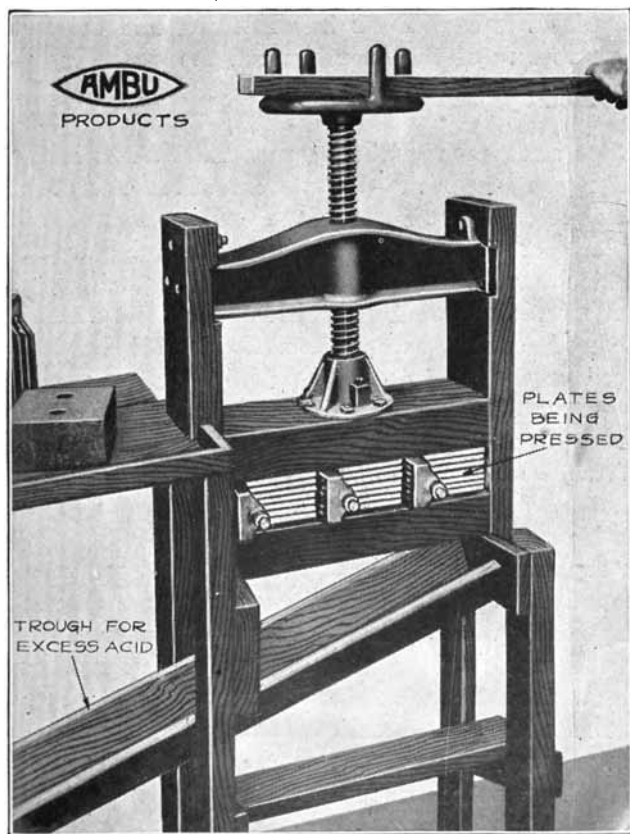

Fig. 77. Battery Plate Press

Many garagemen press battery plates in an ordinary bench vise. This is hard on the vise, as acid drops from the plates on the iron parts of the vise, which in time become badly corroded and rusted. Such a vise is weak, breaks easily, and grows very

stiff and hard to operate. The vise is therefore not well suited for this work because it is made of metal.

The Battery Plate Press, figure 77, is especially designed for pressing battery plates, and is so constructed that there is no metallic part which can be reached by acid dripping from the plates. A trough is so arranged that the acid which is squeezed from the plates is carried off into a drain, and there is consequently no rotting of the floor beneath the press by dripping acid, and no wet, acid covered floor to ruin your shoes and clothes.

A further advantage of the Battery Plate Press is that there are no iron parts near the plates from which bits of iron may fall on the plates. Iron is one of the greatest enemies of storage battery plates, as it ruins them in a short time. Figure 121 shows plates which have been disintegrated by impurities, probably iron, since iron is removed only with the greatest difficulty after it once comes in contact with a plate. Figure 124 shows negatives which need pressing.

Three groups of plates may be pressed at once in the Battery Plate Press, thus resulting in a considerable saving of time. Figure 77 shows clearly the construction of this press.

The Battery Turntable.

Every repairman knows that the most disagreeable feature of a battery is its weight. No one moves a battery about unnecessarily, especially when it is on the work bench. In cleaning, painting and repairing the case, however, it is necessary to get at all sides of the battery, and the battery must be turned around.

To eliminate the back-breaking lifting of the heavy battery, every repairman should have a battery turntable, as shown in figure 78. The turntable is made of two pieces of well seasoned hardwood, ten inches long, eight inches wide, and two inches thick. The illustrations shows the cast iron fittings which form the pivot bearing. Figure 79 shows how the battery is placed on the turntable. The battery can be turned around easily with one hand while cleaning, painting, or repairing the case. The turntable is not fastened to the work bench, and may be taken to the battery instead of bringing the battery to it.

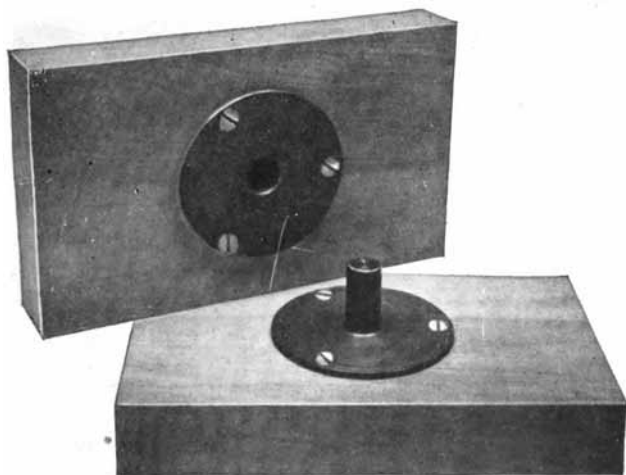

Fig. 78. Battery Turntable

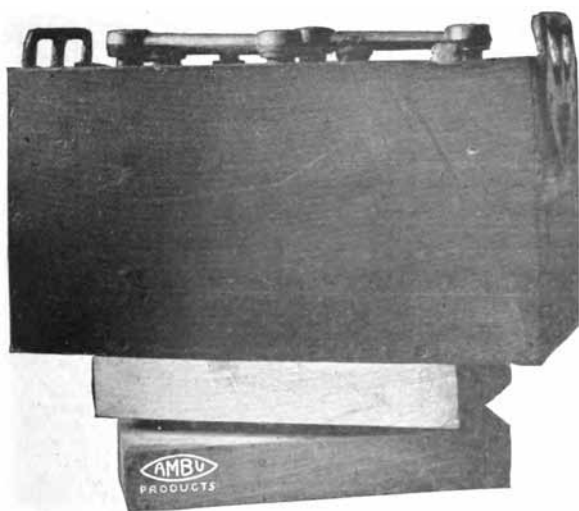

Fig. 79. Battery on Turntable

Every shop should have several of these convenient, time and labor saving turntables.

The Burning Lead Mold.

In every shop there is an accumulation of scrap lead from most drillings, old connecting straps, old plate straps, and old plates. These should be kept in a special box provided for that purpose, and when a sufficient amount has accumulated, the lead should be melted and run off into molds for making burning lead.

The Burning Lead Mold is designed to be used for this purpose. As shown in figure 80, the mold consists of a sheet iron form which has been pressed into six troughs or grooves into which the

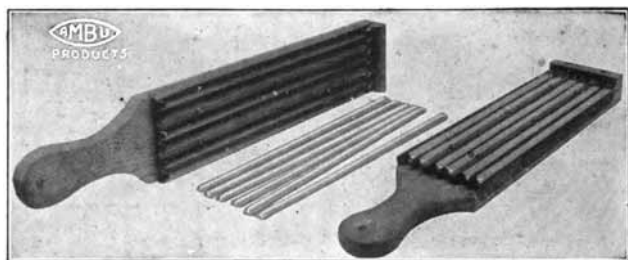

Fig. 80. Burning Lead Molds, Showing Lead Made in Them.

melted lead is poured. This sheet iron form is conveniently mounted on a block of wood which has a handle at one end, making it possible to hold the mold while hot without danger of being burned. A sheet of asbestos separates the iron form from the wood, thus protecting the wood from the heat of the melted lead. A hole is drilled in the end of the handle to permit the mold being hung on a nail when not in use. The grooves in the iron form will produce bars of burning lead 15 inches long, 5-16 inch thick, $\frac{3}{8}$ inch wide at the top, and $\frac{1}{4}$ inch wide at the bottom.

The advantage of this type of Burning Lead Mold over a cast iron mold is obvious. The form being made of sheet iron, heats up very quickly, and absorbs only a very small amount of heat from the melted lead. The cast-iron mold, on the other hand, takes so much heat from the melted lead that the latter

cools quickly and is hard to pour. Furthermore, this Burning Lead Mold is very light and convenient to handle, whereas the cast-iron mold is heavy and inconvenient.

In melting lead scrap, add a pinch of powdered sulphur and rosin to the melted lead to purify it. Stir the lead thoroughly, and skim off the surface dirt before pouring in the mold. Be careful not to heat the lead too hot after it has melted. If you add from 2 to 4 per cent antimony to the melted lead, the finished strips will melt more easily, and simplify the burning-in process.

Tagging Batteries.

Every battery concern has its system of marking and tagging batteries, usually a card system or books for making records of the work. Some of these systems are complicated and confusing. Make your system as simple as possible, but have it complete. Then stick to it, and keep it in an orderly, businesslike way. There are a few essential items that must be recorded correctly, or your whole system will be confusing and worthless. When a battery comes in, and before the driver or owner leaves, be sure that you have recorded the following information:

1. The owner's name, address, and telephone number if he has one.
2. What is to be done with the battery—charged, repaired, or rebuilt.
3. What the trouble with the battery is (dead cell, box eaten by acid, cracked jar, loose top connectors, broken sealing compound, etc.), and what caused it (trouble in starting, lighting or charging circuits; neglect on part of owner; driver left switch on, etc. See BATTERY TROUBLE CHARTS).

Fill out all these items on the tag, and attach the tag to the handle near the negative battery terminal. Then record the job in a book kept for that purpose, or save the tag as a record. A good plan is also to mark with chalk on the battery box what the trouble is and what is to be done, such as, I.D.C. for "one dead cell," R.S. for "reseal," R.B. for "rebuilt," etc.

You are now ready to make repairs, charge the battery or open and rebuild it, as the case may be.

Figure 81 shows the front and back side of a charging or repair tag. Figure 82 shows a set of pigeon holes for tags alphabetically arranged. The top row is for charging or repair tags for owners whose names begin with A to G. The next row is for rent tags for owners whose names begin with A to G. The third row is for charging or repair tags for owners whose names begin with H to N. The fourth row is for rent tags for owners whose

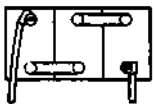
Any RECHARGED PAIRED SEALED BUILT
Battery

Itemized Cost

| | |
|-------------------|--------------|
| Recharging | Plates |
| Electrolyte | Jars |
| Separators | Case |
| Compound | Misc'l |
| Time | |
| Total | |

The Auto Battery Specialists

706 Phone
 Jackson St
 Topeka 810

Serial No. Date

Owner

Address

Serial No. Date

Owner

Address

Phone

Battery Type

Fig. 81. Two Sides of Repair Tag

names begin with H to N. The other rows are similarly arranged in pairs, one of a pair for charging or repair tags, and the other for rent tags. Unused tags should be kept on hooks near the pigeon holes, as shown in figure 82. The top edge of the rows for the rent tags should be painted the same color as the rent tags. You will notice that one side of the tag, figure 81, permits you to keep a correct account of material used, trouble with battery and what to do with it, and has a space for a battery diagram, so that you can place position of terminals and

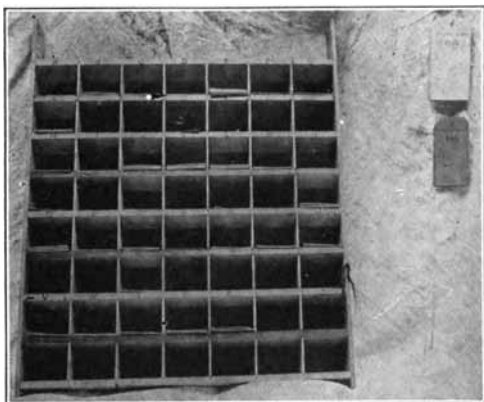

Fig. 82. Pigeon Holes for Tags

date mark on it. A sample drawing is shown on the tag. This tag is perforated across the center. The upper part is tied to the handle near the negative terminal, and the lower part is kept in the proper compartment of the set of pigeon holes shown in figure 82.

The Auto Battery Specialists

700 Jackson St. Topeka Phone 618

Rental Check No.
 Battery No.
 Date

Serial _____ Battery _____
 Name _____
 Address _____
 Out _____ In _____
 Time _____ Charges _____

Fig. 83. Rent Tag

Your rent tags should be green, red, blue, or some color different from the charging tag, figure 83. A good way to keep aluminum or lead rent tags is on 10 hooks. Tags 1, 11, 21, 31, etc., should go on hook No. 1; 2, 12, 22, 32, etc., on hook No. 2; 3, 13, 23, 33, etc., on hook No. 3. The last figure of a number goes on the corresponding hook number. If you use aluminum or lead tags, you are almost compelled to have a registering book to keep track of the numbers, unless you have them in pairs, two of a kind, and hang on racks as above. Another plan is to have one set of numbered aluminum or lead tags, and attach a tag on each battery. Then

number the paper tags shown in figures 81 and 83, and put these in the pigeon holes shown in figure 82.

Precautions to be Taken by the Repairman.

(From bulletin of the Associated Edison Illuminating Companies.)

1. Do not work on an empty stomach—you can then absorb lead easily.
2. Keep your fingers out of your mouth when at work.
3. Keep your finger nails short and clean.
4. Do not chew tobacco while at work. In handling tobacco, the lead oxides are carried to your mouth. Chewing tobacco does not prevent you from swallowing lead.
5. When you leave the shop at night, and before eating, wash your face, hands, and arms with soap, and clean your nose, mouth, and finger nails.
6. Do not eat in the repair shop.
7. Drink plenty of good milk. It prevents lead poisoning.
8. Use Epsom Salts when constipated. This is very important.
9. Bathe frequently to prevent lead poisoning.
10. Leave your working clothes in the shop.
11. It is better not to wear a beard or mustache. Keep your hair covered with a cap.
12. Before sweeping the shop, dampen the floor to keep down the dust.
13. Do not drink beer or whiskey, or any other alcoholic liquors. These weaken your system and make you more susceptible to lead poisoning.
14. In handling lead, wear gloves as much as possible, and wash and dry the gloves every day that you wear them.
15. Wear goggles to keep lead and acid out of your eyes.
16. When melting lead in a hydrogen flame, as in burning on the top connectors, the fumes given off may be blown away by a stream of air. The air supply to the flame may be tapped for this purpose.
17. The symptoms of lead poisoning are: gums darken or become blue, indigestion, colic, constipation, loss of appetite, muscular pains. In the later stages there is muscular weakness and paralysis. The hands become limp and useless.
18. Wear rubber shoes or boots. Leather shoes should be

Painted with a hot mixture of equal parts of paraffine and bees-wax.

19. Wear woolen clothes if possible. Cotton clothing should be dipped in a strong solution of washing soda, and dried. Wear a flannel apron covered with sacking.

20. Keep a bottle of strong ammonia handy. If you should spill acid on your clothes, apply some of the ammonia immediately to neutralize the acid, which will otherwise burn a hole in your clothes.

21. Keep a stone, earthenware, or porcelain jar filled with a solution of washing soda or bicarbonate of soda. Rinse your hands in this solution occasionally to prevent the acid from irritating them.

22. If you should splash acid in your eye, wash it out immediately with warm water, and drop olive oil on the eye. If you have no olive oil at hand, do not wait to get some, but use any lubricating oil, or vaseline.

Lead Burning.

“Lead Burning,” so called, refers to the melting together of plates and straps, or posts and top connectors and terminals. There are three general methods used:

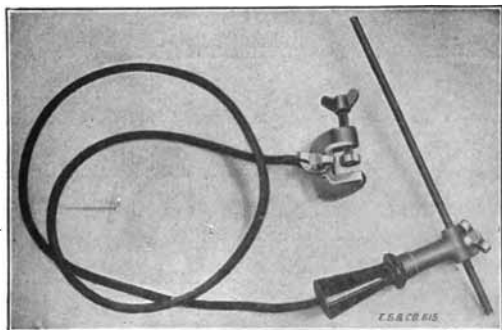

Fig. 84. Carbon Lead Burning Outfit

1. **Soldering Irons.** These are inconvenient, and should not be used unless a gas outfit is not available. A description of this method is given later, beginning on page 244.

2. The Electric Arc. This is a very simple method, and requires only a spare 6 volt battery, a $\frac{1}{4}$ inch carbon rod, carbon holder, cable, and clamp for attaching to battery. This outfit is shown in Figure 84. It may be bought from the Electric Storage Battery Co., of Philadelphia.

In using this outfit, one terminal of an extra 6 volt battery is connected by a piece of cable with the connectors to be burned. The contact between cable and connector should be clean and tight. The cable which is attached to the carbon rod is then connected to the other terminal of the extra battery, if the battery is not fully charged, or to the connector on the next cell if the battery is fully charged. The number of cells used should be such that the carbon is heated to at least a bright cherry red color when it is touching the joint which is to be burned together.

Sharpen the carbon to a pencil point, and adjust its position so that it projects from the holder about one inch. Occasionally plunge the holder and hot carbon in a pail of water to prevent carbon from overheating. After a short time, a scale will form on the surface of the carbon, and this should be scraped off with a knife or file.

In burning in a connector, first melt the lead of the post and connector before adding the burning lead. Keep the carbon point moving over all parts to be joined, in order to insure a perfectly welded joint. The directions beginning page 239 for lead burning with the hydrogen flame may also be used for the carbon.

3. Gas flame. A number of outfits are used. These are described below:

(a) Oxygen and Hydrogen gases under pressure in separate tanks. These gases are sent through a mixing valve, where the proper proportions of the two gases are obtained. This is probably the most satisfactory and convenient of all methods, but it is not always possible to obtain the gas. The simplicity of this set is shown in Figure 85.

(b) Hydrogen and air under pressure in separate tanks. This set is fully as simple as the Oxygen-Hydrogen, is cheaper, and is more easily obtained than the Oxygen-Hydrogen.

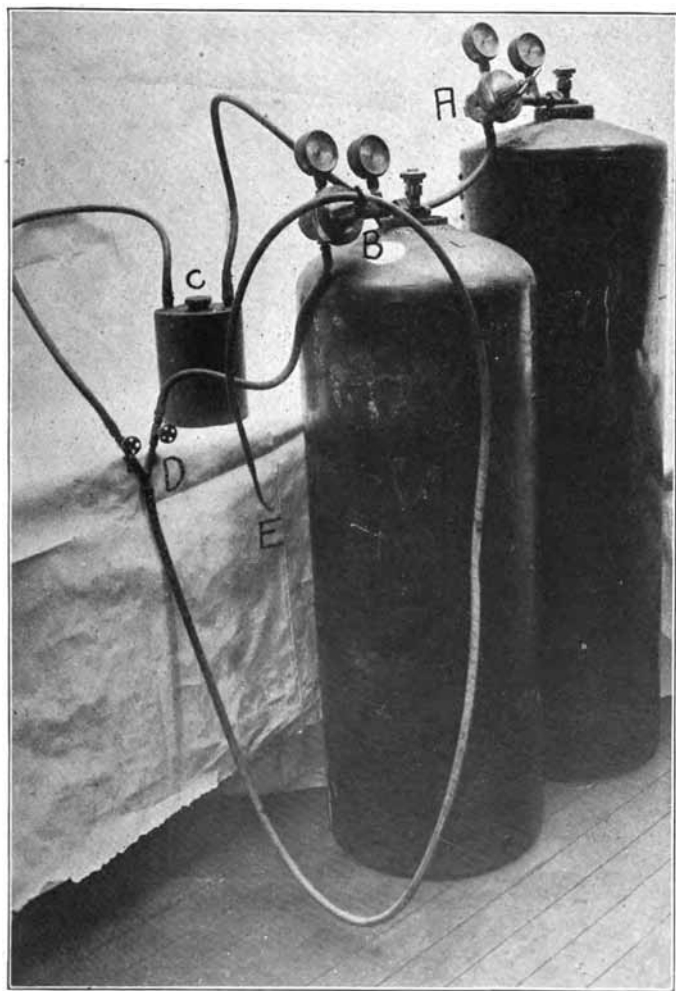

Fig. 85. Hydrogen-Oxygen Lead Burning Outfit. A and B are Regulating Valves. C is the Safety Flash Back Tank. D is the Mixing Valve. E is the Burning Tip

(c) The Prestolite Company of Indianapolis sells a lead burning outfit which uses Prestolite gas and oxygen under pressure.

(d) The Electric Storage Battery Company of Philadelphia sells a Hydrogen-Air set which includes a gas generator. The parts of the outfit are as follows:

- 1 Gas generator.
- 1 Wash bottle.
- 1 Branch pipe.
- 2 Rubber stoppers.
- 1 Air pump and air tank combined.
- 1 Finger pipe, and set of tips.
- 1 50-ft length of 5-16 inch rubber tubing.
- 1 2-ft. length of $\frac{3}{4}$ inch rubber tubing.
- 1 Triangular scraper.

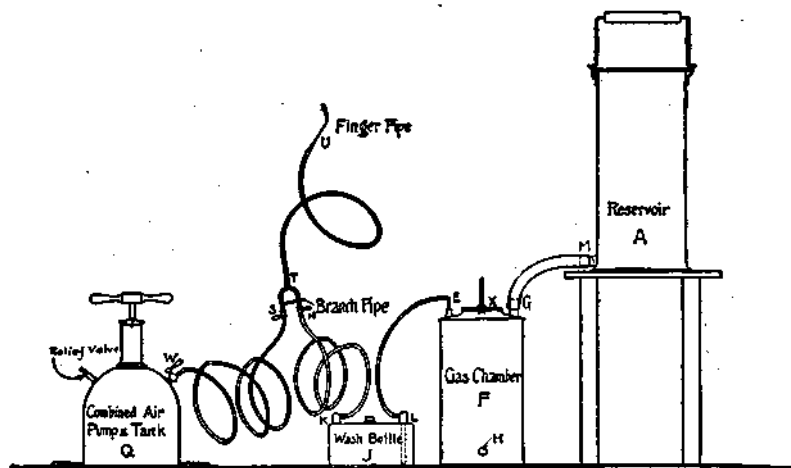

Fig. 86. Hydrogen Generating Outfit

Three sizes, F, E, and D, are made. The materials used for generating the gas are Granulated Zinc, Water, and Sulphuric acid. The arrangement of parts is shown in Figure 86.

(e) Figure 87 shows a similar gas generating and lead burning set.

(f) Ordinary illuminating gas (coal gas) may be used. A

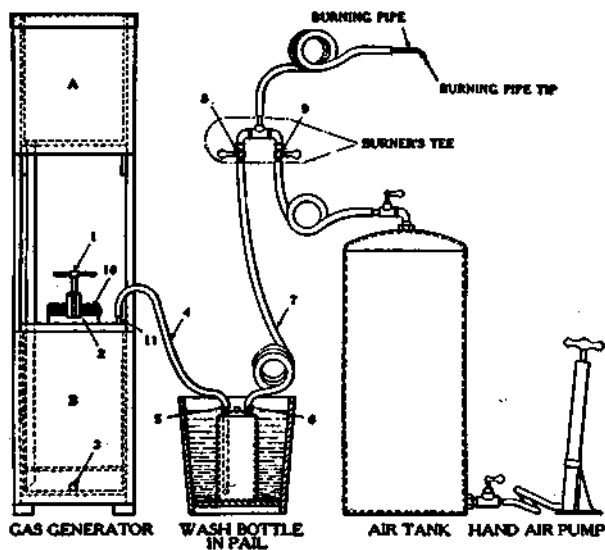

Fig. 87

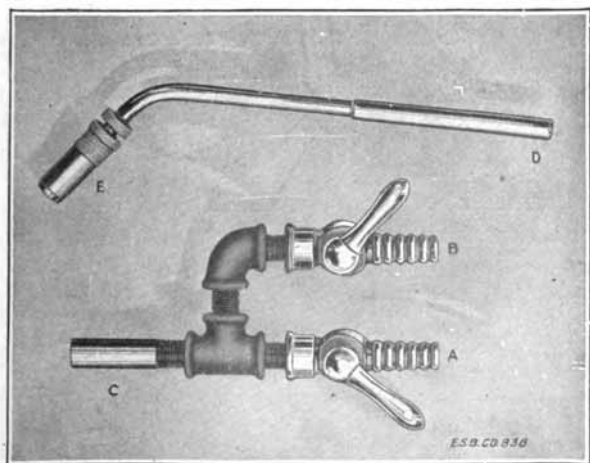

Fig. 88. Illuminating Gas Valve and Burning Tip

special tip and mixing valve are necessary. The burner and valve are shown in Figure 88. This set may be bought from the Electric Storage Battery Co. Enough 5-16 inch rubber tubing should be provided to make the connections. The hose should be fastened with wire or clamps to the nipples to prevent leaks.

The air should have a pressure of from 5 to 10 pounds, depending on the length of hose, and the size of flame desired. In using air from a tire air compressor, a reducing valve is necessary for reducing the pressure. Referring to Figure 88, connect the air hose at A, the gas hose at B, and the hose leading to the burning tip at C and D. This hose should not be more than five or six feet long.

In using, close the air valve A, and turn the gas valve B, on full. Light the gas at the burning tip, and then turn on the air. The air pressure should not be high enough to blow out the flame.

When the gas is turned on full, the flame will look ragged, and will "show a waist," or become narrow about $\frac{1}{2}$ inch from the burning tip, and will then spread out. Do not use such a flame for burning.

Turn the gas off slowly until the outer portion of the flame at the waist breaks and spreads, with an inner tongue of flame issuing through the outer ring. The flame will now have a greenish color, and is suitable for burning.

If the gas is turned off further, or too much air is turned on, the flame will become blue and then invisible. It is not suitable for burning.

When the flame is properly adjusted, the hottest part is just beyond the end of the inner point. The burning tip should not be held too close to the work when burning, as the flame becomes cooler near the burning tip.

The burning tip has a sleeve and lock nut. The position of the sleeve should be adjusted so as to give the best flame.

(g) A tank of illuminating gas, either natural or manufactured, and a tank of oxygen may also be used. This is a simple method. Full information may be obtained from the Electric Storage Battery Co. of Philadelphia, Pa.

When tank gas or air is used, an automatic pressure valve must be inserted in each line so as to regulate the pressure at any point. Tank hydrogen must have, in addition, a safety flash back water tank inserted in the line, as shown in Figure 85.

Saving the Sediment.

Many batterymen throw away the sediment which they wash from battery jars. This sediment is often called "lead mud," and should be saved and sold to junkmen. Figure 89 shows a

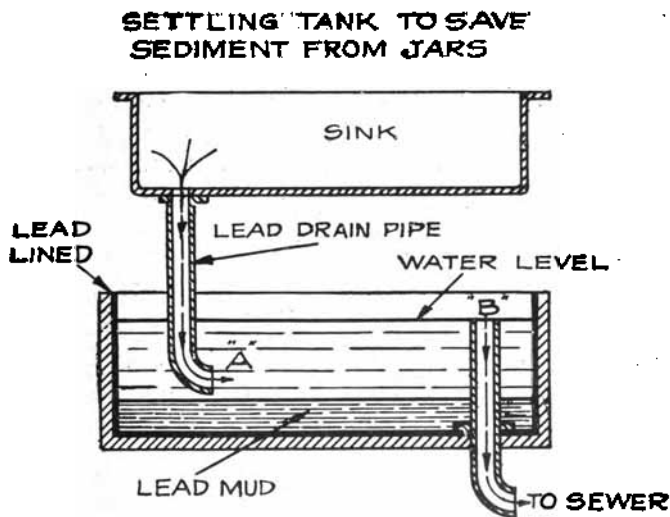

Fig. 89

scheme for collecting the sediment. Run the drain pipe from the sink at which the jars are washed out to a lead lined box as shown. The water and sediment enter at A. The sediment settles to the bottom of the box, while the water escapes to the sewer at B. The lead mud may be cleaned out periodically.

The lead lined box is best to use, but is somewhat expensive. If the inside of the box is given two coats of very hot asphaltum paint, it will be fairly well protected from the action of acid.

The box may be placed wherever convenient. One batteryman uses an old enameled bathtub as a settling tank.

Mixing Electrolyte.

The simplest scheme for handling electrolyte is to have only the 10-gallon carboys of 1.400 specific gravity acid, and the bottles of distilled water on hand, and mixing the electrolyte for each

A CHEAP METHOD OF DRAWING ACID FROM CARBOY

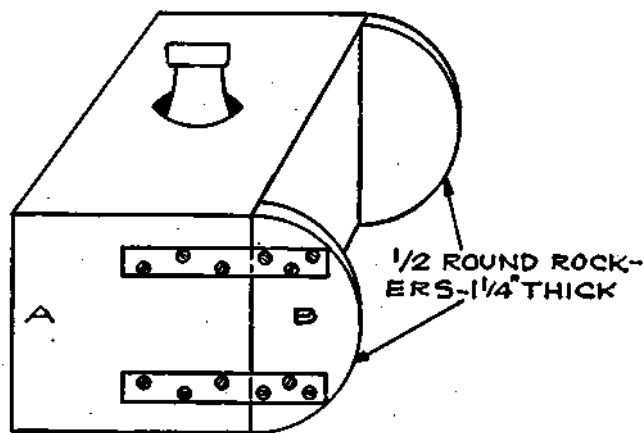

Fig. 90

particular battery. Pour some water into an earthenware or porcelain pitcher or jar, and then add the acid very slowly until the desired specific gravity is obtained. Never add water to acid, as an explosion might result which would injure you. Stir the mixture thoroughly as you add the acid.

Figures 90, 91 and 92 show three methods of handling acid or distilled water. Figure 90 shows the simplest method. Cut two half round pieces of wood, using a radius which is half the height of the wooden case in which the bottle is placed. Screw

these on the side of the case. These will act as rockers for tipping the bottle when emptying.

Figure 91 shows a simple siphon arrangement. A is the container, B a rubber stopper, C and D glass or lead tubes, E a rubber tube having a pinch clamp at the lower end. To use, the stopper and tubes are inserted in the bottle, and air blown in at C while the pinch clamp is open, until the tube E is full. The pinch clamp is then released. Whenever the liquid is to be drawn from the bottle, the pinch clamp is pressed, so as to release the pressure on the tube. The liquid will flow automatically down the tube E as long as the clamp is open. To stop the flow release the clamp.

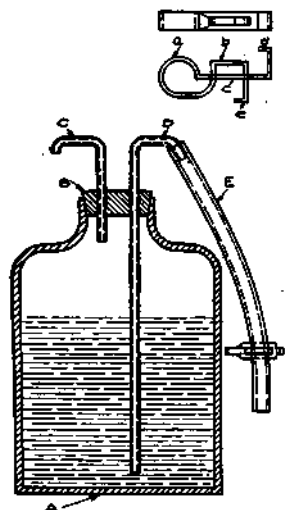

SIPHON FOR DRAWING ACID FROM CARBON

Fig. 91

The clamp may be made of flat or round spring brass or bronze. This is bent round at (a). At (c) an opening is made through which the part (b) is bent. The clamp is operated by pressing

at (d) and (e). The rubber tube is passed through the opening between (b) and (c).

Figure 92 shows a similar arrangement, except that an air foot pump is used to force out the liquid. To operate, the finger is placed over the opening at D and the pressure is applied. The liquid will flow out as long as the pressure is applied and the finger held at D. To stop the flow, the finger is lifted, thus releasing the pressure.

The following table shows the number of parts of distilled water to one part of 1.400 specific gravity electrolyte to prepare electrolyte of various specific gravities. The specific gravity of the mixture must be taken when the temperature of the mixture is 70° F. If its temperature varies more than 5 degrees above or below 70° F, make the corrections described on page 85 to find what the specific gravity would be if the temperature were 70° F.

BY WEIGHT.

For 1.300 specific gravity use 5 ounces of distilled water for each pound of 1.400 electrolyte.

For 1.280 specific gravity use $6\frac{1}{2}$ ounces of distilled water for each pound of 1.400 electrolyte.

**COMPRESSED AIR SYPHON PUMP
FOR EMPTYING ELECTROLYTE CARBOYS**

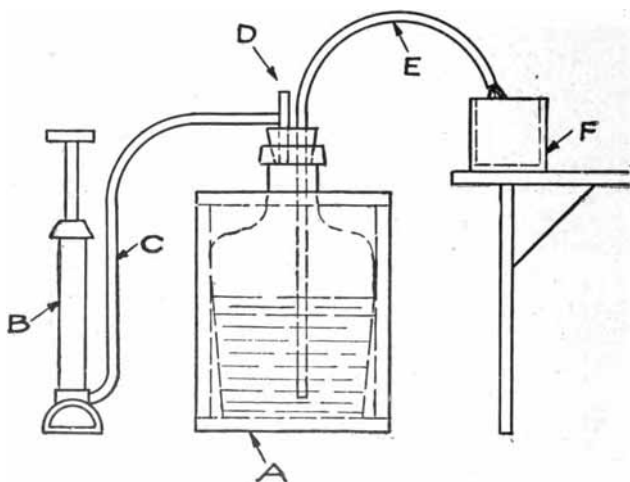

Fig. 92

For 1.275 specific gravity use $6\frac{1}{2}$ ounces distilled water for each pound of 1.400 electrolyte.

For 1.260 specific gravity use $7\frac{1}{2}$ ounces distilled water for each pound of 1.400 electrolyte.

BY VOLUME.

For 1.300 specific gravity use $3\frac{1}{2}$ pints distilled water for each gallon of 1.400 electrolyte.

For 1.280 specific gravity use $4\frac{1}{2}$ pints distilled water for each gallon of 1.400 electrolyte.

For 1.275 specific gravity use 5 pints distilled water for each gallon of 1.400 electrolyte.

For 1.260 specific gravity use $5\frac{1}{4}$ pints distilled water for each gallon of 1.400 electrolyte.

In case you wish to use other measuring units than those given in the above table, this table may be written as follows, giving the number of parts distilled water to 10 parts of 1.400 specific gravity electrolyte:

| Specific Gravity Desired | Parts by Weight | Parts by Volume |
|-----------------------------|--------------------|--------------------|
| 1.300..... | 3 | $4\frac{1}{4}$ |
| 1.280..... | 4 | $5\frac{1}{2}$ |
| 1.275..... | 4 | 6 |
| 1.260..... | 4 7-10 | $6\frac{1}{2}$ |

The next table gives the number of parts of distilled water to 10 parts of concentrated sulphuric acid (which has a specific gravity of 1.835) to prepare electrolyte of various specific gravities:

| Specific Gravity Desired | Parts by Weight | Parts by Volume |
|-----------------------------|-----------------------|--------------------|
| 1.400..... | $8\frac{1}{2}$ | 15 8-10 |
| 1.300..... | $13\frac{1}{2}$ | 25 |
| 1.280..... | 15 | 27 |
| 1.275..... | 16 | 28 |
| 1.260..... | 17 | 30 |

CHAPTER 15.

ANALYSIS OF THE CONDITION OF THE BATTERY.

What is the Trouble?

With some batterymen it is a case of "blind leading the blind," when a man brings his car to the shop. Generally the car owner only knows that his lights are dim, or his starting motor will not crank the engine; he does not know what is wrong, and usually does not care particularly. He wants you to make his lights and starter work properly, and the sooner you do it, the better satisfied he will be, and the greater the probability of his coming back to you the next time he has trouble.

"What is the Trouble?" That is what you must determine at once, and tell the car owner how soon he may again have his car. He may have a long tale of woe and may think he knows just what is wrong and what must be done, and say that he merely brought the car to you because he lacks the proper tools and equipment. If you go ahead on the strength of what the car owner tells you, unless you are well acquainted with him and know that he has a better knowledge of electricity than you have and has made a thorough study of his car, you are in the position of one blind man being led by another. You will have a vague feeling of uneasiness and dissatisfaction with yourself which you cannot analyze. You will most likely feel ashamed of yourself and be very apt to do a very poor job of putting the car in good shape. You started by not using your head or doing your own thinking, and you very likely will not do any thinking on the whole job. You will feel that the car owner is your superior, and that you must do just what he said the car needed.

If you run your battery repair business on such a basis, you are bound to be a flat failure. For the sake of your success, self-satisfaction and peace of mind, do not let the car owner be the

master of the situation. You have a head on your shoulders which you should use. You are the expert, and it is up to you to make a quick, accurate analysis of the situation and decide what the remedy is. You would not think of going to a doctor when you feel ill and telling him you have such and such a trouble, that you wanted a certain medicine to cure it, and that you were merely coming to him because you needed his official prescription in order to get the medicine at the drug store. If any doctor allowed you to do this, you would have a feeling of dissatisfaction with him because he allowed you to make the diagnosis when, because of his special training and experience, he should be able to make it himself, and do it better and more quickly. You like to have him listen to what you think is wrong with yourself, but not to be guided entirely by your opinions. If he does not examine you himself, and ask you questions that show he is analyzing your condition carefully, you will go away dissatisfied, and your anxiety about your pains will not be relieved. Most likely, you will go to another doctor who will not let your talk influence him too much in his diagnosis and prescription.

When a car is brought to your shop, you are the doctor. Some part of the mechanism is in trouble, and it is your duty to put yourself in charge of the situation. Examine and test the battery carefully. Listen to what the driver or car owner has to say. It will probably give you a clue to the trouble. Question him so as to establish certain points in your mind. Then decide for yourself what must be done, and tell the man who brought the car or battery what repairs you consider necessary, regardless of whether he thinks you are right or not. If he disagrees, explain to him clearly and courteously what you think must be done, and if you show that you have been careful in your analysis, he will think more of you for insisting on certain repairs.

It is just as disastrous if you go too far in doing your own thinking. If you have any hopes of being successful in your business, do not assume such air of superiority that says, "I know it all," and shows a contempt for the knowledge of the owner or driver. If you are told that the lights won't work, turn on the lighting switch to see if they will. If the driver says that the

starter won't crank the engine, try it. Listen attentively and courteously to what the driver has to say. Disregarding his story entirely will most likely make him angry, and he may never return to your shop.

What the owner wants to know is how much the repairs will cost, and when he can have his car again. The following directions will enable you to decide what must be done. Estimate carefully, if possible, what the work will cost. If a considerable amount of work is required, and you cannot tell how much time and material will be needed, tell the owner you will let him know the approximate cost later, when you have gone far enough to be able to make an estimate.

If the owner cannot leave his car, take off the battery and put a "renter" in its place until the repairs are completed.

The first thing to do, therefore, when a car comes to your shop is to greet the driver courteously and ask him what the trouble seems to be. He certainly has noticed that something is wrong with the electrical system of his car, or he would not have brought the car to you. Generally the driver complains that his lights burn dimly, or that the motor will not start his engine, or else turns the engine over very slowly. Dim lights usually come first, that is, a battery which will not give bright lights will operate the starter satisfactorily. A drop in battery voltage which will give dim lights may not cause failure to start. The immediate trouble which caused the owner to send the car to you may, of course, be due to one or more conditions which you can discover by merely making an inspection of the battery, or which may be more difficult to determine. It is best, therefore, to go at each car in the same way, making the same tests and inspections, but always bearing in mind the trouble which the driver has described. You will be able to analyze the conditions you find more clearly. If, for instance, there is starter trouble, and you find that there is a loose connector between two cells, you will know, when you find the loose connector, that you have probably discovered the cause of the trouble. Do not, however, be satisfied with merely reburning the joints between the connectors and the posts. Make other tests to determine what the exact condition

of the battery is in other respects. One trouble very often leads to others, and curing the one will not eliminate the others.

If trouble exists and the battery is badly discharged, tell the owner he has an abnormal condition or trouble some place on his car, and that his battery will have to be taken off his car, and a renter put in its place while his is being charged, repaired or rebuilt, as the case may be, and that the trouble or abnormal condition must be removed or his battery will run down again in a short time. It is your business to get the job; do it in as agreeable a manner as possible. If you have good reasons to believe it is some trivial trouble, fix it as quickly as possible in a workmanlike manner. If it proves to be anything serious that will take considerable time, make an appointment with the man to have him leave his car, and when he leaves it, locate the direct cause of trouble, repair it as quickly as possible, in a conscientious, workmanlike manner, so that it will stay fixed and give satisfactory service. Your business will grow just in proportion as you give satisfactory service. Satisfy every customer and give him a square deal. The public is not slow in locating and patronizing this kind of repair shop.

You must have a standard method of procedure. It is the only way to avoid the haphazard, hit-or-miss habits of an inferior repairman. Go through the steps described below, and you will soon have the business-getting, profit-making habits which you need in order to be successful.

The Standard procedure is as follows:

1. Ask the driver or owner why he brought the car to your shop. Remember what he says when you take the remaining steps.

2. Open the battery box and make a general inspection.

(a) **Is the battery covered with dust and dirt?** Brush off the coarser dirt with an old whisk broom. Then take a rag wet with ammonia or solution of soda and wipe all parts clean.

(b) **Are the cables tight?** Feel each connection at the positive and negative terminals. If any are loose, tighten them. See that no cable is partly broken through, especially at the end of the terminal. See that cables are well insulated.

(c) **Are the top connectors tight?** Feel each connector. If

one or more are loose, you must take battery from the car and reburn the connector.

(d) **Is there corrosion at the battery terminals?** This is indicated by a green deposit, especially at the positive terminal. Scrape deposit off with a knife, and remove cable if possible. Clean contact surfaces on cable terminal and post with fine sandpaper. If corrosion has proceeded so far that you cannot remove the cable, use cable tongs, bore off the terminal connection, and soak in boiling soda water for a few minutes. The cable can then be removed easily, and the connector will be clean.

(e) **Are all the connections clean?** Remove cables and if there is any dirt on contact surfaces, soak in boiling soda water or clean with knife or fine sandpaper.

(f) **Is the battery loose in the box?** If so, put in new hold down bolts. A loose battery will cause broken jars, spilled electrolyte (causing corrosion at terminals, short-circuits, rotted box, rotted case, low gravity, low liquid in cells), and loose cables.

Always examine closely the battery box on car. See if it is hung loosely, or not properly braced, or no hold downs attached, or if loose in the box, or if the terminal cables jump around with vibration of car. The trouble may be due to any one of the above causes. Never put a battery on a car without noticing carefully all the above possible conditions and if any exist call the car owner's attention to them and ask him if he wants them fixed; fix them right and charge him for the time and material used. Always have a supply of hold down bolts, $\frac{1}{4}$ or 5-16 inch on hand of two lengths, 11 inches and $12\frac{1}{2}$ inches; also have good heavy spring washers and winged nuts for same.

It is a fact that a battery should be firmly fastened down; do not overdo it, however, by screwing the hold downs so tight as to pull off the handles or break the sealing on end of case, but it must be **firmly clamped down**, and the box or hanger the battery is in **must** be solidly fastened to the car, and have no perceptible vibration other than the movement of the car. For repairing handles that have pulled off, see page 225.

(g) **Is any of the sealing compound on top of the cells broken at the posts, filling vent, or around the edges?** See Trouble Chart, No. 7, page 176. This will cause the battery to be a "slopper," one

in which electrolyte is thrown out through the cracks in the compound by the jolting of the car on the road. If so, remove battery from car and open it. See page 187.

(h) Are the ends of battery bulged out? If so, the battery has been frozen. See Trouble Chart No. 11, page 178. Remove battery from car and open it. See page 187.

(i) Is the battery case, or metal box, rotted and eaten through? See Trouble Chart No. 8, page 177. If condition of box is very bad, remove battery from car and open it. See page 187.

3. Read the date marks on the battery. If you cannot find them, ask the driver how long the battery has been on the car. If he says it has been in use for fifteen months or more, the battery is probably worn out, and needs new plates. Open the battery. See page 187. If battery has been in use only a short time, or less than a year, try to find out if battery was new when installed on car. It may have been a second hand battery in the first place, and may now be old enough to need new plates.

If battery looks new, proceed with remainder examination.

4. Remove filling vents and inspect level of electrolyte. If electrolyte is below tops of plates in any cell, fill with distilled water. See Trouble Chart No. 3, page 174. If it requires a considerable amount of water to fill any cell, that cell has been injured in proportion to the length of time the electrolyte has been below the tops of the plates.

Ask the driver when water was last added. If more than a month has since passed, remove battery from car and give charge for sulphated battery. See page 184. If the electrolyte level sinks below tops of plates soon after filling with water, the jar is cracked. In this case remove battery from car and open it. See page 187.

If it is necessary to add only a normal amount of water, battery may be charged on car by running engine for several hours, or battery may be charged in shop at the charging bench.

5. Turn on the lighting switch or switches. Measure the voltage of each cell. Each cell should have a voltage of 2 or more. If any cell shows no voltage, that cell is "dead." Remove battery from car and open it. See page 187. See also Trouble Chart No. 1, page 172, and No. 12, page 178. If all cells

show from 1.8 to 2 volts, remove battery from car and give it a normal charge. See page 183.

6. **Close the starting switch**, and if battery will not crank motor while switch is closed, measure the voltage of the whole battery. If this drops to a very low value, say 1 volt per cell, make sure that there is no trouble outside of the battery. If there is none, remove battery from car and charge it. See page 183. Instead of measuring the voltage you may turn on the lamps before closing the starting switch. If the lights then become very dim when the switch is closed remove the battery and put it on charge, unless it is in a bad condition. It should then be opened.

7. **Measure the specific gravity of each cell**. Make a record of the readings for use later. See page 79, and Trouble Charts 1 and 2, pages 172 and 174. If you have added water to bring the level of the electrolyte above the plate tops, do not measure the specific gravity unless you have, in the meantime, run the engine till the cells have been gassing freely. The meaning of the various values of specific gravity are:

1.300 to 1.250—Fully charged.

1.250 to 1.200—More than half charged.

1.200 to 1.150—Less than half charged.

—Run engine several hours to charge

1.150 or less—Completely discharged.

—Remove battery from car. See page 187.

Note:—It sometimes happens that gravity readings of 1.200 or over are obtained, and the voltage is high, and yet the lights are dim and the starter will not crank the engine. This shows that acid has been added instead of water. Remove battery from car and open it, as battery has probably been damaged internally. See page 187.

8. **There may be other symptoms of trouble such as:—**

(a) **Battery overheats while car is running.** See Trouble Chart No. 4, page 175. Electrolyte is below surface of plates, or generator is delivering too much charging current. Battery may also be located near a hot place such as the exhaust pipe. Look for low electrolyte (See 4, above); measure charging current with ammeter; if battery is near a hot place, change its location.

(b) Battery runs down quickly on car after being charged. Generator not delivering charging current, or too small a current. There may be short circuits or grounds in wiring which cause a continuous discharge. Use the AMBU Trouble Shooter. See Trouble Chart No. 10, page 177.

(c) Battery will not take a charge. See Trouble Chart No. 6, page 176, and No. 5, page 176. Look for loose connections. If none are found, remove battery from car and open it. See page 187.

(d) Specific gravity low even though generator is delivering the proper charge. May not be enough acid in the electrolyte. If specific gravity will not rise after long continued charge, remove water and add 1.400 specific gravity electrolyte, so as to bring specific gravity of each cell up to 1.275-1.300.

(e) Lights on one side of car burn dim, and on other bright. This occurs when a three wire lighting system is used with a 12 volt battery. It indicates that one side of the battery is carrying a heavier load than the other. Change wiring so that same current is drawn from each half of battery. Remove battery from car and give it a normal charge. See page 183.

(f) Battery run down after storage. Remove and give battery a long charge, as for sulphated battery. See page 184. It may be impossible to put any life into the battery, on account of badly sulphated or disintegrated plates.

9. In order to do the best work and build up a reputation for thoroughness, test the lighting system and the generator, with all the wiring. Your battery trouble may be due to some fault in other parts of the starting and lighting system, and unless you find this trouble, it is of little use to put the battery in shape, as the same trouble will soon return. For such testing you should have an "AMBU" Trouble Shooter, which quickly and accurately locates troubles in the starting and lighting system of all American made cars.

10. The action of the cutout relay in opening or closing the charging circuit must be correct. This should always be checked according to the directions given below:

The cutout should close the circuit between the battery and dynamo as soon as the voltage of the dynamo is sufficiently above that of the battery to cause a charging current to flow from the

dynamo to the battery. The action of the cutout may be tested as follows:

First turn off all the lamps; make sure that the specific gravity of each cell of the battery is at least 1.250 and that the dynamo is giving its normal output. If the battery is run down, it must be charged, or a "rener" put in its place. That means that an Ambu test for Engine Running, Lamps Off, should give an "N" reading. Have the Ambu ammeter attached at the battery as for the regular Ambu tests. With the engine running, gradually close the throttle until the engine runs slow enough to allow the cutout to remain open. When the cutout is open, the ammeter pointer will be over the "O" line. Now gradually increase the engine speed and watch the ammeter pointer. At some speed between 5 and 15 miles per hour, the pointer will swing to the right or left of the "O" line, showing that the cutout has closed.

If the pointer first swings to the left of the "O" line and then with increasing engine speed moves to the right of the "O" line, the cutout is closing too soon. This condition may be remedied by increasing the air gap between the movable cutout arm and the electromagnet, or by increasing the spring tension. Increasing the spring tension will also cause the cutout to open at a higher engine speed than before, and in making this adjustment care should be taken that the action of the cutout in opening is as described below.

If the pointer first swings to the right of the "O" line, the contacts are not closing at too low a speed, but may still be closing at too high an engine speed. Bring the engine to its lowest speed and then gradually open the throttle. When the pointer moves to the right of the "O" line, hold the engine speed constant at that point for an instant. Then with a further increase of engine speed, the pointer should move farther away from the "O" line. Increase the engine speed until the charging current stops rising. Note if this maximum is correct. If not, use the Ambu trouble shooter. If the pointer moves so as to indicate the normal charging current as soon as the cutout closes, or if only two or three amperes more charging current are obtained with increased engine speed, it indicates that the cutout is closing at too high a speed. This condition may be remedied by

either decreasing the air gap or decreasing the spring tension. In decreasing the spring tension, check the action of the cutout in opening, as described below, in order that the discharge current necessary to allow the spring to open the cutout may not be too great.

Check the action of the cutout in opening; start with the cutout closed and then gradually decrease the engine speed. The pointer will move toward the "O" line and then will move to the left of this line. The amount of the motion to the left should not exceed two or three amperes and the pointer should remain on this side of the line for only a very brief instant and should then return to the "O" line, showing that the cutout has opened. If the cutout opens before the pointer passes to the left of the "O" line, the spring tension should be decreased. If the pointer moves to the left of the "O" line so as to indicate a discharge current of more than 4 amperes, or if the pointer remains on the left of the "O" line for more than an instant, the spring tension should be increased.

It sometimes happens that a cutout will not open as the engine is stopped and such a condition should be remedied at once by making the contact points clean and smooth, and by increasing the spring tension. When the cutout acts in this way and the condition is not remedied, the battery will discharge into the generator until it is run down. Such a condition often exists without the knowledge of the car owner and is the reason for much mysterious battery trouble, in which the battery apparently runs down without any cause being discovered. Such conditions are often hard to discover because in connecting a testing instrument at the battery, the cutout will open as soon as the battery circuit is broken and no discharge of current will be indicated on the meter. It is therefore necessary in testing any car to start the engine and then stop it and notice if any discharge current is shown on the meter, thus indicating that the cutout has not opened.

If you have no Ambu Trouble Shooter, use an ammeter which has the "O" in the center of the scale and which reads to about 25 amperes both ways. This ammeter should be connected in series with one cable of the battery. This is done by removing

one of the main cables from the battery, and connecting this cable to one of the terminals on the ammeter. Connect the other ammeter terminal to the battery post from which the main cable was removed.

Most cars now use battery ignition systems, and it is necessary to use dry cells or an extra storage battery to furnish the ignition current while making the test. If you have Ambu, make the connections which are described in the Ambu Instruction Book, and then test the cutout as explained above.

BATTERY TROUBLE CHART NO. 1.

LOW GRAVITY OR LOW VOLTAGE.

A. LOOK FOR THE FOLLOWING TROUBLES:

1. Loose or dirty terminals or connectors.
2. Broken terminals or connectors.
3. Loose plugs causing flooding.
4. Corroded terminals caused by acid on top of battery due to overfilling or flooding.
5. Copper wires attached to battery posts. Remove wires and attach to battery cables at least one foot from battery terminals.
6. Acid or moisture on top of battery, causing current leakage.
7. Tools or wire causing short circuits.
8. Short circuits or grounds in wiring. Use "AMBU" Trouble Shooter.
9. Three wire lighting system with unequally divided load, discharging two halves of battery at different rates. Redistribute load.
10. Multiple section battery charged with two or more sections in parallel. Cable terminals and connections must all be clean and tight.
11. Check action of cutout relay. See page 169.
12. Polarity of dynamo reversed, or battery connections reversed.
13. Excessive lamp current. Use "AMBU" Trouble Shooter.
14. Dynamo not charging battery. Use "AMBU" Trouble Shooter.

15. Dynamo charging battery at too low a rate. Use "AMBU" Trouble Shooter.

B. ASK THE DRIVER:

1. If water has been added once every week.
2. If distilled water only has been used.
3. If too much water is added.
4. If electrolyte has been spilled and replaced by water.
5. If any alcohol or anti-freeze mixture has been added.
6. If electrolyte is always returned to correct cell after hydrometer readings.
7. If impure acid or electrolyte has been used.
8. Has battery been dropped?
9. Has battery been idle, or stored without regular charging for several months?
10. Has specific gravity been low for a considerable time? There is, therefore, sulphation present.
11. How old is the battery? If a battery has been used more than fifteen months, it is best to put in a new one.
12. Is car used in night time more than the day time? Considerable night driving does not allow battery to remain charged.
13. Is starter used frequently?
14. Has starter been used frequently, merely to demonstrate it?
15. How fast is car driven on an average? Speed should be at least 15 m.p.h. Battery is not charged at low speed.
16. How long do you spin the engine with the starting motor? Should not exceed one half minute.
17. If it is winter, caution driver to keep battery charged, even if battery must occasionally be removed from car to do so.

C. IF BATTERY HAS BEEN REPAIRED:

The trouble may be due to

1. Negative exposed to air.
2. Common wood used in place of separators.
3. Grooved sides of separators put toward negative plates instead of positive.
4. A separator may have been left out.
5. Positives used that should have been discarded.

6. Bulged negatives used.
7. Poor connections made.

D. BATTERY TROUBLE WHICH MAY EXIST:

1. Sulphated Plates.
2. Buckled Plates.
3. Internal Corrosion.
4. Shedding of Active Material.
5. Internal Short Circuits.
6. Cracked Jars.
7. Hardened Negatives.
8. Clogged Separators.
9. Battery frozen.
10. Negatives reversed.
11. Disintegrated positives.
12. Crystallized positives.

BATTERY TROUBLE CHART NO. 2.

HIGH GRAVITY.

A. PROBABLE CAUSES:

1. Raw acid added instead of water.
2. Electrolyte added instead of water.
3. Electrolyte replaced in wrong cell after testing specific gravity.

B. BATTERY TROUBLES WHICH MAY EXIST:

1. Sulphated Plates.
2. Burned Separators.
3. Internal Corrosion.

BATTERY TROUBLE CHART NO. 3.

LOW LEVEL OF ELECTROLYTE.

A. PROBABLE CAUSES:

1. Water not added.
2. Electrolyte replaced in wrong cell after testing specific gravity.

3. Battery dropped.
4. Battery loose in box.
5. Battery located in hot place, such as near the exhaust pipe.
6. Battery overcharged due to long daylight runs, with little use of lamps.

B. BATTERY TROUBLES WHICH MAY EXIST:

1. Sulphated plates.
2. Cracked jars.
3. Burned separators.
4. Shedding of active materials.

BATTERY TROUBLE CHART NO. 4.

BATTERY OVERHEATS.

A. PROBABLE CAUSES:

1. Battery located in hot place on car.
2. Water not added regularly.
3. Impure water used.
4. Electrolyte dirty.
5. Impure acid used.
6. Alcohol or Anti-Freeze liquid added.
7. Sulphated battery charged at too high a rate.
8. Common wood used for separators.
9. Battery overcharged by long daylight runs.
10. Battery charged at too high a rate due to excessive generator output.

B. BATTERY TROUBLES WHICH MAY EXIST:

1. Sulphated plates.
2. Softened or broken jars.
3. Cracked, burned, or broken separators.
4. Buckled plates.
5. Active material has dropped out.
6. Separators clogged.

OTHER TROUBLES.**5. SPECIFIC GRAVITY WILL NOT RISE ON CHARGE.****A. PROBABLE CAUSES:**

1. Battery badly sulphated.
2. Not enough acid in electrolyte.
3. Sediment in bottom of jars.

B. REMEDIES: (Numbered to correspond with causes given above).

1. Long charge at 3 to 5 ampere rate.
2. Charge until specific gravity is constant for several hours. Then draw off some electrolyte and add 1.400 electrolyte. Charge again, and repeat until specific gravity is 1.280-1.300.
3. Open Battery. See page 187.

6. BATTERY WILL NOT TAKE CHARGE.**A. PROBABLE CAUSES:**

1. Badly sulphated, or crystallized plates.
2. Terminals or top connectors corroded, dirty, or loose.
3. Open circuit inside of battery.

B. REMEDIES: (Numbered to correspond with causes given above).

1. Open battery. See page 187.
2. Remove green deposit, tighten and clean terminals, reburn top connectors.
3. Open battery. See page 187.

7. ELECTROLYTE LEAKING AT TOP.**A. PROBABLE CAUSES:**

1. Too much water added.
2. Battery loose in case.
3. Battery poorly sealed, causing a "slopper."
4. Filling plugs loose.

B. REMEDIES: (Numbered to correspond with causes given above).

1. Add correct amount of water.
2. Fasten battery in case.
3. Reseal battery. See page 187.
4. Tighten filling plugs.

8. BATTERY BOX ROTTED.

A. PROBABLE CAUSES:

1. All the causes given in preceding chart.
2. Broken jars.
3. Electrolyte spilled in testing specific gravity.

B. REMEDIES: (Numbered to correspond with causes given above).

1. All the remedies given in preceding chart.
2. New Jars—Open battery. See page 187.

9. CORRODED TERMINALS.

A. PROBABLE CAUSES:

1. All the causes given in No. 7 above.
2. Connecting copper wire directly to battery terminals.
3. Electrolyte spilled in testing specific gravity.

B. REMEDIES: (Numbered to correspond with causes given above).

1. All the remedies given in No. 7.
2. Connect wires to battery cables at least one foot from battery.
3. Wipe off electrolyte spilled in testing specific gravity. Remove green deposit.

10. BATTERY DISCHARGES RAPIDLY.

A. PROBABLE CAUSES:

1. Short circuits or grounds in wiring. (Battery Idle.)
2. Short circuit in battery. (Battery Idle.)

3. Battery old, with most of active material dropped from **grids**.
(Battery in Use.)

B. REMEDIES: (Numbered to correspond with causes given above).

1. Locate short circuits or grounds in wiring and remove. Use the "Ambu Trouble Shooter."

2. Open battery and clear shorts. See page 187.

3. Open battery and install new plates. See page 187.

11. BATTERY FROZEN.

A. PROBABLE CAUSE:

1. Allowed to stand in discharged condition in cold place.

B. REMEDY:

1. Try charging at 3 ampere rate for a week. Most likely battery must be opened and new plates and separators put in.

12. LIGHTS DIM.

A. PROBABLE CAUSES:

1. Battery partly discharged, due to insufficient charge.

2. Dead cell in battery.

3. Dirty, corroded, or loose terminals and top connectors.

4. Dynamo not delivering sufficient charging current.

5. Car used mostly at night with lights burning.

B. REMEDIES: (Numbered to correspond with causes given above).

1. Remove battery and charge on charge bench.

2. Open battery. See page 187.

3. Clean and tighten terminals. Reburn top connectors.

4. Use "Ambu Trouble Shooter."

5. Change driving conditions, or charge battery about once a month while removed from car.

SUMMARY OF WORK TO BE DONE ON BATTERY.**1. When may a battery be left on the car?**

(a) When you find that the specific gravity of all cells is 1.250 or more, the voltage of each cell is at least 2, the voltage does not drop when the lights are turned on, the starter action is satisfactory, there are no loose terminals or connectors, the sealing compound is not broken or cracked so as to cause a "slopper," the electrolyte covers the plates, the box is not rotted by acid, and there are no broken jars.

(b) Conditions given in (a) will exist only if battery has been well taken care of, and some trouble has suddenly and recently arisen, such as caused by a break in one of the battery cables, loosening of a cable connection at the battery or in the line to the starting motor, or in fact, any starter, generator, or lighting trouble which has not caused a battery to lose more than half of its charge and has not interfered with the charging circuit or current.

(c) If removing of corrosion, cleaning or tightening of terminals at battery will make the starting, charging, and lighting systems operate satisfactorily.

(d) If battery is more than half charged, due to the conditions given in (b) and (c), and the driver promises to use his starter and lights sparingly until battery is fully charged.

2. When should a battery be removed from car?

(a) When you find broken sealing compound, causing a "slopper."

(b) When you find top connectors and terminals loose, corroded, or poorly burned on.

(c) When you find box badly rotted by acid, or otherwise defective.

(d) When you find a cracked jar, indicated by low electrolyte, or find that electrolyte level falls below the tops of the plates soon after adding water.

(e) When you find a dead cell, indicated by very low or no voltage.

(f) When specific gravity of electrolyte is less than 1.250.

(g) When battery voltage drops to about 1.8 or less per cell when lamps are turned on. Lamps will then burn dimly.

(h) When you find that electrolyte is below tops of plates, and it requires considerable water to bring it up to the correct height.

(i) When battery overheats on charge, or discharge, although battery is not located in hot place, charging rate is not too high, and lamp and accessories load is normal.

(j) When battery is more than 15 months' old, and action not satisfactory.

(k) When battery has low capacity, as shown by rapid loss of charge after being fully charged.



Fig. 93. A Blacksmith Tried His Hand on This Battery

(l) When a blacksmith or plumber has tried his hand at rebuilding the battery, or the car owner has attempted to save money by doing his own repair work. Such a battery is shown in Figure 93.

(m) When the ends of the case are bulged out, indicating a frozen battery.

3. When is it unnecessary to open up a battery?

(a) When the conditions given in paragraphs (a), (b), (f), (g), (h), and (i), in section 2, above, can be remedied by outside repairs, or by charging; (a) and (b) require repairs, and (f), (g), (h), and (i) require charging. If the charging will not cause the

specific gravity to come up to 1.280-1.300, it will be necessary to open the battery. See page 187.

4. When must a battery be opened?

(a) When the conditions given in section 2, paragraphs (a), (b), (f), (g), (h), and (i) cannot be remedied by charging or repairs that do not require the removal of the sealing compound.

(b) When you find the conditions given in section 2, paragraphs (c), (d), (e), (j), (k), (l), and (m).

CHAPTER 16.

WORK ON THE BATTERY.

Charging Batteries Before Rebuilding.

Battery charging may in general be divided into two classifications:

1. Charging while on the car, by the generator installed on the car.
2. Charging battery when removed from the car.

1. **With the battery on the car**, the driving conditions determine to a great extent the condition of charge, and the garageman should watch them closely. The battery is alternately charged and discharged. The discharge takes place when the starter is used, or current is furnished to the lights, horn, ignition, etc.

The battery furnishes these currents whenever the car is not running, or running at such a low speed that the dynamo does not charge the battery. Most generators are designed so that their outputs can be changed in order to keep the battery charged under the driving conditions of the particular car upon which the generator is placed. When cars leave the factory, the generators are set to produce a current which will keep the battery charged under average driving conditions. This current should never be changed unless a battery does not receive enough charge due to unusual driving conditions, or receives too high a charge, as indicated by high temperatures (above 105°F), or abnormal gassing.

It is important to check the action of the cutout in closing and opening the charging circuit. (See page 169.) The cutout should close as soon as the generator voltage is slightly greater than

that of the battery, and should open the circuit as soon as the generator voltage is slightly less than that of the battery.

The temperature of the battery on the car must be watched closely. If a thermometer indicates that the temperature of the electrolyte is above 105° , and the connectors on top of the battery feel hot, the charging rate of the dynamo must be decreased. If the charging rate cannot be changed, the lamps should be burned, day or night, whenever the car is running. This will cut down the charging current delivered to the battery and prevent overheating.

If the specific gravity of the electrolyte is always below 1.250, due to unusual driving conditions, the output of the generator must be increased so as to keep the battery charged, or the lights should be used sparingly.

2. With the battery off the car, the charge and discharge can be regulated by the repairman. There are many things to be considered in such charging.

(a) If a battery needs a charge on account of generator not having a sufficient output, or on account of unusual driving conditions, or neglect, give the battery a charge. Such a charge is necessary:

When the lamps burn dimly (with engine not running).

When voltage per cell has fallen below 1.80 (with lamps burning).

When electrolyte has fallen below the tops of the plates and battery is not giving satisfactory service. Water should first be added to bring electrolyte up to the correct height.

Sometimes a battery will be completely discharged, as shown by dim lights and voltage below 1.8 per cell, but the hydrometer reading will be 1.200 or above. This shows that acid has been added to the discharged battery instead of water. Give battery a full charge at once, and then reduce specific gravity to 1.270-1.300 by removing some electrolyte and adding water. Cells should be gassing while this is done, and the specific gravity reading should not be taken until an hour after adding water. The time required to charge such a battery depends upon the extent to which the battery has been damaged by the acid. If a considerable amount of acid has been added, the plates may be

badly sulphated, and require a long charge, or the separators may be rotted, making it necessary to open the battery. See page 187. The normal charging current to be used is that stamped on the nameplate usually found on the battery.

Most manufacturers give a "starting" rate and a "finishing" rate. Charge the battery at the "starting" rate until the cells are gassing freely, and then reduce the current to the "finishing" rate. Some manufacturers give only one charging rate, and in this case charge the battery at the rate given until each cell is gassing freely, and the specific gravity does not rise for five hours. The voltage of a charged battery is from 2.5 to 2.7, measured while the charging current is still passing through the battery.

If the battery nameplate does not give the charging rate, start charging with a current which is equal to $1/8$ of the ampere hour capacity of the battery. Charge at this rate for one hour, and then finish with a current which is equal to $1/20$ of the ampere hour capacity of the battery.

With most batteries, the filling plugs should be removed while charging. When charging Exide batteries, however, there is a tendency to flood when the plugs are out. Many battery men are not aware that a simple quarter turn of the movable hard rubber collar seen inside the well after the plug is removed will put it in the same position it occupies when the plug is in place, and will prevent flooding when the plug is removed. The reason for this is that when the plug is removed, this movable rubber collar closes the two vent holes in the cover. A quarter turn of the collar will move it from over the vent holes, allowing the accumulated gases to escape, and thus preventing flooding. The special design of this cover, as described on page 98 makes this necessary. Exide plugs may be removed to see if cells are gassing, but should be replaced immediately unless the collar is turned as described above. It is a good thing to make a Cadmium test (see page 266) on each battery while it is charging. If either positive or negative plates show a decided loss of capacity, put in new plates.

(b) If the specific gravity of the electrolyte in a battery is around 1.150, the battery is completely discharged, and should be given a complete charge. Such a battery is very likely sulphated to a considerable extent, and it may require from one day

to several weeks of continuous charging to bring it back to its full strength. Usually the charging current for a sulphated battery should be not more than five amperes. The current is governed by two things—(1) temperature, and (2) gassing.

(1) Temperature. Have a thermometer on hand and measure the temperature of the electrolyte in each cell once every hour. If the temperature rises above 105°F , reduce the charging current so that the temperature drops to at least 90°F .

(2) Gassing. A sulphated battery will begin to gas unless a low charging current is used. If any cell gasses, reduce the current immediately, as long continued gassing will cause excessive shedding.

If the temperature of the electrolyte does not rise above 105°F , and if the cells do not gas, the current may be increased. Never use a current that will cause a higher temperature or bring about gassing long before the end of the charge. If the specific gravity rises to 1.280-1.300 within 24 hours, the battery was not badly sulphated. If the rise in specific gravity is slower, continue the charge until there is no further rise for several days. If the gravity is then 1.280-1.300, the battery is rejuvenated. If the gravity will not come up to normal, it will be necessary to discharge the battery and then charge it again. It may be necessary to repeat this cycle of charge and discharge several times, before the plates are in a healthy condition. To discharge the battery, connect it to the Discharge Board (see page 133) and adjust the switches so as to draw from the battery a current whose value in amperes does not exceed one-tenth of the ampere capacity of the battery. Thus for an 100 ampere hour battery, the current should be 10 amperes. Discharge the battery until the voltage of each cell has dropped to 1.6 or 1.7. This voltage should be measured while the discharge current is still flowing. Then charge the battery again, and discharge it, repeating the charge and discharge several times. This should remove most of the sulphate.

When you discharge such a battery notice how long it takes for the voltage to drop to 1.6 per cell. Multiply this time by the discharge current, and if this product is very much less than the normal ampere-hour capacity of the battery, the plates have been

too severely damaged to be of further use, and the battery should be opened. See page 187.

(c) If the temperature of one or all the cells in a battery rises rapidly when the battery is put on charge, and if the specific gravity does not rise to at least 1.250, there is trouble in the battery, and it should be opened. See page 187.

(d) If you are charging a battery at the normal rate, and the temperature does not rise above 105°F at any time, and if gassing begins before the specific gravity rises to 1.280-1.300, and the specific gravity will not rise to at least 1.280, it is probable that electrolyte has been spilled from flooding due to overfilling, or slopping, and has been replaced by water. In this case, draw off some of the electrolyte and replace it with electrolyte having a specific gravity of 1.400. This should be done while the cells are gassing. One hour after adding the electrolyte, measure the specific gravity of each cell. If this is below 1.280-1.300, draw off more electrolyte and add 1.400 electrolyte. If the specific gravity is above 1.300, draw off electrolyte and add distilled water. In this way balance the electrolyte until it has the proper specific gravity.

If you now have time, put the battery on the discharge board and discharge at a current equal to about one-fifth of its ampere hour capacity. Multiply the current by the time required to cause the voltage per cell to drop to 1.6 or 1.7, and if this product is nearly equal to the normal ampere hour capacity, the battery will give good service. Then charge the battery at the normal rate, and it is ready for use.

(e) If the specific gravity of a battery on charge rises above 1.300, either acid or electrolyte have been added instead of water. Remove some of the electrolyte and add distilled water in its place. When the cells are gassing, and the specific gravity does not rise in several hours, the electrolyte should have a specific gravity of 1.280-1.300, and if necessary, electrolyte should be drawn off and replaced with distilled water, or 1.400 electrolyte, depending on whether the specific gravity of the electrolyte in the battery is above or below 1.280-1.300.

(f) It is generally considered necessary to give the battery an overcharge about once a month. An overcharge means that the

normal charge rate is continued until the specific gravity shows no further rise for three hours and at the end of this time the cells should be gassing freely.

If a battery is kept properly charged, that is, with the specific gravity at 1.275 or above, an overcharge may do harm rather than good. The charge should never be continued to a point at which the voltage for each cell raises above 2.5.

REBUILDING BATTERIES.

To Open a Battery.

This relates to batteries with burned-on connecting straps and terminals, and with compound poured on top of lower covers for



Fig. 94. Before Rebuilding

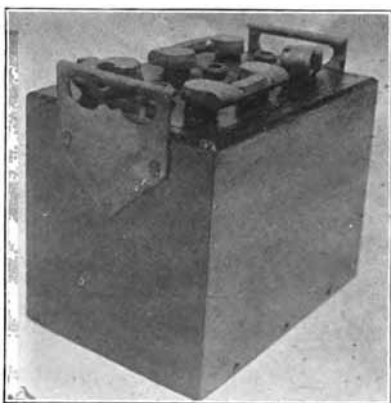

Fig. 95. After Rebuilding

sealing. Figure 94 shows the battery before rebuilding, and Figure 95 after rebuilding.

First, set the battery on the bench. See that the vent plugs are screwed in tightly. Then remove any dirt or grease from the top, sides, and bottom of battery. If the dirt and grease is thick, remove it with a putty knife. Then put the battery in the sink and let the water run over it, using a stiff bristle brush to clean it. If you have no running water, put battery in a tub and clean it with the brush. A large 4-inch paint brush is very satisfactory for this work, and it will last a year or more if well taken care of. If the battery is too greasy to be cleaned in this way, use a rag

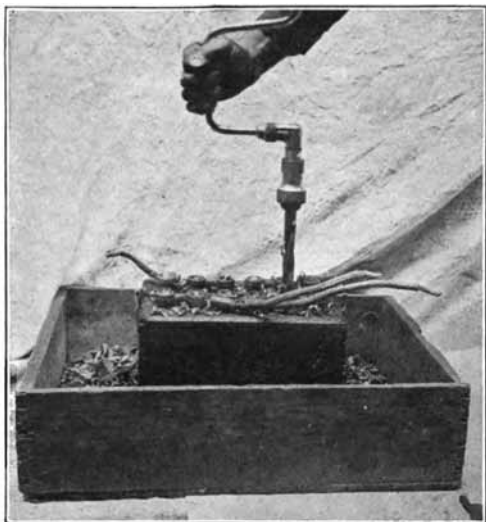

Fig. 96. Drilling Posts and Top Connectors, with Battery in Special Box

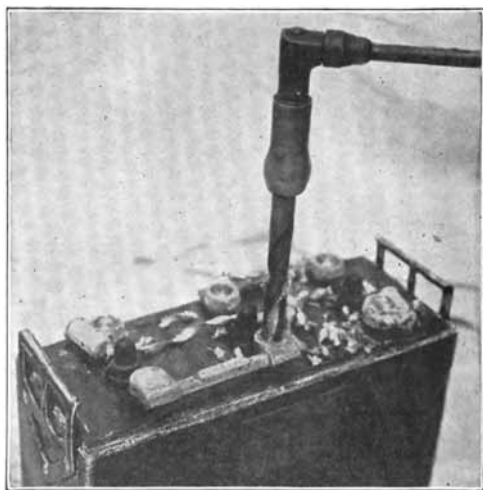

Fig. 97. Drilling Posts and Top Connectors

dipped in gasoline. The object is to clean the battery thoroughly. When you have removed all the dirt, set the battery on the floor near your work bench, or in a shallow box about 4 to 6 inches high and 2 to 2½ feet square, as shown in Figure 96.

The next operation is to remove the connecting straps and terminals. You will need for this a large brace with a heavy chuck, a drill the same size as the post (the part that goes down into the battery), a large screw driver, center punch, and hammer.

With the center punch, mark the exact center of the top of the post and connector. Then drill down straight about half way through the straps and terminals, as shown in Figure 97.

Now pry off the connectors with the screw driver, as shown in Figure 98. A convenient tool to be used here to avoid damaging the top of the box with the screw driver is a length of one inch angle iron, which is placed

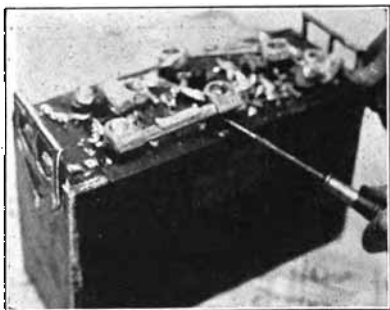

Fig. 98. Prying off Connectors with Screw Driver

on the top edge of the box to protect it from the screw driver.

If any connector is still tight, and you cannot pry it off, with a reasonable effort, bore down a little deeper, and it will come off easily, provided that the hole which you are drilling is exactly over the center of the post and as large as the post. There are five things to remember in drilling the connectors and posts:

1. Be sure that the hole is exactly over the center of the post.

2. Do not drill too deep. Make each hole just deep enough so that the connector will come off easily. Figure 99 shows a cross section of a post and connector drilled to the proper depth. Notice that you need not drill down the whole depth of the connector, because the bot-

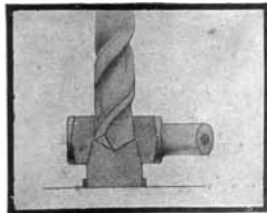

Fig. 99

tom part is not burned to the post.

3. Be sure that the drill makes the right sized hole to permit

the connectors and terminals to be removed easily when drilled half way through. An electric drill will do the work much faster than a hand brace.

4. Protect the edge of the battery box when you pry up the connectors with a screw driver. The angle iron is best for this purpose.

5. Remove your drill after the hole is well started and see whether the hole is in the center of the post. Should you find

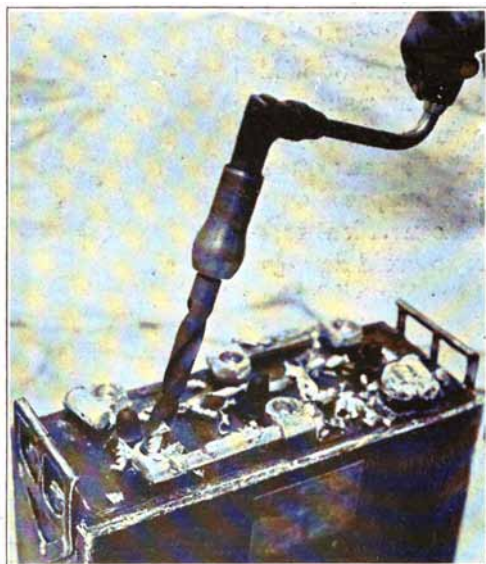

Fig. 100. Straightening Hole Which was Started Off Center

that it is off center, tilt the brace as shown in Figure 100, and with the end of the drill pointing toward the center of the post as you drill, gradually straighten the brace. This will bring the hole over the center of the post.

Having removed the connectors, take a whisk broom and sweep all the lead drillings from the top of the battery into a box kept for lead drillings only, Figure 101, or into the shallow box shown in Figure 96. When this box is full, melt the drillings in a large adle, and pour off in the burning lead mold.

The next step is to heat and remove the sealing compound so that the covers may be removed. The compound must be heated

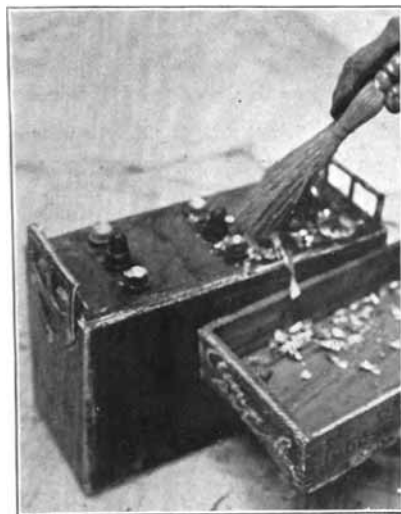

Fig. 101. Sweeping Lead Drillings Into Box

to a temperature of about 200° Fahrenheit. Before you bring a flame near the battery, remove the filler plugs and blow out any gas which may have collected above the plates with a hand bellows, Figure 102, or with compressed air. If you fail to do this, the flame may cause these gases to explode, with possible serious injury to yourself.

The ease with which the compound is softened and removed depends entirely upon having the proper amount of heat, the proper length of time in applying it, and the way it is applied.

The purpose is to heat the covers and compound gradually, and not have too hot a flame, as a hot flame will burn the hard rubber tops and wells, and ruin the threads in the wells. The compound must be heated uniformly to a temperature of about 200° Fahrenheit down to the bottom of the lower covers, in order to be able to remove it easily.

The methods of heating the compound are:

1. The common gasoline blow torch. This gives a very hot flame, and great care must be taken not to hold the flame on one spot for any length of time, otherwise the rubber tops, wells and threads in the wells will be ruined. If you use this torch, be sure that you have one that gives a large spreading yellowish flame, Figure 103. A concentrated, short blue tip flame is unsuitable for this work.

2. Natural or manufactured gas, mixed with air. This has already been described. (See page 154.) Where such gas is available, this is a very convenient method to use. The flame is much

softer than that of the gasoline torch, and may be instantly adjusted to any size by the thumb and forefinger of the hand holding the burner. Any of the flames described under "Lead Burning," page 151, may be used.

3. Figure 104 shows a four compartment sheet steel or iron box having two gas burners running the full length under a sheet iron plate extending the full length of the box, midway between the top and bottom. About one inch above this iron plate is a shelf of $\frac{1}{4}$ inch to $\frac{3}{8}$ inch transite board, which is reinforced under-



Fig. 102. Blowing Gas out of Battery with Hand Bellows



Fig. 103. Heating Compound with Torch

neath by several angle iron supports. Two sliding doors divide one side of the box into halves. The doors slide up and down, as shown.

When you wish to heat the sealing compound in opening a battery, place the battery on the bottom shelf. When you wish to heat the bottom of the battery for removing a jar, place battery on upper shelf. The temperature can be regulated by turning the flame up or down. It is a good plan to place a thermometer on top of the battery and not allow the temperature to rise above 212° Fahrenheit.

4. **The Battery Steamer.** This has already been described. See page 140.

You will need four screw drivers of the following dimensions for removing the compound: two with ten-inch blades, one with

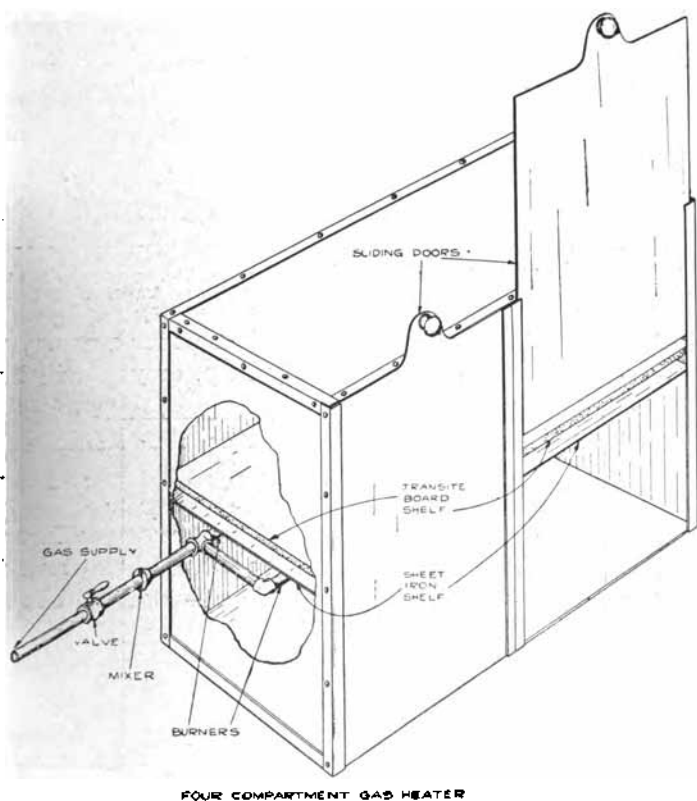

Fig. 104

an eight-inch blade ground rather narrow, and one with a six-inch blade. A one-eighth inch wood chisel is also useful for this purpose. Place battery on end of low work bench, Figure 55. With the compound properly softened, no matter what method you have used to soften it, heat the point of your large screw driver slightly.

Place tip of screw driver in one of the spaces between successive cell covers at the farther side of the battery, and hold it at an angle which will fit the beveled edge of the covers. Press down on the handle and draw the screw driver toward you, using enough pressure to clean out all the compound in this space as you draw the screw driver toward you. In this way, remove the compound from all the spaces between cell covers, Figure 105, and also all around the edge of the case. It is easily and quickly done, and saves time in cleaning covers later on.



Fig. 105. Cleaning out Cracks with Screw Driver

Now, with a long screw driver in your right hand, and the angle iron on the edge of the case, slip the point of the screw driver under a cover, as in Figure 106. The covers must be fairly limp, or you will break

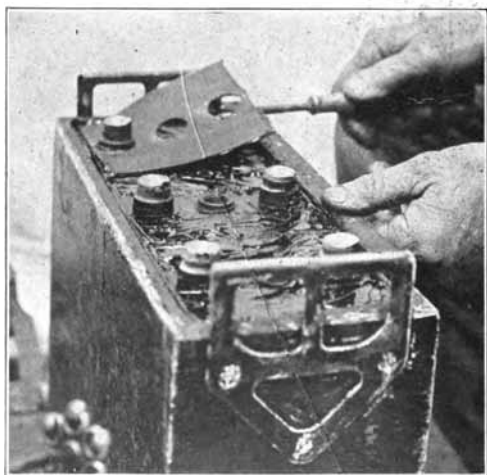

Fig. 106. Removing Top Covers with Screw Driver Resting on Angle-Iron

them. They must also be well warmed in order to be able to separate them easily from the compound under them. Push the screw driver point close to the posts, and gradually through to the

other side, and carefully raise cover from posts. In this way remove all the covers.

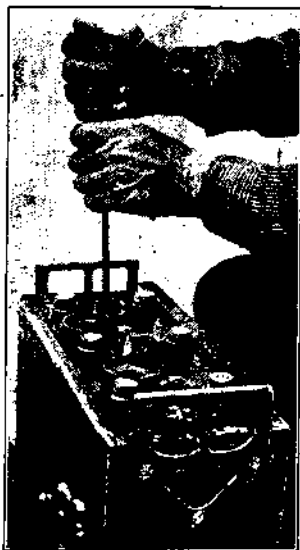

Fig. 107. Digging Compound from around Wells with Hot Screw Driver

If you do not use the angle iron to protect the edge of the case, keep the edge free from bruise marks caused by the screw driver by lifting the covers off with the screw drivers without touching the edges of the case.

With the tops off, heat the point of the large screw driver pretty hot, and run it around each well, Figure 107, cutting the compound from them. If the wells are removable, take them out. Now sink point of large hot screw driver into the compound in the right hand corner of case next to you. Push the screw driver across that end of the case, Figure 108, raising compound off the top of jar and the end of the case. Follow this by pushing screw driver along opposite side of case and tops of jars. Then sink screw driver in compound at the corner at which you be-

gan; and in a similar way remove compound from tops of jars and inside of case on the side next to you, the left hand end, and top edges of jars between cells, Figure 109. Gather up the loose pieces of compound and put the compound box under the tool scraper on your work bench. Remember that the end of the screw driver must be warm at all times, but not sizzling hot. Clean the screw driver on the tool scraper whenever necessary to keep the point clean.

Now, sink the warm point of the large screw driver in the compound at the inside corner of the jar to your right, and push along the inside of the jar to the opposite side. Follow up in this way all around the inside of the jar, clear down to the top of the lower cover, Figure 110. If the compound is not warm enough to do this easily, heat it a little with the flame. In this way remove all

the compound systematically from top of the lower cover, and the inside well of the jar of every cell.

Try to make every motion of screw driver cut out a mass of compound fully as wide as the screw driver point. In opening small batteries, you must use a smaller screw driver, but always use as wide a screw driver as possible to save time.

Gather up the loose compound and put in compound box under tool scraper. If the lower covers and tops of jars have become

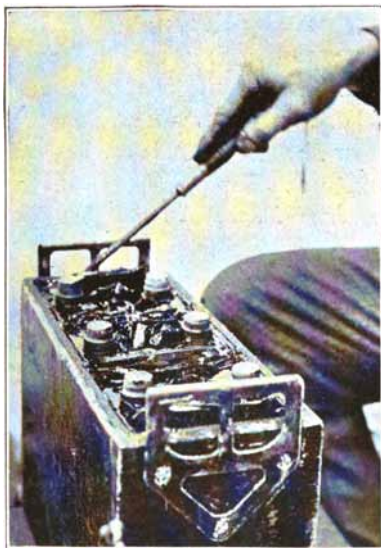

Fig. 108. Cleaning Compound from Top Edge of Jars at End of Case



Fig. 109. Removing Compound from Edge of Case and Tops of Jars with Hot Screw Driver

hard, play the flame over them until they are pliable, but take care not to burn them. Then run a hot putty knife around the edges of the covers, so as to remove the compound from the crack between the covers and jars. Using a pair of crooked-nose pliers, lift out the elements from each jar, as in Figure 111, and rest on the edge of the case to drain. If the covers are pliable, remove them as in Figure 112.

Now is a good time to clean all the top and lower covers and wells, and put in a properly labeled box as described on page 139.

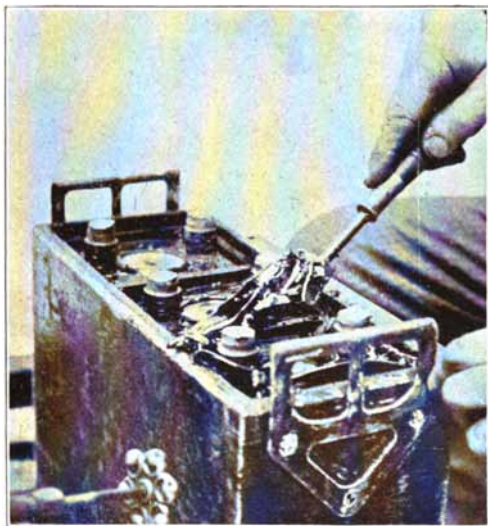

Fig 110. Digging Compound from Covers

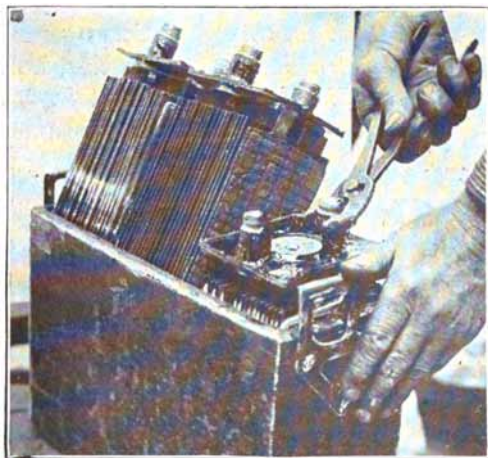

Fig. 111. Lifting Elements Out of Jars, and Resting on Edge of Case to Drain. Note that Cell on the Left Has been two-thirds Dry

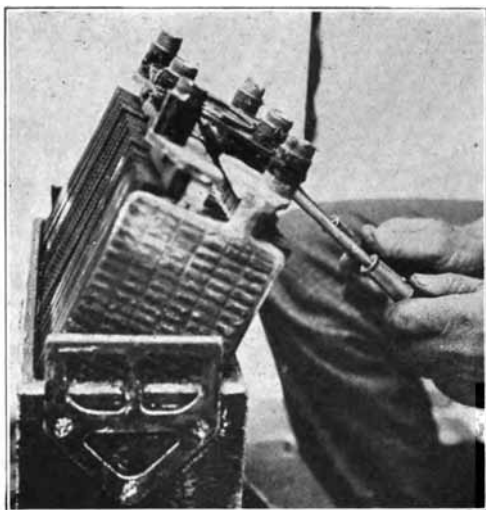

Fig. 112. Taking Off Covers with Two Screw Drivers

What Must Be Done?

The battery is now open, and in a condition to be examined and judgment pronounced upon it. The question now arises, "What must be done with it." In deciding upon this, be honest with your customer, put yourself in his place, and do just what you would like to have him do if he were the repairman and you the car owner. The best battery men occasionally make mistakes in their diagnosis of the battery's condition, and the repairs necessary. Experience is the best teacher in this respect, and you will in time learn to analyze the condition of a battery quickly.

You may have some trouble in deciding what must be done with the battery,—whether you should merely free any short-circuits, and charge it, or put it through several charges and discharges, or whether you must cut off some of the plates and replace with good ones.

It is absolutely necessary for you to have a standard method in working on the battery plates. You must divide your work into a number of definite steps, and always perform these steps, and in the same order each time. If you have a different method

of procedure for every battery, you will never be successful. The preliminary work on the plates should be divided into the following steps:

1. Examine plates to determine whether they can be used again. Rules for determining when to discard or use old plates are given below.

2. If all plates of both positive and negative groups are to be discarded, cut off the old ones and burn new ones on the plate strap.

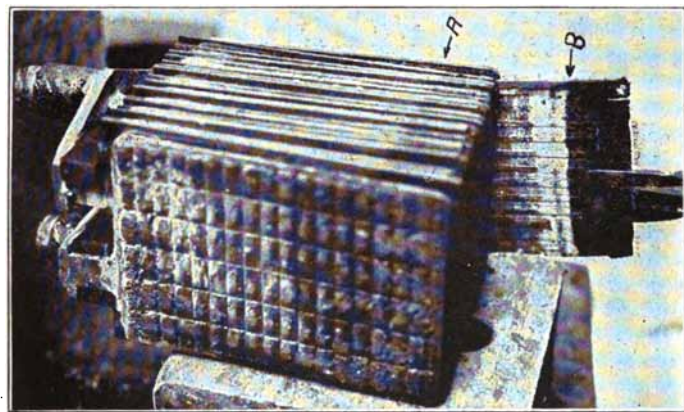

Fig. 113. Group on Block for Examination

3. If you find that only some of the plates are to be discarded, or if you are not certain as to the condition of the plates, free any short circuits which may exist, and give the battery a preliminary charge, as described later, before you do any work on the plates. Plates that are fully charged are in the best possible condition for handling, and you should make it an iron-clad rule that if some of the plates can be used again always to charge a battery before you work on the plates, no matter what is to be done to them. Very few batteries will come to your shop in a fully charged condition, and an exhausted battery is not in a good condition to be worked on. Charge the whole battery even though only one cell is in a very bad condition.

To make the examination of the plates, proceed as follows:

Place a group on block of wood as shown in Figure 113. With a putty knife or screw driver, carefully pry the plates apart so that you can look down between them and make a fair preliminary examination. Whenever possible, make your examination on the plates without separating the groups or removing the old separators. This should be done because:

(a) Very often the active material is bulged, hard, and sulphated, and if you pull out the old separators and put in new ones before charging, the element spreads out so at the bottom that it cannot be put back into the jars without first pressing in a vise or plate press.

(b) If you put in new separators before giving the battery the preliminary charge, the new separators will become clogged up with any impurities which may be on the plates, and will probably be cracked by forcing them between the bulged and sulphated plates.

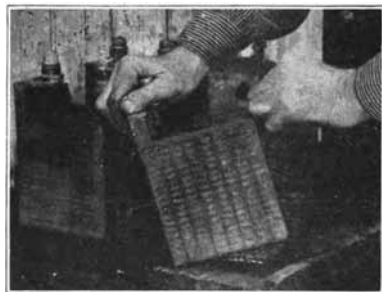

Fig. 114. Separating The Groups

If, however, you are not absolutely certain as to the condition of the plates, draw out a few separators. Removing a few separators will permit you to separate the groups before removing the rest of the separators. To separate the groups, grasp a post in each hand, as in Figure 114, and work them back and forth, being careful not to injure the posts, or break

off any plates. With the groups separated, the remaining separators will either fall out or may be easily pushed out with a putty knife. Ordinarily, the groups may be separated in this way if the elements have thirteen plates or less.

The natural thing to do at this point is to decide what must be done to the plates, and we therefore give a number of rules to help you to determine which are to be junked, and which are to be used again. Study these rules carefully, and have them fixed firmly in your mind so that you can tell instantly what must be done with the plates.

When to Put In New Plates.

1. If one or more jars are cracked and leak, and positive plates have been ruined by freezing, as shown in Figure 115, and if upon drawing out the separators, and separating the positive and negative groups the active material drops out of the grids, the only way to put the battery in a good condition is to cut off the positive plates and burn in good ones.

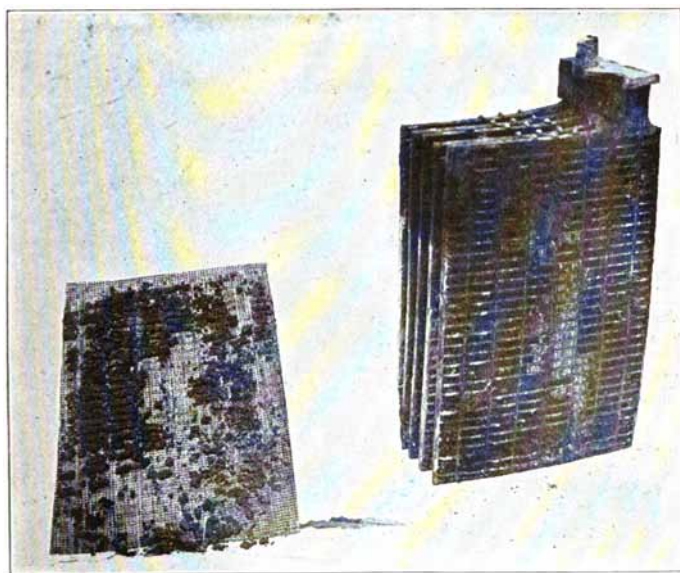

Fig. 115. Positives from a Frozen Vehicle Cell. Note Active Material Sticking to the Rubber Separator

Make a careful estimate of

- (a) Cost of new jars.
- (b) Cost of new plates.
- (c) Cost of new case if needed.
- (d) Cost of labor required.

Call up the owner, tell him what the total cost will be, and if he has no objections, go ahead with the job. If he is not entirely satisfied with your price, try to get him to come to your shop. Then show him the battery, explain its condition, tell him just

what must be done with it, and explain how you made your estimate of the cost of the whole job. If you do this, there will never be any misunderstanding as to cost. Tell him the cost of a new battery, and let him decide if he wants one. If the cost of repairing is within five dollars of the price of a new battery, ad-

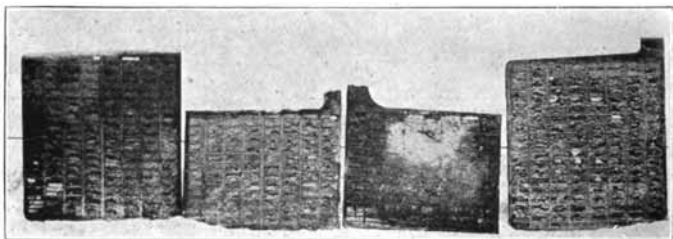

Fig. 116. Diseased Negatives. The Large Ones only Eight Months Old. Active Material Blistered, Soft, and Granulated

vise him to buy a new one, but allow him to make the decision himself. He will then have no cause for complaint.

2. If the battery is from two to three years old, and the active material on the negative plates is bulged, more or less granulated (grainy appearance), figure 116, and somewhat disintegrated; if

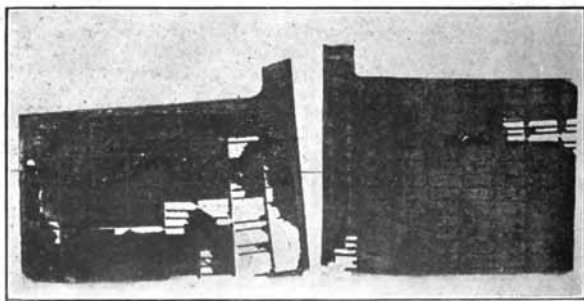

Fig. 117. Weak and Cracked Positives

the positive plates are weak and brittle around the edges, and several are cracked, figure 117, and have lost a considerable amount of paste; and if the case has been rotted by the acid, the battery should be junked.

Whenever the active material on the positive plates has shed

so that it has filled the bottom of the jar until it touches the plates, put in a new set of plates.

Call up the owner, and tell him he needs a new battery. If he does not seem pleased, ask him to come to your shop. Then show him his battery, and explain its condition. If you are

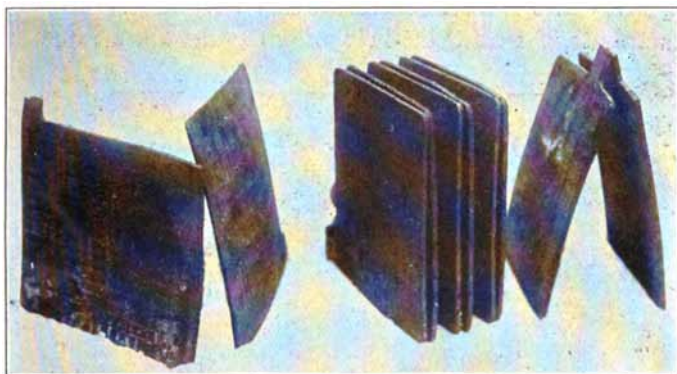

Fig. 118. Buckled Plates. Do not use such Plates again

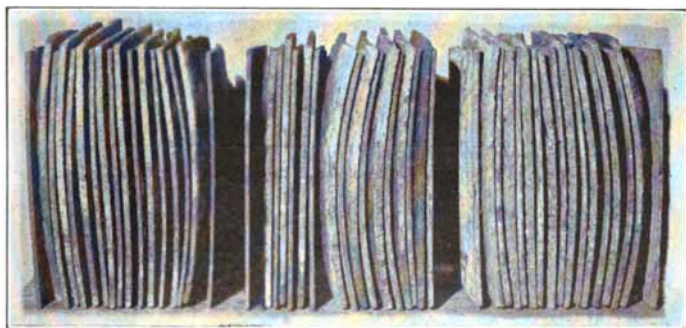

Fig. 119. Badly Buckled Plates

courteous and patient, you will sell him a new battery. Otherwise he will never return.

3. If the positive paste is hard, cracked, and shiny, it is badly crystallized and will no longer give good service, new positive plates should be installed. Such a condition is usually

caused by charging while the electrolyte is below the tops of the plates.

4. If the positive plates are badly distorted from buckling, as in figures 118 and 119, they will cut through new separators, if put into commission again, in from two to six months.

5. A battery which has been dry and badly sulphated at some past period of its life will have the dry portions covered with a white sulphate, the acid line being clearly distinguishable by this



Fig. 120. Corroded, Bulged and Sulphated Negatives. Disintegrated, Rotted Positives

white color, as shown at A and B in figure 113. The positives will be warped and its active material badly blistered or fallen out. The parts of the separators above the electrolyte will have been deteriorated, and new separators should be put in. Corroded and sulphated grids should be looked for carefully, as in figure 120. In corroded grids, the pastes cannot make good contact with the grids, and the capacity will be lowered in proportion to the extent of the corrosion. No amount of charging will remove all of the corrosion, as some of the deposit is insoluble, insulating the grids from the active material, and making it difficult

for a charging current to pass through. Such a battery will become very hot, even with a charging rate below normal.

Corroded batteries are always sluggish, and very little can be done to help them; discard them if possible, as they are trouble breeders. It is needless to say that both positives and negatives are subject to corrosion.

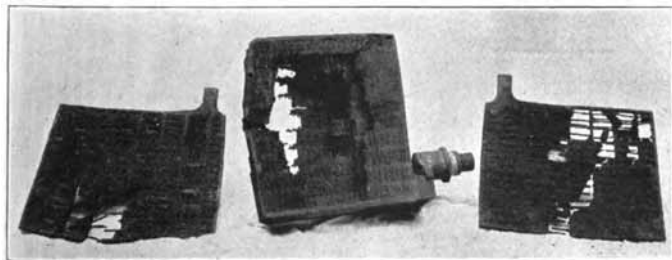

Fig. 121. Disintegrated Positives

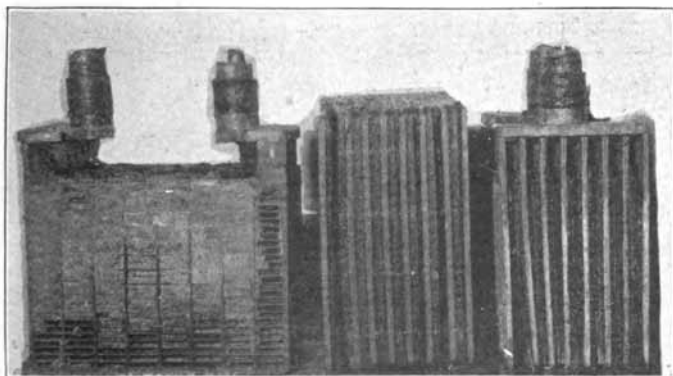

Fig. 122. Side, Bottom, and End View of Elements Taken from Traveling Salesman's Car who Made Long Daylight Tours

If you want to try to bring such plates back to life, try charging at a low rate of about three amperes. The length of time required may be several weeks or more. Be careful not to allow temperature to rise above 105° . When the specific gravity will no longer rise, connect the battery to the discharge board and discharge to 1.8 volts per cell with current still flowing, using a current equal to about one-eighth to one-tenth of the ampere hour

capacity. Do this charging and discharging before reassembling. Lower the elements into the jars and connect the posts together,—positive to negative,—as described on page 213.

6. **Rotten and disintegrated positive plates**, figures 120 and 121, must be replaced with new plates. The plates have fallen to pieces or break at the slightest pressure. Disintegrated plates are an indication of impurities or overcharging, providing the battery is not old enough to cause disintegration normally,—say about fifteen months. The lead grid is converted into peroxide of lead and becomes soft. As a result, there is nothing to support the paste, and it falls out. Better put in new negatives also.

7. **Overcharged batteries** have burned and carbonized separators, turning them black and rotting them; the negative paste is kept in a soft condition, and gradually drops from the grids on account of the jolting of the car on the road. Figure 122 shows plainly the result of overcharging and overheating. This battery was only three months old when it went dead. The owner was a traveling man who made long trips of one hundred or two hundred miles several times a week. He did not use the starter often during the day, and did not drive at night, and the battery was consequently overcharged. Notice from the illustration:

(a) What happens to one cell, happens to all, differing only a little in degree.

(b) Carbonized, rotten separators.

(c) Buckled plates cutting through rotten separators.

(d) Softened active material in negative plates, and dropping out of grid.

8. **Dry, hard, and white, long discharged, and badly sulphated plates**, figures 113 and 120, are practically ruined, though if the trouble is not of long standing, the plates may be revived somewhat by a long charge at a very low rate, and then discharging at a current equal to about one-eighth to one-tenth of the ampere hour capacity of the battery at the discharge board. Charge and discharge a battery a number of times, and you may be able to put a little "pep" into it. In charging sulphated positive plates, use as much current as possible, without allowing gassing before

the end of the charge, or a temperature of the electrolyte above 105°F.

9. When positive paste has become softened considerably.

10. If a battery case is not held down firmly, or if the elements are loose in the jars, the plates will jump around when

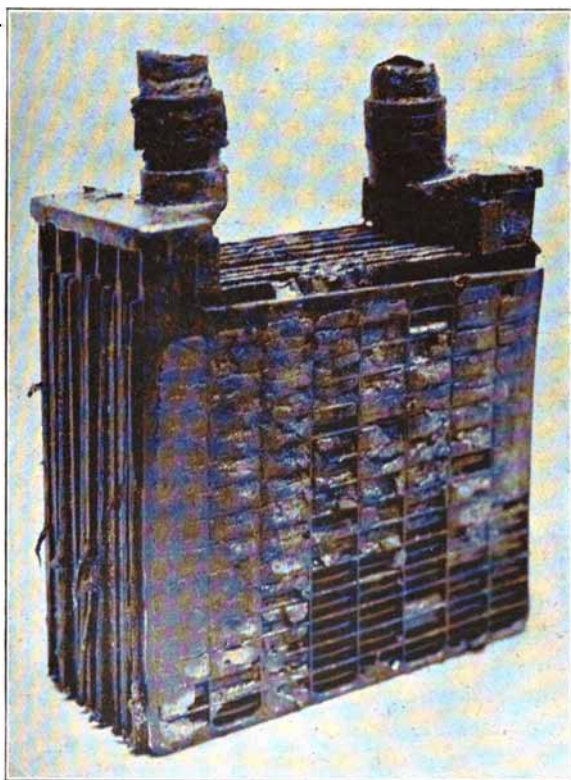

Fig. 123. Element From a "Slopper." Element was Loose in Jar, and Jolting of Car Caused Active Material to Fall From Grids

the car is in motion. This will break the sealing compound on top of the battery, and cause the battery to be a slopper. The active materials will be shaken out of the grids, as shown in figure 123. New plates are required.

When the Old Plates May be Used Again.

11. If one or more plates are broken from the plate connecting straps, or the joint between any strap and the plate is poorly made. If plates are in good condition, reburn the plate lugs to the straps.

12. **Straight rebuild.** If the general condition of the battery is good; i.e., if no jars are cracked, the plates straight and not warped, no paste shed, no white sulphate on either plates, the active materials not bulged out, the grids not brittle, paste adhering to and firmly touching the grids, the positive paste of a chocolate brown color and fairly hard (as determined by

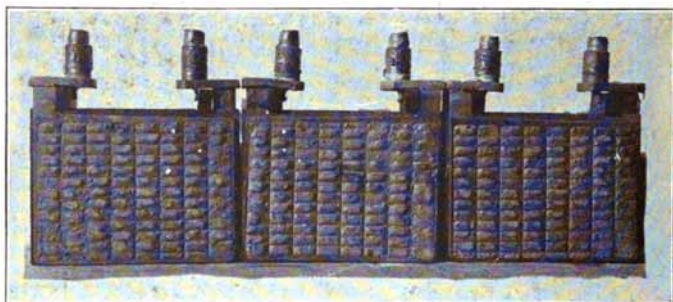

Fig. 124. Badly Bulged Negatives. Such Plates Need Pressing

scratching with blade of a pocket knife), the negative paste light gray in color and softer than the positive paste, and the plates not too thin, make a straight rebuild. To do this, remove any sediment from the bottom of the jar, clean the parts, insert new separators, and reassemble as directed later.

13. **Badly bulged negative plates**, figure 124, cause lack of capacity because the paste is loose, and does not make good contact with the grids. If the paste is not badly granulated (having a grainy appearance), the plates can be used again.

14. **Positives which are only slightly warped or buckled** may be used again.

15. **When the only trouble found is a slight amount of shedding.** Positive paste must be of a chocolate brown color and fairly hard. Negatives must be a light gray.

16. When the plates are in a good condition, but one or more separators have been worn or cut through.

Separators.

It is the safest plan to put in new separators whenever a battery is opened, and the groups separated. Separators are the weakest part of the battery, and it is absolutely essential that all their pores be fully open so as to allow free passing of electro-

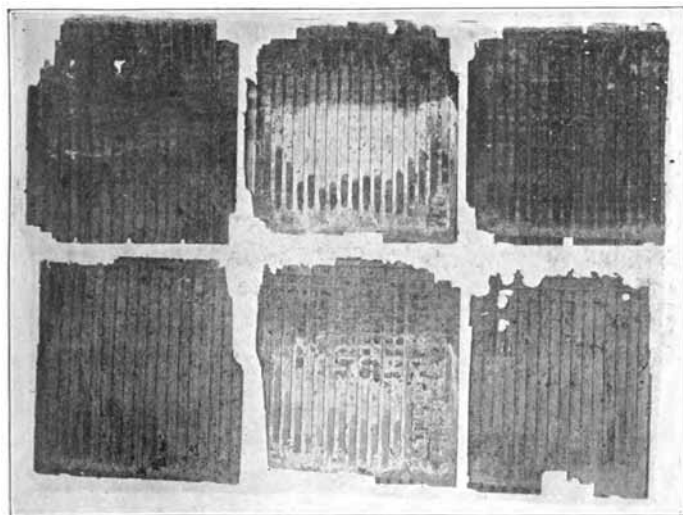

Fig. 125. Separators worn thin and cut through on edges by Buckled Plates. Holes worn through by Bulged Active Material. Center pair shows Cell was dry two thirds of the way down

lyte through them. Some of the conditions requiring new separators are:

1. Whenever the pores are closed by any foreign matter whatsoever. Put in new separators whether you can figure out the cause of the trouble or not. The separator shown in figure 113 is sulphated clear through above the line B. The separator shown in figure 115 should not be used again.

2. When the separators have been cut or "chiseled off" by the edge of a buckled plate, figure 125.

3. When a buckling plate or plate with bulged active material breaks through the separator, figure 125.

4. When a battery has been used while the level of the electrolyte has been below the tops of the plates, or the battery has been used in a discharged condition, and lead sulphate has deposited on the separators, figure 113.

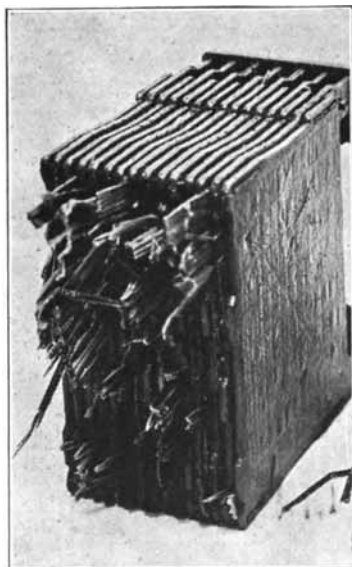

Fig. 126. Rotted Separators

5. When a battery has been over-heated by overcharging or other causes, and the hot acid has rotted, burned and carbonized the separators, figure 126.

6. When a battery has been damaged by the addition of acid and the separators have been rotted, figure 126.

When you have put in new separators, and put the battery on charge, the specific gravity of the electrolyte may go down at first, instead of rising. This is because the separators may absorb some of the acid. If the battery was discharged when you put in the new separators, the lowering of the specific gravity might not take place, but in most cases the specific gravity will go down, or

not change at all.

Separators kept in stock must be placed in a jar and kept moist with water to which a slight amount of sulphuric acid has been added. Never allow them to be dry, as this makes them very brittle and hard to handle.

A tight lead lined box may be used for storing separators. Instead of covering them with water, a pad of ducking placed in the box and kept wet will keep the separators in first class condition for months. The separators must be packed closely and compactly. In dry, hot weather, sprinkle the separators occasionally with distilled water.

Find the Cause of Every Trouble.

The above conditions **must** be studied carefully and be clearly tabulated in your mind to be able to tell what to put into commission again and what to discard as junk. It will take time to learn how to discriminate, but keep at it persistently and persevere, and as you pass judgment on this battery and that battery, ask yourself such questions as: What put this battery in this condition? Why are the negative plates granulated? Why are the positive plates buckled? What caused the positive plates to disintegrate? Why are the separators black? Why is the case rotten when less than a year old? Why did the sealing compound crack on top and cause the electrolyte to slop? Why did one of the terminal connectors get loose and make a slopper? Who is to blame for it, the car manufacturer, the manufacturer of the battery, or the owner of the car? Why did this battery have to be taken off the car, opened up and rebuilt at 5 months old, when the battery taken off a car just the day before had been on for 30 months and never had been charged off the car but once? There is a reason; **find it**. Locate the cause of the trouble if possible, **remove the cause**; your customer will appreciate it and tell his friends about it, and this will mean more business for you.

From these conditions, you see that most of the trouble is with the positives:

- (a) Because the positive active material does not stick together well, but drops off, or sheds easily.
- (b) Because the positives warp or buckle, this causing most of the battery troubles.
- (c) Because the positive plate is weaker and is ruined by freezing.

Freeing "Shorts."

If you have decided that some or all of the plates may be used again, the next thing to do is to separate any plates that are touching, and put the battery on charge. It may be necessary to put in new separators in place of the defective ones. Examine the separators carefully. Whenever you find the pores of the sep-

arators clogged up from any cause whatsoever, put in new separators before charging.

1. Sometimes the negative plates are bulged or blistered badly and have worn clear through the separators, figure 125, and touch the positives. In cases of this kind, to save time and trouble, separate the groups, press the negatives lightly with transite boards between them, as described later, assemble the element with new separators, and it is ready for charging.

2. There is another case where the groups must be separated and new separators inserted before they will take a charge, and that is where the battery has suffered from lack of water and has sulphated clear through the separators, figure 113. The separators will be covered with white sulphate. Chemical action is very sluggish in such cases.

If you find that the separator pores are still open, leave the separators in place and proceed to separate the plates that are touching. How? That depends on what insulating material you have available that is thin enough. If nothing else is available, take a piece of new dry separator about $\frac{3}{8}$ inch to $\frac{1}{2}$ inch square, or a piece of pasteboard the same size. Use a screw driver or putty knife to separate the plates far enough to insert the little piece of insulation as in figure 127. Free all the shorts in this way, unless you have some old, perforated, hard, sheet rubber available from Vesta, Exide or vehicle batteries. In this case,

break off some narrow strips $\frac{3}{4}$ inch wide or less, put two together and repeat the operation as above, using the rubber strips instead of the pieces of separator. Insert down $\frac{1}{2}$ inch or so and bend

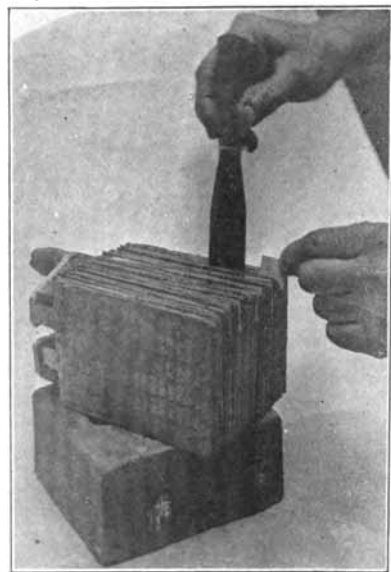

Fig. 127. Freeing Shorts

over and break off; then repeat with the rest of the shorts until all plates have hard rubber between them. Occasionally the upper edges of the plates are shorted out, in which case they must be treated the same way.

Charging.

When you have in this way freed all the "shorts" in the elements place the elements back in the jars in the same position as they were when you opened the battery, and add enough distilled water to the electrolyte to cover the plates to a depth of one-half inch. The next operation is to put the battery on charge. Grasp each post in the jaws of a pair of gas pliers and work the pliers back and forth, figure 128, so as to remove the scale and allow the connecting



Fig. 128. Cleaning Scale From Posts Before Replacing Connectors Temporarily for Charging

straps to make good contact. Now take a knife and cut off the rough edges left in the connecting straps by the drill. Taper the edge, if necessary to go on post. Turn the connectors upside down and pound gently in position, figure 129, to make a good connection. This being properly done, the battery is ready for charging. Check up the connections to be sure they are correct.



Fig. 129. Tapping Connectors in Place, Preparatory to Charging after Battery has been Opened and Shorts Removed

Now put the battery on charge, and charge at about one-third of the starting charge rate in amperes. Do not allow the temperature of any cell to rise above 105°F. Continue the

charge until the electrolyte clears up, and its specific gravity tests 1.280-1.300, and the plates have a normal color. Fully charged positive plates have a chocolate brown color, and fully charged negative plates have a light gray color. Do not take the battery off charge until you have obtained these results, although it may be necessary to continue the charge for two, three, four, or five days. The battery must stay on charge until you have the desired conditions. If one cell does not charge,—that is, if its specific gravity does not rise,—you have probably not freed all the shorts, and must take the element out of the jar again and carefully inspect it for more shorts.

Right here is where one of the most important questions may be asked about rebuilding batteries. Why must you free the shorts and put the battery on charge? Why not save time by putting in all new separators, sealing the battery, burning on the top connectors, and then putting it on charge? If you have ever treated a battery in this way, what results did you get? Why did you have a badly unbalanced gravity of electrolyte? How could you know what specific gravity electrolyte to put in each cell? Perhaps one was charged, one only half charged, and the other dead. Suppose the dead cell had impurities in it. How could you get rid of them? Suppose the battery showed poor capacity on test, what would you do?

The battery is put on charge because you cannot do an A No. 1 job of repairing in any other way. The chemical actions caused by the charging current passing through the cells for a long time have:

(a) Removed all possible impurities, with the exception of iron, which is sometimes permanent.

(b) Worked the active materials and put them in a healthy condition, just as exercise strengthens your body and improves your health.

(c) Put all the plates in the same condition chemically, so that all can be handled further in the same way.

(d) Put the plates in the best possible condition to be worked on. The positive plates are as soft as they can be made to be. They can now be straightened more easily and with less danger of cracking. The negative plates are also as soft. The spongy

lead is in the best condition to press firmly into the grids, as described later.

Let it be impressed on your mind that the foregoing is one of the **most important** factors in the rebuilding of batteries. Your success in rebuilding old batteries depends much upon the thoroughness with which you follow these instructions. If you want to succeed, you **must** be careful and accurate. You **cannot** expect to have your rebuilt batteries efficient and deliver their proper amount of current if worked over in a careless, haphazard and know-not-why method.

The minute you begin to use this Standard Method and follow instructions minutely, you emerge from the guess way, the know-not-why, indefinite way, groping from one operation to another. The auto battery business has arrived at a stage where the battery owner demands better work and will find the man **who knows how** to do the work in the **right way**, not occasionally by the guess way, but can tell him **how** it should be done, and **why** it should be done, and show him by his finished work that he can do as good work as the factory, because he specializes on old batteries and takes time and pains with each job. Impress upon your mind the importance of doing every job the very best you possibly can by a **Standard** process. Make the rebuilt battery look as neat, and good as a new battery, so that you will not be ashamed to put your name on it.

Washing and Pressing.

To continue the actual work on the battery. The battery being fully charged,—the electrolyte clear, the plates of normal color, the specific gravity no longer rising,—remove it from the charging bench and put it on the work bench. Draw each element and let drain as in figure 111.

Here again the labelled boxes described on page 139 come in handy. Separate one group, remove the separators, and put one group in each end of box to keep clean. Separate another group, and nest the plates, figure 130, the negative with the negative, and positive with positive. Separate the third element and put groups in the boxes. You now have the plates in the best possible shape for handling. Take the boxes containing the plates to the

sink. Have a vise or press and the transite boards ready for use.

If, for any reason, you are called away from your work at this point to be gone for five minutes, do not leave the fully charged negatives exposed to the air, as they will become very hot and will be injured. Cover them with water. A one-gallon stone or earthenware jar will hold the negative plates of a 100 ampere hour battery if you nest two of the groups. You may also put negatives back in jars from which they were taken, and fill with water.

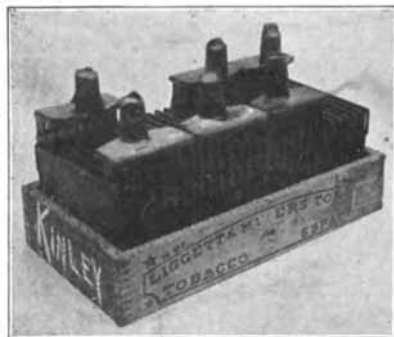

Fig. 130. Nested Plates in Handy Box for Keeping Them Clean

Now hold a negative group under the faucet, and let a strong stream of water run down over each plate so as to wash it thoroughly, and to remove any foreign matter from the plate surfaces. This is one of the "standard" operations, and all negative groups must be handled in exactly the same way so as to get the same results in each case.

After you have washed the first group, place it on edge on a clean board with the post down and pointing away from you, and the bottom of the group toward you. Now insert transite or hard wood boards which are slightly larger than the plates, and of the exact thickness required to fill the spaces between plates, figure 131. For the standard $\frac{1}{8}$ inch plates, the

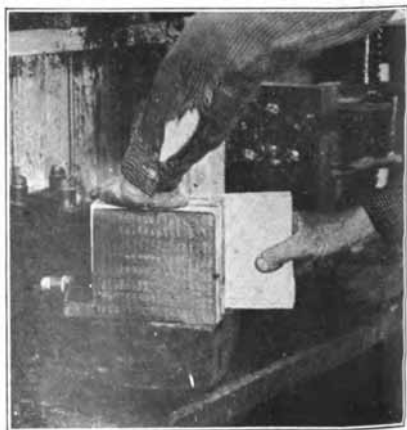

Fig. 131. Inserting Transite Boards Between Negatives, Preparatory to Pressing

boards should be 9-32 inch thick. If you do not happen to have boards of this thickness, use two boards, each $\frac{1}{8}$ inch thick and a piece of cardboard 1-32 inch thick. Never push the boards more than $\frac{1}{8}$ inch above the tops of the plates, and be sure that they cover the entire plates.

Obtain two blocks, each $1\frac{1}{2}$ to 2 inches thick, 6 inches wide, and 7 inches long. To the end of one of these, nail a piece 1 inch thick, 6 inches long, and 6 inches wide, this latter piece to rest on the sliding jaw and inside of the vise, and the 6 by 7 piece against the jaw farther from you. Place the negative group in the vise, and resting on the 6 by 6 piece at the bottom of the vise. Place the second 6 by 7 piece against the movable jaw of the vise. Be careful not to let either of the 6 by 7 blocks extend more than $\frac{1}{8}$ inch beyond the top of the plates, or you may break off some of them.

Now screw up the vise as tightly as you can. While this group is in the vise, hold another negative group under the faucet and wash it thoroughly, and place on a board as you did the first one. Take the first group out of the vise, and put it to the left of the group on the board. Take the transit boards out of the group removed from the vise, and put them in the second group. Now put the second group in the vise. Put the first group in the box to protect it from injury. Repeat this operation for the third group of negatives, and you have the negatives in as good a condition as it is possible to get them. All three groups may be pressed at once in the Plate Press, as shown in figure 77. If you have done the job in a first class workmanlike manner, the negatives will pass inspection by the most expert battery man, and be pronounced O.K. Many negative groups treated by this process will be good after fifteen months to two years of service after reassembling, and will, at the end of that time, really justify a rebuild. Keep the negatives in a stoneware jar filled with water. Never expose fully charged negatives to air more than five minutes.

The next step is to wash the positives. These should not be held under the faucet as were the negatives, as this would dislodge much of the active material. Dip the positives up and down a number of times in a jar of clean water to remove im-

purities and wash off foreign or loose materials from the surfaces of the plates. As you wash each positive group, replace it in the box to protect it from injury.

The groups are now ready to be worked on. If you have decided to burn on several new plates, proceed as described below. The negatives which are to be used again require no further work, as the charging, washing, and pressing have put them in the best possible condition. Positives which are to be used again should now be straightened if they are warped or buckled. Positive plates, when fully charged, and just taken out of the cell, may be straightened somewhat by inserting between them transite boards the exact thickness of the distance between the plates, and pressing the group slowly in a vise or Plate Press for five minutes. Do not apply too much pressure. If the edges are still buckled, use a pair of thin, wide nosed pliers and straighten them, being very careful not to crack the edges. Do not straighten all the distortion at any point at once, but move the pliers all along the edge, bending only a little at a time until the plate is straight. If you are careful, and straighten all four edges, and not much paste has dropped from the grids, it may be possible to use the plates again. If the plates are only very slightly buckled, straighten them with pliers only, and put them back in commission.

Burning on Plates.

When you put new plates into a battery, or find some of the plates broken from the connecting strap, it will be necessary to burn the plates to the strap. Frequently you will find plates which are otherwise in a good condition broken from the connecting straps. This is most likely to happen when the plates have been cast on to the connecting strap instead of being burned on. These plates must be burned on.

New plates are frequently necessary. From pages 201 to 207 you see that new plates are required under the following conditions:

(a) **Positives.** Ruined by freezing; weak and brittle from age, with large part of active material shed; hard, cracked, and

shiny active material; badly buckled; charged while dry; rotten and disintegrated by impurities; ruined by overcharging; badly sulphated because allowed to stand idle, or used while discharged; softened active material.

(b) Negatives. Active material granulated, bulged, and disintegrated; charged while dry; positives disintegrated by impurities; ruined by overcharging; badly sulphated because allowed to stand idle, or used while discharged, or active material dropped from grids.

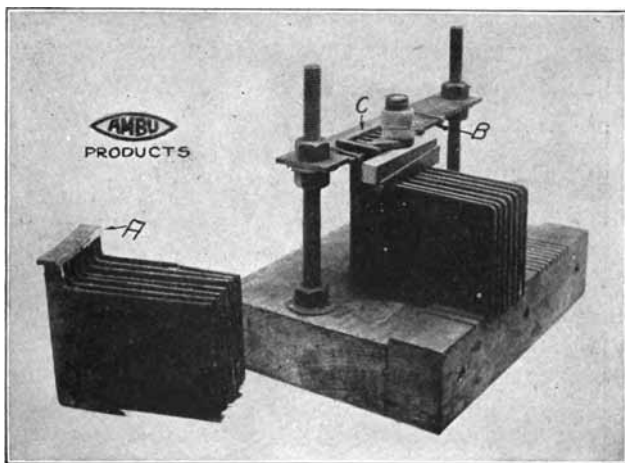

Fig. 132. Burning Rack

When making plate renewals, never install plates of different design or age in the same group. Always use plates of the type intended for the battery. The positive group need not be of the same age as the negatives, however, but all the plates of one group should be of the same age and type.

The following directions will explain every step in burning plates to the straps. The battery should first be fully charged, as already explained. If all the plates in a group are to be discarded, clamp the post in a vise, being careful not to crack the hard rubber shell if one is on it, or to damage the threads on posts such as the Exide, or to draw up the vise so tightly as to crush the post. Then saw off all the old plates with a hack saw, close

to the post as shown in figure 132 at A. This separates the entire group of plates from the post in one short operation. This method is much better than the old one of sawing the plates off below the connecting strap, and sawing or punching the old plate ends out of the strap.

Now set the new plates in the rack, figure 132, and set the adjustable guide bar so that the tops of the lugs on the plates extend above it a distance equal to the thickness of that part of the plate strap which is still attached to the post. With the plate lugs in the slots of the guide bar, put the bar shown at B in figure 132 in

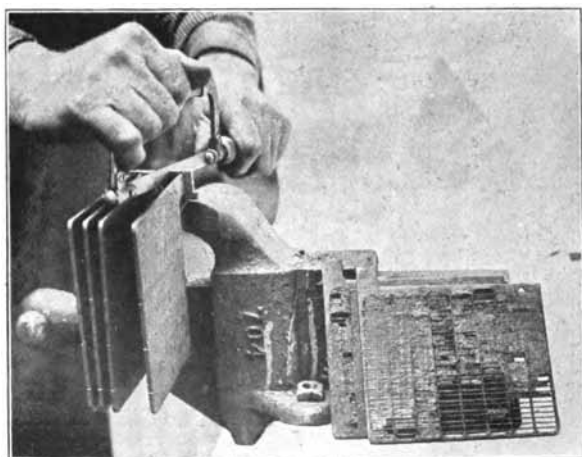

Fig. 133. Sawing Slot in Plate Connecting Strap

place and fasten it with two loops of wire as shown. Tie some asbestos around the post, and put in position as shown, one edge resting on the bar B, and the other held up by two wooden wedges. Next place the U-shaped piece of iron around the ends of the plate lugs, and the post, as shown at C in figure 132. This prevents the melted lead from running off. Clean the surfaces of the lugs and edge of the part of the old connecting strap still attached to the post.

Now apply your lead burning flame, and heat up the ends of the plate lugs and the edge of the part of the strap attached to the post, until they begin to melt. Then melt in

burning lead until the tops of the plate lugs are just covered. This will give you a perfect joint between the post and the plates, and will require much less time than if you had sawed off all the plates below the connecting strap, and had sawed out the ends of the plate lugs.

If one or two of the outside plates only are to be renewed, saw these off just below the connecting strap. If one or more of the inner plates are to be removed from the group, grasp the plate lug near the connecting strap with a pair of long and rather flat nosed pliers. Bend the plate back and forth with the pliers

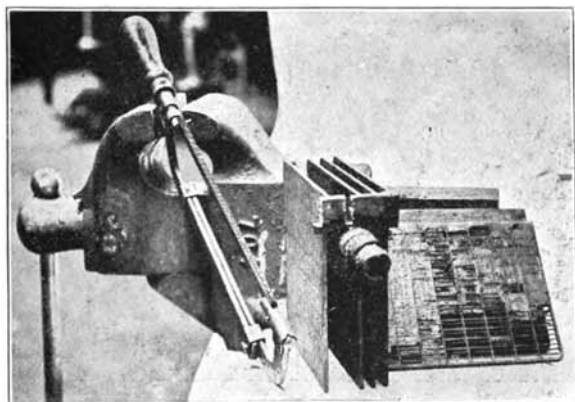

Fig. 134. Slotted Saw, a group with two Plates removed, and Slots in Connecting Strap for New Plates

until it breaks off. Battery manufacturers make and sell special plate punches for removing individual plates, and these may be used instead of slotting with a saw.

Having removed the defective plates, saw slots in the strap, figure 133, exactly in the same place where the old lug was burned in. Make the slot of the proper depth for the lug of the new plate. Figure 134 shows the slotting saw, the group in the vise, and the defective plates to one side. Two regular slotting saws are placed in an ordinary hack saw frame so as to saw the full width of the slot, $\frac{1}{8}$ inch, in one operation.

Figure 135 shows the method of lengthening a plate lug. It will be necessary to lengthen the lugs on plates which have been

broken from the strap, but which are otherwise in a good condition, and are to be used again. For a guide use a piece of $\frac{1}{8}$ inch thick strap iron, $\frac{3}{4}$ to 1 inch wide. Cut notches in this iron having the same width as the plate lug which is to be lengthened, and put the iron and the plate on a sheet of asbestos, figure 135. Melt the lead in the notch until the desired length is obtained.

Mount the group and the new plate in the burning rack, similar to the way shown in figure 132, with the lug of the new plates

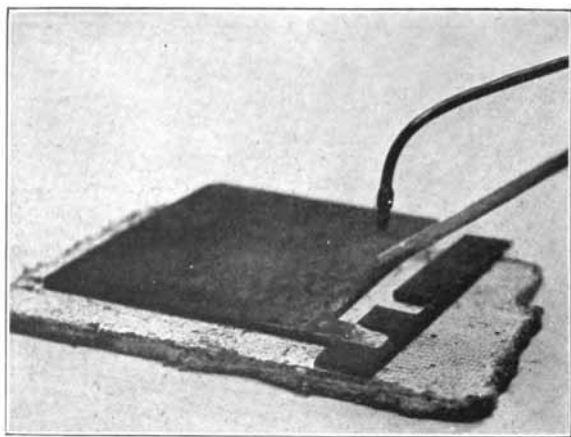

Fig. 135. Extending Lug on Plate

fitting in the slots which you sawed in the connecting strap. Clean all the surfaces which are to be melted together, and melt in the burning lead as previously described.

Reassembling the Elements.

Take a negative group and put it on edge on a board, with post away from you, and lower edge toward you. Examine the "hold down" blocks, figure 3; if one side has been worn slightly by the separators but the block is otherwise in a good condition, turn it over, and place worn side toward the top; if any hold down is soft and rotten, replace it with a new one. Always make sure



Fig. 136. Putting In New Separators

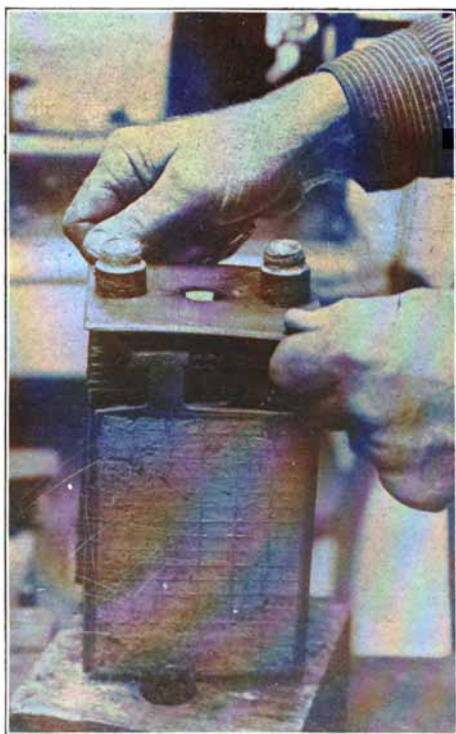

Fig. 137. Trying on a Top Cover

that the hold downs are in good condition, and are securely fastened.

Take a positive and a negative group and place in position as in figure 136. The groups are now ready for the separators. Take six separators in your left hand and bend as shown in figure 136. Take one with your right hand and slip it into position from the bottom in the middle of the group, with the grooved side toward the positive plate, as in figure 136. Take another separator from your left hand and slip it into position on the opposite side of the positive against which your first separator was placed. In this way, put in the six separators which you are holding in your left hand, with the grooved side toward the positives, working outward in both directions from the center.

Now grasp the element in both hands, and set it right side up on the block, giving it a slight jar to bring the bottoms of the plates and separators on a level.

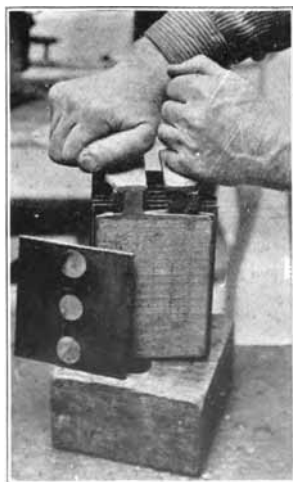

Fig. 138. Getting Posts in Right Position to have Cover Fit. Only a few Separators are in Place

Next take a top cover, and try it on the posts, figure 137. Pull the groups apart slightly, if necessary, before inserting any more separators, so that the top fits exactly over the posts, figure 138. See that the separators extend the same distance beyond each side of the plates. You may take a stick, about 10 inches long, $1\frac{1}{2}$ inches wide, and $\frac{7}{8}$ inch thick, and tap the separators gently, figure 139, to even them up. If you put in too many separators before trying on the cover, the plates may become so tight that you may not be able to shift them to make the cover fit the posts or you may not be able to shift the separators to their proper positions. It is therefore best to put in only enough separ-

ators to hold the groups together and so they can be handled and yet remain in their proper position when set up on block.

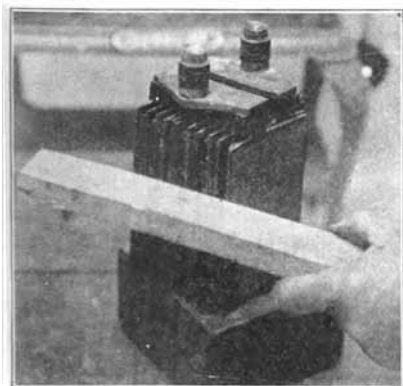

Fig. 139. Tapping the Separators Gently to Make Them Even on Both Sides of Plates

With the element reassembled, and the remaining separators in their proper positions, see that all the plates are level on bottom, and no foreign matter sticking to them. Place the element in box to keep clean. Reassemble the other elements in exactly the same way, and put them in the box. The elements are now ready to be put in the jars.

Repairing the Case.

Empty the old acid from the jars, take the case to the sink (or tub), and wash out all the sediment, figure 140. With the pipe shown in figure 54, you have both hands free to hold the case, as the water is controlled by a foot operated spring cock.

If the case needs repairing, now is the time to do it. If the case is rotten at top, patch it with good wood. If the top and bottom are so rotten that considerable time will be required to repair it, advise the owner to buy a new case. Nine times out of ten, he will do just as you advise, if you are honest with him. Sometimes the top of the case can be greatly improved by straightening the side edges with a small smoothing plane, and sometimes a $\frac{1}{2}$ inch strip or more fitted all along the edge is necessary for a good job.



Fig. 140. Washing Sediment from Jars. Water Supply Controlled by Foot Operated Valve or Cock

Handles that have been pulled, rotted, or corroded off make disagreeable repair jobs, but a satisfactory job can be done un-

less the end of the case has been pulled off or rotted. Sometimes the handle will hold in place until the battery is worn out by old age if three or four extra holes are bored and countersunk in the handle where the wood is solid, and common wood screws, size 12, $\frac{1}{2}$ or $\frac{5}{8}$ inch long, used to fasten the handle in place. Sometimes it will be necessary to put in one half of a new end, the handle being fastened to the new piece with brass bolts and nuts before it is put into place. Sometimes you can do a good job by using a plate of sheet iron 1-16 inch thick, and 4 inches wide, and as long as the end of the case is wide. Rivet the handle to this plate with stove-pipe, or copper rivets, and then fasten the plate to the case with No. 12 wood screws, $\frac{1}{2}$ inch long.

If the old case is good enough to use again, soak it in a solution of baking soda in water to neutralize any acid which may have been spilled on or which may be spilled on it later. After soaking the case, rinse it in water, and allow it to dry thoroughly. Then paint the case carefully with hot asphaltum paint.

Putting in New Jars.

When you have washed out the jars, examine them carefully under a good light. If you find any crack or hole, no matter how small it is, remove the old jar and put in a new one. In order to remove a jar, it is necessary to soften the sealing compound, and the heat may be applied in several ways:

1. Place case in the four compartment heater described on page 193.

2. Fill the jar with boiling water if they will hold water, cover up and allow it to stand for at least fifteen minutes.

3. Use the Battery Steamer described on page 140.

If only one jar is to be removed, put the steam hose directly in the jar. Cover the top of the jar with rags or paper to hold in the steam. Steam for half an hour.

If all the jars are to be removed, put the case containing the jars into the steam box and turn on the steam. Keep steam flowing for one-half hour or more.

When you have softened the compound by one of the above methods, grasp the jar with two pairs of pliers and pull it straight

up. If the jar will not lift out easily, heat an old small cross cut or compass saw blade hot with a blow torch, run the blade down on each side and end of the jar so as to cut away the compound. Then loosen the compound under the bottom of the jar by one of the three methods described above.

After removing the jar, inspect the inside of the case and remove anything which may make it difficult to put in a new jar.

Now heat the new jar with a blow torch, being careful not to burn it. A good thing to use here is a block of wood which fits the inside of the jar somewhat snugly, figure 141. This will prevent the jar from being broken when it is put in the case. Instead of this, the assembled elements may be put in the jar to prevent it from breaking.

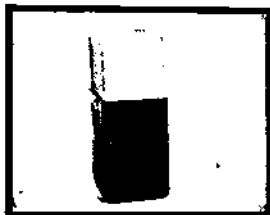

Fig. 141. Wooden Block to Protect Jar

Pour about one inch of hot compound in the space which the new jar is to occupy. Push the heated jar down into place. Be sure that the top of the new jar is level with the other jars in the case. Otherwise you will have trouble in burning on the connectors, and your finished battery will look as if a novice had done the job.

Putting Elements in Jars.

With the case ready, look for the "+," "P" or "POS" mark on it. Place the case so that this mark is toward you. Put an element in the jar nearest the mark, with the positive post toward you, next to the mark. Put an element in the next jar so that the negative post is toward you. Put an element in the next jar so that the positive post is toward you, and so on. The elements are correctly placed when each connecting strap connects a positive to a negative post. If the case has no mark on it, reassemble exactly according to the diagram you made on the tag before you opened the battery.

It is well to play the flame over the tops of the jars to soften them somewhat, so that there will be no danger of breaking a jar when you put in the elements. If an element fits loosely

in the jar, it must be tightened. The best way to do this is to put one or more separators on one or both sides of the element before putting it in the jar, figure 142. If you leave the elements loose in the jars, the jolting of the car will soon crack the sealing compound, and you will have a "slopper" on your hands.

Filling Jars with Electrolyte.

With all the elements in place in the jars, the next step is to fill the jars with electrolyte. It has been found from hundreds of battery jobs that it is best to fill the jars with electrolyte before the covers are put on, or the top connectors burned in. There are several reasons for this:

(a) Remember that those plates which are to be used again are fully charged. If the negatives are now exposed to the air while putting on covers and burning in the top connectors, they will become very hot and may be ruined.

(b) In setting new jars or changing from an old case to a new one, the hot compound, which was poured in the space to be occupied by the new jar, may foam up when the heated jar is pushed down into place and run over the top of the jar. If there is no electrolyte in the jar, the compound runs down over the plates and can be removed only with difficulty. On the other hand, if the jar has been filled with electrolyte, any compound which runs over the top of the jar cools as soon as it strikes the electrolyte, and floats on the surface of the electrolyte, and is easily removed. This also happens sometimes in pouring compound on top covers. With electrolyte in the jars, sealing compound can generally be fished out.

(c) When lead burning without electrolyte in the jars, the com-



Fig. 142. Tightening an Element in Jar by Placing a Separator on Outside Negative

pound around the posts often melts and runs out on top of covers. The electrolyte helps in keeping the post cool and prevents the melting of the sealing compound.

A two-quart earthenware, glass, or crockery pitcher should be used in handling the electrolyte. If you have a lead funnel, use it, so as not to spill any acid on the case, jars, or posts. Pour in the new electrolyte until it covers the plates to a depth of $\frac{3}{8}$ inch.

If you have followed the directions carefully, and have therefore freed all the shorts, have thoroughly charged the plates before separating the groups, have washed and pressed the negative groups, have washed the positives, have then added any new plates which were needed, and have put in new separators, use 1.400 specific gravity electrolyte. This is necessary because washing the plates removed some of the acid, and the new separators will absorb enough acid so that the specific gravity after charging will be about 1.280-1.300.

The final specific gravity must be 1.280-1.300. In measuring the specific gravity the temperature must be about 70°F, or else corrections must be made. For every three degrees above 70°, add one point (.001) to the reading you obtain on the hydrometer. For every three degrees under 70°, subtract one point (.001) from the reading you obtain on the hydrometer. For instance, if you read a specific gravity of 1.275, and find that the temperature of

the electrolyte is 82°F, add $(\frac{82-70}{3}=4)$ four points (1.275+.004),

which gives 1.279, which is what the specific gravity of the electrolyte would be if its temperature were lowered to 70°. The reason this is done is that when we speak of an electrolyte of a certain specific gravity, say 1.280, we mean that this is its specific gravity when its temperature is 70°F. We must therefore make the temperature correction if the temperature of the electrolyte is much higher or lower than 70°F.

Remember that you cannot charge a battery by adding acid to the cells. True, you may bring up the specific gravity, but specific gravity is a true indication of the condition of charge only when the exactly correct amount of acid is contained in the battery,

and if there is either too much or too little acid, the hydrometer readings are misleading. If the specific gravity of a cell refuses to come up to 1.280-1.300 after long continued charging, make a cadmium test (page 266) to see if plates are fully charged. If the test indicates that they are, add 1.400 electrolyte until the gravity of the cell reads 1.280-1.300.

Putting on the Covers.

After filling jars with electrolyte play the flame over the tops of the jars until the compound sticking to them is somewhat soft.

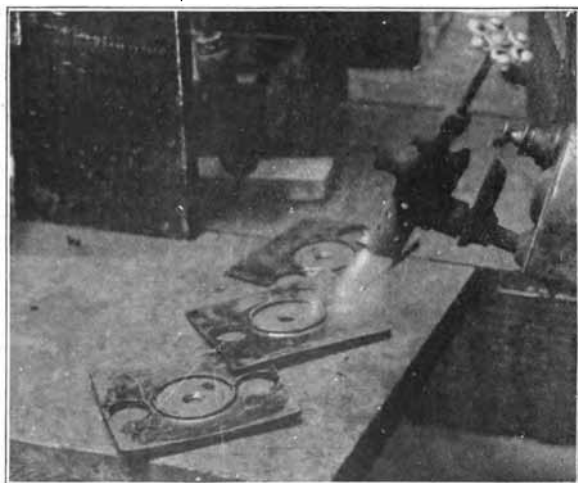

Fig. 143. Heating Lower Covers Before Replacing on Battery

Then, with a narrow putty knife, scrape off all the compound you can from inside of jar. Wipe off the rest with a rag saturated with gasoline. (Be careful with fire near gasoline.) It is also a good plan to scrape the inside edges with a knife, since the cleaner you make the edges, the better will the contact with the compound be.

The next operation is a particular one, and must be done properly, or you will come to grief. Get the box labeled for the battery you are working on, take the bottom and top covers, and

clean them thoroughly. There are several ways to clean them. If you have gasoline at hand, dip brush in it and scrub off the compound. The covers may also be cleaned off with boiling water, but even after you have used the hot water, it will be necessary to wipe off the covers with gasoline. Another way to soften any compound which may be sticking to them, is to put the covers in the Battery Steamer and steam them for about fifteen minutes.

With the covers clean, seat yourself at the work bench and lay the inside covers on a board beside you, and play the flame over them, as in figure 143, and warm them through. Be careful not to burn them. The covers will now be soft enough to place them in position on the cells without breaking them. The tops of the jars should also be warmed slightly before you put on the lower covers, to avoid cracking them.

If the covers fit snugly all around the inside of the jars so that there is no crack which will allow the compound to run down on the elements, all is well and good. If, however, there are cracks large enough to put a small, thin putty knife in, you must close them. If the cracks are due to the tops of the jars being bent out of shape, heat the tops until they are limp, (be careful not to burn them). With a screw driver clean all around the outer edges of the jars and inside edge of case. Now, with short, thin wedges of wood, (new dry separators generally answer the purpose), crowd down on the outside edges of the jar, until you have the upper edge of jars straight and even all around. If the cracks between cover and case still remain, calk them with asbestos packing, tow, or ordinary wrapping string. Do not use too much packing, just enough to close the cracks is sufficient. When this is done, see that the top of the case is perfectly level, so that when the compound is poured in, it will settle level all around the upper edge of the case.

Sealing Compounds.

There are many grades of compounds, and the kind to use must be determined by the type of battery to be sealed. There is no question but that a poor grade used as carefully as possible will ~~crack~~ crack and produce a slopper. A battery carelessly sealed with the best compound is no better.

The three imperative conditions for a permanent lasting job are:

1. Use the best quality of the proper kind of compound for sealing the battery on hand.
2. All surfaces that the compound comes in contact with must be free from acid and **absolutely clean and dry**.
3. The sealing must be done conscientiously and all details properly attended to step by step, and all work done in a workmanlike manner.

With respect to sealing, batteries may be divided into two general classes. First, the battery with a considerable bulk of sealing compound, the quantity depending principally on the amount of compound used around the edges of case to hold the elements in position and tight around the posts. This type of battery generally has a lower and an upper cover, the well being attached or detached, depending on the design. The compound is poured in a bulk on top of the lower cover and around the wells, and when it is hard, the top covers are put on. Now with this type most of the batteries you come in contact with have a thin hard rubber shell shrunk on the post where the compound comes in contact with it; this hard rubber shell usually has several shallow grooves around it which increase its holding power. This is good construction provided everything else is normal and the work properly done with a good sticky compound. There are a few batteries with low down connecting straps close to top of covers, and the compound is poured all over the top of the straps. Sometimes this type gives good service.

The second general type consists of those batteries that have small cracks or spaces around the jars next to the covers and have a threaded post with nuts to screw down on covers to hold in position, or some special means of holding the covers in position. This type of battery is gaining in popularity, and when properly designed and built makes a very satisfactory battery. Of course, in rebuilding this kind of battery, just as in all kinds of repair work, if the job is worth doing at all, do it as well as you possibly can. Have the edges coming in contact with the pitch or compound absolutely clean, have the covers fitting snugly all around

the inside of jars before pouring; have the pitch (or special compound for this kind of sealing) hot and thin, pour the cracks full and let cool, and when cold make a second pouring; when again cold, clean off level with top with putty knife if necessary.

Pitch is sticky stuff. The best way to handle it is, when you receive it, to melt it and strain it through some window screen wire into a small, narrow, long box and keep it covered. The best tool to take some pitch out of box is a chisel made of a piece of old flat spring, or file. Heat one end red hot, and hammer to taper point, grind square and sharpen. Then as you need only a little pitch at a time, heat the sharp edge of the chisel and cut out only as much as you need. If you do not handle it in this way, you will get pitch all over yourself.

When pitch burns on bottom of pan, clean it all off, throw it away, and put in fresh, or you will not be able to melt it thin enough, to do a good job. Pitch is sometimes used in sealing motorcycle batteries.

Compound in bulk or in thin iron barrels can be cut into small pieces with a hatchet or hand ax. To cut off a piece in hot weather, strike it a quick hard blow in the same place once or twice, and a piece will crack off.

Sealing the Battery.

Always start the fire under the compound before you are ready to use it, and turn the fire lower after it has melted, so as not to have it too hot at the time of pouring. If you have a special long-nosed pouring ladle, fill it with compound by dipping in the pot, or by pouring compound from a closed vessel. If you heat the compound in an iron kettle, pour it directly into pouring ladle, using just about enough for the first pouring. The compound should not be too hot, as injury to the battery will result from its use.



Fig. 144. Pouring Compound on Top of Lower Covers

Pour compound on the lower covers, as in figure 144. Use enough

to fill the case just over the tops of the jars. Then pour the rest of the compound back in compound vessel or kettle. Now take the sealing iron, which should be nearly red hot, and quickly run it all around the edge of the case and next to the outside of the jars, melt-



Fig. 145. Using Very Hot Sealing Iron Around Case

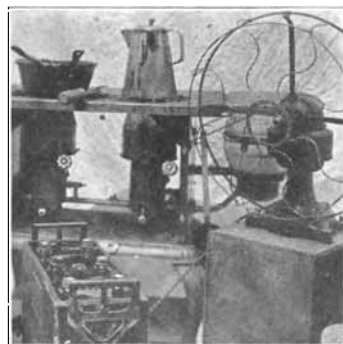

Fig. 146. Cooling Hot Compound with Electric Fan

ing the compound thin, driving off any possible moisture, and making a good joint between the compound and the outside edges of the jars, as in figure 145. To complete the job, and make as good a job as possible, take a small hot flame and run it around the edges of case, tops of jars, and around the posts until the compound runs and makes good contact all around. If you have an electric fan, let it blow on the compound a few minutes to cool it, as in figure 146. Then, with safety, the compound used for the second pouring may be hotter and thinner than the first.

Fill the pouring ladle with compound which is thinner than that used in the first pouring, and pour within 1/16 inch of the top of the case, being careful to get in just enough, so that after it has cooled, the covers will press down exactly even with the top of the case. It will require some experience to do this, but you will soon learn just how much to use.

As soon as you have finished pouring, use the flame as in figure 147, and run it all around the edges of the case and around the posts, being very careful not to injure any of the wells. A small, hot-pointed flame is safer than

a large, spreading flame for this purpose. Now turn on the fan again to cool the compound.

While the compound is cooling, get the connecting straps and terminal connectors, put them in a two-quart granite stewpan, just barely cover with water, and sprinkle a tablespoon of baking soda over them. Set the stewpan over the fire and bring water to boiling point. Then pour the water on some spot on a bench or floor where the acid has been spilled. This helps to neutralize the acid and keep it from injuring the wood or cement. Rinse off the connectors and wipe them dry with a cloth, or heat them to dry them.

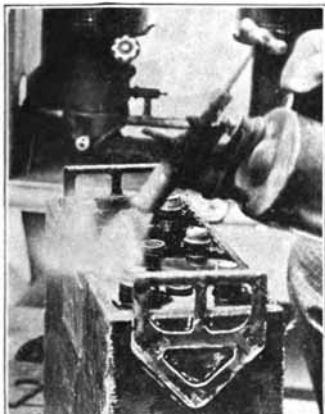

Fig. 147. Heating Compound to Make It Unite with Edge of Case and Around Posts.

Now take the top covers, which must be absolutely clean and dry, and spread a thin coat of vaseline over the top only, wiping off any vaseline from the beveled edges. Place these covers right

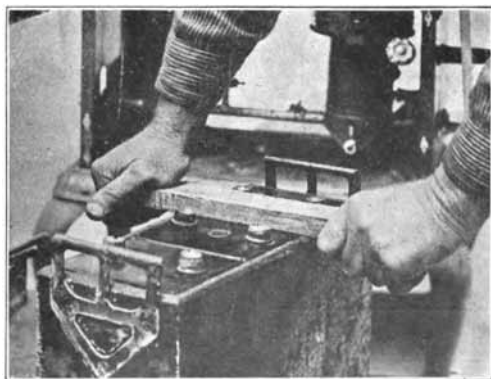

Fig. 148. Pressing Down Top Covers to Make Them Level with Top of Case

side up on a clean board and heat perfectly limp with a large, spreading blow torch flame. Never apply this flame to the under

side of the top covers. The purpose is to get the covers on top of the battery absolutely level, and exactly even with the top of the case all around it, and to have them sticking firmly to the compound. There is not an operation in repairing and rebuilding batteries that requires greater care than this one, that will show so clearly just what kind of workman you are, or will count so much in appearance for a finished job. If you are careless with any of the detail, if just one bump appears on top, if one top is warped, if one cover sticks above top of case, try as you may, you never can cover it up, and show you are a first-class workman. See that you have these four conditions, and you should not have any difficulty after a little experience:

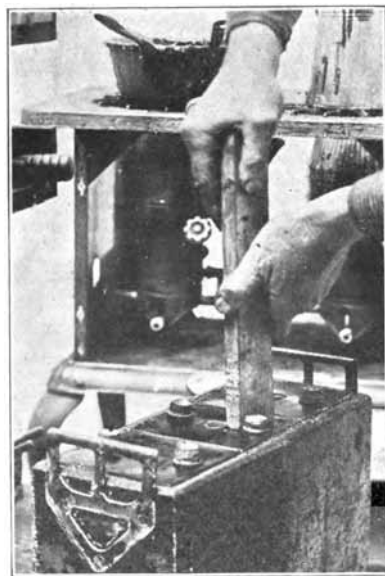

Fig. 149. Pressing Down Top Covers Around Posts to Make Them Flush with Case

1. You must have **just enough** compound on top to allow the top covers to be pressed down exactly even with upper edge of case.

2. The top covers must be absolutely clean and have a thin coat of vaseline over their top, but none on the bevel edge.

3. A good sized spreading flame to heat quickly and evenly the tops to a perfectly limp condition without burning or scorching them.

4. Procure a piece of $\frac{7}{8}$ inch board $1\frac{1}{2}$ inches wide and just long enough to go between handles of battery you are working on, plane the edges straight, round the corners a little, and have the ends sawed square. Spread a thin film of oil or vaseline all over it. Sometimes

with small batteries you need a small piece of board $\frac{3}{8}$ inch thick to go between narrow places.

Quickly heat the covers and also heat the top surface of the compound until it is sticky so that the covers may be put down far

enough and adhere firmly to it. Place the covers in position. Then press the covers down firmly with piece of oiled wood, as in figure 148, applying the wood sidewise and lengthwise of case until the top of cover is exactly even with the top of the case. It may be necessary to use the wood on end around the wells and posts as in figure 149, to get that part of the cover level. If the compound comes up between covers and around the edges of the case, and interferes with the use of the wood, clean it out with a screw-driver. You can then finish without smearing any compound on the covers.

When you have removed the excess compound from the cracks around the edges of the covers with the screw-driver, take a large iron spoon which has the end bent into a pouring lip, and dip up from $\frac{1}{2}$ to $\frac{2}{3}$ of a spoonful of melted compound (not too hot). Wipe off the bottom of the spoon, figure 150, and



Fig. 150. Wiping Bottom of Spoon Filled with Sealing Compound

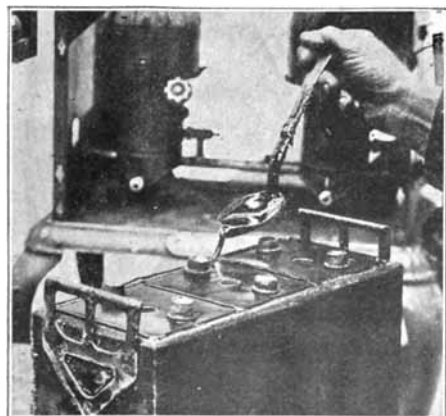

Fig. 151. Pouring Compound from a Spoon Into Cracks Around Covers

pour a small stream of compound evenly in all the cracks around the edges of the covers until they are full, as in figure 151. Do not hold the spoon too high, and do not smear or drop any compound on top of battery or on the posts. No harm is done if a little runs over the outside of the case, except that it requires a little time to clean it off. A small teapot may be used instead of the spoon. If you have the compound at the right temperature, and do not put in too much at a time, you can obtain good results, but you should take care not to spill the compound over anything.

After the last compound has cooled,—this requires only a few minutes,—take a putty knife, and scrape off all the surplus compound, making it even with the top of the covers and cases, figure 152. Be careful not to dig into a soft place in the compound with the putty knife. If you have done your work right, and have followed directions explicitly, you have scraped off the compound with one sweep of the putty knife over each crack, leaving the compound smooth and level. You will be surprised to see how finished the battery looks.

Some workmen pour hot compound clear to the top of the case and then hurry to put on a cold, dirty, and many times a scorched and burned top. What happens? The underside of the cover, coming in contact with the hot compound, expands and lengthens out, curling the top surface beyond redemption. As you push down one corner, another goes up, and it is impossible to make the covers level.



Fig. 152. Final Operation of Cleaning Off Compound with Putty Knife to Make It Flush with Case and Top Covers

In 1915, a batteryman in a large Kansas City shop, while putting cold, dirty covers on hot compound, and having great difficulty in making all the corners stay down, was asked why he put covers on that way. The reply was, "because they stick." In 1918, the men in that shop are trying to put the tops on level and are making an effort to do better work. Why? Simply because they are compelled to, to get work, as their competitors have thinking workmen who take more pains with their work and do better work, and as a result, get the business. If the men in the Kansas City shop do not use their heads and think any better in treating the inside of a battery than they do the covers, it is no wonder their repaired and rebuilt batteries do not give satisfaction.

Burning in the Connecting Straps.

With the covers in place, the next operation is to burn in the top connectors. Place the battery on the floor near the burning bench. With a $\frac{3}{4}$ inch drill, clean off the tops of the posts with one or two turns of the brace, cutting off a clean, thin shaving, as in figure 153. Now put battery on bench, or on the Battery Turntable. With a chisel, $\frac{3}{4}$ inch or more wide, cut the rough edges from the tops of the posts, as in figure 155.

Now take a connecting strap which is dry and free from acid, and put it in a vise, as in figure 156. Clean it with a wire brush, then clean the openings with a knife. Finish each end of the top of strap with a bastard file, as in figure 154. Place the straps in their proper positions on the posts, and with a length of two by four

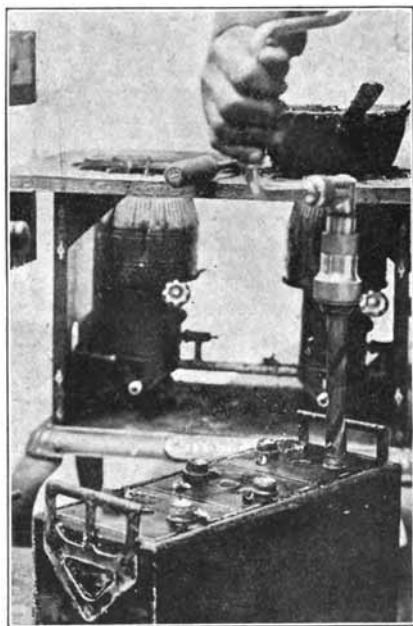

Fig. 153. Cleaning Tops of Posts Preparatory to Burning In

wood, pound them snugly into position, as in figure 157. Be sure the connecting straps are level, and the terminal connectors in the same position as when you took the battery off the car. Always test the voltage of the battery to make sure that the total voltage is equal to two times the number of cells in the battery, this showing that you have connected all the cells in series.

The straps are now ready for burning. Before you bring any flame near the battery, remove the stoppers, and blow out any possible gas with an air hose or hand bellows, figure 102. Then put a long strip of asbestos, $1\frac{1}{2}$ inches wide, over the vent holes, figure 158, or put a $1\frac{1}{2}$ inch square of asbestos over each vent

hole. These serve to protect the wells from the flame, and also keep dirt out of the wells.



Fig. 154. Rasping Terminals and Connecting Links Before Burning In

For burning in the connecting straps you need strips of burning lead about fifteen inches long, and from $\frac{1}{4}$ to $\frac{3}{8}$ inch diameter. This can be made of old plate straps, connecting straps, and terminal connectors. Melt these and run them off in forms. The Burning Lead mold is very useful for this purpose, see page 146.

Figure 85 shows a hydrogen and oxygen burning outfit. A careful study of the same will reveal to you any desired informa-

To make a perfect finish of the compound, turn on a strong flame of hydrogen (no air or oxygen), and quickly run all around the outer edges of the case and between the covers, directly on the compound. You must be extremely careful, however, not to burn the covers.

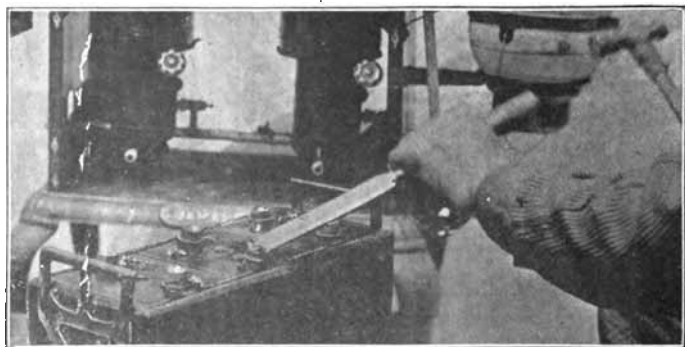

Fig. 155. Chiseling Off Rough Edges from Tops of Posts Before Burning In

tion you wish or need to know to fit one out for yourself that will do the work right if you follow directions, as follows:

Before turning on either the higher hydrogen pressure or the oxygen pressure on regulating valves, see that the regulating valves are turned sufficiently to the left to register 0 when the higher hydrogen and oxygen pressures are turned on. You must

never turn the regulating valves to the left when the higher pressures are turned on. If, when the higher pressures are turned on, the regulating valves register 0, turn to the right slowly

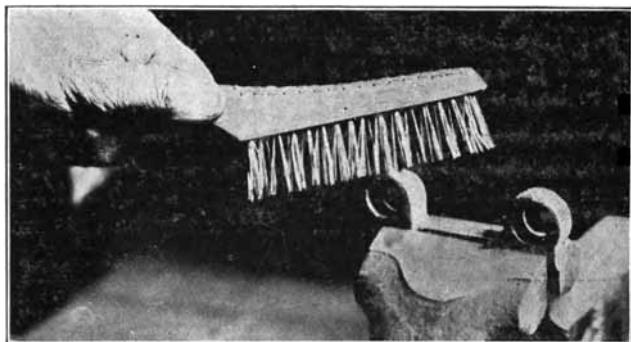

Fig. 156. Cleaning Connector Before Burning In

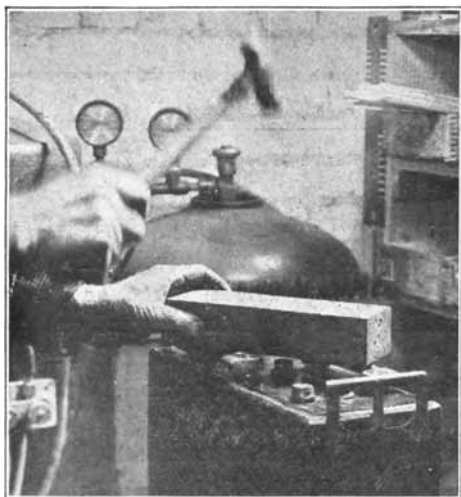

Fig. 157. Leveling Top Connectors Before Burning In

until the pointer registers 4 or 5 pounds while burning a job. Have ready some kind of a pilot light so that you can light the hydrogen without using a match each time.

Turn on the hydrogen slowly, holding the tip to the pilot (the

point on the tip should be the medium sized one with a $1/32$ inch hole). Turn on enough hydrogen to make a flame 2 to 6 inches long, depending on the size of a lug to be burned. Use your judgment and common sense about it; don't try to burn a motorcycle battery lug with a large strong flame, or a heavy terminal with a little bit of a flame. When you have the proper sized flame for the joint to be burned, turn on the oxygen slowly at the mixing or "Y" valve until the flame becomes a pointed hissing flame. Now try it on one of the joints to be burned and play the point of the flame around **on top of post**, holding it **at the distance which melts the lead the quickest**. This can easily be determined by

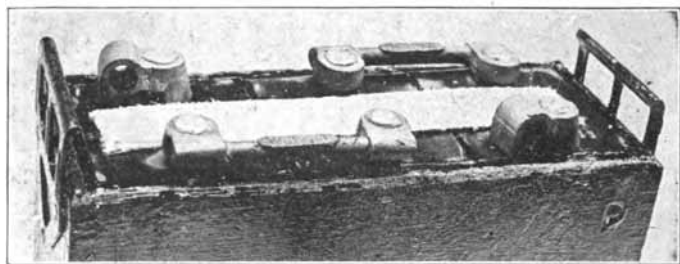

Fig. 158. First Stage of Burning Finished. Note Strip of Asbestos Over Filling Holes

raising the flame up and down slowly. You will note that there is a certain point of the flame which melts the lead more quickly than any other. Keep it at this distance, and as soon as the top of the post is melted, play the flame around and around, melting in lead as fast as you can. Keep it melted all around on top of the post, building up as fast as you can with the melted burning lead. Continue playing your flame around and around, joining the melted burning lead with the melted inside edge of the post, building up until you have enough lead to raise the top of the post (not the whole top, of connector) evenly, $1/16$ inch above the connector. Do not attempt to finish the top with this flame and do not let the flame touch the outside edge of connector. Burn in the rest of the posts in the same way. Figure 158 shows the first stage of the burning completed. Turn off the gas and oxygen.

Take a wire brush and brush off the tops thoroughly, until they are all clean and bright,—then you are ready for the finishing. You need a soft flame, with less oxygen, just bordering on hissing for finishing. Begin directly over center of post just built up. Play the flame on one center until the built up post begins to melt; now shake the flame outward back and forth until the outer edge of connector melts and the top portion of melted post unites and flows to outer edge. Quickly follow around ahead of flowing lead with point of flame until the melted lead has united with the outer edge all round, the object being to melt the **whole** top of the post only, **not** melting **deep** enough to have it break the outer

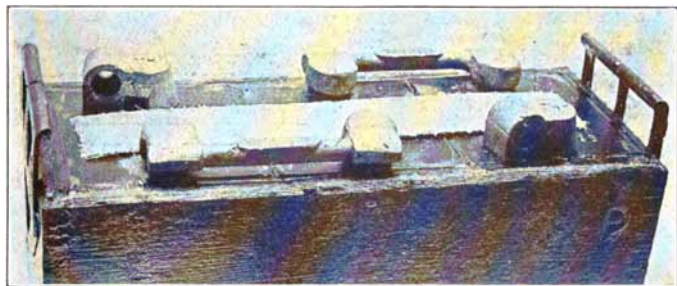

Fig. 159. Second, and Final Stage of Burning Completed

edge and run off, but to melt the whole top as quickly as possible so that it will flow level all over top of connector. Then instantly raise flame from it. All this must be done carefully and dexterously to do a first-class job, and you must keep the flame shaking around over the top and not hold it in any one place, so as not to melt too deep on outer edge or break the outside shell of connector, and allow the lead to run off. Learn to melt just a thin layer all over the top of connector, and then with a quick twist of the hand, draw the flame off at the heaviest part of the connector, and at the same time raise the hand. If you allow the flame to go over the melted lead when you raise it off, it will roughen it. Sometimes the whole mass becomes too hot and the top cannot be made smooth with the flame. Either wait until the connector cools, or soften the flame, or both. Finish all the tops with a soft flame.

Figure 159 shows the second stage of the burning finished. Do not spoil the job by brushing it; do such a good job that it will not be necessary to brush it. You should have a set of stencil letters about $\frac{1}{8}$ inch in size, figure 160, and mark every battery you rebuild or repair. Have your own private date to stamp on connectors, and also the factory date mark. Also stamp "POS" on positive terminal and "NEG" on negative terminal. Record the factory date, mark type of battery in a book, also your date mark and what was done to battery. By doing this, you will always be able to settle disputes that may arise, as you will know when and what was done.

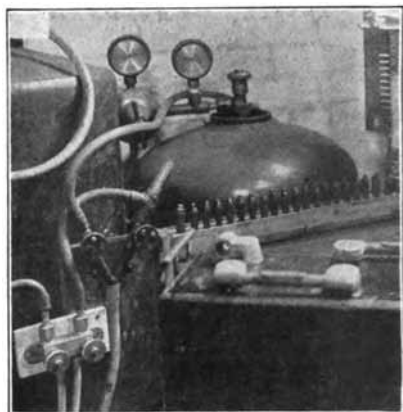

Fig. 160. Stencils and Number Stamps. Hydrogen and Oxygen Mixing Y Valve. Also Prestolite and Oxygen Mixing Valve at Left.

To go one step farther, keep a record of condition of plates, and number of new plates, if you have used any. Grade the plates in three divisions, good, medium and doubtful. The "doubtful" division will grow smaller as you become experienced and learn by their appearance the ones to be discarded and not used in a rebuilt battery. There is no question that even the most experienced man will occasionally make a mistake in judgment, as there is no way of knowing what a battery has been subjected to during its life before it is brought to you. Stamp the POS and NEG marks on, then your initials; then your date of rebuilding and then date of leaving factory.

Directions For Burning in Connecting Straps and Terminal Connectors With Soldering Irons.

There may be some battery men who do not have a gas burning outfit, or there may be emergencies when the burning outfit

is out of commission and it is necessary to burn in a few joints without delay. For these conditions this chapter is given.

Necessary Equipment:

Two soldering irons, weighing 3 pounds each, the ends heated and hammered to long points so that there will be no difficulty in touching tops of posts when connecting straps are on.

One large piece of sal ammoniac. Wire solder. Stick solder will answer the purpose if wire solder is not available.

A plumber's candle for flux.

One quart soldering acid in a two-quart earthen jar; this is for cleaning the iron after tinning it, and **not under any circumstances to be used as a flux with lead.**

One good sized bastard file to keep the scale filed off of soldering iron and for filing tops of straps before soldering.

One good pocket knife with strong small blade for cutting and cleaning holes in connecting straps and terminal connectors.

Some good apparatus for heating irons, either natural gas burners, gasoline burners, or tinner's furnace.

The four essential conditions for a perfect job are:

- 1. Large heavy irons, properly shaped and red hot.**
- 2. Perfectly tinned irons for each joint.**
- 3. The surfaces to be united perfectly cleaned.**
- 4. A tallow candle for flux.**

With these four conditions fulfilled, any man of ordinary ability can, if he follows directions, do a **first-class job.**

With the necessary equipment on hand, put your irons in a hot fire. Put your connecting straps and terminal connectors in a two-quart granite stewpan; barely cover with water; sprinkle a heaping tablespoonful of soda in water, and place on fire and boil. This cleans every atom of acid from them. Remove stewpan from fire and pour soda water on some acid spot on floor. Then rinse the terminals well and place in pile on hot plate and light fire under them and let burn 5 to 10 seconds only to dry (never go away and leave them with fire under them); then turn fire out, clean all straps and connectors thoroughly, either with hand wire brush or circular wire brush run by power. The surfaces to be fused together **must be perfectly clean and bright.**

Now take your $\frac{3}{4}$ inch drill bit in brace and bore a thin shaving off the post,—just enough to bright and clean the top of post. Use your pocket knife or chisel to cut off dirty, ragged edges of post. Blow off all loose dirt on top of posts. Take candle and rub top of posts. Now take the hottest iron, and with coarse file, **clean the four sides** of taper point; then tin thoroughly on the sal ammoniac. Dip point of iron in the soldering acid to clean. Now hold the point of the iron on the top of the post, and at the same time melt some solder on the point of the iron so it will run down off the point of iron and fuse with the melted lead on top of post. Twist the iron back and forth while holding it in a vertical position, so as to mix the melted lead with the melted solder. Repeat this operation on the top of each post, and you have the foundation for a good job of soldering in.

Now place the connecting straps in proper position and level the upper surfaces by gently tapping them with a hammer whose face has been rubbed on sandpaper to clean it. Also put the terminals on exactly as they came off and you are ready to solder in. Rub a little tallow around holes with plumber's candle. Take a cherry hot iron, file the four taper surfaces clean, then tin on block of sal ammoniac, and dip tinned point in acid. Holding the iron perpendicular, place it on top of post and see that it melts the top of post; then as fast as you can, melt solder into hole, turning your iron back and forth so as to have the corners of iron come in contact with surface of inside of hole and melt it, so the solder will fuse with it. When the hole is full of melted solder, draw the iron out, and with flat surface of iron, level the top of post carefully by melting solder so it will flow smoothly, all over top, fusing with the lead. If you have done your work right, you have a perfect joint, notwithstanding the belief that tin will be affected by sulphuric acid.

Cleaning and Painting the Case.

The next operation is to thoroughly clean the case; scrape off all compound that has been spilled on it, and also any grease or dirt. If any grease is on the case, wipe off with rag soaked in gasoline. Unless the case is clean, the paint will not dry. Brush

the sides and end with wire brush; also brush bright the name plate. Then coat the case with good asphaltum paint. Any good turpentine asphaltum is excellent for this purpose. If it is too thick, thin it with turpentine, but be sure to mix well before using, as it does not mix readily. Use a $1\frac{1}{2}$ inch, rather narrow brush, but of good quality. Paint all around the upper edge, first drawing the brush straight along the edges, just to the outer edges of rubber tops. Now paint the sides, ends and handles, but be careful to go around name plate without smearing any paint on it. To finish, put a second, and thick coat all around top edge to protect edge of case. Paint will soak in around the edge on top of an old case more easily than on the body of the case as it is more porous.

Charging the Rebuilt Battery.

With the battery completely assembled, the next step is to charge it at about one-third of the starting or normal charge rate. For batteries having a capacity of 80 ampere hours or more, use a current of 5 amperes. Do not start the charge until at least 12 hours after filling with electrolyte. This allows the electrolyte to cool.

Continue the charge until the specific gravity and voltage do not rise during the last 5 hours of the charge. If you have put in new elements or new plates charge for at least 72 hours.

New battery plates as received from the factory are generally somewhat sulphated, particularly the negatives. When you assemble an element, place it in a jar, and cover with electrolyte, the amount of sulphate increases on both positives and negatives. This action is shown by a drop in voltage caused by extraction of the acid from the electrolyte. The charge should be begun about twelve to fifteen hours after you cover them with electrolyte. It is better to charge the new plates at a low rate, say 5 amperes, and keep the temperature of the electrolyte below 105°F .

Measure the temperature of the electrolyte occasionally, and if it should go above 105°F , either cut down the charging current, or take the battery off charge long enough to allow the electrolyte to cool below 90°F .

Adjusting the Electrolyte.

If the specific gravity of the electrolyte is from 1.270-1.300 at the end of the charge, the battery is ready for testing. If the specific gravity is below 1.270 or above 1.300, draw off as much electrolyte as you can with the hydrometer. If the specific gravity was below 1.270, add enough 1.400 specific gravity electrolyte with the hydrometer to bring the level up to the correct height (about $\frac{1}{2}$ inch above tops of plates). If the specific gravity was above 1.300, add a similar amount of distilled water. If the specific gravity is 15 points (.015) too low or too high, adjust as directed above. If the variation is greater than this, pour out all the electrolyte and add fresh 1.270-1.300 specific gravity electrolyte.

After adjusting the electrolyte, charge until the gravity of all cells is 1.280-1.300, and there is no further change in gravity for at least two hours. Then take the battery off charge and make a final measurement of the specific gravity. Measure the temperature at the same time, and if it varies more than 10° above or below 70° , correct the hydrometer readings by adding one point (.001 sp. gr.) for each 3 degrees above 70° , and subtracting one point (.001 sp. gr.) for each 3 degrees below 70° . Be sure to wipe off any electrolyte which you spilled on the battery in adjusting the electrolyte or measuring the specific gravity. Use a rag dipped in ammonia, or soda solution.

Discharging and Testing.

At this point, many battery men send batteries out, but it is better, if you have time, to discharge the battery and calculate the number of ampere hours the battery will deliver by multiplying the discharge current by the time required for the voltage of each cell to drop to 1.8.

Discharge the battery at a current approximately equal to its ampere hour capacity, using this current for about 10 minutes. For batteries of 80 ampere hours or less, use the discharge board shown in figure 74. For batteries of 100 ampere hours or more, use the coil of Nichrome wire shown at the left, in figure 73.

With the battery discharging, measure the voltage of each cell. If no cell shows a voltage below 1.8 at the end of 10 minutes, the battery is normal. In this case, discharge the battery at $\frac{1}{4}$ to $\frac{1}{5}$ of its ampere hour capacity until the specific gravity in each cell is 1.150. Then charge at the normal rate until the battery tests 2.5 volts per cell, and the specific gravity is 1.280-1.300, and adjust the electrolyte to 1.280.

If the voltage of any cell drops below 1.8 at the end of 10 minutes, discharge the battery at the rate given on the name plate until the specific gravity is 1.150. Then charge the battery again at the normal rate, and see if the cell will come to 2.5 volts while charging. If not, make a cadmium test, as described on page 266, and determine whether the positives or negatives are at fault. If either shows a considerable loss of capacity, the battery will not give a long service.

The charging and discharging of the battery puts the active material in good condition, because the active materials must have exercise, just as a man must, in order to be in the best of health. By charging and discharging, you exercise the pastes and make them as active as possible. Were it not for the time and expense of charging and discharging, it would be better to put the battery through four or five charges and discharges.

CHAPTER 17.

SPECIAL INSTRUCTIONS.

Willard Type S Storage Batteries.

The Willard Type S Storage Battery is a very difficult one to take down and rebuild, and great care must be taken to perform each operation thoroughly, in order to do a good job.

Opening the Battery.

Have the plugs in. With a $7/16$ inch drill, bore three holes in a row in each connector, $1/4$ to $3/8$ inch deep, directly over the post, figure 161. Then hold the drill at an angle and run it along the slot made by the three holes so as to cut away the edges left where the holes meet, figure 162. This will give you a slot a little wider than the post.

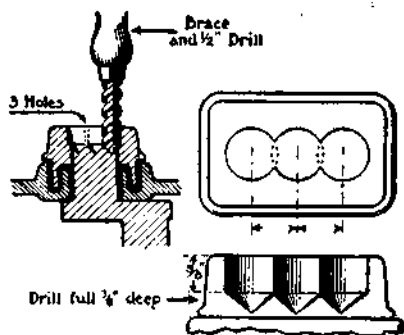

Fig. 161. Drilling Holes in Connector of Willard Type S Battery

Sweep all lead drillings in a box with a whisk broom. Remove all the plugs and blow out the gas. Heat the connectors by running a flame over the drilled slot. You can then pry off the connectors with a

screw driver, using an angle iron to protect the top of the case, figure 163.

Heat the sealing compound with the flame, and with a medium wide screw driver, cut out the compound flush with the tops of the jars.

Heat up the compound again with flame, and clean out the

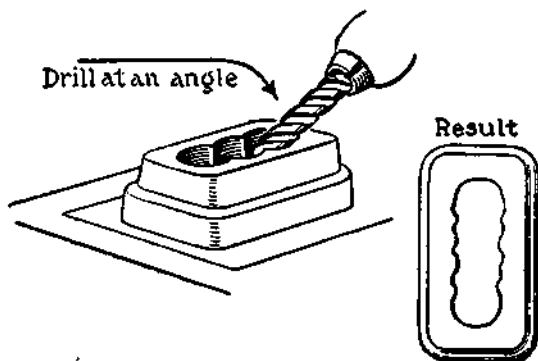

Fig. 162. Widening the Slot

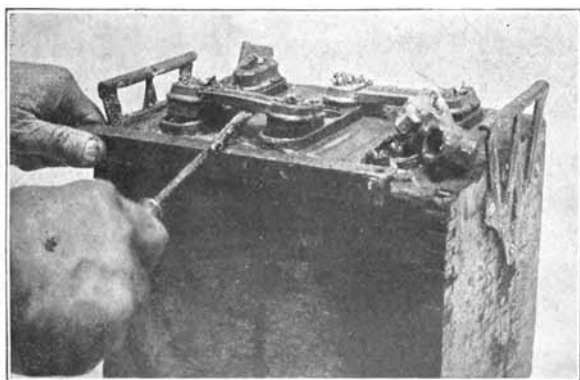

Fig. 163. Removing Top Connectors with Screwdriver. Note Angle Iron Held on Edge of Case to Prevent Damaging Case. Willard Type S Battery

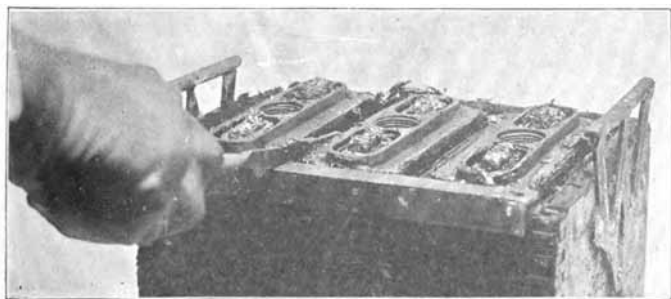

Fig. 164. Removing Pitch with a $\frac{1}{4}$ -inch Chisel from V-shaped Slot Around Covers on Willard Type S Battery



Fig. 165. Lifting Elements Out of Jars, and Resting on Edge of Case to Drain.
Willard Type S Battery.

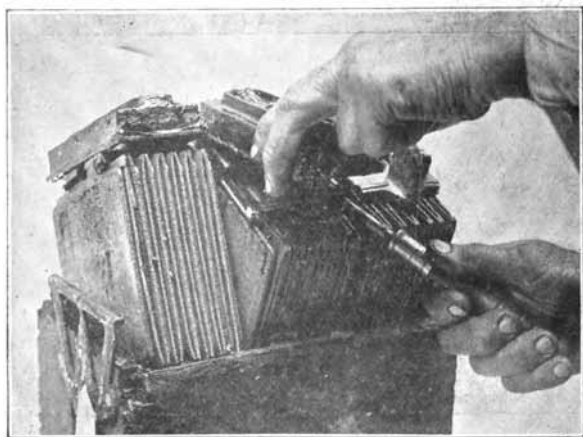

Fig. 166. Removing Covers from Willard Type S Battery

V-shaped cracks with a $\frac{1}{8}$ inch chisel, figure 164. Apply a little more heat, place battery on floor, and pull out the elements and drain, figure 165, using two gas pliers or pincers to grasp the posts in lifting.

Grasp each cover in both hands, work it back and forth, and lift off or remove as in figure 166. Place an element on block as in figure 113. Examine plates, and proceed as directed on pages 198 to 230. After charging, pressing negative plates, and making any repairs necessary, assemble the elements, put in the rubber separators, and place elements in jars. Add new electrolyte, of 1.400 gravity.

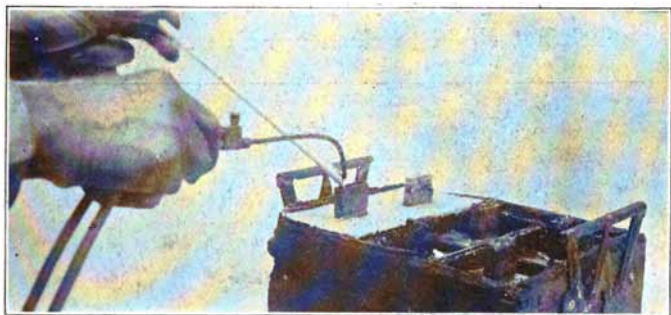

Fig. 167. Extending Post on Willard Type S Battery. Note Asbestos Fitted Around Posts to Prevent Lead from Running Down Into Cell

With the elements all firmly in place, and properly arranged for connecting, the next step is to lengthen the posts by about $\frac{3}{8}$ inch. Take a piece of $\frac{1}{8}$ inch thick asbestos paper, and cut holes in it exactly the size of the post. Push this down around the post, figure 167. Get some $\frac{1}{32}$ inch thick sheet iron, $1\frac{1}{2}$ inches wide, and 3 inches long, and bend a piece exactly the same size as the post to serve as a mold. Slip this over the post, figure 167, and fill all around the inside of the mold, which will make the top of the post of the proper size. The lower part of the post is larger than the top. If the mold does not fit at the lower edge, calk it with asbestos packing.

With a small hissing flame melt the top of the post in the mold, figure 167. Then melt in lead as fast as you can until you have built up the post $\frac{7}{16}$ inch above the old top. Let the post

cool, and then work out the asbestos from the mold with a knife. Pry off the mold, and in a similar way build up the other posts. Should the lead ever show a tendency to stick to the mold, rub a little graphite mixed with oil over it.

The next step is to clean the covers thoroughly. Also clean the compound out of the wells around the posts with a hot $\frac{1}{8}$ inch chisel. A good way to clean the covers is to scrub them with a brush soaked in gasoline, and wipe them dry. Clean out the very bottoms of the wells into which the petticoats of the straps fit, and wipe perfectly dry.

Clean out the inside of the jars near the top, and play the flame on the tops of the jars, and around the edge of the case. Use a $\frac{1}{8}$ inch hot chisel to clean out all compound. Use a hot

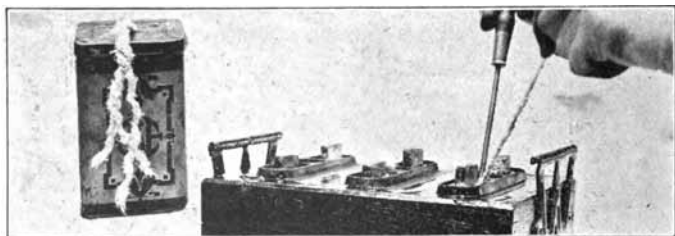

Fig. 168. Putting Asbestos Packing Around Post in Willard Type S Battery, to Prevent Compound from Running Down Into Cell When Burning In

sealing iron to dry out the cracks, being careful not to burn the jars.

Now place on the covers, and make sure that the upper edges are straight and square. See page 230. If there are any cracks around the lower edge next to the jars, calk them with $\frac{1}{8}$ inch strands of asbestos. Force this in tightly all around the edge of the jars.

Now put just enough pitch in a two-quart granite stewpan to seal this one battery, and not more. The pitch is liable to burn if heated more than once, and it will not become as thin when heated the second time as when heated only once. Put the pitch over a rather slow fire so that it will be heated sufficiently just at the time you need it. The pitch must be hot, and very thin to do a good job, yet you must be careful not to burn it, for

when it burns at the bottom, it is not thin enough to run into the small cracks, and is therefore not suitable for the first pouring.

While the pitch is heating, straighten the posts so that they are exactly in the center of the holes in the covers. After warming them slightly, calk around them with $\frac{1}{8}$ inch strands of asbestos, figure 168. A small screw driver is about the best tool to use in calking. When you have calked around all the posts, the pitch will probably be hot enough to pour. Shake the pitch around in the pan, and if it is quite thin, and pours very easily, it is ready for use.

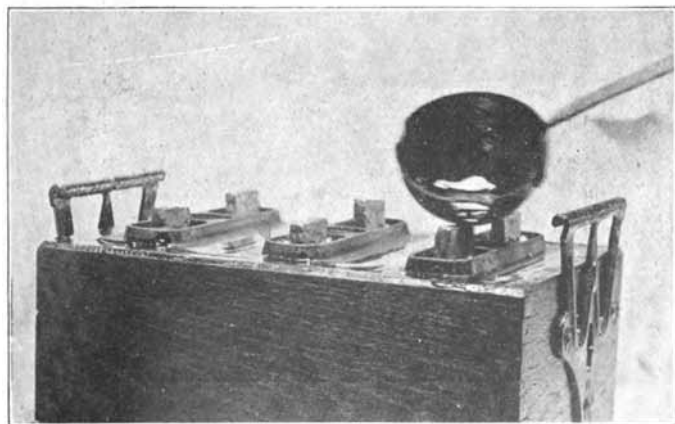

Fig. 169. Pouring Special No. 4 Compound Into Wells Around Posts. Willard Type S Battery

Now pour the pitch in the spaces between the case, jars, and covers until these are full. It is well to tamp the sealing compound in the slots with a hot sealing iron. This is made of a block of copper with a narrow iron blade—to go in the slots—attached to the copper. When using this iron, pour the pitch around only one cover at a time. Then hold the hot iron in a vertical position, insert it between the cover and the jar, and quickly move it up and down, thus forcing the compound clear to the bottom of the slot. Move the iron forward about $\frac{1}{2}$ inch after each downward stroke. In this way tamp in the compound

all around the cover. Do the same for all the cells. If you have an electric fan, turn it on the battery to cool the pitch. If the pitch was thin and hot, the edges of the jars clean, the covers clean, and tight around the insides of the jars, the edge of case properly cleaned and dried, the pitch will stick, and as it cools, it will sink down in the middle of the cracks. When it has cooled, pour in some more pitch until it is slightly higher than the top of the case and covers. When the pitch of the second pouring has cooled, scrape off the excess with a warm putty knife.

Place the connecting straps in a pan of soda solution, and boil

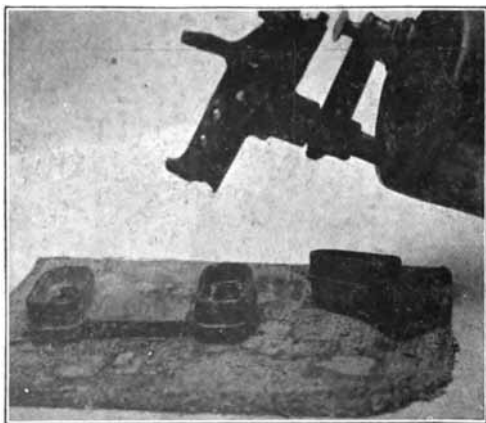

Fig. 170. Heating Top Connectors from Willard Type S Battery before Placing on Post

them. Then dry them, and brush and clean them. File out the oblong holes in the straps with a rat-tailed or coarse flat bastard file. The straps may be held in a vise, if they are carefully handled. Also file the tops of the straps clean around the holes. After the filing, the straps will slip over the posts so that they fit snugly and will easily unite with the extended post. The surfaces of the post and strap must be absolutely clean, or else they cannot be burned together. When you have the straps cleaned up, and tried on, so you are sure that they will fit well, put some Willard special No. 4 compound over the fire. Use about a tablespoon for each post. This compound contains a considerable percentage

of rubber, and will melt very thin and make a good seal if properly used.

When the compound is hot and thin, quickly dry out the wells around the post with the hydrogen flame. Also run the flame over the compound which you have already poured in, so as to put the finishing touches to it. With the connecting straps removed, pour the compound into the wells around the posts until it comes up almost to the top of the edge of the well next to the post, figure 169. Fill all the wells to the same height.

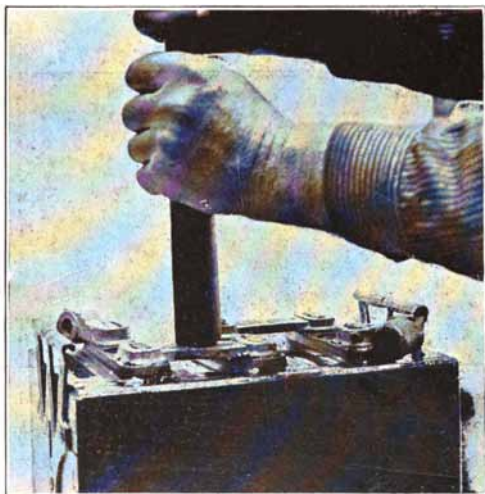

Fig. 171. Pressing Down Hot Top Connector Into No. 4 Compound. Willard Type S Battery

Now put one connecting strap, and one terminal connector on an asbestos pad, and with a blow torch or strong hydrogen flame with little air, heat them, figure 170. Be careful to keep the flame moving constantly, or you will melt them. When hot, put them in position on the posts with pliers, placing the positive terminal near positive mark on case. Pound them in place with a block of wood, figure 171, until they fit tight, and are close to the covers. Put on the other terminal and strap in the same way, and the battery is ready for burning.

In burning these terminals and connectors, several steps must be taken:

1. You must protect the upper edge of cover all around the connecting straps and terminals with asbestos paper or transite board, figure 172.

2. If the built up posts extend more than $\frac{1}{8}$ inch above the top of the straps, cut them down to this height.

3. You must do the burning quickly, or the compound will boil and run out. If the compound becomes so hot that it begins to run out, stop working on that post, and start on another while the first one cools.

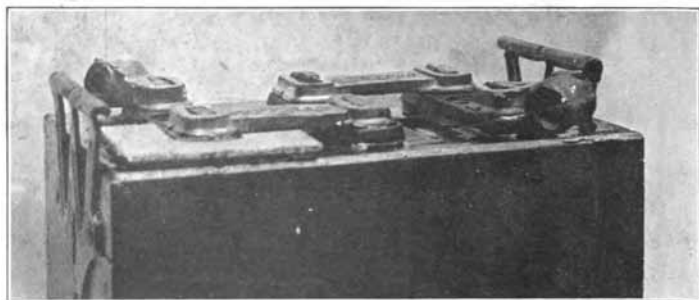

Fig. 172. Transite Board Around Cover to Protect It When Burning In Connectors

4. You must have a rather small, hot hissing flame to start with, and must do the rough burning as quickly as possible.

5. When all the posts are roughly burned, brush off the tops and finish with a rather soft, small flame, with just a faint hiss to it.

6. Mark and paint the battery. See page 246.

If you perform each step carefully, it will take five hours or more to do a first-class job.

Special Instructions for Exide Batteries.

Exide batteries all use a removable nut to make a tight joint between the posts and the cover. With reference to other features, these batteries may be divided into several classes.

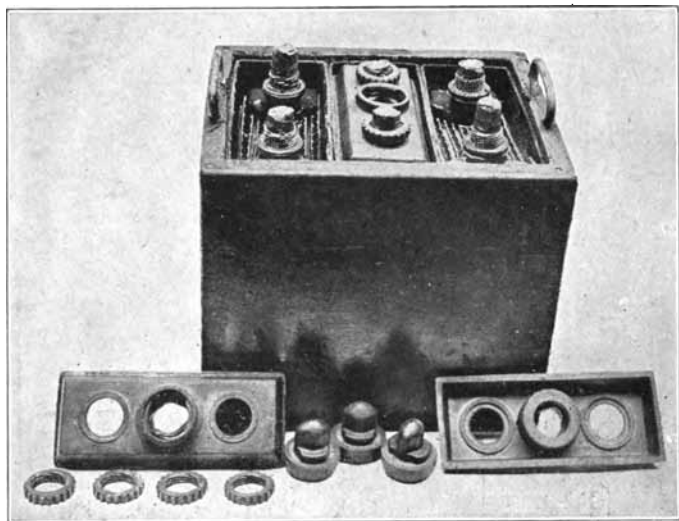

Fig. 173. Exide Battery, Type 3-XC-13-1, Showing Parts and Construction

1. Batteries having burned-in connecting straps, with a single flange cover, figure 173.

2. Batteries having burned-in connecting straps, with double flange cover, figure 175.

3. Batteries having bolted connecting straps, with double flange cover. These never use the single flange cover.

(a) Batteries with burned-in connectors—types XA, XC, LX, SX, ZA, JX, PHA, MIIA. Remove these as described on pages 187 to 191.

(b) Batteries with bolted connectors,—types X, PH, PHB, MH, ZB. The nuts should be removed with a socket wrench of the proper size, figure 174. Then remove the connectors and washers carefully, and put

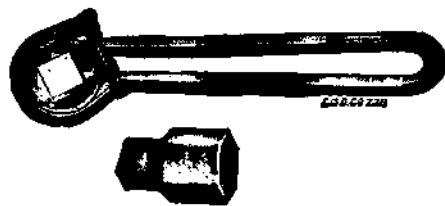

Fig. 174. Socket Wrench

in one of the labeled boxes previously mentioned. There are two top nuts and straps for each complete strap, and three washers over each post, as shown in figure 176.

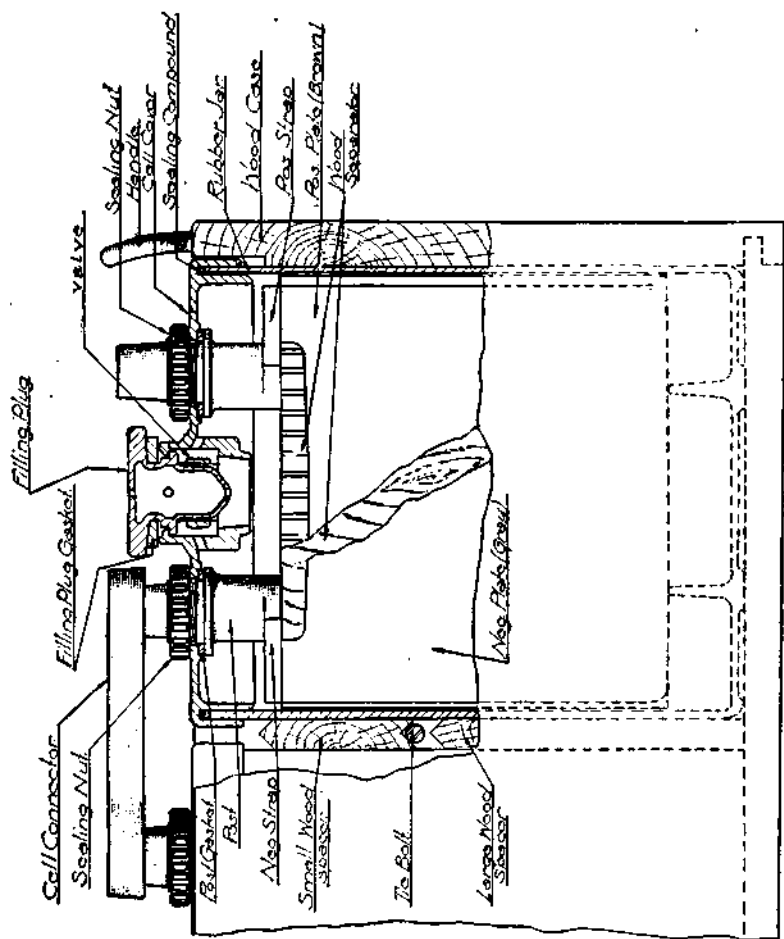

Fig. 175. Section of Exide Battery with Burned-In Connections, and Single Flange Cover

Removing Covers.

Batteries, types X, XA, PH, and MH have tie bolts which run through the case from side to side, between the jars. The jars are spaced properly by horizontal, wooden strips, between which are the tie bolts. Unscrew these bolts several turns to release the jars.

The next step is to remove the sealing nuts. For this purpose you need a special Exide Sealing nut wrench, figure 177. Never use any other tool for this purpose. Heat the tops of the cells a little, and with two crooked nosed pliers, raise the complete cell an inch or two.

Next remove the sealing compound. The single flange cover (used on types XC, LX, SX, and JX) rests on rubber gaskets placed on top of the posts, and is level with the top of the jar, leaving a V-shaped slot all around the inner edge of the jar which is filled with pitch. The pitch may be softened as previously described (page 191), or a hot screw driver may be run through it in order to remove it.

The double flange cover (used on types X, XA, PH, MH, ZB, and ZA) laps over both the inner and outer edge of the jar. There are two flanges, one on the outside, and the other on the inside of the jar, forming a slot which fits over the top of the jar, and also holds the pitch. To remove the pitch, run the flame all around the edge of the cover, but be extremely careful not to burn the cover. After the outer flange is thoroughly warmed, the cover will lift off slowly. Support the cell on two blocks, the lower edge of the outer flange resting on the top of the block, and the bottom of the jar raised slightly above the bench. Press down on the posts, and the cell will drop free of the cover, figure 178.

Inspection of plates, etc. This has already been described fully,

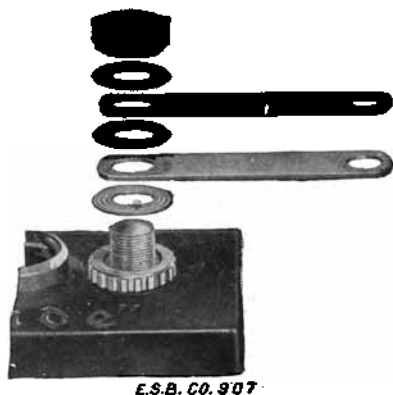

Fig. 176. Parts for Bolted Connections



Fig. 177. Exide Sealing Nut Wrench

pages 198 to 222. The only special instructions needed refer to the perforated rubber separators used in types PH and MII. These are nearly always in such a condition that they can be used again, unless they have been broken in handling, or worn through. Better have some of these on hand in case you break some.

Reassembling.

Put the positive and negative groups together without separators, place the rubber washers on the posts, and put on the cover. Put on the sealing nuts, and tighten them slightly with your fingers. If the nuts turn on hard, spread a little graphite—which has been mixed to a paste with water—on the threads. Never use vaseline or grease for this purpose. Now put in the separators. (See page 224.) Tighten the sealing nuts with the wrench shown in figure 177.

Next lock the sealing nuts. On batteries using burned-in connectors, the thread on the post extends above the top of the nut. Hold the point of a center punch (or nail) on the thread at the top of the nut and strike a sharp blow with a hammer, figure 179. This will damage the thread and prevent the nut from turning loose. Do this at several points around the post.

On the batteries having bolted connections, the washers, straps and top nut will hold the sealing nut firmly in place.

Sealing.

Remove all old compound from covers and jars and wipe with a cloth dipped in ammonia or soda solution. In sealing batteries that use the single flange cover, melt the compound and pour it into

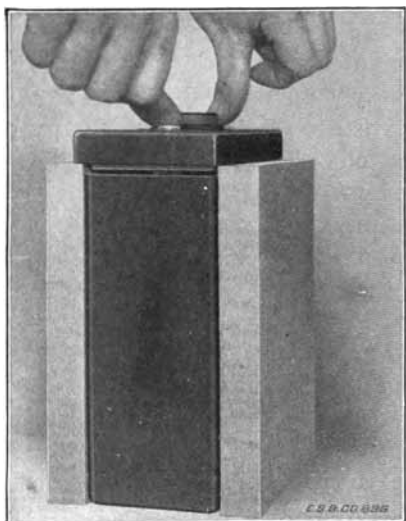

Fig. 178. Removing Double Flange Cover

the V-shaped groove, finishing as usual. In sealing batteries using the double flange cover, clean the groove thoroughly and pour one-half full of hot pitch. Place cover on top of jar and press down evenly all around. Another way is to roll out between two boards some of the special Exide compound, made for this type of cover, until it is about 3-16 inch in diameter. Lay this compound in the groove while the element is upside down, figure 180. Then put element in jar, and press down evenly so that the top of the jar presses up against the compound at all points. Run a flame around the outside of the flange until the compound melts evenly. Press down the cover carefully. Remove any compound which is forced down out of the groove with a hot putty knife or screw driver.

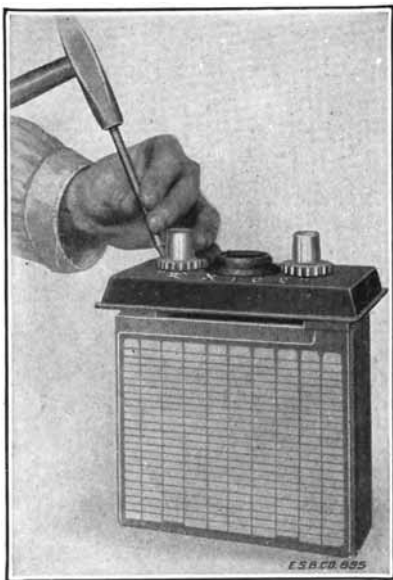

Fig. 179. Locking Sealing Nut

Putting Cells in Case.

When all the cells have been sealed, put the elements in the cases, taking care to have the positive and negative posts placed correctly for putting on the connectors. In types X, XA, PH, and MH, be sure to put in the wooden spacers between cells, and tighten the tie bolts to hold the jars firmly in place. If the battery has no tie bolts, wedge the jars in place with strips of wood if they do not fit snugly.

Putting on Connecting Straps.

Directions for the burned-in connectors have already been given (pages 239 to 246). In placing the bolted connectors, spread vaseline over the studs. Put the connectors and washers on in

the following order,—one connector link, one washer, second connector link, second washer, top nut. Tighten the top nut with socket wrench, figure 175.

The remaining steps consist of charging, and balancing the electrolyte, consult pages 247 and 248.

In addition to the three types of Exide batteries described above, there are several other types which use no sealing compound at all, and therefore require no special instructions. An old type has two covers, the lower of which is somewhat similar to the single flange cover described above. The upper cover fits over the outside of the jar.

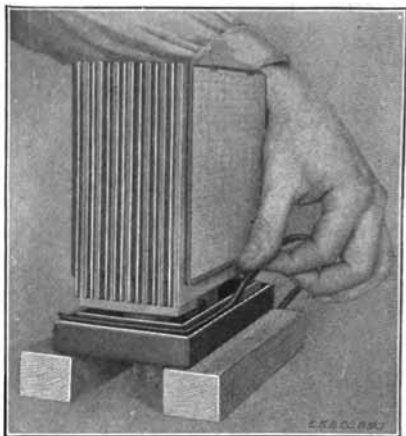

Fig. 180. Sealing Double Flange Cover

Special Instructions for Prestolite and U.S.L.

The Prestolite and U.S.L. Companies make a new type of battery which resemble each other in a number of respects. The tops are like U.S.L. described on page 98. Take great care in bringing a flame near these batteries, as gas may be pocketed under the covers and cause an explosion. There is only a small vent hole through which gas can escape, as the wells extend down into the electrolyte when the cells are properly filled.

When you work on these batteries, draw out enough electrolyte so that it is below the bottom of the well. Then thoroughly blow out any gas which may have become pocketed under the cover.

Another unique feature of construction is the post and lead sealing shell fitting over it. After this shell has been screwed into the cover from below against a soft rubber gasket, the tops of the shell and post are burned together. This makes a perfectly tight seal, provided the shells have been screwed up tightly. The

sealing arrangement around the edge of the jar is similar to that in the single flange Exide cover, figure 173.

Be very careful in sealing this type of battery. Ordinary compounds will not hold. Use pitch, or a high grade and very sticky



Fig. 181. Prest-O-Lite Battery, Showing Parts and Construction

compound. Never use compound or pitch a second time for this battery.

Figure 181 shows a Prest-O-Lite Battery. Directions already given apply to this type also.

CHAPTER 18.

CADMIUM TEST. STORING BATTERIES.

Cadmium Test for Storage Batteries.

Tests of the specific gravity of batteries and tests of voltage of the cells give indications that are quite reliable, but unfortunately either the voltage or gravity or both voltage and gravity

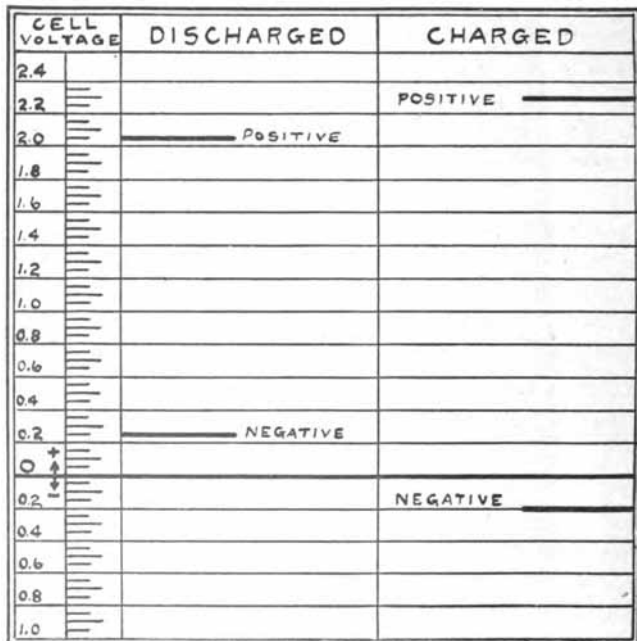

Fig. 182

may be satisfactory and yet the battery capacity may be very low. This is true because either the positive or negative plates may not be charging or discharging properly and if either set does not completely charge and discharge, then the capacity of the

cell can only be equal to the capacity of the faulty set of plates. Should such a condition exist, the voltage will fall rapidly during discharge and the capacity of the battery will be greatly reduced.

The change in voltage of the positive and negative plates, between the discharged and the charged condition is graphically shown in figure 182. The horizontal lines represent the change in voltage starting from the heavy line marked "O" and increasing above the line for positive polarity and below the line for negative polarity.

The position of the negative plates of a discharged cell as to voltage is represented by the heavy line marked "Negative" in the column headed "Discharged." The position of the positive plate at this time is indicated by a heavy line marked "Positive" and in this same column. The voltage of the negative plate with relation to the "O" line is 0.25 and the voltage of the positive plate with reference to this same "O" line is 2.05. It will be seen that the total difference in voltage between the positive and negative plates is therefore 1.8, or 2.05 minus 0.25, and it will be recognized that this voltage (1.8) is the voltage of a discharged storage cell.

The relative voltages of the positive and negative plates in a fully charged cell are indicated by the heavy lines in the column marked "Charged" and it will be seen that the voltage of the positive plate has become 2.3 above "O" while that of the negative has become 0.2 below the "O" line. The total difference in voltage between the positive and negative plates is now 2.5, or 2.3 plus 0.2. It will be recognized that this voltage (2.5) is the voltage of a storage cell when fully charged.

The voltage of the positive plates has changed 0.25 of a volt, that is from 2.05 to 2.3. The voltage of the negative plates has changed 0.45 of one volt, that is from 0.25 above the "O" line to 0.2 below the "O" line. Therefore, in order that a discharged cell may become fully charged, it is necessary that the voltage of the positive plates change 0.25 of a volt and the voltage of the negatives must change 0.45 of a volt.

If for any reason the positive plates should get into such a condition that their voltage does not change over this range, the battery cannot have full capacity or full voltage on discharge.

The same is true of the negative plates, their voltage should change over the entire normal range.

It will be seen by examining the diagram in Figure 182 that it would be quite possible for the cell voltage to be normal and yet have an incorrect relation between either the positive or negative plates and the "O" point. For instance with a fully charged battery, should the voltage of the positive plate be found considerably below the normal point, it would indicate that the lead sulphate had not been completely reduced and replaced by peroxide

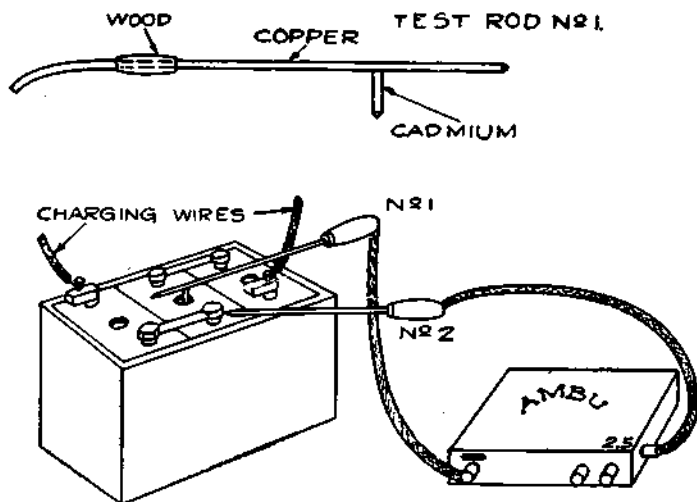

Fig. 183. Making a Cadmium Test

of lead. Should it be found that with a charged battery the voltage of the negative plates remains above or on the positive side of the "O" line or if it does not drop to the proper point on the negative side below the "O" line, it would indicate that the lead sulphate on the negative plates had not been completely reduced and replaced by sponge lead. In either case the remedy would be to give the battery a long continued charge at a low rate, that is, at the twenty-four hour rate.

The voltage of the separate sets of plates is measured by attaching one side of a voltmeter to the terminal of the set of plates that is to be tested and attaching the other side of the voltmeter

to a rod of the metal cadmium, which is then inserted into the electrolyte of the cell. The voltmeter will then indicate the voltage between the cadmium and the plates being tested. The cadmium remains inert and is represented by the "O" line on the diagram. With the voltmeter connected between the cadmium, which represents "O," and either set of plates, the plate voltage may be found.

The cadmium rod should be from 3-16 to $\frac{3}{8}$ of an inch in diameter, and from 3 to 4 inches long. Solder it to the side of a rod of copper or bronze, as shown at No. 1 in Figure 183. You will need a second test rod, as shown at No. 2 in Figure 183.

The voltmeter for this test should have a scale reading up to 2.5 volts, and should preferably have the "O" in the center. If the "O" is at the left end of the scale, the wires attached to the test rod should be connected to the meter terminals so that the needle swings toward the right. If the pointer should swing to the left in this meter, reverse the wires at the meter terminals so that it will swing to the right.

If you use Ambu in making the cadmium test, connect the wires which are fastened to the test rods to the "—" and "2.5" posts. Set lever "C" so that the "O" line on the "VOLT AND AMPERE SCALE" is under the pointer, and turn the button switch so that the arrow points to "V." Do not move the "C" lever again during the test.

The cadmium should be covered with a rubber tube which has holes cut in it. No part of the rod should touch the plates. In testing the positive plates, test rod No. 2 is held on the positive post of the cell, and the cadmium rod is inserted in the vent hole. In testing the negative plates, test rod No. 2 is held on the negative post of the cell, and the cadmium rod is inserted in the vent hole. The acid must cover the lower part of the cadmium.

When about to proceed with the work the cadmium which has been covered with rubber should be inserted in the electrolyte and allowed to remain so that its surface may reach a condition that will not change with further action of the acid. The surface of the cadmium should never be scraped or polished as this will prevent uniform readings from being secured under various conditions and with varying intervals of time.

The methods of inserting the cadmium pencil into the cell and of connecting the cadmium and cell terminal with the voltmeter are shown in Figure 183.

Charged battery. Test the negative and positive plates as directed above. Test the positive plates first. Then test the negative plates. If you are using a voltmeter with the "O" at the left end of the scale, the pointer should swing "backwards" when you test the negatives, and the wires connected to the meter should be reversed, and the test repeated. If you are using Ambu, the pointer should swing to the opposite side of the "O" line when testing the negatives that it did in testing the positives. The charging current should be passing into the battery when the tests are made on each cell. The voltage reading between the cadmium and positives should be between 2.35 and 2.45.

The voltage reading between the cadmium and the negatives should be between 0.1 and 0.2. If the pointer is near the "O" line in testing the negatives, or swings to the same side of the "O" line as it does in testing the positives, the negatives are defective. The farther the pointer goes to the other side of the "O" line, the better the condition of the negatives.

If the voltage reading obtained in testing the positives is less than 2.35 volts, and the negative plates give a normal reading of 0.1 to 0.2 volts, the positive plates are defective. The causes may be sulphated plates, leak of current between plates, natural ageing of the battery, or lack of charge. In this case, discharge the battery to 1.8 volts per cell, (see page 248), and then charge it again. Repeat this several times.

Discharged battery. Test the positive plates as directed above. Then test the negatives, the pointer should swing to the same side of the "O" line in each case, without reversing the wires attached to the meter. With a battery having a voltage of 1.8 per cell, the reading obtained when you test the positive plates should be about 2.05 volts. The reading obtained when testing the negatives should be about 0.25. The readings should be taken while the battery is discharging at the normal rate.

In some cases, readings obtained in both tests for positive and negative plates are nearly zero. This indicates a short circuit, and the battery should be opened. See page 187.

Storing Batteries Dry.

Taking a battery out of commission for dry storage of six weeks or longer (six years, if necessary) consists in putting each cell in condition to charge normally; then charge it until the gravity will not rise any more, the electrolyte is clear, and the plates all of the proper color; at this stage the charging has excluded all impurities possible from the plates and the pores contracted to their limit. Pour out the electrolyte, separate the groups, remove the separators, and press the negative plates as follows:

Put a smooth straight board or transite board, the thickness of the positive plate plus two separators, (which in the ordinary automobile battery is just a trifle over one-fourth of an inch) in each space between the negative plates of that group, then place a piece of 2"x6"x7" long board on each side of group, put group in vise or plate press, draw up slowly till tight. Leave for a few moments; then remove from vise or press and remove boards, and rinse group in clear water. Treat each negative group in similar manner and then put in jars and cover with distilled water for ten or twelve hours. Then remove and dry; but if they begin to heat, dip in water and dry; repeat the dipping if they heat the second time. Continue dipping the group after drying as long as the plates heat up. When the plates are thoroughly dry, immerse them in clean, new electrolyte (of about 1.275 specific gravity) and allow to soak for three or four hours. The jars may be used for this purpose. After rinsing and drying they are ready to put away.

The positive plates should not be washed but may be dipped in the above acid several times to clean them. They should be straightened as much as possible immediately upon removing from jars. Sometimes this may be done (if not too hard) by placing boards between them as with the negatives and pressing in vise or plate press. Do not apply much pressure. Press the group about 10 or 15 minutes, and then use flat nosed pliers to completely straighten the edges if they are still warped. Plates can generally be straightened fairly well, but care must be used not to crack them. If plates are cracked, or buckled badly, replace with new ones without hesitation. The positive plates must not be left

exposed to the light. Throw away the old separators. Clean the covers and terminals, as directed elsewhere, wash out the jars and put a positive group in each jar. Nest two negative groups and with covers and terminals put in labeled box as described elsewhere.

Store the case and box in a dark place until called for. You should tell the owner when arrangements are made for storing that he must give you ten days' notice to put battery back into commission. When a battery is dry stored as above, to put it into commission, use about 1.360 gravity acid, fully charge and discharge, making two complete cycles, and balance to 1.280. With this treatment the pastes become active and put the battery into first-class condition.

Finished Work.

Perform every detail, from boring off connecting straps, to the final charge with the utmost care. Make it an iron-clad rule that every battery which you rebuild must be rebuilt as nearly perfect as you can; that every battery you turn out of your shop will deliver from 80% to 90% of its rated capacity; that every such battery will stand up under the service required of it.

See that every job you turn out is done as well as you can do it. Make each job a little better than the previous one. Treat each customer courteously, and never promise anything unless you know absolutely that you can keep that promise. Put yourself in your customer's position, and be as careful of his money as if it were yours, and you were paying a repairman to put your battery in shape.

Do not grow careless and do sloppy work. Be conscientious, and do everything right. If you do not know the right way, make up your mind to learn the right way. You must know what you are doing, and must not grope around on a job. If you make a guess as to what should be done, and adopt the cut-and-dry method, you will "fall down on the job" nine times out of ten.

The battery owner may pay the bill once, for a poor job, but he will never come back. The public is just as intelligent as you



Fig. 184. Upper Side of a Very Poorly Burned-In Connector



Fig. 185. Under Side of Link Shown in Previous Figure. Note that Holes were Bored with a Wood-Bit



Fig. 186. Trouble Breeders. Failures in Making Connections and Burning In

are, and knows when it is being "soaked." Car owners soon learn to go to the man who knows what he is doing, and who does it in the right way.

Inferior work, such as the burning shown in figures 184, 185, and 186, will soon put you out of business. Your reputation is at stake every time you rebuild a battery. It is in your power to build up a reputation for good work that will make you the busiest battery man in your vicinity.

You should go a step beyond repairing the battery. You should know, when a car leaves your shop, that there are no grounds or short circuits in the wiring which will cause the battery to run down, and that the generator is charging at the proper rate. The best way to do this is to have an AMBU ELECTRICAL TROUBLE SHOOTER, which gives the proper charging rates for all types and makes of dynamos which have been used as standard equipment since 1911, and which furthermore quickly locates and tells how to cure any troubles which may exist in the starting or lighting system. If you find any repair troubles outside of the battery, you will earn more money, and you will have car owners coming to your shop from near and far.

[The page contains extremely faint and illegible text, likely bleed-through from the reverse side of the document. The text is too light to transcribe accurately.]

INDEX

A

| | Page |
|---|------------|
| Adding water to replace evaporation..... | 73 to 78 |
| Adjusting the electrolyte after rebuilding..... | 248 |
| Analysis of the condition of the battery..... | 162 to 172 |
| Assembling and finishing elements during manufacture..... | 100 |

B

| | |
|---|------------|
| Batteries in general..... | 5 |
| Battery case rotted. Causes and remedies..... | 177 |
| Battery discharges rapidly. Causes and remedies..... | 178 |
| Battery trouble charts..... | 172 to 178 |
| Battery will not take charge..... | 176 |
| Boring off connecting straps..... | 189 |
| Buckling of plates..... | 58 |
| Burning lead mold..... | 146 |
| Burning on connecting straps with Oxy-Hydrogen flame..... | 239 |
| Burning on connecting straps with soldering irons..... | 244 |
| Burning on new plates..... | 218 |

C

| | |
|---|-----|
| Cadmium test for storage batteries..... | 266 |
| Capacity of storage batteries..... | 40 |
| Capacity, causes for loss of..... | 54 |
| Capacity, effect of age on..... | 46 |
| Capacity, effect of circulation of electrolyte on..... | 43 |
| Capacity, effect of plate surface area on..... | 41 |
| Capacity, effect of quantity, arrangement and porosity of active material on..... | 41 |
| Capacity, effect of quantity and strength of electrolyte on..... | 41 |
| Capacity, effect of rate of discharge on..... | 43 |
| Capacity, effect of temperature on..... | 45 |
| Care of battery when not in service..... | 88 |
| Case, care of battery..... | 72 |
| Case, cleaning and painting the..... | 246 |
| Case, manufacture of..... | 99 |
| Case, repairing the..... | 225 |

| | Page |
|---|------------|
| Case, rotted..... | 177 |
| Cell, elementary..... | 5 |
| Cell, things required in storage..... | 7 |
| Cells, primary and secondary..... | 6 |
| Charge, battery will not hold..... | 178 |
| Charge, battery will not take..... | 176 |
| Charge, changes at negative plates during..... | 38 |
| Charge, changes at positive plates during..... | 39 |
| Charge, change in density of electrolyte during..... | 38 |
| Charge, chemical actions of..... | 15 |
| Charge, final products of..... | 12, 14 |
| Charge for sulphated battery..... | 184 |
| Charge, freshening..... | 72 |
| Charge, gassing during..... | 184 |
| Charge, ions during..... | 18, 22 |
| Charge, loss of in an idle battery..... | 26 |
| Charge, normal..... | 184 |
| Charge phenomena..... | 37 |
| Charge, specific gravity does not rise during..... | 186 |
| Charge, specific gravity rises above 1.300 during..... | 186 |
| Charge, starting rate of..... | 184 |
| Charge, voltage changes during..... | 37 |
| Charging battery before rebuilding..... | 182 |
| Charging battery off the car..... | 183 |
| Charging battery on the car..... | 182 |
| Charging bench..... | 114 |
| Charging equipment..... | 113 |
| Charging methods..... | 110 |
| Charging the rebuilt battery..... | 247 |
| Chemical actions, substances which enter into the..... | 12 |
| Chemical actions which produce electricity..... | 11 |
| Cleaning and painting the case..... | 246 |
| Condition of battery. Analysis of..... | 162 to 172 |
| Conditions of operation, engine idle..... | 62 |
| Conditions of operation, engine running..... | 63 |
| Connecting straps, burning on, with Oxy-hydrogen flame..... | 239 |
| Connecting straps, burning on with soldering irons..... | 244 |
| Connecting straps, removing..... | 189 |
| Connection of battery to car..... | 71 |
| Cold weather efficiency of storage batteries..... | 66 |
| Corroded terminals. Causes and remedies..... | 177 |
| Course of operation of starting and lighting systems..... | 61 |
| Covers, putting on the..... | 230 |
| Covers, various designs for..... | 96 |

| | Page |
|---|------|
| Cutout adjustment..... | 169 |
| Cutout, operation of electromagnetic..... | 65 |
| Cutout, operation of manual..... | 63 |
| Cutout, operation of mechanical..... | 64 |

D

| | |
|--|------------|
| Discharge board..... | 133 |
| Discharge, changes at negative plates during..... | 34 |
| Discharge, changes at positive plates during..... | 35 |
| Discharge, expansion of negative active material during..... | 35 |
| Discharge, chemical actions of..... | 15 |
| Discharge, factors limiting extent of..... | 31, 34, 42 |
| Discharge, final products of..... | 12, 14 |
| Discharge, ions during..... | 22, 24 |
| Discharge phenomena..... | 29 |
| Discharge, voltage changes during..... | 30 |
| Discharging and testing batteries after rebuilding..... | 248 |
| Discharging battery after charge..... | 186 |
| Diseases of storage batteries..... | 51 |
| Dry storage of batteries..... | 271 |

E

| | |
|---|-----|
| Early history of storage battery..... | 11 |
| Efficiency of battery in cold and warm weather..... | 66 |
| Electric arc, lead burning with..... | 152 |
| Electricity not generated by battery..... | 22 |
| Electricity, sources of, on car..... | 3 |
| Electrolyte, adjusting after rebuilding..... | 248 |
| Electrolyte, causes of leakage of, at top of battery..... | 176 |
| Electrolyte, causes of low level of..... | 175 |
| Electrolyte, changes in density of, during charge..... | 38 |
| Electrolyte, changes in density of, during discharge..... | 32 |
| Electrolyte, densities of, for best operation..... | 36 |
| Electrolyte, filling jars with..... | 228 |
| Electrolyte, freezing points of..... | 87 |
| Electrolyte, height of..... | 73 |
| Electrolyte, mixing..... | 158 |
| Electrolyte, proportions of water and acid in mixing..... | 160 |
| Electrolyte not decomposed in an idle battery..... | 27 |
| Electrolytic rectifier..... | 128 |
| Elementary cells..... | 5 |
| Elements, reassembling the..... | 222 |

| | Page |
|---|------|
| Examining plates in rebuilding batteries..... | 200 |
| Excessive temperature on charge..... | 186 |
| Exide batteries..... | 258 |
| Exide covers..... | 98 |

F

| | |
|---|-----|
| Filling jars with electrolyte..... | 228 |
| Find the cause of every trouble..... | 211 |
| Finished work..... | 272 |
| Finishing charge rate..... | 184 |
| Forming plates..... | 92 |
| Four compartment heater..... | 192 |
| Freeing shorts..... | 211 |
| Freshening charge..... | 72 |
| Freezing, causes and remedies..... | 178 |
| Freezing points of electrolyte of various specific gravities..... | 87 |

G

| | |
|----------------------------|-----|
| Gassing during charge..... | 184 |
|----------------------------|-----|

H

| | |
|---|-----|
| Hardening of negatives..... | 59 |
| Height of electrolyte..... | 73 |
| High gravity, causes and results of..... | 174 |
| History of storage battery..... | 11 |
| How chemical actions produce electricity..... | 17 |
| How to take care of battery on the car..... | 68 |

I

| | |
|--|----------|
| Idle battery, causes of loss of charge in..... | 26 to 28 |
| Idle battery, electrolyte not decomposed in..... | 27 |
| Idle battery, formation of sulphate in..... | 26 |
| Idle battery, loss of charge in, caused by impurities..... | 28 |
| Idle battery, loss of charge in, caused by leakage..... | 28 |
| Installation of battery on car..... | 69 |
| Internal resistance, effect of active materials on..... | 49 |
| Internal resistance, effect of electrolyte on..... | 49 |
| Internal resistance, effect of grids on..... | 48 |
| Ions during charge..... | 18 to 22 |
| Ions during discharge..... | 22 to 24 |

J

| | Page |
|--|------|
| Jars, putting in new..... | 226 |
| Jars, how to determine if cracked..... | 167 |

L

| | |
|--|-----|
| Lamps, do not use larger than those supplied with car..... | 63 |
| Layout for a small shop..... | 104 |
| Lead burning with electric arc..... | 152 |
| Lead burning with gas flame..... | 152 |
| Lead burning with oxygen-hydrogen flame..... | 239 |
| Lead burning with soldering irons..... | 244 |
| Leakage of electrolyte at top of battery..... | 176 |
| Light in the shop..... | 109 |
| Lights, causes of dim..... | 178 |
| Loss of charge in an idle battery..... | 26 |
| Low gravity, causes of..... | 172 |
| Low level of electrolyte, causes and results of..... | 175 |
| Low voltage, causes of..... | 172 |

M

| | |
|---|-----|
| Manufacture of storage batteries..... | 89 |
| Mercury arc rectifier..... | 123 |
| Methods of heating sealing compounds..... | 191 |
| Methods of producing electricity..... | 5 |
| Mold for preparing burning lead..... | 146 |
| Molding grids for plates..... | 89 |
| Motor generator sets..... | 123 |

N

| | |
|---|-----|
| Negative plates, changes at during charge..... | 38 |
| Negative plates, changes at during discharge..... | 34 |
| Negative plates, expansion of during discharge..... | 35 |
| Negative plates, hardening of..... | 59 |
| Negative plates, pressing..... | 215 |
| Normal charge..... | 184 |

O

| | |
|---|-----|
| Open circuit voltage not a reliable test..... | 32 |
| Opening a battery..... | 187 |
| Opening, when necessary..... | 181 |

| | Page |
|--|------|
| Opening, when unnecessary..... | 180 |
| Operating conditions governing action of battery..... | 65 |
| Operating temperatures..... | 85 |
| Operation, conditions of..... | 61 |
| Operation, conditions of with engine idle..... | 62 |
| Operation, conditions of with engine running..... | 63 |
| Operation, course of, in a starting and lighting system..... | 61 |
| Overcharge, monthly..... | 186 |
| Overheating, causes and results of..... | 175 |

P

| | |
|---|-----|
| Pastes, applying to grids..... | 91 |
| Pastes, formulas for..... | 91 |
| Plate press..... | 142 |
| Plates, buckling of..... | 58 |
| Plates, burning on new..... | 239 |
| Plates, examination of, in rebuilding..... | 200 |
| Plates, forming of..... | 92 |
| Plates, manufacture of..... | 89 |
| Plates, Planté and Faure..... | 11 |
| Plates, washing and pressing..... | 215 |
| Plates, what to do if some must be discarded..... | 199 |
| Plates, when old may be used again..... | 208 |
| Plates, when to put in new..... | 201 |
| Plugs filling, must be removed during charge..... | 184 |
| Positive plates, buckling of, when exposed to light..... | 60 |
| Positive plates, changes at during charge..... | 39 |
| Positive plates, changes at during discharge..... | 35 |
| Positive plates, greater activity at, than at negative..... | 35 |
| Precautions to be taken by repairman..... | 150 |
| Preliminary charge in rebuilding batteries..... | 213 |
| Preparing battery for use..... | 69 |
| Prestolite batteries..... | 264 |
| Primary and secondary cells..... | 6 |
| Producing electricity, methods of..... | 5 |
| Proportions of water and acid in mixing electrolyte..... | 160 |
| Putting elements in jars..... | 227 |
| Putting in new jars..... | 226 |
| Putting on the covers..... | 230 |

R

| | |
|--------------------------------|-----|
| Reassembling the elements..... | 222 |
| Rebuilding batteries..... | 187 |

| | Page |
|--------------------------------|------|
| Rectifier, electrolytic..... | 128 |
| Rectifier, mercury arc..... | 123 |
| Removing sealing compound..... | 191 |
| Repairing the case..... | 225 |

S

| | |
|---|------------|
| Saving the sediment..... | 157 |
| Sealing compound, methods of heating..... | 191 |
| Sealing compound, removing..... | 191 |
| Sealing compounds..... | 231 |
| Sealing the battery..... | 233 |
| Separators, manufacture of..... | 95 |
| Separators, storing..... | 210 |
| Separators, work on, in rebuilding batteries..... | 209 |
| Shelving..... | 109 |
| Shop equipment..... | 103 |
| Shop, layout for small..... | 104 |
| Shop, light in the..... | 109 |
| Shorts, freeing..... | 211 |
| Soldering irons, lead burning with..... | 244 |
| Sources of electricity on the car..... | 3 |
| Specific gravity as affected by temperature..... | 85 |
| Specific gravity, causes of low..... | 172 |
| Specific gravity does not rise on charge..... | 176 to 186 |
| Specific gravity, measuring..... | 79 |
| Specific gravity rises above 1.300 on charge..... | 186 |
| Specific gravity, why 1.300 is used..... | 42 |
| Standard method of procedure in handling plates..... | 199 |
| Starting charge rate..... | 184 |
| Starting motor should be used as little as possible..... | 65 |
| Steamer, battery..... | 140 |
| Steps in the application of electricity to the gasoline automobile..... | 1 |
| Storage battery does not generate electricity..... | 22 |
| Storage battery, what it consists of..... | 89 |
| Storing batteries while dry..... | 271 |
| Sulphate, formation of, in an idle battery..... | 26 |
| Sulphated battery, charging..... | 184 |
| Sulphation..... | 51 |

T

| | |
|--------------------------------|-----|
| Tagging batteries..... | 147 |
| Temperature during charge..... | 185 |

| | Page |
|------------------------------|------------|
| Temperature, operating..... | 85 |
| Tools and equipment..... | 135 |
| Trouble charts..... | 172 to 178 |
| Turntable for batteries..... | 144 |

U

| | |
|-------------------------|-----|
| U. S. L. batteries..... | 264 |
| U. S. L. covers..... | 98 |

V

| | |
|--|-----|
| Voltage, causes of low..... | 172 |
| Voltage changes during charge..... | 37 |
| Voltage changes during discharge..... | 30 |
| Voltage independent of plate surface area..... | 32 |
| Voltage on open circuit not reliable test..... | 32 |

W

| | |
|--|-----|
| Warm weather efficiency of storage batteries..... | 66 |
| Washing and pressing plates..... | 215 |
| What must be done with opened battery..... | 198 |
| What to do if some plates are to be discarded..... | 199 |
| When a battery may be left on the car..... | 179 |
| When a battery must be opened..... | 181 |
| When a battery should be removed from car..... | 179 |
| When it is unnecessary to open a battery..... | 180 |
| When the old plates may be used again..... | 208 |
| When to put in new plates..... | 201 |
| Why specific gravity of 1.300 is used..... | 42 |
| Willard type S battery..... | 250 |
| Work bench, special..... | 105 |
| Work on the battery..... | 182 |
| Workshop..... | 102 |

THIS BOOK IS DUE ON THE LAST DATE
STAMPED BELOW

AN INITIAL FINE OF 25 CENTS
WILL BE ASSESSED FOR FAILURE TO RETURN
THIS BOOK ON THE DATE DUE. THE PENALTY
WILL INCREASE TO 50 CENTS ON THE FOURTH
DAY AND TO \$1.00 ON THE SEVENTH DAY
OVERDUE.

JUL 30 1946

31 Oct 51 PF

30 Oct 51 LU

8 Nov 55 CT

OCT 25 1955 LU

APR 25 1966 6 8

APR 22 '66 9 2 RCD

RECEIVED 5

OCT 21 '69 - 6 PM

LOAN DEPT.
LOAN DEPT.

LD 21-100m-7,40 (6986a)

