



This is a digital copy of a book that was preserved for generations on library shelves before it was carefully scanned by Google as part of a project to make the world's books discoverable online.

It has survived long enough for the copyright to expire and the book to enter the public domain. A public domain book is one that was never subject to copyright or whose legal copyright term has expired. Whether a book is in the public domain may vary country to country. Public domain books are our gateways to the past, representing a wealth of history, culture and knowledge that's often difficult to discover.

Marks, notations and other marginalia present in the original volume will appear in this file - a reminder of this book's long journey from the publisher to a library and finally to you.

### **Usage guidelines**

Google is proud to partner with libraries to digitize public domain materials and make them widely accessible. Public domain books belong to the public and we are merely their custodians. Nevertheless, this work is expensive, so in order to keep providing this resource, we have taken steps to prevent abuse by commercial parties, including placing technical restrictions on automated querying.

We also ask that you:

- + *Make non-commercial use of the files* We designed Google Book Search for use by individuals, and we request that you use these files for personal, non-commercial purposes.
- + *Refrain from automated querying* Do not send automated queries of any sort to Google's system: If you are conducting research on machine translation, optical character recognition or other areas where access to a large amount of text is helpful, please contact us. We encourage the use of public domain materials for these purposes and may be able to help.
- + *Maintain attribution* The Google "watermark" you see on each file is essential for informing people about this project and helping them find additional materials through Google Book Search. Please do not remove it.
- + *Keep it legal* Whatever your use, remember that you are responsible for ensuring that what you are doing is legal. Do not assume that just because we believe a book is in the public domain for users in the United States, that the work is also in the public domain for users in other countries. Whether a book is still in copyright varies from country to country, and we can't offer guidance on whether any specific use of any specific book is allowed. Please do not assume that a book's appearance in Google Book Search means it can be used in any manner anywhere in the world. Copyright infringement liability can be quite severe.

### **About Google Book Search**

Google's mission is to organize the world's information and to make it universally accessible and useful. Google Book Search helps readers discover the world's books while helping authors and publishers reach new audiences. You can search through the full text of this book on the web at <http://books.google.com/>

HANDBOOK *of* SHIP  
CALCULATIONS  
CONSTRUCTION  
*and* OPERATION  

---

CHARLES H. HUGHES







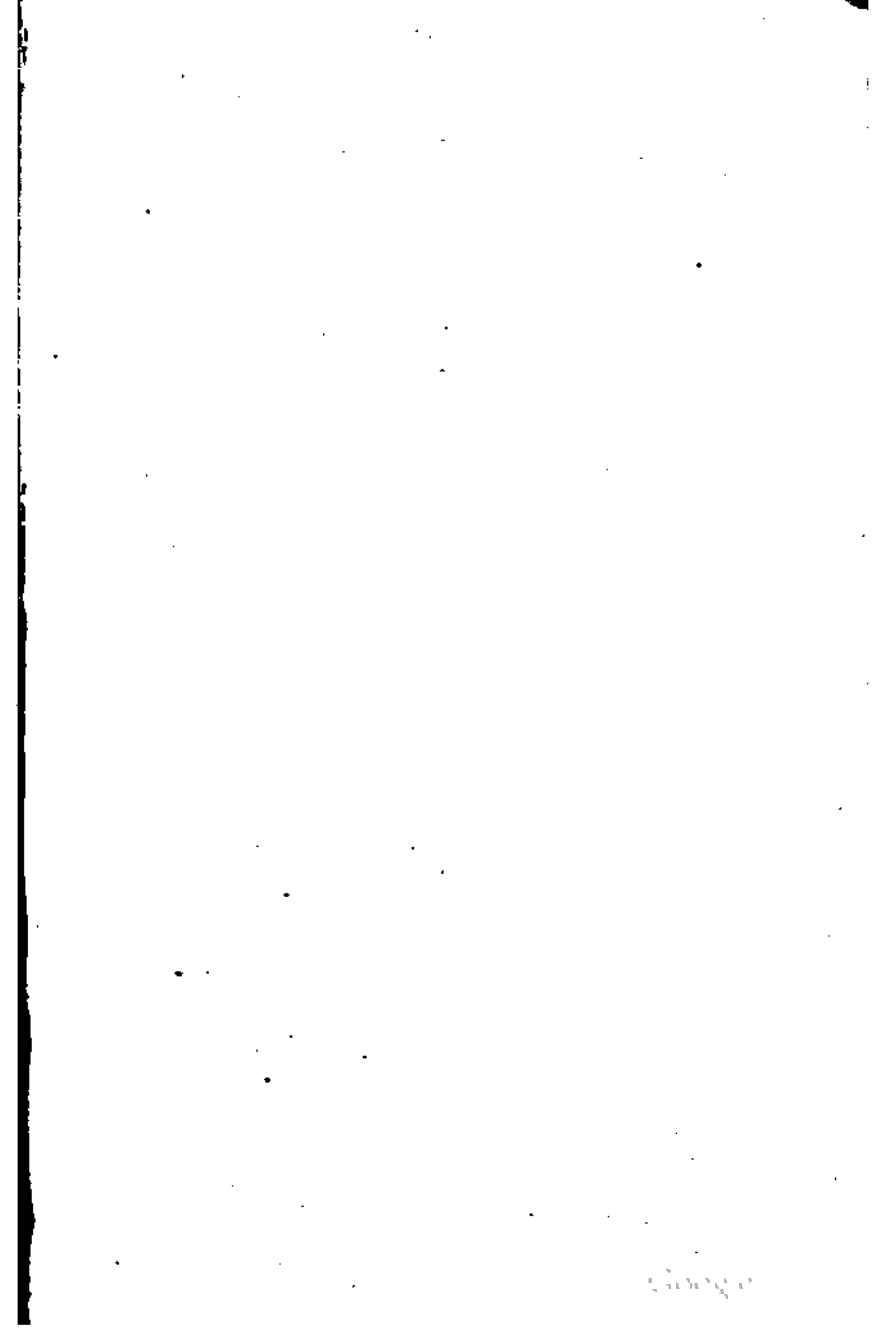



# HANDBOOK OF SHIP CALCULATIONS, CONSTRUCTION AND OPERATION

A BOOK OF REFERENCE FOR SHIPOWNERS, SHIP  
OFFICERS, SHIP AND ENGINE DRAUGHTSMEN,  
MARINE ENGINEERS, AND OTHERS ENGAGED  
IN THE BUILDING AND OPERATING OF SHIPS

BY

CHARLES H. HUGHES

NAVAL ARCHITECT AND ENGINEER



D. APPLETON AND COMPANY

NEW YORK

LONDON

1917



V. 1151  
42

COPYRIGHT, 1917, BY  
D. APPLETON AND COMPANY

*Printed in the United States of America*

## PREFACE

---

This handbook has been compiled with the purpose of assembling in a single publication in convenient form, practical data for everyday reference, for men engaged in the designing, building and operating of ships. Theoretical calculations have been purposely omitted.

Shipowners and men in the offices of steamship companies will find particular interest in the sections on Loading and Stowing of Cargoes, Maintenance, Ship Chartering, and Marine Insurance.

To men employed in shipyards the sections on Ship Calculations and Hull Construction, Structural Details, Machinery, and Ship Equipment, and the various formulæ for making quick calculations will be of use. In making preliminary designs the section on Hull and Machinery Weights, as also the tables giving particulars of all classes of vessels, will be found convenient.

Ship officers and marine engineers will find, in the section on Machinery, valuable data on the overhauling of boilers, on indicator cards, on the operating of pumps, condensers and motors, and many other practical subjects. They will find useful also the sections on Loading and Stowing of Cargoes, Ship Machinery, and many other subjects.

Marine underwriters, ship brokers and freight brokers will find convenient data on ship construction and the stowage sizes of materials, with a large number of miscellaneous tables.

For men engaged in the designing and building of war vessels a section on warships has been included, which describes the different classes and their armor and armament. Although the fundamental calculations for all vessels, merchant and war, are the same, the text contains frequent special references to warships, as on the subject of electric propulsion, electric steering gears, electric winches, etc.

To the student of naval architecture and marine engineering this handbook offers a broader collection of practical data than

any other published work. The very latest marine practice is given, and such subjects as electric propulsion, geared turbines, Diesel engines, and oil fuel are fully treated, as are also recent and special types of construction, such as tankers, battle cruisers, submarine chasers, and submarines.

The handbook represents many years of collection and classification of material, assembled primarily for the writer's everyday use. The data have been obtained from many sources (see authorities), not only from textbooks but very largely from technical papers and trade literature. As it is impossible to mention in the text all the works consulted and used, the writer wishes to make here a general acknowledgment of his indebtedness to many other workers in the marine field. He wishes to thank particularly the editors of *International Marine Engineering* and *Shipping Illustrated*. Prof. H. E. Everett kindly revised the section on Freeboard. Mr. J. C. Craven checked Structural Details, while other friends in the trade read over various sections: To Mr. F. G. Wickware, of D. Appleton and Co., he is indebted for the typographical arrangement and many suggestions.

CHAS. H. HUGHES.

New York,

June 26, 1917.

# CONTENTS

(See also Index)

## SECTION I

### WEIGHTS, MEASURES AND FORMULÆ

PAGE

Weights and Measures—United States and Great Britain .....	1
Weights and Measures—Metric System .....	4
Decimal Equivalents of Fractions of an Inch .....	5
Centimeter, Gram, Second System .....	6
Conversion Table—Metric Units into United States .....	7
Board Measure .....	8
Water, Weights of Different Units of .....	8
Feet Board Measure in Timber .....	9
Inches and Fractions in Decimals of a Foot .....	10
Water Conversion Table .....	11
Composition of Salt Water .....	12
Specific Gravities and Weights of Materials .....	13
Cubic Feet per Ton or Stowage Sizes of Materials .....	16
Shipping Weights of Lumber .....	18
Weights of Miscellaneous Units of Different Products .....	19
Bundling Schedule of Pipe .....	20
Barrels, Sizes of .....	20
Horse Powers .....	22
Equivalent Values of Mechanical and Electrical Units .....	23
Comparison of Thermometer Scales .....	24
Thermometers .....	25
Circumferences and Areas of Circles Advancing by Eights .....	25
Involution and Evolution .....	26
To Extract the Square Root of a Number .....	26
To Extract the Cube Root of a Number .....	27
Logarithms .....	28
Powers and Roots of Numbers .....	29
Circumferences and Areas of Circles .....	29
Geometrical Propositions .....	31
Circle and Ellipse, Formulæ pertaining to .....	32
Areas of Plane Figures and Surfaces of Solids .....	33
Volumes of Solids .....	36
Trigonometry—Trigonometric Functions .....	39
Oblique Triangles .....	41
Trigonometric Formulæ .....	42
Natural Sines, Cosines, etc., Table of .....	43
Moment of Inertia, Radius of Gyration and Center of Gravity .....	50
Center of Gravity of a Cross Section of a Ship .....	50
Center of Gravity of a Water Plane .....	51
Properties of Sections .....	52

SECTION II  
STRENGTH OF MATERIALS

	PAGE
Definitions—Stress, Strain, Tension, etc. ....	70
Strength of Materials, Tables. ....	71
Factors of Safety. ....	73
Timber, Strength of. ....	74
Beams—Neutral Axes, Bending Moment, Shearing Stresses, etc. ....	75
Beam Formulae. ....	76
Beams Under Various Loading Conditions. ....	78
Columns—Formulae for. ....	84
Safe Loads for H and I Columns. ....	86
Safe Loads for Square and Round Wood Columns. ....	87
Safe Loads for Wrought Iron Pipe, Strong and Extra Strong Columns. ....	88
Torsional Stresses. ....	89
Springs. ....	90
Tubes, Pipes and Cylinders, Formulae for. ....	90
Bursting and Collapsing Pressures of Wrought Iron Tubes. ....	91
Ship Fittings, Strength of. ....	91
Shearing and Tensile Strength of Bolts. ....	93
Tests of Hooks. ....	94
Tests of Shackles. ....	95
Tests of Eye Bolts. ....	95
Tests of Hoist Hooks. ....	96
Tests of Turnbuckles. ....	97
Formulae for Davits. ....	97
Stresses in Cranes, Derricks and Shear Legs. ....	98
Rivet Heads and Points. ....	101
Proportions of Rivets. ....	102
Diameters of. ....	102
Lengths for Ordering. ....	102
Signs for Rivets. ....	103
Shearing and Tensile Strength of Steel Rivets. ....	104
Formulae for Riveted Joints. ....	105
Shearing Value of Rivets and Bearing Value of Riveted Plates. ....	107
Reduction of Diameters to Inches. ....	108
Weight of Cone Head Rivets. ....	100
Number of Cone Head Rivets in 100 lbs. ....	110

SECTION III  
SHIPBUILDING MATERIALS

Steel and Iron

Steel, Methods of Manufacture. ....	111
Carbon, Manganese, Nickel and Alloy Steels. ....	112
Structural Steel—Lloyd's, Am. Bureau of Shipping and Am. Soc. of Testing Materials, Requirements. ....	114
Rivet Steel. ....	117
Cast Steel. ....	118

# Table of Contents

ix

	PAGE
Iron.....	119
Wrought Iron.....	120
Cast Iron.....	120
Malleable Iron.....	121
Pickling Steel Plates.....	121
Galvanizing Fittings and Steel Plates.....	121
Weights of Steel Plates in Hundredths of an Inch.....	122
Standard Gauges—United States and Great Britain for Sheets and Plates....	123
Diamond Checkered Plates.....	125
Weights of Sheets and Plates of Steel, Copper and Brass (Birmingham Wire Gauge).....	126
Weights of Sheets and Plates of Steel, Copper and Brass (American or Brown and Sharpe Gauge).....	127
Sizes of Steel Plates and Heads.....	128
Sizes and Properties of Structural Shapes.....	129
Weights and Areas of Square and Round Bars, and Circumferences of Round Bars.....	143
Weights of Flat Rolled Steel Bars.....	149

## Non-Ferrous Metals and Alloys

Copper.....	155
Aluminum.....	155
Zinc.....	155
Lead.....	155
Tin.....	155
Bronzes—Phosphor, Admiralty, Titan, Tobin, Manganese.....	156
Gun Metal.....	156
Brasses.....	156
Muntz Metal.....	157
Naval Brass.....	157
Alloys.....	157

## Wood

Sawing and Seasoning.....	157
Hardness of Wood, How Measured.....	158
Table of Relative Hardness of Soft Woods.....	158
Table of Relative Hardness of Hard Woods.....	159
Hard Wood Sizes.....	159
Soft Wood Sizes.....	160
Characteristics, Weights and Specific Gravities of Woods used in Ship-building.....	160

## Miscellaneous Non-Metallic Materials

Oakum.....	162
Caulking Cotton.....	162
Portland Cement.....	162
Insulating Materials—Magnesia, Asbestos, Cork, Hair Felt, Mineral Wool....	162
Steam Pipe Covering.....	163
Boiler Covering.....	163

	PAGE
Cylinder Covering.....	164
Tests of Insulating Materials.....	164
Relative Value of Non-Conducting Materials.....	165

## SECTION IV

## SHIP CALCULATIONS

Lengths.....	166
Breadth.....	166
Depth.....	167
Draft.....	167
Displacement.....	168
Displacement Curve.....	169
Deadweight.....	169
Registry.....	169
Tonnage.....	169
Cubic Capacity.....	170
Tons per Inch of Immersion.....	170
Coefficients—Prismatic, Block, etc.....	171
Wetted Surface.....	172
Center of Buoyancy.....	172
Transverse Metacenter.....	173
Metacentric Heights.....	174
Moment of Inertia of a Water Plane about its Center Line.....	176
Displacement Sheet.....	177
Curves of Stability.....	183
Notes on Stability.....	189
Trim.....	190
Moment to Alter Trim.....	190
To Find the Trim by Trim Lines.....	192
Quantity of Water That Will Flow Into a Ship Through a Hole in Her Side.....	195
Compartment Flooded, Calculation of Trim, by Trim Lines.....	195
Compartment Flooded, Calculation of Trim, by Mean Sinkage.....	196
Center of Gravity of a Vessel, Fore and Aft Position of.....	200
Center of Gravity of a Vessel, Vertical Position of.....	202
Heights of the Center of Gravity above the Base.....	202
Heights of the Metacenter above the Base.....	202
Effects of Moving Weights.....	203
To Find the Center of Gravity of a Vessel by Moving Weights.....	204
Freeboard.....	205
Freeboard Calculations.....	213
Freeboard Calculations for a Shelter Deck Steamer.....	218
Freeboard Notes.....	220
Freeboard Markings.....	221
Powering Vessels.....	222
Approximate I. H. P. to Propel a Vessel.....	222
Effective Horse Power.....	223
Towing.....	223
Engine Revolutions to Drive a Vessel at a Given Speed.....	224
Formula for Estimating Speed of a Motor Boat.....	224

# Table of Contents

xi

	PAGE
Resistance.....	225
Law of Comparison.....	226
Surface Friction Constants.....	227
Launching.....	227
Launching Ways.....	228
Launching Calculations.....	229
Releasing and Checking Devices.....	231
Launching Data.....	232
Declivity of Ways and Launching Velocity.....	233

## SECTION V

### HULL CONSTRUCTION

Classification Societies and Organisations Governing Shipping.....	234
Types of Merchant Vessels.....	238
War Vessels.....	238
Armor.....	244
Armament.....	245
Types of War Vessels.....	247
Systems of Construction of Merchant Vessels.....	253
Frames.....	255
Reverse Frames.....	256
Shell Plating.....	258
Double Bottom.....	261
Keelsons and Longitudinals.....	263
Keels.....	264
Deck Plating and Coverings.....	264
Deck Beams.....	265
Hatchways.....	266
Pillars.....	268
Stringers.....	268
Bulkheads.....	268
Stem and Stern Frames.....	272
Rudders.....	275
Machinery Foundations.....	277
Deck Erections.....	277
Cementing.....	278
Painting.....	279
Wood Vessels.....	282
Carpenter and Joiner Work.....	284
Interior Painting.....	287
Tables of Screws, Nails and Spikes.....	290
Structural Strength.....	294
Curves of Weights.....	294
Curve of Buoyancy.....	296
Curve of Loads.....	296
Neutral Axis and Moment of Inertia Calculations.....	297
Hogging and Sagging.....	298
Curve of Shearing Stresses.....	298



	PAGE
Curve of Bending Moments.....	299
Specification Headings for Hull.....	300
Specification Headings for Machinery.....	301
Specification Headings for Equipment.....	301
Hull Weights, Formulae for.....	302
Hull Weights of Vessels.....	303
Machinery Weights per I. h. p.....	304
Engine Weights.....	305
Boiler Weights.....	306
Weights of Water Tube Boilers.....	308
Weights of Boilers, Engines and Auxiliaries.....	308
Weights of Diesel Engines.....	309
Data on Passenger and Cargo Steamers [reciprocating engines].....	310, 311
Data on Passenger and Cargo Steamers [turbines].....	312
Data on Excursion Vessels, Tugs, Lighters and Steam Yachts.....	314
Data on Motor Ships.....	316
Data on Motor Boats.....	317
Data on Sailing Vessels with Motors.....	318
Data on Schooners.....	319
Data on Schooners with Motors.....	320
Oil Carriers.....	320
Lumber Steamers.....	327
Trawlers.....	327
Dredges.....	327
Shallow Draft Steamers.....	328
Tunnel Vessels.....	330
Fittings for Cattle and Horse Steamers.....	330
Prices, Costs and Estimates.....	331
Prices of Vessels sold in 1916.....	332
Estimates for Building a Motor Schooner.....	334
Estimates for Operating a Motor Schooner.....	334
Operating Costs of Diesel Engines.....	335
Repair Costs of Motor Ships.....	336
Costs of Electric and Refrigerating Systems.....	337
Prices of Steam Engines and Boilers.....	337
Estimates, Preparing.....	338
Labor Costs.....	340

## SECTION VI

## MACHINERY

## Steam

Definitions—British Thermal Unit, Mechanical Equivalent of Heat, Calorie..	341
Specific, Total and Latent Heat of Steam.....	342
Saturated Steam.....	343
Superheated Steam.....	343
Dry Steam.....	343
Wet Steam.....	343
Steam Table—Properties of Saturated Steam.....	344

## Fuels

Coal Required to Evaporate one Pound of Water .....	349
Coal Consumption .....	349
Coal or Oil Consumption .....	350
Evaporation per Pound of Combustible .....	350
Heat Values of Coal .....	351
Calorific Value of Coal from its Chemical Analysis .....	351
Sizes of Coals .....	351
Heat Values of Wood .....	352
Temperature of Fire .....	353
Air Required for Combustion of Fuel .....	353

## Oil

Crude Petroleum and its Products .....	353
Fuel Oil, Table of Beaumé Gravity, Specific Gravity, etc., of .....	354
Beaumé Gravity .....	355
Specific Gravities and Weights of Oils .....	355
Definitions—Flash Point, Fire Point, Viscosity, etc. ....	356
Oil for Boilers .....	356
Heat Values of Oil .....	356
Fuel Oils for Internal Combustion Engines .....	357
Lubricating Oil .....	358
Oil Burning Systems .....	360

## Boilers

Types of Boilers .....	363
Scotch Boilers, Proportions of .....	363
Scotch Boilers, Tables of .....	364
Locomotive Boilers .....	366
Leg Boilers .....	366
Water Tube Boilers .....	368
Comparison of Fire Tube and Water Tube Boilers .....	370
Boiler Horse Power .....	371
Boiler Horse Power Required for an Engine .....	371
Factor of Evaporation .....	373
Boiler Efficiency .....	374
Gallons of Water Evaporated per Minute in Boilers .....	375
Boiler Fittings .....	376
Safety Valve .....	376
Stop Valve .....	377
Feed Water Connections for Scotch Boilers .....	377
Feed Check Valve .....	378
Surface and Bottom Blows .....	378
Steam Gauges .....	378
Water Gauges and Cocks .....	379
Boiler Circulators .....	379
Fusible Plugs .....	379
Injectors and Inspirators .....	380
Hydrometer .....	381
Superheaters .....	382
Ash Ejectors .....	384

	PAGE
Boiler Operating.....	385
Firing.....	385
Shutting Off Boilers.....	386
Overhauling Boilers.....	386
Boiling Out Boilers.....	387
<b>Draft</b>	
Systems.....	389
Measurement of Draft.....	389
Velocity of Air under Pressure Escaping into the Atmosphere.....	390
Air Required.....	390
Blowers.....	391
Forced Draft Installations.....	392
Frictional Resistance of Stack.....	393
<b>Marine Steam Engines</b>	
Types of.....	394
Ratio of Cylinders and Steam Expansion.....	394
Expansion, Cut-off and Back Pressure.....	395
Crank Sequences.....	396
Paddle Wheel Engines.....	397
Valves.....	399
Lap and Lead.....	400
Valve Travel.....	401
Valve Mechanism.....	402
Setting Valves.....	404
Steam Pressure in a Cylinder at End of Stroke.....	404
Steam Pressure at Different Cut-offs.....	405
Cut-off and Coal or Steam Consumption.....	405
Indicator Cards.....	406
Mean Effective Pressure and I. H. P. Calculations.....	410
Coal Consumption per I. H. P.....	411
Engine Formulae—Estimated Horse Power.....	411
Shafting.....	412
Cylinders.....	413
Connecting Rod.....	413
Piston Rod.....	414
Pistons.....	414
Bearing Surfaces.....	414
Engine Fittings.....	414
Thrust and Line Shafting Bearings.....	418
Engine Room Floors.....	419
Operating.....	419
Trials.....	421
<b>Propellers</b>	
Definitions—Pitch, Driving Face, Projected Area, etc.....	424
Slip.....	425
Table of Propellers.....	426
Formulae for Slip, Speed, Revolutions and Pitch.....	428
Rule for Finding Pitch of a Propeller.....	428

	PAGE
Rule for Finding Helicoidal and Projected Area .....	429
Propeller Thrust .....	429
Propellers for Turbine Ships .....	429
Formulae for Keys, Nuts, etc .....	430
Propellers for Motor Boats .....	431
Weights of Propellers .....	432
Speed Table, When Pitch, Slip and R. P. M. Are Given .....	433
<b>Paddle Wheels</b>	
Breadth of Floats, etc .....	436
Formulae for Slip, Speed, Revolutions and Pitch .....	436
Table of Paddle Wheels .....	437
<b>Steam Turbines</b>	
Types of Turbines .....	439
Geared Turbines .....	442
Trials of Geared Turbines and Reciprocating Engines .....	443
Turbo-electric Propulsion .....	444
Comparative Performance of Different Systems of Propulsion .....	445
Efficiency .....	446
Steam Consumption .....	446
Weights .....	446
Calculation of Horse Power .....	447
Steam per Shaft Horse Power .....	448
Auxiliaries .....	448
<b>Steam Plant Auxiliaries</b>	
Definitions—Atmospheric Pressure, Gauge Pressure, etc .....	449
Thermodynamics of Condensers .....	449
Types of Condensers .....	450
Surface Condensers .....	452
Operating .....	453
Vacuum and Vacuum Gauge .....	454
To Find Vacuum under Working Conditions .....	455
Vacuum and Corresponding Steam Temperature .....	456
Jet Condensers .....	456
Cooling Water Required for Surface or Jet Condenser .....	457
Keel or Outboard Condensers .....	459
Air Pump .....	459
Circulating Pump .....	462
Feed and Filter Tank .....	462
Steam Traps .....	463
Feed Water Filter .....	464
Feed Water Heaters .....	465
Evaporators .....	467
Pumps, Types of .....	470
Reciprocating Pumps .....	470
Centrifugal Pumps .....	474
Pumps installed in a Freight Steamer .....	477
Installing and Operating Pumps .....	477

	PAGE
<b>Internal Combustion Engines</b>	
Fuels .....	478
Operation .....	479
Horse Power Formula .....	480
Table of Engines (Electric Ignition) .....	481
Carburetors and Vaporizers .....	482
Starting .....	482
Reverse Gears .....	483
Lubricating Systems .....	484
Valves .....	484
Ignition Systems .....	486
Timers and Distributors .....	487
Magnetos .....	489
Spark Plugs .....	490
Motor Trouble .....	491
Hot Bulb Engines .....	492
Diesel Engines .....	495
Comparison of Diesel Engines, Steam Engines and Turbines .....	495
General Features of Diesel Engines .....	496
Operation .....	498
Types of Diesel Engines .....	501
Diesel Engine Installations .....	506
<b>Piping, Tubing, Valves and Fittings</b>	
Trade Terms .....	507
Tables of Standard, Extra Strong, and Double Extra Strong Wrought Iron Pipe .....	508, 509
Boiler Tubes .....	510, 511, 512
Copper Tubes .....	513
Brass and Copper Tubes .....	514
Brass and Copper Pipe .....	518
Formula for Working Pressure .....	518
Copper Tubes .....	519
Bending Pipes and Tubes .....	519
Flow of Water through Pipes .....	520
Comparative Areas of Pipes .....	521
Flanges .....	522
Bolt and Pipe Threads .....	524
Gaskets .....	526
Nipples and Couplings .....	526
Unions .....	526
Materials for Piping Systems .....	527
Valves, Cocks and Fittings .....	528
<b>SECTION VII</b>	
<b>ELECTRICITY</b>	
Definitions—Ohm, Ampere, Volt, Coulomb, etc. ....	531
Voltage .....	532
Wires, Calculation of Size of .....	533
Tables of Sizes of Wires .....	534, 535, 536, 537

	PAGE
Diameters by Different Wire Gauges.....	538
Wiring Systems.....	539
Conduits.....	541
Switchboards and Equipment.....	543
Determination of Output.....	543
Laying Out Electric Installations.....	544
Wiring of a Steamer.....	547
Wiring of a Motor Boat.....	550
Wiring of Gasoline Engines.....	551
Incandescent Lamps.....	552
Searchlights.....	553
Primary Batteries.....	554
Storage Batteries.....	554
Grouping of Cells.....	557
Generating Sets.....	557
Windings of Generators.....	558
Engine Horse Power.....	558
Tables of Direct Connected Sets.....	559
Operating Notes.....	560
Electric Motors, Windings of.....	561
Formula for Horse Power of Motor.....	562
Weights of Motors.....	563
Current Taken by Motors.....	564
Motors for Ship Work.....	564
Motor Starting and Controlling Devices.....	565

## SECTION VIII

HEATING, VENTILATION, REFRIGERATION, DRAINAGE, PLUMBING  
AND FIRE EXTINGUISHING SYSTEMS

Heat Passing Through a Ship's Side or Bulkhead.....	567
Heating Systems.....	568
Heating by Steam.....	568
Steam Heating Installations.....	568
Sizes of Radiators.....	569
Square Feet of Radiation for a Room.....	570
Heating Surfaces of Pipes.....	571
Heating by Thermostats.....	571
Heating by Electricity.....	573
Heating by Special Systems.....	574
<b>Ventilation</b>	
Fresh Air Required.....	575
Air Pressure.....	576
Systems—Plenum and Exhaust.....	576
Ventilation of Oil Carriers.....	578
Ventilation of Engine Rooms.....	579
Ventilators.....	579
Fans, Types of.....	580
Horse Power Required to Drive a Fan.....	582

	PAGE
Ducts.....	582
Data on the Escape of Air into the Atmosphere.....?	583
Duct Areas.....	584
Laying Out Ventilating Systems.....	584
Loss of Pressure by Friction of Air in Pipes.....	585
<b>Refrigeration</b>	
Keeping Perishable Products.....	587
Insulating Materials.....	587
Cold Storage Temperatures.....	588
Compression System.....	591
Brine Circulating.....	593
Refrigerants—Ammonia and Carbon Dioxide.....	594
Different Makes of Machines.....	594
Cooling by Air.....	595
Pipe, Valves and Fittings.....	596
Linear Feet of Pipe Required.....	596
Capacity of Ammonia Compressors.....	597
Refrigeration Required for Cold Storage Rooms.....	598
Refrigeration Required for Stored Products.....	599
Specific Heat and Latent Heat of Food Products.....	600
Horse Power Required for Compressors.....	600
Operating Notes.....	600
<b>Drainage</b>	
Systems.....	601
Main Drain.....	602
Auxiliary Drain.....	603
U. S. Steamboat-Inspection and Lloyd's Requirements.....	603
<b>Plumbing</b>	
Fixtures.....	606
Waste Lines.....	609
Fresh Water Service.....	609
<b>Fire Extinguishing and Alarm Systems</b>	
General Requirements.....	610
Fire Main (Water).....	611
Sizes of Water Streams.....	612
Fire Main (Steam).....	612
Sulphur Dioxide System.....	613
Sprinkler Systems.....	614
Fire Alarms.....	614
<b>SECTION IX</b>	
<b>SHIP EQUIPMENT</b>	
Steering Gears.....	615
Steam Steering Gears.....	615
Electric Steering Gears.....	616
Arrangements.....	617
Installations.....	618

	PAGE
Transmission.....	620
Power Required to Turn a Rudder.....	623
Pressure on Rudder.....	623
Steering Chain and Rod.....	624
Windlasses—Steam and Electric.....	624
Table of Steam Windlasses.....	625
Winches or Hoisting Engines—Steam and Electric.....	626
Tables of Winches.....	627
Power Required to Raise a Load.....	628
Rope Capacity of a Drum.....	628
Capstans and Gypsy Capstans—Steam and Electric.....	630
Tables of Capstans.....	630
Towing Machines.....	631
Rope, Trade Terms.....	632
Hoisting Speeds.....	632
Knots and Hitches.....	633
Tension in Hoisting Rope.....	634
Kinds of Rope, Materials and Strands.....	634
Weight and Strength of Manila Rope.....	636
Weight and Strength of Hemp Clad Wire Rope.....	637
Weight and Strength of Flattened Strand Hoisting Rope.....	638
Table Comparing Manila and Hemp Clad Wire Rope.....	640
How to Measure Wire Rope.....	640
Weight and Strength of Cast Steel Wire Rope.....	641
Weight and Strength of Steel Mooring Lines.....	642
Formule for Size and Weight of Rope.....	642
Weight and Strength of Yacht Rigging and Guy Ropes.....	643
Weight and Strength of Galvanised Steel Hawseers.....	644
Weight and Strength of Galvanised Ships' Rigging and Guy Ropes.....	645
Weight and Strength of Galvanized Steel Hawseers.....	646
Length of Rope Required for Splices.....	646
Blocks, Types of.....	646
Wood Blocks for Manila Rope.....	648
Steel Blocks for Wire Rope.....	648
Working Loads for Blocks.....	648
Tackles, Types of.....	650
Power Gained with Tackles.....	652
Chain.....	655
Pitch, Breaking and Working Strains of Chain.....	656
Anchors, Types of.....	657
Anchors for Yachts and Motor Boats.....	657
Anchors for Steam Vessels.....	658
Anchors for Sailing Vessels.....	659
Anchor Cranes.....	660
Life-Saving Equipment—U. S. Steamboat-Inspection Requirements.....	663
Life-Saving Equipment, Abstracts from Seamen's Bill.....	665
Capacities of Lifeboats.....	669
Lundin Lifeboats.....	670
Engelhardt Collapsible Lifeboats.....	671
Life Rafts.....	672



	PAGE
Life Preservers.....	672
Buoys.....	673
Boats Carried by War Vessels.....	673
Boat Davits.....	673
Rotating Davits.....	673
Pivoted Davits.....	676
Quadrant Davits.....	676
Heel of a Vessel When Lowering a Boat.....	678
Rigs of Vessels.....	679
Wireless Equipment.....	680
Storm Oil.....	681
Line-carrying Guns and Rockets.....	682

## SECTION X

## SHIP OPERATING

## Loading and Stowing of Cargoes

General Considerations—Stability, Winging Out Weights, etc.....	683
Oil Cargoes—Bulk.....	684
Stowage of Oil in Barrels.....	685
Stowage of Oil in Cases.....	686
Grain Cargoes.....	688
Settling of Grain and Angle of Repose.....	688
Rules of N. Y. Board of Underwriters.....	688
Board of Trade Requirements.....	692
Coal Cargoes.....	693
Effect of Using Bunker Coal.....	693
Rules of N. Y. Board of Underwriters.....	693
Lumber Cargoes.....	694
Regulations for Carrying Dangerous Articles.....	695

## MACHINERY OPERATING (see Index)

## Maintenance

When Surveys Are to Be Made.....	696
Hull—Shell Plating Working.....	698
Decks Leaking.....	698
Removing of Rubbish from Bilges.....	698
Galvanic Action.....	698
Corrosion in Double Bottom.....	699
Sea Valves and Outboard Bearings.....	699
Docking.....	699
Painting (see Index)	
Machinery, Care of.....	700
Surveys.....	700
Taking Indicator Cards.....	701
Care of Boilers.....	701
Log to Be Kept by Engineer.....	702

## Table of Contents

xxi

	PAGE
<b>Ship Chartering</b>	
Trip Charters.....	703
Contracts for the Movement of Freight.....	704
Time Charter.....	704
Charter Forms.....	704
Preamble Clause.....	707
Delivery.....	707
Redelivery.....	708
Trading Limits and Insurance Warranties.....	708
Speed and Consumption.....	708
Berth Terms.....	709
Cotton Rates.....	709
Abbreviations.....	709
<b>Marine Insurance</b>	
Insurable Value.....	711
Ship.....	711
Freight.....	711
Goods.....	711
Policies, Paragraphs in.....	711
Kinds of Policies.....	713
General Average.....	713
Particular Average.....	714
River Plate, Clause.....	715
Protection and Indemnity Clause.....	715
Collision or Running Down Clause.....	715
Inchmaree Clause.....	715
<b>Export and Shipping Terms</b>	
Abbreviations and Terms.....	716
Authorities Quoted.....	718
Index.....	721



## ABBREVIATIONS AND SYMBOLS

### Weights and Measures (U. S. and English)

oz.	ounce	qt.	quart
lb.	pound	gal.	gallon
cwt.	hundredweight	pk.	peck
in.	inch	bu.	bushel
"	inch	sq.	square
ft.	foot	□'	square foot
'	foot	cu.	cubic
yd.	yard	Ft. B.M.	feet board measure
fath.	fathom	C.G.S.	Centimeter, Gram, Second System
mi.	mile		
kt.	knot	dbl.	barrel
pt.	pint		

### Weights and Measures (Metric)

m.	meter	l.	liter
g.	gram		See metric system for prefixes.

### Miscellaneous

=	equals	sec	secant
<	less than	cosec	cosecant
>	more than	F. or	
Σ	sum	Fahr.	Fahrenheit
√	square root of the	C	Centigrade
	quantity under the	R	Réaumer
	sign	Be	Beaumé
∛	cube root of the quan-	I	moment of inertia
	tity under the sign	S	modulus of section
a <sup>2</sup>	square root of a	r	radius of gyration
a <sup>2</sup>	square of a	Sp. gr.	specific gravity
a <sup>n</sup>	nth root of a	g	acceleration due to
a <sup>n</sup>	a raised to the nth		gravity = 32.16 ft.
	power		per sec.
°	degrees	B.t.u.	British thermal unit
%	per cent	S.W.G.	Stubs Wire Gauge
e	3.14159	B.w.g.	Birmingham wire gauge
log	logarithm	B & S	Brown & Sharpe
sin	sine	A.W.G.	American Wire Gauge
cos	cosine	I.W.G.	Imperial Wire Gauge
tan	tangent	N.B.S.	New British Standard
cotan	cotangent		

## Naval Architecture

F.P.	forward perpendicular	C.G.	center of gravity
A.P.	after perpendicular	B.M.	distance between center of buoyancy and metacenter
Bet.		B.G.	distance between center of buoyancy and center of gravity
perps.	length between perpendiculars	G.M.	distance between center of gravity and metacenter
L.O.A.	length over all	G.Z.	arm of righting couple
B.	beam molded	Bkhd.	bulkhead
D.	depth molded	B.L.	base line
<del>at</del>	midship section		See Rivets and Riveting
d.w.	dead weight		
W.L.	or		
w.l.	water line		
C.B.	center of buoyancy		
M.	metacenter		

## Machinery

h.p.	horse power	t.h.p.	thrust horse power
i.h.p.	indicated horse power	m.e.p.	mean effective pressure
e.h.p.	effective horse power	r.p.m.	revolutions per minute
b.h.p.	brake horse power	G.S.	grate surface
n.h.p.	nominal horse power	H.S.	heating surface
s.h.p.	shaft horse power		

## Electricity

d.c.	direct current	Q.	coulomb
a.c.	alternating current	J.	Joule
C.	amperes	W.	watt
E.	volts	Kw.	kilowatt
R.	Ohms	c.p.	candle power
e.m.f.	electromotive force	cir. mils.	circular mils

Ship Chartering abbreviations.—See section on Ship Chartering.

Marine Insurance abbreviations.—See section on Marine Insurance.

Shipping and Export abbreviations.—See section on Shipping and Export Terms.

**HANDBOOK OF SHIP CALCULATIONS,  
CONSTRUCTION AND OPERATION**

THE UNIVERSITY OF CHICAGO  
LIBRARY

George

# Handbook of Ship Calculations, Construction and Operation

## SECTION I

### WEIGHTS, MEASURES AND FORMULAE

#### WEIGHTS AND MEASURES

##### TROY WEIGHT

24 grains = 1 pennyweight      12 ounces = 1 pound  
20 pwts. = 1 ounce

Used for weighing gold, silver and jewels.

##### APOTHECARIES' WEIGHT

20 grains = 1 scruple      8 drams = 1 ounce  
3 scruples = 1 dram      12 ounces = 1 pound

The ounce and pound in this are the same as in Troy weight.

##### AVOIRDUPOIS WEIGHT

27.344 grains = 1 dram      2000 pounds = 1 short ton  
16 drams = 1 ounce      2240 pounds = 1 long ton  
16 ounces = 1 pound

##### SHIPPING WEIGHT

16 ounces = 1 pound (lb.)  
28 pounds = 1 quarter (qr).  
4 quarters or 112 pounds = 1 hundredweight (cwt.)  
20 hundredweight or }  
2240 pounds                = 1 ton (T.)



## WEIGHTS AND MEASURES

## SHIPPING MEASURE

1 register ton	= 100 cubic feet
1 United States shipping ton	= 40 cubic feet or 2.14 United States bushels or 31.16 Imperial bushels
1 British shipping ton	= 42 cubic feet or 32.72 Imperial bushels or 33.75 United States bushels

## LINEAR MEASURE (LAND)

12 inches = 1 foot	40 rods	= 1 furlong
3 feet = 1 yard	8 furlongs	} = 1 mile (statute)
5½ yards = 1 rod	or 5280 feet	

Other units are: 4 inches = 1 hand; 9 inches = 1 span; 1000 mils = 1 inch; 7.92 inches = 1 link; 100 links or 66 feet or 4 poles = 1 chain; 10 chains = 1 furlong.

## MARINER'S MEASURE

6 feet	= 1 fathom	6080 feet	= 1 nautical mile (knot)
120 fathoms	= 1 cable length	3 knots	= 1 league
1 cable length = 120 fathoms = 960 spans = 720 feet = 219.457 meters.			

1 international nautical mile =  $\frac{1}{60}$  degree at meridian = .999326 U. S. nautical miles = 1852 meters = 6076.10 ft.

1 U. S. nautical mile is the length of one minute of arc of a great circle of a sphere whose surface equals that of the earth. Thus 1 U. S. nautical mile = 1.15155 statute miles = 6080.20 ft. = 1853.25 meters.

1 British nautical mile = 1.15152 statute miles = 6080 feet = 1853.19 meters. The knot generally adopted is the one of 6080 feet.

## SQUARE MEASURE

144 square inches	= 1 square foot	40 square rods	= 1 rood
9 square feet	= 1 square yard	4 roods	= 1 acre
30¼ square yards	= 1 square rod	640 acres	= 1 square mile

## TIME MEASURE

60 seconds	= 1 minute	24 hours	= 1 day
60 minutes	= 1 hour	7 days	= 1 week
28, 29, 30 or 31 days = 1 calendar month (30 days = 1 month in computing interest)			
365 days	= 1 year	366 days	= 1 leap year

## CIRCULAR MEASURE

60 seconds = 1 minute

90 degrees = 1 quadrant

60 minutes = 1 degree

360 degrees = 1 circumference

Instead of an angle being given in degrees it can be given in radians, one radian being equal to the arc of a circle whose length is the radius. Thus if  $R$  denotes the radius, the circumference

of the circle  $2\pi R$ , then the circular measure of  $90^\circ = \frac{\frac{1}{4} \times 2\pi R}{R} =$

$\frac{\pi}{2}$ ; similarly the circular measure of  $180^\circ$  is  $\pi$ ,  $60^\circ = \frac{\pi}{3}$ , etc.

An angle expressed in degrees may be reduced to circular measure by finding its ratio to  $180^\circ$  and multiplying the result by  $\pi$ .

Hence the circular measure of  $115^\circ$  is  $\frac{11.5\pi}{18} = .63\pi$

An angle expressed in circular measure may be reduced to degrees by multiplying by 180 and dividing by  $\pi$ , or by substituting 180 for  $\pi$ . As  $\frac{7\pi}{15} = \frac{7}{15} \times 180 = 84^\circ$ .

The angle whose subtending arc is equal to the radius, or the unit of circular measure reduced to degrees is  $\frac{180^\circ}{\pi} = 57.2958$ .

Therefore an angle expressed in circular measure may be reduced to degrees by multiplying by 57.2958. Thus the angle  $\frac{2}{3} = \frac{2}{3} \times 57.2958 = 38.1972^\circ$ .

## DRY MEASURE

2 pints = 1 quart

4 pecks = 1 bushel

8 quarts = 1 peck

36 bushels = 1 chaldron

One United States struck bushel contains 2150.42 cu. ins. or 1.244 cu. ft. By law its dimensions are those of a cylinder  $18\frac{1}{2}$  ins. diameter by 8 ins. high. A heaped bushel is equal to  $1\frac{1}{4}$  struck bushels the cone being 6 ins. high. A dry gallon contains 268.8 cu. ins. and is  $\frac{1}{2}$  of a struck bushel. One U. S. struck bushel may be taken as approximately  $1\frac{1}{4}$  cu. ft., or 1 cu. ft. as  $\frac{2}{3}$  of a bushel.

The British bushel contains 2218.19 cu. ins. or 1.2837 cu. ft. or 1.032 U. S. bushels.

## LIQUID MEASURE

4 gills	= 1 pint	31½ gallons	= 1 barrel
2 pints	= 1 quart	2 barrels or 63 gallons	=
4 quarts	= 1 gallon	1 hogshead	

One United States gallon contains 231 cu. ins. or .134 cu. ft., or 1 cu. ft. contains 7.481 gallons.

The British Imperial gallon both liquid and dry contains 277.27 cu. ins. or .160 cu. ft., and is equivalent to the volume of 10 lb. of pure water at 62° F. To convert British to U. S. liquid gallons multiply by 1.2. To convert U. S. into British divide by 1.2.

## METRIC SYSTEM

The fundamental unit of the metric system is the meter, the unit of length, which is one ten-millionth of the distance from the pole to the equator or 39,370.1 ins. From the meter the units of capacity (liter) and of weight (gram) are derived with subdivisions of 10 or multiples of 10, the following prefixes being used: milli =

$\frac{1}{1000}$ , centi =  $\frac{1}{100}$ , deci =  $\frac{1}{10}$ , deca = 10, hecto = 100, kilo =

1000, myrie = 10000. Thus a millimeter is  $\frac{1}{1000}$  of a meter, and

so on. The units of meter, liter and gram are simply related, as for all practical purposes 1 cubic decimeter = 1 liter and 1 liter of water weighs 1 kilogram at 4° C.

The metric system is specified by law in Argentina, Austria, Belgium, Bolivia, Brazil, Bulgaria, Chile, Colombia, Denmark, Finland, France, Germany, Holland, Hungary, Italy, Luxemburg, Mexico, Montenegro, Norway, Peru, Portugal, Roumania, Servia, Siam, Spain, Sweden, Turkey and Uruguay.

## LINEAR MEASURE

10 millimeters	= 1 centimeter	= .394 inches
10 centimeters	= 1 decimeter	= 3.937 inches
10 decimeters	= 1 meter	= 39.37 inches or 3.281 feet
10 meters	= 1 decameter	= 32.809 feet
10 decameters	= 1 hectometer	= 328.09 feet
10 hectometers	= 1 kilometer	= 3280.9 feet

## SURFACES

100 square millimeters	= 1 square centimeter	= .155 square inches
100 square centimeters	= 1 square decimeter	= 15.5 square inches
100 square decimeters	= 1 square meter	= 10.764 square feet

DECIMAL EQUIVALENTS OF FRACTIONS OF AN INCH, AND MILLI-METER-INCH CONVERSION TABLE

Fract.	Dec.	Mm.	Fract.	Dec.	Mm.	Mm.	Dec. Inch	Mm.	Dec. Inch
$\frac{1}{16}$	.015625	.397	$\frac{1}{16}$	.515625	13.1	1	.039379	51	2.007892
$\frac{1}{8}$	.03125	.79	$\frac{1}{8}$	.53125	13.49	2	.078740	52	2.047262
$\frac{3}{16}$	.046875	1.19	$\frac{3}{16}$	.546875	13.89	3	.118110	53	2.086632
$\frac{1}{4}$	.0625	1.59	$\frac{1}{4}$	.5625	14.29	4	.157480	54	2.126002
$\frac{5}{16}$	.078125	1.98	$\frac{5}{16}$	.578125	14.68	5	.196850	55	2.165372
$\frac{3}{8}$	.09375	2.38	$\frac{3}{8}$	.59375	15.08	6	.236220	56	2.204742
$\frac{7}{16}$	.109375	2.77	$\frac{7}{16}$	.609375	15.48	7	.275590	57	2.244112
$\frac{1}{2}$	.125	3.17	$\frac{1}{2}$	.625	15.87	8	.314960	58	2.283482
$\frac{9}{16}$	.140625	3.57	$\frac{9}{16}$	.640625	16.27	9	.354330	59	2.322852
$\frac{5}{8}$	.15625	3.97	$\frac{5}{8}$	.65625	16.7	10	.393704	60	2.362222
$\frac{11}{16}$	.171875	4.37	$\frac{11}{16}$	.671875	17.06	11	.433074	61	2.401596
$\frac{3}{4}$	.1875	4.76	$\frac{3}{4}$	.6875	17.46	12	.472444	62	2.440966
$\frac{13}{16}$	.203125	5.16	$\frac{13}{16}$	.703125	17.86	13	.511814	63	2.480336
$\frac{7}{8}$	.21875	5.56	$\frac{7}{8}$	.71875	18.26	14	.551184	64	2.519706
$\frac{15}{16}$	.234375	5.96	$\frac{15}{16}$	.734375	18.65	15	.590554	65	2.559076
$1$	.25	6.35	$1$	.75	19.05	16	.629924	66	2.598446
$\frac{17}{16}$	.265625	6.75	$\frac{17}{16}$	.765625	19.45	17	.669294	67	2.637816
$\frac{9}{8}$	.28125	7.14	$\frac{9}{8}$	.78125	19.84	18	.708664	68	2.677186
$\frac{19}{16}$	.296875	7.54	$\frac{19}{16}$	.796875	20.24	19	.748034	69	2.716556
$\frac{5}{4}$	.3125	7.94	$\frac{5}{4}$	.8125	20.64	20	.787409	70	2.755930
$\frac{21}{16}$	.328125	8.33	$\frac{21}{16}$	.828125	21.03	21	.826779	71	2.795300
$\frac{11}{8}$	.34375	8.73	$\frac{11}{8}$	.84375	21.43	22	.866149	72	2.834670
$\frac{23}{16}$	.359375	9.13	$\frac{23}{16}$	.859375	21.83	23	.905519	73	2.874040
$1\frac{1}{16}$	.375	9.52	$1\frac{1}{16}$	.875	22.22	24	.944889	74	2.913410
$\frac{25}{16}$	.390625	9.92	$\frac{25}{16}$	.890625	22.62	25	.984259	75	2.952780
$\frac{13}{8}$	.40625	10.32	$\frac{13}{8}$	.90625	23.02	26	1.023629	76	2.992150
$\frac{27}{16}$	.421875	10.72	$\frac{27}{16}$	.921875	23.41	27	1.062999	77	3.031520
$1\frac{1}{8}$	.4375	11.11	$1\frac{1}{8}$	.9375	23.81	28	1.102369	78	3.070890
$\frac{29}{16}$	.453125	11.51	$\frac{29}{16}$	.953125	24.21	29	1.141739	79	3.110260
$\frac{15}{8}$	.46875	11.91	$\frac{15}{8}$	.96875	24.61	30	1.181113	80	3.149635
$\frac{31}{16}$	.484375	12.30	$\frac{31}{16}$	.984375	25.	31	1.220483	81	3.189005
$1\frac{1}{4}$	.5	12.7	$1\frac{1}{4}$	1.	25.4001	32	1.259853	82	3.228375
						33	1.299223	83	3.267745
						34	1.338593	84	3.307115
						35	1.377963	85	3.346485
						36	1.417333	86	3.385855
						37	1.456703	87	3.425225
						38	1.496073	88	3.464595
						39	1.535443	89	3.503965
						40	1.574813	90	3.543335
						41	1.614183	91	3.582705
						42	1.653553	92	3.622075
						43	1.692923	93	3.661445
						44	1.732293	94	3.700815
						45	1.771663	95	3.740185
						46	1.811033	96	3.779555
						47	1.850403	97	3.818925
						48	1.889773	98	3.858295
						49	1.929143	99	3.897665
						50	1.968522	100	3.937035

## VOLUME AND CAPACITY

10 milliliters	= 1 centiliter	= .61 cubic inches
10 centiliters	= 1 deciliter	= 6.10 cubic inches
10 deciliters	= 1 liter	= 61.02 cubic inches
10 liters	= 1 decaliter	= .353 cubic feet
10 decaliters	= 1 hectoliter	= 3.53 cubic feet
10 hectoliters	= 1 kiloliter	= 35.31 cubic feet

A liter is equal to the volume occupied by 1 cubic decimeter of water at 4° C.

## WEIGHT

10 milligrams	= 1 centigram	= .154 grains
10 centigrams	= 1 decigram	= 1.54 grains
10 decigrams	= 1 gram	= 15.43 grains
10 grams	= 1 decagram	= 154.3 grains
10 decagrams	= 1 hectogram	= .220 pound avoirdupois
10 hectograms	= 1 kilogram	= 2.204 pound avoirdupois
1000 kilograms	= 1 metric ton	= 2204.621 pound avoirdupois

One gram is the weight of 1 cu. cm. of pure distilled water at a temperature of 39.2° F., or 4° C.; a kilogram is the weight of 1 liter (1 cubic decimeter) of water; a metric ton is the weight of 1 cubic meter of water.

## CENTIMETER, GRAM, SECOND, OR ABSOLUTE SYSTEM OF PHYSICAL MEASUREMENT

Unit of space or distance	= 1 centimeter
Unit of mass	= 1 gram
Unit of time	= 1 second
Unit of velocity	= $\frac{\text{space}}{\text{time}}$ = 1 centimeter in 1 second
Unit of acceleration	= change of 1 unit of velocity in 1 second

Acceleration due to gravity at Paris = 981 centimeters in 1 second.

Unit of force = 1 dyne =  $\frac{1}{981}$  gramme =  $\frac{.0022046}{981}$  lb. = .000002247 lb.

A dyne is that force which acting on a mass of one gram during one second will give it a velocity of one centimeter per second. The weight of one gram in latitude 40° to 45° is about 980 dynes, at the equator 973 dynes and at the poles 984 dynes. Taking the value of  $g$ , the acceleration due to gravity in British measures at 32.185 ft. per second at Paris, and the meter as 39.37 ins., then

$$1 \text{ gram} = \frac{32.185 \times 12}{3937} = 981 \text{ dynes.}$$

## METRIC CONVERSION TABLE

*Reading from Left to Right and Vice Versa*

Millimeters	×	.03937	=	Inches
Millimeters	=	25.400	×	Inches
Meters	×	3.2809	=	Feet
Meters	=	.3048	×	Feet
Kilometers	×	.621377	=	Miles
Kilometers	=	1.6093	×	Miles
Square centimeters	×	.15500	=	Square inches
Square centimeters	=	6.4515	×	Square inches
Square meters	×	10.76410	=	Square feet
Square meters	=	.09290	×	Square feet
Square kilometers	×	247.1098	=	Acres
Square kilometers	=	.00405	×	Acres
Hectares	×	2.471	=	Acres
Hectares	=	.4047	×	Acres
Cubic centimeters	×	.061025	=	Cubic inches
Cubic centimeters	=	16.3866	×	Cubic inches
Cubic meters	×	35.3156	=	Cubic feet
Cubic meters	=	.02832	×	Cubic feet
Cubic meters	×	1.308	=	Cubic yards
Cubic meters	=	.765	×	Cubic yards
Liters	×	61.023	=	Cubic inches
Liters	=	.01639	×	Cubic inches
Liters	×	.26418	=	U. S. Gallons
Liters	=	3.7854	×	U. S. Gallons
Grams	×	15.4324	=	Grains
Grams	=	.0648	×	Grains
Grams	×	.03527	=	Ounces avoirdupois
Grams	=	28.3495	×	Ounces avoirdupois
Kilograms	×	2.2046	=	Pounds
Kilograms	=	.4536	×	Pounds
Kilog's per sq. centim.	×	14.2231	=	Lbs. per sq. inch
Kilog's per sq. centim.	=	.0703	×	Lbs. per sq. inch
Kilog's per cu. meter	×	.06243	=	Lbs. per cu. ft.
Kilog's per cu. meter	=	16.01890	×	Lbs. per cu. ft.
Metric tons (1000 Kg.)	×	1.1023	=	Tons (2000 lb.)
Metric tons (1000 Kg.)	=	0.9072	×	Tons (2000 lb.)
Kilowatts	×	1.3405	=	Horse power
Kilowatts	=	.746	×	Horse power
Calories	×	3.9683	=	B. thermal units
Calories	=	.2520	×	B. thermal units

*Example.* 25.4 millimeters  $\times$  .03937 = 1 inch. 1 inch  $\times$  25.4 = 25.4 millimeters.

Unit of work = 1 erg = 1 dyne-centimeter = .00000007373 ft. lb.  
 Unit of power = 1 watt = 10,000,000 ergs per second  
 = .7373 ft. lb. per second  
 =  $\frac{.7373}{550}$  =  $\frac{1}{746}$  h. p. = .00134 h. p.

Centimeter, Gram, Second (CGS) unit of magnetism = the quantity which attracts or repels an equal quantity at a distance of one centimeter with a force of one dyne.

CGS unit of electric current = the current which, flowing through a length of one centimeter of wire, acts with a force of one dyne upon a unit of magnetism distant one centimeter from every point of the wire. The ampere, the commercial unit of current, is one-tenth of the CGS unit.

### BOARD MEASURE

To find the number of feet board measure in a stick of timber, multiply the length in feet, by the breadth in feet, by the thickness in inches.

*Example.* Find the board measure of a piece of timber 20 ft. long, 2 ft. wide by 2 ins. thick.

$$20 \text{ ft.} \times 2 \text{ ft.} \times 2 \text{ ins.} = 80 \text{ feet board measure.}$$

To convert board feet into cubic feet, divide the board feet by 12.

To convert board feet into tons, divide the board feet by 12, and multiply the quotient by the weight of the timber per cubic foot, thus giving the weight in pounds. Divide the weight in pounds by 2240 to get it into long or shipping tons, or by 2000 to get into short tons.

*Example.* A schooner has 1,000,000 feet board measure, of yellow pine on board. What is the weight of her load in shipping tons?

$$\frac{1,000,000}{12} = 83,333 \text{ cu. ft.} \quad \text{Yellow pine weighs 38 lb. per cu. ft.}$$

$$\frac{3,166,654 \text{ lb.}}{38} = 1415 \text{ tons nearly.}$$

### WATER

One cubic foot of fresh water weighs 62.42 lb. at its maximum density 39.1° F.

One cubic foot of salt water weighs 64 lb.

35.88 cubic feet of fresh water weighs one ton (2240 lb.)

35 cubic feet of salt water weighs one ton

One cubic foot of water (fresh or salt) = 7.48 gallons (U. S.)

One gallon (U. S.) of fresh water weighs 8.33 lb.

One gallon (U. S.) of salt water weighs 8.58 lb.

One cubic foot of ice (fresh) weighs 56 lbs., specific gravity .9.

## BOARD MEASURE

9

## FEET BOARD MEASURE IN DIFFERENT SIZES OF TIMBER\*

Size in Inches	Length in Feet											
	10	12	14	16	18	20	22	24	26	28	30	32
2 x 4	6½	8	9½	10½	12	13½	14½	16	17½	18½	20	21½
2 x 6	10	12	14	16	18	20	22	24	26	28	30	32
2 x 8	13½	16	18½	21½	24	26½	29½	32	34½	37½	40	42½
2 x 10	16½	20	23½	26½	30	33½	36½	40	43½	46½	50	53½
2 x 12	20	24	28	32	36	40	44	48	52	56	60	64
2 x 14	23½	28	32½	37½	42	46½	51½	56	60½	65½	70	74½
2 x 16	26½	32	37½	42½	48	53½	58½	64	69½	74½	80	85½
2½ x 12	25	30	35	40	45	50	55	60	65	70	75	80
2½ x 14	29½	35	40½	46½	52½	58½	64½	70	76½	81½	87½	93½
2½ x 16	33½	40	46½	53½	60	66½	73½	80	86½	93½	100	106½
3 x 6	15	18	21	24	27	30	33	36	39	42	45	48
3 x 8	20	24	28	32	36	40	44	48	52	56	60	64
3 x 10	25	30	35	40	45	50	55	60	65	70	75	80
3 x 12	30	36	42	48	54	60	66	72	78	84	90	96
3 x 14	35	42	49	56	63	70	77	84	91	98	105	112
3 x 16	40	48	56	64	72	80	88	96	104	112	120	128
4 x 4	13½	16	18½	21½	24	26½	29½	32	34½	37½	40	42½
4 x 6	20	24	28	32	36	40	44	48	52	56	60	64
4 x 8	26½	32	37½	42½	48	53½	58½	64	69½	74½	80	85½
4 x 10	33½	40	46½	53½	60	66½	73½	80	86½	93½	100	106½
4 x 12	40	48	56	64	72	80	88	96	104	112	120	128
4 x 14	46½	56	65½	74½	84	93½	102½	112	121½	130½	140	149½
6 x 6	30	36	42	48	54	60	66	72	78	84	90	96
6 x 8	40	48	56	64	72	80	88	96	104	112	120	128
6 x 10	50	60	70	80	90	100	110	120	130	140	150	160
6 x 12	60	72	84	96	108	120	132	144	156	168	180	192
6 x 14	70	84	98	112	126	140	154	168	182	196	210	224
6 x 16	80	96	112	128	144	160	176	192	208	224	240	256
8 x 8	53½	64	74½	85½	96	106½	117½	128	138½	149½	160	170½
8 x 10	66½	80	93½	106½	120	133½	146½	160	173½	186½	200	213½
8 x 12	80	96	112	128	144	160	176	192	208	224	240	256
8 x 14	93½	112	130½	149½	168	186½	205½	224	242½	261½	280	298½
10 x 10	83½	100	118½	133½	150	166½	183½	200	216½	233½	250	266½
10 x 12	100	120	140	160	180	200	220	240	260	280	300	320
10 x 14	116½	140	163½	186½	210	233½	256½	280	303½	326½	350	373½
10 x 16	133½	160	186½	213½	240	266½	293½	320	346½	373½	400	426½
12 x 12	120	144	168	192	216	240	264	288	312	336	360	384
12 x 14	140	168	196	224	252	280	308	336	364	392	420	448
12 x 16	160	192	224	256	288	320	352	384	416	448	480	512
14 x 14	163½	196	228½	261½	294	326½	359½	392	424½	457½	490	522½
14 x 16	186½	224	261½	298½	336	373½	410½	448	485½	522½	560	597½

Thus a stick of timber 2 ins. x 4 ins. x 12 ft. long contains 8 ft. board measure. Board measure is often abbreviated B. M.

\* From Mechanical Engineer's Handbook. W. Kent.



INCHES AND FRACTIONS IN DECIMALS OF A FOOT

Parts of Foot in Inches and Fractions	Decimal of a Foot	Parts of Foot in Inches and Fractions	Decimal of a Foot	Parts of Foot in Inches and Fractions	Decimal of a Foot	Parts of Foot in Inches and Fractions	Decimal of a Foot
1/16	.00520	3/16	.25520	6/16	.50520	9/16	.75520
1/8	.01040	3/8	.26040	6/8	.51040	9/8	.76040
1/4	.01562	3/4	.26562	6/4	.51562	9/4	.76562
1/2	.02080	3/2	.27080	6/2	.52080	9/2	.77080
3/4	.02600	3/4	.27600	6/4	.52600	9/4	.77600
5/8	.03125	3/4	.28125	6/4	.53125	9/4	.78125
11/16	.03640	3/4	.28650	6/4	.53640	9/4	.78650
1/2	.04170	3/4	.29170	6/4	.54170	9/4	.79170
5/8	.04687	3/4	.29687	6/4	.54687	9/4	.79687
3/4	.05210	3/4	.30210	6/4	.55210	9/4	.80210
7/8	.05730	3/4	.30730	6/4	.55730	9/4	.80730
15/16	.06250	3/4	.31250	6/4	.56250	9/4	.81250
1	.06770	3/4	.31770	6/4	.56770	9/4	.81770
1 1/16	.07290	3/4	.32290	6/4	.57290	9/4	.82290
1 1/8	.07812	3/4	.32812	6/4	.57812	9/4	.82812
1 1/4	.08333	4	.33333	7	.58330	10	.83333
1 1/8	.08850	4/8	.33850	7/8	.58850	10/8	.83850
1 1/8	.09375	4/8	.34375	7/8	.59375	10/8	.84375
1 1/4	.09900	4/8	.34900	7/8	.59900	10/8	.84900
1 1/4	.10420	4/8	.35420	7/8	.60420	10/8	.85420
1 1/4	.10937	4/8	.35937	7/8	.60937	10/8	.85937
1 1/4	.11460	4/8	.36460	7/8	.61460	10/8	.86460
1 1/4	.11980	4/8	.36980	7/8	.61980	10/8	.86980
1 1/4	.12500	4/8	.37500	7/8	.62500	10/8	.87500
1 1/4	.13020	4/8	.38020	7/8	.63020	10/8	.88020
1 1/4	.13540	4/8	.38540	7/8	.63540	10/8	.88540
1 1/4	.14062	4/8	.39062	7/8	.64062	10/8	.89062
1 1/4	.14580	4/8	.39580	7/8	.64580	10/8	.89580
1 1/4	.15100	4/8	.40100	7/8	.65100	10/8	.90100
1 1/4	.15625	4/8	.40625	7/8	.65625	10/8	.90625
1 1/4	.16150	4/8	.41140	7/8	.66150	10/8	.91150
2	.16670	5	.41670	8	.66670	11	.91670
2 1/16	.17187	5/16	.42187	8/16	.67187	11/16	.92187
2 1/8	.17710	5/8	.42710	8/8	.67710	11/8	.92710
2 1/4	.18230	5/4	.43230	8/4	.68230	11/4	.93230
2 1/4	.18750	5/4	.43750	8/4	.68750	11/4	.93750
2 1/4	.19270	5/4	.44270	8/4	.69270	11/4	.94270
2 1/4	.19790	5/4	.44790	8/4	.69790	11/4	.94790
2 1/4	.20312	5/4	.45312	8/4	.70312	11/4	.95312
2 1/4	.20830	5/4	.45830	8/4	.70830	11/4	.95830
2 1/4	.21350	5/4	.46350	8/4	.71350	11/4	.96350
2 1/4	.21875	5/4	.46875	8/4	.71875	11/4	.96875
2 1/4	.22400	5/4	.47400	8/4	.72400	11/4	.97400
2 1/4	.22920	5/4	.47920	8/4	.72920	11/4	.97920
2 1/4	.23437	5/4	.48437	8/4	.73437	11/4	.98437
2 1/4	.23950	5/4	.48950	8/4	.73950	11/4	.98950
2 1/4	.24480	5/4	.49480	8/4	.74480	11/4	.99480
3	.25000	6	.50000	9	.75000	12	1.00000

## FRESH WATER

One Imperial gallon	=	277.27	Cubic inches
One Imperial gallon	=	.16	Cubic feet
One Imperial gallon	=	10.00	Lb.
One Imperial gallon	=	4.54	Liters
One Imperial gallon	=	1.20	U. S. gallons
One U. S. gallon	=	231	Cubic inches
One U. S. gallon	=	.134	Cubic feet
One U. S. gallon	=	8.33	Lb.
One U. S. gallon	=	.83	Imperial gallons
One U. S. gallon	=	3.8	Liters
One pound of water	=	27.74	Cubic inches
One pound of water	=	.083	U. S. gallons
One pound of water	=	.10	Imperial gallons
One cwt. of water	=	11.2	Imperial gallons
One cwt. of water	=	13.44	U. S. gallons
One cwt. of water	=	1.79	Cubic feet
One ton of water	=	35.88	Cubic feet
One ton of water	=	223.60	Imperial gallons
One ton of water	=	268.38	U. S. gallons
One ton of water	=	1000	Liters (approx.)
One ton of water	=	1	Cubic meter (approx.)
One cubic inch of water	=	.036	Lb.
One cubic inch of water	=	.0036	Imperial gallons
One cubic inch of water	=	.0043	U. S. gallons
One cubic foot of water	=	.027	Ton
One cubic foot of water	=	.55	Cwt.
One cubic foot of water	=	62.42	Lb.
One cubic foot of water	=	6.23	Imperial gallons
One cubic foot of water	=	7.48	U. S. gallons
One cubic foot of water	=	28.31	Liters
One cubic foot of water	=	.028	Cubic meters
One liter of water	=	.22	Imperial gallons
One liter of water	=	.264	U. S. gallons
One liter of water	=	61	Cubic inches
One liter of water	=	.0354	Cubic feet
One cubic meter of water	=	220	Imperial gallons
One cubic meter of water	=	264	U. S. gallons
One cubic meter of water	=	1.308	Cubic yards
One cubic meter of water	=	35.31	Cubic feet
One cubic meter of water	=	61024	Cubic inches
One cubic meter of water	=	1000	Kilos
One cubic meter of water	=	1	Ton (approx.)
One cubic meter of water	=	1000	Liters
One Pood	=	3.6	Imperial gallons
One Eimer	=	2.7	Imperial gallons
One Vedros	=	2.7	Imperial gallons
One Miners' inch of water	=	10	Imperial gals. (approx.)
One column of water 1 foot high	=	.434	Lb. pressure per sq. in.
One column of water 1 meter high	=	1.43	Lb. pressure per sq. in.
A pressure of 1 lb. per square inch	=	2.31	Feet of water in height

In the above, one ton = 2,240 lb.

## WEIGHT AND SIZE OF DIFFERENT STANDARD GALLONS OF FRESH WATER

	Cubic Inches in a Gallon	Weight of a Gallon in Pounds	Gallons in a Cubic Foot	Weight of a cubic foot of fresh water, English standard, 62.321 lb. avoirdupois.
Imperial or English...	277.274	10.00	6.232102	
United States.....	231.	8.33111	7.480519	

## SALT WATER

The composition of salt water varies at different parts of the world, but usually contains the following to every 100 parts:

Pure water.....	96.2	Sulphate of lime.....	.08
Common salt.....	2.71	Sulphate of magnesium...	.12
Magnesium chloride.....	.54	Calcium bicarbonate.....	.01
Magnesium bromide.....	.01	Organic matter.....	.33

About 5 ounces of solid matter are present in one gallon of salt water, and this density can be expressed as a fraction thus

$$\frac{\text{solid matter}}{\text{water holding it in solution}} = \frac{5 \text{ oz.}}{1 \text{ gal.}} = \frac{5 \text{ oz.}}{16 \times 10} = \frac{1}{32}$$

that is, one part in 32 of sea water is solid matter, if an English gallon of 10 lb. is used. If an American of 1 gal. = 8.33 lb.,

$$\text{then } \frac{5 \text{ oz.}}{16 \times 8.33} = \frac{1}{26.7}$$

Salt water boils at a higher temperature than fresh owing to its greater density, as the boiling point of water is increased by any substance that enters into combination with it. The property water has of holding chemical substances, as salts of lime in solution, decreases as the temperature increases; from this follows that boilers carrying a high steam pressure form more scale than those working at lower temperatures and pressures.

Water is at its maximum density at 39.1° F. or 4° C. The boiling point of fresh water at sea level is 212° F. and of salt water 213.2. Fresh water freezes at 32° F. or 0° C.; salt water freezes at a lower temperature. In freezing, water expands. Thus as hot water cools down from the boiling point it contracts to 39.1°, its maximum density, while below this temperature it expands again.

The British and United States standard temperature for specific gravity is pure water at 62° F. Water has the greatest specific heat of any known substance except hydrogen, and is taken as the standard for all solids and liquids.

## SPECIFIC GRAVITIES AND WEIGHTS OF MATERIALS\*

Material	Specific Gravity <sup>1</sup>	Weight, lb. per cu. ft.
Alcohol, 100%.....	.79	49
Alum.....		107
Aluminum, bronze.....	7.7	478
Aluminum, cast.....	2.55-2.75	160
Aluminum, sheet.....		168
Anthracite coal (broken).....	1.4-1.7	47-58
Antimony.....	6.7	417
Asbestos.....	2.1-2.8	153
Ash, white-red.....	.62-.65	40
Asphaltum.....	1.1-1.5	81
Babbitt metal.....		456
Barley.....		38
Barytes.....	4.5	281
Basalt.....	2.7-3.2	184
Bauxite.....	2.55	159
Beech.....		44
Bell metal.....		503
Benzine.....	.73-.75	46
Birch.....		33
Bismuth.....	9.74	608
Bituminous coal (broken).....		49
Boxwood.....	.96	63
Brass, cast-rolled.....	8.4-8.7	534
Brick, common (1000 weigh about 3¼ tons).....	1.8-2.0	120
Bronze, 7.9 to 14% tin.....	7.4-8.9	509
Camphor.....		62
Cedar, white-red.....	.32-.38	22
Cement, Portland, loose.....		90
Chalk.....	1.8-2.6	137
Charcoal (piled).....		10-14
Cherry.....	.70	42
Chestnut.....	.66	41
Clay, dry.....		63
Clay, moist.....		110
Coal—see anthracite and bituminous.		
Coke.....		23-32
Concrete, cement—stone—sand.....	2.2-2.4	144
Copper, cast, rolled.....	8.8-9.0	556
Copper ore, pyrites.....	4.1-4.3	262
Cork.....	.25	15.6
Corn.....		48
Cotton, pressed.....	1.47-1.50	93
Cypress.....	.48	30
Dolomite.....	2.9	181
Earth, dry loose.....		76
Earth, packed and moist.....		96
Ebony.....	1.25	79
Elm.....	.72	45

<sup>1</sup> The specific gravities of solids and liquids refer to water at 4° C. The weights per cubic foot are derived from average specific gravities.

\* From Pocket Computation. Carnegie Steel Co.

**SPECIFIC GRAVITIES AND WEIGHTS OF MATERIALS—Continued**

Material	Specific Gravity	Weight, lb. per cu. ft.
Emery.....		251
Felspar.....	2.5-2.6	159
Fir, Douglas (Oregon pine).....	.51	32
Flagging.....		168
Flax.....	1.47-1.50	93
Flour, loose.....	.4-.5	28
Flour, pressed.....	.7-.8	47
Flint.....		164
Gasoline.....	.66-.69	42
Glass, common.....	2.4-2.6	156
Glass, plate or crown.....	2.45-2.72	161
Gold, cast, hammered.....	19.25	1205
Gneiss, serpentine.....	2.4	159
Granite.....	2.5	175
Graphite.....	1.9-2.3	131
Greenheart.....		62.5
Gypsum.....	2.3	159
Hay and straw bales.....		20
Hemlock.....	.42-.52	29
Hickory.....	.74-.84	49
Hornblende.....	3.	187
Ice.....	.88-.92	56
India rubber.....		58
Iron, cast, pig.....	7.2	450
Iron, wrought.....	7.6-7.9	485
Ivory.....		114
Kerosene.....	.66	42
Lancewood.....		42
Lead.....	11.37	710
Lead, ore, galena.....	7.3	465
Leather.....	.86-1.02	59
Lignum vitæ.....	1.10	83
Lime, quick, loose.....		53-60
Limestone.....	2.5	165
Linseed oil.....		58
Locust.....	.73	46
Manganese.....	7.2-8.0	475
Manganese ore.....	3.7	259
Mahogany, Honduras.....		35
Mahogany, Spanish.....		53
Maple.....	.65	49
Marble.....		170
Mercury.....	13.6	849
Mica.....		183
Muntz metal.....		511
Nickel.....	8.9-9.2	565
Nitric acid 91%.....	1.5	94
Oak, live.....	.95	59

**SPECIFIC GRAVITIES AND WEIGHTS OF MATERIALS—Continued**

Material	Specific Gravity	Weight, lb. per cu. ft.
Oak, red, black	.65	41
Oats, bulk		32
Oil—see gasoline, petroleum, etc.		
Olive oil		57
Oregon pine	.51	32
Paper	.70	58
Petroleum, crude	.87	54
Petroleum, refined	.79	50
Phosphate rock	3.2	200
Phosphor bronze		537
Pine—long leaf yellow	.70	44
Pine—short leaf yellow	.6	38
Pine—white	.41	26
Pitch	1.07	69
Platinum, cast, hammered	21.1	1330
Plumbago		140
Poplar	.48	30
Potatoes, piled		42
Quartz, flint	2.5	165
Rubber, caoutchouc	.92	59
Rubber goods	1.-2.	94
Rye		48
Salt, granulated, piled		48
Salt peter		67
Sand, dry, loose		90-105
Sand, wet		120
Sandstone	2.2	147
Shale, slate, piled		92
Silver, cast, hammered	10.4	656
Soapstone, talc	2.6	169
Spruce, white, black	.4	27
Starch	1.53	96
Steel, cast		493
Steel, structural	7.8	490
Sulphur	1.93	125
Talc	2.6	169
Tallow		59
Tar, bituminous		75
Teak	.82	52
Tin, cast, hammered	7.2	459
Tin ore	6.4-7.0	418
Walnut, black	.61	38
Water, fresh	1.	62.5
Water, salt	1.02	64
Wheat		48
White metal, Babbitt		456
Wool, pressed	1.32	82
Zinc, cast, rolled	6.9	440
Zinc ore, blende	3.9	253

CUBIC FEET PER TON (2240 LB.) OF DIFFERENT MATERIALS\*

Material	Cu. ft. per ton	Material	Cu. ft. per ton
Alcohol in casks.....	80	Cider in casks.....	65
Almonds in bags.....	70	Cigars in cases.....	180
Almonds in hogsheads..	108	Cinchona (Peruvian bark)	140
Aniseed in bags.....	120	Cloth goods in cases....	87
Apples in boxes.....	90	Cloves in cases.....	50
Arrowroot in bags.....	52	Coal (Admiralty).....	48
Arrowroot in boxes.....	70	Coal (American).....	43
Arrowroot in cases.....	50	Coal (Newcastle).....	45
Asbestos in cases.....	53	Coal (Welsh).....	40
Asphalt.....	17	Cocoa in bags.....	80
Bacon in cases.....	65	Cocoanuts in bulk.....	140
Bananas.....	90	Coffee in bags.....	61
Barley in bags.....	59	Coir yarn in bales.....	190
Barley in bulk.....	47	Coke.....	80
Beans, haricot, in bags..	68	Copper, cast.....	10
Beans in bulk.....	47	Copper ore.....	10-20
Beef, frozen, packed....	93	Copper sulphate in casks	50
Beef hung in quarters...	125	Copperas in casks.....	52
Beer, bottled, in cases..	80	Copra in cases.....	85
Beer in hogsheads.....	54	Cork wood in bales.....	270
Beeswax.....	74	Cotton—a bale of U. S.	
Bone meal.....	45	cotton is 54 ins. by 27 by	
Bones, crushed.....	60	24 to 30 ins. high de-	
Bones, loose.....	85	pending on the com-	
Books.....	50	pression, assuming 30	
Borate of lime.....	50	ins. space occupied is	
Borax in cases.....	52	25.3 cu. ft. Average	
Bottles, empty, in crates	85	stowage per ton.....	114
Bran compressed in bales	80	Cotton waste.....	170
Bran in bags.....	110	Cowrie shells in bags...	75
Brandy, bottled, in cases	55	Creosote in casks.....	60
Brandy in casks.....	80	Dates.....	43
Bread in bulk.....	124	Earth, loose.....	25
Bread in cases.....	155	Earthenware in crates...	47
Bricks.....	22	Fish in boxes.....	95
Buckwheat in bags.....	65	Fish, frozen.....	60
Butter in kegs or cases..	70	Flax.....	105
Camphor in cases.....	50	Flour in bags.....	47
Candles in boxes.....	56	Flour in barrels.....	60
Canvas in bales.....	43	Freestone.....	16
Carpets in rolls.....	80	Fuel oil.....	39-40
Cassia in cases.....	184	Furs in cases.....	130
Cellulose.....	240	Ginger.....	80
Cement in barrels.....	40	Glass bottles.....	85
Chalk in barrels.....	38	Glassware in crates....	180
Cheese.....	70	Granite blocks.....	16
Chicory in sacks.....	60	Gravel, coarse.....	23
Chloride of lime in casks	80	Grease.....	65

\* From The Naval Constructor. G. Simpson.

CUBIC FEET PER TON (2240 LB.) OF DIFFERENT MATERIALS—Cont.

Material	Cu. ft. per ton	Material	Cu. ft. per ton
Guano.....	42	Nails, kegs.....	21
Gum.....	50	Nitrate of soda.....	32
Gunny bags.....	50	Nuts, Brazil, in barrels.....	90
Gunpowder.....	48	Nuts, pistachio, in cases.....	70
Hair, pressed.....	160	Oatmeal in sacks.....	65
Ham in barrels.....	70	Oats in bags.....	78
Hay, compressed.....	120	Oats in bulk.....	61
Hay, uncompressed.....	140	Oil, lubricating, in bbls.....	60
Hemp in bales.....	100	Oil in drums.....	49
Hemp seed in bags.....	70	Oil in bottles in cases.....	75
Herrings in barrels.....	60	Oil cake in bags.....	50
Herrings in boxes.....	85	Olives in barrels.....	67
Hides in bales.....	120	Onions in boxes.....	77
Hides in barrels.....	50	Oranges in boxes.....	90
Hops in bales.....	260	Oysters in barrels.....	60
Ice.....	39	Paint in drums.....	16
India rubber, crude.....	72	Paper in rolls.....	120
Indigo in cases.....	67	Peas in bags.....	50
Iron, corrugated sheets.....	36	Phosphate of lime.....	42
Iron, pig.....	10	Pineapples, canned, and in boxes.....	60
Ivory.....	28	Pitch in barrels.....	45
Jute.....	58	Potatoes in bags.....	55
Kaolin (China clay) in bags.....	40	Potatoes in barrels.....	68
Lard.....	70	Prunes in casks.....	52
Lead, pig.....	8	Raisins.....	52
Lead pipes, random sizes about.....	12	Rape seed.....	60
Leather in bales.....	90	Rice in bags.....	48
Leather in rolls.....	220	Rice meal.....	62
Lemons.....	85	Rope.....	135
Linseed in bags.....	57	Rum in bottles and cases.....	66
Locust beams in bulk.....	84	Rum in hogsheads.....	70
Logwood.....	92	Rye in bags.....	53
Manure—phosphate.....	45	Sago.....	55
Maize in bags.....	51	Salt in bulk.....	37
Maize in bulk.....	49	Salt in barrels.....	52
Marble in slabs.....	17	Salt peter.....	36
Margarine in tubs.....	69	Sand, fine.....	19
Marl.....	28	Sand, coarse.....	20
Matches.....	120	Sandstone.....	14
Melons.....	80	Shellac.....	83
Milk, condensed, in cases.....	45	Silk in bales.....	125
Millet in bags.....	50	Silk in cases.....	112
Mineral water in cases.....	70	Slate.....	13
Molasses in bulk.....	25	Soap in boxes.....	46
Molasses in puncheons.....	65	Soda in bags.....	57
Mutton.....	110	Soda in casks.....	54
		Sponge.....	152



CUBIC FEET PER TON (2240 LB.) OF DIFFERENT MATERIALS—Cont.

Material	Cu. ft. per ton	Material	Cu. ft. per ton
Starch in cases.....	100	Ties, steel.....	38
Stone, paving.....	50	Tiles, roofing, in crates..	85
Stone, limestone.....	80	Tobacco, Brazilian, in bales.....	40
Sugar in bags.....	15	Tobacco, Turkish, in small bales.....	150
Sugar in hogsheads.....	13	Turmeric.....	80
Sulphur in bulk.....	40	Turpentine in barrels.....	60
Sulphur in cases.....	54	Vermic. li.....	110
Sulphur in kegs.....	60	Water, fresh.....	36
Sumac in bags.....	27	Water, salt.....	35
Syrup.....	40	Wheat in bags.....	52
Tallow in barrels and tierces.....	60	Wheat in bulk.....	48
Tallow in hogsheads.....	70	Whitening in casks.....	39
Tamarinds in cases.....	34	Woods, sawn into planks	
Tamarinds in casks or kegs.....	58	Ash.....	39
Tan extract.....	70	Beech.....	51
Tapioca.....	45	Elm.....	60
Tar in barrels.....	54	Fir.....	65
Tea, China, in chests.....	48	Greenheart.....	34
Tea, Indian, in cases.....	57	Mahogany.....	34
Ties, oak.....	54	Wool in sheets.....	260
	100	Wool in bales, pressed..	100

SHIPPING WEIGHTS OF AMERICAN LUMBER  
(Rough Lumber in lb. per 1,000 ft. board measure)

Ash, black.....	3,200	Gum, sap.....	3,000
Ash, white.....	3,500	Hemlock.....	3,000
Basswood.....	2,500	Hickory.....	4,500
Beech.....	4,000	Longleaf pine.....	3,000
Birch.....	4,000	Mahogany.....	3,500
Butternut.....	2,500	Maple, soft.....	3,000
Cherry.....	3,800	Maple, hard.....	3,900
Chestnut.....	2,800	Oak.....	3,900
Cottonwood.....	2,800	Poplar, yellow.....	2,800
Douglas fir.....	3,300	Shortleaf pine.....	4,200
Elm, rock.....	3,800	Sycamore.....	3,000
Elm, soft.....	3,000	Tupelo.....	2,800
Gum, red.....	3,300	Walnut.....	4,000

Weight of Green Logs per 1,000 ft. board measure

Yellow pine (Southern).....	8,000 to 10,000 lb.
Norway pine (Michigan).....	7,000 to 8,000 lb.
Hemlock (Pennsylvania), bark off.....	6,000 to 7,000 lb.

## WEIGHTS OF MISCELLANEOUS UNITS OF DIFFERENT PRODUCTS

	Lb.
Keg of nails.....	100
Firkin of butter.....	56
Chest of tea.....	68
Barrel of flour, etc.—See Sizes of Barrels.	
Bushel of oysters.....	80
Bushel of clams.....	100
Bushel of barley.....	48
Bushel of beans.....	60
Bushel of buckwheat.....	48
Bushel of charcoal.....	30
Bushel of castor beans.....	50
Bushel of clover seed.....	60
Bushel of corn (shelled).....	56
Bushel of corn (on cob).....	70
Bushel of malt.....	34
Bushel of onions.....	57
Bushel of oats.....	32
Bushel of potatoes.....	60
Bushel of rye.....	56
Bushel of Timothy seed.....	45
Bushel of wheat.....	60
Quarter or 8 bushels of wheat.....	480
Gallon of molasses.....	12
Bale of United States cotton weighs.....	500
Bale of Peruvian cotton weighs.....	200
Bale of Brazilian cotton weighs.....	250
Bale of East Indian cotton weighs.....	400
Bale of Egyptian cotton weighs.....	750
Bale of jute weighs.....	440

One bushel of wheat = 60 lb. = 1.244 cu. ft.

Eight bushels of wheat = one quarter = 9.952 cu. ft. = 480 lb.

One ton of wheat =  $4\frac{3}{4}$  quarters = 46.43 cu. ft. = 2240 lb.

A case of kerosene oil generally contains two 5-gallon cans or ten 1-gallon, in the former taking up 2 cu. ft. and in the latter 2.1. Some hold fifteen 1-gallon cans and take up 3.2 cu. ft.

Gallon of honey.....	12
Gallon of crude oil about.....	$8\frac{1}{2}$
7 bags of sugar (one ton).....	2240
11 bags of potatoes (one ton).....	2240
One bag of flour.....	140
Cord of dry hickory.....	4369
Cord of dry maple.....	2862

Linoleum  $\frac{1}{4}$  of an inch thick, including cement, weighs 1.5 lb. per sq. ft.

Rubber tiling,  $\frac{1}{8}$  of an inch thick, weighs 2 lb. per sq. ft.

White tiling,  $\frac{1}{4}$  of an inch thick, weighs 6 lb. per sq. ft.

BUNDLING SCHEDULE FOR BUTTWELD PIPE<sup>1</sup>

This schedule applies to butt-weld wrought iron pipe only.

*Standard Weight Pipe*

Size	No. of Pieces per Bundle	Approx. No. of Feet per Bundle	Approx. Weight of Bundle in Lb.
$\frac{1}{8}$ .....	42 (Approx.)	500	120
$\frac{1}{4}$ .....	24	450	190
$\frac{3}{8}$ .....	18	340	190
$\frac{1}{2}$ .....	12	245	210
$\frac{3}{4}$ .....	7	140	160
1.....	5	100	168
$1\frac{1}{4}$ .....	3	60	138
$1\frac{1}{2}$ .....	3	58	158

*Extra Strong Pipe*

$\frac{1}{8}$ .....	42	500	157
$\frac{1}{4}$ .....	24	450	241
$\frac{3}{8}$ .....	18	330	244
$\frac{1}{2}$ .....	12	245	266
$\frac{3}{4}$ .....	7	140	206
1.....	5	100	217
$1\frac{1}{4}$ .....	3	60	180
$1\frac{1}{2}$ .....	3	58	211

*Double Extra Strong Pipe*

$\frac{1}{2}$ .....	7	126	215
$\frac{3}{4}$ .....	5	95	230
1.....	3	60	220
$1\frac{1}{4}$ .....	3	60	310
$1\frac{1}{2}$ .....	3	60	380

<sup>1</sup> Adopted on June 1st, 1915, at the suggestion of the National Pipe and Supplies Association.

## BARRELS

There is no standard size of barrel universally adopted either by Great Britain or the United States. In Great Britain an old wine barrel =  $26\frac{1}{4}$  imperial gallons, an ale barrel =  $31\frac{1}{2}$  imperial gallons and a beer barrel =  $36\frac{1}{2}$  imperial gallons. A French barrique of Bordeaux = 228 liters = 50 imperial gallons. Four barriques = 1 tonneau.

A barrel for fruit, vegetables and other dry commodities as fixed by a United States statute approved March 4, 1914, specifies staves  $28\frac{1}{2}$  ins. long, heads  $17\frac{1}{8}$  ins. dia., distance between heads 26 ins., circumference 64 ins., all outside measurements, representing as nearly as possible 7050 cu. ins. or 4.08 cu. ft., equivalent to 105 dry quarts. Besides the above the different states specify the dimensions of barrels for various commodities. The usual barrel for liquids contains  $31\frac{1}{2}$  U. S. wine gallons of 231 cu. ins. Below is a table of wood barrels.

Material Held	Diameter Top and Bottom (ins.)	Diameter at Bilge (ins.)	Height (ins.)	Cubic Feet
Sugar.....	$19\frac{1}{8}$	$21\frac{1}{2}$	30	5.60
Flour.....	$17\frac{1}{8}$	$19\frac{1}{2}$	$28\frac{1}{2}$	4.36
Oil.....	$21\frac{1}{2}$	$25\frac{3}{4}$	33	8.37
				52 gals.
Fish.....	20	$22\frac{1}{2}$	30	6.23
Meat.....	$21\frac{1}{2}$	$25\frac{3}{4}$	33	8.37
Molasses.....	$22\frac{1}{2}$	$27\frac{1}{2}$	35	10.04
				60 gals.
Salt.....	$18\frac{1}{2}$	21	30	5.34
Cement.....	16	18	$28\frac{1}{2}$	3.75
Lime.....	16	18	$28\frac{1}{2}$	3.75
Apple.....	$17\frac{1}{8}$	19	$28\frac{1}{2}$	4.33
Potato.....	15	$16\frac{1}{2}$	$28\frac{1}{2}$	3.22
Tar.....	$19\frac{1}{8}$	$21\frac{1}{2}$	30	5.60

All dimensions are outside. The above barrels are of wood, data from G. A. Riley, Cleveland, O.

An oil company (Platt & Washburn Ref'g Co., New York) gave the following figures on the sizes of their wood barrels and steel drums:

Material	Diam. Top and Bottom (ins.)	Diam. at Bilge (ins.)	Length (ins.)	Capacity (gals.)	Wt. with Oil About (lb.)	Tare (lb.)
Wood.....	21	26	$33\frac{1}{2}$	50	450	73
Wood half barrel....	17	22	27	28	205	45
Drum (steel).....	22	26	34	50	450	50
Half-drum.....	17	22	27	28	213	24

## HORSE POWERS

**Horse Power (h. p.)**, the unit of power equivalent to raising a weight of 33,000 lb. one foot in one minute.

One horse power	}	2.64	lb. of water evaporated per hour from and at 212° F.
		746	watts
		.746	kw.
		33,000	ft. lb. per minute
		550	ft. lb. per second
		2,545	heat units per hour
		42.4	heat units per minute

**Indicated Horse Power (i. h. p.)** is the power as measured by an indicator and calculated by the following formula:

$P$  = mean effective pressure in pounds per sq. in. on the piston as obtained from the indicator card

$L$  = length of stroke in ft.

$A$  = area of piston in sq. ins.

$N$  = number of single strokes per minute or two times the number of revolutions

$$\text{Then indicated horse power (i. h. p.)} = \frac{P L A N}{33,000}$$

**Brake Horse Power (b. h. p.)** is the actual horse power of an engine as measured at the flywheel by a friction brake or dynamometer. It is the indicated horse power minus the friction of the engine.

**Boiler Horse Power.**—See Boilers.

**Nominal Horse Power (n. h. p.)**.—Lloyd's formulæ are as follows:

$D$  = diameter of l. p. cylinder in ins.

$s$  = stroke in ins.

$H$  = heating surface in sq. ft.

$P$  = working pressure in pounds per sq. in.

$N$  = number of cylinders

(1) Where the boiler pressure and heating surface are known

$$\begin{aligned} \text{N. h. p.} &= \frac{P + 340}{1000} \left( \frac{D^2 \sqrt{s}}{100} + \frac{H}{15} \right) \text{ where boiler pressure is below 160 lb.} \\ &= \frac{P + 590}{1500} \left( \frac{D^2 \sqrt{s}}{100} + \frac{H}{15} \right) \text{ where boiler pressure is above 160 lb.} \end{aligned}$$

If boilers are fitted with forced or induced draft then  $H/12$  is substituted for  $H/15$ .

## EQUIVALENT VALUES OF MECHANICAL AND ELECTRICAL UNITS

Unit	Equivalent Value in Other Units	Unit	Equivalent Value in Other Units
Horse-power = (h. p.)	33,000 ft.-lb. per minute 550 ft.-lb. per second 746 watts .746 kw. 2,545 heat units (B.t.u.) per hour 42.4 heat units per minute 2.64 lb. water evap. per hour from and at 212° F.	1 Joule = (J)	1 watt second .00134 h. p. second .00000278 kw. hour .000954 heat units, .7372 ft.-lb.
		1 Foot-pound = (ft.-lb.)	1.356 joules .0000005 h. p. hour .00000377 kw. hour .001285 heat units .1363 kilogram-meter
1 Kilo-watt = (kw.)	1,000 watts 2,654,200 ft.-lb. per hour 44,232 ft.-lb. per minute 737.2 ft.-lb. per second 1.34 h. p. 3,412 heat units per hour 56.9 heat units per minute 3.53 lb. water evap. per hour from and at 212° F.	1 lb. water evaporated from and at 212° F. =	.379 h.p. hour .283 kw. hour 751,300 ft.-lb. 967. heat units 1,019,000 joules 103,900 kilogram-meters
			1 Kilogram meter = (kgm.)
1 British Heat Unit = (B.t.u.)	778 ft.-lb. .000393 h. p. hour .000293 kw. hour 1048. watt seconds .001036 lb. water evap. from and at 212° F.		

(2) If boiler pressure and heating surface are not known

$$N. h. p. = \frac{D^2 \sqrt{s}}{130} \text{ for simple engines}$$

$$= \frac{D^2 \sqrt{s}}{120} \text{ for compound engines}$$

$$= \frac{D^2 \sqrt{s}}{100} \text{ for triple and quadruple engines}$$

(3) In vessels with Diesel engines

$$N. h. p. = \frac{N \times D^2 \sqrt{s}}{80} \text{ for single acting 4-cycle engines}$$

$$= \frac{N \times D^2 \sqrt{s}}{40} \text{ for single acting 2-cycle engines}$$

$$= \frac{N \times D^2 \sqrt{s}}{20} \text{ for double acting 2-cycle engines}$$

Shaft Horse Power (s. h. p.) is the power delivered by the engine or turbine to the shafting. See Turbines.

**Effective Horse Power (e. h. p.)** See Powering Vessels.

**Thrust Horse Power (t. h. p.)** is the power delivered by the propeller for the propulsion of the ship. Owing to the friction of the working parts of the engine and shafting, the horse power transmitted to the propeller is about  $\frac{1}{2}$  of the indicated. Horse power used by the propeller =  $\frac{\text{thrust in lb.} \times \text{dist. ship travels in ft. in 1 min.}}{33000}$

Thrust in lb. =  $\frac{33000 \times \text{h. p. used by the propeller}}{\text{dist. ship travels in ft. in 1 min.}}$

### COMPARISON OF THERMOMETER SCALES

Cent.	Reau.	Fahr.	Cent.	Reau.	Fahr.	Cent.	Reau.	Fahr.
-40	-32.0	-40.0	21	16.8	69.8	62	49.6	143.6
-38	-30.4	-36.4	22	17.6	71.6	63	50.4	145.4
-36	-28.8	-32.8	23	18.4	73.4	64	51.2	147.2
-34	-27.2	-29.2	24	19.2	75.2	65	52.0	149.0
-32	-25.6	-25.6	25	20.0	77.0	66	52.8	150.8
-30	-24.0	-22.0	26	20.8	78.8	67	53.6	152.6
-28	-22.4	-18.4	27	21.6	80.6	68	54.4	154.4
-26	-20.8	-14.8	28	22.4	82.4	69	55.2	156.2
-24	-19.2	-11.2	29	23.2	84.2	70	56.0	158.0
-22	-17.6	-7.6	30	24.0	86.0	71	56.8	159.8
-20	-16.0	-4.0	31	24.8	87.8	72	57.6	161.6
-18	-14.4	-0.4	32	25.6	89.6	73	58.4	163.4
-16	-12.8	+ 3.2	33	26.4	91.4	74	59.2	165.2
-14	-11.2	6.8	34	27.2	93.2	75	60.0	167.0
-12	-9.6	10.4	35	28.0	95.0	76	60.8	168.8
-10	-8.0	14.0	36	28.8	96.8	77	61.6	170.6
-8	-6.4	17.6	37	29.6	98.6	78	62.4	172.4
-6	-4.8	21.2	38	30.4	100.4	79	63.2	174.2
-4	-3.2	24.8	39	31.2	102.2	80	64.0	176.0
-2	-1.6	28.4	40	32.0	104.0	81	64.8	177.8
0	0.0	32.0	41	32.8	105.8	82	65.6	179.6
+ 1	+0.8	33.8	42	33.6	107.6	83	66.4	181.4
2	1.6	35.6	43	34.4	109.4	84	67.2	183.2
3	2.4	37.4	44	35.2	111.2	85	68.0	185.0
4	3.2	39.2	45	36.0	113.0	86	68.8	186.8
5	4.0	41.0	46	36.8	114.8	87	69.6	188.6
6	4.8	42.8	47	37.6	116.6	88	70.4	190.4
7	5.6	44.6	48	38.4	118.4	89	71.2	192.2
8	6.4	46.4	49	39.2	120.2	90	72.0	194.0
9	7.2	48.2	50	40.0	122.0	91	72.8	195.8
10	8.0	50.0	51	40.8	123.8	92	73.6	197.6
11	8.8	51.8	52	41.6	125.6	93	74.4	199.4
12	9.6	53.6	53	42.4	127.4	94	75.2	201.2
13	10.4	55.4	54	43.2	129.2	95	76.0	203.0
14	11.2	57.2	55	44.0	131.0	96	76.8	204.8
15	12.0	59.0	56	44.8	132.8	97	77.6	206.6
16	12.8	60.8	57	45.6	134.6	98	78.4	208.4
17	13.6	62.6	58	46.4	136.4	99	79.2	210.2
18	14.4	64.4	59	47.2	138.2	100	80.0	212.0
19	15.2	66.2	60	48.0	140.0	..	....	....
20	16.0	68.0	61	48.8	141.8	..	....	....

## THERMOMETERS

Fahrenheit (F.) thermometer is used in the United States and in Great Britain. The freezing point of water is marked 32 and the boiling at sea level 212, the distance between these points is divided into 180 parts or degrees. 32 parts are marked off from the freezing point downwards, and the last one marked 0 or zero.

Centigrade (C.) is used extensively in Europe and in scientific calculations. The freezing point of water is marked 0, and the boiling point at sea level 100, and the distance between is divided into 100 parts or degrees.

To convert Fahrenheit readings into Centigrade, subtract 32 and multiply by  $\frac{5}{9}$ . To convert Centigrade into Fahrenheit multiply by  $\frac{9}{5}$  and add 32.

Reaumur (R.) is used in Russia. The freezing point of water is taken as 0, and the boiling point 80. To convert Fahrenheit readings into Reaumur subtract 32 and multiply by  $\frac{4}{9}$ .

To convert Reaumur into Fahrenheit multiply by  $\frac{9}{4}$  and add 32.

If the temperature be below freezing, "add 32" in the formula becomes "subtract from 32" and "subtract 32" becomes "subtract from 32." See table on page 24.

## CIRCUMFERENCES AND AREAS OF CIRCLE ADVANCING BY EIGHTHS

Diameter	Circum.	Area	Diameter	Circum.	Area
$\frac{1}{8}$	.3927	.0123	$3\frac{1}{8}$	9.817	7.669
$\frac{1}{4}$	.7854	.0491	$\frac{1}{4}$	10.210	8.295
$\frac{3}{8}$	1.178	.110	$\frac{3}{8}$	10.603	8.946
$\frac{1}{2}$	1.570	.196	$\frac{1}{2}$	10.996	9.621
$\frac{5}{8}$	1.963	.306	$\frac{5}{8}$	11.388	10.321
$\frac{3}{4}$	2.356	.441	$\frac{3}{4}$	11.781	11.045
$\frac{7}{8}$	2.741	.601	$\frac{7}{8}$	12.174	11.793
1	3.141	.785	4	12.568	12.566
$\frac{1}{8}$	3.534	.994	$\frac{1}{8}$	12.959	13.364
$\frac{1}{4}$	3.927	1.227	$\frac{1}{4}$	13.352	14.186
$\frac{3}{8}$	4.319	1.485	$\frac{3}{8}$	13.744	15.033
$\frac{1}{2}$	4.712	1.767	$\frac{1}{2}$	14.137	15.904
$\frac{5}{8}$	5.105	2.074	$\frac{5}{8}$	14.530	16.800
$\frac{3}{4}$	5.497	2.405	$\frac{3}{4}$	14.923	17.728
$\frac{7}{8}$	5.890	2.761	$\frac{7}{8}$	15.315	18.685
2	6.283	3.141	5	15.708	19.635
$\frac{1}{8}$	6.675	3.546	$\frac{1}{8}$	16.101	20.629
$\frac{1}{4}$	7.068	3.976	$\frac{1}{4}$	16.493	21.648
$\frac{3}{8}$	7.461	4.430	$\frac{3}{8}$	16.886	22.691
$\frac{1}{2}$	7.854	4.908	$\frac{1}{2}$	17.279	23.758
$\frac{5}{8}$	8.246	5.411	$\frac{5}{8}$	17.671	24.850
$\frac{3}{4}$	8.639	5.939	$\frac{3}{4}$	18.064	25.967
$\frac{7}{8}$	9.032	6.491	$\frac{7}{8}$	18.457	27.109
3	9.424	7.068	6	18.850	28.274



## MATHEMATICAL TABLES

## INVOLUTION AND EVOLUTION

The quantity represented by the letter  $a$  multiplied by a quantity represented by the letter  $b$ , is expressed  $a \times b$  or  $ab$ .

Quantities in brackets thus  $(a + b)(a + b)$  signify they are to be multiplied together.

To square a number multiply the number by itself. Thus the square of 4 (often written  $4^2$ ) is  $4 \times 4 = 16$ .

To cube a number multiply the square by the number. Thus cube of 4 (written  $4^3$ ) =  $4 \times 4 \times 4 = 16 \times 4 = 64$ .

To find the fourth power of a number, multiply the cube by the number. Fourth power of 4 =  $64 \times 4 = 256$ .

The  $n$ th power of a number as  $a^n$  is obtained by multiplying the logarithm of the number by  $n$  and then finding the number corresponding to the logarithm. Thus  $5^{1.8} = \log. \text{ of } 5 \times 1.8$ , and from the table of logarithms find the number corresponding to this logarithm.

$\sqrt{\quad}$  is the radical sign and either with or without the index figure 2 as  $\sqrt{\quad}$  indicates that the square root of the quantity under it is to be taken. Thus the  $\sqrt{4}$  is 2.  $\sqrt[3]{\quad}$  indicates the cube root is to be taken as  $\sqrt[3]{8}$  is 2.  $\sqrt[4]{\quad}$  that the fourth root as  $\sqrt[4]{256}$  is 4. The fourth root is the square root of the square root, and the sixth root is the cube root of the square root.

Any root of a number as  $\sqrt[n]{a}$  may be obtained by taking the logarithm of the number  $a$  and dividing it by the index  $n$  and from the table of logarithms finding the corresponding number.

**To Extract the Square Root of a Number.**—Point off the given number into periods of two places each beginning with units. If there are decimals, point these off likewise beginning at the decimal point, and supplying as many ciphers as may be required.

Find the greatest number whose square is less than the first left-hand period, and place it as the first figure in the quotient. Subtract its square from the left-hand period, and to the remainder annex the two figures of the second period for a dividend.

Double the first figure of the quotient for a partial divisor. Find how many times the latter is contained in the dividend exclusive of the right-hand figure, and set the figure representing that number of times as the second figure in the quotient and annex it to the right of the partial divisor, forming the complete divisor. Mul-

multiply this divisor by the second figure in the quotient and subtract the product from the dividend. To the remainder bring down the next period and proceed as before, in each case doubling the figures in the root already found to obtain the trial divisor. Should the product of the second figure in the root by the completed divisor be greater than the dividend, erase the second figure both from the quotient and from the divisor, and substitute the next smaller figure or one small enough to make the second figure by the divisor less than or equal to the dividend.

Find the square root of 3.141592

$$\begin{array}{r}
 3.141592 \quad | \quad \underline{1.772} \quad + \text{ square root} \\
 1 \\
 27 \overline{) 214} \\
 \underline{189} \\
 347 \overline{) 2515} \\
 \underline{2429} \\
 3542 \overline{) 8692} \\
 \underline{7084}
 \end{array}$$

**To Extract the Cube Root.**—Point off the number into periods of three figures each, beginning at the right hand or units' place. Point off decimals in periods of three figures from the decimal point. Find the greatest cube that does not exceed the left-hand period, write its root as the first figure in the required root. Subtract the cube from the left-hand period, and to the remainder bring down the next period for a dividend.

Square the first figure of the root, multiply by 300, and divide the product into the dividend for a trial divisor, write the quotient after the first figure of the root as a trial second figure.

Complete the divisor by adding to 300 times the square of the first figure, 30 times the product of the first by the second figure and the square of the second figure. Multiply this divisor by the second figure, and subtract the product from the remainder. Should the product be greater than the remainder the last figure of the root and the complete divisor are too large; substitute for the last figure the next smaller number and correct the trial divisor accordingly.

To the remainder bring down the next period, and proceed as before to find the third figure of the root; that is, square the two figures of the root already found, multiply by 300 for a trial divisor, etc. If the trial divisor is less than the dividend bring down another period of three figures, and place 0 in the root and proceed as before.

The cube root of a number will contain as many figures as there are periods of three in the number.

Find the cube root of 1,881,365

$$\begin{array}{r}
 1,881,365 \quad | \quad 123. + \text{ cube root} \\
 \underline{1} \\
 300 \times 1^3 = 300 \quad | \quad 881 \\
 30 \times 1 \times 2 = 60 \quad | \quad \quad \\
 2^3 = 4 \quad | \quad \quad \\
 \hline
 364 \quad | \quad 728 \\
 300 \times 12^3 = 43200 \quad | \quad 153365 \\
 30 \times 12 \times 3 = 1080 \quad | \quad \quad \\
 3^3 = 9 \quad | \quad \quad \\
 \hline
 44289 \quad | \quad 132867
 \end{array}$$

[Above examples from Mechanical Engineer's Pocket Book. Wm. Kent.]

#### LOGARITHMS

The **logarithm** (log.) of a number is the exponent of the power to which it is necessary to raise a fixed number or base to produce the given number. Thus if the base is 10, the log. of 100 is 2, for  $10^2 = 100$ . Logarithms having 10 as the base are called **common** or **Brigg's logarithms**, while those with 2.718281 are **hyperbolic** or **Naperian**. Common logarithms are given in the table on pages 29-30. The hyperbolic log. of a number is equal to the common log. of the number  $\times 2.302585$ .

With the aid of logarithms, multiplication, division, involution and evolution of large numbers may be shortened. Thus, to multiply two numbers, add their logarithms, and then find the number whose logarithm is their sum. To divide one number into another, subtract the logarithm of the smaller from the larger, and find the number whose logarithm is the difference, which number will be the quotient.

To raise a number to a given power, multiply the logarithm of the number by the exponent of the power, and find the number whose logarithm is the product.

To find any root of a number, divide the logarithm of the number by the index of the root, and the quotient will be the logarithm of the root; then by referring to the table of logarithms the number can be found.

The logarithm of a number consists of two parts, viz., a whole number called the **characteristic**, and a decimal or **mantissa**. The characteristic is one less than the number of figures to the left

**SQUARES, CUBES, SQUARE ROOTS, CUBE ROOTS, LOGARITHMS,  
CIRCUMFERENCES AND CIRCULAR AREAS OF NOS. FROM 1 TO 50**

No.	Square	Cube	Square Root	Cube Root	Log.	No. = Dia.	
						Circum.	Area
1	1	1	1.0000	1.0000	0.00000	3.142	0.7854
2	4	8	1.4142	1.2599	0.30103	6.283	3.1416
3	9	27	1.7321	1.4422	0.47712	9.425	7.0686
4	16	64	2.0000	1.5874	0.60206	12.566	12.5664
5	25	125	2.2361	1.7100	0.69897	15.708	19.6350
6	36	216	2.4495	1.8171	0.77815	18.850	28.2743
7	49	343	2.6458	1.9129	0.84510	21.991	38.4845
8	64	512	2.8284	2.0000	0.90308	25.133	50.2655
9	81	729	3.0000	2.0801	0.95424	28.274	63.6173
10	100	1000	3.1623	2.1544	1.00000	31.416	78.5398
11	121	1331	3.3166	2.2240	1.04139	34.558	95.0332
12	144	1728	3.4641	2.2894	1.07918	37.699	113.097
13	169	2197	3.6056	2.3513	1.11394	40.841	132.732
14	196	2744	3.7417	2.4101	1.14613	43.982	153.938
15	225	3375	3.8730	2.4662	1.17609	47.124	176.715
16	256	4096	4.0000	2.5198	1.20412	50.265	201.062
17	289	4913	4.1231	2.5713	1.23045	53.407	226.990
18	324	5832	4.2426	2.6207	1.25527	56.549	254.469
19	361	6859	4.3589	2.6684	1.27875	59.690	283.529
20	400	8000	4.4721	2.7144	1.30103	62.832	314.159
21	441	9261	4.5826	2.7589	1.32222	65.973	346.361
22	484	10648	4.6904	2.8020	1.34242	69.115	380.133
23	529	12167	4.7958	2.8439	1.36173	72.257	415.476
24	576	13824	4.8990	2.8845	1.38021	75.398	452.389
25	625	15625	5.0000	2.9240	1.39794	78.540	490.874
26	676	17576	5.0900	2.9625	1.41497	81.681	530.929
27	729	19683	5.1962	3.0000	1.43136	84.823	572.555
28	784	21952	5.2915	3.0356	1.44716	87.965	615.752
29	841	24389	5.3852	3.0723	1.46240	91.106	660.520
30	900	27000	5.4772	3.1072	1.47712	94.248	706.858
31	961	29791	5.5678	3.1414	1.49136	97.389	754.768
32	1024	32768	5.6569	3.1748	1.50515	100.531	804.248
33	1089	35937	5.7446	3.2075	1.51851	103.673	855.299
34	1156	39304	5.8310	3.2396	1.53148	106.814	907.920
35	1225	42875	5.9161	3.2711	1.54407	109.956	962.113
36	1296	46656	6.0000	3.3019	1.55630	113.097	1017.88
37	1369	50653	6.0828	3.3322	1.56820	116.239	1075.21
38	1444	54872	6.1644	3.3620	1.57978	119.381	1134.11
39	1521	59319	6.2450	3.3912	1.59106	122.522	1194.59
40	1600	64000	6.3246	3.4200	1.60206	125.66	1256.64
41	1681	68921	6.4031	3.4482	1.61278	128.81	1320.25
42	1764	74088	6.4807	3.4760	1.62325	131.95	1385.44
43	1849	79507	6.5574	3.5034	1.63347	135.09	1452.20
44	1936	85184	6.6332	3.5303	1.64345	138.23	1520.53
45	2025	91125	6.7082	3.5569	1.65321	141.37	1590.43
46	2116	97336	6.7823	3.5830	1.66276	144.51	1661.90
47	2209	103823	6.8557	3.6088	1.67210	147.65	1734.94
48	2304	110592	6.9282	3.6342	1.68124	150.80	1809.56
49	2401	117649	7.0000	3.6593	1.69020	153.94	1885.74
50	2500	125000	7.0711	3.6840	1.69897	157.08	1963.50

of the decimal point in the number whose logarithm is to be found. Thus the characteristic of numbers from 1 to 9.999 is 0, from 10 to 99.999 is 1, and so on. Should the number be a decimal with no figures to the left of the decimal point, then the characteristic is negative and is equal to the number of places the first figure is from

**SQUARES, CUBES, SQUARE ROOTS, CUBE ROOTS, LOGARITHMS,  
CIRCUMFERENCES AND CIRCULAR AREAS OF NOS. FROM 51 TO 100**

No.	Square	Cube	Square Root	Cube Root	Log.	No. = Dia.	
						Circum.	Area
51	2601	132651	7.1414	3.7084	1.70757	160.22	2042.82
52	2704	140608	7.2111	3.7325	1.71600	163.36	2123.72
53	2809	148877	7.2801	3.7563	1.72428	166.50	2206.18
54	2916	157464	7.3485	3.7798	1.73239	169.65	2290.22
55	3025	166375	7.4162	3.8030	1.74036	172.79	2375.83
56	3136	175616	7.4833	3.8259	1.74819	175.93	2463.01
57	3249	185193	7.5498	3.8485	1.75587	179.07	2551.76
58	3364	195112	7.6158	3.8709	1.76343	182.21	2642.08
59	3481	205379	7.6811	3.8930	1.77085	185.35	2733.97
60	3600	216000	7.7460	3.9149	1.77815	188.50	2827.43
61	3721	226981	7.8102	3.9365	1.78533	191.64	2922.47
62	3844	238328	7.8740	3.9579	1.79239	194.78	3019.07
63	3969	250047	7.9373	3.9791	1.79934	197.92	3117.25
64	4096	262144	8.0000	4.0000	1.80618	201.06	3216.99
65	4225	274625	8.0623	4.0207	1.81291	204.20	3318.31
66	4356	287496	8.1240	4.0412	1.81954	207.35	3421.19
67	4489	300763	8.1854	4.0615	1.82607	210.49	3525.65
68	4624	314432	8.2462	4.0817	1.83251	213.63	3631.68
69	4761	328509	8.3066	4.1016	1.83885	216.77	3739.28
70	4900	343000	8.3666	4.1213	1.84510	219.91	3848.45
71	5041	357911	8.4261	4.1408	1.85126	223.05	3959.19
72	5184	373248	8.4853	4.1602	1.85733	226.19	4071.50
73	5329	389017	8.5440	4.1793	1.86332	229.34	4185.39
74	5476	406224	8.6023	4.1983	1.86923	232.48	4300.84
75	5625	424875	8.6603	4.2172	1.87506	235.62	4417.86
76	5776	438976	8.7178	4.2358	1.88081	238.76	4536.46
77	5929	454533	8.7750	4.2543	1.88649	241.90	4656.63
78	6084	471552	8.8318	4.2727	1.89209	245.04	4778.36
79	6241	490039	8.8882	4.2908	1.89763	248.19	4901.67
80	6400	512000	8.9443	4.3089	1.90309	251.33	5026.55
81	6561	531441	9.0000	4.3267	1.90849	254.47	5153.00
82	6724	551368	9.0554	4.3445	1.91381	257.61	5281.02
83	6889	571787	9.1104	4.3621	1.91908	260.75	5410.61
84	7056	592704	9.1652	4.3795	1.92428	263.89	5541.77
85	7225	614125	9.2195	4.3968	1.92942	267.04	5674.50
86	7396	636056	9.2736	4.4140	1.93450	270.18	5808.80
87	7569	658503	9.3274	4.4310	1.93952	273.32	5944.68
88	7744	681472	9.3808	4.4480	1.94448	276.46	6082.12
89	7921	704969	9.4340	4.4647	1.94939	279.60	6221.14
90	8100	729000	9.4868	4.4814	1.95424	282.74	6361.73
91	8281	753571	9.5394	4.4979	1.95904	285.88	6503.88
92	8464	778688	9.5917	4.5144	1.96379	289.03	6647.61
93	8649	804357	9.6437	4.5307	1.96848	292.17	6792.91
94	8836	830584	9.6954	4.5468	1.97313	295.31	6939.78
95	9025	857375	9.7468	4.5629	1.97772	298.45	7088.22
96	9216	884736	9.7980	4.5789	1.98227	301.59	7238.23
97	9409	912673	9.8489	4.5947	1.98677	304.73	7389.81
98	9604	941192	9.8995	4.6104	1.99123	307.88	7542.96
99	9801	970299	9.9499	4.6261	1.99564	311.02	7697.69
100	10000	1000000	10.0000	4.6418	2.00000	314.16	7852.98

the decimal point. Thus the characteristic of numbers from .1 to .999 is - 1, from .01 to .099 is - 2, .0000072 is - 6, etc. The mantissa or decimal part is only given in the table, the decimal point being omitted. The minus sign is frequently placed above the characteristic thus: log. .31830 =  $\bar{1}.50285$  or  $9.50285 - 10$ .

If a number is multiplied or divided by any integral power of 10, producing another number with the same sequence of figures, the mantissae of their logarithms will be equal. To find the logarithm of a number take from the table the mantissa corresponding to its sequence of figures, and the characteristic may be prefixed by the rule given above.

Thus if  $\log.$  of 3.053 = .484727

$\log.$  30.53 = 1.484727       $\log.$  .3053 = 9.484727 - 10

$\log.$  305.3 = 2.484727       $\log.$  .03053 = 8.484727 - 10

$\log.$  3053. = 3.484727       $\log.$  .003053 = 7.484727 - 10

The above property is only enjoyed by the common or Brigg's logarithms and constitutes their superiority over other systems of logarithms.

#### ·GEOMETRICAL PROPOSITIONS

The sum of the angles of a triangle is equal to  $180^\circ$ .

If a triangle is equilateral it is equiangular.

In a right-angled triangle the square on the hypotenuse is equal to the sum of the squares of the other two sides.

A straight line from the vertex of an isosceles triangle perpendicular to the base bisects the base and the vertical angle.

A circle can be drawn through any three points not in the same straight line.

If a triangle is inscribed in a semicircle, it is right-angled.

In a quadrilateral the sum of the interior angles is equal to four right angles or  $360^\circ$ .

In a parallelogram the opposite sides are equal, as also the opposite angles are equal.

A parallelogram is bisected by its diagonals, which in turn are bisected by each other.

If the sides of a polygon are produced, then the sum of the exterior angles is equal to four right angles.

The areas of two circles are to each other as the squares of their radii.

If a radius is perpendicular to a chord, it bisects the chord and the arc subtended by the chord.

From a point without a circle only two tangents can be drawn to the circle. The tangents so drawn are equal.

A straight line tangent to a circle meets it at one point, and it is perpendicular to the radius drawn to that point.

If an angle is formed by a tangent and a chord, it is measured by one-half of the arc intercepted by the chord.

If an angle at the circumference of a circle between two chords is subtended by the same arc as an angle at the center between two radii, the angle at the circumference is equal to half the angle at the center.

#### PROPERTIES OF CIRCLES AND ELLIPSES

**Circle.**—The ratio of the circumference of a circle to its diameter is 3.141592 and is represented by the symbol  $\pi$  (called Pi)

Circumference of a circle = diameter  $\times$  3.14159

Diameter of circle  $\times$  .88623 } = side of equal square

Circumference of circle  $\times$  .28209 }

Circumference of circle  $\times$  1.1284 = perimeter of equal square

Side of square of equal periphery as circle = diameter  $\times$  .7854

Diameter of circle circumscribed about square = side  $\times$  1.4142

Side of square inscribed in circle = diameter  $\times$  .70711

To find the length of an arc of a circle, multiply the diameter of the circle by the number of degrees in the arc and this product by .0087266. Or let  $C$  represent the length of the chord of the arc and  $c$  the length of the chord of half the arc, then the length

$$\text{of the arc} = \frac{8c - C}{3}$$

$$\text{Chord of the arc} = 2 \times \text{radius} \times \sin \frac{\text{angle in degrees}}{2}$$

Rise (the perpendicular distance from the center of the chord to the arc) = radius -  $\frac{1}{2} \sqrt{4 \text{ radius}^2 - \text{length of chord}^2}$

$$= 2 \times \text{radius} \times \sin^2 \frac{\text{angle in degrees}}{4}$$

For areas of segments and sectors see Areas.

$\pi$	= 3.1415926	log. = 0.497149
$\frac{\pi}{4}$	= .7853982	log. = $\bar{1}.895090$
$\frac{1}{\pi}$	= .0318309	log. = $\bar{1}.5028501$
$\frac{\pi}{180}$	= .0174533	log. = $\bar{2}.2418774$
$\frac{180}{\pi}$	= 57.2957795	log. = 1.7581226

Ellipse. Let  $D$  = major axis  
 $d$  = minor axis

$$\text{Approximate circumference} = 3.1416 \sqrt{\frac{D^2 + d^2}{2}}$$

$$\begin{aligned} \text{Area} &= D \times d \times .78539 \\ &= \frac{D \times d}{4} \times 3.14159 \end{aligned}$$

#### AREAS OF PLANE FIGURES AND SURFACES OF SOLIDS

##### Plane Figures.

Triangle = base  $\times$   $\frac{1}{2}$  altitude  
 =  $\sqrt{s(s-a)(s-b)(s-c)}$  where  $s$  =  $\frac{1}{2}$  sum  
 of the three sides  $a$ ,  $b$  and  $c$

Parallelogram = base  $\times$  altitude

Trapezoid = altitude  $\times$   $\frac{1}{2}$  the sum of the parallel sides

Trapezium = divide into two triangles and find area of the  
 triangles

Circle = diameter<sup>2</sup>  $\times$  .7854 =  $\pi \times$  radius<sup>2</sup>

Sector of circle = length of arc  $\times$   $\frac{1}{2}$  the radius  
 =  $\frac{\pi \times \text{radius}^2 \times \text{angle in degrees}}{360} = .0087266 \times$   
 radius<sup>2</sup>  $\times$  angle in degrees

Segment of circle.—Where the line forming the segment cuts the  
 circle, draw lines to the center forming a sector and a center angle  $A$ .

Then area of segment =  $\frac{\text{radius}^2}{2} \left( \frac{3.1416 \times A \text{ in degrees}}{180} - \sin A \right)$

Circle of same area as square: diameter = side  $\times$  1.12838

Square of same area as circle: side = diameter  $\times$  .88623

Ellipse = long diameter  $\times$  short diameter  $\times$  .7854

Parabola = base  $\times$   $\frac{2}{3}$  perpendicular height.

Regular polygon = sum of its sides  $\times$  perpendicular from its  
 center to one of its sides divided by 2. Or multiply  $\frac{1}{2}$  the  
 perimeter by the perpendicular from the center to a side.

Irregular polygon: draw diagonals dividing it into triangles, and  
 find the sum of the areas of the triangles.

Trapezoidal Rule.—To find the area of a curvilinear figure, as  
 $ABCD$  (see Fig. 1), divide the base into any number of con-  
 venient equal parts, and erect perpendiculars meeting the curve.  
 To the half sum of the first and last perpendiculars add the sum of  
 all the intermediate ones; then the sum multiplied by the common  
 interval will give the area.



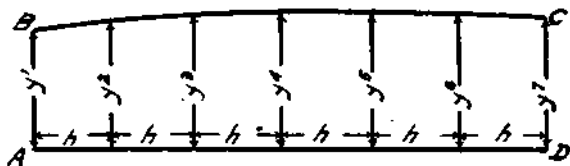

Figure 1

Let  $h$  = the common interval

$y_1, y_2$ , etc., lengths of the perpendiculars to the line  $AD$

Then the area  $ABCD = h \left( \frac{y_1 + y_7}{2} + y_2 + y_3 + y_4 + y_5 + y_6 \right)$

**Simpson's First Rule.**—This rule assumes that the curved line  $BC$  forming one side of the curvilinear area  $ABCD$  (see Fig. 2) is a portion of a curve known as a parabola of the second order whose equation is  $y = ax^2 + bx + c$ .

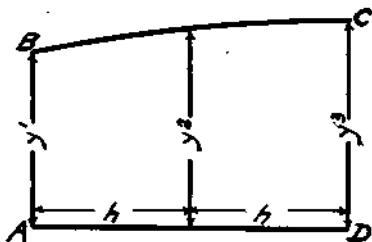

Figure 2

Divide the base into any convenient even number of parts, and erect perpendiculars to meet the curve. To the sum of the end perpendiculars or ordinates add four times the even numbered ordinates and twice the odd numbered ordinates. Multiply the sum by one-third the common interval and the product will be the area.

Thus the area  $ABCD$  in Fig. 2 =  $\frac{h}{3} (y_1 + 4y_2 + y_3)$

Or the area of  $ABCD$  in Fig. 1 =  $\frac{h}{3} (y_1 + 4y_2 + 2y_3 + 4y_4 + 2y_5 + 4y_6 + y_7)$

It is found that areas given by the above approximate rule for curvilinear figures are very accurate, and the rule is extensively used in ship calculations.

*Example.* The ordinates to a curve are 1.5, 3.1, 5.2, 6.0, 6.5, 7.0, 8.1, 8.5 and 9.0 ft., the common interval is 3 ft. Find the area.

Number of Ordinate	Length of Ordinate	Simpson's Multipliers	Functions of Ordinates
1.....	1.5	1	1.5
2.....	3.1	4	12.4
3.....	5.2	2	10.4
4.....	6.0	4	24.0
5.....	6.5	2	13.0
6.....	7.0	4	28.0
7.....	8.1	2	16.2
8.....	8.5	4	34.0
9.....	9.0	1	9.0

148.5

Common interval = 3 ft.

Then the area =  $\frac{1}{2} \times 3 \times 148.5 = 148.5$  sq. ft.

The multipliers may be  $\frac{1}{2}$  of those given in the example, viz.,  $\frac{1}{2}$ , 2, 1, 2, 1, 2, 1, 2,  $\frac{1}{2}$  and the sum of the functions multiplied by  $\frac{3}{2}$  the common interval as above. The  $\frac{1}{2}$  multipliers are in some cases easier to work with, as the sum of the functions is a smaller number.

Simpson's Second Rule assumes that the curve  $BC$  (see Fig. 3) is part of a parabola of the third order, where  $y = ax + bx + cx$ .

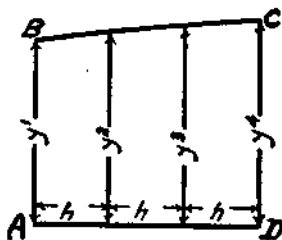

Figure 3

The area of the curve  $ABCD$ , Fig. 3, is  $\frac{3h}{8} (y_1 + 3y_2 + 3y_3 + y_4)$

or the curve in Fig. 1 is  $\frac{3h}{8} (y_1 + 3y_2 + 3y_3 + 2y_4 + 3y_5 + 3y_6 + y_7)$

Here the number of ordinates must be a multiple of 3 plus 1.

Simpson's first rule is used more than the second as it is simpler and is quite as accurate.

**Surface of Solids.**—Lateral surface of a right or oblique prism or cylinder = perimeter of the base  $\times$  lateral length. To get the total surface add the areas of the bases to the lateral surface.

Pyramid or cone, right and regular, lateral surface = perimeter of base  $\times \frac{1}{2}$  slant height. To get total surface add area of base.

Frustum of pyramid or cone, right and regular parallel ends, lateral surface = (sum of perimeters of base and top)  $\times \frac{1}{2}$  slant height. To get total surface add areas of the bases to the lateral surface.

Surface of a sphere =  $4 \pi$  radius<sup>2</sup> =  $\pi$  diameter<sup>2</sup>.

Surface of spherical sector =  $\frac{1}{2} \pi r (4b + c)$ . See Fig. 4.

Surface of a spherical segment =  $2 \pi r b = \frac{1}{4} \pi (4b^2 + c^2)$ . See Fig. 5.

Surface of a spherical zone =  $2 \pi r b$ . See Fig. 6.

Surface of a circular ring =  $4 \pi^2 R r$ . See Fig. 7.

Surface of a regular polyhedron (a solid whose sides are equal regular polygons) = area of one of the faces  $\times$  the number of faces.

#### VOLUMES OF SOLIDS

**Prism, right or oblique regular or irregular.**—Volume = area of section perpendicular to the sides  $\times$  the lateral length of a side.

**Cylinder, right or oblique, circular or elliptic, etc.**—Volume = area of section perpendicular to the sides  $\times$  the lateral length of a side.

**Frustum of any prism or cylinder.**—Volume = area of base  $\times$  perpendicular distance from base to center of gravity of opposite face.

**Pyramid or cone, right or oblique, regular or irregular.**—Volume = area of base  $\times \frac{1}{3}$  the perpendicular height.

**Frustum of any pyramid or cone, parallel ends.**—Volume = (sum of the areas of base and top plus the square root of their products)  $\times \frac{1}{3}$  the perpendicular height.

**Wedge, parallelogram face.**—Volume = sum of three edges  $\times$  perpendicular height  $\times$  perpendicular width.

**Sphere.**—Volume =  $\frac{4}{3} \pi$  (radius)<sup>3</sup> or (diameter)<sup>3</sup>  $\times .5236$ .

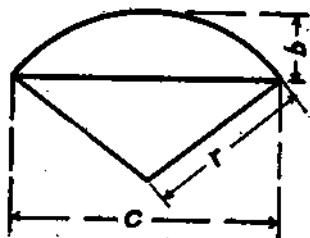

$$\text{Volume} = \frac{3}{8} \pi r^2 b$$

Figure 4  
Spherical Sector

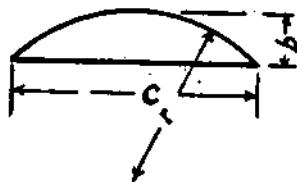

$$\text{Volume} = \frac{1}{8} \pi b^2 (3r - b)$$

Figure 5  
Spherical Segment

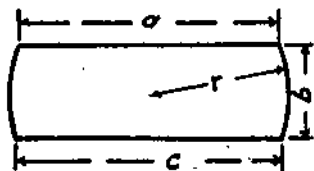

$$\text{Volume} = \frac{1}{4} \pi b (3a^2 + 3c^2 + 4b^2)$$

Figure 6  
Spherical Zone

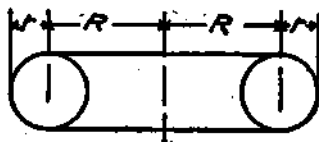

$$\text{Volume} = 2 \pi^2 R r^2$$

Figure 7  
Circular Ring



$$\text{Volume} = \frac{4}{3} \pi r a b$$

Figure 8  
Ellipsoid

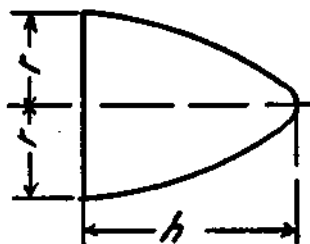

$$\text{Volume} = \frac{1}{2} \pi r^2 h$$

Figure 9  
Paraboloid

**Regular polyhedron.**—Volume = area of its surface  $\times \frac{1}{3}$  the perpendicular from the center to one of the faces.

The volume of any irregular prismatic solid may be obtained by dividing it into prisms or other bodies whose contents can be calculated by the above formulae. The sum of the contents of these bodies will give the total volume of the solids.

To find the volume of a solid bounded by a curved surface, as the underwater portion of a ship's hull, divide the solid by a series of planes or sections spaced an equal distance apart.

The area of each section can be calculated by either the trapezoidal or Simpson's rule, or by means of an instrument called a planimeter. The areas of the sections can be laid off on ordinates which are spaced the same distance apart as the sections which the body was divided into. A curve is drawn through the points laid off on the ordinates, and the area of the curvilinear figure is the volume of the solid.

*Example.* The areas of cross sections of a ship below the load water line are 1.2, 17.6, 41.6, 90.7, 134.3, 115.4, 61.7, 30.4 and 6.6 sq. ft. The sections are 9.5 ft. apart. Find the volume in cubic feet, and the displacement in tons of salt water.

Number of Section	Area	Simpson's Multipliers	Functions of Areas
1 .....	1.2	1	1.2
2 .....	17.6	4	70.4
3 .....	41.6	2	83.2
4 .....	90.7	4	362.8
5 .....	134.3	2	268.6
6 .....	115.4	4	661.6
7 .....	61.7	2	123.4
8 .....	30.4	4	121.6
9 .....	6.6	1	6.6
			1,699.4

$$\text{Volume} = \frac{1}{3} \times 9.5 \text{ ft.} \times 1,699.4 = 5,381.4 \text{ cu. ft.}$$

$$\text{Displacement} = \frac{5,381.4}{35} = 153.7 \text{ tons}$$

To find the volume of a cross coal bunker or a side bunker having the same cross section throughout, divide the height into intervals and calculate the area of the section by Simpson's first rule. Multiply the area thus found by the length of the bunker, giving the capacity in cubic feet. To convert this into tons divide by 42, as 42 cu. ft. is usually taken as one ton of 2240 lb.

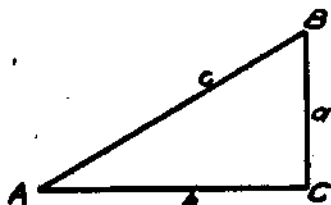

Figure 10

## TRIGONOMETRY

The complement of an angle or arc is what remains after subtracting the angle or arc from  $90^\circ$ . If an arc is represented by  $A$ , its complement is  $90^\circ - A$ . Hence the complement of an arc that exceeds  $90^\circ$  is negative.

The supplement of an angle or arc is what remains after subtracting the angle or arc from  $180^\circ$ . If  $A$  is an arc, its supplement is  $180^\circ - A$ . The supplement of an arc that exceeds  $180^\circ$  is negative.

As the sum of the three angles of a triangle is equal to  $180^\circ$ , any angle is the supplement of the other two.

**Trigonometric Functions.**—In the right triangle (Fig. 10) if  $A$  is one of the acute angles,  $a$  the opposite side,  $b$  the adjacent side and  $c$  the hypotenuse,

$$\text{sine of angle } A = \frac{\text{opposite side}}{\text{hypotenuse}} = \frac{a}{c}$$

$$\text{cosine of angle } A = \frac{\text{adjacent side}}{\text{hypotenuse}} = \frac{b}{c}$$

$$\text{tangent of angle } A = \frac{\text{opposite side}}{\text{adjacent side}} = \frac{a}{b}$$

$$\text{cotangent of angle } A = \frac{\text{adjacent side}}{\text{opposite side}} = \frac{b}{a}$$

$$\text{secant of angle } A = \frac{\text{hypotenuse}}{\text{adjacent side}} = \frac{c}{b}$$

$$\text{cosecant of angle } A = \frac{\text{hypotenuse}}{\text{opposite side}} = \frac{c}{a}$$

$$\text{versed sine of angle } A = 1 - \text{cosine } A$$

$$\text{exsecant of angle } A = \text{secant } A - 1$$

For angle  $B$

$$\sin B = \frac{b}{c} \qquad \cotan B = \frac{a}{b}$$

$$\cos B = \frac{a}{c} \qquad \sec B = \frac{c}{a}$$

$$\tan B = \frac{b}{a} \qquad \text{cosec } B = \frac{c}{b}$$

$$\text{Then } \sin A = \cos B = \frac{a}{c} \qquad \cotan A = \tan B = \frac{b}{a}$$

$$\cos A = \sin B = \frac{b}{c} \qquad \sec A = \text{cosec } B = \frac{c}{b}$$

$$\tan A = \cotan B = \frac{a}{b} \qquad \text{cosec } A = \sec B = \frac{c}{a}$$

If a circle is divided into four quadrants, the upper right-hand quadrant is called the first, the upper left the second, the lower left the third, and the lower right the fourth. The signs of the functions in the four quadrants are as follows:

	First	Second	Third	Fourth
Sine and cosecant.....	+	+	-	-
Cosine and secant.....	+	-	-	+
Tangent and cotangent.....	+	-	+	-

The symbol  $\sin^{-1}x$  means the angle whose sine is  $x$ , and is read inverse sine of  $x$  and anti sine of  $x$  (also arc sine  $x$ ). Similarly  $\cos^{-1}x$ ,  $\tan^{-1}x$ , etc. While the direct functions sine, cos, etc., are single valued, the indirect are many, thus  $\sin 30^\circ = .5$ , but  $\sin^{-1}.5 = 30^\circ$  or  $150^\circ$ .

If an acute angle and one side or if two sides of a right triangle are given the other elements can be determined. Let  $A$  and  $B$  be acute angles (see Fig. 10),  $a$  and  $b$  the sides opposite them. The acute angles are complementary, that is  $A + B = 90^\circ$ . Five cases may be distinguished.

Given  $c$  and  $A$  then  $a = c \sin A$ ,  $b = c \cos B$

$a$  "  $A$        $b = a \cot A$ ,  $c = a \operatorname{cosec} A$

$b$  "  $A$        $a = b \tan A$ ,  $c = b \sec A$

$a$  "  $c$        $A = \sin^{-1} \frac{a}{c}$ ,  $b = \sqrt{(c+a)(c-a)}$

$a$  "  $b$        $A = \tan^{-1} \frac{a}{b}$ ,  $c = \sqrt{a^2 + b^2}$

**Solution of Oblique Triangles.**—If any three of the six elements (three angles and three sides) of a triangle are known, the remaining three can be found, provided one of the given three is a side. There are four cases as follows:

**Case 1.** Given one side and two angles.

The third angle equals  $180^\circ$  minus the sum of the two given.

If the given side be  $a$  then  $b = \frac{a \sin B}{\sin A}$  and  $c = \frac{a \sin C}{\sin A}$

**Case 2.** Given two sides ( $a$  and  $b$ ) and the included angle  $C$ .

Then  $A = \frac{1}{2}(A + B) + \frac{1}{2}(A - B)$

$B = \frac{1}{2}(A + B) - \frac{1}{2}(A - B)$

$c = \frac{a \sin C}{\sin A}$

**Case 3.** Given two sides  $a$  and  $b$ , and the angle  $A$  opposite one of them.

$\sin B = \frac{b}{a} \sin A$  giving two values of  $B$ , one acute and one obtuse unless  $\sin B > 1$  in which case the data are impossible. Calling these two values  $B_1$  and  $B_2$ , then



corresponding to  $B_1, C_1 = 180 - (A + B)_1$  and  $c_1 = \frac{a \sin C_1}{\sin A}$

$$B_2, C_2 = 180 - (A + B)_2 \quad c_2 = \frac{a \sin C_2}{\sin A}$$

That is, there are two solutions unless  $C_2 < 0$  when only the first holds. A triangle should be constructed as then the two solutions will become more evident.

Case 4. Given the three sides. Let  $s = \frac{1}{2}(a + b + c)$

$$\text{Then } \cos \frac{1}{2} A = \sqrt{\frac{s(s-a)}{bc}}$$

$$\cos \frac{1}{2} B = \sqrt{\frac{s(s-b)}{ca}}$$

$$\cos \frac{1}{2} C = \sqrt{\frac{s(s-c)}{ab}}$$

There are two kinds of trigonometrical tables for the computation of the sides and angles of a triangle, viz., natural sines, tangents, etc., and logarithmic sines, tangents, etc. Natural sines, tangents, etc., are calculated for a circle whose radius is unity, and logarithmic sines, tangents, etc., for a circle whose radius is 10,000,000,000. With natural sines long operations in multiplication and division are necessary, while with logarithmic sines these operations in conjunction with a table of logarithms are reduced to addition and subtraction.

Trigonometric Formulae.— $\tan A = \frac{\sin A}{\cos A}$      $\sec A = \frac{1}{\cos A}$   
 $\tan A = \frac{1}{\cotan A}$      $\cotan A = \frac{\cos A}{\sin A}$      $\operatorname{cosec} A = \frac{1}{\sin A}$

$$\sin^2 A + \cos^2 A = 1$$

$$1 + \tan^2 A = \sec^2 A \quad 1 + \cotan^2 A = \operatorname{cosec}^2 A$$

$$\sin(A + B) = \sin A \cos B + \cos A \sin B$$

$$\cos(A + B) = \cos A \cos B - \sin A \sin B$$

$$\sin(A - B) = \sin A \cos B - \cos A \sin B$$

$$\cos(A - B) = \cos A \cos B + \sin A \sin B$$

$$\sin 2A = 2 \sin A \cos A \quad \tan 2A = \frac{2 \tan A}{1 - \tan^2 A}$$

$$\cos 2A = \cos^2 A - \sin^2 A \quad \cotan 2A = \frac{\cot^2 A - 1}{2 \cotan A}$$

$$\sin \frac{1}{2} A = \pm \sqrt{\frac{1 - \cos A}{2}} \quad \tan \frac{1}{2} A = \pm \sqrt{\frac{1 - \cos A}{1 + \cos A}}$$

$$\cos \frac{1}{2} A = \pm \sqrt{\frac{1 + \cos A}{2}} \quad \cotan \frac{1}{2} A = \pm \sqrt{\frac{1 + \cos A}{1 - \cos A}}$$

## NATURAL SINES, COSECANTS, TANGENTS, ETC.

		Sine	Cosecant	Tangent	Cotangent	Secant	Cosine		
0	0	.00000	Infinite.	.00000	Infinite.	1.00000	1.00000	0	90
10	0	.002909	343.77516	.002909	343.77371	1.00000	.999996	50	
20	0	.005818	171.88831	.005818	171.88840	1.00002	.999983	40	
30	0	.008727	114.58301	.008727	114.58865	1.00004	.999962	30	
40	0	.011635	85.945009	.011635	85.939791	1.00007	.999932	20	
50	0	.014544	68.757380	.014545	68.750087	1.00011	.999894	10	
1	0	.017452	57.298688	.017455	57.289962	1.00015	.999848	0	89
10	0	.020361	49.114062	.020365	49.103981	1.00021	.999793	50	
20	0	.023269	42.975713	.023275	42.964077	1.00027	.999729	40	
30	0	.026177	38.201550	.026186	38.188459	1.00034	.999657	30	
40	0	.029085	34.382318	.029097	34.367771	1.00042	.999577	20	
50	0	.031992	31.267577	.032009	31.241577	1.00051	.999488	10	
2	0	.034899	28.633708	.034921	28.636253	1.00061	.999391	0	88
10	0	.037806	26.450510	.037834	26.431900	1.00072	.999285	50	
20	0	.040713	24.562123	.040747	24.541758	1.00083	.999171	40	
30	0	.043619	22.925596	.043661	22.903766	1.00095	.999048	30	
40	0	.046525	21.493676	.046576	21.470401	1.00108	.998917	20	
50	0	.049431	20.290284	.049491	20.265553	1.00122	.998778	10	
3	0	.052336	19.107323	.052406	19.081137	1.00137	.998630	0	87
10	0	.055241	18.102619	.055325	18.074977	1.00153	.998473	50	
20	0	.058145	17.198434	.058243	17.189337	1.00169	.998308	40	
30	0	.061049	16.380408	.061163	16.349855	1.00187	.998135	30	
40	0	.063952	15.636793	.064083	15.604794	1.00206	.997957	20	
50	0	.066854	14.957832	.067004	14.924417	1.00224	.997763	10	
4	0	.069756	14.335587	.069927	14.300466	1.00244	.997564	0	86
10	0	.072658	13.763115	.072851	13.728738	1.00265	.997357	50	
20	0	.075559	13.234717	.075776	13.196888	1.00287	.997141	40	
30	0	.078459	12.745496	.078702	12.706206	1.00309	.996917	30	
40	0	.081359	12.291252	.081629	12.250506	1.00333	.996685	20	
50	0	.084258	11.868370	.084563	11.826167	1.00357	.996444	10	
5	0	.087156	11.473713	.087489	11.430062	1.00382	.996196	0	85
10	0	.090053	11.104549	.090421	11.059431	1.00408	.995937	50	
20	0	.092950	10.759486	.093354	10.711913	1.00435	.995671	40	
30	0	.095846	10.434431	.096289	10.385397	1.00463	.995396	30	
40	0	.098741	10.127522	.099226	10.078031	1.00491	.995113	20	
50	0	.101635	9.8391227	.102164	9.7881732	1.00521	.994822	10	
6	0	.104528	9.5667722	.105104	9.5143645	1.00551	.994522	0	84
10	0	.107421	9.3091699	.108046	9.2553035	1.00582	.994214	50	
20	0	.110313	9.0651512	.110990	9.0062261	1.00614	.993897	40	83
		Cosine	Secant	Cotangent	Tangent	Cosecant	Sine		

For functions from 83° 40' to 90° read from bottom of table upward.

## NATURAL SINES, COSECANTS, TANGENTS, ETC.—Continued

		Sine	Cosecant	Tangent	Cotangent	Secant	Cosine		
6	30	.113203	8.8336715	.113084	8.7766874	1.00647	.993572	30	
	40	.116093	8.6137901	.116883	8.5553488	1.00681	.992338	20	
	50	.118982	8.4045588	.119833	8.3449358	1.00715	.992096	10	
7	0	.121869	8.2058090	.122785	8.1443464	1.00751	.992546	0	83
	10	.124756	8.0150450	.125738	7.9530224	1.00787	.992187	50	
	20	.127642	7.8344335	.128694	7.7703506	1.00823	.991820	40	
	30	.130528	7.6612976	.131653	7.5957541	1.00863	.991445	30	
	40	.133410	7.4957100	.134613	7.4287064	1.00902	.991061	20	
	50	.136292	7.3371909	.137576	7.2687255	1.00942	.990669	10	
8	0	.139173	7.1852965	.140641	7.1153897	1.00983	.990286	0	82
	10	.142053	7.0396220	.143506	6.9682335	1.01024	.989896	50	
	20	.144932	6.8997942	.146478	6.8269437	1.01067	.989442	40	
	30	.147809	6.7654691	.149451	6.6911562	1.01111	.989016	30	
	40	.150686	6.6363293	.152426	6.5605538	1.01155	.988562	20	
	50	.153561	6.5120812	.155404	6.4348428	1.01200	.988139	10	
9	0	.156434	6.3924532	.158394	6.3137515	1.01247	.987688	0	81
	10	.159307	6.2771933	.161398	6.1970279	1.01294	.987229	50	
	20	.162178	6.1660674	.164434	6.0844381	1.01342	.986762	40	
	30	.165048	6.0588960	.167543	5.9757644	1.01391	.986286	30	
	40	.167916	5.9553625	.170634	5.8709042	1.01440	.985801	20	
	50	.170783	5.8553921	.173729	5.7693688	1.01491	.985309	10	
10	0	.173648	5.7587705	.176837	5.6712913	1.01543	.984808	0	80
	10	.176512	5.6653331	.179923	5.5763786	1.01595	.984298	50	
	20	.179375	5.5749258	.183032	5.4845052	1.01649	.983781	40	
	30	.182236	5.4874043	.186139	5.3965172	1.01703	.983255	30	
	40	.185095	5.4028333	.189259	5.3092793	1.01758	.982721	20	
	50	.187953	5.3204890	.191363	5.2256847	1.01815	.982178	10	
11	0	.190809	5.2406431	.194390	5.1445540	1.01872	.981627	0	79
	10	.193664	5.1635824	.197401	5.0658352	1.01930	.981098	50	
	20	.196517	5.0898284	.200425	4.9894027	1.01989	.980590	40	
	30	.199368	5.019317	.203462	4.9151570	1.02049	.979925	30	
	40	.202218	4.9511687	.206463	4.8430045	1.02110	.979281	20	
	50	.205065	4.8764907	.209518	4.7728568	1.02171	.978748	10	
12	0	.207912	4.8097343	.212557	4.7046301	1.02234	.978148	0	78
	10	.210759	4.7448206	.215699	4.6382457	1.02296	.977529	50	
	20	.213599	4.6816748	.218845	4.5736287	1.02362	.976921	40	
	30	.216440	4.6202268	.221985	4.5107065	1.02428	.976326	30	
	40	.219279	4.5604090	.224748	4.4494181	1.02494	.975663	20	
	50	.222116	4.5031546	.227806	4.3896940	1.02562	.975020	10	
		Cosine	Secant	Cotangent	Tangent	Cosecant	Sine		

For functions from 77° 10' to 83° 30' read from bottom of table upward.

## NATURAL SINES, COSECANTS, TANGENTS, ETC.—Continued

°	'	Sine	Cosecant	Tangent	Cotangent	Secant	Cosine	'	°
13	0	.234951	4.4454115	.230668	4.3314759	1.02630	.974370	0	77
	10	.237784	4.3901158	.233494	4.2747046	1.02700	.973712	50	
	20	.230616	4.3362150	.237004	4.2193315	1.02770	.973045	40	
	30	.233445	4.2839676	.240079	4.1652998	1.02842	.972370	30	
	40	.236273	4.2333943	.243168	4.1125614	1.02914	.971687	20	
	50	.239098	4.1823785	.246241	4.0610700	1.02987	.970995	10	
14	0	.241922	4.1335855	.249328	4.0107809	1.03061	.970296	0	76
	10	.244743	4.0859130	.252420	3.9616518	1.03137	.969588	50	
	20	.247563	4.0393304	.255517	3.9136420	1.03213	.968872	40	
	30	.250380	3.9939292	.258618	3.8667131	1.03290	.968146	30	
	40	.253195	3.9495224	.261723	3.8206281	1.03363	.967415	20	
	50	.256008	3.9061250	.264834	3.7759519	1.03447	.966675	10	
15	0	.258819	3.8637933	.267949	3.7320508	1.03528	.965926	0	75
	10	.261628	3.8222251	.271069	3.6890927	1.03609	.965169	50	
	20	.264434	3.7816596	.274195	3.6470487	1.03691	.964404	40	
	30	.267238	3.7419775	.277325	3.6058835	1.03774	.963630	30	
	40	.270040	3.7031506	.280460	3.5655749	1.03858	.962849	20	
	50	.272840	3.6651518	.283600	3.5260938	1.03944	.962059	10	
16	0	.275637	3.6279553	.286745	3.4874144	1.04030	.961262	0	74
	10	.278432	3.5915343	.289896	3.4495120	1.04117	.960456	50	
	20	.281225	3.5558710	.293052	3.4123628	1.04206	.959642	40	
	30	.284015	3.5209365	.296214	3.3759434	1.04296	.958820	30	
	40	.286803	3.4867110	.299380	3.3402323	1.04385	.957990	20	
	50	.289589	3.4531735	.302553	3.3052091	1.04477	.957151	10	
17	0	.292372	3.4203036	.305731	3.2708526	1.04569	.956305	0	73
	10	.295152	3.3886820	.308914	3.2371438	1.04663	.955450	50	
	20	.297930	3.3564900	.312104	3.2040633	1.04757	.954588	40	
	30	.300706	3.3250995	.315299	3.1715948	1.04853	.953717	30	
	40	.303479	3.2951234	.318500	3.1397194	1.04950	.952838	20	
	50	.306249	3.2663149	.321707	3.1084210	1.05047	.951951	10	
18	0	.309017	3.2386680	.324920	3.0776835	1.05146	.951057	0	72
	10	.311782	3.2073673	.328139	3.0474915	1.05246	.950154	50	
	20	.314545	3.1791978	.331394	3.0178301	1.05347	.949243	40	
	30	.317305	3.1515463	.334595	2.9886850	1.05449	.948324	30	
	40	.320062	3.1243959	.337833	2.9600422	1.05552	.947397	20	
	50	.322816	3.0977363	.341077	2.9318665	1.05657	.946462	10	
19	0	.325568	3.0715535	.344328	2.9042109	1.05762	.945519	0	71
	10	.328317	3.0458352	.347585	2.8789970	1.05869	.944568	40	
	20	.331063	3.0205693	.350848	2.8502349	1.05976	.943606	40	
°	'	Cosine	Secant	Cotangent	Tangent	Cosecant	Sine	'	°

For functions from 70° 40' to 77° 0' read from bottom of table upward.

## NATURAL SINES, COSECANTS, TANGENTS, ETC.—Continued

		Sine	Cosecant	Tangent	Cotangent	Secant	Cosine		
19	30	.333807	2.9957443	.354119	2.8239129	1.06085	.942641	30	70
	40	.336547	2.9713490	.357396	2.7980108	1.06195	.941666	20	
	50	.339285	2.9473724	.360680	2.7725446	1.06306	.940684	10	
20	0	.342020	2.9238044	.363970	2.7474774	1.06416	.939693	0	70
	10	.344752	2.9006346	.367268	2.7228076	1.06531	.938694	50	
	20	.347481	2.8778532	.370573	2.6985254	1.06645	.937687	40	
	30	.350207	2.8554610	.373885	2.6746218	1.06761	.936672	30	
	40	.352931	2.8334185	.377204	2.6510967	1.06873	.935650	20	
	50	.355651	2.8117471	.380530	2.6279121	1.06986	.934619	10	
21	0	.358368	2.7904281	.383864	2.6050891	1.07115	.933580	0	60
	10	.361082	2.7694532	.387205	2.5826094	1.07235	.932534	50	
	20	.363793	2.7488144	.390554	2.5604649	1.07356	.931480	40	
	30	.366501	2.7285038	.393911	2.5386479	1.07479	.930418	30	
	40	.369206	2.7085139	.397275	2.5171507	1.07602	.929348	20	
	50	.371908	2.6888374	.400647	2.4959661	1.07727	.928270	10	
22	0	.374607	2.6694672	.404026	2.4750869	1.07853	.927184	0	60
	10	.377302	2.6503962	.407414	2.4545061	1.07981	.926090	50	
	20	.379994	2.6316180	.410810	2.4342172	1.08109	.924989	40	
	30	.382683	2.6131250	.414214	2.4142136	1.08239	.923880	30	
	40	.385369	2.5949137	.417628	2.3944899	1.08370	.922762	20	
	50	.388052	2.5769753	.421046	2.3750372	1.08503	.921638	10	
23	0	.390731	2.5593047	.424475	2.3558524	1.08636	.920505	0	60
	10	.393407	2.5418961	.427912	2.3369287	1.08771	.919364	50	
	20	.396080	2.5247440	.431358	2.3182606	1.08907	.918216	40	
	30	.398749	2.5078428	.434812	2.2998425	1.09044	.917060	30	
	40	.401415	2.4911874	.438276	2.2816693	1.09183	.915896	20	
	50	.404078	2.4747726	.441748	2.2637357	1.09323	.914726	10	
24	0	.406737	2.4585933	.445229	2.2460368	1.09464	.913546	0	60
	10	.409392	2.4426448	.448719	2.2285676	1.09606	.912359	50	
	20	.412045	2.4269222	.452218	2.2113234	1.09750	.911164	40	
	30	.414693	2.4114210	.455726	2.1942997	1.09895	.909961	30	
	40	.417338	2.3961367	.459244	2.1774920	1.10041	.908751	20	
	50	.419980	2.3810650	.462771	2.1608958	1.10189	.907533	10	
25	0	.422618	2.3662016	.466308	2.1445069	1.10338	.906308	0	60
	10	.425253	2.3515424	.469854	2.1283213	1.10488	.905075	50	
	20	.427884	2.3370833	.473410	2.1123348	1.10640	.903834	40	
	30	.430511	2.3228205	.476976	2.0965436	1.10793	.902586	30	
	40	.433135	2.3087601	.480551	2.0809438	1.10947	.901329	20	
	50	.435755	2.2948985	.484137	2.0655318	1.11103	.900065	10	
		Cosine	Secant	Cotangent	Tangent	Cosecant	Sine		

For functions from 64° 10' to 70° 30' read from bottom of table upward.

## NATURAL SINES, COSECANTS, TANGENTS, ETC.—Continued

°	'	Sine	Cosecant	Tangent	Cotangent	Secant	Cosine	'	°
26	0	.438271	2.2811720	.487793	2.0603038	1.11280	.898794	0	64
	10	.440984	2.2676571	.491339	2.0352566	1.11419	.897515	50	
	20	.443593	2.2543204	.494955	2.0203862	1.11579	.896239	40	
	30	.446198	2.2411585	.498582	2.0056897	1.11740	.894934	30	
	40	.448799	2.2281681	.502219	1.9911637	1.11903	.893633	20	
	50	.451397	2.2153400	.505867	1.9769050	1.12067	.892323	10	
27	0	.453990	2.2026893	.509525	1.9626105	1.12233	.891007	0	63
	10	.456580	2.1901947	.513195	1.9485773	1.12400	.889682	50	
	20	.459166	2.1778895	.516876	1.9347020	1.12568	.888350	40	
	30	.461749	2.1656806	.520567	1.9209621	1.12738	.887011	30	
	40	.464327	2.1535653	.524270	1.9074147	1.12910	.885664	20	
	50	.466901	2.1417908	.527984	1.8939971	1.13083	.884309	10	
28	0	.469472	2.1300545	.531709	1.8807265	1.13257	.882948	0	62
	10	.472038	2.1184737	.535447	1.8676003	1.13433	.881578	50	
	20	.474600	2.1070359	.539198	1.8546159	1.13610	.880201	40	
	30	.477159	2.0957385	.542966	1.8417409	1.13789	.878817	30	
	40	.479713	2.0845792	.546758	1.8290628	1.13970	.877425	20	
	50	.482263	2.0735656	.550515	1.8164892	1.14152	.876026	10	
29	0	.484810	2.0626653	.554309	1.8040478	1.14335	.874620	0	61
	10	.487352	2.0519061	.558118	1.7917362	1.14521	.873206	50	
	20	.489890	2.0412757	.561939	1.7795524	1.14707	.871784	40	
	30	.492424	2.0307720	.565773	1.7674940	1.14896	.870356	30	
	40	.494953	2.0203929	.569619	1.7555590	1.15085	.868920	20	
	50	.497479	2.0101362	.573479	1.7437453	1.15277	.867476	10	
30	0	.500000	2.0000000	.577350	1.7320608	1.15470	.866026	0	60
	10	.502517	1.9898822	.581235	1.7204736	1.15665	.864567	50	
	20	.505030	1.9800810	.585134	1.7090116	1.15861	.863102	40	
	30	.507538	1.9702044	.589045	1.6976631	1.16059	.861629	30	
	40	.510043	1.9606206	.592970	1.6864261	1.16259	.860149	20	
	50	.512543	1.9510677	.596908	1.6752988	1.16460	.858662	10	
31	0	.515038	1.9416040	.600861	1.6642795	1.16663	.857167	0	59
	10	.517529	1.9322576	.604827	1.6533663	1.16868	.855665	50	
	20	.520016	1.9230173	.608807	1.6425576	1.17075	.854156	40	
	30	.522499	1.9138809	.612801	1.6318517	1.17283	.852640	30	
	40	.524977	1.9048469	.616809	1.6212499	1.17493	.851117	20	
	50	.527450	1.8959138	.620832	1.6107417	1.17704	.849586	10	
32	0	.529919	1.8870799	.624869	1.6003345	1.17916	.848048	0	58
	10	.532384	1.8783438	.628921	1.5900238	1.18133	.846503	50	
	20	.534844	1.8697040	.632988	1.5798079	1.18360	.844951	40	
°	'	Cosine	Secant	Cotangent	Tangent	Cosecant	Sine	'	°

For functions from 57° 40' to 64° 0' read from bottom of table upward.

## NATURAL SINES, COSECANTS, TANGENTS, ETC.—Continued

		Sine	Cosecant	Tangent	Cotangent	Secant	Cosine		
32	30	.537300	1.8611590	.637079	1.5696856	1.18566	.843391	30	
	40	.539751	1.8527073	.641167	1.5596562	1.18790	.841825	20	
	50	.542197	1.8443476	.645280	1.5497165	1.19012	.840251	10	
33	0	.544639	1.8360785	.649408	1.5398660	1.19236	.838671	0	57
	10	.547076	1.8278985	.653531	1.5301026	1.19463	.837083	50	
	20	.549509	1.8198065	.657710	1.5204261	1.19691	.835488	40	
	30	.551937	1.8118010	.661886	1.5108353	1.19920	.833886	30	
	40	.554360	1.8038809	.666077	1.5013262	1.20152	.832277	20	
	50	.556779	1.7960449	.670285	1.4919039	1.20386	.830661	10	
34	0	.559193	1.7882916	.674509	1.4825810	1.20622	.829038	0	56
	10	.561602	1.7806201	.678749	1.4732983	1.20859	.827407	50	
	20	.564007	1.7730290	.683007	1.4641147	1.21096	.825770	40	
	30	.566406	1.7655173	.687281	1.4550090	1.21341	.824126	30	
	40	.568801	1.7580837	.691573	1.4459801	1.21584	.822475	20	
	50	.571191	1.7507273	.695881	1.4370268	1.21830	.820817	10	
35	0	.573578	1.7434468	.700206	1.4281480	1.22077	.819152	0	55
	10	.575957	1.7362413	.704562	1.4193427	1.22327	.817480	50	
	20	.578332	1.7291096	.708913	1.4106096	1.22579	.815801	40	
	30	.580703	1.7220608	.713298	1.4019483	1.22833	.814116	30	
	40	.583069	1.7150939	.717691	1.3933571	1.23089	.812423	20	
	50	.585429	1.7081478	.722108	1.3848355	1.23347	.810723	10	
36	0	.587785	1.7013016	.726543	1.3763810	1.23607	.809017	0	54
	10	.590138	1.6945244	.730996	1.3679559	1.23866	.807304	50	
	20	.592482	1.6878151	.735469	1.3596794	1.24134	.805584	40	
	30	.594823	1.6811730	.739961	1.3514224	1.24400	.803857	30	
	40	.597159	1.6745970	.744473	1.3432331	1.24669	.802123	20	
	50	.599489	1.6680864	.749003	1.3351075	1.24940	.800383	10	
37	0	.601815	1.6616401	.753554	1.3270448	1.25214	.798636	0	53
	10	.604136	1.6552575	.758125	1.3190441	1.25489	.796882	50	
	20	.606451	1.6489376	.762716	1.3111046	1.25767	.795121	40	
	30	.608761	1.6426796	.767327	1.3032264	1.26047	.793353	30	
	40	.611067	1.6364828	.771959	1.2954067	1.26330	.791579	20	
	50	.613367	1.6303462	.776612	1.2876447	1.26615	.789796	10	
38	0	.615661	1.6242692	.781286	1.2799416	1.26902	.788011	0	52
	10	.617951	1.6182510	.785981	1.2722957	1.27191	.786217	50	
	20	.620235	1.6122908	.790696	1.2647062	1.27483	.784416	40	
	30	.622515	1.6063879	.795436	1.2571723	1.27778	.782606	30	
	40	.624789	1.6005416	.800196	1.2496933	1.28075	.780794	20	
	50	.627057	1.5947511	.804980	1.2422685	1.28374	.778973	10	
		Cosine	Secant	Cotangent	Tangent	Cosecant	Sine		

For functions from 51° 10' to 57° 30' read from bottom of table upward.

## NATURAL SINES, COSECANTS, TANGENTS, ETC.—Continued

		Sine	Cosecant	Tangent	Cotangent	Secant	Cosine		
39	0	.699320	1.5890157	.809784	1.2349972	1.23976	.777146	0	51
	10	.691578	1.5833318	.814612	1.2275786	1.28990	.775312	50	
	20	.683831	1.5777077	.819463	1.2203121	1.29287	.773472	40	
	30	.676078	1.5721337	.824336	1.2130970	1.29597	.771625	30	
	40	.668320	1.5666121	.829234	1.2059327	1.29909	.769771	20	
	50	.660557	1.5611424	.834155	1.1988184	1.30223	.767911	10	
40	0	.642788	1.5557238	.839100	1.1917536	1.30541	.766044	0	50
	10	.645013	1.5503558	.844069	1.1847376	1.30861	.764171	50	
	20	.647233	1.5450378	.849063	1.1777698	1.31183	.762292	40	
	30	.649448	1.5397690	.854081	1.1708496	1.31509	.760406	30	
	40	.651657	1.5345491	.859124	1.1639763	1.31837	.758514	20	
	50	.653861	1.5293773	.864193	1.1571495	1.32168	.756615	10	
41	0	.650059	1.5242531	.869287	1.1503684	1.32501	.754710	0	49
	10	.652252	1.5191759	.874407	1.1435326	1.32838	.752798	50	
	20	.654439	1.5141452	.879553	1.1366414	1.33177	.750880	40	
	30	.656620	1.5091605	.884725	1.1297044	1.33519	.748956	30	
	40	.658795	1.5042211	.889924	1.1228099	1.33864	.747025	20	
	50	.660966	1.4993267	.895151	1.1171305	1.34212	.745088	10	
42	0	.669131	1.4944755	.900404	1.1106125	1.34563	.743145	0	48
	10	.671289	1.4896703	.905685	1.1041365	1.34917	.741195	50	
	20	.673443	1.4849073	.910994	1.0977020	1.35274	.739239	40	
	30	.675590	1.4801872	.916331	1.0913085	1.35634	.737277	30	
	40	.677732	1.4755095	.921697	1.0849554	1.35997	.735309	20	
	50	.679868	1.4708736	.927091	1.0786423	1.36363	.733335	10	
43	0	.681996	1.4662792	.932515	1.0723687	1.36733	.731354	0	47
	10	.684123	1.4617257	.937968	1.0661341	1.37105	.729367	50	
	20	.686242	1.4572127	.943451	1.0599381	1.37481	.727374	40	
	30	.688355	1.4527397	.948965	1.0537801	1.37860	.725374	30	
	40	.690462	1.4483063	.954506	1.0476598	1.38242	.723369	20	
	50	.692563	1.4439120	.960083	1.0415767	1.38628	.721357	10	
44	0	.694658	1.4395565	.965689	1.0355303	1.39016	.719340	0	46
	10	.696748	1.4352393	.971326	1.0295203	1.39409	.717316	50	
	20	.698832	1.4309602	.976996	1.0235461	1.39804	.715286	40	
	30	.700909	1.4267182	.982697	1.0176074	1.40203	.713251	30	
	40	.702981	1.4225134	.988432	1.0117088	1.40606	.711209	20	
	50	.706047	1.4183454	.994199	1.0058348	1.41012	.709161	10	
45	0	.707107	1.4142136	1.000000	1.000000	1.41421	.707107	0	45
		Cosine	Secant	Cotangent	Tangent	Cosecant	Sine		

For functions from 45° 0' to 51° 0' read from bottom of table upward.



## MOMENT OF INERTIA, RADIUS OF GYRATION AND CENTER OF GRAVITY

**Moment of Inertia.**—The moment of inertia of a section is the sum of the products of each elementary area of the section times the square of its distance from an axis through the center of gravity of the section or other axis assumed for purposes of computation. Thus suppose an area  $A$  be divided into a large number of small areas  $a$ , and that each has its own radius  $r$ , from the assumed axis, then the moment of inertia  $I = \sum a r^2$ . See table on page 52.

**Radius of Gyration.**—This is equal to the square root of the quotient of the moment of inertia divided by the area of the section, expressed,  $R = \sqrt{I/A}$ . The radius of gyration is used in column

calculations. The unbraced length of the section divided by the radius of gyration is termed the ratio of slenderness. See Columns.

**Center of Gravity** of a body is that point about which, if suspended, all the parts would be in equilibrium, that is, there would be no tendency to rotate. If a body is suspended at its center of gravity, it will be in equilibrium in all positions. If it is suspended at any other point it will swing into a position such that its center of gravity is vertically below its point of suspension.

**To Find the Center of Gravity of a Cross Section of a Ship.**—First find the moment of the area about an end ordinate by taking each ordinate and multiplying it by its distance from the end ordinate. These products put through Simpson's rule will give the moment of the figure about the end ordinate, which moment divided by the area will give the distance of the center of gravity of the area from the end ordinate.

*Example.* A section of a steamer has half breadths beginning at the load water line, 4.86, 4.20, 3.40, 2.42, 1.33, .70 and .10 ft. spaced 2 ft. apart. Find how far from the load water line the center of gravity of the section is.

Number of Ordinate	Length of Ordinate	Simpson's Multipliers	Function of Ordinates	Number of Intervals from No. 1	Products for Moments
1	4.86	1	4.86	0	.00
2	4.20	4	16.80	1	16.80
3	3.40	2	6.80	2	13.60
4	2.42	4	9.68	3	29.04
5	1.33	2	2.66	4	10.64
6	.70	4	2.80	5	14.00
7	.10	1	1.00	6	6.00
			44.60		90.08

Half area from load water line =  $\frac{1}{2} \times 2 \times 44.60$ .

Moment of half area about load water line =  $\frac{1}{2} \times 2 \times 2 \times 90.08$ .

Distance center of gravity of section below load water line

$$= \frac{\frac{1}{2} \times 2 \times 2 \times 90.08}{\frac{1}{2} \times 2 \times 44.60} = 4.03 \text{ ft.}$$

If the total area or total moment was desired multiply by 2.

**To Find the Center of Gravity of a Water Plane from its Middle Ordinate.**—Lay off a table thus:

Number of Ordinate	Length of Ordinate	Simpson's Multipliers	Functions of Ordinates	Number of Intervals from Middle Ordinate	Products for Moments
1	.10	$\frac{1}{2}$	.05	5	.25
2	2.48	2	4.96	$4\frac{1}{2}$	22.32
3	4.88	$1\frac{1}{2}$	7.29	4	29.16
4	8.75	4	35.00	3	105.00
5	11.16	2	22.32	2	44.64
6	12.12	4	48.48	1	48.48
7	12.25	2	24.50	0	249.85
8	12.25	4	49.00	1	49.00
9	11.92	2	23.84	2	47.68
10	11.12	4	44.48	3	133.44
11	9.10	$1\frac{1}{2}$	13.65	4	54.60
12	6.80	2	13.60	$4\frac{1}{2}$	61.20
13	3.90	$\frac{1}{2}$	1.95	5	9.75
			289.12		
				355.67	

Ordinates 9.5 ft. apart

$$355.67 - 249.85 = 105.82$$

Distance center of gravity aft of the middle ordinate =

$$\frac{105.82 \times 9.5}{289.12} = 3.47 \text{ ft.}$$

Or let

A = sum of functions of ordinates

B = sum of products of moments forward of the middle ordinate

C = sum of products of moments aft of the middle ordinate

subtract the smaller sum of products of moments from the larger and let the difference be D.

Then the distance of the center of gravity from the middle ordinate

$$= \frac{D \times \text{distance the ordinates are apart}}{A}$$

and whether the distance is forward or aft depends on whether B or C is the largest.

## PROPERTIES OF VARIOUS SECTIONS

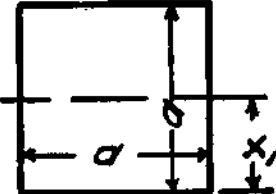
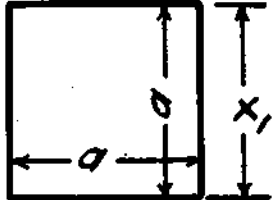
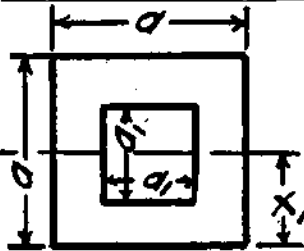
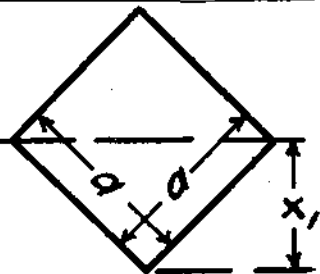
Sections	Area of Section A	Distance from Neutral Axis to Extremities of Section x and $x_1$
	$a^2$	$x = \frac{a}{2}$
	$a^2$	$x = a$
	$a^2 - a_1^2$	$x = \frac{a}{2}$
	$a^2$	$x = \frac{a}{\sqrt{2}} = .707a$

PROPERTIES OF VARIOUS SECTIONS—Continued

Moment of Inertia $I$	Section Modulus $S = \frac{I}{x_1}$	Radius of Gyration $r = \sqrt{\frac{I}{A}}$
$\frac{a^4}{12}$	$\frac{a^3}{6}$	$\frac{a}{\sqrt{12}} = .289a$
$\frac{a^4}{3}$	$\frac{a^3}{3}$	$\frac{a}{\sqrt{3}} = .577a$
$\frac{a^4 - a_1^4}{12}$	$\frac{a^3 - a_1^3}{3a}$	$\sqrt{\frac{a^2 + a_1^2}{12}}$
$\frac{a^4}{12}$	$\frac{a^3}{6\sqrt{2}} = .118a^2$	$\frac{a}{\sqrt{12}} = .289a$

## PROPERTIES OF VARIOUS SECTIONS—Continued

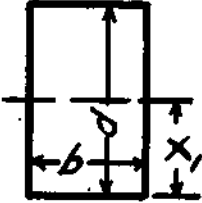
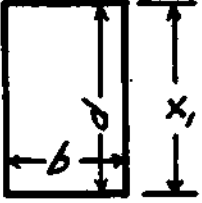
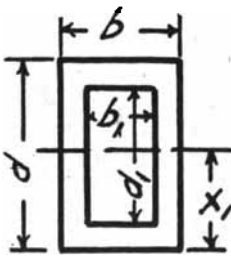
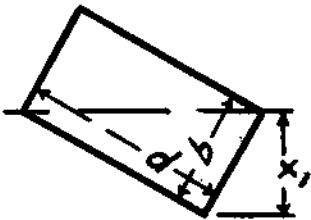
Sections	Area of Section A	Distance from Neutral Axis to Extremities of Section x and x <sub>1</sub>
	bd	$x = \frac{d}{3}$
	bd	$x = d$
	$bd - b_1d_1$	$x = \frac{d}{3}$
	bd	$x = \frac{bd}{\sqrt{b^2 + d^2}}$

## PROPERTIES OF VARIOUS SECTIONS—Continued

Moment of Inertia $I$	Section Modulus $S = \frac{I}{x_1}$	Radius of Gyration $r = \sqrt{\frac{I}{A}}$
$\frac{bd^3}{12}$	$\frac{bd^2}{6}$	$\frac{d}{\sqrt{12}} = .289d$
$\frac{bd^3}{3}$	$\frac{bd^2}{3}$	$\frac{d}{\sqrt{3}} = .577d$
$\frac{bd^3 - b_1d_1^3}{12}$	$\frac{bd^2 - b_1d_1^2}{6d}$	$\sqrt{\frac{bd^3 - b_1d_1^3}{12 (bd - b_1d_1)}}$
$\frac{bd^3}{6 (b^2 + d^2)}$	$\frac{bd^2}{6\sqrt{b^2 + d^2}}$	$\frac{bd}{\sqrt{6 (b^2 + d^2)}}$

## PROPERTIES OF VARIOUS SECTIONS—Continued

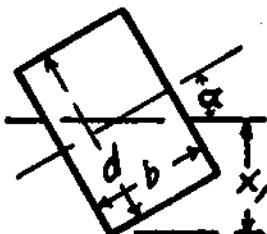
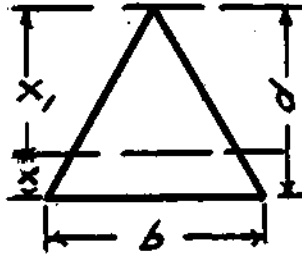
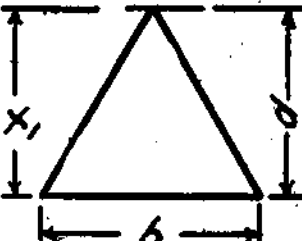
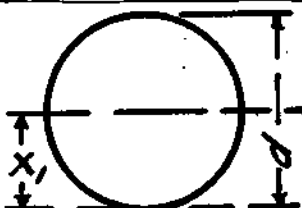
Sections	Area of Section A	Distance from Neutral Axis to Extremities of Section x and x <sub>1</sub>
	bd	$x_1 = \frac{d \cos \alpha + b \sin \alpha}{2}$
	$\frac{bd}{3}$	$x = \frac{d}{3}$ $x_1 = \frac{2d}{3}$
	$\frac{bd}{2}$	$x = d$
	$\frac{\pi d^2}{4} = .785d^2$	$x_1 = \frac{d}{2}$

PROPERTIES OF VARIOUS SECTIONS—Continued

Moment of Inertia $I$	Section Modulus $S = \frac{I}{x}$	Radius of Gyration $r = \sqrt{\frac{I}{A}}$
$\frac{bd}{12} (d^3 \cos^2 \alpha + b^3 \sin^2 \alpha)$	$\frac{db}{6} \left( \frac{d^3 \cos^2 \alpha + b^3 \sin^2 \alpha}{d \cos \alpha + b \sin \alpha} \right)$	$\sqrt{\frac{d^3 \cos^2 \alpha + b^3 \sin^2 \alpha}{12}}$
$\frac{bd^3}{36}$	$\frac{bd^2}{24}$	$\frac{d}{\sqrt{18}} = .386d$
$\frac{bd^3}{12}$	$\frac{bd^2}{12}$	$\frac{d}{\sqrt{6}} = .408d$
$\frac{wd^4}{64} = .049d^4$	$\frac{wd^3}{32} = .008d^3$	$\frac{d}{4}$

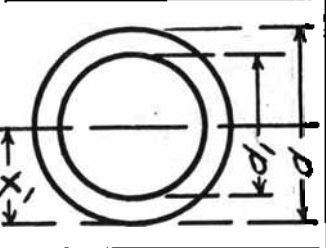
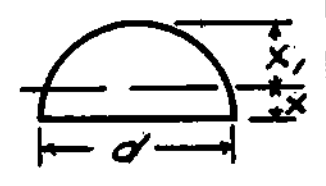
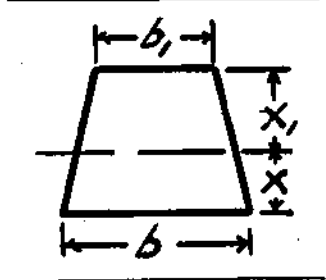
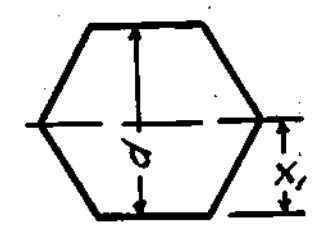

## PROPERTIES OF VARIOUS SECTIONS—Continued

Sections	Area of Section A	Distance from Neutral Axis to Extremities of Section x and x <sub>1</sub>
	$\frac{\pi(d^2 - D^2)}{4} = .785(D^2 - d^2)$	$x = \frac{d}{2}$
	$\frac{\pi d^2}{8} = .393d^2$	$x = \frac{2d}{3\pi} = .212d$ $x_1 = \frac{(3\pi - 4)d}{6\pi} = .288d$
	$\frac{b + b_1}{2} \cdot d$	$x = \frac{b + 2b_1}{b + b_1} \cdot \frac{d}{3}$ $x_1 = \frac{b_1 + 2b}{b + b_1} \cdot \frac{d}{3}$
	$\frac{3}{2} D^2 \tan 30^\circ = .866D^2$	$x = \frac{d}{2}$

PROPERTIES OF VARIOUS SECTIONS—Continued

Moment of Inertia $I$	Section Modulus $S = \frac{I}{x_1}$	Radius of Gyration $r = \sqrt{\frac{I}{A}}$
$\frac{\pi (d^4 - d_1^4)}{64} = .049 (d^4 - d_1^4)$	$\frac{\pi (d^4 - d_1^4)}{32 d} = .008 \frac{(d^4 - d_1^4)}{d}$	$\frac{\sqrt{d^4 + d_1^4}}{4}$
$\frac{9\pi^2 - 64}{1152\pi} \cdot d^4 = .007d^4$	$\frac{9\pi^2 - 64}{192 (3\pi - 4)} \cdot d^3 = .004d^3$	$\frac{\sqrt{9\pi^2 - 64}}{12\pi} \cdot d = .132d$
$\frac{b^4 + 4bb_1 + b_1^4}{36 (b + b_1)} \cdot d^3$	$\frac{b^4 + 4bb_1 + b_1^4}{12 (b_1 + 2b)} \cdot d^3$	$\frac{d}{6(b+b_1)} \sqrt{2(b^4 + 4bb_1 + b_1^4)}$
$\frac{A}{12} \left[ \frac{d^4 (1 + 2 \cos^2 30^\circ)}{4 \cos^2 30^\circ} \right]$ $= .06d^4$	$\frac{A}{6} \left[ \frac{d (1 + 2 \cos^2 30^\circ)}{4 \cos^2 30^\circ} \right]$ $= .12d^3$	$\frac{d}{4 \cos 30^\circ} \sqrt{\frac{1 + 2 \cos^2 30^\circ}{3}}$ $= .264d$

## PROPERTIES OF VARIOUS SECTIONS—Continued

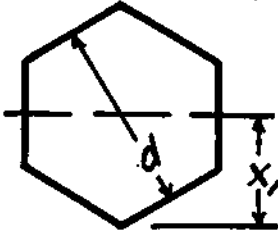
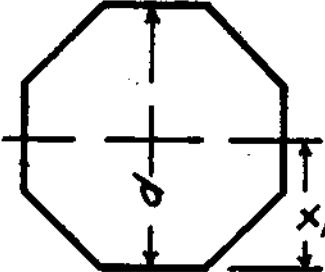
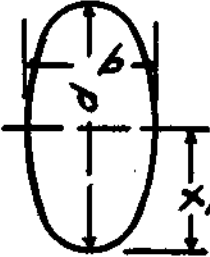
Sections	Area of Section A	Distance from Neutral Axis to Extremities of Section x and x <sub>1</sub>
	$\frac{3}{2} d^2 \tan 30^\circ = .866d^2$	$x_1 = \frac{d}{2 \cos 30^\circ} = .577d$
	$2d^2 \tan 22\frac{1}{2}^\circ = .838d^2$	$x_1 = \frac{d}{2}$
	$\frac{\pi bd}{4} = .785 bd$	$x_1 = \frac{d}{4}$

PROPERTIES OF VARIOUS SECTIONS—Continued

Moment of Inertia I	Section Modulus $S = \frac{I}{x}$	Radius of Gyration $r = \sqrt{\frac{I}{A}}$
$\frac{A}{12} \left[ \frac{d^3 (1 + 2 \cos^2 30^\circ)}{4 \cos^3 30^\circ} \right]$ $= .066d^3$	$\frac{A}{6} \left[ \frac{d (1 + 2 \cos^2 30^\circ)}{4 \cos 30^\circ} \right]$ $= .104d^2$	$\frac{d}{4 \cos 30^\circ} \sqrt{\frac{1 + 2 \cos^2 30^\circ}{3}}$ $= .264d$
$\frac{A}{12} \left[ \frac{d^3 (1 + 2 \cos^2 22\frac{1}{2}^\circ)}{4 \cos^3 22\frac{1}{2}^\circ} \right]$ $= .066d^3$	$\frac{A}{6} \left[ \frac{d (1 + 2 \cos^2 22\frac{1}{2}^\circ)}{4 \cos 22\frac{1}{2}^\circ} \right]$ $= .100d^2$	$\frac{d}{4 \cos 22\frac{1}{2}^\circ} \sqrt{\frac{1 + 2 \cos^2 22\frac{1}{2}^\circ}{3}}$ $= .287d$
$\frac{wb^3}{64} = .0486b^3$	$\frac{wb^2}{32} = .0086b^2$	$\frac{d}{4}$

## PROPERTIES OF VARIOUS SECTIONS—Continued

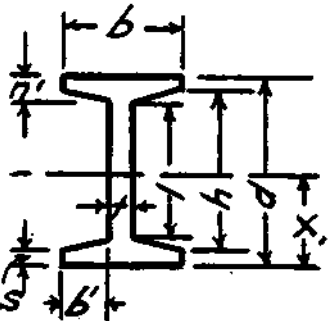
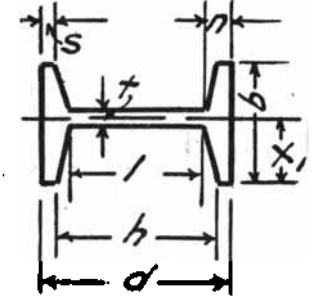
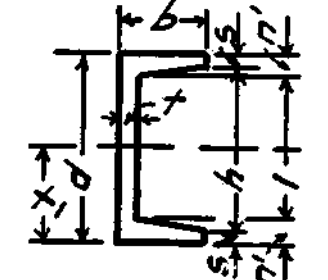
Sections	Area of Section A	Distance from Neutral Axis to Extremities of Section x and x <sub>1</sub>
	$td + 2b'(n + n')$	$x = \frac{d}{2}$
	$td + 2b'(n + n')$	$x = \frac{b}{2}$
	$td + b'(n + n')$	$x = \frac{d}{2}$

## PROPERTIES OF VARIOUS SECTIONS—Continued

Moment of Inertia $I$	Second Modulus $S = \frac{I}{x_1}$	Radius of Gyration $r = \sqrt{\frac{I}{A}}$
$\frac{1}{12} \left[ b d^3 - \frac{1}{4g} (b^4 - d^4) \right]$	$\frac{2I}{d}$	$r = \sqrt{\frac{I}{A}}$
$\frac{1}{12} \left[ b^3 (d - b) + b^3 + \frac{b}{4} (b^4 - d^4) \right]$	$\frac{2I}{b}$	$r = \sqrt{\frac{I}{A}}$
$\frac{1}{12} \left[ b d^3 - \frac{1}{8g} (b^4 - d^4) \right]$	$\frac{2I}{d}$	$r = \sqrt{\frac{I}{A}}$

## PROPERTIES OF VARIOUS SECTIONS—Continued

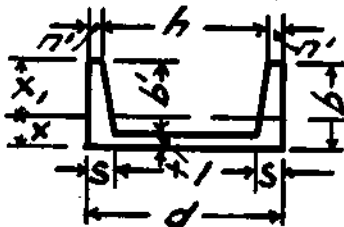
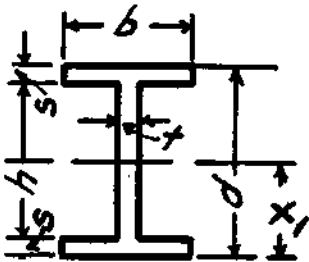
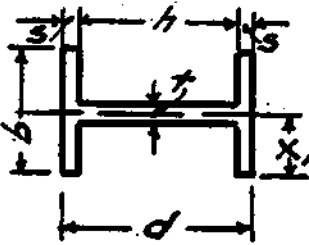
Sections	Area of Section A	Distance from Neutral Axis to Extremities of Section x and z
	$td + b'(g + n)$	$x = \left[ b^2 + \frac{h^2}{2} + \frac{g}{3} (b - t)^2 \right. \\ \left. (b + 2t) \right] + A \\ z = b - x$
	$bd - b(b - t)$	$z = \frac{d}{2}$
	$bd - b(b - t)$	$z = \frac{b}{2}$

## PROPERTIES OF VARIOUS SECTIONS—Continued

Moment of Inertia $I$	Section Modulus $S = \frac{I}{x}$	Radius of Gyration $r = \sqrt{\frac{I}{A}}$
$\frac{1}{3} \left[ 2ab^3 + h^3 + \frac{h}{3} (b^2 - a^2) \right] - Ax^2$	$\frac{I}{b-x}$	$r = \sqrt{\frac{I}{A}}$
$\frac{bd^3 - b^3(b-t)}{12}$	$\frac{bd^3 - b^3(b-t)}{6d}$	$\sqrt{\frac{bd^3 - b^3(b-t)}{12[bd - h(b-t)]}}$
$\frac{2ab^3 + h^3}{12}$	$\frac{2ab^3 + h^3}{6b}$	$\sqrt{\frac{2ab^3 + h^3}{12[bd - h(b-t)]}}$

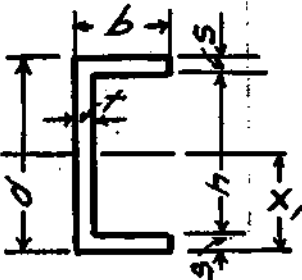
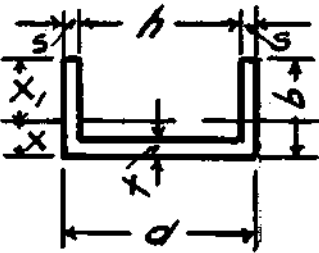
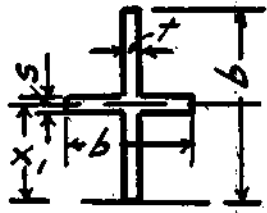

## PROPERTIES OF VARIOUS SECTIONS—Continued

Sections	Area of Section A	Distance from Neutral Axis to Extremities of Section x and x <sub>1</sub>
	$bd - h(b - t)$	$x_1 = \frac{d}{2}$
	$bd - h(b - t)$	$x = \frac{2bs + ht^2}{2A}$ $x_1 = b - x$
	$bd + s(b - t)$	$x_1 = \frac{d}{2}$

PROPERTIES OF VARIOUS SECTIONS—Continued

Moment of Inertia $I$	Section Modulus $S = \frac{I}{x_1}$	Radius of Gyration $r = \sqrt{\frac{I}{A}}$
$\frac{bd^3 - h^3(b-t)}{12}$	$\frac{bd^3 - h^3(b-t)}{6d}$	$\sqrt{\frac{bd^3 - h^3(b-t)}{12[bd - h(b-t)]}}$
$\frac{2ab^3 + ht^3}{3} - Axt$	$\frac{I}{b-x}$	$\sqrt{\frac{I}{A}}$
$\frac{td^3 + s^3(b-t)}{12}$	$\frac{td^3 + s^3(b-t)}{6d}$	$\sqrt{\frac{td^3 + s^3(b-t)}{12[td + s(b-t)]}}$

Copyright

## PROPERTIES OF VARIOUS SECTIONS—Continued

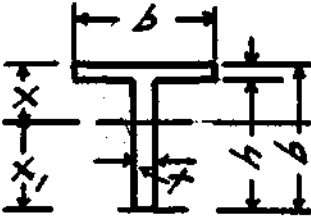
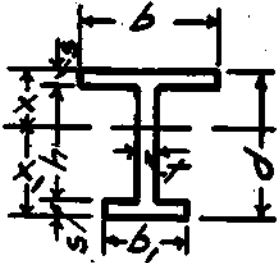
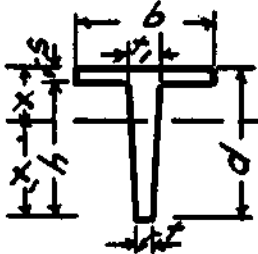
Sections	Area of Section A	Distance from Neutral Axis to Extremities of Section x and $x_1$
	$bt + ht$	$x = \frac{t^2 + t^2(b-t)}{2A}$ $x_1 = d - x$
	$bt + ht + b_1t_2$	$x = \frac{t^2 + t^2(b-t) + t_1(b_1-t_1)(2d-t_1)}{2A}$ $x_1 = d - x$
	$bt + \frac{b(t+t_1)}{2}$	$x = \frac{3bt^2 + 3ht(d+t) + t_1(t_1-t)(h+2t)}{6A}$ $x_1 = d - x$

PROPERTIES OF VARIOUS SECTIONS—Continued

Moment of Inertia $I$	Section Modulus $S = \frac{I}{x_1}$	Radius of Gyration $r = \sqrt{\frac{I}{A}}$
$\frac{bx^3 + bx^3 - (b-t)(x-s)^3}{3}$	$\frac{I}{d-x}$	$\sqrt{\frac{bx^3 + bx^3 - (b-t)(x-s)^3}{3(bs+bt)}}$
$\frac{bx^3 + bx^3 - (b-t)(x-s)^3}{3}$ $\frac{(x-t)(x_1-s)^3}{3}$	$\frac{I}{d-x}$	$\left[ \frac{bx^3 + bx^3 - (b-t)(x-s)^3}{3(bs+bt+bs)} - \frac{(b-t)(x_1-s)^3}{3(bs+bt+bs)} \right]^{1/2}$
$\frac{4bs^3 + h^3(3t+h)}{12} - A(x-s)^3$	$\frac{I}{d-x}$	$\sqrt{\frac{I}{A}}$

George

## SECTION II

### STRENGTH OF MATERIALS

**Stress** is the general term denoting the force or resistance which acts between bodies or parts of a body when under the influence of a load. It is measured either in tons or lb. per square inch of sectional area.

**Strain** is the change in form produced by stress.

**Tension.**—A body is said to be under tension when the action of a force tends to extend it in the direction of its length. Tensile strength is the resistance per unit of surface which the molecular fibers oppose to separation.

**Compression.**—A body is said to be under compression when the action of a force tends to compress it in the direction of its length.

**Shearing Strain.**—A body is said to be subjected to a shearing strain in any cross section when the distorting force acts in the plane of that cross section.

**Elasticity** is the power to resist permanent deformation. The elastic limit is the limit of stress that can be withstood without permanent elongation. The continued application of a stress in excess of the original elastic limit will eventually cause fracture owing to fatigue of the material.

The modulus or coefficient of elasticity is the ratio between the stresses and corresponding strains for a given material. If  $l$  be the strain or increase per unit length of a material subjected to tensile stress, and  $p$  the unit stress producing the elongation, the modulus of elasticity  $E$  is equal to  $\frac{p}{l}$ .

**Modulus of rupture** is the strain at which the molecular fibers cease to hold together.

**Ultimate Strength.**—The load producing rupture gives the strength of a material, and it is usual to denote the strength by the expression  $\frac{\text{breaking load}}{\text{cross section}}$ . In this expression the original cross section is taken before it has been decreased by the stress.

**STRENGTH OF MATERIALS\***  
(Stresses per Square Inch)

Metals and Alloys	Stresses in Thousands of Pounds					Modulus of Elasticity, Lb.	Elongation %
	Tension Ultimate	Elastic Limit	Compression Ultimate	Bending Ultimate	Shearing Ultimate		
Aluminum—							
cast.....	15	6.5	12	.....	12	11,000,000	.....
bars, sheets.....	24-28	12-14	.....	.....	.....	.....	.....
wire annealed.....	20-35	14	.....	.....	.....	.....	.....
Aluminum bronze—							
5% to 12% al.....	75	40	120	.....	.....	.....	.....
10% al.....	85-100	60	.....	.....	.....	.....	.....
Brass—							
17% zinc.....	32.6	6.2	.....	23.2	.....	.....	26.7
30% zinc.....	28.1	6.6	.....	26.6	.....	.....	20.7
cast, common.....	18-24	6	30	20	36	9,000,000	.....
wire annealed.....	50	16	.....	.....	.....	14,000,000	.....
Bronze—							
8% tin.....	28.5	19	42	43.7	.....	10,000,000	5.5
13% tin.....	29.4	26	53	34.6	.....	.....	3.3
24% tin.....	22	22	114	32	.....	.....	.....
gun metal—							
9% copper, 1% tin..	25-55	10	.....	52	.....	10,000,000	.....
manganese, cast—							
10% tin, 2% mang..	60	30	125	.....	.....	.....	.....
manganese, rolled—							
10% tin, 2% mang..	100	80	.....	.....	.....	.....	.....
phosphorus, cast—							
9% tin, 1% phos....	50	24	.....	.....	.....	.....	.....
phosphorus, wire—							
9% tin, 1% phos....	100	.....	.....	.....	.....	.....	.....
tobin, cast—							
38% zinc, 1½% tin,							
½ lead.....	66	.....	.....	.....	.....	.....	.....
tobin, rolled—							
38% zinc, 1½% tin,							
½ lead.....	80	40	.....	.....	.....	4,500,000	.....
Copper—							
cast.....	25	6	40	22	30	10,000,000	.....
plates, rods, bolts.....	32-35	10	32	.....	.....	.....	.....
wire annealed.....	36	10	.....	.....	.....	15,000,000	.....
Delta Metal—							
cast { 55-60% copper }.....	45	.....	.....	.....	.....	.....	.....
plates { 38-40% zinc }.....	68	.....	.....	.....	.....	.....	.....
bars { 2-4% iron }.....	85	.....	.....	.....	.....	.....	.....
wire { 1-2% tin }.....	100	.....	.....	.....	.....	.....	.....

\* Carnegie Steel Co. Handbook



**STRENGTH OF MATERIALS—Continued**  
(Stresses in Pounds per Square Inch)

Building Materials	Ultimate Average Stresses			Modulus of Elasticity	Safe Working Stresses		
	Compression	Tension	Bending		Compression	Bearing	Shearing
<b>Stone—</b>							
bluestone.....	12,000	1,200	2,500	7,000,000	1,200	1,200	200
granite.....	12,000	1,200	1,800	7,000,000	1,200	1,200	200
limestone—marble..	8,000	800	1,500	7,000,000	800	800	150
sandstone.....	5,000	150	1,200	3,000,000	500	500	150
slate.....	10,000	3,000	5,000	14,000,000	1,000	1,000	175
<b>Brick—</b>							
common, good.....	10,000	200	800	.....	.....	.....	.....
pressed and paving..	6,000	.....	.....	.....	.....	.....	.....
<b>Masonry—</b>							
granite.....	.....	.....	.....	.....	420	800	.....
limestone—bluestone.	.....	.....	.....	.....	350	500	.....
sandstone.....	.....	.....	.....	.....	280	400	.....
rubble.....	.....	.....	.....	.....	140	250	.....
concrete 1, 2½, 5..	.....	.....	.....	.....	280	500	.....
brick, common.....	.....	.....	.....	.....	168	300	.....
<b>Miscellaneous—</b>							
glass, common.....	30,000	3,000	3,000	8,000,000	.....	.....	.....
plaster.....	700	70	.....	.....	.....	.....	.....
terra cotta.....	5,000	.....	.....	.....	.....	.....	.....
<b>Concrete—</b>							
1, 2½, 5, hard stone..	1,700	.....	.....	.....	.....	.....	.....
soft stone.....	1,200	.....	.....	.....	.....	.....	.....
cinders.....	500	.....	.....	.....	.....	.....	.....

**REINFORCED CONCRETE—SAFE WORKING STRESSES**

**Elastic Modulus—**

2,000,000 if ultimate compression is up to 2,200.

2,500,000 if ultimate compression is over 2,200.

3,000,000 if ultimate compression is over 2,900.

**Compression—**

22.5% of ultimate compression on piers or columns of lengths not exceeding 12 ins.

**Bearing—**

32.5% of ultimate compression on surfaces of at least twice the loaded area.

**Shearing—**

2% of ultimate compression, horizontal bars.

3% for reinforcement with bent up bars.

6% for thoroughly reinforced webs.

**Bond—**

4% of ultimate compression for plain bars.

2% for drawn wire.

**Working Stress: Factor of Safety.**—The stress allowed under working conditions is only a fraction of the ultimate strength and is called the working stress. The factor of safety is that number which is divided into the ultimate strength to arrive at the working stress. Thus working stress =  $\frac{\text{ultimate strength}}{\text{factor of safety}}$ . The factor of safety depends to a great extent on the nature of the forces acting and on the material.



TIMBER

Seasoned timber, moisture 12 per cent and under: Stresses given in pounds per square inch

	Ultimate Resistance to Tension	Ultimate Resistance to Compression Length	Ultimate Resistance to Compression	Ultimate Resistance to Shear Length	Ultimate Resistance to Shear Cross	Elastic Limit	Modulus of Elasticity	Modulus of Ultimate Bending	Modulus of Elastic Bending	Ordinary Working Stresses			Weight in Pounds per Cu. Ft.		
										Tension	Compression			Tension	Trans.
											Tension	Trans.			
Ash (American)	17,000	7,200	1,900	1,100	6,260	7,900	1,640,000	10,800	7,900	2,000	1,000	1,200	39		
Birch	15,000	8,000	.....	.....	5,600	.....	1,645,000	11,700	.....	2,000	1,000	1,200	33		
Bor	20,000	10,200	.....	.....	.....	.....	.....	.....	.....	2,500	1,200	1,500	70		
Cedar (White)	.....	5,200	700	400	1,370	5,800	910,000	6,300	5,800	1,200	600	800	23		
Cedar (Am. Red)	10,800	6,000	.....	.....	.....	.....	.....	7,200	.....	1,400	700	900	.....		
Chestnut	11,500	5,300	.....	.....	1,530	.....	1,140,000	8,100	.....	1,400	600	900	41		
Cottonwood (see Poplar)	.....	.....	.....	.....	.....	.....	.....	.....	.....	.....	.....	.....	.....		
Douglas Spruce (Oregon Pine)	13,000	6,700	800	500	.....	6,400	1,680,000	7,900	6,400	1,400	700	1,000	32		
Fir	13,000	.....	.....	1,300	.....	.....	1,580,000	.....	.....	.....	.....	.....	37		
Hemlock	8,700	6,700	.....	400	2,750	.....	.....	7,100	.....	.....	.....	750	25		
Hickory (Am. average)	19,600	9,500	2,700	1,100	6,000	11,200	2,380,000	16,000	11,000	2,000	1,200	1,800	50		
Lignum Vitae	11,800	9,900	.....	.....	.....	.....	.....	11,700	.....	1,500	1,200	1,500	83		
Mahogany (Spanish)	14,900	8,200	.....	.....	.....	.....	1,255,000	9,550	.....	1,500	1,200	1,500	53		
Maple	11,150	7,150	1,800	500	6,350	.....	.....	10,000	.....	.....	.....	.....	49		
Oregon Pine (see Douglas Spruce)	.....	.....	.....	.....	.....	.....	.....	.....	.....	.....	.....	.....	.....		
Oak (Red)	10,250	7,200	2,300	1,100	.....	9,200	1,970,000	11,400	9,200	1,400	900	1,200	45		
Oak (White)	13,600	8,500	2,200	1,000	4,400	9,600	2,050,000	13,100	9,600	1,700	1,000	1,500	50		
Oak (Live)	.....	10,400	.....	.....	8,480	9,040	1,851,500	11,300	.....	.....	.....	.....	71		
Pine (Southern Yellow Long Leaf)	13,000	8,000	1,260	835	5,600	10,000	2,070,000	12,600	9,500	1,600	1,000	1,500	38		
Pine (White)	10,000	5,400	700	400	2,500	6,400	1,380,000	7,900	6,400	1,200	700	900	24		
Poplar	7,000	5,000	.....	.....	.....	.....	.....	6,500	.....	900	600	750	30		
Spruce (Northern)	11,000	6,000	.....	400	3,250	.....	1,400,000	8,000	.....	.....	.....	.....	25		
Spruce Pine	12,000	7,200	1,200	800	.....	8,400	1,640,000	10,000	8,400	1,200	700	900	30		
Walnut (Black)	10,500	7,500	2,500	.....	4,700	5,700	1,306,000	8,000	.....	1,000	1,000	900	38		

Author not known.

## FACTORS OF SAFETY

Material	Steady Load	Load Varying from Zero to Maximum in One Direction	Load Varying from Zero to Maximum in Both Directions	Suddenly Varying Loads and Shocks
Cast iron.....	6	10	15	20
Wrought iron.....	4	6	8	12
Steel.....	5	6	8	12
Wood.....	8	10	15	20
Brick.....	15	20	25	30
Stone.....	15	20	25	30

Hemp rope for running rigging factor of safety 8-9

Steel rope for running rigging factor of safety 6-7

Steel rope for standing rigging factor of safety 5-6

## BEAMS

The strength of a beam depends on the form of its cross section, how the load is distributed and on the way the beam is supported. In the majority of cases in ship construction beams are fixed at both ends, although some fixed at one end occur in fittings as bitts, davits, etc.

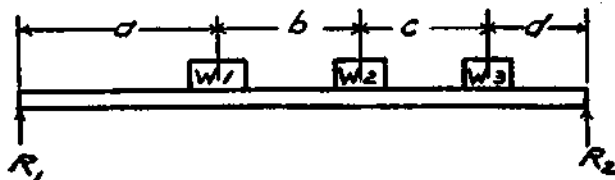

Figure 11

When a beam is loaded there is always compression in the top-most fibers and tension in the bottom. There is a position in the cross section at which the fibers are neither in compression nor tension, and this position is the neutral axis of the section. Thus the neutral axis passes through the center of gravity of every cross section and is at right angles to the direction in which the load acts.

The algebraic sum of the moments of the external forces about any point in a beam is the bending moment at that point; that is, the bending moment at any point is the moment about that point of either reaction minus the sum of the moments of the intermediate loads about the same point. The bending moments at several points on the beam shown in Fig. 11 are: at  $W_1 = R_1 a$ , at  $W_2 = R_1 (a + b) - W_1 b$ , at  $W_3 = R_1 (a + b + c) - [W_2 c + W_1 (b + c)]$ . Various methods of loading are shown under Bending Moments of Beams.

Fibers which are at equal distances from the neutral axis will be deformed to the same extent. The resistance to bending is the combination of the resistances to tension and compression. Thus let

$M$  = bending moment

$y$  = distance from the outermost fiber to the neutral axis

$I$  = moment of inertia of the section

$p$  = safe or allowable unit fiber stress in pounds per square inch

$$\text{Then } \frac{p}{y} = \frac{M}{I} \text{ or } p = \frac{My}{I} \text{ or } M = \frac{pI}{y}$$

and  $\frac{I}{y}$  the section modulus =  $s$ . The moment of resistance  $M_1$  of a beam is the sum of the moments about the neutral axis of all the stresses in the fibers composing the section. Hence  $M_1 = s p$ ; that is, the safe resisting moment is equal to the safe fiber stress multiplied by the resistance.

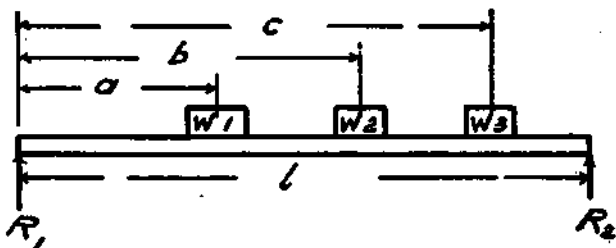

Figure 12

The reactions or supporting forces of a beam must equal the load on it. If the load on a beam is uniformly distributed, applied at the center of the span or symmetrically placed and of equal amount on each side of the center, the reactions  $R_1$  and  $R_2$  will each be equal to one half the load. When the load is not symmetrically placed, the reactions are found by the principle of moments.

Suppose a beam as in Fig. 12 is supporting loads  $W_1$ ,  $W_2$  and  $W_3$ ,  $l$  the span or distance between the reactions  $R_1$  and  $R_2$ ,  $a$ ,  $b$ , and  $c$  the distances from the reaction  $R_1$  to the loads  $W_1$ ,  $W_2$  and  $W_3$ .

Then the right-hand reaction  $R_2 = \frac{(W_1 \times a) + (W_2 \times b) + (W_3 \times c)}{l}$ .

Hence to find the reaction at either support, multiply each load by its distance from the other support, and divide the sum of these products by the distance between supports. Since the sum of the reactions must equal the sum of the loads, if one reaction is found the other can be obtained by subtracting the known one from the sum of the loads.

The loads and reactions, besides causing bending or flexure, create shearing stresses in the beam by their opposing tendency; that is, as the reactions act upward, and the loads downward, the effect is to shear the fibers of the beam vertically. At any section, the shear is equal to either reaction minus the sum of the loads between that reaction and the section considered. The maximum shear is always equal to the greatest reaction. For a single beam with a uniformly distributed load, the maximum shear is at the supports, and is equal to one half the load or the reaction; the shear changes at every point of the loaded length, the minimum shear being zero at the center of the span. The maximum shear in a simple beam having a single load (omitting weight of beam) concentrated at the center is equal to one half the load, and is uniform throughout the beam. When a beam supports several concentrated loads, changes in the amount of shear occur only at the points where the loads are applied.

*Examples.* What is the greatest safe load that can be lifted by a boat davit having an outreach of 5 ft. and a diameter of 7 ins. The davit is of wrought iron.

This is a case of a beam with one end fixed and with the load at the other, hence the bending moment is  $M = W \times L$ , where  $L$  is the outreach of the davit or 5 ft.

From the beam formula  $M = \frac{p \times I}{y}$

$p$  = safe load for wrought iron = 5 tons

$L$  = 5 ft.  $\times$  12 ins. = 60 ins.

$I$  = section modulus =  $S$

$y$  = diameter = 7 ins.

$d$  = diameter = 7 ins.

$$W \times L = p \times \frac{I}{y}$$

$$\text{Hence } W = \frac{p \times S}{L} = \frac{5 \text{ tons} \times \frac{\pi d^3}{32}}{60} = 2\frac{1}{2} \text{ tons. See also formula for}$$

Boat Davit.

Find the safe resisting moment of a Northern yellow-pine beam 10 ins. wide by 12 ins. deep, using a factor of safety of 4.

Here  $M_1 = S p$ .

The section modulus  $S$  (see table) is  $\frac{bd^2}{6}$  or  $\frac{10 \times 12 \times 12}{6} = 240$

The modulus of rupture for Northern yellow pine is 6,000 lb.

The desired factor of safety being 4, the safe unit stress  $p = \frac{6,000}{4} = 1,500$  lb.

Substituting these values in the formula, safe resisting moment  $M_1 = S p$ , we have  $1,500 \times 240 = 360,000$  as the safe resisting moment of the beam section in inch pounds.

[Above paragraph contains abstracts from Building Trade Handbook, Int. School of Correspondence.]

## BEAMS UNDER VARIOUS LOADING CONDITIONS

[From Pocket Companion, Carnegie Steel Co.]

### Bending Moments and Deflections

#### *Notation in Formulae*

- $A$  = area of section in square inches  
 $y$  = distance from center line of gravity to extreme fiber in inches  
 $I$  = moment of inertia about center line of gravity in inches<sup>4</sup>  
 $s$  = section modulus =  $\frac{I}{y}$  in inches<sup>3</sup>  
 $r$  = radius of gyration =  $\sqrt{\frac{I}{A}}$  in inches  
 $f$  = bending stress in extreme fiber in pounds per square inch  
 $E$  = modulus of elasticity in pounds per square inch  
 $l$  = length of section in inches  
 $d$  = depth of section in inches  
 $b$  = breadth of section in inches  
 $t$  = thickness of section in inches  
 $W, W_1, W_2$  = superimposed loads supported by beam in pounds  
 $w$  = superimposed loads in pounds per unit length or area  
 $W$  max. = maximum safe load at point given in pounds  
 $R, R_1$  = reactions at points of support in pounds  
 $M, M_1, M_2$  = bending moments at points given in inch pounds  
 $M$  max. = maximum bending moment in inch pounds  
 $D, D_1$  = deflections at points given in inches  
 $D$  max. = maximum deflection at point given in inches

## 1. Cantilever Beam.—Concentrated load at free end.

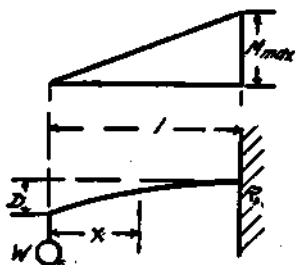

$R_1$ (max. shear)	=	$W$
$M$ , distance $x$	=	$Wx$
$M$ max. at $R_1$	=	$Wl$
$W$ max.	=	$\frac{fs}{l}$
$D$ max.	=	$\frac{Wl^3}{3EI}$

## 2. Cantilever Beam.—Uniformly distributed load.

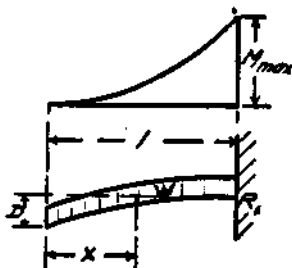

$R_1$ (max. shear)	=	$W$
$M$ , distance $x$	=	$\frac{Wx^2}{2l}$
$W$ max.	=	$\frac{2fs}{l}$
$D$ max.	=	$\frac{Wl^3}{8EI}$

## 3. Cantilever Beam.—Load increasing uniformly to fixed end.

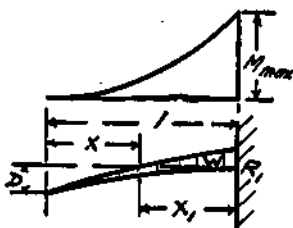

$R_1$ (max. shear)	=	$W$
$M$ , distance $x$	=	$\frac{Wx^2}{3l}$
$M$ max. at $R_1$	=	$\frac{Wl}{3}$
$W$ max.	=	$\frac{3fs}{l}$
$D$ max.	=	$\frac{Wl^3}{15EI}$

## 4. Beam Supported at Ends.—Concentrated load near one end.

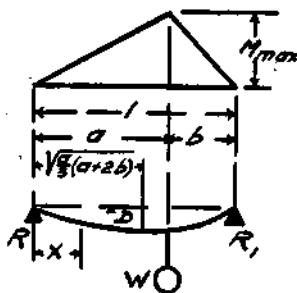

$$R \text{ (max. shear if } b > a) = \frac{Wb}{l}$$

$$R_1 \text{ (max. shear if } a > b) = \frac{Wa}{l}$$

$$M, \text{ distance } x = \frac{Wbx}{l}$$

$$M \text{ max. at point of load} = \frac{Wab}{l}$$

$$W \text{ max.} = \frac{fs}{ab}$$

$$D \text{ max.} = \frac{Wab(a+2b)\sqrt{3a(a+2b)}}{27EI}$$

## 5. Beam Supported at Ends.—Concentrated load at center.

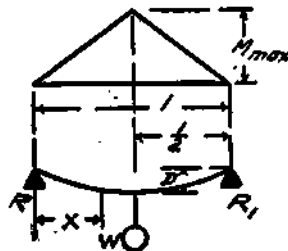

$$R \text{ (max. shear)} = R_1 = \frac{W}{2}$$

$$M, \text{ distance } x = \frac{Wx}{2}$$

$$M \text{ max. at point of load} = \frac{Wl}{4}$$

$$W \text{ max.} = \frac{4fs}{l}$$

$$D \text{ max.} = \frac{Wl^3}{48EI}$$

## 6. Beam Supported at Ends.—Two unsymmetrical concentrated loads.

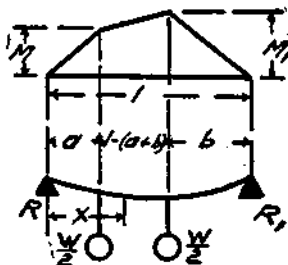

$$R \text{ (max. shear if } a < b) = \frac{W}{2l}(l-a+b)$$

$$R_1 = \frac{W}{2l}(l+a-b)$$

$$M, \text{ distance } a = R_2a = \frac{Wa}{2l}(l-a+b)$$

$$M_1 \text{ max. distance } b (b > a) = R_1b = \frac{Wb}{2l}(l+a-b)$$

$$M_2, \text{ distance } x = R_2x - \frac{W}{2}(x-a)$$

$$W \text{ max. } (b > a) = \frac{2lfs}{b(l+a-b)}$$

## 7. Beam Supported at Ends.—Two symmetrical loads.

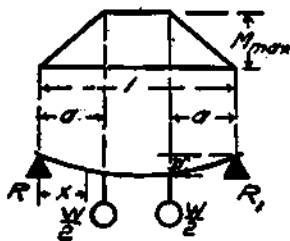

$$R \text{ (max. shear)} = R_1 = \frac{W}{2}$$

$$M, \text{ distance } x = \frac{Wx}{2}$$

$$M \text{ max. at and between loads} = \frac{Wa}{2}$$

$$W \text{ max.} = \frac{2fs}{a}$$

$$D \text{ max.} = \frac{W a^3}{12 E I} (3\beta - a^2)$$

## 8. Beam Supported at Ends.—Three concentrated loads

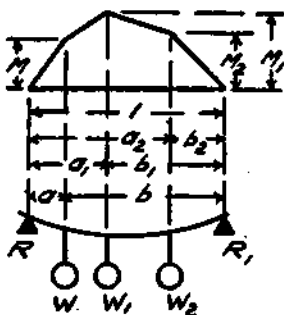

$$R = \frac{Wb + W_1 b_1 + W_2 b_2}{l}$$

$$R_1 = \frac{W a + W_1 a_1 + W_2 a_2}{l}$$

$$M \text{ at } W = R a$$

$$M \text{ max. if } W = \text{or } > E$$

$$M \text{ at } W_1 = R a_1 - W (a_1 - a)$$

$$M \text{ max. if } W_1 + W = R \text{ or } > R$$

$$M \text{ max. if } W_1 + W_2 = R_1 \text{ or } > R_1$$

$$M \text{ at } W_2 = R a_2 - W (a_2 - a) - W_1 (a_2 - a_1)$$

$$M \text{ max. if } W_2 = R_1 \text{ or } > R_1$$

## 9. Beam Supported at Ends.—Uniformly distributed load.

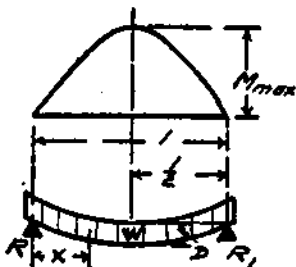

$$R \text{ (max shear)} = R_1 = \frac{W}{2}$$

$$M, \text{ distance } x = \frac{Wx}{2} \left( 1 - \frac{x}{l} \right)$$

$$M \text{ max. at center} = \frac{Wl}{8}$$

$$W \text{ max.} = \frac{8fs}{l}$$

$$D \text{ max.} = \frac{5 W l^3}{384 E I}$$



10. Beam Supported at Ends.—Load increasing uniformly to one end.

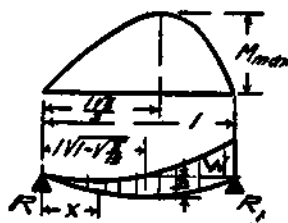

$$R = \frac{W}{3}$$

$$R_1 \text{ (max. shear)} = \frac{2W}{3}$$

$$M, \text{ distance } x = \frac{Wx}{3} \left( 1 - \frac{x^2}{l^2} \right)$$

$$M \text{ max. distance } \frac{l\sqrt{3}}{3} = \frac{2Wl}{9\sqrt{3}}$$

$$W \text{ max.} = \frac{27fs}{2l\sqrt{3}}$$

$$D \text{ max.} = \frac{.013044 W l^3}{EI}$$

11. Beam Supported at Ends.—Load decreasing uniformly to center.

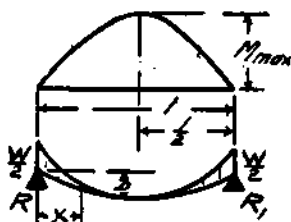

$$R \text{ (max. shear)} = R_1 = \frac{W}{2}$$

$$M, \text{ distance } x = Wx \left( \frac{1}{2} - \frac{x}{l} + \frac{2x^2}{3l^2} \right)$$

$$M \text{ max. distance } \frac{l}{12} = \frac{Wl}{12}$$

$$W \text{ max.} = \frac{12fs}{l}$$

$$D \text{ max.} = \frac{3Wl^3}{320EI}$$

12. Beam Supported at Ends.—Load increasing uniformly to center.

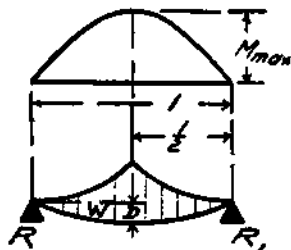

$$R \text{ (max. shear)} = R_1 = \frac{W}{2}$$

$$M, \text{ distance } x = Wx \left( \frac{1}{2} - \frac{2x^2}{3l^2} \right)$$

$$M \text{ max. distance } \frac{l}{6} = \frac{Wl}{6}$$

$$W \text{ max.} = \frac{6fs}{l}$$

$$D \text{ max.} = \frac{Wl^3}{60EI}$$

13. Beam Supported at Ends.—Uniform load partially distributed.

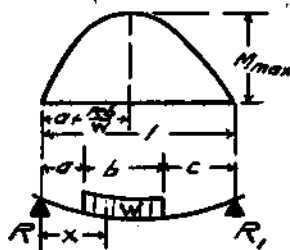

$$R \text{ (max. shear if } a < c) = \frac{W(2c+b)}{2l}$$

$$R_1 = \frac{W(2a+b)}{2l}$$

$$M, \text{ distance } x = a \text{ or } < a = Rx$$

$$M_1, \text{ distance } x > a = Rx - \frac{W(x-a)^2}{2b}$$

$$M_2, \text{ distance } x > (a+b) = Rx - \frac{W(2x-2a-b)}{2}$$

$$M \text{ max. distance } a + \frac{Rb}{W} = \frac{W(2c+b)[4al+b(2c+b)]}{8l^2}$$

$$W \text{ max.} = \frac{8l^2 f_s}{(2c+b)[4al+b(2c+b)]}$$

14. Beam Supported at Ends.—Uniform load partially discontinuous.

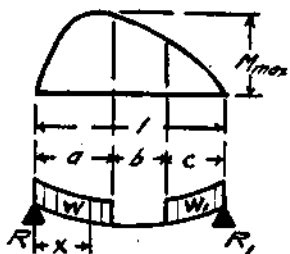

$$R \text{ (max. shear if } W > W_1) = \frac{W(2l-a) + W_1 c}{2l}$$

$$R_1 = \frac{W_1(2l-c) + W a}{2l}$$

$$M, \text{ distance } x < a = Rx - \frac{Wx^2}{2a}$$

$$M_1, \text{ distance } x > a = Rx - \frac{W(2x-a)}{2}$$

$$M \text{ max. distance } x = \frac{2W a l - W a^2 + W_1 c a}{2W l}$$

$$\text{and } W a > W_1 c = \frac{R^2 a}{2W}$$

$$W \text{ max.} = \frac{R^2 a}{2 f_s}$$

15. Beam Continuous over Two Supports.—Two exterior symmetrical loads.

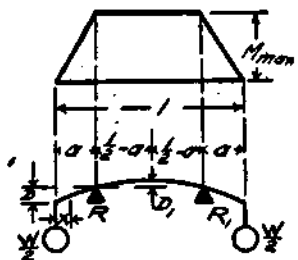

$$R \text{ (max. shear)} = R_1 = \frac{W}{2}$$

$$M, \text{ distance } x = \frac{Wx}{2}$$

$$M \text{ max. from } R \text{ to } R_1 = \frac{W a}{2}$$

$$W \text{ max.} = \frac{2 f_s a}{a}$$

$$D, \text{ distance } a = \frac{W a (3al - 4a^2)}{12 E I}$$

$$D_1, \text{ distance } \frac{l}{2} - a = \frac{W a (l - 2a)^2}{16 E I}$$

16. Beam Continuous over Two Supports.—Uniformly distributed load.

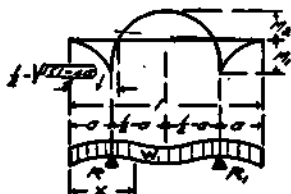

$$R = R_1 = \frac{W}{2}, \text{ max. shear}$$

$$M, \text{ distance } x = \frac{W a}{l} \text{ or } \frac{W}{l} \left( \frac{l}{2} - a \right)$$

$$= 0 \text{ if } x = \frac{l}{2} = \sqrt{\frac{l(l-4a)}{4}}$$

$$M_1 \text{ at } E \text{ and } R_1 = \frac{W a^2}{2l}$$

$$\text{max. if } a > l(\sqrt{\frac{1}{2}} - \frac{1}{2})$$

$$M_2 \text{ at center} = \frac{W(l-4a)}{8}$$

$$\text{max. if } a < l(\sqrt{\frac{1}{2}} - \frac{1}{2})$$

$$W_1 \text{ max.} = \frac{2l f a}{a^2}$$

$$\text{max. if } a > l(\sqrt{\frac{1}{2}} - \frac{1}{2})$$

$$W_2 \text{ max.} = \frac{8 f a}{l - 4a}$$

$$\text{max. if } a < l(\sqrt{\frac{1}{2}} - \frac{1}{2})$$

**Deflection.**—Formula for deflection is given in section on Beams under Various Loading Conditions. The depth of rolled steel beams should not be less than  $\frac{1}{12}$  of the span, and plate girders not less than  $\frac{1}{12}$ .

### COLUMNS

It was formerly assumed that the strength of a column depended largely on the condition of its ends. Many engineers now make no difference in their calculations for round-ended, pin-ended and square-ended columns. Usual factor of safety 5 or 6.

Below are formulæ for calculating the strength of columns:\*

(1) *Steel Columns.*

$P$  = total centrally applied load on column in pounds, including proper allowance for impact

$A$  = minimum area of cross sections in square inches

$l$  = total length of column in inches

$r$  = its least radius of gyration

Then for steel columns of ordinary length where  $l/r$  does not exceed 120 for the principal members, or 150 for the secondary members, and where  $P/A$  does not exceed 14,000 lb.

$$P = A \left( 16,000 - 70 \frac{l}{r} \right)$$

\* Formulæ from Electrical Engineer's Handbook.

(2) *Cast Iron Columns.*

$d$  = diameter of circular column or shortest side of rectangular column in inches

$\frac{l}{d}$  not to exceed 40

$$P = A \left( 6,100 - 32 \frac{l}{d} \right)$$

(3) *Timber Columns.*

Long-leaf yellow pine  $P = A \left[ 1300 \left( 1 - \frac{l}{60d} \right) \right]$

Short-leaf pine and spruce  $P = A \left[ 1100 \left( 1 - \frac{l}{60d} \right) \right]$

Or if  $p$  is taken as the ultimate load in pounds per square inch, then the safe load for a given section may be obtained by multiplying the value of  $p$  as found from the formulæ given below,\* by the area of the section and dividing by the factor of safety.

Steel column with both ends fixed or resting on flat supports.

$$p = \frac{50000}{1 + \frac{l^2}{36000 r^2}}$$

Steel column with one end fixed and resting on flat supports and the other end round or hinged.

$$p = \frac{50000}{1 + \frac{l^2}{24000 r^2}}$$

Steel column with both ends round or hinged.

$$p = \frac{50000}{1 + \frac{l^2}{18000 r^2}}$$

Cast iron columns solid with both ends fixed or resting on flat supports,  $d$  = diameter of column.

$$p = \frac{80000}{1 + \frac{l^2}{800 d^2}}$$

\* From Machinery's Handbook.

## COLUMNS OF H AND I SECTIONS\*

(Safe loads in thousands of lbs.)

Allowable fiber stress per square inch, 13,000 lb. for lengths of 60 radii or under; reduced for lengths over 60 radii.

Effective Length in Feet	DEPTH AND WEIGHT OF SECTIONS												
	H				I								
	8-in.	6-in.	5-in.	4-in.	15-in.	12-in.	10-in.	9-in.	8-in.	7-in.	6-in.	5-in.	4-in.
	34 lb. per ft.	23.8 lb.	18.7 lb.	13.6 lb.	42 lb. per ft.	31½ lb.	25 lb.	21 lb.	18 lb.	15 lb.	12¼ lb.	9¾ lb.	7¼ lb.
2	130.	91.	71.5	52.	162.2	120.4	95.8	82.	69.3	57.5	46.9	37.3	28.7
3	130.	91.	71.5	52.	162.2	120.4	95.8	82.	69.3	57.5	46.9	37.3	28.5
4	130.	91.	71.5	52.	162.2	120.4	95.8	82.	69.3	56.8	44.5	33.3	24.
5	130.	91.	71.5	50.7	162.2	120.4	94.4	77.8	63.2	50.	38.5	28.	19.5
6	130.	91.	71.5	45.7	153.9	109.9	85.3	69.4	55.6	43.2	32.5	22.7	15.2
7	130.	91.	66.	40.6	140.1	98.9	76.2	61.	48.	36.4	26.5	18.8	13.
8	130.	86.7	60.5	35.6	126.2	87.9	67.1	52.6	40.4	30.3	22.9	16.1	10.8
9	130.	80.9	55.	30.5	112.3	76.9	58.	44.2	35.	26.9	19.9	13.5	8.5
10	125.8	75.1	49.5	26.7	98.5	65.9	50.2	40.	31.2	23.5	16.8	10.8	
11	119.4	69.3	44.	24.2	86.	59.9	45.7	35.8	27.4	20.1	13.8		
12	113.	63.5	38.5	21.7	79.	54.4	41.1	31.5	23.6	16.7	10.8		
13	106.6	57.7	35.8	19.2	72.1	48.9	36.5	27.3	19.8	13.3			
14	100.2	51.9	33.	16.6	65.2	43.4	32.	23.1	16.				
15	93.8	47.6	30.3	14.1	58.2	37.9	27.4	18.9					
16	87.3	44.7	27.5		51.3	32.4	22.9						
17	80.9	41.8	24.8		44.4	26.9							
18	74.5	38.9	22.		37.4								
19	69.	36.	19.3										
20	65.8	33.1	16.5										
Area in sq. in.	10.	7.	5.5	4.	12.48	9.26	7.37	6.31	5.33	4.42	3.61	2.87	2.21

Safe load values above upper zigzag line are for ratios of  $\frac{l}{r}$  not over 60, those between the zigzag lines are for ratios up to 120 and those below lower zigzag line for ratios over 200.

\* Carnegie Steel Co. Pocket Companion.

Cast iron column, hollow, round, both ends fixed or resting on flat supports,  $d$  = outside diameter of column.

$$p = \frac{80000}{1 + \frac{P}{800 d^2}}$$

Cast iron column, hollow, square, with both ends fixed or resting on flat supports,  $S$  = outside dimension of square.

$$p = \frac{80000}{1 + \frac{P}{1000 S^2}}$$

For square wood columns with flat supports, the side of the square being  $S$ ,

$$p = \frac{5000}{1 + \frac{P}{250 S^2}}$$

SQUARE WOODEN COLUMNS

(Safe loads in thousands of pounds)

*America Railway Engineering Association Formulae*

LONG-LEAF PINE—WHITE OAK—1,300  $\left(1 - \frac{l}{60d}\right)$

Length Feet	Side of Square (Inches)																																				
	4	6	8	10	12	14	16	18	20																												
5	15.6	35.1																																			
	15.6																																				
6	14.6																																				
7	13.5																																				
8	12.5									34.3	62.4																										
	9									11.4								32.8																			
10	10.4									31.2								62.4	97.5																		
										11								29.6							60.3												
										12								28.1							58.2												
14	25.0									54.1																											
		14	93.6																																		
16			49.9	88.4	137.3																																
																																16	191.1				
18																																	45.8	83.2	131.0		
											18	189.3																									
20												41.6	78.0	124.8	182.0	249.6	315.9																				
																			20	182.0																	

## STRENGTH OF MATERIALS

 ROUND WOODEN COLUMNS  
 (Safe loads in thousands of pounds)

 LONG LEAF PINE—WHITE OAK—1,300  $(1 - \frac{l}{60d})$ 

Length Feet	Diameter (Inches)								
	4	6	8	10	12	14	16	18	20
	12.3								
5	12.3								
8	11.4								
7	10.6								
		27.6							
8	9.8	27.0							
9	9.0	25.7							
			49.0						
10	8.2	24.5	49.0						
11		23.3	47.4						
12		22.1	45.7						
				76.6					
14		19.6	42.5	73.5					
					110.3				
16			39.2	69.4	107.8				
						150.1			
18			35.9	65.3	102.9	148.7			
20			32.7	61.3	98.0	142.9	196.0	248.1	306.3

Loads above horizontal lines are the maximum allowable safe loads.

 SAFE LOAD ON STANDARD WROUGHT IRON PIPE COLUMNS  
 (For table of sizes see page 508.)

Both Ends Fixed Factor of Safety = 6 In Tons of 2000 lb.

Size Pipe Inches	Length of Column—Feet						
	8	10	12	14	16	18	20
2	2.0	1.8	1.4	.....	.....	.....	.....
2½	.....	3.35	2.8	2.4	2.1	.....	.....
3	.....	4.8	4.3	3.8	3.36	3.08	.....
3½	.....	6.07	5.52	5.1	4.47	4.02	.....
4	.....	7.67	7.1	6.56	6.02	5.4	.....
4½	.....	9.32	8.69	8.16	7.52	6.98	.....
5	.....	.....	10.53	9.93	9.33	8.6	8.0
6	.....	.....	14.6	13.82	13.03	12.37	11.75
7	.....	.....	18.58	17.9	17.2	16.5	15.76
8	.....	.....	23.13	22.45	21.7	20.85	20.11

## SAFE LOAD ON STRONG AND EXTRA STRONG WROUGHT IRON PIPE COLUMNS

Both Ends Fixed Factor of Safety = 6 In Tons of 2000 lb.

*Strong*

Size Pipe Inches	Length of Column—Feet						
	8	10	12	14	16	18	20
2	3.36	3.10	2.46	.....	.....	.....	.....
2½	.....	4.93	4.41	3.81	3.43	.....	.....
3	.....	6.78	6.21	5.64	5.10	4.60	.....
3½	.....	9.05	8.43	7.80	7.18	6.58	.....
4	.....	11.56	10.94	10.30	9.52	8.88	.....
4½	.....	12.23	11.62	10.97	10.18	9.64	.....
5	.....	.....	15.94	15.27	14.40	13.67	12.99
6	.....	.....	23.03	22.18	21.26	20.54	19.80
7	.....	.....	29.24	28.52	27.73	26.90	25.73
8	.....	.....	33.84	33.34	32.53	31.63	30.68

*Extra Strong*

2	6.04	5.57	4.43	.....	.....	.....	.....
2½	.....	8.79	7.86	6.80	6.12	.....	.....
3	.....	13.19	12.08	10.97	9.92	8.94	.....
3½	.....	16.55	15.41	14.26	13.13	12.05	.....
4	.....	21.24	20.11	18.92	17.50	16.32	.....
4½	.....	25.29	24.03	22.69	21.05	19.94	.....
5	.....	.....	29.58	28.35	26.73	25.38	24.11
6	.....	.....	42.79	41.21	39.50	38.16	36.80
7	.....	.....	56.23	54.85	53.34	51.73	49.49
8	.....	.....	65.66	64.70	63.11	61.37	59.52

**Torsional Stresses.**—To find the safe torsional load of a circular shaft.

$T$  = twisting moment

$d_1$  = outside diameter of the shaft

$d_2$  = inside diameter of the shaft

$f$  = safe stress per square inch of section

Then for a hollow shaft  $T = \frac{\pi}{16} f \frac{d_1^4 - d_2^4}{d_1}$

If the shaft is solid  $d_2 = 0$  and  $T = \frac{\pi}{16} f d^3$



**Springs.**—To determine the size of steel wire for wire springs,

Let  $D$  = mean diameter in inches of coil.

$W$  = total load in pounds

$d$  = diameter of round or side of square steel wire in inches

$c$  = 11,000

$$\text{Then } d = 3\sqrt{\frac{DW}{c}}$$

To obtain the number of free coils  $N$  when the above data are known and the compression  $C$  is decided on, use the formula

$$N = \frac{C d^4 a}{W D^3}$$

where  $d$  = size in sixteenths of an inch

$a$  = 26 for round (British Admiralty) or 22 (Board of Trade)

= 32 for square (British Admiralty) or 30 (Board of Trade)

**Formula for Calculating Strength of Tubes, Pipes and Thin Cylinders.**—The one (Barlow's) commonly used assumes that the elasticity of the material at the different circumferential fibers will have their diameters increased in such a manner that the length of the tube is unaltered by the internal pressure.

Let  $t$  = thickness of wall in inches

$p$  = internal pressure in pounds per square inch

$S$  = allowable tensile strength in pounds per square inch

$D$  = outside diameter in inches

$n$  = safety factor as based on ultimate strength

$$\text{Then } \frac{P}{S} = \frac{2t}{D} \quad t = \frac{D P}{2 S}$$

$$P = \frac{2St}{D} \quad S = \frac{D P}{2 t}$$

$$S = \frac{40000}{n} \text{ for butt-welded steel pipe}$$

$$= \frac{50000}{n} \text{ for lap-welded steel pipe}$$

$$= \frac{60000}{n} \text{ for seamless steel tubes}$$

$$= \frac{28000}{n} \text{ for wrought iron pipe}$$

In the above, the thickness of the wall  $t$  is assumed to be small

compared to the diameter. The thicknesses of thin pipes under the same internal pressure should increase directly as their diameters.

A cylinder under exterior pressure is theoretically in a similar condition to one under internal pressure as long as it remains a true circle in cross section.

## BURSTING AND COLLAPSING PRESSURES OF WROUGHT IRON TUBES

[Lukens Iron &amp; Steel Co.]

External Dia. (Ins.)	Thick- ness (Ins.)	Burst- ing	Collaps- ing	External Dia. (Ins.)	Thick- ness (Ins.)	Burst- ing	Collaps- ing
		Per Sq. Inch of Internal Surface (Lb.)	Per Sq. Inch of External Surface (Lb.)			Per Sq. Inch of Internal Surface (Lb.)	Per Sq. Inch of External Surface (Lb.)
1.25	.083	7700	6500	3.25	.12	4000	2700
1.375	.083	6900	5800	3.5	.134	4200	2700
1.5	.083	6200	5200	3.75	.134	3900	2400
1.625	.083	5700	4700	4.	.134	3600	2100
1.75	.083	5300	4300	4.25	.134	2400	1900
1.875	.083	4900	4000	4.5	.134	3200	1700
2.	.083	4500	3700	4.75	.134	3000	1600
2.125	.095	4900	3800	5.	.134	2800	1400
2.25	.095	4600	3600	5.25	.148	3000	1400
2.5	.109	4800	3600	5.5	.148	2800	1200
2.75	.109	4300	3100	5.75	.148	2700	1100
3.	.12	4400	3000	6.	.148	2600	1000

## Strengths of Various Fittings.—

Let  $d$  = diameter of iron in inches

Then working load of a hook =  $\frac{d^2}{5}$  tons

working load of a ring bolt =  $2d^2$  tons

working load of eye bolt =  $5d^2$  tons

working load of a straight shackle =  $3d^2$

working load of a bow shackle =  $2\frac{1}{2}d^2$

Suppose in a chain having a shackle, hook and ring bolt, it is desired to have all the parts of approximately the same strength, assuming the link of the chain as 1, then the eye of eye bolt =  $1\frac{1}{8}$   
 shackle =  $1\frac{1}{2}$   
 ring bolt =  $1\frac{3}{4}$   
 hook at back =  $3\frac{1}{2}$

See also Chain table.

[Abstracts from Naval Constructor, G. Simpson.]

The strength of a bitt or bollard can be calculated as a beam supported at one end and loaded at the other. Usually a thickness of  $1\frac{1}{2}$  ins. is sufficient, but the outside diameter depends on the size of the chain or hawser that will be used. For steel wire hawsers, bitts should not be less in diameter than four times the circumference of the hawser.

## RIDING BITTS OR BOLLARDS

Dia. in Inches	Dia. of Cable in Inches
16	$1\frac{1}{2}$
18	$1\frac{3}{8}$
20	$1\frac{3}{4}$
22	$1\frac{1}{2}$
24	2
26	$2\frac{1}{8}$
28	$2\frac{1}{4}$

As to the working load for rivets

allow 1 ton for each  $\frac{1}{2}$  inch rivet  
 2 tons for each  $\frac{3}{4}$  inch rivet  
 $3\frac{1}{2}$  tons for each 1 inch rivet

The breaking stress in tons of a rivet in single shear is about 25 times the sectional area  $A$  of the rivet, and in double shear 50 times.

If  $S$  = safe shearing stress on a rivet in tons per square inch  
 $W$  = working load on a rivet  
 $A$  = sectional area of the rivet in square inches

Then  $W = S A$  for single shear, or  
 $= 1\frac{1}{4} S A$  for double shear

See also section on Rivets and Riveting. Bolts may be similarly calculated.

SHEARING AND TENSILE STRENGTH OF BOLTS

Dia. of Bolt	Area		Shearing Strength				Tensile Strength		Ultimate Tensile and Shearing Strain at 50,000 lb. Per Square Inch	
	Cross Sections		Safe Loads				Safe Loads			
			Full Bolt		Root of Thd.		Root of Thd.			
	Bolt	Root of Thread	7500 lb. per Sq. In.	10000 lb. per Sq. In.	7500 lb. per Sq. In.	10000 lb. per Sq. In.	10000 lb. per Sq. In.	12500 lb. per Sq. In.	Full Bolt	Root of Thread
sq. in.	sq. in.	lb.	lb.	lb.	lb.	lb.	lb.	lb.	lb.	
1/4	.049	.026	368	491	202	269	280	336	2455	1346
	.076	.045	575	767	341	454	451	568	3835	2270
	.110	.067	828	1104	509	678	678	848	5520	3390
	.150	.093	1127	1503	700	933	933	1166	7515	4665
3/8	.196	.125	1472	1963	943	1257	1257	1571	9815	6285
	.248	.162	1861	2485	1216	1621	1621	2026	12425	8105
	.306	.201	2301	3068	1514	2018	2018	2523	15340	10090
	.441	.302	3314	4418	2265	3020	3020	3775	22090	15100
1/2	.601	.419	4510	6013	3145	4193	4193	5241	30065	20965
	.785	.551	5891	7854	4133	5510	5510	6888	39270	27550
	.994	.693	7455	9940	5198	6931	6931	8664	49700	34655
	1.227	.869	9204	12272	6074	8099	8099	11124	61360	44495
5/8	1.484	1.054	11137	14849	7906	10541	10541	13176	74245	52705
	1.767	1.293	13253	17671	9704	12938	12938	16173	86355	64690
	2.073	1.514	15554	20739	11362	15149	15149	18936	103695	75745
	2.405	1.744	18040	24053	13081	17441	17441	21801	120265	87205
3/4	2.761	2.049	20709	27612	15368	20490	20490	25613	138060	102480
	3.141	2.300	23562	31416	17251	23001	23001	28751	157080	115065
	3.976	3.021	29821	39761	22660	30213	30213	37766	198905	151065
	4.908	3.716	36815	49087	27872	37163	37163	46454	245435	185815
2	5.939	4.619	44547	59396	34647	46196	46196	57745	296980	230980
	7.068	5.427	53015	70686	40708	54277	54277	67846	353430	271385
	8.295	6.509	62219	82958	48819	65092	65092	81365	414790	325490
	9.621	7.549	72158	96211	56618	75491	75491	94364	481055	377455
3	11.044	8.641	82835	110447	64809	86412	86412	108015	552235	432060
	12.366	9.992	94248	125664	74947	99929	99929	124911	628320	499645
	14.186	11.230	106397	141863	84977	113302	113302	141628	709315	566510
	15.904	12.740	119282	159043	95554	127405	127405	159256	795215	637025
4	17.720	14.220	132904	177205	106654	142206	142206	177756	886025	711025
	19.635	15.765	147263	196350	118244	157659	157659	197074	981750	788295
	21.647	17.574	162366	216475	131909	175745	175745	219681	1082375	878725
	23.758	19.267	178187	237583	144509	192678	192678	240848	1187915	963390
5	25.967	21.262	194754	259672	159465	212620	212620	265775	1298360	1063100
	28.274	23.064	212067	282743	173210	230947	230947	288684	1413715	1154735

## TESTS OF HOOKS AND SHACKLES

Experience has shown that the same brand of iron or steel will not maintain the same tensile strength under various conditions. The following tables give the results of tests of hooks from  $\frac{3}{8}$  in. to 3 ins. diameter and of shackles from  $\frac{1}{2}$  in. to 3 ins. diameter, the figures being taken from the catalogue of the Boston & Lockport Co., Boston, Mass. In the column "Size, Inches," the diameter of the hook or shackle is meant. It is suggested that not more than 20% of the tensile strength as given in Column 2 be reckoned as the working load, and on this basis Column 4 is calculated. Ordinarily the hook of a block is the first to give way, and when heavy weights are to be handled, shackles are far superior to hooks. By many tests it has been proven that flattening a hook adds from 12 to 15% to its ultimate strength.

## TESTS OF HOOKS

[Boston &amp; Lockport Co.]

In column Size, Inches, the diameter of the hook or shackle is meant.

Size, Inches	Tensile Strength, Lb.	Description of Fracture	Working Load in Lb., Based on 20% of the Tensile Strength. That is a Factor of Safety of 5
$\frac{3}{8}$ .....	1,040	Straightened the Hook	208
$\frac{7}{16}$ .....	1,245	"	249
$\frac{1}{2}$ .....	2,010	"	402
$\frac{5}{8}$ .....	2,650	"	530
$\frac{3}{4}$ .....	3,210	"	642
$\frac{7}{8}$ .....	4,750	"	950
1.....	6,680	"	1,336
1.....	13,720	"	2,744
$1\frac{1}{8}$ .....	14,540	"	2,908
$1\frac{1}{4}$ .....	16,950	"	3,390
$1\frac{3}{8}$ .....	18,340	"	3,668
$1\frac{1}{2}$ .....	21,220	"	4,244
$1\frac{5}{8}$ .....	25,780	"	5,156
$1\frac{3}{4}$ .....	30,250	"	6,050
$1\frac{7}{8}$ .....	38,100	"	7,620
2.....	41,150	"	8,230
$2\frac{1}{4}$ .....	46,145	"	9,229
$2\frac{1}{2}$ .....	65,150	"	13,030
3.....	110,000	"	22,000

### TESTS OF SHACKLES

Size, Inches	Tensile Strength, Lb.	Description of Fracture	Working Load in Lb., Based on 20% of the Tensile Strength
$\frac{1}{2}$	15,400	Sheared Shackle Pin	3,080
$\frac{5}{8}$	20,500	"	4,100
$\frac{3}{4}$	22,700	"	4,540
$\frac{7}{8}$	40,100	"	8,020
1	66,380	"	13,276
$1\frac{1}{8}$	68,900	"	13,780
$1\frac{1}{4}$	78,900	"	15,780
$1\frac{3}{8}$	105,900	"	21,180
$1\frac{1}{2}$	121,850	"	24,370
$1\frac{5}{8}$	126,700	"	25,340
$1\frac{3}{4}$	150,600	"	30,120
$1\frac{7}{8}$	170,500	"	34,100
2	230,200	"	46,040
$2\frac{1}{4}$	260,500	"	52,100
$2\frac{1}{2}$	280,600	"	56,120
3	498,000	"	99,600

### WELDLESS EYE BOLTS (Either plain or shoulder pattern)

Shank		Maximum Length in Stock	Diameter Eye		Capacity, Net Tons		
Diameter	Standard Length Under Eye		Inside	Outside	Safe Working Load	Average Load at Elastic Limit	Approximate Breaking Strain
$\frac{3}{8}$	$1\frac{1}{4}$	$4\frac{1}{2}$	1	$1\frac{1}{8}$	.7	1.4	3.
$\frac{1}{2}$	$1\frac{3}{8}$	$4\frac{1}{2}$	$1\frac{1}{4}$	$1\frac{1}{2}$	1.	2.	4.
$\frac{5}{8}$	$1\frac{1}{2}$	$4\frac{1}{2}$	$1\frac{3}{8}$	$2\frac{1}{8}$	1.3	2.5	5.
$\frac{3}{4}$	$1\frac{5}{8}$	$4\frac{1}{2}$	$1\frac{1}{2}$	$2\frac{1}{4}$	1.5	3.	6.
$\frac{5}{8}$	$1\frac{3}{4}$	$4\frac{1}{2}$	$1\frac{3}{8}$	$2\frac{1}{2}$	2.	4.	8.
$\frac{3}{4}$	2	5	$1\frac{1}{2}$	$2\frac{1}{4}$	3.	6.	12.
$\frac{7}{8}$	$2\frac{1}{4}$	5	$1\frac{1}{4}$	$3\frac{1}{4}$	3.5	7.	16.
1	$2\frac{1}{2}$	5	$1\frac{1}{2}$	$3\frac{1}{8}$	4.	8.	20.
$1\frac{1}{8}$	$2\frac{3}{4}$	5	2	4	5.	10.	23.
$1\frac{1}{4}$	3	6	$2\frac{3}{16}$	$4\frac{1}{16}$	7.5	15.	33.
$1\frac{1}{2}$	$3\frac{1}{2}$	6	$2\frac{1}{2}$	$5\frac{1}{16}$	9.	18.	42.
$1\frac{3}{4}$	$3\frac{3}{4}$	6	$2\frac{7}{8}$	$6\frac{1}{16}$	11.	21.	53.
2	4	6	$3\frac{1}{4}$	$6\frac{7}{8}$	13.	25.	68.
$2\frac{1}{2}$	5	6	4	$8\frac{1}{16}$	16.	32.	85.

**DROP FORGED HOIST HOOKS WITH EYE**  
(Capacity with plain shank the same)

Diameter of Eye		Extreme Dimensions		Capacity, Net Tons		
Inside	Outside	Length	Width	Safe Working Load	Average Load at Elastic Limit	Approximate Load Required to Straighten Out
3/4	1 1/2	4 3/8	2 7/8	.5	.9	1.9
7/8	1 3/4	4 7/8	3 1/8	.6	1.2	2.3
1	2	5 3/8	3 1/2	.7	1.5	3.
1 1/8	2 1/4	6 1/8	3 7/8	1.2	2.5	5.7
1 1/4	2 1/2	6 7/8	4 3/8	1.7	3.5	7.
1 3/8	2 3/4	7 5/8	4 7/8	2.1	4.2	8.5
1 1/2	3	8 3/16	5 5/8	2.5	5.4	10.
1 5/8	3 1/4	9 1/16	6 3/8	3.	6.2	13.
1 3/4	3 1/2	10 3/8	6 7/8	4.	8.	17.
2	4	11 1/2	7 1/2	4.7	9.	19.
2 3/8	4 5/8	13	8 1/4	5.5	11.	26.
2 1/4	5 1/4	14 3/4	9 1/4	6.8	13.	32.
3 1/8	6 1/8	16 3/4	10 7/8	8.	17.	35.
3 1/2	7.	19 1/8	13	11.	21.	48.
4	8 1/2	22 1/2	14 3/4	20.	40.	80.

**IRON GUY SHACKLES**

Size in Inches of Shackle (Diam. in Bow)	Gov. Test Maximum Strength in Pounds	Length Inside Inches	Width Between Eyes Inches	Diameter of Pin in Inches	Approximate Weight of Each in Pounds
3/8	10,890	1 3/8	5/8	1/2	0.30
1/2	15,200	1 3/4	1 1/8	5/8	0.48
5/8	18,390	1 7/8	1 1/4	3/4	0.70
3/4	24,800	1 7/8	1 1/4	3/4	0.90
5/8	33,400	2 1/4	1 7/8	3/4	1.40
3/4	43,400	3	1 3/4	7/8	2.20
7/8	55,200	3 1/2	1 3/8	1	3.40
1	74,900	4	1 3/4	1 1/8	5.00
1 1/8	90,200	4 1/2	1 7/8	1 1/4	6.80
1 1/4	92,040	5	2	1 3/8	9.40
1 5/8	94,100	5 1/2	2 1/8	1 1/2	12.20
1 1/2	103,800	6	2 1/4	1 5/8	16.40
1 5/8	155,542	6 1/2	2 1/2	1 3/4	19.00
1 3/4	172,400	7	2 3/4	1 7/8	24.00
2	235,620	8	3 1/4	2 1/8	38.20

From J. H. Williams & Co., Brooklyn.

## TURNBUCKLES

Drop-forged, with hook and eye, shackle and eye, two eyes, two hooks, two shackles, or hook and shackle.

Size Turnbuckle and Outside Diameter of Thread in Inches	Approximate Breaking Strength in Pounds	Recommended Working Load in Pounds	Amount of Take-up Length in the Clear Between Heads in Inches	Length of Buckle Outside in Inches	Length Pull to Pull When Extended in Inches	Approximate Weight Each in Pounds
$\frac{1}{4}$	1,350	270	4	$4\frac{3}{4}$	12	.40
$\frac{3}{8}$	2,250	450	$4\frac{1}{4}$	$5\frac{1}{4}$	$13\frac{1}{2}$	.60
$\frac{1}{2}$	3,350	670	$4\frac{1}{2}$	$6\frac{3}{4}$	14	.90
$\frac{3}{4}$	4,650	930	5	$6\frac{1}{4}$	$16\frac{1}{2}$	1.31
$\frac{7}{8}$	6,250	1,250	6	$7\frac{1}{2}$	$18\frac{1}{4}$	1.87
$1\frac{1}{8}$	8,100	1,620	$7\frac{1}{4}$	9	$23\frac{3}{8}$	3.00
$1\frac{1}{4}$	10,000	2,000	$8\frac{1}{2}$	$10\frac{1}{2}$	$24\frac{1}{4}$	3.69
$1\frac{3}{8}$	15,000	3,000	$9\frac{1}{4}$	$11\frac{3}{4}$	$27\frac{1}{2}$	5.81
$1\frac{1}{2}$	21,000	4,200	10	$12\frac{3}{4}$	$30\frac{1}{2}$	8.81
1	27,500	5,500	11	14	33	12.56
$1\frac{5}{8}$	34,500	6,900	12	$15\frac{1}{4}$	39	17.00
$1\frac{3}{4}$	44,500	8,900	13	$16\frac{3}{4}$	40	25.00
$1\frac{7}{8}$	52,500	10,500	14	18	50	36.00
$1\frac{1}{2}$	64,500	12,900	15	$19\frac{1}{2}$	51	40.00
$1\frac{5}{8}$	75,500	15,100	16	21	$51\frac{1}{2}$	48.00
$1\frac{3}{4}$	87,000	17,400	18	23	$55\frac{1}{2}$	52.00
$1\frac{7}{8}$	102,500	20,500	18	23	66	89.00
2	115,000	23,000	24	31	74	98.00
$2\frac{1}{8}$	132,500	26,500	24	31	.....	.....
$2\frac{1}{4}$	151,000	30,200	24	32	.....	.....

## Formulæ for Circular Davits.—

$D$  = diameter of each davit in inches

$W$  = weight of boat with full complement of equipment and persons (figured at 165 lb. each) plus weight of tackle and blocks, all in pounds

$R$  = radius of overhang of davit arm in inches

$a$  = increase of  $W$  to take care of increase in stresses when ship is listed  $15^\circ$

$K$  = fiber stress allowed in pounds per square inch

$$\text{Then } D = \sqrt[3]{\frac{16W \times R \times (1 + a)}{\pi \times K}}$$



The average values given below substituted in the above formula will give a handy equation for calculating the diameter of the davit.

$$a = 25 \text{ and } K = 12000$$

$$\text{Hence } D = .0812 \sqrt[3]{W \times R}$$

For davits of structural steel their dimensions must give the same strength as round bar davits as figured with the above formula.

Lloyd's rule for boat davits.

$L$  = length of boat

$B$  = beam of boat

$D$  = depth of boat

$H$  = height of davit above its uppermost point of support

$S$  = spread

All the above dimensions are in feet.

$C$  = constant = 82 when the davit is of wrought iron and of sufficient strength to safely lower the boat fully equipped and carrying the maximum number of passengers

$d$  = diameter of davit in inches

$$d = \sqrt[3]{\frac{L \times B \times D (H + 4S)}{C}}$$

Davits may be calculated as beams, fixed at one end and loaded at the other. See also section on Anchor Davits.

Stresses in Cranes, Derricks, and Shear Poles.—The stresses in any member can be found graphically. Thus in Fig. 13 lay off

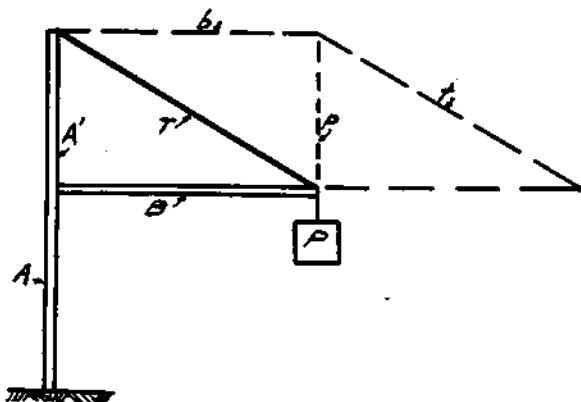

Figure 13

the distance  $p$  to any scale, say 1 inch = 1,000 lb., it representing the downward force or weight of the load, and draw a parallelogram with the sides  $b t$  parallel to  $B$  and  $T$  so that  $p$  is the diagonal. By scaling  $t$  the tension in the tie  $T$  is obtained and similarly the compression  $b$  in the brace. The above also applies to Fig. 14.

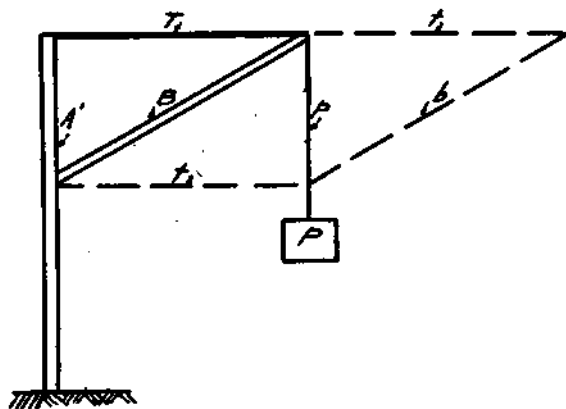

Figure 14

In a guyed crane or derrick as Fig. 15 the strain in  $B$  is  $\frac{P \times B}{A'}$

$A'$  being that portion of the vertical included between  $B$  and  $T$  wherever  $T$  may be attached to  $A$ . If  $T$  is attached to  $B$  below its

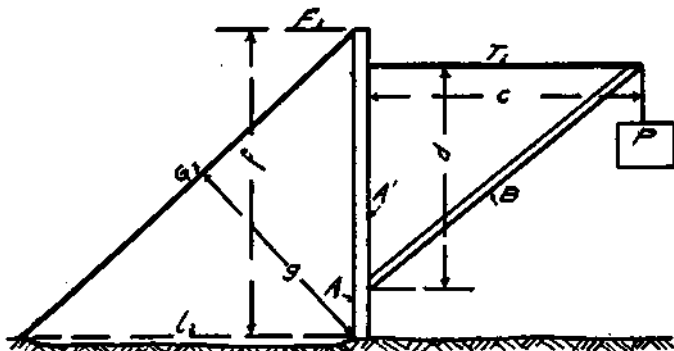

Figure 15

extremity, there may be in addition a bending strain  $B$  due to a tendency to turn about the point of attachment of  $T$  as a fulcrum. The strain in  $T$  may be calculated by the principle of moments. The moment of  $P$  is  $P \times c$ . The moment of the strain on  $T$  is  $T \times d$ , therefore the strain on  $T$  is  $\frac{P \times c}{d}$ . As  $d$  decreases the strain on  $T$  increases.

The strain on the guy rope  $G$  is calculated by the principle of moments. The moment of the load about the bottom of the mast is  $P \times c$ . If the guy is horizontal the strain in it is  $F$  and its moment is  $F \times f$ , and  $F = \frac{P \times c}{f}$ . If it is inclined, the moment is the strain  $G \times$  the perpendicular distance of the line of its direction or  $g$ , and  $G = \frac{P \times c}{g}$ . The guy rope having the least strain is the horizontal one  $F$ , and the strain in  $G =$  strain in  $F \times$  secant of the angle between  $F$  and  $G$ . As  $G$  is made more nearly vertical  $g$  decreases and the strain increases.

Another case is where the tie  $T$  is not perpendicular to  $A'$ , or the post  $A$  may be omitted and  $T$  extended to the ground. The parallelogram of forces may be applied and the equations,

(1) tension in  $T = \frac{P \times T}{A'}$  and (2) compression in  $B = \frac{P \times B}{A'}$ , hold.

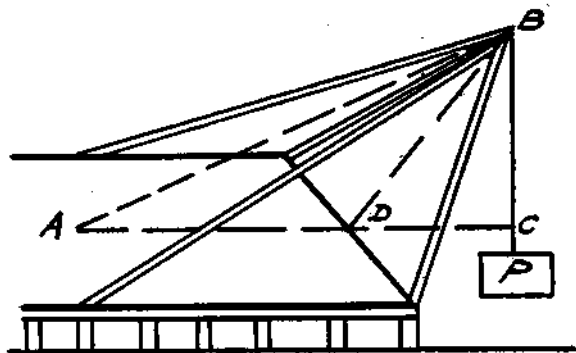

Figure 16

Shear poles with guys. See Fig. 16. First assume that the two masts act as one placed at  $B D$  and the two guys as one at  $A B$ .

Calculate the strain in  $AB$  and  $BD$  as in the previous case. Multiply half the strain in  $AB$  (or  $BD$ ) by the secant of half the angle the two masts or guys make with each other to find the strain in each mast or guy.

(From Mech. Eng'rs Pocket Book. W. Kent)

### RIVETS AND RIVETING

Different types of rivets are shown in Fig. 17. Pan- and button-head rivets  $\frac{1}{2}$  inch in diameter or over have coned or swelled necks for punched plates, and straight necks for drilled. The advantage of swelled-neck rivets is that the diameter of the punched hole on the die side is always slightly larger than on the punched side. In assembling the plates are reversed, and thus with swelled-neck rivets the holes are completely filled.

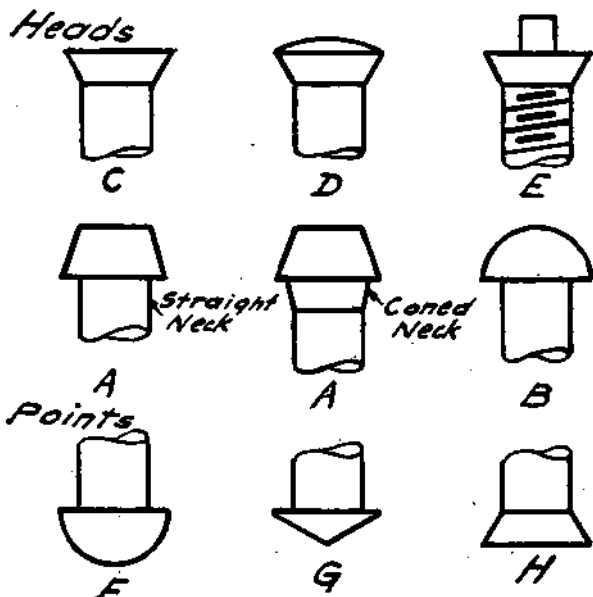
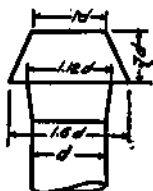

Figure 17.—Rivet Heads and Points.

$A$  = pan head.  $B$  = snap or button head, makes a neater appearance than pan head.  $C$  = flush or countersunk flat head.  $D$  = countersunk raised head.  $E$  = tap rivets. They are  $\frac{1}{4}$  of an inch greater diameter than is required for a plain rivet to the same thickness of plate or shape (Am. Bureau of Shipping Rules).  $F$  = snap point, proportions same as button head.  $G$  = hammered point.  $H$  = countersunk point, proportions same for countersunk head.

Form of Rivet in outside plating



Tapered neck to be of suitable length in relation to thickness of plates.

Proportions.—The proportions of the heads and countersinks vary with the different classification societies. The U. S. Navy has its own standard. There are thus no universal standards, although Lloyd's is doubtless adopted more than any other for merchant work. Below are Lloyd's proportions.

Countersink.

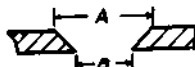

Diameter of Rivet, Ins.	A, Ins.	B, Ins.
$\frac{5}{8}$ .....	1	$\frac{11}{16}$
$\frac{3}{4}$ .....	$1\frac{1}{8}$	$\frac{13}{16}$
$\frac{7}{8}$ .....	$1\frac{3}{8}$	$\frac{14}{16}$
1.....	$1\frac{1}{2}$	$1\frac{1}{8}$
$1\frac{1}{8}$ .....	$1\frac{3}{4}$	$1\frac{1}{4}$









Countersink to extend through the whole thickness of the plate when less than  $\frac{14}{32}$  or .7 ins. thick, when .7 ins. or above the countersink to extend through nine-tenths the thickness of the plate.







## LLOYD'S RULES FOR THE DIAMETER OF RIVETS

Thickness of plate in ins.	.22 and under .34	.34 and under .48	.48 and under .66	.66 and under .88	.88 and under 1.14	1.14 and under 1.2
Diameter of rivet in ins.	$\frac{3}{8}$	$\frac{1}{2}$	$\frac{3}{4}$	1	$1\frac{1}{8}$	$1\frac{1}{4}$

Lengths of Rivets for Ordering.—The length for ordering pan- and button-head rivets is measured exclusive of the head; for countersunk rivets and taps the ordered length includes the head to the top of the countersink.

# CONVENTIONAL SIGNS FOR RIVETS

Shop Rivets		Field Rivets	
Countersunk and Chipped		Countersunk and Chipped	
Near side		Near side	
Far side		Far side	
Both sides		Both sides	
Two full heads		Two full heads	
			

Shop Rivets		Field Rivets	
Countersunk but Not Chipped. Max. Height $\frac{1}{8}$ "		Flattened to $\frac{1}{8}$ " High, $\frac{1}{4}$ , $\frac{3}{8}$ and $1$ " Rivets	
Near side		Near side	
Far side		Far side	
Both sides		Both sides	

ALLOWANCE FOR POINTS IN LENGTH OF RIVETS WITH TWO THICKNESSES CONNECTED

Type of Point	Diameters of Rivets (Ins.)					
	$\frac{1}{2}$	$\frac{3}{8}$	$\frac{1}{2}$	$\frac{3}{4}$	1	$1\frac{1}{2}$
Countersunk.....	$\frac{1}{2}$	$\frac{5}{8}$	$\frac{3}{4}$	$\frac{7}{8}$	1	$1\frac{1}{8}$
Hammered.....	$\frac{1}{2}$	$\frac{1}{2}$	$\frac{1}{2}$	$\frac{5}{8}$	$\frac{5}{8}$	$\frac{5}{8}$
Snap.....	$\frac{7}{8}$	1	$1\frac{1}{8}$	$1\frac{1}{4}$	$1\frac{3}{8}$	$1\frac{1}{2}$
Oval.....	$\frac{7}{8}$	$\frac{3}{8}$	...	...	...	...

The above allowances are based upon the average practice at various U. S. Navy and private ship yards.

Rivets are usually shipped in kegs of 100 and 200 lb. In ordering the diameter should be given first thus:  $\frac{1}{2}$  in.  $\times$  3 ins.

**Materials.**—To prevent galvanic action as far as possible iron rivets should be used in iron plates, and steel in steel plates. It is important that rivets have a high tensile strength and resistance to shear. For specifications see Shipbuilding Materials.

**Strength of Rivets.**—The diameter of a rivet in inches for single shear is given by the formula  $D = \sqrt{\frac{4Fc}{\pi S}}$  and in double

shear,  $\sqrt{\frac{2Fc}{\pi S}}$  or  $.707 D$  in single shear, where

$D$  = diameter of rivet

$c$  = factor of safety

$F$  = shearing force

$S$  = ultimate shearing strength of the material

SHEARING AND TENSILE STRENGTH OF STEEL RIVETS IN POUNDS PER SQUARE INCH

	$\frac{1}{2}$ In.	$\frac{3}{8}$ In.	$\frac{1}{2}$ In.	$\frac{3}{4}$ In.	$1\frac{1}{2}$ In.
Shearing lb. per sq. in.	9,225	13,150	18,000	20,525	27,100
Tensile lb. per sq. in.	10,600	16,500	20,000	23,800	31,400

TABLE OF ULTIMATE SINGLE SHEARING STRENGTH OF RIVETS

Diameter in Fractions (Ins.)	Diameter in Decimals (Ins.)	Steel at 40,000 Lb. Per Sq. Inch	Steel at 45,000 Lb. Per Sq. Inch
$\frac{1}{8}$	.125	490	552
$\frac{1}{8}$	.187	1,104	1,242
$\frac{1}{4}$	.250	1,963	2,209
$\frac{3}{8}$	.312	3,068	3,452
$\frac{3}{8}$	.375	4,418	4,970
$\frac{1}{2}$	.437	6,013	6,735
$\frac{1}{2}$	.500	7,854	8,836
$\frac{5}{8}$	.562	9,940	11,183
$\frac{5}{8}$	.625	12,272	13,806
$\frac{3}{4}$	.687	14,848	16,705
$\frac{3}{4}$	.750	17,671	19,880
$\frac{7}{8}$	.812	20,739	23,332
$\frac{7}{8}$	.875	24,052	27,060
$\frac{7}{8}$	.937	27,611	31,064
1	1.000	31,416	35,343
$1\frac{1}{8}$	1.062	35,465	39,899
$1\frac{1}{8}$	1.125	39,760	44,731
$1\frac{1}{8}$	1.187	44,300	49,838
$1\frac{1}{4}$	1.250	49,088	55,224
$1\frac{1}{4}$	1.312	54,120	60,885
$1\frac{1}{4}$	1.375	59,396	66,820
$1\frac{1}{2}$	1.437	64,920	73,035
$1\frac{1}{2}$	1.500	70,684	79,519

From Lukens Iron &amp; Steel Co.

**Riveted Joints.**—A riveted joint may fail: (1) in the plate, by tearing out or across from hole to hole; (2) in the rivet, by shearing; and (3) in the plate or rivet, by a crushing of the material.

The failure of a joint by the tearing out of the plate in front of the rivet may be prevented by placing the rivets at a proper distance from the edge of the plate. This has been found to be about one diameter in the clear or one and a half diameters of the rivet from the edge of the plate to the center of the rivet.

To determine the efficiency of a riveted joint, calculate the ways it may fail, and the one giving the least result will show the actual strength of the joint. If this equals  $T_r$  and  $T$  equals the tensile strength of the solid plate then the efficiency of the joint is  $\frac{T_r}{T}$  which can be expressed as a percentage. Thus the average relative strengths of joints in boilers are as follows:

Single riveted lap ..... 55%



Double riveted lap .....	70%
Single riveted butt joint .....	65
Double riveted butt joint .....	75
Triple riveted butt joint .....	80
Quadruple riveted butt joint .....	85

From the following equations the unit stresses may be computed when the other quantities are known, and by comparing them with proper allowable unit stresses the degree of security of the joint is estimated.

$d$ = diameter of rivets	$T$ = tensile strength of plate
$t$ = thickness of plate	$C$ = crushing strength of rivets
$p$ = pitch of rivets	$S$ = shearing strength of rivets

All dimensions are in inches, and stresses in pounds per square inch.

*Lap Joint Single Riveted.*

Resistance to tearing plate between rivets	= $t(p - d) T$
Resistance to crushing of one rivet	= $t d C$
Resistance to shearing of one rivet	= $\frac{1}{4} \pi d^2 S$

*Lap Joint Double Riveted.*

Resistance to tearing plate between two rivets	= $t(p - d) T$
Resistance to crushing of two rivets	= $2 t d C$
Resistance to shearing of two rivets	= $\frac{2 \pi d^2 S}{4}$

*Butt Strap, Single Riveted, Two Cover Plates.*

Resistance to tearing plate	= $t(p - d) T$
Resistance to crushing of one rivet	= $t d C$
Resistance to shearing of one rivet	= $\frac{2 \pi d^2 S}{4}$

*Butt Strap, Double Riveted, Two Cover Plates.*

Resistance to tearing plate	= $t(p - d) T$
Resistance to crushing of two rivets	= $2 t d C$
Resistance to shearing of two rivets	= $\frac{4 \pi d^2 S}{4}$

The total shearing strength of a rivet in double shear is usually taken as about 1.75 the strength in single shear.

# SHEARING VALUE OF RIVETS AND BEARING VALUE OF RIVETED PLATES

All Dimensions in Inches

Shearing Value = Area of Rivet X Allowable Shearing Stress Per Square Inch

Bearing Value = Diameter of Rivet X Thickness of Plate X Allowable Bearing Stress Per Square Inch.

Dia. of Rivet	Area in Square Inches	Single Shear 6,000 lb. Sq. in.	Double Shear 6,000 lb. Sq. in.	Bearing Value for Different Thicknesses of Plate in Inches at 12,000 lb. Per Square Inch																																																																																																																																																																																																																																																																																																																																																																																																																																																																																																																																																																																																																																																																																																																																																																																																																																																																																																																																																																																																																		
				1/4"	3/8"	1/2"	5/8"	3/4"	7/8"	1"	1 1/8"	1 1/4"	1 1/2"																																																																																																																																																																																																																																																																																																																																																																																																																																																																																																																																																																																																																																																																																																																																																																																																																																																																																																																																																																																																									
1/4	.1964	1178	2356	1800	1975	2250	2625	3000	3375	3750	4125	4500	4875	5250	5625	6000	6375	6750	7125	7500	7875	8250	8625	9000	9375	9750	10125	10500	10875	11250	11625	12000																																																																																																																																																																																																																																																																																																																																																																																																																																																																																																																																																																																																																																																																																																																																																																																																																																																																																																																																																																																						
1/8	.3068	1841	3682	1875	2344	2813	3281	3750	4219	4688	5157	5625	6094	6563	7031	7500	7969	8438	8907	9376	9845	10314	10783	11252	11721	12190	12659	13128	13597	14066	14535	15004	15473	15942	16411	16880	17349	17818	18287	18756	19225	19694	20163	20632	21101	21570	22039	22508	22977	23446	23915	24384	24853	25322	25791	26260	26729	27198	27667	28136	28605	29074	29543	30012	30481	30950	31419	31888	32357	32826	33295	33764	34233	34702	35171	35640	36109	36578	37047	37516	37985	38454	38923	39392	39861	40330	40799	41268	41737	42206	42675	43144	43613	44082	44551	45020	45489	45958	46427	46896	47365	47834	48303	48772	49241	49710	50179	50648	51117	51586	52055	52524	52993	53462	53931	54400	54869	55338	55807	56276	56745	57214	57683	58152	58621	59090	59559	60028	60497	60966	61435	61904	62373	62842	63311	63780	64249	64718	65187	65656	66125	66594	67063	67532	68001	68470	68939	69408	69877	70346	70815	71284	71753	72222	72691	73160	73629	74098	74567	75036	75505	75974	76443	76912	77381	77850	78319	78788	79257	79726	80195	80664	81133	81602	82071	82540	83009	83478	83947	84416	84885	85354	85823	86292	86761	87230	87699	88168	88637	89106	89575	90044	90513	90982	91451	91920	92389	92858	93327	93796	94265	94734	95203	95672	96141	96610	97079	97548	98017	98486	98955	99424	99893	100362	100831	101300	101769	102238	102707	103176	103645	104114	104583	105052	105521	105990	106459	106928	107397	107866	108335	108804	109273	109742	110211	110680	111149	111618	112087	112556	113025	113494	113963	114432	114901	115370	115839	116308	116777	117246	117715	118184	118653	119122	119591	120060	120529	120998	121467	121936	122405	122874	123343	123812	124281	124750	125219	125688	126157	126626	127095	127564	128033	128502	128971	129440	129909	130378	130847	131316	131785	132254	132723	133192	133661	134130	134599	135068	135537	136006	136475	136944	137413	137882	138351	138820	139289	139758	140227	140696	141165	141634	142103	142572	143041	143510	143979	144448	144917	145386	145855	146324	146793	147262	147731	148200	148669	149138	149607	150076	150545	151014	151483	151952	152421	152890	153359	153828	154297	154766	155235	155704	156173	156642	157111	157580	158049	158518	158987	159456	159925	160394	160863	161332	161801	162270	162739	163208	163677	164146	164615	165084	165553	166022	166491	166960	167429	167898	168367	168836	169305	169774	170243	170712	171181	171650	172119	172588	173057	173526	173995	174464	174933	175402	175871	176340	176809	177278	177747	178216	178685	179154	179623	180092	180561	181030	181499	181968	182437	182906	183375	183844	184313	184782	185251	185720	186189	186658	187127	187596	188065	188534	189003	189472	189941	190410	190879	191348	191817	192286	192755	193224	193693	194162	194631	195100	195569	196038	196507	196976	197445	197914	198383	198852	199321	199790	200259	200728	201197	201666	202135	202604	203073	203542	204011	204480	204949	205418	205887	206356	206825	207294	207763	208232	208701	209170	209639	210108	210577	211046	211515	211984	212453	212922	213391	213860	214329	214798	215267	215736	216205	216674	217143	217612	218081	218550	219019	219488	219957	220426	220895	221364	221833	222302	222771	223240	223709	224178	224647	225116	225585	226054	226523	226992	227461	227930	228399	228868	229337	229806	230275	230744	231213	231682	232151	232620	233089	233558	234027	234496	234965	235434	235903	236372	236841	237310	237779	238248	238717	239186	239655	240124	240593	241062	241531	242000	242469	242938	243407	243876	244345	244814	245283	245752	246221	246690	247159	247628	248097	248566	249035	249504	249973	250442	250911	251380	251849	252318	252787	253256	253725	254194	254663	255132	255601	256070	256539	257008	257477	257946	258415	258884	259353	259822	260291	260760	261229	261698	262167	262636	263105	263574	264043	264512	264981	265450	265919	266388	266857	267326	267795	268264	268733	269202	269671	270140	270609	271078	271547	272016	272485	272954	273423	273892	274361	274830	275299	275768	276237	276706	277175	277644	278113	278582	279051	279520	279989	280458	280927	281396	281865	282334	282803	283272	283741	284210	284679	285148	285617	286086	286555	287024	287493	287962	288431	288900	289369	289838	290307	290776	291245	291714	292183	292652	293121	293590	294059	294528	294997	295466	295935	296404	296873	297342	297811	298280	298749	299218	299687	300156	300625	301094	301563	302032	302501	302970	303439	303908	304377	304846	305315	305784	306253	306722	307191	307660	308129	308598	309067	309536	310005	310474	310943	311412	311881	312350	312819	313288	313757	314226	314695	315164	315633	316102	316571	317040	317509	317978	318447	318916	319385	319854	320323	320792	321261	321730	322199	322668	323137	323606	324075	324544	325013	325482	325951	326420	326889	327358	327827	328296	328765	329234	329703	330172	330641	331110	331579	332048	332517	332986	333455	333924	334393	334862	335331	335800	336269	336738	337207	337676	338145	338614	339083	339552	340021	340490	340959	341428	341897	342366	342835	343304	343773	344242	344711	345180	345649	346118	346587	347056	347525	347994	348463	348932	349401	349870	350339	350808	351277	351746	352215	352684	353153	353622	354091	354560	355029	355498	355967	356436	356905	357374	357843	358312	358781	359250	359719	360188	360657	361126	361595	362064	362533	363002	363471	363940	364409	364878	365347	365816	366285	366754	367223	367692	368161	368630	369099	369568	370037	370506	370975	371444	371913	372382	372851	373320	373789	374258	374727	375196	375665	376134	376603	377072	377541	378010	378479	378948	379417	379886	380355	380824	381293	381762	382231	382700	383169	383638	384107	384576	385045	385514	385983	386452	386921	387390	387859	388328	388797	389266	389735	390204	390673	391142	391611	392080	392549	393018	393487	393956	394425	394894	395363	395832	396301	396770	397239	397708	398177	398646	399115	399584	400053	400522	400991	401460	401929	402398	402867	403336	403805	404274	404743	405212	405681	406150	406619	407088	407557	408026	408495	408964	409433	409902	410371	410840	411309	411778	412247	412716	413185	413654	414123	414592	415061	415530	415999	416468	416937	417406	417875	418344	418813	419282	419751	420220	420689	421158	421627	422096	422565	423034	423503	423972	424441	424910	425379	425848	426317	426786	427255	427724	428193	428662	429131	429600	430069	430538	431007	431476	431945	432414	432883	433352	433821	434290	434759	435228	435697	436166	436635	437104	437573	438042	438511	438980	439449	439918	440387	440856	441325	441794	442263	442732	443201	443670	444139	444608	445077	445546	446015	446484	446953	447422	447891	448360	448829	449298	449767	450236	450705	451174	451643	452112	452581	453050	453519	453988	454457	454926	455395	455864	456333	456802	457271	457740	458209	458678	459147	459616	460085	460554

REDUCTION OF DIAMETERS TO INCHES

Diameter of Rivet	1½	2¼	3	3¼	3½	4	4½	5	5½	6	6¼	6½	7	8	8½	9¼	11¼	12½	16½	18½	
¼ inch.....	¾	¾	¾	1	1	1	1½	1½	1½	1½	1½	1½	1½	2	2	2	2	2	2	2	2
⅓ inch.....	¾	¾	1	1	1	1	1½	1½	1½	1½	1½	1½	2	2	2	2	2	2	2	2	2
¼ inch.....	1	1	1	1	1	1	1½	1½	1½	1½	1½	1½	2	2	2	2	2	2	2	2	2
⅓ inch.....	1	1	1	1	1	1	1½	1½	1½	1½	1½	1½	2	2	2	2	2	2	2	2	2
½ inch.....	1	1	1	1	1	1	1½	1½	1½	1½	1½	1½	2	2	2	2	2	2	2	2	2
⅓ inch.....	1	1	1	1	1	1	1½	1½	1½	1½	1½	1½	2	2	2	2	2	2	2	2	2
¼ inch.....	1	1	1	1	1	1	1½	1½	1½	1½	1½	1½	2	2	2	2	2	2	2	2	2
⅓ inch.....	1	1	1	1	1	1	1½	1½	1½	1½	1½	1½	2	2	2	2	2	2	2	2	2
½ inch.....	1	1	1	1	1	1	1½	1½	1½	1½	1½	1½	2	2	2	2	2	2	2	2	2
⅓ inch.....	1	1	1	1	1	1	1½	1½	1½	1½	1½	1½	2	2	2	2	2	2	2	2	2
¼ inch.....	1	1	1	1	1	1	1½	1½	1½	1½	1½	1½	2	2	2	2	2	2	2	2	2
1 inch.....	1	1	1	1	1	1	1½	1½	1½	1½	1½	1½	2	2	2	2	2	2	2	2	2
1½ inch.....	1	1	1	1	1	1	1½	1½	1½	1½	1½	1½	2	2	2	2	2	2	2	2	2
1¾ inch.....	1	1	1	1	1	1	1½	1½	1½	1½	1½	1½	2	2	2	2	2	2	2	2	2

EXAMPLES. What is the distance in inches of ¼ in. rivets spaced 3 diameters apart? Follow the ¼ in. line across until column with 3 at the top is reached, and at the intersection is 1½, which is the distance in inches.

NUMBER OF CONE HEAD RIVETS IN 100 POUNDS\*

Scant Diameter

Length Under Head	Diameter									
	3/8"	1/2"	5/8"	3/4"	7/8"	1"	1 1/8"	1 1/4"	1 3/8"	1 1/2"
3/8" .....	1162	840	645	.....	.....	.....	.....	.....	.....	.....
1/2" .....	1075	787	606	.....	.....	.....	.....	.....	.....	.....
1" .....	1010	735	568	446	355	288	.....	.....	.....	.....
1 1/8" .....	943	694	537	423	337	275	.....	.....	.....	.....
1 1/4" .....	892	657	510	401	321	262	217	163	.....	.....
1 3/8" .....	840	621	483	383	306	251	208	147	107	.....
1 1/2" .....	800	591	460	364	293	240	200	142	104	78.7
1 5/8" .....	757	564	440	349	280	230	192	136	100	75.7
1 3/4" .....	724	537	420	334	269	221	185	131	97	73.5
1 7/8" .....	689	515	403	321	259	213	178	128	93	71.4
2" .....	662	495	367	308	249	205	172	123	90	68.9
2 1/8" .....	632	476	371	296	240	198	166	119	87	67.1
2 1/4" .....	609	456	358	284	232	191	161	114	85	65.3
2 3/8" .....	584	440	346	276	224	185	156	112	82	63.2
2 1/2" .....	561	425	333	267	216	179	151	108	80	61.7
2 5/8" .....	543	409	322	258	210	173	147	105	78	60.2
2 3/4" .....	523	396	312	250	203	168	142	103	75	58.4
2 7/8" .....	507	384	302	242	197	163	138	100	74	57.1
3" .....	490	371	293	235	191	159	135	97	71	55.8
3 1/8" .....	460	350	276	222	181	150	128	92	68	53.1
3 1/4" .....	436	331	261	210	172	143	120	87	65	50.7
3 3/8" .....	411	313	248	200	163	136	114	84	62	48.7
4" .....	390	296	235	190	156	129	109	80	59	46.7
4 1/8" .....	371	284	225	181	149	124	105	76	57	44.8
4 1/4" .....	354	271	215	173	142	119	101	74	55	43.1
4 3/8" .....	338	259	205	166	136	114	97	70	53	41.6
5" .....	324	248	197	159	131	109	93	68	51	40.1
5 1/8" .....	311	238	189	153	126	105	90	66	49	38.7
5 1/4" .....	299	229	182	147	121	101	88	63	47	37.5
5 3/8" .....	288	221	176	142	117	98	83	61	46	36.3
6" .....	277	213	169	137	113	95	80	59	44	35.2
6 1/8" .....	258	199	158	128	106	89	75	56	42	33.2
7" .....	242	186	148	120	100	84	71	52	39	31.3

\* Cone head sometimes called pan head. (Hoopce & Townsend, Phila., Pa.)

† All Rivets larger than one inch are made to exact diameter.

In rivet calculations, it is customary to disregard friction and to proportion rivets to the entire stress to be transmitted. They must be of sufficient size and number to resist shear and to afford such bearing area as not to cause distortion of the metal at the rivet holes.

(Pocket Companion, Carnegie Steel Co.)

## WEIGHT OF CONE HEAD RIVETS PER 100\*

## Sawt Diameter

Length Under Head	Diameter									
	3/8"	1/2"	5/8"	3/4"	7/8"	1"	1 1/8"	1 1/4"	1 3/8"	1 1/2"
3/8"	8.6	11.9	15.5	....	....	....	....	....	....	....
1/2"	9.3	12.7	16.5	....	....	....	....	....	....	....
1"	9.9	13.6	17.6	22.4	28.1	34.5	....	....	....	....
1 1/8"	10.6	14.4	18.6	23.6	29.6	36.3	....	....	....	....
1 1/4"	11.2	15.2	19.6	24.9	31.1	38.1	46	65	....	....
1 3/8"	11.9	16.1	20.7	26.1	32.6	39.8	48	68	93	....
1 1/2"	12.5	16.9	21.7	27.4	34.1	41.6	50	70	96	127
1 3/4"	13.2	17.7	22.7	28.6	35.6	43.4	52	73	100	132
1 7/8"	13.8	18.6	23.8	29.9	37.1	45.1	54	76	103	136
2"	14.5	19.4	24.8	31.1	38.6	46.9	56	78	107	140
2 1/8"	15.1	20.2	25.8	32.4	40.1	48.7	58	81	110	145
2 1/4"	15.8	21.0	26.9	33.7	41.6	50.5	60	84	114	149
2 3/8"	16.4	21.9	27.9	34.9	43.1	52.2	62	87	117	153
2 1/2"	17.1	22.7	29.9	36.2	44.6	54.0	64	89	121	158
2 3/4"	17.8	23.5	30.0	37.4	46.1	55.8	66	92	124	162
2 7/8"	18.4	24.4	31.0	38.7	47.6	57.5	68	95	128	166
3"	19.1	25.2	32.0	39.9	49.1	59.3	70	97	132	171
3 1/8"	19.7	26.0	33.1	41.2	50.6	61.1	72	100	135	175
3 1/4"	20.4	26.9	34.1	42.5	52.1	62.8	74	103	139	179
3 3/8"	21.7	28.5	36.2	45.0	55.1	66.4	78	108	146	188
3 1/2"	22.9	30.2	38.2	47.5	58.1	69.9	83	114	153	197
3 3/4"	24.3	31.9	40.3	50.0	61.1	73.4	87	119	160	205
4"	25.6	33.5	42.4	52.5	64.1	77.0	91	124	167	214
4 1/8"	26.9	35.2	44.4	55.0	67.1	80.5	95	130	174	223
4 1/4"	28.2	36.9	46.5	57.5	70.1	84.0	99	135	181	232
4 3/8"	29.5	38.5	48.6	60.0	73.1	87.6	103	141	188	240
5"	30.8	40.2	50.6	62.6	76.1	91.1	107	146	195	249
5 1/8"	32.1	41.9	52.7	65.1	79.1	94.6	111	151	202	258
5 1/4"	33.4	43.5	54.8	67.6	82.1	98.2	115	157	209	266
5 3/8"	34.7	45.2	56.8	70.1	85.1	101.7	120	162	216	275
6"	36.0	46.8	58.9	72.6	88.1	105.2	124	167	223	284
6 1/2"	38.7	50.2	63.0	77.6	94.1	112.3	132	178	237	301
7"	41.3	53.5	67.2	82.7	100.2	119.4	140	189	251	319
Weight of Heads...	4.7	6.9	9.3	12.3	16.1	20.4	26	38	54	75

\* Cone head sometimes called pan head. (Hoopes &amp; Townsend, Phila., Pa.)

† All Rivets larger than one inch are made to exact diameter.

**Boiler Rivet Steel.**—The Am. Soc. for Testing Materials states that the steel shall be made by the open hearth process. Chemical composition, manganese .30-.50%, phosphorus not over .04%, sulphur not over .045%. Tensile strength 45,000-50,000 lb. per sq. in., yield point minimum .5 tensile strength, elongation in 8 ins. minimum per cent  $\frac{1,500,000}{\text{tens. str.}}$  but not to exceed 30%.

## SECTION III

### SHIPBUILDING MATERIALS

#### IRON AND STEEL, NON-FERROUS METALS AND ALLOYS, WOOD, MISCELLANEOUS NON-METALLIC MATERIALS

#### IRON AND STEEL

Steel is a compound of iron and carbon intermediate in composition between cast and wrought iron, but having a higher specific gravity than either.

	Per cent. of carbon	Sp. gr.	Properties
Cast iron.....	5 to 2	7.2	not malleable nor temperable
Steel.....	1.5 to .10	7.8	malleable and temperable
Wrought iron.....	.30 to .05	7.7	malleable, not temperable

The principal methods of manufacture are the crucible process, the open hearth process, and the Bessemer. In the crucible, impure wrought iron or blister steel with carbon and a flux is fused in a sealed vessel which air cannot enter: the best tool steels are made thus. In the open hearth process, pig iron is melted, wrought iron scrap being added until the proper degree of carbonization is secured. In the Bessemer process, pig iron is completely decarbonized in a converter by an air blast and then recarbonized to the proper degree by the addition of spiegeleisen. The metal for the open hearth or for the Bessemer converter is cast into ingots which are rolled in mills to the required forms. The open hearth process produces steel for shafts, axles, armor plate and for structural purposes, and the Bessemer process mainly produces steel for railroad rail. [Mechanical Eng'rs Handbook, Kent.]

The physical properties of steel depend upon the method of manufacture and chemical composition, carbon being the controlling element in regard to strength, and the same is the case with respect to ultimate elongation. The higher the percentage of carbon within a reasonable limit the greater the strength and the less the

ultimate elongation. Steel may be given special properties by adding other elements as nickel, chromium, etc., in which case the steel is known as alloy or special steel, being given the name of the element added, as nickel steel, chromium steel, etc.

**Carbon Steel.**—Here carbon is the controlling element. Carbon steel may be classified as follows:

Soft,	.05-.20% carbon	not temperable, easily welded
Medium,	.15-.40% carbon	poor temper, weldable
Hard,	.30-.70% carbon	temperable, welded with difficulty
Veryhard,	.60-1% carbon	high temper, not weldable

Increasing the carbon content of steel increases its strength, hardness, brittleness, and susceptibility to cracking under sudden cooling or heating, it also diminishes the elongation and reduction of area to fracture. Phosphorus increases the tensile strength about 1,000 lb. per square inch for each .01% but tends to make the metal brittle.

**AVERAGE PROPERTIES OF STEEL IN POUNDS PER SQUARE INCH**

	Medium	Hard
Elastic limit in tension and compression	35,000	50,000
Elastic limit shear.....	30,000	40,000
Tensile strength.....	60,000	100,000
Compressive strength.....	60,000	120,000
Shearing strength.....	50,000	75,000
Modulus of rupture.....		110,000
Modulus of elasticity, tension.....	30,000,000	30,000,000
Modulus of elasticity, shear.....	12,000,000	12,000,000

Ultimate elongation ranges from 5 to 30%, the higher the amount of carbon the less the elongation. Reduction of area follows the same rule, ranging from 10 to 60%. Coefficient of expansion .0000065° F. Sp. gr. about 7.8. Weight per cu. ft. 490-491 lb.

**Manganese Steel.**—Manganese increases the tensile strength from 80 to 400 lb. per square inch for each .01% depending on the carbon present and whether the steel is acid or basic. In its most serviceable form manganese steel contains about 13 to 14% of manganese and is practically non-magnetic. On account of its extreme hardness it is difficult to machine.

The usual analysis of manganese steel lies between the following limits, manganese 11 to 14%, carbon 1. to 1.3%, silicon .3 to .8%, phosphorus .05 to .08%, the sulphur content being so as to be negligible. Manganese steel when tested in the form of a  $\frac{1}{4}$ -in.

round bar should show a tensile strength of 140,000 lb. per square inch, elastic limit 90,000, reduction of area not less than 50%, elongation in 2 ins. not less than 20%. Castings on cooling shrink to a noticeable extent, and an allowance of about  $\frac{1}{4}$  of an in. should be made per foot.

**Nickel Steel.**—Ordinarily contains 1.5 to 4.5% of nickel and .2 to .5% of carbon. Nickel steel has a larger resistance to wear and abrasion than carbon steel and greater resistance to corrosion. When the percentage of nickel is less than 5%, the elastic limit and tensile strength are increased without any reduction in the elongation or in the contraction of area. Because of this increase in strength without loss of ductility nickel steel is used for shafting, connecting rods, etc., where a steel is required that will combine great strength and toughness. Tests made at the Watertown Arsenal (Watertown, Mass.) on a 3.37% nickel steel gave an average elastic limit of 56,700 lb. per square inch and a tensile strength of 90,300. It is practically non-corrodible, and has a high electrical resistance which does not seem to vary much with the percentage of nickel.

#### COMPARISON OF SIMPLE STEEL AND NICKEL STEEL FORGINGS

Steel Forging					Nickel Steel Forging					
Carbon	Tensile Strength	Elastic Limit	Elongation, %	Reduction of Area, %	Carbon	Nickel	Tensile Strength	Elastic Limit	Elongation, %	Reduction of Area, %
.20	55,000	28,000	34	60	.20	3.5	85,000	48,000	26	55
.30	75,000	37,000	30	50	.30	3.5	95,000	60,000	22	48
.40	85,000	43,000	26	45	.40	3.5	111,000	72,000	18	40
.50	95,000	48,000	21	40	.50	3.5	125,000	85,000	13	32

Nickel steel in the form of shapes, plates, or bars containing 3.25% nickel has a tensile strength of 85,000–100,000 lb. per square inch, elastic limit 50,000, shearing  $\frac{3}{4}$  of the tensile strength, modulus of elasticity 29,000,000, elongation 17.6–15%. Sp. gr. of low carbon nickel steel containing up to 15% nickel is from 7.86 to 7.9 and from 19 to 39% is 7.91 to 8.08.

**Silicon Steel.**—The addition of silicon to steel appears to increase the strength about 80 lb. per square inch for every .01% up to a content of 4%; beyond this it impairs the ductility.

**Tungsten Steel** is characterized by hardness and toughness and



its remarkable tempering properties. The tungsten content ranges from .5% in ordinary-bar steel, 2 to 5% in finishing and intermediate steels, 4.5 to 12% in self-hardening or air-hardening steels and 14 to 26% in high speed steels.

**Vanadium Steel.**—The vanadium content is usually less than 3%. Its effect is to improve the tensile strength, hardness and toughness.

**Chromium Steel.**—Here the percentage of chromium varies from 2.5 to 5%, and of carbon from .8 to .2%. This steel is very hard and tough. Armor-piercing projectiles are made of it.

**Chromium-Nickel Steel.**—The influence of both chromium and nickel is to increase the hardness and strength. Gears, axles, shafts, and gun barrels are made of it.

**Chromium-Vanadium Steel.**—Particularly suitable for springs. Axles and gears are also made of this steel.

**Structural Steel.**—This is carbon steel rolled into shapes and plates. Lloyd's rules state: "Steel for shipbuilding shall be made by the open hearth process, acid or basic. The tensile breaking strength of steel plates shall be between the limits of 28 and 32 tons per square inch. Plates intended for cold flanging, the tensile strength shall be between 26 and 30 tons per square inch. The elongation measured on a standard test piece having a gauge length of 8 ins., shall not be less than 20% for material .375 inch in thickness and upwards, and not less than 16% for material below .375 inch in thickness. The tensile strength of angles, channels, etc., shall be between 28 and 33 tons per square inch. The elongation on a standard test piece having a gauge length of 8 ins. shall not be less than 20% for material .375 inch in thickness and upwards, and not less than 16% for material below. For cold and temper tests the test pieces shall withstand without fracture, being doubled over until the internal radius is equal to  $1\frac{1}{2}$  times the thickness of the test piece and the sides are parallel."

American Bureau of Shipping Rules state: "Steel plates, angles and shapes shall have an ultimate tensile strength of from 58,000 to 68,000 lb. per square inch of section, an elastic limit of one-half the ultimate tensile strength, a reduction of area at point of fracture of at least 40% and an elongation of 22% in 8 ins. for plates 18 lb. thick and over, and 18% for plates under 18 lb. Material of greater ultimate tensile strength than 68,000 lb. per square inch and not above 70,000 lb. may be accepted provided the elongation and reduction are as specified and the bending tests meet the re-

quirements. Shapes and angles in excess of 68,000 lb. tensile strength must be capable of being efficiently welded. Specimens for all materials (plates and shapes) must stand bending through 180° on a radius of one-half its thickness without fracture on the convex side either cold or after being heated to cherry red and quenching in water at 80° F."

Abstracts from the Specifications of Structural Steel for Ships, issued by the American Society for Testing Materials, are as follows: "The steel shall be made by the open hearth process and shall conform to the following requirements as to chemical composition.

Phosphorus:	{ Acid.....	not over .06%
	{ Basic.....	not over .04%
Sulphur.....		not over .05%

"Tension Tests.—Tensile strength 58,000–68,000 lb. per square inch.

Yield point maximum .5 tensile strength.

Elongation in 8 ins. minimum per cent.  $\frac{1,500,000}{\text{tensile strength}}$

"For material over  $\frac{3}{4}$  inch in thickness, a deduction of one from the percentage of elongation as given above shall be made for each increase of  $\frac{1}{8}$  inch in thickness above  $\frac{3}{4}$  inch to a minimum of 18%. For material  $\frac{1}{4}$  inch or under in thickness the elongation shall be measured on a gauge length of 24 times the thickness of the specimen.

"Bend Tests.—The test specimen shall bend cold through 180° without cracking on the outside of the bent portion as follows: For material  $\frac{3}{4}$  inch or under in thickness, around a pin the diameter of which is equal to the thickness of the specimen, for material over  $\frac{3}{4}$  inch to and including  $1\frac{1}{4}$  inch in thickness around a pin the diameter of which is equal to  $1\frac{1}{2}$  times the thickness of the specimen, and for material over  $1\frac{1}{4}$  inch in thickness around a pin the diameter of which is equal to twice the thickness of the specimen.

"Test Specimens.—Tension and bend test specimens shall be taken from the finished rolled material. The specimens have a parallel section not less than 9 ins. long by  $1\frac{1}{2}$  ins. wide, broadened out at each end to about 2 ins. in width by about 3 ins. long, making approximately a total length of 18 ins.

"Permissible Variations.—The cross section or weight of each piece of steel shall not vary more than 2.5% from that specified;

except in the case of sheared plates which shall be covered by the following permissible variations to apply to single plates.

"When ordered to weight for plates 12½ lb. per square foot or over, under 100 ins. in width, 2.5% above or below the specified

Thickness Ordered, Ins.	Nominal Weight, Lb. per Sq. Ft.	Allowable Excess, Expressed as Percentage of Nominal Weight for Width of Plate as Follows:						
		Under 50 Ins.	50 Ins. to 70 Ins. Excl.	70 Ins. or Over	Under 75 Ins.	75 Ins. to 100 Ins. Excl.	100 Ins. to 115 Ins. Excl.	115 Ins. or Over
½ to ⅝	5.10 to 6.37	10	15	20	..	..	..	..
⅝ to ¾	6.37 to 7.65	8.5	12.5	17	..	..	..	..
¾ to 1	7.65 to 10.20	7	10	15	..	..	..	..
1	10.20	..	..	..	10	14	18	..
1 ¼	12.75	..	..	..	8	12	16	..
1 ½	15.30	..	..	..	7	10	13	17
1 ¾	17.85	..	..	..	6	8	10	13
2	20.40	..	..	..	5	7	9	12
2 ¼	22.95	..	..	..	4.5	6.5	8.5	11
2 ½	25.50	..	..	..	4	6	8	10
Over ½	.....	..	..	..	3.5	5	6.5	9

#### PRINCIPAL REQUIREMENTS FOR STEEL AND IRON FOR U. S. NAVAL VESSELS

Quality of Material	Use	Minimum Tensile Strength, Lb. per Square Inch	Elongation	
			Percent	Ins.
Medium steel, open hearth, carbon.	Plates and shapes for hull.	60,000	25	8
High tensile steel, open hearth, carbon, nickel, or silicon.	Plates and shapes for hull.	80,000	20	8
Medium steel, open hearth, carbon.	Rods and bars for rivets, bolts, stanchions, davits, etc.	< 1½ in. dia., = 58,000	28	8
		> 1½ in. dia., = 60,000	30	32
High-tensile steel, open hearth, carbon, nickel, or silicon.	Rods and bars for rivets, bolts, stanchions, davits, etc.	< 1½ in. dia., = 75,000	23	8
		> 1½ in. dia., = 75,000	25	2
Steel forgings, Class A, open hearth, nickel or carbon.	Forgings exposed to dynamic actions as gun mounts.	80,000	25	2
Steel forgings, Class B, open hearth, carbon.	Stems and stern posts, rudder stocks, etc.	60,000	30	2
Steel castings, Class A.	Hawse pipes, turret tracks, etc.	80,000	17	2
Steel castings, Class B.	Stems, stern posts, rudder frames, struts, etc.	60,000 to 80,000	22	2
Wrought iron . . . . .	Miscellaneous forgings.	48,000	26	8

weight; 100 ins. in width or over 5% above or below the specified weight. For plates under 12½ lb., under 75 ins. in width 2.5% above or below the specified weight, 75 to 100 ins. exclusive in width 5% above or 3% below the specified weight, 100 ins. in width or over 10% above or 3% below the specified weight.

"When ordered to gauge, the thickness of each plate shall not vary more than .01 inch under that ordered. An excess over the nominal weight corresponding to the dimensions on the order shall be allowed for each plate, if not more than that shown on the table given on page 116, one cubic inch of rolled steel being assumed to weigh .2833 lb."

The ultimate strength of steel in tension and compression is practically the same, and may for different kinds of steel be assumed as follows:

Kind of Steel	Ultimate Strength, Pounds per Square Inch
Structural steel for rivets.....	55,000
Structural steel for beams.....	60,000
Boiler steel for rivets.....	50,000
Boiler steel for plates.....	60,000
Machine steel.....	75,000
Gun steel.....	90,000
Axle steel.....	100,000
Spring steel.....	125,000

**Rivet Steel.**—Lloyd's requirements are: "The tensile strength of steel rivet bars shall be between the limits of 25 and 30 tons per square inch of section with an elongation of not less than 25% of the gauge length of eight times the diameter of the test piece."

American Bureau of Shipping: "Materials for rivets shall be of best open hearth steel, limit of phosphorus and sulphur .04 of one per cent. Tensile strength to be not less than 45,000 nor more than 55,000 lb. per square inch."

Abstracts from the Specifications for Rivet Steel for Ships issued by the American Society for Testing Materials are as follows: "The steel shall be made by the open hearth process and shall conform to the requirements given below:

Phosphorus:	{ Acid.....	not over .06%
	{ Basic.....	not over .04%
Sulphur.....		not over .045%

"Tension Tests.—Tensile strength 55,000–65,000 lb. per square inch.  
Yield point minimum, .5 tensile strength

Elongation in 8 ins. minimum per cent.  $\frac{1,500,000}{\text{tensile strength}}$

"For bars over  $\frac{3}{4}$  inch in diameter, a deduction of one from the percentage of elongation specified above shall be made for each increase of  $\frac{1}{8}$  inch in diameter above  $\frac{3}{4}$  inch.

"Bend Tests.—The test specimen shall bend cold through 180° flat on itself without cracking on the outside of the bent portion.

"Flattening Tests.—The rivet head shall flatten while hot to a diameter of  $2\frac{1}{2}$  times the diameter of the shank without cracking at the edges.

"Permissible Variations.—The gauge of bars 1 in. or under in diameter shall not vary more than .01 inch from that specified; the gauge bars over 1 in. to and including 2 ins. in diameter shall not vary more than  $\frac{1}{16}$  under nor more than  $\frac{1}{32}$  inch over that specified."

See also Rivets and Riveting.

Cast Steel.—A malleable alloy of iron cast from a fluid mass. It is distinguished from cast iron which is not malleable by being much lower in carbon and from wrought iron by being free from intermingled slag. Stern frames, tillers, quadrants, gun mounts, etc., are made of it.

Lloyd's rules state: "The tensile breaking strength determined from test pieces of standard dimensions is to be between 26 and 35 tons per sq. in. with an elongation of not less than 20%. They must also stand being bent cold through an angle of 120°, the internal radius not being greater than one inch. The castings are also to be subjected to dropping and hammer tests."

American Bureau of Shipping requirements are: "Tensile strength not less than 60,000 lb. per sq. in., elongation not less than 15% in 8 ins. For moving parts a bar one inch square shall bend cold through an angle of 120° over a radius not exceeding  $1\frac{1}{2}$  ins. and without showing cracks or flaws. For other castings, tests will be the same except that the angle may be reduced to 90°. Drop tests shall be made from a height not exceeding 10 ft. on a hard road or floor."

The following abstract is from the Specifications of Steel Castings issued by the American Society for Testing Materials: "These specifications cover two classes of castings, viz., Class A ordinary castings for which no physical requirements are specified, and

Class B for which requirements are specified. There are three grades in Class B, hard, medium and soft.

“Chemical Composition.—

	Class A	Class B
Carbon.....	not over .30%	.....
Phosphorus.....	not over .06%	not over .05%
Sulphur.....	.....	not over .05%

“Physical Properties.—

	Hard	Medium	Soft
Tensile strength, lbs. per sq. in.....	80,000	70,000	60,000
Yield point, lbs. per sq. in.....	36,000	31,500	27,000
Elongation in 2 ins., per cent.....	15	18	22
Reduction of area, per cent.....	20	25	30

“Bend Tests.—The test specimen for soft castings shall bend cold through 120°, and for medium castings through 90°, around a 1-inch pin, without cracking on the outside of the bent portion. Hard castings shall not be subject to bend test requirements.

“Heat Treatment.—Class A castings need not be annealed unless otherwise specified. Class B shall be annealed, which consists in allowing the castings to become cold, and then uniformly reheating them to the proper temperature to refine the grain, and allowing them to cool uniformly and slowly. All castings for ships shall be annealed.

“Percussion Test.—The casting is suspended by chains and hammered all over by a hammer of a weight approved by the purchaser. If cracks, flaws or weakness appear after such treatment the casting will be rejected.”

Shrinkage allowed for casting about  $\frac{1}{4}$  of an inch per foot. Weight per cubic foot, 490 lb. Sp. gr. 7.8-7.9.

Iron.—Iron plates and shapes for ships have been superseded by steel as the former are heavier for a given strength. Lloyd's states: “Deck plating and ordinary floors, also the floors, girders and top plating of double bottoms in holds, coal bunker and other bulkheads, shaft tunnels, casings around engines, hatchway coamings, bulwarks and deck houses may be of iron 10% in excess of the thicknesses in steel where scantlings for the same are provided for in the Rules. No other parts of the vessel are to be of iron without the special sanction of the Committee.” Pure iron has a tensile strength of 40,000 lb. and is very ductile. Weight per cubic foot 480 lb. Sp. gr. 7.70.

**Wrought Iron.**—Is tough, ductile, malleable, weldable but cannot be tempered. Boat davits, rail stanchions and a variety of fittings are made of it. It is composed chiefly of pure iron and slag (iron silicate) and, in small amounts, the following impurities:

	Common wrought iron	Best wrought iron.
Carbon.....	.05%	.06%
Phosphorus.....	.35	.18
Sulphur.....	.06	.04
Silicon.....	.23	.20
Manganese.....	.....	.06
Slag.....	about 3.3	2.80

**Tension.**—Average of many tests at Columbia University, New York, on good wrought iron for general purposes:

Elastic limit pounds per square inch.....	31,000
Ultimate strength.....	51,000
Elongation in 8 ins. per cent.....	21
Reduction of area per cent.....	30
Modulus of elasticity pounds per square inch..	28,200,000

**Shear and Torsion.**—Best wrought iron which had an ultimate tensile strength of 48,400 gave as follows:

Ultimate strength in single shear pounds per square inch.....	42,000
Elastic limit in torsion.....	20,530
Ultimate strength.....	56,400
Modulus of elasticity.....	12,800,000

**Compression.**—Ultimate compressive strength of good wrought iron varies from 55,000 to 60,000 lb. per square inch. Elastic limit in compression is from 40 to 50% the ultimate strength. • Weight per cubic foot, 485 lb. Sp. gr. 7.6-7.9.

(From Civil Engineer's Handbook, M. Merriman.)

**Cast Iron.**—Is brittle, weak in tension and strong in compression. Its great usefulness comes from the fact that it can be readily cast in a variety of forms. For engine cylinders hard close grain iron is called for. Cast iron when exposed to continued heat becomes permanently expanded  $1\frac{1}{4}$  to 3% of its length, hence grate bars should be allowed about 4% play.

Carbon, silicon and other impurities affect the physical properties. Carbon occurs as combined carbon or as a graphite or uncombined carbon. When the former the metal is hard, brittle, white, weak in tension and strong in compression, while in the latter (graphitic

carbon) the iron is soft, gray, and weak in tension and compression. Silicon in cast iron up to .5% increases its compressive strength, and the tensile strength is increased up to 2%. Manganese when below 1% is not injurious, but when above, it causes hardness and brittleness. Phosphorus makes the iron weaker and becomes a serious impurity when it occurs in quantities above 1.5%. Sulphur causes whiteness, brittleness, hardness and greater shrinkage, and is in general an objectionable impurity.

Cast iron has an average tensile strength of 22,500 lb. per square inch, compression about 90,000, modulus of elasticity in tension varies from 15,000,000 to 20,000,000 lb. per square inch, and in shear 5,000,000 to 7,000,000. Weight per cubic foot, 449.2. Sp. gr. 6.85 to 7.4.

**Malleable Iron.**—This is cast iron that has been heated to a temperature of about 2,000° F. The castings are packed in retorts or annealing pots and an oxide of iron (generally hematite ore) is packed with them. The castings are kept red hot for several days, causing the carbon near the surface to be burned out, leaving the outer surface tough and strong like wrought iron while the interior is hard. Pipe fittings largely are made of it. Tensile strength 37,000 lb. per square inch.

#### PICKLING AND GALVANIZING

**Pickling.**—Steel plates as received from the mill have a scale which must be removed before they can be painted or cemented, otherwise when the scale falls off bare places will be left. The scale is removed by pickling, the plate being stood on end in a hydrochloric acid bath (19 parts water and 1 of acid), for about 12 hours, then taken out and thoroughly washed with fresh water.

**Galvanizing.**—Cast iron and wrought iron fittings exposed to the weather or to dampness, and sometimes the steel frames and floors of torpedo boats and destroyers are galvanized. Before galvanizing all paint must be burned off and the fittings cleaned, after which they are placed in a bath of one part of hydrochloric acid and 40 parts of water to remove rust and grease. They are next dried and placed in a zinc bath from which they are taken after a sufficient coating of zinc has been deposited on them. The additional weight due to galvanizing by the hot process is 2¼ to 2½ ounces and by the electric process about 1 ounce per square foot of exposed surface. All steel plates less than ¼ of an inch thick should be galvanized before assembling.



The outward appearance of any galvanized article is not necessarily an indication of its excellence. The only final test of a zinc coating is the test of time under actual conditions of exposure. As this takes too long for commercial purposes, various tests have been devised; among them may be mentioned the lead acetate by Prof. W. H. Walker (Massachusetts Institute of Technology, Boston, Mass.). This test is designed to show the weight of actual coating covering products, and takes into consideration the impurities in the coating. The solution employed removes from the articles both the zinc and zinc iron alloys present. The accurate weight before and after testing furnishes the basis for computing the quantitative value of the coating. The weighings must be accurate to one milligram. The length of time the sample is being tested is about 3 minutes. For further particulars see "Galvanizing and Tinning," by W. T. Flanders.

WEIGHTS OF STEEL PLATES IN HUNDREDTHS OF AN INCH

Thickness, Ins.	Weight in Lb. per Sq. Ft.	Thickness, Ins.	Weight in Lb. per Sq. Ft.
$\frac{1}{100}$	.408	$\frac{55}{100}$	22.44
$\frac{5}{100}$	2.04	$\frac{60}{100}$	24.48
$\frac{10}{100}$	4.08	$\frac{65}{100}$	26.52
$\frac{15}{100}$	6.12	$\frac{70}{100}$	28.56
$\frac{20}{100}$	8.16	$\frac{75}{100}$	30.60
$\frac{25}{100}$	10.20	$\frac{80}{100}$	32.64
$\frac{30}{100}$	12.24	$\frac{85}{100}$	34.68
$\frac{35}{100}$	14.28	$\frac{90}{100}$	36.72
$\frac{40}{100}$	16.32	$\frac{95}{100}$	38.76
$\frac{45}{100}$	18.36	$\frac{100}{100}$	40.80
$\frac{50}{100}$	20.40		

## STANDARD GAUGES

Number of Gauge	Thickness in Decimals of an Inch					
	Birmingham Wire Gauge (B.w.g.)	British Imperial	United States Standard	Brown and Sharpe	Stub's Steel Wire	Washburn and Moen
000000	....	.500	.500	.....	....	....
000000	....	.464	.46875	.....	....	....
00000	....	.432	.4375	.....	....	....
0000	.454	.400	.40625	.46	....	.3938
000	.425	.372	.375	.40964	....	.3625
00	.380	.348	.34375	.3648	....	.3310
0	.340	.324	.3125	.32486	....	.3065
1	.300	.300	.28125	.2893	.227	.2830
2	.284	.276	.265625	.25763	.219	.2625
3	.259	.252	.25	.22942	.212	.2437
4	.238	.232	.234375	.20431	.207	.2253
5	.220	.212	.21875	.18194	.204	.2070
6	.203	.192	.203125	.16202	.201	.1920
7	.180	.176	.1875	.14428	.199	.1770
8	.165	.160	.171875	.12849	.197	.1620
9	.148	.144	.15625	.11443	.194	.1483
10	.134	.128	.140625	.10189	.191	.1350
11	.120	.116	.125	.090742	.188	.1205
12	.109	.104	.109375	.080808	.185	.1055
13	.095	.092	.09375	.071961	.182	.0915
14	.083	.080	.078125	.064084	.180	.0800
15	.072	.072	.0703125	.057068	.178	.0720
16	.065	.064	.0625	.05082	.175	.0625
17	.058	.056	.05625	.045257	.172	.0540
18	.049	.048	.05	.040303	.168	.0475
19	.042	.040	.04375	.03589	.164	.0410
20	.035	.036	.0375	.031961	.161	.0348
21	.032	.032	.034375	.028462	.157	.03175
22	.028	.028	.03125	.025347	.155	.0286
23	.025	.024	.028125	.022571	.153	.0258
24	.022	.022	.025	.0201	.151	.0230
25	.020	.020	.021875	.0179	.148	.0204
26	.018	.018	.01875	.01594	.146	.0181
27	.016	.0164	.0171875	.014195	.143	.0173
28	.014	.0148	.015625	.012641	.139	.0162
29	.013	.0136	.0140625	.011257	.134	.0150
30	.012	.0124	.0125	.010025	.127	.0140
31	.010	.0116	.0109375	.008928	.120	.0132
32	.009	.0108	.01015625	.00795	.115	.0128
33	.008	.0100	.009375	.00708	.112	.0118
34	.007	.0092	.008593	.006304	.110	.0104
35	.005	.0084	.007812	.005614	.108	.0095
36	.004	.0076	.007031	.005	.106	.0090
37	....	.0068	.006640	.004453	.103	....
38	....	.0060	.00625	.003965	.101	....
39	....	....	....	.003531	.099	....
40	....	....	....	.003144	.097	....

**UNITED STATES STANDARD GAUGE FOR SHEET AND PLATE IRON  
AND STEEL**

Number of Gauge	Approximate Thick- ness in Fractions of an Inch	Approximate Thick- ness in Decimal Parts of an Inch	Weight per Square Foot in Pounds Avoirdupois <sup>1</sup>
0000000	1/2	.5	20.
000000	15/32	.46875	18.75
00000	7/16	.4375	17.5
0000	13/32	.40625	16.25
000	3/8	.375	15.
00	11/32	.34375	13.75
0	5/16	.3125	12.5
1	9/32	.28125	11.25
2	17/64	.265625	10.625
3	1/4	.25	10.
4	15/64	.234375	9.375
5	7/32	.21875	8.75
6	13/64	.203125	8.125
7	3/16	.1875	7.5
8	11/64	.171875	6.875
9	5/32	.15625	6.25
10	9/64	.140625	5.625
11	1/8	.125	5.
12	7/64	.109375	4.375
13	3/32	.09375	3.75
14	5/64	.078125	3.125
15	9/128	.0703125	2.8125
16	1/16	.0625	2.5
17	9/160	.05625	2.25
18	1/20	.05	2.
19	7/160	.04375	1.75
20	3/80	.0375	1.5
21	11/320	.034375	1.375
22	1/32	.03125	1.25
23	9/320	.028125	1.125
24	1/40	.025	1.
25	7/320	.021875	.875
26	3/160	.01875	.75
27	11/640	.0171875	.6875
28	1/64	.015625	.625
29	9/640	.0140625	.5625
30	1/80	.0125	.5
31	7/640	.0109375	.4375
32	13/1280	.01015625	.40625
33	3/320	.009375	.375

**UNITED STATES STANDARD GAUGE FOR SHEET AND PLATE IRON  
AND STEEL—Continued**

Number of Gauge	Approximate Thickness in Fractions of an Inch	Approximate Thickness in Decimal Parts of an Inch	Weight per Square Foot in Pounds Avoirdupois <sup>1</sup>
34	11/1280	.00859375	.34375
35	5/640	.0078125	.3125
36	9/1280	.00703125	.28125
37	17/2560	.006640625	.265625
38	1/160	.00625	.25

On and after July first, eighteen hundred and ninety-three, the above and no other shall be used in determining duties and taxes levied by the United States of America on sheet and plate iron and steel. But this act shall not be construed to increase duties upon any article which may be imported.

In the practical use and application of the standard gauge hereby established a variation of two and one-half per cent, either way, may be allowed. Approved March 3, 1893.

The weight of flat galvanized sheets is based on the weight of black sheets and two and one-half (2½) ounces per square foot added for the increase caused by galvanizing.

<sup>1</sup> This is based on a cubic foot of wrought iron weighing 480 lb. Steel would be about 2 per cent heavier.

**DIAMOND CHECKERED PLATES FOR ENGINE AND BOILER ROOM  
FLOORS**

(Carnegie Steel Co.)

Thickness of Plate—Rib $\frac{3}{8}$ " Above Plate	Width and Length in Inches			Weight per Square Foot in Pounds
	6" to 11½"	12" to 48"	48½" to 60"	
½"	120	240	240	21.4
⅝"	120	240	240	18.9
⅜"	120	240	240	16.3
⅜"	120	240	240	13.8
¼"	120	240	240	11.2
⅜"	120	180	240	8.7

**Classification of Gauges.**—Brown & Sharpe (B & S) = American Wire Gauge (A W G); United States Standard Gauge (U S S G); Birmingham Wire Gauge (B W G); New British Standard (N B S) = British Imperial Wire Gauge (I W G) = British Standard Wire Gauge (S W G).

**WEIGHTS OF SHEETS AND PLATES OF STEEL, COPPER AND BRASS**  
(Birmingham Wire Gauge)

No. of Gauge	Thickness in Inches	Weight per Square Foot		
		Steel	Copper	Brass
0000	.454	18.5232	20.5662	19.4312
000	.425	17.3400	19.2525	18.1900
00	.380	15.5040	17.2140	16.2640
0	.340	13.8720	15.4020	14.5520
1	.300	12.2400	13.5900	12.8400
2	.284	11.5872	12.8652	12.1552
3	.259	10.5672	11.7327	11.0852
4	.238	9.7104	10.7814	10.1864
5	.220	8.9760	9.9660	9.4160
6	.203	8.2824	9.1959	8.6884
7	.180	7.3440	8.1540	7.7040
8	.165	6.7320	7.4745	7.0620
9	.148	6.0384	6.7044	6.3344
10	.134	5.4672	6.0702	5.7352
11	.120	4.8960	5.4360	5.1360
12	.109	4.4472	4.9377	4.6652
13	.095	3.8760	4.3035	4.0660
14	.083	3.3864	3.7599	3.5524
15	.072	2.9376	3.2616	3.0816
16	.065	2.6520	2.9445	2.7820
17	.058	2.3664	2.6274	2.4824
18	.049	1.9992	2.2197	2.0972
19	.042	1.7136	1.9026	1.7976
20	.035	1.4280	1.5855	1.4980
21	.032	1.3056	1.4496	1.3696
22	.028	1.1424	1.2684	1.1984
23	.025	1.0200	1.1325	1.0700
24	.022	.8976	.9966	.9416
25	.020	.8160	.9060	.8560
26	.018	.7344	.8154	.7704
27	.016	.6528	.7248	.6848
28	.014	.5712	.6342	.5992
29	.013	.5304	.5889	.5564
30	.012	.4896	.5436	.5136
31	.010	.4080	.4530	.4280
32	.009	.3672	.4077	.3852
33	.008	.3264	.3624	.3424
34	.007	.2856	.3171	.2996
35	.005	.2040	.2265	.2140
36	.004	.1632	.1812	.1712
Specific gravities.....		7.85	8.72	8.24
Weight of a cubic foot...		489.6	543.6	513.6
Weight of a cubic inch ..		.2833	.3146	.2972

WEIGHTS OF SHEETS AND PLATES OF STEEL, COPPER AND BRASS  
(American or Brown and Sharpe Gauge)

No. of Gauge	Thickness in Inches	Weight per Square Foot		
		Steel	Copper	Brass
0000	.460000	18.7680	20.8380	19.6880
000	.409642	16.7134	18.5568	17.5327
00	.364796	14.8837	16.5253	15.6133
0	.324861	13.2543	14.7162	13.9041
1	.289297	11.8033	13.1052	12.3819
2	.257627	10.5112	11.8705	11.0264
3	.229423	9.3605	10.3929	9.8193
4	.204307	8.3357	9.2551	8.7443
5	.181940	7.4232	8.2419	7.7870
6	.162023	6.6105	7.3396	6.9346
7	.144285	5.8868	6.5361	6.1754
8	.128490	5.2424	5.8206	5.4994
9	.114423	4.6685	5.1834	4.8973
10	.101897	4.1574	4.6159	4.3612
11	.090742	3.7023	4.1106	3.8838
12	.080808	3.2970	3.6606	3.4596
13	.071962	2.9360	3.2599	3.0800
14	.064084	2.6146	2.9030	2.7428
15	.057068	2.3284	2.5852	2.4425
16	.050821	2.0735	2.3022	2.1751
17	.045257	1.8465	2.0501	1.9370
18	.040303	1.6444	1.8257	1.7250
19	.035890	1.4643	1.6258	1.5361
20	.031961	1.3040	1.4478	1.3679
21	.028462	1.1612	1.2893	1.2182
22	.025346	1.0341	1.1482	1.0848
23	.022572	.92094	1.0225	.99608
24	.020101	.82012	.91058	.86032
25	.017900	.73032	.81087	.76612
26	.015941	.65039	.72213	.68227
27	.014195	.57916	.64303	.60755
28	.012641	.51575	.57264	.54103
29	.011257	.45929	.50994	.48180
30	.010025	.40902	.45413	.42907
31	.008928	.36426	.40444	.38212
32	.007950	.32436	.36014	.34026
33	.007080	.28886	.32072	.30302
34	.006305	.25724	.28562	.26985
35	.005615	.22909	.25436	.24032
36	.005000	.20400	.22650	.21400
37	.004453	.18168	.20172	.19059
38	.003965	.16177	.17961	.16970
39	.003531	.14406	.15995	.15113
40	.003144	.12828	.14242	.13456

**MAXIMUM SIZES OF STEEL PLATES AND HEADS<sup>1</sup>**  
**(Midvale Steel Co.)**

Thickness in Inches	Width in Inches														Diameter of Heads							
	144	140	136	132	128	120	114	106	102	96	90	84	78	72		64	60	54	48	43	36	24
No. 13																						
No. 12																						
No. 11																						
No. 10																						
No. 8																						
$\frac{3}{4}$																						
$\frac{7}{8}$																						
$1\frac{1}{8}$																						
$1\frac{1}{4}$																						
$1\frac{3}{8}$																						
$1\frac{1}{2}$																						
$1\frac{3}{4}$																						
$1\frac{7}{8}$																						
2																						

<sup>1</sup> For a guide only, as the sizes vary with the mills.

SIZES AND WEIGHTS OF STRUCTURAL SHAPES.

$A$  = area of section in square inches

$y$  = distance from center of gravity to extreme fiber in inches

$I$  = moment of inertia about line through center of gravity

$S$  = section modulus =  $\frac{I}{y}$

$r$  = radius of gyration =  $\sqrt{\frac{I}{A}}$

Dimensions in inches, or functions of inches

Weights in pounds per foot.

SHIPBUILDING CHANNELS  
(Carnegie Steel Co.)



Depth of Channel, Inches	Weight Per Foot in Pounds	Area of Action in Square Inches	Width of Flange, Inches	Thickness of Web, Inches	Axis 1-1			Axis 2-2			Distance $x$ for Axis 2-2 Inches
					$I$	$S$	$R$	$I$	$S$	$R$	
13	55.0	16.17	4.529	0.904	334.5	61.5	4.85	16.1	5.2	1.06	1.00
	50.	14.71	4.416	.791	313.8	48.3	4.62	16.7	4.9	1.07	.98
	45.	13.24	4.303	.678	293.1	45.1	4.71	15.3	4.6	1.06	.97
	40.	11.76	4.190	.565	272.3	41.9	4.81	13.9	4.3	1.09	.97
	37.	10.88	4.122	.497	259.9	40.	4.89	13.1	4.2	1.10	.95
12	35.	10.29	4.077	.462	251.6	38.7	4.95	12.5	4.1	1.10	.99
	33.	9.30	4.000	.375	237.6	36.6	6.06	11.6	3.9	1.12	1.01
	50.	14.70	4.140	.840	268.6	44.8	4.27	17.8	5.8	1.10	1.06
	48.4	14.22	4.100	.800	262.9	43.8	4.30	17.3	5.7	1.10	1.05
	46.3	13.62	4.050	.760	256.6	42.6	4.33	16.6	5.6	1.11	1.05
10	44.3	13.02	4.000	.700	248.4	41.4	4.37	16.0	5.4	1.11	1.05
	40.	11.76	3.896	.695	233.3	36.9	4.45	14.6	5.1	1.11	1.05
	35.	10.30	3.773	.673	216.8	36.	4.58	13.0	4.8	1.12	1.07
	40.6	12.00	3.700	.700	217.9	35.3	4.26	11.3	4.	.97	.89
	37.2	10.92	3.610	.610	205.0	34.2	4.33	10.4	3.6	.96	.89
10	33.7	9.60	3.500	.500	189.1	31.5	4.44	9.4	3.6	.99	.89
	30.2	8.38	3.440	.440	180.5	30.1	4.51	8.6	3.6	.99	.90
	40.	11.77	4.091	.741	157.1	31.4	5.66	15.4	5.2	1.14	1.11
	36.9	10.86	4.000	.650	149.5	29.9	3.71	14.3	4.9	1.15	1.11
	34.4	10.11	3.925	.575	143.2	28.6	3.76	13.4	4.8	1.15	1.11
31.8	9.36	3.860	.500	137.0	27.4	3.63	12.4	4.6	1.15	1.12	



**SHIPBUILDING CHANNELS—Continued**

Depth of Channel, Inches	Weight Per Foot in Pounds	Area of Action in Square Inches	Width of Flange, Inches	Thickness of Web, Inches	Axis 1-1			Axis 2-2			Distance <i>s</i> for Axis 2-2, inches
					I	S	R	I	S	R	
	30.0	8.83	3.797	.447	132.6	26.5	3.68	11.7	4.4	1.15	1.14
	32.2	9.75	3.675	.675	124.0	24.8	3.57	9.1	3.3	.97	.89
	30.6	9.00	3.600	.600	117.7	23.5	3.62	8.5	3.1	.97	.88
	28.9	8.50	3.550	.550	113.6	22.7	3.66	8.2	3.1	.99	.88
	27.2	8.00	3.500	.500	109.4	21.9	3.70	7.8	3.	.99	.89
	26.4	7.75	3.475	.475	107.3	21.5	3.72	7.6	2.9	.99	.89
	28.5	8.38	3.575	.575	106.0	21.6	3.68	7.7	2.8	.96	.84
	26.0	7.63	3.500	.500	101.7	20.3	3.66	7.1	2.7	.97	.84
	24.3	7.13	3.450	.450	97.5	19.5	3.70	6.8	2.6	.97	.85
	22.6	6.63	3.400	.400	93.4	18.7	3.75	6.4	2.5	.96	.86
	21.7	6.38	3.375	.375	91.3	18.3	3.78	6.2	2.5	.99	.87
9	35.5	10.43	4.025	.675	117.0	26.	3.35	14.1	4.9	1.16	1.16
	34.7	10.21	4.000	.650	115.5	25.7	3.36	13.8	4.9	1.16	1.16
	31.7	9.31	3.900	.580	109.5	24.3	3.43	12.6	4.6	1.16	1.17
	28.6	8.41	3.800	.450	103.4	23.	3.51	11.4	4.4	1.16	1.19
8	27.2	8.00	3.625	.625	98.9	17.2	2.94	8.4	3.2	1.02	.98
	26.5	7.80	3.600	.600	97.8	17.	2.95	8.2	3.1	1.03	.98
	26.2	7.40	3.550	.550	95.7	16.4	2.98	7.8	3.	1.03	.98
	23.8	7.00	3.500	.500	93.6	15.9	3.01	7.4	3.	1.03	.99
	21.5	6.32	3.415	.415	90.0	15.	3.08	6.9	2.9	1.05	.99
	21.0	6.16	3.000	.466	84.1	13.5	2.96	4.3	1.9	.83	.79
	17.6	5.16	2.875	.344	48.8	12.2	3.07	2.8	1.3	.74	.80
7	24.5	7.20	3.600	.600	48.9	14.	2.61	7.9	3.1	1.05	1.04
	23.3	6.95	3.550	.550	47.5	13.6	2.63	7.5	3.	1.05	1.04
	22.1	6.60	3.500	.500	46.0	13.2	2.66	7.1	2.9	1.05	1.05
	20.9	6.15	3.450	.450	44.6	12.7	2.69	6.7	2.8	1.05	1.05
	19.7	5.80	3.400	.400	43.2	12.3	2.73	6.3	2.7	1.05	1.07
	21.9	6.43	3.575	.575	42.6	12.2	2.67	6.5	2.5	1.01	.99
	18.6	5.46	3.438	.438	38.7	11.	2.66	5.7	2.3	1.02	.96
	16.5	4.85	3.350	.350	36.2	10.3	2.73	5.1	2.2	1.03	.99
	15.6	4.59	3.313	.313	35.1	10.	2.77	4.8	2.1	1.03	1.01
6	31.5	6.83	3.665	.636	33.3	11.1	2.29	7.8	3.1	1.11	1.16
	19.0	5.58	3.560	.410	31.1	10.4	2.36	6.8	2.9	1.10	1.18
	15.0	4.46	3.500	.340	25.0	8.3	2.37	5.2	2.1	1.06	1.08
	18.1	5.33	3.063	.563	25.4	8.5	2.18	3.5	1.6	.82	.80
	13.0	3.83	2.613	.313	20.9	7.	2.34	2.6	1.3	.82	.81
	17.0	4.97	2.781	.831	23.5	7.8	2.18	2.8	1.3	.77	.73
	12.5	3.66	2.583	.313	19.6	6.5	2.31	2.1	1.1	.76	.74
5 1/4	17.0	4.99	3.500	.375	25.8	9.	2.28	5.8	2.5	1.06	1.15
4	13.6	4.00	2.500	.500	8.8	4.4	1.49	2.2	1.4	.74	.87
	6.4	1.86	.875	.375	3.2	1.6	1.31	.08	.13	.21	.27
3	7.1	2.05	1.984	.250	2.8	1.9	1.17	.75	.60	.80	.72

**Ordering Shapes and Plates.**—Structural beams, H beams, structural channels, shipbuilding channels, bulb angles, bulb beams, Tees and Zees should be ordered to weight per foot. Angles may be ordered either to weight per foot or to thickness.

Orders for rounds, squares and other bar mill products should specify width and thickness in inches and the length in feet and inches.

Orders for plates should specify all dimensions in inches.

In the calculation of the areas and weights of the sections on the following pages, the fillets have been disregarded in accordance with the rules of the Association of American Steel Manufacturers.

### EQUAL ANGLES

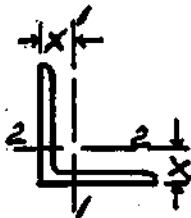

Size, Inches	Weight per Foot Pounds	Area of Section, Sq. Ins. A	Axis 1-1 and Axis 2-2				
			I	R	S	x	
8 × 8 × 1/8	56.9	16.73	98.0	2.42	17.5	2.41	
	54.0	15.87	93.5	2.43	16.7	2.39	
	51.0	15.00	89.0	2.44	15.8	2.37	
	48.1	14.12	84.3	2.44	14.9	2.34	
	45.0	13.23	79.6	2.45	14.0	2.32	
	42.0	12.34	74.7	2.46	13.1	2.30	
	38.9	11.44	69.7	2.47	12.2	2.28	
	35.8	10.53	64.6	2.48	11.2	2.25	
	32.7	9.61	59.4	2.49	10.3	2.23	
	29.6	8.68	54.1	2.50	9.3	2.21	
	26.4	7.75	48.6	2.51	8.4	2.19	
	6 × 6 × 1/8	37.4	11.00	35.5	1.80	8.6	1.86
35.3		10.37	33.7	1.80	8.1	1.84	
33.1		9.73	31.9	1.81	7.6	1.82	
31.0		9.09	30.1	1.82	7.2	1.80	
28.7		8.44	28.2	1.83	6.7	1.78	
26.5		7.78	26.2	1.83	6.2	1.75	
24.2		7.11	24.2	1.84	5.7	1.73	
21.9		6.43	22.1	1.85	5.1	1.71	
19.6		5.75	19.9	1.86	4.6	1.68	
17.2		5.06	17.7	1.87	4.1	1.66	
14.9		4.36	15.4	1.88	3.5	1.64	
5 × 5 × 1/8		30.6	9.00	19.6	1.48	5.8	1.61
	28.9	8.50	18.7	1.48	5.5	1.59	
	27.2	7.98	17.8	1.49	5.2	1.57	
	25.4	7.47	16.8	1.50	4.9	1.55	
	23.6	6.94	15.7	1.50	4.5	1.52	
	21.8	6.40	14.7	1.51	4.2	1.50	
	20.0	5.86	13.6	1.52	3.9	1.48	
	18.1	5.31	12.4	1.53	3.5	1.46	
	16.2	4.75	11.3	1.54	3.2	1.43	
	14.3	4.18	10.0	1.55	2.8	1.41	
	12.3	3.61	8.7	1.56	2.4	1.39	
	4 × 4 × 1/8	19.9	5.84	8.1	1.18	3.0	1.29
18.5		5.44	7.7	1.19	2.8	1.27	
17.1		5.03	7.2	1.19	2.6	1.25	
15.7		4.61	6.7	1.20	2.4	1.23	
14.3		4.18	6.1	1.21	2.2	1.21	
12.8		3.75	5.6	1.22	2.0	1.19	
11.3		3.31	5.0	1.23	1.8	1.16	
9.8		2.86	4.4	1.23	1.5	1.14	
8.2		2.40	3.7	1.24	1.3	1.12	
6.6		1.94	3.0	1.25	1.0	1.09	
3 1/2 × 3 1/2 × 1/8		17.1	5.03	5.3	1.02	2.3	1.17
		16.0	4.69	5.0	1.03	2.1	1.15
	14.8	4.34	4.7	1.04	2.0	1.12	
	13.6	3.98	4.3	1.04	1.8	1.10	
	12.4	3.62	4.0	1.05	1.6	1.08	

EQUAL ANGLES—Continued

Size, Inches	Weight per Foot Pounds	Area of Section Sq. Ins. A	Axis 1-1 and Axis 2-2			
			I	R	S	z
3½ × 3½ × ¼	11.1	3.25	3.6	1.06	1.5	1.06
	9.8	2.87	3.3	1.07	1.3	1.04
	8.5	2.48	2.9	1.07	1.2	1.01
	7.2	2.09	2.5	1.08	.98	.99
3½ × 3½ × ⅜	5.8	1.69	2.0	1.09	.79	.97
	11.5	3.36	2.6	.88	1.3	.98
	10.4	3.06	2.4	.89	1.2	.95
	9.4	2.75	2.2	.90	1.1	.93
3½ × 3½ × ½	8.3	2.43	2.0	.91	.95	.91
	7.2	2.11	1.8	.91	.83	.89
	6.1	1.78	1.5	.92	.71	.87
	4.9	1.44	1.2	.93	.58	.84
2½ × 2½ × ¼	7.7	2.25	1.2	.74	.73	.81
	6.8	2.00	1.1	.75	.65	.78
	5.9	1.73	.98	.75	.57	.76
	5.0	1.47	.85	.76	.48	.74
2½ × 2½ × ⅜	4.1	1.19	.70	.77	.39	.72
	3.07	.90	.55	.78	.30	.69
	2.06	.81	.38	.79	.20	.67
	5.3	1.56	.54	.59	.40	.66
2 × 2 × ¼	4.7	1.36	.48	.59	.35	.64
	3.92	1.15	.42	.60	.30	.61
	3.19	.94	.35	.61	.25	.59
	2.44	.71	.28	.62	.19	.57
2 × 2 × ⅜	1.65	.48	.19	.63	.13	.55
	4.6	1.34	.35	.51	.30	.59
	3.90	1.17	.31	.51	.26	.57
	3.39	1.00	.27	.52	.23	.55
2 × 2 × ½	2.77	.81	.23	.53	.19	.53
	2.12	.62	.18	.54	.14	.51
	1.44	.42	.13	.55	.10	.48
	3.35	.98	.19	.44	.19	.51
1½ × 1½ × ¼	2.86	.84	.16	.44	.16	.49
	2.34	.69	.14	.45	.13	.47
	1.80	.53	.11	.46	.10	.44
	1.23	.36	.08	.46	.07	.42
1½ × 1½ × ⅜	2.33	.68	.09	.36	.11	.42
	1.92	.56	.08	.37	.09	.40
	1.48	.43	.06	.38	.07	.38
	1.01	.30	.04	.38	.05	.35
1 × 1 × ¼	1.49	.44	.04	.29	.06	.34
	1.16	.34	.03	.30	.04	.32
1 × 1 × ⅜	.80	.23	.02	.31	.03	.30

Stove Bolts.—Have either button or flush head similar to ordinary wood screws, but have threads for nut at end.

Dia. of bolt, in.	⅛	⅜	½	⅝	¾	1	1½	2
Threads per in.	32	28	24	22	18	18	16	

Carriage Bolts.—Have button heads, and below is a square shank at end of which are threads for a nut.

Diameter of bolt, in.	¼	⅜	½	⅝	¾	1	1½	2
Thickness of head, in.	⅛	⅜	½	⅝	¾	1	1½	2
Diameter of head, in.	½	⅝	¾	1	1½	2	2½	3

The length of thread depends on the length of the bolt, the thread being about three times the thickness of the nut. See Table of Bolts and Nuts.

# UNEQUAL ANGLES

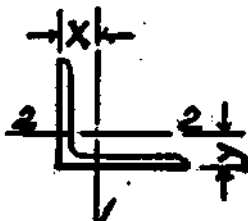

Size, Inches	Weight per Foot Pounds	Area of Section Sq. Ins. A	Axis 1-1				Axis 2-2			
			I	S	R	z	I	S	R	y
8 x 6 x 1	44.2	13.00	80.8	15.1	2.49	2.65	38.8	8.9	1.73	1.65
	41.7	12.25	76.8	14.3	2.50	2.63	36.8	8.4	1.73	1.63
	39.1	11.48	72.3	13.4	2.51	2.61	34.9	7.9	1.74	1.61
	36.5	10.72	67.9	12.5	2.52	2.59	32.8	7.4	1.75	1.59
	33.8	9.94	63.4	11.7	2.63	2.56	30.7	6.9	1.76	1.56
	31.2	9.15	58.8	10.8	2.54	2.54	28.6	6.4	1.77	1.54
	28.5	8.38	54.1	9.9	2.54	2.52	26.3	5.9	1.77	1.52
	25.7	7.56	49.3	8.9	2.55	2.50	24.0	5.3	1.78	1.50
	23.0	6.75	44.3	8.0	2.56	2.47	21.7	4.8	1.79	1.47
	20.2	5.93	39.2	7.1	2.57	2.45	19.3	4.2	1.80	1.45
	35.7	10.50	66.2	13.7	2.51	3.17	7.8	3.0	.86	.92
	33.7	9.90	62.9	12.9	2.52	3.14	7.4	2.9	.87	.89
31.7	9.30	59.4	12.2	2.53	3.12	7.1	2.7	.87	.87	
29.6	8.68	55.9	11.4	2.54	3.10	6.7	2.5	.88	.85	
27.5	8.06	52.3	10.6	2.55	3.07	6.3	2.3	.88	.82	
25.3	7.43	48.5	9.8	2.56	3.05	5.9	2.2	.89	.80	
23.2	6.80	44.7	9.0	2.57	3.03	5.4	2.0	.90	.78	
21.0	6.15	40.8	8.2	2.57	3.00	5.0	1.8	.90	.75	
18.7	5.50	36.7	7.3	2.58	2.98	4.5	1.6	.91	.73	
16.5	4.84	32.5	6.4	2.59	2.95	4.1	1.5	.92	.70	
32.3	9.50	45.4	10.6	2.19	2.71	7.5	3.0	.89	.96	
30.5	8.97	43.1	10.0	2.19	2.69	7.2	2.8	.89	.94	
28.7	8.42	40.8	9.4	2.20	2.66	6.8	2.6	.90	.91	
26.8	7.87	38.4	8.8	2.21	2.64	6.5	2.5	.91	.89	
24.9	7.31	36.0	8.2	2.22	2.62	6.1	2.3	.91	.87	
23.0	6.75	33.5	7.6	2.23	2.60	5.7	2.1	.92	.85	
21.0	6.17	30.9	7.0	2.24	2.57	5.3	2.0	.93	.82	
19.1	5.59	28.2	6.3	2.25	2.55	4.9	1.8	.93	.80	
17.0	5.00	25.4	5.7	2.25	2.53	4.4	1.6	.94	.78	
15.0	4.40	22.6	5.0	2.26	2.50	4.0	1.4	.95	.75	
13.0	3.80	19.6	4.3	2.27	2.48	3.5	1.3	.96	.73	
30.6	9.00	30.8	8.0	1.65	2.17	10.8	3.8	1.09	1.17	
28.9	8.50	29.3	7.6	1.66	2.14	10.3	3.6	1.10	1.14	
27.2	7.98	27.7	7.2	1.66	2.12	9.8	3.4	1.11	1.12	
25.4	7.47	26.1	6.7	1.67	2.10	9.2	3.2	1.11	1.10	
23.6	6.94	24.5	6.2	1.68	2.08	8.7	3.0	1.12	1.08	
21.8	6.40	22.8	5.8	1.69	2.06	8.1	2.8	1.13	1.06	
20.0	5.85	21.1	5.3	1.69	2.03	7.5	2.5	1.13	1.03	
18.1	5.31	19.3	4.8	1.69	2.01	6.9	2.3	1.14	1.01	
16.2	4.75	17.4	4.3	1.91	1.99	6.3	2.1	1.15	.99	
14.3	4.18	15.5	3.8	1.92	1.96	5.6	1.8	1.16	.96	
12.3	3.61	13.5	3.3	1.93	1.94	4.9	1.6	1.17	.94	
28.9	8.50	29.2	7.8	1.85	2.26	7.2	2.9	.92	1.01	
27.3	8.03	27.8	7.4	1.86	2.24	6.9	2.7	.93	.99	
25.7	7.55	26.4	7.0	1.87	2.22	6.6	2.6	.93	.97	
24.0	7.06	24.9	6.6	1.88	2.20	6.2	2.4	.94	.95	

## UNEQUAL ANGLES—Continued

Size, Inches	Weight per Foot Pounds	Area of Section Sq. Ins., A	Axis 1-1				Axis 2-2			
			I	S	R	$\alpha$	I	S	R	$\beta$
6 × 3½ × ¾	22.4	6.58	23.3	6.1	1.89	2.18	5.8	2.3	.04	.93
	20.6	6.06	21.7	5.6	1.89	2.15	5.5	2.1	.95	.90
	18.9	5.55	20.1	5.2	1.90	2.13	5.1	1.9	.96	.88
	17.1	5.03	18.4	4.7	1.91	2.11	4.7	1.8	.96	.86
	15.3	4.50	16.6	4.2	1.92	2.08	4.3	1.6	.97	.83
	13.5	3.97	14.8	3.7	1.93	2.06	3.8	1.4	.98	.81
	11.7	3.42	12.9	3.3	1.94	2.04	3.3	1.2	.99	.79
	9.8	2.87	10.9	2.7	1.95	2.01	2.9	1.0	1.00	.76
	24.2	7.11	16.4	5.0	1.52	1.71	9.2	3.3	1.14	1.21
	22.7	6.65	15.5	4.7	1.53	1.68	8.7	3.1	1.15	1.18
21.1	6.19	14.6	4.4	1.54	1.66	8.2	2.9	1.15	1.16	
19.5	5.72	13.6	4.1	1.54	1.64	7.7	2.7	1.16	1.14	
17.8	5.23	12.6	3.7	1.55	1.62	7.1	2.5	1.17	1.12	
16.2	4.75	11.6	3.4	1.56	1.60	6.6	2.3	1.18	1.10	
14.5	4.23	10.5	3.1	1.57	1.57	6.0	2.0	1.18	1.07	
12.8	3.75	9.3	2.7	1.58	1.55	5.3	1.8	1.19	1.05	
11.0	3.23	8.1	2.3	1.59	1.53	4.7	1.6	1.20	1.03	
5 × 3½ × ¾	22.7	6.67	15.7	4.9	1.53	1.79	6.2	2.6	.96	1.04
	21.3	6.25	14.8	4.6	1.54	1.77	5.9	2.4	.97	1.02
	19.8	5.81	13.9	4.3	1.55	1.75	5.6	2.2	.98	1.00
	19.3	5.37	13.0	4.0	1.56	1.72	5.2	2.1	.98	.97
	16.8	4.92	12.0	3.7	1.56	1.70	4.8	1.9	.99	.95
	15.2	4.47	11.0	3.3	1.57	1.68	4.4	1.7	1.00	.93
	13.6	4.00	10.0	3.0	1.58	1.66	4.0	1.6	1.01	.91
	12.0	3.53	8.9	2.6	1.59	1.63	3.6	1.4	1.01	.88
	10.4	3.05	7.8	2.3	1.60	1.61	3.2	1.2	1.02	.86
	8.7	2.56	6.6	1.9	1.61	1.59	2.7	1.0	1.03	.84
5 × 3 × ¾	19.9	5.84	14.0	4.5	1.55	1.86	3.7	1.7	.90	.86
	18.5	5.44	13.2	4.2	1.55	1.84	3.5	1.6	.90	.84
	17.1	5.03	12.3	3.9	1.56	1.82	3.3	1.5	.81	.82
	15.7	4.61	11.4	3.5	1.57	1.80	3.1	1.4	.81	.80
	14.3	4.18	10.4	3.2	1.58	1.77	2.8	1.3	.82	.77
	12.8	3.75	9.5	2.9	1.59	1.75	2.6	1.1	.83	.75
	11.3	3.31	8.4	2.6	1.60	1.73	2.3	1.0	.84	.73
	9.8	2.86	7.4	2.2	1.61	1.70	2.0	.89	.84	.70
	8.2	2.40	6.3	1.9	1.61	1.68	1.8	.75	.85	.68
	18.5	5.43	10.3	3.8	1.38	1.65	3.6	1.7	.81	.90
17.3	5.06	9.7	3.4	1.39	1.63	3.4	1.6	.82	.88	
15.0	4.68	9.1	3.1	1.39	1.60	3.2	1.5	.83	.85	
14.7	4.30	8.4	2.9	1.40	1.58	3.0	1.4	.83	.83	
13.3	3.90	7.8	2.6	1.41	1.56	2.8	1.3	.85	.81	
11.9	3.50	7.0	2.4	1.42	1.54	2.5	1.1	.85	.79	
10.6	3.09	6.3	2.1	1.43	1.51	2.3	1.0	.85	.76	
9.1	2.67	5.5	1.8	1.44	1.49	2.0	.88	.86	.74	
7.7	2.25	4.7	1.5	1.44	1.47	1.7	.75	.87	.72	
4 × 3½ × ¾	18.5	5.43	7.8	2.9	1.19	1.36	5.5	2.3	1.01	1.11
	17.3	5.06	7.3	2.8	1.20	1.34	5.2	2.1	1.01	1.09
	16.0	4.68	6.9	2.6	1.21	1.32	4.9	2.0	1.02	1.07
	14.7	4.30	6.4	2.4	1.22	1.29	4.5	1.8	1.03	1.04
	13.3	3.90	5.9	2.1	1.23	1.27	4.2	1.7	1.03	1.02
	11.9	3.50	5.3	1.9	1.23	1.25	3.8	1.5	1.04	1.00
	10.6	3.09	4.8	1.7	1.24	1.23	3.4	1.3	1.05	.96
	9.1	2.67	4.2	1.5	1.25	1.21	3.0	1.2	1.05	.93
	7.7	2.25	3.6	1.3	1.26	1.18	2.6	1.0	1.07	.96
	17.1	5.03	7.3	2.9	1.21	1.44	3.5	1.7	.83	.94
16.0	4.69	6.9	2.7	1.22	1.42	3.3	1.6	.84	.92	
14.8	4.34	6.5	2.5	1.22	1.39	3.1	1.5	.84	.89	
13.6	3.98	6.0	2.3	1.23	1.37	2.9	1.4	.85	.87	
12.4	3.62	5.6	2.1	1.24	1.35	2.7	1.2	.86	.85	
11.1	3.25	5.0	1.9	1.25	1.33	2.4	1.1	.86	.83	
9.8	2.87	4.5	1.7	1.25	1.30	2.2	1.0	.87	.80	

UNEQUAL ANGLES—Continued

Size, Inches	Weight per Foot Pounds	Area of Section Sq. Ins. A	Axis 1-1				Axis 2-2			
			I	S	R	x	I	S	R	y
4 x 3 x 1/4	8.5	2.48	4.0	1.5	1.26	1.26	1.9	.87	.88	.78
4 x 3 x 1/4	7.2	2.09	3.4	1.2	1.27	1.26	1.7	.74	.89	.76
4 x 3 x 1/4	5.8	1.69	2.8	1.0	1.28	1.24	1.4	.60	.89	.74
3 1/2 x 3 x 1/4	15.8	4.62	5.0	2.2	1.04	1.23	3.3	1.7	.85	.98
3 1/2 x 3 x 1/4	14.7	4.31	4.7	2.1	1.04	1.21	3.1	1.5	.85	.96
3 1/2 x 3 x 1/4	13.6	4.00	4.4	1.9	1.05	1.19	3.0	1.4	.86	.94
3 1/2 x 3 x 1/4	12.5	3.67	4.1	1.8	1.06	1.17	2.8	1.3	.87	.92
3 1/2 x 3 x 1/4	11.4	3.34	3.8	1.6	1.07	1.15	2.5	1.2	.87	.90
3 1/2 x 3 x 1/4	10.2	3.00	3.5	1.5	1.07	1.13	2.3	1.1	.88	.88
3 1/2 x 3 x 1/4	9.1	2.65	3.1	1.3	1.08	1.10	2.1	.98	.89	.85
3 1/2 x 3 x 1/4	7.9	2.30	2.7	1.1	1.09	1.08	1.8	.85	.90	.83
3 1/2 x 3 x 1/4	6.6	1.93	2.3	.96	1.16	1.06	1.6	.72	.90	.81
3 1/2 x 3 x 1/4	5.4	1.56	1.9	.78	1.11	1.04	1.3	.58	.91	.79
3 1/2 x 2 1/2 x 1/4	12.6	3.65	4.1	1.9	1.06	1.27	1.7	.99	.69	.77
3 1/2 x 2 1/2 x 1/4	11.5	3.36	3.8	1.7	1.07	1.25	1.6	.92	.69	.75
3 1/2 x 2 1/2 x 1/4	10.4	3.06	3.6	1.6	1.08	1.23	1.5	.84	.70	.73
3 1/2 x 2 1/2 x 1/4	9.4	2.75	3.2	1.4	1.09	1.20	1.4	.76	.70	.70
3 1/2 x 2 1/2 x 1/4	8.3	2.43	2.9	1.3	1.09	1.18	1.2	.68	.71	.68
3 1/2 x 2 1/2 x 1/4	7.2	2.11	2.6	1.1	1.10	1.16	1.1	.59	.72	.66
3 1/2 x 2 1/2 x 1/4	6.1	1.78	2.2	.93	1.11	1.14	.94	.50	.73	.64
3 1/2 x 2 1/2 x 1/4	4.9	1.44	1.8	.75	1.12	1.11	.78	.41	.74	.61
3 x 2 1/2 x 1/4	9.5	2.78	2.3	1.2	.91	1.02	1.4	.82	.72	.77
3 x 2 1/2 x 1/4	8.5	2.60	2.1	1.0	.91	1.00	1.3	.74	.72	.75
3 x 2 1/2 x 1/4	7.6	2.21	1.9	.93	.92	.98	1.2	.66	.73	.73
3 x 2 1/2 x 1/4	6.6	1.92	1.7	.81	.93	.96	1.0	.58	.74	.71
3 x 2 1/2 x 1/4	5.6	1.62	1.4	.69	.94	.93	.90	.49	.74	.68
3 x 2 1/2 x 1/4	4.5	1.31	1.2	.56	.95	.91	.74	.40	.75	.66
3 x 2 x 1/4	7.7	2.26	1.9	1.0	.92	1.08	.67	.47	.55	.58
3 x 2 x 1/4	6.8	2.20	1.7	.89	.93	1.06	.61	.42	.55	.56
3 x 2 x 1/4	5.9	1.73	1.5	.78	.94	1.04	.54	.37	.56	.54
3 x 2 x 1/4	5.0	1.47	1.3	.66	.95	1.02	.47	.32	.57	.52
3 x 2 x 1/4	4.1	1.19	1.1	.54	.95	.99	.39	.25	.57	.49
2 1/2 x 2 x 1/4	6.8	2.00	1.1	.70	.75	.88	.64	.46	.56	.63
2 1/2 x 2 x 1/4	6.1	1.78	1.0	.62	.76	.85	.58	.41	.57	.60
2 1/2 x 2 x 1/4	5.3	1.55	.91	.55	.77	.83	.51	.36	.58	.58
2 1/2 x 2 x 1/4	4.5	1.31	.79	.47	.78	.81	.45	.31	.58	.56
2 1/2 x 2 x 1/4	3.62	1.06	.65	.38	.78	.79	.37	.25	.59	.54
2 1/2 x 2 x 1/4	2.75	.81	.51	.29	.79	.76	.29	.20	.60	.51
2 1/2 x 2 x 1/4	1.86	.55	.35	.20	.80	.74	.20	.13	.61	.49
2 1/2 x 1 1/2 x 1/4	3.92	1.15	.71	.44	.79	.90	.19	.17	.41	.40
2 1/2 x 1 1/2 x 1/4	3.19	.94	.59	.36	.79	.88	.16	.14	.41	.38
2 1/2 x 1 1/2 x 1/4	2.44	.72	.46	.28	.80	.86	.13	.11	.42	.35
2 1/4 x 1 1/2 x 1/4	5.6	1.63	.75	.54	.68	.86	.26	.26	.40	.48
2 1/4 x 1 1/2 x 1/4	5.0	1.45	.68	.48	.69	.83	.24	.23	.41	.46
2 1/4 x 1 1/2 x 1/4	4.4	1.27	.61	.42	.69	.81	.21	.20	.41	.44
2 1/4 x 1 1/2 x 1/4	3.66	1.07	.53	.36	.70	.79	.19	.17	.42	.42
2 1/4 x 1 1/2 x 1/4	2.98	.88	.44	.30	.71	.77	.16	.14	.42	.39
2 1/4 x 1 1/2 x 1/4	2.26	.67	.34	.23	.72	.75	.12	.11	.42	.37
2 x 1 1/2 x 1/4	3.99	1.17	.43	.34	.61	.71	.21	.20	.42	.46
2 x 1 1/2 x 1/4	3.39	1.00	.38	.29	.62	.69	.18	.17	.42	.44
2 x 1 1/2 x 1/4	2.77	.81	.32	.24	.62	.66	.15	.14	.43	.41
2 x 1 1/2 x 1/4	2.12	.62	.25	.18	.63	.64	.12	.11	.44	.39
2 x 1 1/2 x 1/4	1.44	.42	.17	.13	.64	.62	.09	.08	.45	.37
2 x 1 1/4 x 1/4	2.55	.75	.30	.23	.63	.71	.09	.10	.34	.33
2 x 1 1/4 x 1/4	1.96	.57	.23	.18	.64	.69	.07	.08	.35	.31
1 3/4 x 1 1/4 x 1/4	2.34	.69	.30	.18	.54	.60	.09	.10	.35	.35
1 3/4 x 1 1/4 x 1/4	1.80	.53	.16	.14	.55	.58	.07	.08	.36	.33
1 3/4 x 1 1/4 x 1/4	1.23	.38	.11	.09	.56	.56	.05	.05	.37	.31
1 1/2 x 1 1/4 x 1/4	2.59	.76	.16	.16	.45	.52	.10	.11	.35	.40
1 1/2 x 1 1/4 x 1/4	2.13	.63	.13	.13	.46	.50	.08	.09	.36	.38
1 1/2 x 1 1/4 x 1/4	1.64	.48	.10	.10	.46	.48	.07	.07	.37	.35

# I BEAMS



Depth of Beam	Weight per Foot	Area of Section	Width of Flange	Thickness of Web	Axis 1-1			Axis 2-2		
					I	S	R	I	S	R
27	83.	24.41	7.5	.424	2888.6	214.	10.88	53.1	14.1	1.47
	115.0	33.98	8.	.760	2955.5	246.3	9.33	63.2	20.8	1.57
24	110.0	32.48	7.938	.688	2883.5	240.3	9.42	61.	20.4	1.58
	105.	30.98	7.875	.625	2811.5	234.3	9.53	78.9	20.	1.60
21	100.	29.41	7.254	.764	2379.6	198.3	9.00	48.6	13.4	1.28
	95.	27.94	7.193	.693	2309.	192.4	9.09	47.1	13.1	1.30
20	90.	26.47	7.131	.631	2238.4	186.5	9.20	45.7	12.8	1.31
	85.	25.00	7.070	.570	2167.8	180.7	9.31	44.4	12.6	1.33
18	80.	23.32	7.	.5	2067.2	173.9	9.46	42.9	12.3	1.36
	75.	21.65	6.5	.39	1928.	160.7	9.71	39.3	11.2	1.39
16	70.	19.98	6.0	.357	1727.5	146.9	9.54	28.4	8.8	1.30
	65.	18.31	5.5	.324	1556.6	133.1	9.77	21.5	7.1	1.21
15	60.	16.64	5.0	.291	1385.7	119.3	9.99	14.6	5.4	1.12
	55.	14.97	4.5	.258	1214.8	105.5	10.21	7.7	3.7	1.03
14	50.	13.30	4.0	.225	1043.9	91.7	10.43	1.0	2.0	0.94
	45.	11.63	3.5	.192	873.0	77.9	10.65	0.3	1.3	0.85
13	40.	10.00	3.0	.160	702.1	64.1	10.87	0.6	1.6	0.76
	35.	8.37	2.5	.127	531.2	50.3	11.09	0.9	1.9	0.67
12	30.	6.74	2.0	.095	360.3	36.5	11.31	1.2	2.2	0.58
	25.	5.11	1.5	.062	189.4	22.7	11.53	1.5	2.5	0.49

### I BEAMS—Continued

Depth of Beam	Weight per Foot	Area of Section	Width of Flange	Thickness of Web	Axis 1—1			Axis 2—2		
					I	S	R	I	S	R
12	45.	13.24	5.366	.576	285.7	47.6	4.63	14.9	5.6	1.06
	40.	11.84	5.35	.490	269.	44.8	4.77	13.6	5.3	1.08
	35.	10.29	5.086	.436	238.3	38.	4.71	10.1	4.	1.09
	31.5	9.26	5.	.35	215.8	36.	4.83	9.5	3.8	1.01
10	27.5	8.04	5.	.255	199.6	33.3	4.96	8.7	3.5	1.04
	40.	11.76	5.099	.749	158.7	31.7	3.87	9.5	3.7	.90
	35.	10.29	4.952	.602	146.4	29.3	3.77	8.5	3.4	.91
	30.	8.82	4.905	.456	134.2	26.6	3.90	7.7	3.2	.93
	25.	7.37	4.66	.310	122.1	24.4	4.07	6.9	3.	.97
	22.	6.53	4.67	.232	113.9	22.8	4.18	6.4	2.7	.99
9	35.	10.29	4.772	.733	111.8	24.8	3.29	7.3	3.1	.84
	30.	8.82	4.609	.569	101.9	22.6	3.40	6.4	2.8	.85
	25.	7.35	4.446	.406	91.9	20.4	3.54	5.7	2.5	.89
	21.	6.31	4.33	.29	84.9	18.9	3.67	5.2	2.4	.90
8	25.5	7.50	4.271	.541	68.4	17.1	3.02	4.8	2.2	.80
	23.	6.76	4.179	.449	64.5	16.1	3.09	4.4	2.1	.81
	20.5	6.03	4.087	.357	60.6	15.2	3.17	4.1	2.	.82
	18.	5.23	4.	.27	56.9	14.2	3.27	3.8	1.9	.84
7	17.5	5.15	4.33	.21	59.3	14.6	3.37	4.5	2.1	.93
	20.	5.88	3.668	.458	42.2	12.1	2.68	3.2	1.7	.74
	17.5	5.15	3.763	.353	39.2	11.2	2.78	2.9	1.6	.76
	15.	4.42	3.66	.25	36.2	10.4	2.86	2.7	1.5	.78
6	17.25	5.07	3.575	.475	26.2	8.7	2.27	2.4	1.3	.68
	14.75	4.34	3.452	.353	24.	8.	2.35	2.1	1.2	.69
	12.25	3.61	3.33	.23	21.8	7.3	2.46	1.9	1.1	.72
5	14.75	4.34	3.294	.504	15.2	6.1	1.87	1.7	1.	.63
	12.25	3.6	3.147	.357	13.6	5.6	1.94	1.5	.92	.63
	9.75	2.87	3.	.21	12.1	4.8	2.05	1.2	.82	.65
4	10.5	3.09	2.98	.41	7.1	3.6	1.52	1.	.7	.57
	9.5	2.79	2.807	.337	6.8	3.4	1.55	.93	.66	.58
	8.5	2.5	2.733	.263	6.4	3.2	1.59	.85	.62	.58
3	7.5	2.21	2.66	.190	6.	3.	1.64	.77	.58	.59
	7.5	2.21	2.621	.361	2.9	1.9	1.15	.60	.48	.52
	6.5	1.91	2.423	.263	2.7	1.8	1.19	.53	.44	.52
	5.5	1.63	2.33	.170	2.5	1.7	1.23	.46	.40	.53

### Half Rounds

Diameter  $\frac{1}{16}$ " to  $\frac{3}{8}$ ", inclusive, advancing by 64ths.  
 "  $\frac{1}{8}$ " "  $\frac{1}{4}$ ", " " " 16ths.  
 "  $2$ ",  $2\frac{1}{2}$ ",  $3$ ".

### Rounds

Diameter  $\frac{1}{16}$ " to  $1\frac{3}{4}$ ", inclusive, advancing by 64ths.  
 "  $\frac{1}{4}$ " "  $3\frac{1}{2}$ ", " " " 32nds.  
 "  $3\frac{3}{4}$ " "  $7$ ", " " " 16ths.

See also page 143



### BULB BEAMS

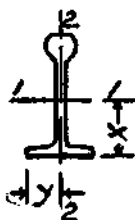

Depth of Beam	Weight per Foot	Area of Section	Width of Flange	Thickness of Web	Axis 1-1				Axis 2-2			
					I	S	R	$\alpha$	I	S	R	y
10	36.6	10.62	5.500	.625	140.4	25.3	3.64	4.45	7.6	2.8	.84	2.75
	28.1	8.12	5.250	.375	118.6	20.7	3.82	4.28	6.3	2.4	.88	2.63
9	30.1	8.83	5.125	.563	95.8	19.4	3.29	4.06	5.4	2.1	.78	2.58
	24.3	7.15	4.938	.375	84.0	16.6	3.43	3.95	4.6	1.9	.80	2.47
8	24.2	7.11	5.156	.469	82.8	14.1	2.97	3.54	4.5	1.7	.79	2.58
	20.0	5.86	5.000	.313	55.6	12.2	3.08	3.43	3.9	1.6	.82	2.50
7	23.3	6.85	5.094	.531	45.5	11.7	2.57	3.11	4.3	1.7	.79	2.56
	18.1	5.32	4.875	.313	38.8	9.7	2.70	2.98	3.6	1.5	.82	2.44
6	17.2	5.00	4.524	.430	24.4	7.2	2.20	2.61	2.7	1.2	.73	2.26
	14.0	4.11	4.375	.281	21.6	6.1	2.28	2.46	2.2	1.0	.72	2.19

### H BEAMS

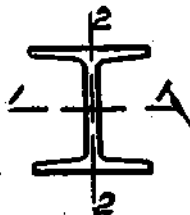

Depth of Beam	Weight per Foot	Area of Section	Width of Flange	Thickness of Web	Axis 1-1			Axis 2-2		
					I	S	R	I	S	R
8	34.	10.	8.	.375	115.4	28.9	3.40	35.1	8.8	1.87
6	23.8	7.	6.	.313	45.1	15.	2.54	14.7	4.9	1.45
5	18.7	5.50	5.	.313	23.8	9.5	2.08	7.9	3.1	1.20
4	13.6	4.	4.	.313	10.7	5.3	1.63	3.6	1.8	.95

### BULB ANGLES

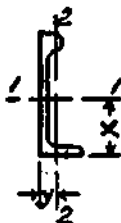

Depth of Angle	Weight per Foot	Area of Section	Width of Flange	Thickness of Web	Axis 1-1				Axis 2-2			
					I	S	R	x	I	S	R	y
10	32.0	9.41	3.500	.625	116.0	21.6	3.51	4.62	6.2	2.3	.82	.77
	28.6	7.80	.....	.484	104.2	19.9	3.66	4.75	5.0	1.8	.80	.72
9	21.8	6.41	.....	.438	69.3	14.5	3.33	4.21	4.3	1.5	.82	.72
8	19.3	5.66	.....	.406	48.8	11.7	2.95	3.87	3.7	1.3	.81	.71
7	20.0	5.81	3.000	.500	36.6	10.0	2.51	3.34	2.9	1.3	.71	.70
	15.3	5.37	.....	.438	34.9	9.6	2.56	3.36	2.6	1.1	.69	.68
6	16.1	4.71	.....	.444	32.2	8.7	2.61	3.30	2.7	1.2	.76	.72
	17.3	5.06	.....	.500	23.9	7.6	2.16	2.84	2.5	1.1	.70	.71
5	15.0	4.38	.....	.406	21.1	6.7	2.19	2.84	2.3	1.0	.72	.69
	13.8	4.04	.....	.375	20.1	6.6	2.21	2.96	1.9	.82	.69	.65
4	12.4	3.62	.....	.313	18.6	5.7	2.28	2.71	1.8	.75	.70	.64
	13.2	3.82	3.500	.375	13.5	4.9	1.88	2.22	3.3	1.24	.92	.86
3	10.0	2.94	2.500	.313	10.2	4.1	1.86	2.49	.95	.49	.57	.57
	8.3	2.44	.....	.240	8.6	3.4	1.89	2.41	.91	.47	.61	.55
4 1/2	6.7	1.95	2.250	.220	5.6	2.4	1.69	2.12	.60	.34	.56	.50
4	14.3	4.21	3.600	.500	8.7	3.7	1.44	1.65	3.9	1.5	.96	.99
	11.9	3.48	.....	.375	7.9	3.5	1.50	1.77	3.1	1.2	.94	.94
3	3.60	1.08	2.000	.190	1.3	.74	1.09	1.24	.31	.20	.54	.45
	3.25	.97	1.750	.160	1.2	.72	1.13	1.31	.21	.16	.47	.41
2 1/2	2.66	.84	1.500	.150	.74	.55	.94	1.17	.12	.11	.38	.36

### Band Edge Flats

Thickness	Width	Weight	No.	Notes
3/8"	wide, X	No. 18 to No. 4 B. W. G.		
1/8"	" X	19 "	"	"
1/2"	" X	22 "	"	"
1/8" to 1"	" X	23 "	"	"
1 1/8"	" X	22 "	"	"
2 1/8"	" X	21 "	1	"
3 1/8"	" X	20 "	"	"
3 1/8"	" X	19 "	"	"
4 1/8"	" X	18 "	"	"
4 1/8"	" X	17 "	"	"
5 1/8"	" X	16 "	"	"
6 1/8"	" X	14 "	"	"
8 1/8"	" X	12 "	"	"

### EQUAL TEES

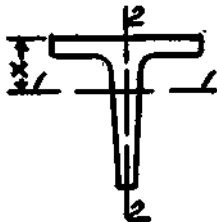

Size				Weight per Foot	Area of Sec- tion	Axis 1-1				Axis 2-2		
Flange	Stem	Minimum Thickness				I	S	R	z	I	S	R
		Flange	Stem									
4	4	1/4	1/4	13.8	3.97	5.7	2.	1.20	1.18	2.8	1.4	.84
3 1/2	3 1/2	1/4	1/4	10.5	3.09	4.5	1.6	1.21	1.13	2.1	1.1	.83
		1/4	1/4	11.7	3.44	3.7	1.5	1.04	1.05	1.9	1.1	.74
		1/4	1/4	9.2	2.66	3.0	1.2	1.06	1.01	1.4	.81	.73
3	3	1/4	1/4	9.9	2.91	2.3	1.1	.88	.93	1.2	.80	.64
		1/4	1/4	8.9	2.59	2.1	.98	.80	.91	1.0	.70	.63
		1/4	1/4	7.8	2.27	1.8	.86	.90	.86	.90	.60	.63
		1/4	1/4	6.7	1.95	1.6	.74	.90	.86	.75	.50	.62
2 1/2	2 1/2	1/4	1/4	6.4	1.87	1.0	.59	.74	.76	.63	.42	.53
		1/4	1/4	5.5	1.60	.88	.5	.74	.74	.44	.35	.52
2 1/4	2 1/4	1/4	1/4	4.9	1.43	.65	.41	.67	.68	.33	.29	.48
		1/4	1/4	4.1	1.19	.52	.32	.66	.65	.25	.22	.46
		1/4	1/4	4.3	1.26	.44	.31	.59	.61	.23	.23	.43
2	2	1/4	1/4	3.56	1.05	.37	.26	.59	.59	.18	.18	.42
		1/4	1/4	3.09	.91	.23	.19	.51	.54	.12	.14	.37
1 1/2	1 1/2	1/4	1/4	2.47	.73	.15	.14	.45	.47	.08	.10	.32
		1/4	1/4	1.94	.57	.11	.11	.45	.44	.06	.08	.32
		1/4	1/4	2.02	.59	.08	.10	.37	.40	.05	.07	.28
1 1/4	1 1/4	1/4	1/4	1.59	.47	.06	.07	.37	.38	.03	.05	.27
		1/4	1/4	1.25	.37	.03	.05	.29	.32	.02	.04	.22
1	1	1/4	1/4	.89	.26	.02	.03	.30	.29	.01	.02	.21

#### Square Edge Flats

	3/8" to	3" wide	X any thickness,	1/8" up to width.
Over	3" "	5" "	X " "	1/4" to 3", inclusive.
"	5" "	7" "	X " "	1/4" " 2", "
"	7" "	7 1/2" "	X " "	1/4" " 1 1/2", "
"	7 1/2" "	8" "	X " "	1/4" " 1", "

#### Squares

Size	1/4" to 2", inclusive,	advancing by 64ths.
"	2 1/4" " 3 1/2", "	" " 32nds.
"	3 1/4" " 5 1/2", "	" " 16ths.

#### Round Cornered Squares

Size	1/4" to 3/4", inclusive,	advancing by 64ths.
------	--------------------------	---------------------

# UNEQUAL TEES



Flange	Size		Weight per Foot	Area of Section	Axis 1-1				Axis 2-2					
	Stem	Minimum Thickness			I	S	R	r	I	S	R			
		Flange										Stem		
5	3	2 1/2	1/2	1/2	13.4	3.3	2.4	1.1	.78	.73	5.4	2.2	1.17	
		3 1/2	1/2	1/2	10.9	3.18	1.5	.78	.68	.63	4.1	1.6	1.14	
	4 1/2	3 1/2	1/2	1/2	15.7	4.80	5.1	2.1	1.05	1.11	3.7	1.7	.90	
		3	1/2	1/2	9.8	2.88	2.1	.91	.84	.74	3.	1.3	1.02	
4	3	3	1/2	1/2	8.4	2.46	1.8	.78	.65	.71	2.5	1.1	1.01	
		2 1/2	1/2	1/2	9.2	2.68	1.2	.63	.67	.59	3.	1.3	1.05	
	2 1/2	3	1/2	1/2	7.8	2.29	1.	.54	.68	.57	2.5	1.1	1.06	
		5	1/2	1/2	15.3	4.50	10.8	3.1	1.55	1.56	2.8	1.4	.79	
	5	5	1/2	1/2	11.9	3.49	8.5	2.4	1.56	1.51	2.1	1.1	.78	
		4 1/2	1/2	1/2	14.4	4.23	7.9	2.5	1.37	1.37	2.8	1.4	.81	
	4 1/2	4 1/2	1/2	1/2	11.2	3.29	6.3	2.	1.39	1.31	2.1	1.1	.80	
		2	1/2	1/2	9.2	2.68	2.	.9	.96	.78	2.1	1.1	.89	
	3	2 1/2	3	1/2	1/2	7.8	2.29	1.7	.77	.87	.75	1.8	.89	.88
			2 1/2	1/2	1/2	8.5	2.48	1.2	.62	.69	.62	2.1	1.	.92
	3 1/2	2	2 1/2	1/2	1/2	7.2	2.12	1.	.53	.69	.6	1.8	.89	.91
			2	1/2	1/2	7.8	2.27	.60	.40	.52	.48	2.1	1.1	.96
4		2	1/2	1/2	6.7	1.95	.53	.34	.52	.46	1.8	.88	.95	
		4	1/2	1/2	12.6	3.70	5.50	2.	1.21	1.24	1.9	1.1	.72	
3	3	3	1/2	1/2	9.8	2.88	4.30	1.5	1.23	1.19	1.4	.81	.70	
		3	1/2	1/2	10.8	3.17	2.4	1.1	.87	.88	1.9	1.1	.77	
	3	3	1/2	1/2	8.5	2.48	1.9	.89	.86	.83	1.4	.81	.75	
		3	1/2	1/2	7.5	2.20	1.8	.85	.91	.85	1.2	.68	.74	
2 1/2	4	4	1/2	1/2	11.7	3.44	6.2	1.9	1.23	1.32	1.2	.81	.59	
		4	1/2	1/2	10.5	3.08	4.7	1.7	1.23	1.29	1.1	.7	.59	
	4	4	1/2	1/2	9.2	2.68	4.1	1.5	1.24	1.27	.9	.6	.58	
		3 1/2	1/2	1/2	10.8	3.17	3.5	1.5	1.06	1.12	1.2	.8	.62	
2 1/2	3 1/2	3 1/2	1/2	1/2	9.7	2.83	3.2	1.3	1.06	1.1	1.	.69	.60	
		3 1/2	1/2	1/2	8.5	2.48	2.8	1.2	1.07	1.07	.93	.62	.61	
	2 1/2	2 1/2	1/2	1/2	7.1	2.07	1.1	.6	.72	.71	.89	.69	.66	
		2 1/2	1/2	1/2	6.1	1.77	.94	.52	.73	.68	.75	.50	.65	
2	3	3	1/2	1/2	7.1	2.07	1.7	.84	.91	.95	.53	.42	.51	
		3	1/2	1/2	6.1	1.77	1.5	.72	.92	.92	.44	.35	.50	
	1 1/2	1 1/2	1/2	1/2	2.87	.84	.08	.09	.31	.32	.29	.23	.58	
		1 1/2	1/2	1/2	3.09	.91	.16	.15	.42	.42	.18	.18	.45	
1 1/2	2	1/2	1/2	2.45	.72	.27	.19	.61	.63	.06	.08	.62		
	1 1/2	1/2	1/2	1.25	.37	.05	.05	.37	.33	.04	.05	.32		
1 1/4	3/4	1/2	1/2	.88	.26	.01	.01	.16	.16	.02	.04	.31		

Keys.—For square and flat steel keys, let  $d$  = diameter of shaft,  $w$  = width of key,  $t$  = thickness, all in inches. Then  $w = \frac{d}{4} + \frac{1}{16}$ ,  $t = \frac{d}{8} + \frac{1}{8}$ , common taper  $\frac{1}{8}$ " = 1', length 1.5 $d$ .

## ZEE'S

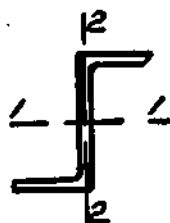

Size			Weight per Foot	Area of Section	Axis 1-1			Axis 2-2		
Depth	Flanges	Thickness			I	S	R	I	S	R
6½	3½	¾	34.6	10.17	50.2	16.4	2.22	19.2	6.0	1.37
6¼	3¼	¾	32.0	9.40	46.1	15.2	2.22	17.3	5.5	1.36
6	3½	¾	29.4	8.63	42.1	14.0	2.21	15.4	4.9	1.34
6½	3½	¾	28.1	8.25	43.2	14.1	2.29	16.3	5.0	1.41
6¼	3¼	¾	25.4	7.46	38.9	12.8	2.28	14.4	4.4	1.39
6	3½	¾	22.8	6.68	34.6	11.5	2.28	12.6	3.9	1.37
6½	3½	¾	21.1	6.19	34.4	11.2	2.36	12.9	3.8	1.44
6¼	3¼	¾	18.4	5.39	29.8	9.8	2.35	11.0	3.3	1.43
6	3½	¾	15.7	4.59	25.3	8.4	2.35	9.1	2.8	1.41
5½	3½	¾	28.4	8.33	28.7	11.2	1.86	14.4	4.8	1.31
5¼	3¼	¾	26.9	7.64	26.2	10.3	1.85	12.8	4.4	1.30
5	3¼	¾	23.7	6.96	23.7	9.6	1.84	11.4	3.9	1.28
5½	3½	¾	22.6	6.64	24.5	9.6	1.92	12.1	3.9	1.35
5¼	3¼	¾	20.2	5.94	21.8	8.6	1.91	10.5	3.5	1.33
5	3¼	¾	17.9	5.25	19.2	7.7	1.91	9.1	3.0	1.31
5½	3½	¾	16.4	4.81	19.1	7.4	1.99	9.2	2.9	1.36
5¼	3¼	¾	14.0	4.10	16.2	6.4	1.99	7.7	2.5	1.37
5	3¼	¾	11.6	3.40	13.4	5.3	1.98	6.2	2.0	1.35
4½	3¼	¾	23.0	5.75	15.0	7.3	1.49	11.2	4.0	1.29
4¼	3¼	¾	20.9	6.14	13.5	6.7	1.48	10.0	3.6	1.27
4	3¼	¾	18.9	5.55	12.1	6.1	1.48	8.7	3.2	1.25
4½	3¼	¾	18.0	5.27	12.7	6.2	1.55	9.3	3.2	1.33
4¼	3¼	¾	15.9	4.66	11.2	5.5	1.55	8.0	2.8	1.31
4	3¼	¾	13.6	4.06	9.7	4.8	1.55	6.7	2.4	1.29
4½	3¼	¾	12.5	3.66	9.6	4.7	1.62	6.8	2.3	1.36
4¼	3¼	¾	10.3	3.03	7.0	3.9	1.62	5.5	1.8	1.34
4	3¼	¾	8.2	2.41	6.3	3.1	1.62	4.2	1.4	1.33
3½	2½	¾	14.3	4.16	5.3	3.4	1.13	5.7	2.3	1.17
3	2½	¾	12.6	3.69	4.6	3.1	1.12	4.9	2.0	1.15
3¼	2½	¾	11.5	3.36	4.6	3.0	1.17	4.8	1.9	1.19
3	2½	¾	9.8	2.86	3.9	2.6	1.16	3.9	1.6	1.17
3¼	2½	¾	6.5	2.48	3.6	2.4	1.21	3.6	1.4	1.21
3	2½	¾	6.7	1.97	2.9	1.9	1.21	2.8	1.1	1.19

## Hexagons.

Size from flat to flat ¼" to 1½" inclusive, advancing by 32nds.

" " " " " 1¼" " 3¼" " " " " 16ths.

" " " " " 3¼".

WEIGHTS AND AREAS OF SQUARE AND ROUND BARS AND CIRCUMFERENCES OF ROUND BARS

One cubic foot of steel weighs 489.6 lb.

Thickness or Diameter in Inches	Weight of Bar One Foot Long	Weight of Bar One Foot Long	Area of Bar in Square Inches	Area of Bar in Square Inches	Circumference of Bar in Inches
$\frac{1}{16}$	.013	.010	.0039	.0031	.1964
$\frac{1}{8}$	.021	.016	.0061	.0048	.2454
$\frac{3}{16}$	.030	.023	.0088	.0069	.2945
$\frac{1}{4}$	.041	.032	.0120	.0094	.3436
$\frac{5}{16}$	.053	.042	.0156	.0123	.3927
$\frac{3}{8}$	.067	.053	.0198	.0155	.4418
$\frac{7}{16}$	.083	.065	.0244	.0192	.4909
$\frac{1}{2}$	.100	.079	.0295	.0232	.5400
$\frac{9}{16}$	.120	.094	.0352	.0276	.5891
$\frac{5}{8}$	.140	.110	.0413	.0324	.6381
$\frac{11}{16}$	.163	.128	.0479	.0376	.6872
$\frac{3}{4}$	.187	.147	.0549	.0431	.7363
$\frac{7}{8}$	.212	.167	.0625	.0491	.7854
$\frac{15}{16}$	.240	.188	.0706	.0554	.8345
1	.269	.211	.0791	.0621	.8836
$1\frac{1}{16}$	.300	.235	.0881	.0692	.9327
$1\frac{1}{8}$	.332	.261	.0977	.0767	.9818
$1\frac{1}{4}$	.366	.288	.1077	.0846	1.0308
$1\frac{3}{8}$	.402	.316	.1182	.0928	1.0799
$1\frac{1}{2}$	.439	.345	.1292	.1014	1.1290
$1\frac{5}{8}$	.478	.376	.1406	.1104	1.1781
$1\frac{3}{4}$	.519	.407	.1526	.1198	1.2272
$1\frac{7}{8}$	.561	.441	.1650	.1296	1.2763
2	.605	.475	.1780	.1398	1.3254
$2\frac{1}{16}$	.651	.511	.1914	.1503	1.3745
$2\frac{1}{8}$	.698	.548	.2053	.1613	1.4235
$2\frac{1}{4}$	.747	.587	.2197	.1726	1.4726
$2\frac{3}{8}$	.798	.627	.2346	.1843	1.5217
$2\frac{1}{2}$	.850	.668	.2500	.1963	1.5708
$2\frac{5}{8}$	.904	.710	.2659	.2088	1.6199
$2\frac{3}{4}$	.960	.754	.2822	.2217	1.6690
$2\frac{7}{8}$	1.017	.799	.2991	.2349	1.7181
$3$	1.076	.845	.3164	.2485	1.7672
$3\frac{1}{16}$	1.136	.893	.3342	.2625	1.8162
$3\frac{1}{8}$	1.199	.941	.3525	.2769	1.8653
$3\frac{1}{4}$	1.263	.992	.3713	.2916	1.9144
$3\frac{3}{8}$	1.328	1.043	.3906	.3068	1.9635
$3\frac{1}{2}$	1.395	1.096	.4104	.3223	2.0126
$3\frac{5}{8}$	1.464	1.150	.4307	.3382	2.0617
$3\frac{3}{4}$	1.535	1.205	.4514	.3545	2.1108

SQUARE AND ROUND BARS—Continued

Thickness or Diameter in Inches	Weight of ■ Bar One Foot Long	Weight of ● Bar One Foot Long	Area of ■ Bar in Square Inches	Area of ● Bar in Square Inches	Circumference of ● Bar in Inches
1 1/16	1.607	1.262	.4727	.3712	2.1599
1 1/8	1.681	1.320	.4944	.3883	2.2089
1 1/4	1.756	1.380	.5166	.4057	2.2580
1 3/8	1.834	1.440	.5393	.4236	2.3071
1 1/2	1.913	1.502	.5625	.4418	2.3562
1 5/8	2.245	1.763	.6602	.5185	2.5526
1 3/4	2.603	2.044	.7656	.6013	2.7489
1 7/8	2.988	2.347	.8789	.6903	2.9453
1	3.400	2.670	1.0000	.7854	3.1416
1 1/16	3.838	3.015	1.1289	.8866	3.3380
1 1/8	4.303	3.380	1.2656	.9940	3.5343
1 1/4	4.795	3.766	1.4102	1.1075	3.7306
1 3/8	5.313	4.172	1.5625	1.2272	3.9270
1 1/2	5.857	4.600	1.7227	1.3530	4.1234
1 5/8	6.428	5.049	1.8906	1.4849	4.3197
1 3/4	7.026	5.518	2.0664	1.6230	4.5161
1 7/8	7.650	6.008	2.2500	1.7671	4.7124
1 15/16	8.301	6.519	2.4414	1.9175	4.9088
2	8.978	7.051	2.6406	2.0739	5.1051
2 1/16	9.682	7.604	2.8477	2.2365	5.3015
2 1/8	10.41	8.178	3.0625	2.4053	5.4978
2 1/4	11.17	8.773	3.2852	2.5802	5.6942
2 3/8	11.95	9.388	3.5156	2.7612	5.8905
2 1/2	12.76	10.02	3.7539	2.9483	6.0869
2	13.60	10.68	4.0000	3.1416	6.2832
2 1/16	14.46	11.36	4.2539	3.3410	6.4796
2 1/8	15.35	12.06	4.5156	3.5466	6.6759
2 1/4	16.27	12.78	4.7852	3.7583	6.8723
2 3/8	17.21	13.52	5.0625	3.9761	7.0686
2 1/2	18.18	14.28	5.3477	4.2000	7.2650
2 5/8	19.18	15.06	5.6406	4.4301	7.4613
2 3/4	20.20	15.87	5.9414	4.6664	7.6577
2 7/8	21.25	16.69	6.2500	4.9087	7.8540
3	22.33	17.53	6.5664	5.1573	8.0504
3 1/16	23.43	18.40	6.8906	5.4119	8.2467
3 1/8	24.56	19.29	7.2227	5.6727	8.4431
3 1/4	25.71	20.19	7.5625	5.9396	8.6394
3 3/8	26.90	21.12	7.9102	6.2126	8.8358
3 1/2	28.10	22.07	8.2656	6.4918	9.0321
3 5/8	29.34	23.04	8.6289	6.7771	9.2285

## SQUARE AND ROUND BARS—Continued

Thickness or Diameter in Inches	Weight of ■ Bar One Foot Long	Weight of ● Bar One Foot Long	Area of ■ Bar in Square Inches	Area of ● Bar in Square Inches	Circumference of ● Bar in Inches
3	30.60	24.03	9.0000	7.0686	9.4248
$\frac{1}{16}$	31.89	25.05	9.3789	7.3662	9.6212
$\frac{1}{8}$	33.20	26.08	9.7656	7.6699	9.8175
$\frac{3}{16}$	34.55	27.13	10.160	7.9798	10.014
$\frac{1}{4}$	35.92	28.21	10.563	8.2958	10.210
$\frac{5}{16}$	37.31	29.30	10.973	8.6179	10.407
$\frac{3}{8}$	38.73	30.42	11.391	8.9462	10.603
$\frac{7}{16}$	40.18	31.55	11.816	9.2806	10.799
$\frac{1}{2}$	41.65	32.71	12.250	9.6211	10.996
$\frac{9}{16}$	43.15	33.89	12.691	9.9678	11.192
$\frac{5}{8}$	44.68	35.09	13.141	10.321	11.388
$\frac{11}{16}$	46.23	36.31	13.598	10.680	11.585
$\frac{3}{4}$	47.82	37.55	14.063	11.045	11.781
$\frac{13}{16}$	49.42	38.81	14.535	11.416	11.977
$\frac{7}{8}$	51.05	40.10	15.016	11.793	12.174
$\frac{15}{16}$	52.71	41.40	15.504	12.177	12.370
4	54.40	42.73	16.000	12.566	12.566
$\frac{1}{16}$	56.11	44.07	16.504	12.962	12.763
$\frac{1}{8}$	57.85	45.44	17.016	13.364	12.959
$\frac{3}{16}$	59.62	46.83	17.535	13.772	13.155
$\frac{1}{4}$	61.41	48.24	18.063	14.186	13.352
$\frac{5}{16}$	63.23	49.66	18.598	14.607	13.548
$\frac{3}{8}$	65.08	51.11	19.141	15.033	13.745
$\frac{7}{16}$	66.95	52.58	19.691	15.466	13.941
$\frac{1}{2}$	68.85	54.07	20.250	15.904	14.137
$\frac{9}{16}$	70.78	55.59	20.816	16.349	14.334
$\frac{5}{8}$	72.73	57.12	21.391	16.800	14.530
$\frac{11}{16}$	74.71	58.67	21.973	17.257	14.726
$\frac{3}{4}$	76.71	60.25	22.563	17.721	14.923
$\frac{13}{16}$	78.74	61.85	23.160	18.190	15.119
$\frac{7}{8}$	80.80	63.46	23.766	18.665	15.315
$\frac{15}{16}$	82.89	65.10	24.379	19.147	15.512
5	85.00	66.76	25.000	19.635	15.708
$\frac{1}{16}$	87.14	68.44	25.629	20.129	15.904
$\frac{1}{8}$	89.30	70.14	26.266	20.629	16.101
$\frac{3}{16}$	91.49	71.86	26.910	21.135	16.297
$\frac{1}{4}$	93.71	73.60	27.563	21.648	16.493
$\frac{5}{16}$	95.96	75.37	28.223	22.166	16.690
$\frac{3}{8}$	98.23	77.15	28.891	22.691	16.886
$\frac{7}{16}$	100.5	78.95	29.566	23.221	17.082



SQUARE AND ROUND BARS—Continued

Thickness or Diameter in Inches	Weight of ■ Bar One Foot Long	Weight of ● Bar One Foot Long	Area of ■ Bar in Square Inches	Area of ● Bar in Square Inches	Circumference of ● Bar in Inches
5 $\frac{1}{16}$	102.9	80.78	30.250	23.758	17.279
$\frac{1}{8}$	105.2	82.62	30.941	24.301	17.475
$\frac{3}{16}$	107.6	84.49	31.641	24.851	17.672
$\frac{1}{4}$	110.0	86.38	32.348	25.406	17.868
$\frac{5}{16}$	112.4	88.29	33.063	25.967	18.064
$\frac{3}{8}$	114.9	90.22	33.785	26.535	18.261
$\frac{7}{16}$	117.4	92.17	34.516	27.109	18.457
$\frac{1}{2}$	119.9	94.14	35.254	27.688	18.653
6	122.4	96.13	36.000	28.274	18.850
$\frac{1}{16}$	125.0	98.15	36.754	28.867	19.046
$\frac{1}{8}$	127.6	101.8	37.516	29.465	19.242
$\frac{3}{16}$	130.2	102.2	38.285	30.069	19.439
$\frac{1}{4}$	132.8	104.3	39.063	30.680	19.635
$\frac{5}{16}$	135.5	106.4	39.848	31.296	19.831
$\frac{3}{8}$	138.2	108.5	40.641	31.919	20.028
$\frac{7}{16}$	140.9	110.7	41.441	32.548	20.224
$\frac{1}{2}$	143.7	112.8	42.250	33.183	20.420
$\frac{5}{8}$	146.5	115.0	43.066	33.824	20.617
$\frac{3}{4}$	149.2	117.2	43.891	34.472	20.813
$\frac{7}{8}$	152.1	119.4	44.723	35.125	21.009
$\frac{1}{4}$	154.9	121.7	45.563	35.785	21.206
$\frac{3}{8}$	157.8	123.9	46.410	36.451	21.402
$\frac{1}{2}$	160.7	126.2	47.266	37.122	21.599
$\frac{5}{8}$	163.6	128.5	48.129	37.800	21.795
7	166.6	130.8	49.000	38.485	21.991
$\frac{1}{16}$	169.6	133.2	49.879	39.175	22.188
$\frac{1}{8}$	172.6	135.6	50.766	39.871	22.384
$\frac{3}{16}$	175.6	138.0	51.660	40.574	22.580
$\frac{1}{4}$	178.7	140.4	52.563	41.283	22.777
$\frac{5}{16}$	181.8	142.8	53.473	41.997	22.973
$\frac{3}{8}$	184.9	145.2	54.391	42.718	23.169
$\frac{7}{16}$	188.1	147.7	55.316	43.446	23.366
$\frac{1}{2}$	191.3	150.2	56.250	44.179	23.562
$\frac{5}{8}$	194.5	152.7	57.191	44.918	23.758
$\frac{3}{4}$	197.7	155.3	58.141	45.664	23.955
$\frac{7}{8}$	200.9	157.8	59.098	46.415	24.151
$\frac{1}{4}$	204.2	160.4	60.063	47.173	24.347
$\frac{3}{8}$	207.5	163.0	61.035	47.937	24.544
$\frac{1}{2}$	210.9	165.6	62.016	48.707	24.740
$\frac{5}{8}$	214.2	168.2	63.004	49.483	24.936

SQUARE AND ROUND BARS—Continued

Thickness or Diameter in Inches	Weight of ■ Bar One Foot Long	Weight of ● Bar One Foot Long	Area of ■ Bar in Square Inches	Area of ● Bar in Square Inches	Circumference of ● Bar in Inches
8	217.6	170.9	64.000	50.266	25.133
$\frac{1}{16}$	221.0	173.6	65.004	51.054	25.329
$\frac{1}{8}$	224.5	176.3	66.016	51.849	25.526
$\frac{3}{16}$	227.9	179.0	67.035	52.649	25.722
$\frac{1}{4}$	231.4	181.8	68.063	53.456	25.918
$\frac{5}{16}$	234.9	184.5	69.098	54.269	26.115
$\frac{3}{8}$	238.5	187.3	70.141	55.088	26.311
$\frac{7}{16}$	242.1	190.1	71.191	55.914	26.507
$\frac{1}{2}$	245.7	192.9	72.250	56.745	26.704
$\frac{9}{16}$	249.3	195.8	73.316	57.583	26.900
$\frac{5}{8}$	252.9	198.6	74.391	58.426	27.096
$\frac{11}{16}$	256.6	201.5	75.473	59.276	27.293
$\frac{3}{4}$	260.3	204.4	76.563	60.132	27.489
$\frac{13}{16}$	264.0	207.4	77.660	60.994	27.685
$\frac{7}{8}$	267.8	210.3	78.766	61.863	27.882
$\frac{15}{16}$	271.6	213.3	79.879	62.737	28.078
9	275.4	216.3	81.000	63.617	28.274
$\frac{1}{16}$	279.2	219.3	82.129	64.504	28.471
$\frac{1}{8}$	283.1	222.3	83.266	65.397	28.667
$\frac{3}{16}$	287.0	225.4	84.410	66.296	28.863
$\frac{1}{4}$	290.9	228.5	85.563	67.201	29.060
$\frac{5}{16}$	294.9	231.6	86.723	68.112	29.256
$\frac{3}{8}$	298.8	234.7	87.891	69.029	29.453
$\frac{7}{16}$	302.8	237.8	89.066	69.953	29.649
$\frac{1}{2}$	306.9	241.0	90.250	70.882	29.845
$\frac{9}{16}$	310.9	244.2	91.441	71.818	30.042
$\frac{5}{8}$	315.0	247.4	92.641	72.760	30.238
$\frac{11}{16}$	319.1	250.6	93.848	73.708	30.434
$\frac{3}{4}$	323.2	253.8	95.063	74.662	30.631
$\frac{13}{16}$	327.4	257.1	96.285	75.622	30.827
$\frac{7}{8}$	331.6	260.4	97.516	76.589	31.023
$\frac{15}{16}$	335.8	263.7	98.754	77.561	31.220
10	340.0	267.0	100.00	78.540	31.416
$\frac{1}{16}$	344.3	270.4	101.25	79.525	31.612
$\frac{1}{8}$	348.6	273.8	102.52	80.516	31.809
$\frac{3}{16}$	352.9	277.1	103.79	81.513	32.005
$\frac{1}{4}$	357.2	280.6	105.06	82.516	32.201
$\frac{5}{16}$	361.6	284.0	106.35	83.525	32.398
$\frac{3}{8}$	366.0	287.4	107.64	84.541	32.594
$\frac{7}{16}$	370.4	290.9	108.94	85.563	32.790

SQUARE AND ROUND BARS—Continued

Thickness or Diameter in Inches	Weight of ■ Bar One Foot Long	Weight of ● Bar One Foot Long	Area of ■ Bar in Square Inches	Area of ● Bar in Square Inches	Circumference of ● Bar in Inches
10 $\frac{1}{8}$	374.9	294.4	110.25	86.590	32.987
$\frac{1}{4}$	379.3	297.9	111.57	87.624	33.183
$\frac{3}{8}$	383.8	301.5	112.89	88.664	33.380
$\frac{1}{2}$	388.4	305.0	114.22	89.710	33.576
$\frac{5}{8}$	392.9	308.6	115.56	90.763	33.772
$\frac{3}{4}$	397.5	312.2	116.91	91.821	33.969
$\frac{7}{8}$	402.1	315.8	118.27	92.886	34.165
1 $\frac{1}{8}$	406.7	319.5	119.63	93.957	34.361
11	411.4	323.1	121.00	95.033	34.558
$\frac{1}{8}$	416.1	326.8	122.38	96.116	34.754
$\frac{1}{4}$	420.8	330.5	123.77	97.206	34.950
$\frac{3}{8}$	425.5	334.3	125.16	98.301	35.147
$\frac{1}{2}$	430.3	338.0	126.56	99.402	35.343
$\frac{5}{8}$	435.1	341.7	127.97	100.51	35.539
$\frac{3}{4}$	439.9	345.5	129.39	101.62	35.736
$\frac{7}{8}$	444.8	349.3	130.82	102.74	35.932
1 $\frac{1}{8}$	449.7	353.2	132.25	103.87	36.128
$\frac{1}{4}$	454.6	357.0	133.69	105.00	36.325
$\frac{3}{8}$	459.5	360.9	135.14	106.14	36.521
$\frac{1}{2}$	464.4	364.8	136.60	107.28	36.717
$\frac{5}{8}$	469.4	368.7	138.06	108.43	36.914
$\frac{3}{4}$	474.4	372.6	139.54	109.59	37.110
$\frac{7}{8}$	479.5	376.6	141.02	110.75	37.307
1 $\frac{1}{8}$	484.5	380.5	142.50	111.92	37.503

From Handbook, Cambria Steel Co.

Notes on Gearing.—Circular pitch =  $\frac{3.1416 \times \text{dia. ins.}}{\text{number of teeth}}$ ; diametrical pitch =  $\frac{\text{number of teeth}}{\text{dia. of pitch circle in ins.}}$

Formulae for Gears. Two gears are to run together, and for the large let  $D$  = diameter of pitch circle,  $D$  = whole diameter,  $N$  = number of teeth,  $V$  = velocity, and for the small  $d$  = diameter of pitch circle,  $d$  = whole diameter,  $n$  = number of teeth,  $v$  = velocity. Also let  $a$  = distance between centers of the two wheels,  $b$  = number of teeth in both wheels. Then  $N = \frac{nv}{V}$ ;  $n = \frac{bV}{v+V}$ ;  $V = \frac{nv}{N}$ ;  $v = \frac{NV}{n}$ ;  $D' = \frac{2av}{v+V}$ ;  $D = \frac{2a(n+2)}{b}$ ;  $d' = \frac{2aV}{v+V}$

\*Brown and Sharpe Mfg. Co.

WEIGHTS OF FLAT ROLLED STEEL BARS

POUNDS PER LINEAL FOOT

One cubic foot of steel weighs 489.6 pounds

For thicknesses from  $\frac{1}{8}$  in. to 2 ins. and widths from 1 in. to  $12\frac{1}{4}$  ins.

Thickness in Inches	1"	1 $\frac{1}{4}$ "	1 $\frac{1}{2}$ "	1 $\frac{3}{4}$ "	2"	2 $\frac{1}{4}$ "	2 $\frac{1}{2}$ "	2 $\frac{3}{4}$ "	3"
$\frac{1}{8}$	.638	.797	.956	1.12	1.28	1.43	1.59	1.75	7.65
$\frac{1}{4}$	.850	1.06	1.28	1.49	1.70	1.91	2.13	2.34	10.20
$\frac{3}{8}$	1.06	1.33	1.59	1.86	2.13	2.39	2.66	2.92	12.75
$\frac{1}{2}$	1.28	1.59	1.91	2.23	2.55	2.87	3.19	3.51	15.30
$\frac{5}{8}$	1.49	1.86	2.23	2.60	2.98	3.35	3.72	4.09	17.85
$\frac{3}{4}$	1.70	2.13	2.55	2.98	3.40	3.83	4.25	4.68	20.40
$\frac{7}{8}$	1.91	2.39	2.87	3.35	3.83	4.30	4.78	5.26	22.95
$\frac{15}{16}$	2.13	2.66	3.19	3.72	4.25	4.78	5.31	5.84	25.50
1"	2.34	2.92	3.51	4.09	4.68	5.26	5.84	6.43	28.05
1 $\frac{1}{8}$	2.55	3.19	3.83	4.46	5.10	5.74	6.38	7.01	30.60
1 $\frac{1}{4}$	2.76	3.45	4.14	4.83	5.53	6.22	6.91	7.60	33.15
1 $\frac{3}{8}$	2.98	3.72	4.46	5.21	5.95	6.69	7.44	8.18	35.70
1 $\frac{1}{2}$	3.19	3.98	4.78	5.58	6.38	7.17	7.97	8.77	38.25
1 $\frac{3}{4}$	3.40	4.25	5.10	5.95	6.80	7.65	8.50	9.35	40.80
1 $\frac{7}{8}$	3.61	4.52	5.42	6.32	7.23	8.13	9.03	9.93	43.35
1 $\frac{15}{16}$	3.83	4.78	5.74	6.69	7.65	8.61	9.56	10.52	45.90
1 $\frac{1}{4}$	4.04	5.05	6.06	7.07	8.08	9.08	10.09	11.10	48.45
1 $\frac{3}{4}$	4.25	5.31	6.38	7.44	8.50	9.56	10.63	11.69	51.00
1 $\frac{7}{8}$	4.46	5.58	6.69	7.81	8.93	10.04	11.16	12.27	53.55
1 $\frac{15}{16}$	4.68	5.84	7.01	8.18	9.35	10.52	11.69	12.86	56.10
1 $\frac{1}{2}$	4.89	6.11	7.33	8.55	9.78	11.00	12.22	13.44	58.65
1 $\frac{3}{2}$	5.10	6.38	7.65	8.93	10.20	11.48	12.75	14.03	61.20
1 $\frac{7}{8}$	5.31	6.64	7.97	9.30	10.63	11.95	13.28	14.61	63.75
1 $\frac{15}{16}$	5.53	6.91	8.29	9.67	11.05	12.43	13.81	15.19	66.30
1 $\frac{1}{4}$	5.74	7.17	8.61	10.04	11.48	12.91	14.34	15.78	68.85
1 $\frac{3}{4}$	5.95	7.44	8.93	10.41	11.90	13.39	14.88	16.36	71.40
1 $\frac{7}{8}$	6.16	7.70	9.24	10.78	12.33	13.87	15.41	16.95	73.95
1 $\frac{15}{16}$	6.38	7.97	9.56	11.16	12.75	14.34	15.94	17.53	76.50
1 $\frac{1}{4}$	6.59	8.23	9.88	11.53	13.18	14.82	16.47	18.12	79.05
2	6.80	8.50	10.20	11.90	13.60	15.30	17.00	18.70	81.60

## WEIGHTS OF FLAT ROLLED STEEL BARS—Continued

Thickness in inches	3"	3¼"	3½"	3¾"	4"	4¼"	4½"	4¾"	12"
⅜	1.91	2.07	2.23	2.39	2.55	2.71	2.87	3.03	7.65
	2.55	2.76	2.98	3.19	3.40	3.61	3.83	4.04	10.20
½	3.19	3.45	3.72	3.98	4.25	4.52	4.78	5.05	12.75
	3.83	4.14	4.46	4.78	5.10	5.42	5.74	6.06	15.30
⅝	4.46	4.83	5.21	5.58	5.95	6.32	6.69	7.07	17.85
	5.10	5.53	5.95	6.38	6.80	7.22	7.65	8.08	20.40
¾	5.74	6.22	6.69	7.17	7.65	8.13	8.61	9.08	22.95
	6.38	6.91	7.44	7.97	8.50	9.03	9.56	10.09	25.50
⅞	7.01	7.60	8.18	8.77	9.35	9.93	10.52	11.10	28.05
	7.65	8.29	8.93	9.56	10.20	10.84	11.48	12.11	30.60
1	8.29	8.98	9.67	10.36	11.05	11.74	12.43	13.12	33.15
	8.93	9.67	10.41	11.16	11.90	12.64	13.39	14.13	35.70
1 ⅛	9.56	10.36	11.16	11.95	12.75	13.55	14.34	15.14	38.25
	10.20	11.05	11.90	12.75	13.60	14.45	15.30	16.15	40.80
1 ¼	10.84	11.74	12.64	13.55	14.45	15.35	16.26	17.16	43.35
	11.48	12.43	13.39	14.34	15.30	16.26	17.21	18.17	45.90
1 ⅝	12.11	13.12	14.13	15.14	16.15	17.16	18.17	19.18	48.45
	12.75	13.81	14.88	15.94	17.00	18.06	19.13	20.19	51.00
1 ¾	13.39	14.50	15.62	16.73	17.85	18.97	20.08	21.20	53.55
	14.03	15.19	16.36	17.53	18.70	19.87	21.04	22.21	56.10
1 ⅞	14.66	15.88	17.11	18.33	19.55	20.77	21.99	23.22	58.65
	15.30	16.58	17.85	19.13	20.40	21.68	22.95	24.23	61.20
2	15.92	17.27	18.59	19.92	21.25	22.58	23.91	25.23	63.75
	16.58	17.96	19.34	20.72	22.10	23.48	24.86	26.24	66.30
2 ¼	17.21	18.65	20.08	21.52	22.95	24.38	25.82	27.25	68.85
	17.85	19.34	20.83	22.31	23.80	25.29	26.78	28.26	71.40
2 ½	18.49	20.03	21.57	23.11	24.65	26.19	27.73	29.27	73.95
	19.13	20.72	22.31	23.91	25.50	27.09	28.69	30.28	76.50
2 ¾	19.76	21.41	23.06	24.70	26.35	28.00	29.64	31.29	79.05
	20.40	22.10	23.80	25.50	27.20	28.90	30.60	32.30	81.60

WEIGHTS OF FLAT ROLLED STEEL BARS—Continued

Thickness in Inches	5"	5¼"	5½"	5¾"	6"	6¼"	6½"	6¾"	12"
1/8	3.19	3.35	3.51	3.67	3.83	3.98	4.14	4.30	7.65
1/4	4.25	4.46	4.68	4.89	5.10	5.31	5.53	5.74	10.20
3/8	5.31	5.58	5.84	6.11	6.38	6.64	6.91	7.17	12.75
1/2	6.38	6.69	7.01	7.33	7.65	7.97	8.29	8.61	15.30
5/8	7.44	7.81	8.18	8.55	8.93	9.30	9.67	10.04	17.85
3/4	8.50	8.93	9.35	9.78	10.20	10.63	11.05	11.48	20.40
7/8	9.56	10.04	10.52	11.00	11.48	11.95	12.43	12.91	22.95
1	10.63	11.16	11.69	12.22	12.75	13.28	13.81	14.34	25.50
1 1/8	11.69	12.27	12.86	13.44	14.03	14.61	15.19	15.78	28.05
1 1/4	12.75	13.39	14.03	14.67	15.30	15.94	16.58	17.21	30.60
1 1/8	13.81	14.50	15.19	15.88	16.58	17.27	17.96	18.65	33.15
1 1/4	14.88	15.62	16.36	17.11	17.85	18.59	19.34	20.08	35.70
1 1/2	15.94	16.73	17.53	18.33	19.13	19.92	20.72	21.52	38.25
1	17.00	17.85	18.70	19.55	20.40	21.25	22.10	22.95	40.80
1 1/8	18.06	18.97	19.87	20.77	21.68	22.58	23.48	24.38	43.35
1 1/4	19.13	20.08	21.04	21.99	22.95	23.91	24.86	25.82	45.90
1 1/2	20.19	21.20	22.21	23.22	24.23	25.23	26.24	27.25	48.45
1 3/4	21.25	22.31	23.38	24.44	25.50	26.56	27.63	28.69	51.00
1 5/8	22.31	23.43	24.54	25.66	26.78	27.89	29.01	30.12	53.55
1 3/4	23.38	24.54	25.71	26.88	28.05	29.22	30.39	31.56	56.10
1 7/8	24.44	25.66	26.88	28.10	29.33	30.55	31.77	32.99	58.65
1 1/2	25.50	26.78	28.05	29.33	30.60	31.88	33.15	34.43	61.20
1 9/8	26.56	27.89	29.22	30.55	31.88	33.20	34.53	35.86	63.75
1 5/4	27.63	29.01	30.39	31.77	33.15	34.53	35.91	37.29	66.30
1 11/8	28.69	30.12	31.56	32.99	34.43	35.86	37.29	38.73	68.85
1 3/4	29.75	31.24	32.73	34.21	35.70	37.19	38.68	40.16	71.40
1 11/4	30.81	32.35	33.89	35.43	36.98	38.52	40.06	41.60	73.95
1 7/8	31.88	33.47	35.06	36.66	38.25	39.84	41.44	43.03	76.50
1 11/8	32.94	34.58	36.23	37.88	39.53	41.17	42.82	44.47	79.05
2	34.00	35.70	37.40	39.10	40.80	42.50	44.20	45.90	81.60

## WEIGHTS OF FLAT ROLLED STEEL BARS—Continued

Thickness in Inches	7"	7¼"	7½"	7¾"	8"	8¼"	8½"	8¾"	12"
⅜	4.46	4.62	4.78	4.94	5.10	5.26	5.42	5.58	7.65
¼	5.95	6.16	6.38	6.59	6.80	7.01	7.23	7.44	10.20
⅜	7.44	7.70	7.97	8.23	8.50	8.77	9.03	9.30	12.75
⅝	8.93	9.24	9.56	9.88	10.20	10.52	10.84	11.16	15.30
⅞	10.41	10.78	11.16	11.53	11.90	12.27	12.64	13.02	17.85
1	11.90	12.33	12.75	13.18	13.60	14.03	14.45	14.88	20.40
1 ⅜	13.39	13.87	14.34	14.82	15.30	15.78	16.26	16.73	22.95
1 ⅝	14.88	15.41	15.94	16.47	17.00	17.53	18.06	18.59	25.50
1 ⅞	16.36	16.95	17.53	18.12	18.70	19.28	19.87	20.45	28.05
1 ¾	17.85	18.49	19.13	19.76	20.40	21.04	21.68	22.31	30.60
1 ⅞	19.34	20.03	20.72	21.41	22.10	22.79	23.48	24.17	33.15
1 ⅝	20.83	21.57	22.31	23.06	23.80	24.54	25.29	26.03	35.70
1 ⅞	22.31	23.11	23.91	24.70	25.50	26.30	27.09	27.89	38.25
1	23.80	24.65	25.50	26.35	27.20	28.05	28.90	29.75	40.80
1 ⅞	25.29	26.19	27.09	28.00	28.90	29.80	30.71	31.61	43.35
1 ⅝	26.78	27.73	28.69	29.64	30.60	31.56	32.51	33.47	45.90
1 ⅞	28.26	29.27	30.28	31.29	32.30	33.31	34.32	35.33	48.45
1 ¾	29.75	30.81	31.88	32.94	34.00	35.06	36.13	37.19	51.00
1 ⅝	31.24	32.35	33.47	34.58	35.70	36.82	37.93	39.05	53.55
1 ⅞	32.73	33.89	35.06	36.23	37.40	38.57	39.74	40.91	56.10
1 ⅞	34.21	35.43	36.66	37.88	39.10	40.32	41.54	42.77	58.65
1 ½	35.70	36.98	38.25	39.53	40.80	42.08	43.35	44.63	61.20
1 ⅞	37.19	38.52	39.84	41.17	42.50	43.83	45.16	46.48	63.75
1 ⅝	38.68	40.06	41.44	42.82	44.20	45.58	46.96	48.34	66.30
1 ⅞	40.16	41.60	43.03	44.47	45.90	47.33	48.77	50.20	68.85
1 ¾	41.65	43.14	44.63	46.11	47.60	49.09	50.58	52.06	71.40
1 ⅞	43.14	44.68	46.22	47.76	49.30	50.84	52.38	53.92	73.95
1 ⅝	44.63	46.22	47.81	49.41	51.00	52.59	54.19	55.78	76.50
1 ⅞	46.11	47.76	49.41	51.05	52.70	54.35	55.99	57.64	79.05
2	47.60	49.30	51.00	52.70	54.40	56.10	57.80	59.50	81.60

WEIGHTS OF FLAT ROLLED STEEL BARS—Continued

Thickness in inches	9"	9¼"	9½"	9¾"	10"	10¼"	10½"	10¾"	12"
¾	5.74	5.90	6.06	6.22	6.38	6.53	6.69	6.85	7.65
	7.65	7.86	8.08	8.29	8.50	8.71	8.93	9.14	10.20
⅞	9.56	9.83	10.09	10.36	10.63	10.89	11.16	11.42	12.75
	11.48	11.79	12.11	12.43	12.75	13.07	13.39	13.71	15.30
1	13.39	13.76	14.13	14.50	14.88	15.25	15.62	15.99	17.85
	15.30	15.73	16.15	16.58	17.00	17.43	17.85	18.28	20.40
1⅛	17.21	17.69	18.17	18.65	19.13	19.60	20.08	20.56	22.95
	19.13	19.66	20.19	20.72	21.25	21.78	22.31	22.84	25.50
1¼	21.04	21.62	22.21	22.79	23.38	23.96	24.54	25.13	28.05
	22.95	23.59	24.23	24.86	25.50	26.14	26.78	27.41	30.60
1½	24.86	25.55	26.24	26.93	27.63	28.32	29.01	29.70	33.15
	26.78	27.52	28.26	29.01	29.75	30.49	31.24	31.98	35.70
1⅝	28.69	29.48	30.28	31.08	31.88	32.67	33.47	34.27	38.25
	30.60	31.45	32.30	33.15	34.00	34.85	35.70	36.55	40.80
1⅞	32.51	33.42	34.32	35.22	36.13	37.03	37.93	38.83	43.35
	34.43	35.38	36.34	37.29	38.25	39.21	40.16	41.12	45.90
2	36.34	37.35	38.36	39.37	40.38	41.38	42.39	43.40	48.45
	38.25	39.31	40.38	41.44	42.50	43.56	44.63	45.69	51.00
2¼	40.16	41.28	42.39	43.51	44.63	45.74	46.86	47.97	53.55
	42.08	43.24	44.41	45.58	46.75	47.92	49.09	50.26	56.10
2½	43.99	45.21	46.43	47.65	48.88	50.10	51.32	52.54	58.65
	45.90	47.18	48.45	49.73	51.00	52.28	53.55	54.83	61.20
2¾	47.81	49.14	50.47	51.80	53.13	54.45	55.78	57.11	63.75
	49.73	51.11	52.49	53.87	55.25	56.63	58.01	59.39	66.30
3	51.64	53.07	54.51	55.94	57.38	58.81	60.24	61.68	68.85
	53.55	55.04	56.53	58.01	59.50	60.99	62.48	63.96	71.40
3¼	55.46	57.00	58.54	60.08	61.63	63.17	64.71	66.25	73.95
	57.38	58.97	60.56	62.16	63.75	65.34	66.94	68.53	76.50
3½	59.29	60.93	62.58	64.23	65.88	67.52	69.17	70.82	79.05
	61.20	62.90	64.60	66.30	68.00	69.70	71.40	73.10	81.60



WEIGHTS OF FLAT ROLLED STEEL BARS—Continued

Thickness in Inches	11"	11¼"	11½"	11¾"	12"	12¼"	12½"	12¾"
$\frac{3}{16}$	7.01	7.17	7.33	7.49	7.65	7.81	7.97	8.13
$\frac{1}{4}$	9.35	9.56	9.78	9.99	10.20	10.41	10.63	10.84
$\frac{5}{16}$	11.69	11.95	12.22	12.48	12.75	13.02	13.28	13.55
$\frac{3}{8}$	14.03	14.34	14.66	14.98	15.30	15.62	15.94	16.26
$\frac{7}{16}$	16.36	16.73	17.11	17.48	17.85	18.22	18.59	18.97
$\frac{1}{2}$	18.70	19.13	19.55	19.98	20.40	20.83	21.25	21.68
$\frac{5}{8}$	21.04	21.52	21.99	22.47	22.95	23.43	23.91	24.38
$\frac{3}{4}$	23.38	23.91	24.44	24.97	25.50	26.03	26.56	27.09
$\frac{7}{8}$	25.71	26.30	26.88	27.47	28.05	28.63	29.22	29.80
1	28.05	28.69	29.33	29.96	30.60	31.24	31.88	32.51
$1\frac{1}{8}$	30.39	31.08	31.77	32.46	33.15	33.84	34.53	35.22
$1\frac{1}{4}$	32.73	33.47	34.21	34.96	35.70	36.44	37.19	37.93
$1\frac{3}{8}$	35.06	35.86	36.66	37.45	38.25	39.05	39.84	40.64
$1\frac{1}{2}$	37.40	38.25	39.10	39.95	40.80	41.65	42.50	43.35
$1\frac{5}{8}$	39.74	40.64	41.54	42.45	43.35	44.25	45.16	46.06
$1\frac{3}{4}$	42.08	43.03	43.99	44.94	45.90	46.86	47.81	48.77
$1\frac{7}{8}$	44.41	45.42	46.43	47.44	48.45	49.46	50.47	51.48
$1\frac{3}{4}$	46.75	47.81	48.88	49.94	51.00	52.06	53.13	54.19
$1\frac{5}{8}$	49.09	50.20	51.32	52.43	53.55	54.67	55.78	56.90
$1\frac{3}{8}$	51.43	52.59	53.76	54.93	56.10	57.27	58.44	59.61
$1\frac{7}{8}$	53.76	54.98	56.21	57.43	58.65	59.87	61.09	62.32
$1\frac{1}{2}$	56.10	57.38	58.65	59.93	61.20	62.48	63.75	65.03
$1\frac{5}{8}$	58.44	59.77	61.09	62.42	63.75	65.08	66.41	67.73
$1\frac{3}{8}$	60.78	62.16	63.54	64.92	66.30	67.68	69.06	70.44
$1\frac{7}{8}$	63.11	64.55	65.98	67.42	68.85	70.28	71.72	73.15
$1\frac{3}{4}$	65.45	66.94	68.43	69.91	71.40	72.89	74.38	75.86
$1\frac{5}{8}$	67.79	69.33	70.87	72.41	73.95	75.49	77.03	78.57
$1\frac{3}{8}$	70.13	71.72	73.31	74.91	76.50	78.09	79.69	81.28
$1\frac{7}{8}$	72.46	74.11	75.76	77.40	79.05	80.70	82.34	83.99
2	74.80	76.50	78.20	79.90	81.60	83.30	85.00	86.70

The weights for 12" width are repeated on each page to facilitate making the additions necessary to obtain the weights of plates of any width greater than 12". Thus, to find the weight of  $15\frac{1}{2}" \times \frac{3}{8}"$ , add the weights to be found in the same line for  $3\frac{1}{2}" \times \frac{3}{8}"$  and  $12" \times \frac{3}{8}" = 10.41 + 35.70 = 46.11$  pounds. Weight of plate  $4' 6\frac{1}{2}" \times \frac{5}{8}" = 4 \times 25.50 + 13.81 = 115.81$ .

## NON-FERROUS METALS AND ALLOYS

**Copper.**—There are three recognized grades, viz., **electrolytic, Lake, and casting.** The first is refined by electrolytic methods and is very pure. Lake is also very pure in its natural or mineral state and requires simply to be melted down to bars for convenient handling. Casting copper contains more impurities and runs lower in conductivity than either electrolytic or Lake.

Copper is very ductile and malleable and can be rolled into sheets, drawn into wire, or cast. Electric conductivity equal to that of silver fuses at around 1930° F. Cast copper tensile strength 25,000, elastic limit 6,000, copper plates, rods and bolts tensile strength 33,500, elastic limit 10,000, annealed wire 36,000 tensile strength and elastic limit 10,000. Weight per cubic foot 554 lb. Sp. gr. 8.9.

**Aluminum.**—A very light and non-corrosive metal that is soft, ductile and malleable. Is acted on by salt water. The tensile strength can be increased by cold rolling, and is about the same as for cast iron. Aluminum castings have a tensile strength of about 15,000 lb. and elastic limit 6,500, sheets 24,000 and 12,000, bars 28,000 and 14,000. Weight per cubic foot 159 lb. Sp. gr. 2.56. Can be welded by electricity.

**Zinc** is practically non-corrosive in the atmosphere, hence is suitable for a coating for iron and steel surfaces exposed to the weather. See Galvanizing. Is ductile and malleable but to a less extent than copper. Melts at 780° F. Weight per cubic foot 436 lb. Sp. gr. 7.14.

**Lead** is a very malleable and ductile metal, but it is difficult to draw it into wire. Is rolled in sheets and pipe. Has a low tensile strength and elastic limit, hence lead pipes are only for low pressures. They are not affected by water containing carbonates or sulphates as a film of insoluble salt is formed which prevents action. Tensile strength 1,600 to 2,400 lb. Melts at 620° F. Weight per cubic foot 709 lb. Sp. gr. 11.07.

**Tin** is a white malleable metal that is not oxidized by moist air. It melts at 450° F., and is often used for safety plugs in boilers and also for protecting iron and copper from moisture. Weight per cubic foot 455 lb. Sp. gr. 7.3.

**Bronzes.**—Alloys of copper and tin with sometimes other metals added. Bronze as ordinarily understood is an alloy of copper and tin varying from 8 to 25% of tin. Average weight 530 lb. per cubic foot. Sp. gr. 8.62. **Gun metal** contains 8 to 10% tin,

and the metal in bells 25%. Cast gun metal, according to U. S. Navy Dept. specifications, contains 87-89% copper, 9-11% tin, 1-3% zinc, iron not to exceed .06% and lead not over .2%. Minimum tensile strength 30,000 lb.

**Phosphor Bronze.**—The strength varies with the percentage of copper, tin, lead and phosphorus. The following may be taken as a fair average, 82.2% copper, 12.95% tin, 4.28% lead and .52% phosphorus. Stems, sternposts and outboard castings of sheathed and composite vessels are made of it. It is harder, closer-grained and stronger than Admiralty bronze, has a tensile strength of about 50,000, elastic limit 24,000. Weight per cubic foot 508 lb. Sp. gr. 8.

**Admiralty Bronze** for propeller blades, etc., in the British Navy, is a mixture of 87% copper, 8% tin and 5% zinc. Average tensile strength 32,000 lb., with an elongation of 7½% in 2 ins. Sp. gr. 8.66.

**Titan Bronze** is an alloy of copper and zinc having the color of gold. Can be forged from a cherry red heat down to a black heat, while ordinary brass is only slightly malleable. It resists corrosion better than brass and is suitable for pump plungers, propeller bolts, motor boat shafts, etc. Castings have a tensile strength of 60,000 to 63,000 lb., elastic limit 35,000 to 40,000 lb. per square inch, elongation 15 to 20% in 2 ins. May be obtained in bars, in which case it has a tensile strength of 70,000 to 80,000, elastic limit 40,000 to 48,000, elongation 40% in 2 ins., reduction of area 45 to 50%.

**Tobin Bronze** is not affected by salt water, hence is suitable for propeller shafts of motor boats, valve stems and for other purposes where a strong material is required that is not acted on by salt water. Contains 59 to 63% copper, ½ to 1½% tin and remainder zinc. Tensile strength 60,000 to 65,000, compression 170,000 to 180,000. Weight per cubic foot 525 lb. Sp. gr. 8.4.

**Manganese Bronze** contains 56% copper, about 41% zinc and small quantities of iron, tin, aluminum and manganese. Used for outboard castings of sheathed and composite vessels. Tensile strength 60,000.

**Brasses.**—These consist of alloys of copper and zinc, the percentage of zinc varying from 10 to 50%. Brass castings have a tensile strength of 26,000 to 31,000 lb., but when the percentage of zinc exceeds about 45% the tensile strength falls off to around 20,000. Average weight per cubic foot 505 lb. Sp. gr. 8.10.

**Muntz Metal** is a brass containing 60% copper and 40% zinc. When rolled and annealed it has the properties of steel, being both malleable and strong, having a tensile strength of 50,000 to 65,000.

**Naval Brass** contains 62% copper, 36 to 37% zinc and 1 to 1½% tin. Is not affected by salt water. When rolled into rods according to the U. S. Navy requirements it must show a tensile strength of at least 60,000, an elastic limit of at least ½ the ultimate strength and an elongation of not less than 25% in two inches.

## COMMON ALLOYS

Alloy	Proportions
Admiralty bronze.....	Copper 87, tin 8, zinc 5
Aluminum bronze.....	Copper 89 to 98, aluminum 11 to 2
Babbitt (light).....	Copper 1.8, tin 89.3, antimony 8.9
Babbitt (heavy).....	Copper 3.7, tin 88.9, antimony 7.4
Brass (common yellow metal)	Copper 65.3, zinc 32.7, lead 2
Brazing metal.....	Copper 84, zinc 16
Gun metal.....	Copper 89, zinc 2.75, tin 8.25
Manganese bronze.....	Copper 88.64, zinc 1.57, tin 8.7, iron .72, lead .3
Muntz metal.....	Copper 60, zinc 40
Navy brass.....	Copper 62, zinc 37, tin 1
Navy composition.....	Copper 88, zinc 2, tin 10
Parsons white metal.....	Copper 1.68, zinc 22.9, tin 72.9, lead 1.68, antimony .84
Phosphor bronze.....	Copper 90 to 92, phosphide of tin 10 to 8
Steam metal.....	Copper 85, tin 6.5, zinc 4.5, lead 4.25
Tobin bronze.....	Copper 59 to 61, tin 1 to 2, zinc 37 to 38, iron .1 to .2, antimony .30 to .35
White metal.....	Antimony 12, lead 88

Weights of Copper and Brass Sheets, see pages 126 and 127.

## WOOD

**Sawing.**—The manner in which lumber is sawed has considerable influence on its qualities. By flat sawing is meant cutting the timber tangential to the annual rings. Rift or quarter sawing is cutting the boards out of a log so the annular rings are cut as nearly as possible in a radial direction. Flat sawing and rift sawing give rise in the trade to the terms "flat grain" and "edge grain"

respectively. Rift sawing is done for the sake of the beauty of the grain, and furthermore the lumber shrinks less, does not sliver, and wears more evenly and smoother than flat grain.

All timber when first cut contains a large quantity of moisture that must be got rid of by seasoning. Seasoning is either by natural means, as by leaving the timber exposed to a free circulation of air, or by artificial, as by putting it in a kiln. As a whole the former gives better results than the latter. The drier the timber the less likely it is to shrink and decay.

In general, the term "soft wood" is given to all trees of the coniferous or needle-leaved family, as pines, firs, spruces, hemlocks, cypress, larch, redwood, cedars, etc. The term "hard wood" is commonly applied to the broad-leaved family, as oaks, maples, hickories, elms, basswood, beech, walnut, birch, etc. In the U. S. Forestry Service hardness is determined by the weight required to force a steel ball .444 of an inch in diameter one-half its diameter into the wood. Tests of woods are given in the following table, the species being arranged from the softest to the hardest as expressed by the pressure in pounds necessary to make the required indentation.

As no two trees of the same species are exactly alike, the weights, strength, and other properties as given in the tables may vary within rather wide limits, so in making comparisons and in all strength calculations an ample factor of safety should be taken.

#### HARDNESS OF VARIOUS WOODS

Pressure in pounds required to indent specimen to depth of one-half diameter of a .444-inch diameter steel ball.

##### *Soft Woods*

Fir, Alpine.....	219	Pine, Norway.....	342
Spruce, Englemann.....	243	Spruce, Red.....	346
Cedar, Western Red.....	246	Cypress.....	354
Cedar, Northern White...	266	Tamarack.....	375
Pine, White.....	296	Fir, Grand.....	375
Pine, Lodgepole.....	315	Hemlock, Eastern.....	406
Pine, Western Yellow.....	320	Douglas Fir.....	408
Pine, Sugar.....	324	Hemlock, Black.....	464
Fir, White.....	328	Pine, Longleaf.....	512
Pine, Table Mountain....	333		

Average hardness, 340

*Hard Woods*

Basswood.....	242	Ash, Pumpkin.....	752
Buckeye, Yellow.....	286	Beech.....	824
Willow, Black.....	334	Maple, Hard.....	882
Butternut.....	386	Elm, Rock.....	888
Cherry, Red.....	386	Ash, White.....	941
Elm, White.....	511	Oak, Red.....	982
Ash, Black.....	548	Oak, White.....	1063
Sycamore.....	580	Oak, Swamp White.....	1158
Maple, Silver.....	592	Laurel, Mountain.....	1299
Maple, Red.....	612	Dogwood.....	1408
Cherry, Black.....	664	Locust, Black.....	1568
Tupelo.....	700	Locust, Honey.....	1846
Birch, Yellow.....	745	Osage, Orange.....	2037

Average hardness, 844

## HARD WOOD SIZES

The standard sizes adopted by the National Hardwood Lumber Association are as follows:

Standard lengths are 4, 5, 6, 7, 8, 9, 10, 11, 12, 13, 14, 15 and 16 ft., but not over 15% of odd lengths are admitted.

Standard thicknesses are  $\frac{1}{4}$ ,  $\frac{3}{8}$ ,  $\frac{1}{2}$ ,  $\frac{5}{8}$ ,  $\frac{3}{4}$ , 1,  $1\frac{1}{4}$ ,  $1\frac{1}{2}$ ,  $1\frac{3}{4}$ , 2,  $2\frac{1}{2}$ , 3,  $3\frac{1}{2}$ , 4,  $4\frac{1}{2}$ , 5,  $5\frac{1}{2}$  and 6 ins.

Standard thicknesses for surfaced lumber are:

Rough	Surfaced	Rough	Surfaced
$\frac{3}{8}$ ins. S-2-S* to.....	$\frac{2}{16}$ ins.	$1\frac{3}{4}$ ins. S-2-S to.....	$1\frac{1}{2}$ ins.
$\frac{1}{2}$ " " " " " " " " " " " "	$\frac{8}{16}$	2 " " " " " " " " " " " "	$1\frac{3}{4}$
$\frac{5}{8}$ " " " " " " " " " " " "	$\frac{10}{16}$	$2\frac{1}{2}$ " " " " " " " " " " " "	$2\frac{1}{4}$
$\frac{3}{4}$ " " " " " " " " " " " "	$\frac{12}{16}$	3 " " " " " " " " " " " "	$2\frac{3}{4}$
1 " " " " " " " " " " " "	$\frac{14}{16}$	$3\frac{1}{2}$ " " " " " " " " " " " "	$3\frac{1}{4}$
$1\frac{1}{4}$ " " " " " " " " " " " "	$1\frac{3}{16}$	4 " " " " " " " " " " " "	$3\frac{3}{4}$
$1\frac{1}{2}$ " " " " " " " " " " " "	$1\frac{1}{4}$		

\* S-2-S signifies surfaced on 2 sides.

Lumber surfaced one side only must be  $\frac{1}{16}$  inch full of the above thicknesses.

The standard sizes for hardwood lumber surfaced two sides adopted by the Hardwood Manufacturers' Association are as above, except that these manufacturers work  $\frac{3}{8}$ -in. stock to  $\frac{1}{4}$ -in. instead of  $\frac{1}{16}$ -in.

## SOFT WOOD SIZES

The standard lengths of soft woods are commonly in multiples of 2 ft., beginning at 4 or 6 ft., and standard widths in multiples of 2 ins., beginning at 4 ins.

**Common Woods.**<sup>1</sup>—Ash, white and red, the former often used for oars, is close grained, takes a good polish and warps very little. Weight per cubic foot 43 to 45 lb. Sp. gr. .75. Crushing strength along the fiber in pounds per square inch, 5,000 to 9,000.

**Balsa**, very light; life preservers are sometimes made of it.

**Black walnut**, heavy, strong and durable; for cabinet work and interior decoration. Weight per cubic foot 38 lb. Sp. gr. .61.

**Cedar (red)**, fine grained, strong, easily split, especially durable in contact with water. Used for planking in high grade motor boats. Weight per cubic foot 20 to 25 lb. Sp. gr. .33. There is also a white cedar that is soft, light and fine grained but lacking the strength and toughness of the red.

**Cherry**, for interior finish, has a close fine grain, and is very durable. Weight per cubic foot 42 lb. Sp. gr. .70.

**Chestnut**, comparatively soft, close grained, is brittle, but is durable when exposed to the weather. Weight per cubic foot 28 lb. Sp. gr. .45.

**Cork**, a tree growing in Southern Europe, the bark of which is used in life preservers and for insulation purposes in refrigerating rooms. To avoid sweating in cabins below a steel deck the plating may be coated with granulated cork. First a coat of sticky varnish is applied, then the cork dusted thickly over it and painted with two or three coats of white paint. Weight per cubic foot 15.6 lb. Sp. gr. .24.

**Cypress**, light, hard, close grained and durable, adapted for both outside and inside work. Weight per cubic foot 30 lb. Sp. gr. .48.

**Douglas fir**.—This term covers the timber known as yellow fir, red fir, western fir, Washington fir, Oregon or Puget Sound fir, northwest and west coast fir. Crushing strength parallel to grain 2,920 lb. per square inch. Weight per cubic foot 34 lb. Sp. gr. .54. Douglas fir is exceptionally strong for its weight, is durable and does not shrink much.

<sup>1</sup> NOTE.—Only those are given that are common in ship construction. The specific gravity and weight of the same wood varies; the value given is a fair average for seasoned wood. The moisture contents varies in seasoned timber from 15 to 20% and in green timber up to 50%. Sp. gr. and weight from 10th U. S. Census.

**Hackmatack**, a strong wood for knees connecting beams and frames of wood vessels. Weight per cubic foot 35 to 40 lb. Sp. gr. .59.

**Lignum vitae**, hard, strong and close grained with fibers running radially and tangentially. Is resinous and is difficult to split. Is used in ship's blocks, and stern and outboard bearings. Tensile strength along the fiber 14,800 lb. per square inch, crushing 7,000. Weight per cubic foot 60 to 65 lb. Sp. gr. 1.14.

**Locust** has a peculiar striped grain, is hard, and is suitable for exposed places where great durability is required. Weight per cubic foot 46 lb. Sp. gr. .73.

**Mahogany**, hard, close grained, difficult to split, takes a fine polish. The straight-grained varieties are little affected by the weather, although the cross varieties warp and twist. Used for planking in high speed motor boats, deck houses, etc., and interior finish. Weight per cubic foot 46 lb. Sp. gr. .73. The soft and inferior grades from Honduras and Mexico are called baywood.

**Maple**, light colored, fine grained, strong and heavy, used for interior trim. Weight per cubic foot 43 lb. Sp. gr. .68.

**Oak (white)**, very durable, largely employed in wood vessels for frames and beams, can be steamed and bent. Is not suitable for steel vessels as it contains an acid which attacks the steel. Weight per cubic foot 46 lb. Sp. gr. .74.

**Oak (live)**, the strongest of the oaks, seldom comes in long straight pieces. Weight per cubic foot 59 lb. Sp. gr. .95.

**Pine, long-leaf or Southern pine**, hard and strong, extensively used for decks. Weight per cubic foot 44 lb. Sp. gr. .70.

**Pine (Oregon)**—same as Douglas fir. See above.

**Pine (short-leaf)**, much resembling long-leaf, but inferior to it. Suitable for interior finish, flooring, etc. Weight per cubic foot 38 lb. Sp. gr. .61. North Carolina pine is the trade name given to that species of short-leaf pine known as the loblolly.

**Pine (white)**, light, very strong and easily worked. Weight per cubic foot 26 lb. Sp. gr. .41.

**Poplar or whitewood**, light, brittle and warps if weather changes. Is cheap and easy to work. Weight per cubic foot 30 lb. Sp. gr. .48.

**Spruce**, light, strong, tougher and more durable than white pine. Varieties: black, white and red. Norway spruce or white deal has a tough, straight grain which makes it an excellent material for masts. Spars, paddles and oars are often made of spruce.



Black spruce is used for wharf piling. Weight per cubic foot 27 lb. Sp. gr. .4 to .46.

Teak, a heavy, strong wood suitable for railings, armor backing, etc., does not readily split nor warp when exposed to alternate moisture and dryness. Will stand heavy wear, and contains a resinous oil which prevents the rusting of steel and iron when in contact with it. Weight per cubic foot 52 lb. Sp. gr. .82.

Physical tests, see Strength of Materials.

Feet board measure, see page 9.

Shipping weights, see page 18.

### MISCELLANEOUS NON-METALLIC MATERIALS

**Oakum.**—Consists of hemp fibers obtained from old rope. For caulking decks with oakum a light one-handed mallet is employed, the caulker hitting a thin flat chisel, forcing the oakum between the planks. In heavy work, as in the outside planking as a final operation, a large horsing mallet is used. After the deck seams are caulked, the oakum being slightly below the surface of the planks, they are payed, i. e., hot pitch is poured into the seams. Oakum is put up in standard bales weighing 50 lb. gross.

**Caulking Cotton.**—For caulking yachts and motor boats where the planking is thin, instead of oakum.

**Portland Cement.**—When mixed with sand and water is laid as a covering for the shell plating in the inner bottom. It not only protects the plating against the corrosive action of foul bilge water but against the erosive action of hard substances which may be washed about. In oil tankers the cement may be omitted, but vessels carrying sugar and copper ore should have a thick coat. Portland cement is not readily affected by ordinary substances but is softened by sulphate of ammonia. When laid, say  $1\frac{1}{2}$  ins. thick, the proportion should be 3 parts of sand to 1 of cement, but if less thickness is required the proportion may be as 2 to 1. Pure Portland cement weighs about 120 lb. per cubic foot; if laid with sand, 128 lb. See also Structural Details.

**Insulating Materials.**—These are magnesia, asbestos, cork and hair felt—the two former for covering hot surfaces, as steam pipes and boilers, and the two latter for cold pipes, as those containing brine.

**Magnesia** is the best non-conducting material and is the most expensive. In combination with asbestos as 85% magnesia and 15% asbestos it can be obtained in a variety of forms as in sec-

tional pipe covering, blocks, sheets and cement. A bag of 85% magnesia weighs 60 lb. and will cover approximately 40 sq. ft. one inch thick.

Asbestos will soften when in contact with water and should not be used where parts are subject to moisture as under the engine room floor plates or on cold water pipes. It can be obtained in sectional pipe covering, blocks, sheets and cement. A bag of asbestos cement weighs 100 lb. and will cover about 40 sq. ft. one inch thick.

Either cork or hair felt may be fitted around cold water and brine pipes but should not be on steam. Cork may be obtained in the granulated form or in sheets. Hair felt comes in rolls  $\frac{1}{4}$ ,  $\frac{1}{2}$ ,  $\frac{3}{4}$ , 1 and  $1\frac{1}{2}$  ins. thick by 6 ft. wide, and after being put around a pipe is covered with canvas. See Refrigeration.

**Mineral Wool**, a fibrous material made from blast furnace slag, is a good non-combustible covering, but is brittle and liable to fall to powder where much jarring exists.

Air space alone is one of the poorest non-conductors, though the best owe their efficiency to the numerous minute air cells in their structure. This is seen in the value of different forms of carbon, from cork charcoal to anthracite dust, the former being three times as valuable, though in chemical constitution they are practically identical.

Based on one inch thickness, the approximate efficiencies of the following coverings referred to bare pipes are—asbestocel, 76.8%, magnesia, 83.5%, asbestos, Navy brand, 82%.

**Steam Pipe Covering** is made in standard lengths 3 ft. long, which when placed around a pipe are fastened on by brass bands; in addition canvas may be sewed around them. The best and most expensive is magnesia, which has high non-conducting qualities and is also very light. Next to this are asbestos sheets made into pipe form so there are air cells, thus giving (as air is an excellent non-conductor of heat) a cheap and efficient covering. For high-pressure steam piping 85% magnesia is used, while for lower pressure and exhaust piping asbestos with air cells, about one inch thick, answers. Valves and fittings are covered with cement, and in some instances the flanges have coverings that can be easily removed.

**Boiler Covering.**—For the best results on high temperatures  $1\frac{1}{2}$ - to 2-inch magnesia blocks are wired on, and finished with a coat of magnesia cement. A cheaper covering for pressures over 125 lb. may consist of 2-inch asbestos blocks, covered with wire mesh and finished with a  $\frac{1}{2}$ -inch coat of cement.

Cylinders may be covered with asbestos or magnesia blocks wired on and then inclosed in teak or mahogany vertical strips secured with brass bands. Sheet iron is sometimes put on instead of wood strips.

ABSTRACT OF SPECIFICATIONS ISSUED BY U. S. NAVY DEPARTMENT

Part	Covering	Lagging
Main cylinders and valve chests.	Magnesia	Lagged all over with galvanized sheet iron
Upper cylinder heads. . . . .	Magnesia	Neatly fitted iron floor plates, with flat topped corrugations
Steam and exhaust pipes, valves, fittings and flanges, separators, feed water heaters. . . . .	Magnesia	Canvas sewed on and painted
Boiler drums. . . . .	Magnesia 2½ ins.	

Magnesia for lagging, and in uptakes, smoke pipes, etc., will be composed as follows:

Carbonate of magnesia. . . . .	85%
Asbestos fiber. . . . .	15%
Canvas on pipes 2 ins. dia. and smaller. . . . .	8 oz. per yard
Canvas on pipes above 2 ins. dia., separators, etc. . . . .	15 oz. per yard

TESTS OF INSULATING MATERIALS

Material	Thick-ness Inches	Transmission in B.t.u. per Square Feet per Degree F. Difference in Temperature per 24 Hours	Transmission in B.t.u. per Square Feet per Degree F. Difference in Temperature per One Inch Thickness per 24 Hours
Composition cork board (granulated cork and asphalt). . . . .	2	4.5	9
Slag wool in board form, sometimes called rock cork. . . . .	2	3.8	7.6
Nonpareil cork board. . . . .	1	6.2	6.2
Nonpareil cork board. . . . .	2	3.	6.
Nonpareil cork board. . . . .	3	2.2	6.6

## PERCENTAGE OF HEAT TRANSMITTED THROUGH VARIOUS PIPE COVERINGS

(The heat loss from an uncovered pipe is taken as 100%)

Substance	Heat Loss Per Cent.
Pipe without covering	100
Pipe painted with black asphaltum	105
Pipe painted with light drab lead paint	107
Pipe painted glossy white	95
Asbestos paper, two layers one inch hair felt canvas covered	15
Asbestos paper, 4 thicknesses	50
Asbestos paper, 2 thicknesses	75
Asbestos, molded, mixed with plaster of Paris	30
Asbestos and wool felt	20
Magnesia, molded, applied in plastic form	25
Magnesia as a class	20
Mineral wool as a class	20
Rock wool as a class	22
Fossil meal as a class	25

From Plumbers' Handbook, Int. Text Book Co.

## TABLE OF RELATIVE VALUE OF NON-CONDUCTING MATERIALS

Substance	Value
Loose wool	3.35
Geese feathers	1.08
Felt, hair, or wool	1.00
Carded cotton	1.00
Mineral wool	.68 to .83
Carbonate of magnesia	.67 to .76
Rice chaff, loose	.76
Paper	.50 to .74
Cork	.71
Sawdust	.61 to .68
Wood ashes	.61
Wood across grain	.40 to .55
Coal ashes	.35 to .49
Asbestos, paper	.47
Asbestos, fibrous	.36
Air space undivided	.14 to .22
Sand	.17

From Handbook, Lukens Iron &amp; Steel Co.

## SECTION IV

### SHIP CALCULATIONS

**Length over all** is the length measured from the foremost tip of the stem bar to the aftermost tip of the overhang of the stern.

**Length between Perpendiculars.**—For vessels with straight vertical stems, the length between perpendiculars is taken from the fore side of the stem bar to the aft side of the stern post. When the stem is raked, that is, inclined forward, the length is measured from the fore side of the stem bar at the upper deck. Should the vessel have a clipper or curved stem, the length is measured from the point where the line of the upper deck beams would intersect the fore edge of the stem if it were produced in the same direction as the part below the cutwater.

**Lloyd's Length** is measured from the fore part of the stem to the after part of the stern post on the range of the upper deck beams except in awning or shelter-deck vessels, in which cases the length is measured on the range of the deck beams next below the awning or shelter deck. In vessels in which the stem forms a cutwater the length is measured from the point where the upper-deck beam line would intersect the fore edge of the stem if it were produced in the same direction as the part below the cutwater. In vessels having cruiser sterns, the length is taken as 96% of the extreme length from the fore part of the stem on the range of the upper-deck beams to the aftermost part of the cruiser stern, but it is not to be less than the length from the fore part of the stem to the after side of sternpost when fitted, or to the fore side of the rudder stock when a sternpost is not fitted.

**Length for Tonnage.**—See Registry.

**Extreme breadth** is measured over the outside plating at the greatest breadth of the vessel.

**Breadth molded** is taken over the frames at the greatest breadth.

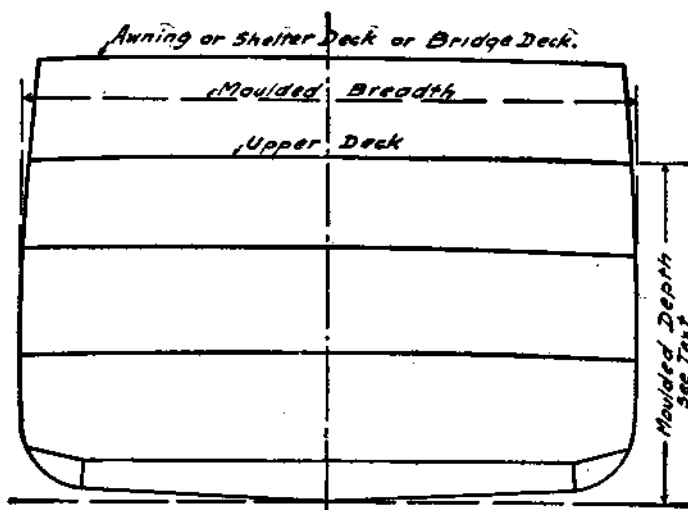

Figure 18

**Depth, Lloyd's (molded)** (Fig. 18) is measured at the middle of the length from the top of keel to the top of beam at the side of the uppermost continuous deck, except in awning or shelter-deck vessels, where it may be taken to the deck next below the awning or shelter deck, provided the height of 'tween-decks does not exceed 8 ft. When the height of 'tween-decks exceeds 8 ft. the depth is to be measured from top of keel to a point 8 ft. below the awning or shelter deck.

**Depth of Hold** is measured from top of ceiling at the middle of the length in vessels with ordinary floors or from top of ceiling on double bottoms if ceiling is laid, or when no ceiling is laid from the tank top plating to the top of the beams of the first deck. Two and a half inches is the usual allowance for the ceiling.

**Draft.**—Most vessels have their draft load line parallel to the keel so that the draft at any point is the same, but in vessels with a drop or drag keel the draft is taken from the lowest point of the drag. The actual or extreme draft includes the depth of the keel. Figures which are placed at the bow and stern for indicating draft read to the lowest point of the figure and are 6 ins. high; so if the

water was half way up on 10, the draft would be 10 ft. 3 ins. or if just covering it, 10 ft. 6 ins.

**Extreme Proportions.**—A vessel is said to have extreme proportions when her length exceeds eleven times her molded depth. In such a vessel additional longitudinal strength is required.

**Displacement** is the amount of water displaced by a vessel. If she is floating in equilibrium in still water, the weight of water she displaces equals the weight of the vessel herself with everything on board. The displacement in cubic feet when floating in salt water divided by 35, and when floating in fresh water divided by 36, gives the total weight of a ship and her cargo in tons; as 35 cu. ft. of salt water weighs 1 ton (2240 lb.) and 36 cu. ft. of fresh water the same amount.

The displacement of a steel vessel is calculated to the molded lines, and, as a rule, no allowance is made for the thickness of the

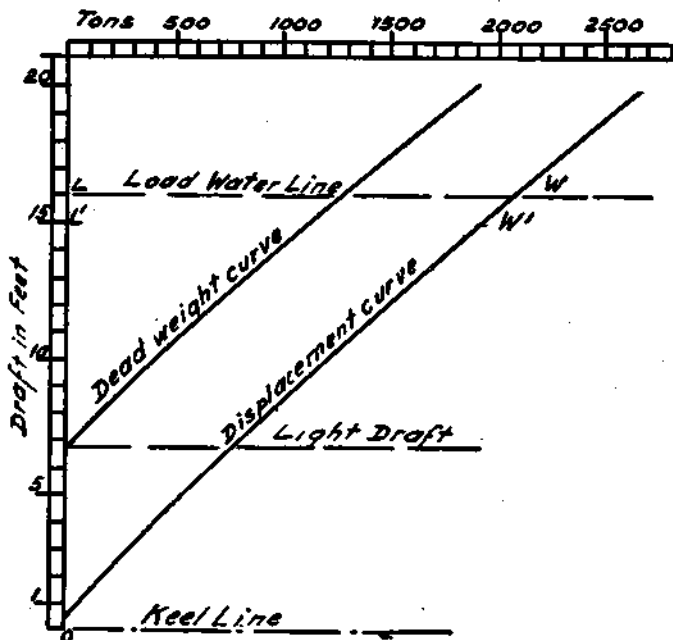

Figure 19.—Curves of Displacement and Dead Weight.

shell plating, although the excess of water displaced by the shell amounts to about 1% of the total. For wooden vessels (motor boats, tugs, lighters, etc.) the displacement is calculated to the outside of the planking. On the Great Lakes (United States) the displacement is calculated in tons of 2000 lb., elsewhere in tons of 2240 lb.

Displacement = dead weight  $\times$  1.64 (approximately).

For calculation of displacement see "Displacement Sheet."

A curve of displacement (see Fig. 19) can be plotted as follows: Lay off on the line *OL* to any convenient scale the draft in feet of the vessel, as 1, 2, 3, etc., and draw in the water lines. On the load-water line lay off to any convenient scale divisions representing tons, the distance *WL* representing the displacement at the load-water line, *W'L'* the displacement at the second water line, and so on. A curve drawn through the points *W*, *W'*, etc., to *O* is the curve of displacement. From this curve, knowing the draft, any displacement can be readily obtained.

Dead weight is the carrying capacity and includes the tons of cargo and generally the coal. The dead weight equals about 64% of the displacement.

The registry of a vessel as prescribed by the U. S. Treasury Department, Revised Statutes, Section 4150, is as follows:

The registry of every vessel shall express her length and breadth, together with her depth and the height under the third or spar deck, which shall be ascertained in the following manner: The tonnage deck in vessels having three or more decks shall be the second deck from below; in all other cases the upper deck is the tonnage deck. The length from the fore part of the outer planking on the side of the stem to the after part of the main stern-post of screw steamers and to the after part of the rudder-post of all other vessels measured on the top of the tonnage deck shall be accounted the vessel's length. The breadth of the broadest part on the outside of the vessel shall be accounted the vessel's breadth of beam. A measure from the under side of the tonnage-deck plank, amidships, to the ceiling of the hold (average thickness) shall be accounted the depth of the hold. If the vessel has a third deck, then the height from the top of the tonnage deck plank to the under side of the upper-deck plank shall be accounted as the height under the spar deck. All measurements to be taken in feet and fractions of feet, and all fractions of feet shall be expressed in decimals.

Register ton measurement is the measurement based on a ton of 2240 lb. occupying 100 cu. ft.

Gross tonnage is the measurement in register tons of the interior capacity of the entire ship.

Net tonnage is the tonnage in register tons upon which payment



is made, and is the space available for cargo and passengers. Roughly, for freight steamers, if the net tonnage is multiplied by 2.5, the tons of cargo that can be carried are obtained. This assumes that the cargo occupies 40 cu. ft. per ton. For calculation of tonnage for vessels using the Suez Canal, see "Suez Canal Tonnage Rules," published by Board of Trade, London; and for those using the Panama Canal see "Panama Canal Rules," published by the Treasury Department, Washington.

**Cubic Capacity.**—When the term "cubic capacity cargo space" is used, this is taken as the cubic capacity of the cargo holds calculated to the molded lines of the vessel. Cubic grain measurement is sometimes taken one or two inches inside the molded lines. Cubic bale measurement is generally understood as being to the bottom of the deck beams and to the inboard face of the reverse frames.

**Tons per Inch of Immersion.**—It is often necessary to find the distance a vessel will sink when known weights are placed on board, or how much she will rise if weights are removed.

If  $A$  is the area of a water plane in square feet, then the displacement of a layer 1 ft. thick, supposing the vessel to be parallel sided, is  $A \times 1 = A$  cu. ft., or  $\frac{A}{35}$  tons in salt water. For a layer 1 in.

thick, the displacement is  $\frac{A}{35 \times 12}$  tons, and this is the number of tons that must be placed on board to make a vessel sink 1 in., or the number of tons to be removed to lighten her 1 in.

**Examples.**—(1) A steamer 350 ft. long, 45 ft. beam, has a draft of 20 ft. How many tons must be placed on board to make her sink 1 in.?

First find the area of the water plane, assuming a coefficient of fineness of the water plane as .85. Then the area is

$$.85 \times 350 \times 45 = 13,387.5 \text{ sq. ft.}$$

$$\text{Tons per inch of immersion} = \frac{\text{area of water plane}}{35 \times 12} = \frac{13,387.5}{420} = 31.8 \text{ tons.}$$

Therefore, when the steamer is drawing 20 ft., 31.8 tons would have to be placed aboard to make her sink 1 in.

(2) At a draft of 16 ft., the tons per inch of immersion of a steamer are 12.5. If 75 tons of cargo were removed, find the decrease in draft and the new draft.

$$\text{Decrease in draft} = \frac{75}{12.5} = 6 \text{ ins.}$$

$$\text{New draft} = 16 \text{ ft. } 6 \text{ ins.} = 15 \text{ ft. } 6 \text{ ins.}$$

A curve of tons per inch of immersion (see Fig. 20) can be plotted as follows: Lay off on the line  $OL$  to any convenient scale

the draft in feet of the vessel, as 1, 2, 3, etc. (in a large vessel take water lines say 4 ft. apart), and draw in the water lines. On the water lines lay off to any convenient scale divisions representing tons that must be added to make the vessel sink 1 in. A curve through the points is the curve of tons per inch of immersion.

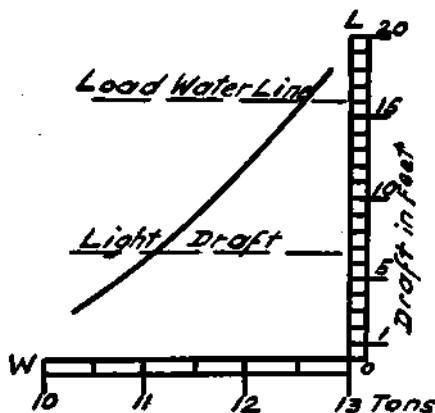

Figure 20.—Curve of Tons per Inch of Immersion.

**Approximate Formulæ for Tons per Inch of Immersion.**—Let

$L$  = length of water line in ft.;

$B$  = beam in ft.

$$\text{For fine vessels, tons per inch of immersion} = \frac{L \times B}{600}$$

$$\text{For medium vessels, tons per inch of immersion} = \frac{L \times B}{550}$$

$$\text{For cargo vessels, tons per inch of immersion} = \frac{L \times B}{500}$$

The coefficient of fineness of water plane is the ratio of the area of the water plane to the circumscribing rectangle. For ships with fine ends this is 0.7; for ships of ordinary form, 0.75; for ships with bluff ends, 0.8 to 0.89.

Prismatic coefficient is the ratio between the volume of the displacement and a solid having a transverse area equal to the area of the immersed midship section multiplied by the length taken for calculating the displacement.

The coefficient of fineness of midship section is the ratio of the area of the immersed midship section to the area of its circumscribing rectangle. The coefficient for ordinary ships varies from .85 to .95, the latter value being for a section with a very flat bottom.

The block coefficient is the ratio of the volume of the displacement to the volume of a block having the same length, breadth and mean draft. Below are the block coefficients of various types of vessels:

Barge .....	.85 to .9
Very full cargo vessels up to 8 knots .....	.8 to .85
Full cargo vessels up to 12 knots .....	.76 to .82
Large cargo vessels up to 12 to 14 knots .....	.7 to .76
Intermediate cargo and coastwise vessels .....	.65 to .7
Fast Atlantic liners .....	.6 to .65
English Channel passenger steamers .....	.5 to .6
Steam trawlers, tugs .....	.56 to .6
Paddle passenger steamers .....	.46 to .57
Battleships .....	.6 to .65
Cruisers .....	.48 to .55
Torpedo boats and destroyers .....	.4 to .48
Sailing vessels .....	.6 to .72
Steam yachts .....	.45 to .6
Sailing yachts .....	.3 to .52

Above coefficients from Design and Cons. of Ships, J. H. Biles.

**Wetted Surface** is the area of the immersed portion of a vessel.

Let  $W$  = displacement in tons;  $L$  = length of vessel in ft.;  
 $D$  = mean draft in ft.;  $V$  = volume of displacement in cu. ft.

$$\text{Wetted surface in sq. ft.} = 1.7 L \times D + \frac{V}{D};$$

$$\text{or} = 15.5 \sqrt{W \times L},$$

$$\text{or} = (L \times B \times 1.7) + (L \times B \times \text{block coefficient});$$

$$\text{or} = \sqrt[3]{V^2} \left( 3.4 + 2 \frac{L}{\sqrt[3]{V}} \right).$$

**Center of Buoyancy** is the center of gravity of the displaced water and is determined solely by the shape of the under water portion of a ship's hull. For calculations see "Displacement Sheet."

In vessels of ordinary form the vertical position of the center of buoyancy below the load-water line varies from .4 to .45 of the mean draft to the top of the keel, the latter (.45) being the value in vessels of full form. For yachts and vessels of unusual shape the above approximate rule does not apply.

Morriah's approximate formula for the distance of the center of buoyancy below the load-water line is as follows:

Let  $V$  = volume of displacement up to the load-water line in cu. ft.;  $A$  = area of load-water plane in sq. ft.;  $d$  = mean draft to top of keel in ft.

Then the center of buoyancy below the load-water line =

$$\left( \frac{1d}{32} + \frac{V}{A} \right)$$

To find the fore and aft position of the center of buoyancy of a vessel, having given the areas of equidistant cross sections. Lay off a table as below which is of a vessel with cross sections 9.5 feet apart, the position of the center of buoyancy being desired from the middle station, that is, No. 5.

Station	Area of Section	Simpson's Multipliers	Functions of Area	Number of Intervals from Middle Station	Moments
1.....	1.2	1	1.2	4	4.8
2.....	17.6	4	70.4	3	211.2
3.....	41.6	2	83.2	2	166.4
4.....	90.7	4	362.8	1	362.8
5.....	134.3	2	268.6	0	745.2
6.....	115.4	4	661.6	1	661.6
7.....	61.7	2	123.4	2	246.8
8.....	30.4	4	121.6	3	364.8
9.....	6.6	1	6.6	4	26.4
			1699.4		1299.6

$$\text{Excess of products aft} = 1299.6 - 745.2 = 554.4$$

$$\text{Volume of displacement cubic feet} = \frac{1}{2} \times 9.5 \text{ ft.} \times 1699.4$$

$$\begin{aligned} \text{Then center of buoyancy aft of middle} \\ \text{station or ordinate 5} &= \frac{\frac{1}{2} \times 9.5 \times 9.5 \times 554.4}{\frac{1}{2} \times 9.5 \times 1699.4} \\ &= 3.9 \text{ ft.} \end{aligned}$$

**Transverse Metacenter.**—Assume that a vessel is floating in still water under normal conditions (see Fig. 21),  $WL$  being the water line,  $B$  the center of buoyancy, and  $G$  the common center of gravity of the hull, engines, boilers and all other weights on the vessel.

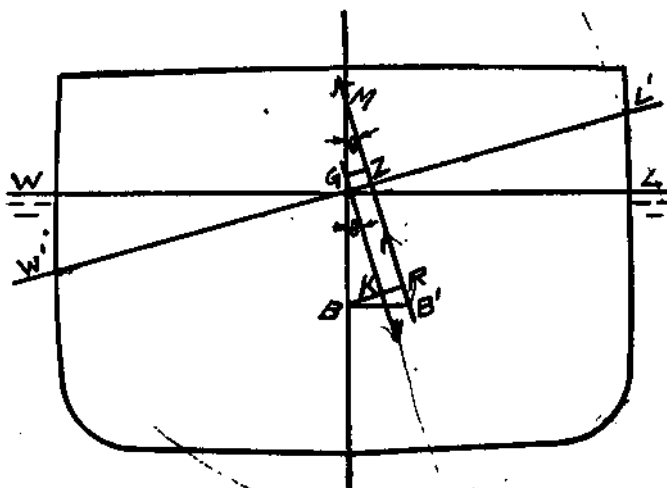

Figure 91

If the vessel is inclined at a small angle, then  $W' L'$  is the new water line, and the new volume of displacement has its center of buoyancy at  $B'$ . The upward force of buoyancy acts through  $B'$ , while the weight of the ship acts vertically down through  $G$ , the center of gravity. The vertical line through  $B'$  cuts the center line of the vessel at  $M$ , and this point  $M$  is called the meta-center and the distance  $GM$  the transverse metacentric height.

TABLE OF METACENTRIC HEIGHTS

Type of Ship	Value of $G. M.$
Harbor vessels, as tugs.....	15 to 18 ins.
Small cruisers.....	2 ft. to 2 ft. 6 ins.
Battleships.....	4 ft. to 5 ft.
Shallow draft gunboats for river use.....	12 ft.
Merchant steamers.....	1 ft. to 3 ft.
Sailing vessels.....	3 ft. to 3 ft. 6 ins.

See also table on Merchant Vessels and table in paragraph To Find Vertical Position of the Center of Gravity.

A ship with a large transverse metacentric height comes to the upright position very suddenly, while a ship with a small one comes to the upright position more slowly and is more comfortable in a seaway.

Referring to the figure it will be noted that the weight of a vessel acting vertically downward through the center of gravity, and the buoyancy of the water acting vertically upward through the new center of buoyancy form a couple. Draw  $GZ$  perpendicular to  $B'M$ . Then  $GZ$  is the arm of the couple, and the moment of the couple is  $W \times GZ$ .

If  $G$  is below  $M$  the ship is in stable equilibrium.

If  $G$  is above  $M$  the ship is in unstable equilibrium.

If  $G$  coincides with  $M$  the ship is in neutral or indifferent equilibrium.

For small angles up to  $10^\circ$  to  $15^\circ$ ,  $M$  practically remains in a constant position, hence  $GZ = GM \times \sin \theta$ . As  $GZ$  is the arm of the couple, then the moment of the couple is  $W \times GM \times \sin \theta$ , and if  $M$  is above  $G$ , this moment tends to right the ship, and is called the moment of statical stability at the angle  $\theta$ .

The above is called the metacentric method of determining a vessel's stability, and can only be used for small angles up to  $15^\circ$ . For larger angles cross curves of stability are calculated. (See section on Cross Curves.)

*Example.* A vessel 250 ft. long having a displacement of 3300 tons has a metacentric height of 2 ft. 6 ins. What is her righting moment if she is inclined at an angle of 12 degrees?

$$\begin{aligned} \text{Righting moment} &= W \times GM \times \sin \theta \\ &= 3300 \times 2.5 \times \sin 12^\circ = 1715 \text{ ft.-tons.} \end{aligned}$$

**To Find Height of Metacenter Above the Base Line.**—The following formula\* gives the height with a fair degree of accuracy.

Let  $H$  = draft in feet

$B$  = beam in feet

$a$  = a coefficient varying between .57 and .54, depending on the coefficient of fineness and exact shape of lines, and decreasing for the same vessel about .01 as the draft increases from 12 ft. to 24 ft. The values .57 to .54 are for coastwise passenger and freight steamers of modern design, having a fine load water line forward and full midship section.

\* From International Marine Engineering, New York.

$C$  = coefficient of .078 to .082 for coastwise passenger and freight steamers.

Then the height of the metacenter above the base =  $a \times H + \frac{C \times B^2}{H}$ .

**To Find the Moment of Inertia of a Water Plane About the Center Line.**—Divide the length of the plane into a convenient number of parts and arrange a table as follows:

Number of Ordinate	Semi-ordinates of Water Planes	Cubes of Semi-ordinates	Simpson's Multipliers	Functions of Cubes
1			1	
2			4	
3			2	
4			4	
etc.			etc.	

The sum of the functions of cubes  $\times \frac{1}{3}$  the common distance the ordinates are apart  $\times \frac{1}{3} \times 2$  (as only semi-ordinates were taken) = the moment of inertia of the water plane about its center line.

**Approximate Formula for the Moment of Inertia of a Ship's Water Plane About the Center Line.**

Let  $L$  = length in feet

$B$  = beam in feet

$n$  = coefficient for ships with fine water-line planes .04

coefficient for ships with moderate water-line planes .05

coefficient for ships with very full water-line planes .06

$I$  = moment of inertia

Then  $I = n L B^3$

**Formula for Finding the Distance of the Transverse Metacenter above the Center of Buoyancy.**

$I$  = moment of inertia of water plane about its center line

$V$  = volume of displacement in cubic feet

Then  $BM = \frac{I}{V}$ . See Displacement Sheet.

**Approximate Formula for the Distance of the Transverse Metacenter above the Center of Buoyancy.**

The formula for the transverse metacenter is  $BM = \frac{I}{V}$

Let  $B$  = beam in feet

$D$  = molded draft in feet

$a$  = a coefficient of .08 to .1 (say .09 for a vessel with a block coefficient of .75)

Then  $BM = a \times \frac{B^3}{D}$

**Displacement Sheet.**—The procedure outlined below is the one usually employed in calculating the displacement, centers of buoyancy and metacenters.

On a profile of a vessel drawn to a convenient scale, say  $\frac{1}{2}$  in. = 1 ft. for small, and  $\frac{1}{4}$  in. = 1 ft. for large, divide the distance between the forward and after perpendiculars into any number of even parts. At these divisions erect perpendiculars, take cross sections, lay out a body plan and on it draw water lines. In the displacement calculations made for the tug on page 180, 10 sections or ordinates were taken with half-ordinates at both ends, the ordinates being 9.5 ft. apart. The water lines were spaced 2 ft. apart, with a one-foot water line between the base line and second water line. Half-ordinates and an additional water line were taken so the calculations would be close.

Rule a sheet as shown on page 180 and write in a horizontal row the figures 1, 2, 4, etc., for the water lines and below Simpson's multipliers as  $\frac{1}{2}$ , 2,  $1\frac{1}{2}$ , 4, etc. In the vertical column at the left write the numbers of the ordinates as 1,  $1\frac{1}{2}$ , 2, etc., and in the next column Simpson's multipliers as  $\frac{1}{2}$ , 2,  $1\frac{1}{2}$ , 4, etc. From the body plan scale the distances from the center line to the intersection at the second water line and write it down (generally in red ink) under 2 water line as .10; do this for the  $1\frac{1}{2}$  ordinate which is .33, and so on for all the water lines.

Multiply the Simpson's multipliers below the water lines by the half-breadths and write the products below. Thus  $.10 \times 1\frac{1}{2} = .15$ ,  $.33 \times 1\frac{1}{2} = .50$ , etc. Add these products horizontally for each ordinate as for No. 1,  $.15 + .4 + .2 + .4 + .1 = 1.25$  and write the sum in the column functions of areas. Multiply the functions of areas by Simpson's multipliers as  $\frac{1}{2}$ , 2,  $1\frac{1}{2}$ , 4, etc., writing the products in the column multiples of areas. Add up this column



which in the present case is 3256 and multiply it by  $\frac{1}{3}$  of each interval and by  $\frac{1}{3}$  of the distance the water lines are apart, thus,  $\frac{1}{3} \times 2 \text{ ft.} \times \frac{1}{3} \times 9.5 \text{ ft.} \times 2$  (as half-breadths were taken), which will give the volume of the displacement in cubic feet as 13748, and to convert it into salt water tons divide by 35, as 35 cu. ft. of salt water weigh one ton.

To find the fore and aft center of buoyancy, multiply the multiples of areas by their lever arm from the midship ordinate, thus giving forward and after moments as  $.60 \times 5 = 3.$ ,  $35.22 \times 4\frac{1}{2} = 158.49$ , etc. Add up the forward moments and the after ones. In the present case the after sum or 3287.92 is the largest, so subtract the forward from it leaving a remainder of 617.95. Multiply 617.95 by 9.5 ft., the distance the ordinates are apart, and the product divided by the sum of the multiples of areas will give the location of the center of buoyancy; in the present vessel it is aft of No. 6, the midship ordinate, a distance of 1.83 ft.

To find the vertical position of the center of buoyancy, multiply the half-breadth as for 2 *W. L.* at No. 1, viz.: .10 by Simpson's multiplier  $\frac{1}{2}$  giving .50; do the same for the next half-breadth, as .33 by 2, giving .66, writing the products in the column to the right and so on. Continue thus for the other water lines, and add up each as 2.75, 133.33, 170.90, etc., multiplying them by Simpson's multipliers as  $\frac{1}{2}$ , 2,  $1\frac{1}{2}$ , 4, etc., the products being 1.37, 246.66, 256.35, etc. Take moments about the base line which is 0 with arms  $\frac{1}{2}$ , 1, 2, 3, etc., the sum of which is 9416.47. Multiply 9416.47 by the distance the water lines are apart or 2 ft., and divide by the sum of the multiples of areas, the quotient being 5.78 ft., which is the distance the center of buoyancy is above the base line.

The above calculations may be simplified by using a planimeter for getting the areas of the cross sections. Thus for the displacement lay off a table as below:

Station	Reading of Planimeter	Simpson's Multipliers	Functions of Areas
1		$\frac{1}{2}$	
$1\frac{1}{2}$		2	
2		$1\frac{1}{2}$	
etc.		etc.	

Then instrument scale constant  $\times$  sum of functions of areas  $\times \frac{1}{3}$  common interval  $\times 2$  (if only half-areas of sections were

taken) = volume of displacement in cubic feet, which divided by 35 will give the displacement in salt water tons.

To find the fore and aft center of buoyancy use a table as follows:

Station	Planimeter Reading	Simpson's Multipliers	Functions of Areas	Arms	Functions of Moments	Sum of Functions
						Forward
						Aft

$$\frac{\text{difference between sum of functions of moments} \times \text{interval}}{\text{sum of functions of areas}} = \text{distance}$$

center of buoyancy is from the station the moments were taken about. If the after moments are the greatest then the center of buoyancy will be aft of the station taken, and if less then forward of it.

To find the vertical center of buoyancy lay off a table thus:

Water Plane	Reading of Planimeter	Simpson's Multipliers	Functions of Areas	Arms Above Base Line	Functions of Moments
1					
2					
etc.					

$$\frac{\text{sum of functions of moments} \times \text{distance water planes are apart}}{\text{sum of functions of areas}} =$$

distance center of buoyancy is above the base line.

For the metacenters lay off a table as on page 181. To find the transverse metacenter multiply the cubes of the ordinates or half-breadths by Simpson's multipliers as  $\frac{1}{2}$ , 2,  $1\frac{1}{2}$ , 4, etc., writing the products in the column of functions of cubes. Take the sum of this column which is 34488.92 and multiply it by  $\frac{1}{3}$  of the distance the ordinates are apart, which in the present case is 9.5 ft. also by  $\frac{1}{3}$  and by 2 (if half-breadths were taken) giving a product of 69359.21, which is the moment of inertia *I* of the water plane about its fore and aft center line. The distance between the trans-

DISPLACEMENT SHEET

Tow with a bar keel  
Length between perpendiculars, 95 ft.

Beam molded, 24 ft. 6 ins.  
Depth, 12 ft. 6 ins. molded

Ordinate, 9.5 ft. apart  
Water lines, 2 ft. apart.

Number of Or-dinate	Water Lines										Vertical Sections			
	1	2	3	4	5	6	7	8	9	10	Pure-ly Areas	Multi-pliers for Mo-ments	Mo-ments	
1	1/4	2	1 1/4	4	10	10	10	10	10	10	10	10	5	3.00
1 1/4	2	1 1/4	1 1/4	4	10	10	10	10	10	10	10	10	5	158.49
2	1 1/4	1 1/4	1 1/4	4	10	10	10	10	10	10	10	10	4 1/4	249.83
3	1 1/4	1 1/4	1 1/4	4	10	10	10	10	10	10	10	10	4	1088.64
4	1 1/4	1 1/4	1 1/4	4	10	10	10	10	10	10	10	10	3	537.00
5	1 1/4	1 1/4	1 1/4	4	10	10	10	10	10	10	10	10	2	653.32
6	1 1/4	1 1/4	1 1/4	4	10	10	10	10	10	10	10	10	1	2609.97
7	1 1/4	1 1/4	1 1/4	4	10	10	10	10	10	10	10	10	1	647.12
8	1 1/4	1 1/4	1 1/4	4	10	10	10	10	10	10	10	10	1	595.48
9	1 1/4	1 1/4	1 1/4	4	10	10	10	10	10	10	10	10	2	1394.68
10	1 1/4	1 1/4	1 1/4	4	10	10	10	10	10	10	10	10	3	870.08
10 1/4	1 1/4	1 1/4	1 1/4	4	10	10	10	10	10	10	10	10	4	273.96
11	1 1/4	1 1/4	1 1/4	4	10	10	10	10	10	10	10	10	4 1/4	16.60
											3256.	3257.92	2699.97	
											3256.	617.96	9.5 ft.	
											3256.	9416.47	3266.	
											3256.	Center of buoyancy = 1.83 ft. aft of No. 5 ordinate		

Keel	Simpson's Multipliers										Total	
	1	2	3	4	5	6	7	8	9	10		
1	1/4	2	1 1/4	4	10	10	10	10	10	10	10	10
1 1/4	2	1 1/4	1 1/4	4	10	10	10	10	10	10	10	10
2	1 1/4	1 1/4	1 1/4	4	10	10	10	10	10	10	10	10
3	1 1/4	1 1/4	1 1/4	4	10	10	10	10	10	10	10	10
4	1 1/4	1 1/4	1 1/4	4	10	10	10	10	10	10	10	10
5	1 1/4	1 1/4	1 1/4	4	10	10	10	10	10	10	10	10
6	1 1/4	1 1/4	1 1/4	4	10	10	10	10	10	10	10	10
7	1 1/4	1 1/4	1 1/4	4	10	10	10	10	10	10	10	10
8	1 1/4	1 1/4	1 1/4	4	10	10	10	10	10	10	10	10
9	1 1/4	1 1/4	1 1/4	4	10	10	10	10	10	10	10	10
10	1 1/4	1 1/4	1 1/4	4	10	10	10	10	10	10	10	10
10 1/4	1 1/4	1 1/4	1 1/4	4	10	10	10	10	10	10	10	10
11	1 1/4	1 1/4	1 1/4	4	10	10	10	10	10	10	10	10
											371.04	389.12
											1094.36	389.12
											4337.44	1446.00

2200 cu. ft. (3 1/4 x 2 ft.) x 6 1/2 ft. x 2 = 15745 cu. ft. As 25 cu. ft. of salt

water weighs one ton (2240 lb.) then 15745 / 25 = 620 tons, thus giving the displacement of the vessel.

$$9416.47 \times 2 \text{ ft.} = \frac{18832.94}{3256} = 5.78 \text{ ft. center of buoyancy above the base.}$$

# METACENTERS

Number of Ordinates	Simpson's Multipliers	TRANSVERSE		LONGITUDINAL			Functions for Moment of Inertia of Water Plane			
		Ordinates or Half Breadths of Water Line	Cubes of Ordinates	Functions of Cubes	Functions of Ordinates	Multiplier		Center of Gravity of Water Plane		
1	1/4	10	.001	.0009	.06	5	.25	5	1.25	
1 1/2	2 1/4	2.48	15.25	30.50	4.96	4 1/2	22.32	4 1/2	100.44	
2	1 1/2	4.80	114.79	172.18	7.29	4	20.16	4	118.64	
3	4	8.75	669.92	2679.68	35.00	3	108.00	3	315.00	
4	2	11.16	1389.86	2779.72	22.32	2	44.64	2	89.28	
5	4	12.12	1780.31	7121.24	48.48	1	48.48	1	48.48	
6	2	12.25	1838.24	3676.48	24.50	0	249.85	0		
7	4	12.25	1838.24	7352.96	49.00	1	49.00	1	49.00	
8	2	11.92	1693.67	3387.34	23.84	2	47.68	2	95.36	
9	4	11.12	1374.99	5499.96	44.48	3	133.44	3	400.32	
10	1 1/2	9.10	753.57	1130.35	13.65	4	54.60	4	218.40	
10 1/2	2	6.80	314.43	628.86	13.60	4 1/2	61.20	4 1/2	276.40	
11	1 1/2	3.90	59.31	29.65	1.95	5	9.75	5	48.75	
				34488.92			289.12		355.67	1758.32

$$34488.92 \times \frac{9.5}{3} \times \frac{1}{3} \times 2 \text{ [half-breadths taken hence multiply by 2]}$$

$$= 69359.21 = I$$

The distance between the transverse center of buoyancy and transverse metacenter =  $\frac{I}{V} = \frac{69359.21}{18748} = 5.04 \text{ ft.}$

$$v = \frac{105.82 \times 9.5}{289.12} = 3.47 \text{ ft. } C.G \text{ aft of No. 6.}$$

V = volume of displacement = 13748 cu. ft.

$$I = 1758.3 \times \frac{2}{3} \times 9.5^2.$$

$$Ay^2 = (289.12 \times \frac{2}{3} \times 9.5) \left( \frac{105.82 \times 9.5^2}{289.12} \right)$$

$$I_0 = I - Ay^2 = 1758.3 \times \frac{2}{3} \times 9.5^2 - (289.12 \times \frac{2}{3} \times 9.5)$$

$$\left( \frac{105.82 \times 9.5^2}{289.12} \right) = 982923$$

$$B M = \frac{I_0}{V} = \frac{982923}{13748} = 64.2 \text{ ft., the distance the longitudinal meta-}$$

center is above the center of buoyancy.

verse center of buoyancy and transverse metacenter  $BM$  is given by the formula  $BM = \frac{I}{V}$ ,  $I$  being the moment of inertia of the water plane as just found and  $V$  the volume of the displacement in cubic feet. Thus  $BM = \frac{I}{V} = \frac{69359.21}{13748} = 5.04$  ft.

To find the longitudinal metacenter multiply the functions of ordinates by the arms or levers there are from the midship ordinate, writing the product in the column Functions for Center of Gravity of Water Plane. Add up the forward and after functions, and as the after in the present vessel is the largest, subtract the forward from it, giving a remainder of 105.82. Multiply 105.82 by the distance the ordinates are apart, viz.: 9.5 ft., and divide the product by the sum of the functions of ordinates 289.12, the quotient being the distance the center of gravity of the water plane is aft of No. 6 ordinate.

Multiply the functions for the center of gravity of the water plane by the arms 5,  $4\frac{1}{2}$ , 4, etc., writing the products in the column of functions for moment of inertia, the sum of the products being 1758.32.

As the longitudinal metacenter is to be referred to the center of gravity of the load water plane, a correction is necessary to the sum of the functions for moment of inertia, viz., 1758.32.

Let  $I$  = moment of inertia about the middle ordinate

$y$  = distance the center of gravity is from the middle ordinate

$A$  = sum of the functions of ordinates  $\times \frac{3}{8}$  distance ordinates are apart

Then the new moment of inertia  $I_0$  around the center of gravity of the water plane is given by the expression  $I_0 = I - Ay^2$

By referring to page 181 the various calculations are shown, giving a value of  $I_0$  as 982923. Hence if  $BM$  is the distance between the longitudinal center of buoyancy and the longitudinal metacenter,  $I_0$  the moment of inertia as just found and  $V$  the volume of the displacement in cubic feet, then  $BM = \frac{I_0}{V}$  and sub-

stituting in this formula the values previously found  $\frac{982923}{13748}$  then the quotient is 64.2 ft., which is the longitudinal metacentric height.

**Curves of Stability.\***—These are obtained by calculating and then plotting the length of the righting arm or lever at different angles of inclination of the vessel and drawing a curve through the points found. For these calculations there must be known: (1) the position of the center of buoyancy in the upright position; (2) the position of the center of gravity of the vessel; (3) the volume of the displacement; and (4) the value of the moment of transference of the immersed and emerged wedges parallel to the new water line.

The resulting curves (see Fig. 22) are important and are often given to the captain so he will know the condition of his vessel under various loadings. (See Loading of Cargoes.) The minimum value of the distance between the center of gravity and metacenter ( $G M$ ) in steamers of medium size is about one foot when loaded with a homogeneous cargo that brings them to the load water line. For small cargo vessels the distance between the center of gravity and the metacenter should not be less than 9 ins. provided a righting arm of like amount is obtained at  $30^\circ$  to  $40^\circ$ . For sailing vessels a higher value of  $G M$  is required, the minimum being 3 ft. to 3 ft. 6 ins. with a homogeneous cargo.

Referring to Fig. 22, the righting levers are given vertically and the angles of inclination of the ship given horizontally in degrees. The important features in the curves are: the inclination of the curve to the base line at its origin, the angle at which the maximum inclination occurs, and the length of the righting lever at this angle.

Increasing the beam of a vessel increases the initial stability but does not greatly influence the area inclosed by the curve of stability or its range.

Increasing the freeboard has no effect on the initial stability (supposing the increase of freeboard does not affect the position of the center of gravity), but it has a most important effect in lengthening out the curve and increasing its area.

In the table in Fig. 22 various conditions of loading a steamer 391 ft. 6 ins. long, 51 ft. 6 ins. beam, and 29 ft. 3 ins. deep are given.

(1) In Curve A, the ship is light, water in boilers, but no cargo, bunker coal, stores or fresh water on board, and all ballast tanks empty.

(2) B same as (1), but with bunker coal, stores and fresh water on board.

(3) C ready for sea, water in boilers, bunker coal, stores and fresh water aboard, and the holds and 'tween-decks filled with a

\* From Ship Cons. and Calculations, G. Nicol.

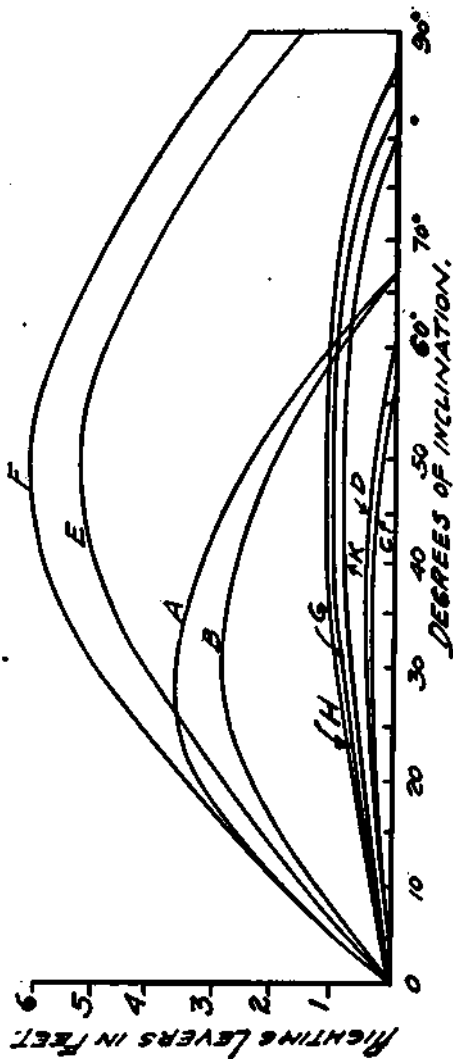

Figure 22

Steamer 395.5 ft. between perpendiculars, 51.5 ft. beam, 29.25 ft. deep.

Curve	Water Ballast (tons)	Cargo (tons)	Punker Coal Stores and Fresh Water (tons)	Displacement (tons)	Mean Draft (ft.) (ins.)	Metacenter Height (ft.)	Maximum Righting Lever (ft.)	Angle of Maximum Righting Lever (degrees)	Height of Center of Gravity Above Base (ft.)
A.....	.....	.....	.....	3150	7 10	10.59	3.57	29	21.11
B.....	.....	.....	592	3742	9 2	7.22	2.85	29	21.34
C.....	.....	7085	592	10827	23 11	.66	.26	31	20.25
D.....	.....	7085	.....	10235	22 9	.75	.34	37	20.12
E.....	1362	.....	592	5104	12 0	7.57	5.32	49	18.60
F.....	1362	.....	.....	4512	10 9	9.93	6.10	49	18.82
G.....	.....	7085	592	10827	23 11	1.90	1.10	52	19.01
H.....	.....	7085	.....	10827	22 9	2.07	1.22	49	18.80

homogeneous cargo of such a density as to bring the steamer to her summer load line.

(4) D same as (3), with bunker coal, stores and fresh water consumed, approximating to the end of the voyage.

(5) E ready for sea, water in boilers, bunker coal, stores and fresh water aboard, and all ballast tanks filled.

(6) F same as (5), but with bunker coal, stores and fresh water consumed.

(7) G same as (3), but loaded with a coal cargo, part of the 'tween-decks empty.

(8) H same as (7), but with bunker coal, stores and fresh water consumed.

**Cross Curves of Stability.\***—These are calculated for two or three conditions as, when the vessel is light, loaded, and loaded with the bunkers empty. Select angles of inclination as  $15^\circ$ ,  $30^\circ$ ,  $50^\circ$ ,  $70^\circ$  and  $90^\circ$ . Prepare body plans for the fore body (see Fig. 23) and after body, and draw on them the load water line and the inclined angles. Make the calculation first for the loaded condition.

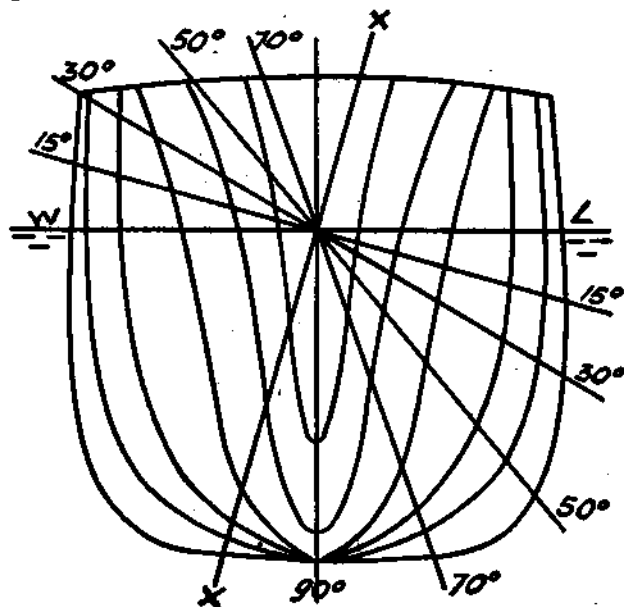

Figure 23

\* From A class book on Naval Architecture, W. J. Lovett.



Find the area of each section of immersion and emersion at the assumed inclination, by a planimeter preferably, altho these can be found by Simpson's rules. Mark the center of gravity of each section. Draw a line  $XX$  perpendicular to the inclined water plane. This is the line about which the moments of the wedges are taken. Prepare a table as follows for the submerged wedge.

Ordinates	Areas	Simpson's Multipliers	Products	Levers About $XX$	Moments
1		1			
2		4			
3		2			
4		4			
5		2			
etc.		etc.			
			$S$		$M$

$$\text{Distance of center of gravity of wedge from } XX = \frac{M}{S}$$

Also find volume of wedge by multiplying  $S$  by  $\frac{1}{3}$  common interval. Repeat this calculation for the emerged wedge. Lay out a table thus:

	Volume	Levers About $XX$	Moments
Submerged wedge . . . . .			
Emerged wedge . . . . .			
	$S_1$		$M$

$S_1$  is the difference between the volumes of the submerged and emerged wedges. Make a correction for the difference, laying out a table thus:

Ordinates	Submerged	Emerged	Total	Simpson's Multipliers	Products	Leverage		Moments	
						Submerged	Emerged	Submerged	Emerged
1			1						
2			4						
3			2						
etc.			etc.						
					$S$			$+ S$ $- E$ <hr/> $\frac{S}{G}$	$E$

The leverage is half the difference of the two ordinates.

$$\frac{\text{Total moment } M \pm S_1 \times G}{\text{Total volume of displacement}} = B R$$

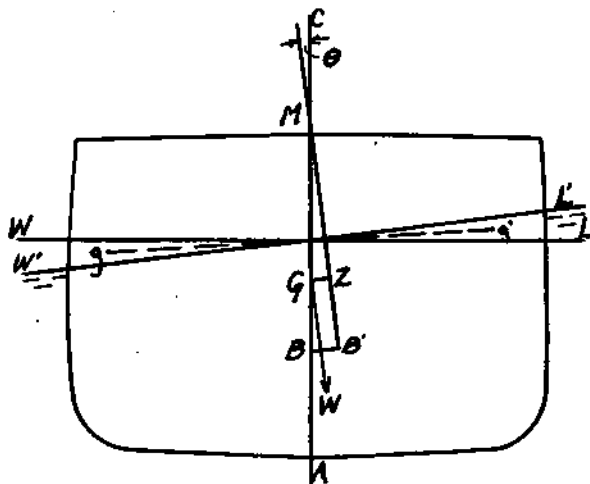

Figure 24

In  $S_1 \times G$  note if the greater volume is on the emerged side and the center of gravity of it on the emerged side, then the moment obtained has to be deducted from the total moment. If the greater volume is on the submerged side and its center of gravity on the submerged side the moment has to be added to the total moment.

$$GZ = BR - BG \sin \theta$$

$$\sin \theta = \frac{BR}{BM}$$

Proceed to find  $BR$  in the same manner for  $30^\circ$ ,  $50^\circ$ ,  $70^\circ$  and  $90^\circ$ . Also find  $BR$  for other drafts for all the angles of inclination. When this is done the cross curves of stability may be constructed, by setting up at the different drafts the  $GZ$  found for the different inclinations. Run lines through each series of spots and these lines are the cross curves of stability. See Fig. 25.

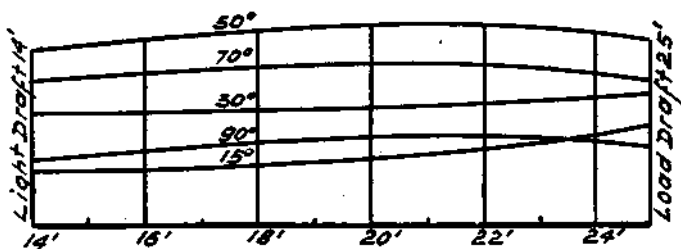

Figure 25

To construct stability curves (Fig. 26) lay off the inclinations  $15^\circ$ ,  $30^\circ$ , etc., horizontally and vertically the values of  $GZ$  as previously found. Draw curves through the points thus laid off.

The cross curves show constant inclination at varying displacements. The stability curves show constant displacement at varying inclinations. The cross curves show the value of the righting arm  $GZ$ . A curve of righting moments could also be made showing the foot-tons (the value of  $W$  [displacement]  $\times GZ$ ). In preparing the body plan the sections are drawn to the uppermost continuous deck. If a watertight poop, bridge or forecastle become immersed at the higher angles of inclination, the value of their buoyancy should be calculated.

As the above curves have been considered with the vessel stationary, they are called static curves.

**Notes on Stability.**—For ordinary vessels the transverse meta-center remains practically unchanged up to 10° inclination. The value of  $GM$  should not be less than 10 ins. and have a righting arm of at least 10 ins. at 45°.

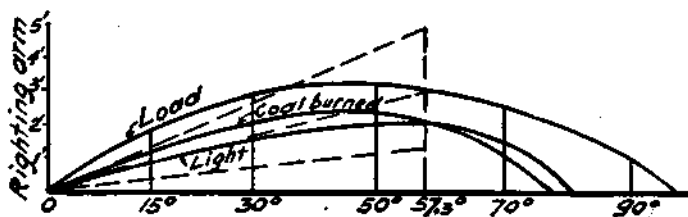

Figure 26

An ordinary seagoing ship should have a range of stability of 70°. Stability varies as the square of the breadth and inversely as the draft. A 300-foot steamer when loaded had a maximum righting lever of 8 ins., while a similar one under similar conditions but 2 ft. broader had a maximum righting lever of 12 ins. Freeboard is an important factor in stability, as the stability immediately begins to decrease when the edge of the deck gets under water, so that every additional inch of freeboard increases the vessel's range.

#### Approximate Formula for Calculating Stability ( $GZ$ ).

Let  $\theta$  = angle the vessel is inclined, that is, the angle between normal water line and the inclined

$GM$  = distance between the center of gravity and the metacenter

$BM$  = distance the metacenter is above the center of buoyancy.

$GZ$  = righting arm

Then

$$GZ = GM \sin \theta + \frac{BM}{2} \tan^2 \theta \sin \theta$$

Up to an angle of 30°, provided the ratio of the beam to the draft is not abnormally great, the above formulæ may be used instead of the long stability calculations. The values at inclinations of

$10^\circ$ ,  $15^\circ$  and  $20^\circ$  are practically the same as obtained with the usual stability calculations.

**Trim** is the difference between the forward and aft draft of a vessel. Thus, suppose a vessel draws 12 ft. forward and 15 ft. aft; then she is said to trim 3 ft. by the stern.

**Longitudinal Metacenter.**—Let  $B$  (see Fig. 27) be the center of buoyancy when floating on an even keel,  $W L$ , and suppose the trim of the vessel to change, the displacement being the same, then  $B_1$  is the new center of buoyancy. Draw  $B_1 M$  a vertical line meeting  $B M$  at  $M$ . Then  $M$  is the longitudinal metacenter, and the distance  $G M$  the longitudinal metacentric height.

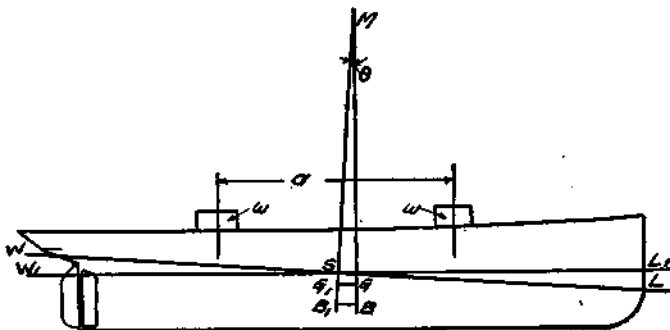

Figure 27

**Moment to Alter Trim One Inch.**—Suppose a weight  $w$  is moved from  $w$  to  $w$ , then the change of trim =  $W W_1 + L L_1 = (W_1 S + S L_1) \times \tan \theta =$  length of load water line  $\times \tan \theta$ .

The movement of the weight  $w$  causes the center of gravity of the vessel to move aft a distance  $G_1 G$ . Let  $W =$  the displacement in tons,  $a =$  the distance the weight  $w$  is moved, then

$$G_1 G = G M \times \tan \theta = \frac{w \times a}{W} \quad \text{and} \quad \tan \theta = \frac{w \times a}{W \times G M} =$$

$$\frac{\text{change of trim}}{\text{length of load water line}}$$

$$\text{Change of trim in feet} = \text{length of load water line } (L) \times \tan \theta =$$

$$\frac{L \times w \times a}{W \times G M}$$

To get the moment to alter trim one inch substitute in  $\frac{w \times a}{W \times GM}$

$$= \frac{\text{change of trim}}{\text{length of load line}}, \text{ one inch or } \frac{1}{12} \text{ foot, thus } \frac{w \times a}{W \times GM} = \frac{1}{12}$$

Therefore the moment to alter trim one inch =  $w \times a = \frac{W \times GM \times \frac{1}{12}}{L}$

$$= \frac{W \times GM}{L \times 12} \text{ foot-tons.}$$

*Example.* A 350-ft. steamer, displacement 6700 tons at her designed draft, has a longitudinal metacentric height of 350 ft. If 10 tons of cargo in her forward hold was moved 100 ft. aft, find the change in trim.

$$\text{Moment to change trim one inch} = \frac{W \times GM}{L \times 12} = \frac{6700 \times 350}{350 \times 12} = 55.8 \text{ foot-tons.}$$

$$\text{Moment aft from shifting cargo} = 10 \text{ tons} \times 100 \text{ ft.} = 1000 \text{ foot-tons.}$$

$$\text{Hence change of trim aft} = \frac{1000}{55.8} = 17.9 \text{ ins.}$$

**Approximate Calculations for Trim.**—In the formula, moment to alter trim one inch =  $\frac{W \times GM}{L \times 12}$  foot-tons, if  $GM$  is assumed to be equal to  $L$  the length of the ship, which is roughly true in the case of ordinary cargo vessels at their load displacements, the trimming moment per inch becomes  $\frac{W}{12}$  foot-tons.

Another approximate formula giving closer results than the above is the following:

$T$  = tons per inch of immersion

$A$  = area of load water plane in square feet

$L$  = length on the load water line in feet

$B$  = breadth of ship amidships in feet

$V$  = volume of displacement in cubic feet

$W$  = displacement in tons

The height of the longitudinal metacenter above the center of buoyancy in ordinary cargo steamers is  $BM = .0735 \frac{A^2 \times L}{B \times V}$

assuming  $BM = GM$ , and as  $W = \frac{\text{vol. of displacement}}{35} = \frac{V}{35}$

Then the moment to alter trim one inch =  $\frac{W \times GM}{L \times 12} =$   
 $\frac{V}{35} \times .0735 \frac{A^2 \times L}{B \times V} = .000175 \frac{A^2}{B}$  foot-tons, or  $\frac{30.9 \times T^2}{B}$  foot-tons.

Another formula for the moment to alter trim one inch is

$$\frac{\text{length on water line} \times \text{displacement}}{n \times \text{draft}}$$

where  $n$  for fine vessels = 190

where  $n$  for ordinary = 180

where  $n$  for cargo = 172

To Estimate the Displacement of a Vessel when Floating Out of Her Designed Trim.

$T$  = tons per inch of immersion

$y$  = center of flotation aft of amidships in feet

$L$  = length of vessel in feet

Then the extra displacement for one foot of extra trim =  
 $12 \frac{T \times y}{L}$

*Example.* A steamer 350 ft. long, draws 17 ft. forward and 24 ft. 3 ins. aft, thus trimming 7 ft. 3 ins. by the stern. When loaded she trims 5 ft. by the stern. If the center of flotation is 14 ft. aft amidships, and the tons per inch of immersion 35, what is the steamer's displacement?

At a draft of 20 ft. 1½ ins.  $\left(\frac{17 \text{ ft.} + 24 \text{ ft. } 3 \text{ ins.}}{2}\right)$  her displacement from the displacement curve is 5850 tons.

The displacement for one foot of extra trim =  $\frac{12 \times 35 \times 14}{350} = 16.8$  tons, and for 2 ft. 3 ins. extra trim = 37.8 tons.

Thus new displacement = 5850 + 37.8 = 5887.8 tons.

To Find the Distance the Longitudinal Metacenter is Above the Center of Buoyancy.

Let  $V$  = volume of displacement in cubic feet

$I_o$  = moment of inertia of water plane about a transverse axis passing through the center of flotation.

Then the longitudinal metacentric height  $BM = \frac{I_o}{V}$ . See Metacenters, page 186.

To Find the Trim Corresponding to any Mean Draft and Longitudinal Position of the Center of Gravity by Trim Lines or Curves.\*—See Fig. 28. Draw a line  $WL$  to represent the mean draft for

\* From Ship Calculations and Cons., G. Nicol.

which the trim line is required. On this line a point  $B$  is taken as the longitudinal position of the center of buoyancy at a level keel, and a line  $NN$  is drawn representing the midship line of the vessel. Thus the distance  $BN$  represents the distance the center of buoyancy is from amidships, which in the present case is forward of it.

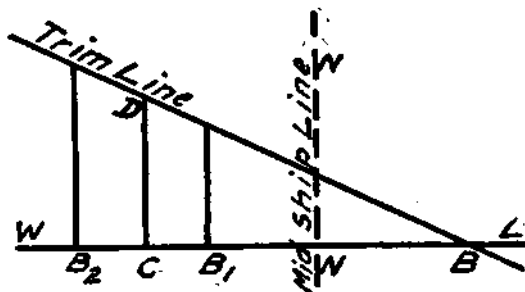

Figure 28

The horizontal distance from  $B$  of the center of buoyancy of the vessel trimming 2 ft. by the stern is calculated as follows:

Change of trim = length of water line  $\times \tan \theta$  (for  $\theta$  see Fig. 27)

$$\tan \theta = \frac{\text{change of trim}}{\text{length of water line}}$$

Now  $GG_1$  equals nearly  $BB_1$ , or the distance between the centers of buoyancy before and after the trim has been changed, so  $GG_1 = BB_1 = GM \times \tan \theta$ .

$GM$  is approximately equal to the length of the ship  $L$  on the water line, then substituting  $GM = L$  and  $\tan \theta = \frac{\text{change of trim}}{L}$

$$GG_1 = BB_1 = GM \times \tan \theta = L \times \frac{\text{change of trim}}{L} = L \times \frac{2 \text{ ft.}}{L}$$

and in the present case this distance is set off from  $B$ .

Next calculate the position of the center of buoyancy with the vessel trimming 4 ft. by the stern, the same method as just outlined being used, and lay off this distance as  $BB_2$ .

At  $B_1$  and  $B_2$  verticals are erected, and the corresponding trims (2 ft. and 4 ft.) laid off, the same scale being used. Through the points thus found and the point  $B$  a line is drawn, which is the trim line required.



For forward trims the trim line should be continued below its level line to indicate the movement of the center of buoyancy in that direction. It should be noted that the center of gravity and center of buoyancy are here assumed to travel the same distance when a change of trim takes place. This is not quite true as  $B$  is below  $G$  and therefore more remote from  $M$ , and moves a greater distance. For very accurate work the distance plotted from  $B$  towards  $W$  should be the calculated travel of the center of gravity plus  $BG \times \tan \theta$ . It is not necessary to proceed to this refinement in ordinary cases, as the error involved is not worth considering.

From the trim line just drawn can be determined any trim up to 4 ft. (other trims, as 6 ft., 8 ft., etc., could be plotted if desired), due to the movement of weights on board. For if the distance the center of gravity travels aft on account of the movement of the weights be ascertained and plotted from  $B$  along the level line  $C$ , and a vertical line be erected to intercept the trim line at  $D$ ,  $CD$  must be the trim by the stern, as the center of buoyancy and center of gravity are always in the same vertical line.

A trim line is only reliable at its own draft, and when the change of displacement is considerable a new curve is required. For ordinary purposes three conditions are sufficient, viz., load, ballast, and light.

**Effect of Flooding a Damaged Compartment.**—To find the effect of a compartment being thrown open to the sea by collision or other accident, account must be taken not only of the water that would enter if the ship remained in her original position, but also of the additional water which will enter due to the heel, change of trim, and sinkage caused by such flooding.

When the compartment is wholly under water, and the water is prevented from spreading by a watertight deck or inner bottom the effect is the same as of adding a weight in a known position.

**To Find the Trim when a Compartment is Flooded.**—The weight of the water in the compartment up to the original water line should be found and the parallel sinkage determined assuming the compartment open to the sea and the admitted water placed with its center of gravity in the vertical plane containing the center of gravity of the added layer of displacement. This distance measured in the trim diagram above the height of the original water plane, will give the point from which the level line and corresponding trim line should be drawn. The trim can then be obtained (as described in the paragraph on Trim Lines) by finding the travel aft of the

center of gravity, assuming the weight to be translated to its true position.

It will next be necessary to calculate the weight of water in the compartment, assuming the surface to rise to the level of the new draft, and to use it in the same way in another trim estimate. If this should differ much from the first calculation, it may be necessary to proceed to a third.

Or instead of the above, which is the trim line method, first determine the amount of mean sinkage due to the loss of buoyancy, and second, determine the change of trim caused.

#### Quantity of Water That Will Flow into a Ship Through a Hole in Her Side.

Let  $H$  = distance center of the hole is below the water line in feet

$A$  = area of hole in square feet

$g$  = acceleration due to gravity (32.16)

$V$  = rate of flow in feet per second

$$\text{Then } V = \sqrt{2gH} = 8\sqrt{H} \text{ approximately}$$

The volume in cubic feet of water passing through the hole per second =  $8\sqrt{H} \times A$

*Example.* A hole having an area of 2 sq. ft., 4 ft. below the water line was made in the side of a ship. What would be the approximate tons of water that would flow into her per minute?

$$\text{Cubic feet per second} = 8\sqrt{H} \times A = 8\sqrt{4} \times 2 = 32.$$

$$\text{Cubic feet per minute} = 32 \times 60 = 1920.$$

$$\text{Tons per minute} = \frac{1920}{35} = 54.85 \text{ tons.}$$

Calculating the Trim by the Trim Line Method when a Compartment is Flooded.\*—Assume a box-shaped vessel 210 ft. long, 30 ft. beam, and 20 ft. deep, drawing 10 ft. forward and aft. Suppose she is in collision and a compartment at the after end is flooded. Find the draft. (See Fig. 29.)

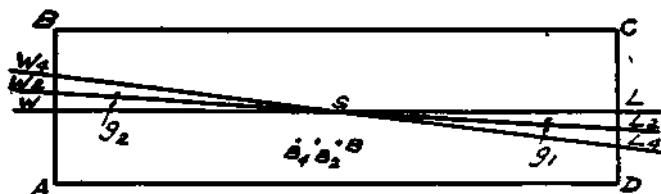

Figure 29

\* From Ship Calculations and Cons., G. Nicol.

Using the trim line method, first obtain the trim line at 10 ft. draft.  $WL$  is the level water line,  $W_2L_2$  and  $W_4L_4$  those when at 2 ft. and 4 ft. by the stern.

Assuming the vessel to be floating in salt water, her displacement is  $\frac{210 \times 30 \times 10}{35} = 1800$  tons, and in passing from the  $WL$  to

$W_2L_2$ , the wedge of displacement  $LSL_2$  moves to the position  $WSW_2$ . As  $SL$  is half the vessel's length, and  $L_2L_2$  one foot, the

volume of the wedge is  $\frac{105 \times 1 \times 30}{2} = 1575$  cu. ft., and in moving

aft its center of gravity travels a horizontal distance  $g_1g_2$  or

$$\frac{105 \times 2^*}{3} + \frac{105 \times 2}{3} = 140 \text{ ft.}$$

The corresponding movement of the vessel's center of buoyancy is from  $B$  to  $B_2$ , then  $BB_2 = GM \times \tan \theta$

$$\tan \theta = \frac{w \times a}{W \times GM} = \frac{\frac{1575}{35} \times 140}{1800 \times 140} = \frac{1575}{1800 \times 35}$$

$$\text{and } BB_2 = \frac{1575 \times 140}{1800 \times 35} = 3.5 \text{ ft.}$$

That is the horizontal travel of the center of buoyancy with the vessel trimming 2 ft. by the stern is 3.5 ft. With the vessel 4 ft. by the stern, the horizontal travel is double 3.5 ft. or 7 ft.

From the above, a trim line can be drawn for the initial draft. Trim lines corresponding to other displacements can be obtained in the same manner. Fig. 30 is the complete diagram for the vessel and shows cross curves with a range of from 7 ft. 6 ins. to 15 ft. draft.

Next begin with the calculation for the bilging.

Weight of water in bilged compartment =  $\frac{10 \times 10 \times 30}{35} = 85.71$  tons,

Parallel sinkage assuming water situated amidships and compartment open to sea =  $\frac{85.71 \times 35 \times 12}{\dagger 200 \times 30} = 6$  ins.

Horizontal travel aft of vessel's center of gravity, assuming the

\* Center of gravity of a wedge is  $\frac{2}{3}$  from the apex.

† The length of the water line, instead of being 210 ft., is now 200 ft., as the compartment flooded is 10 ft. long.

water at the increased draft to move into its true position and the ship's bottom to be intact:

$$w = \frac{\text{new draft of } 10' 6'' \times 10' \text{ length} \times 30' \text{ beam}}{35} = 90 \text{ tons}$$

$$a = \frac{210' - 10' \text{ (length of compartment)}}{2} = 100 \text{ ft.}$$

$W$  = original displacement of 1800 tons + 90 tons = 1890 tons.

$$GG_1 = \frac{w \times a}{W} = \frac{90 \times 100}{1890} = 4.76 \text{ ft.}$$

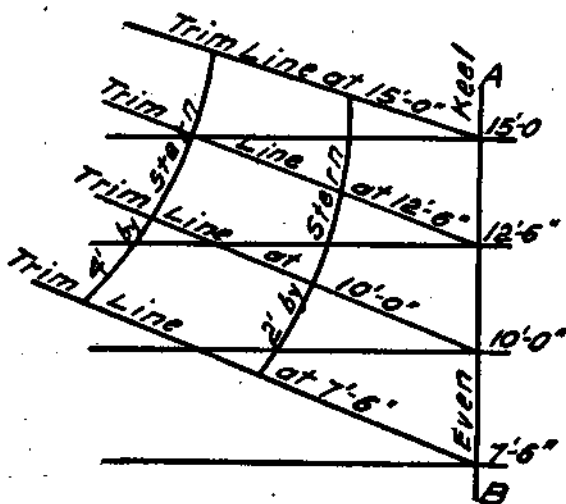

Figure 30

Referring to Fig. 30 the trim line corresponding to a level line at 10 ft. 6 ins. can be drawn, and by measuring 4.76 ft. along this line from  $AB$ , and erecting a perpendicular and scaling it, its length 2 ft. 10 $\frac{1}{4}$  ins. is the trim by the stern. The drafts will be

$$\text{Forward} = 10' 0'' + \text{parallel sinkage of } 6'' - \frac{1}{2} (2' 10\frac{1}{4}'') = 9' 0\frac{3}{8}''$$

$$\text{Aft} = 10' 0'' + \text{parallel sinkage of } 6'' + \frac{1}{2} (2' 10\frac{1}{4}'') = 11' 11\frac{1}{8}''$$

In the second approximation, start with the vessel in the above

trim. The weight of the water in the bilged compartment will be

$$\frac{11.86 \times 10 \times 30}{35} = 101.66 \text{ tons.}$$

$$\text{Parallel sinkage} = \frac{101.66 \text{ tons} \times 35 \text{ cu. ft.} \times 12 \text{ ins.}}{210 \text{ ft.} \times 30 \text{ ft.}} = 6\frac{3}{4} \text{ ins.}$$

nearly.

Taking the center of gravity of the water line at the middle of the length of the compartment, then the travel of the vessel's center

$$\text{of gravity due to admission of water} = \frac{w \times a}{W} = \frac{101.66 \times \frac{200}{2}}{1800 + 101.66} =$$

5.35 ft. aft. By laying this off on the trim diagram, on the water line, and scaling up to the trim line, the trim will be found to be 3 ft.  $2\frac{3}{4}$  ins. by the stern.

Dividing this equally forward and aft, and adding  $6\frac{3}{4}$  ins. as the parallel sinkage, the drafts become

$$\begin{aligned} \text{Forward} & 10' 0'' + 6\frac{3}{4}'' - 1' 7\frac{3}{8}'' = 8' 11\frac{3}{8}'' \\ \text{Aft} & 10' 0'' + 6\frac{3}{4}'' + 1' 7\frac{3}{8}'' = 12' 2\frac{1}{8}'' \end{aligned}$$

**Calculating the Trim by Mean Sinkage when a Compartment is Flooded.\***—A rectangular lighter 100 ft. long, 40 ft. beam, 10 ft. deep, floating in salt water at 3 ft. draft, has a collision bulkhead 6 ft. from the forward end. If the compartment forward of this bulkhead is flooded, what would be the trim in the damaged position? (See Fig. 31.)

(1) Determine the amount of mean sinkage due to the loss of buoyancy.

(2) Determine the change of trim caused.

(1) The lighter, due to the damage, loses an amount of buoyancy represented by the shaded part  $GB$ , and if it is assumed the lighter sinks down parallel, she will settle down at a water line  $wl$  such that volume  $wG$  = volume  $GB$ . This will determine the distance  $x$  between  $wl$  and  $WL$ .  $GL$  = 6 ft.,  $wH$  = 94 ft.

$$\text{For the volume } wG = wH \times 40 \text{ ft.} \times x$$

$$\text{For the volume } GB = GL \times 40 \text{ ft.} \times 3 \text{ ft.}$$

$$x = \frac{GL \times 40 \times 3}{wH \times 40} = \frac{18}{94} \text{ ft. or } 2\frac{1}{4} \text{ ins.}$$

(2) Change of trim.

\* From Theo. Naval Architecture, L. T. Attwood.

Volume of displacement in cubic feet =  $100 \times 40 \times 3$

Displacement =  $\frac{100 \times 40 \times 3}{35} = \frac{2400}{7} = 342$  tons, and this

weight acts through  $G$ , the center of gravity, which is 50 ft. from either end.

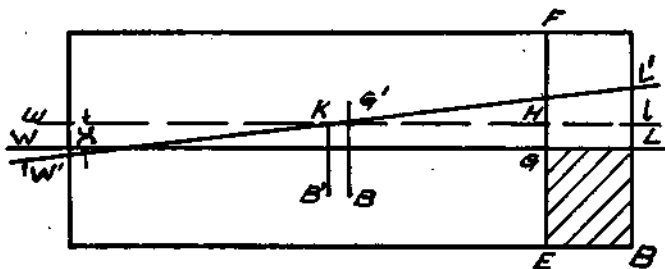

Figure 31

But there has been lost the buoyancy due to the part forward of the bulkhead  $EF$ , and the center of buoyancy has now shifted back to  $B'$  such that the distance of  $B'$  from the after end is 47 ft.

Therefore  $W$ , the weight of the lighter, acts down through  $G$  and  $W$  the upward force of buoyancy acting through  $B'$ , forming a couple of  $W \times 3$  ft. =  $\frac{2400}{7} \times 3 = \frac{7200}{7} = 1028$  foot-tons, tending to trim the lighter.

To find the amount of this trim, the moment to change trim one inch must be found by the formula.

Now  $GM$  equals  $BM$  nearly, therefore the moment to change trim one inch =  $\frac{342}{100 \times 12} \times BM = \frac{2}{7} \times BM$ .

Let  $I$  = the moment of inertia of the intact water plane about a transverse axis through its center of gravity.

$V$  = volume of displacement in cubic feet = 12000

$$I = \frac{1}{12} (94 \times 40) \times 94^3$$

$$BM = \frac{I}{V} = \frac{40 \times 94^3}{12 \times 12000} =$$

Moment to alter trim one inch =  $\frac{2 \times 40 \times 94^3}{7 \times 12 \times 12000} = 66$  foot-tons nearly.

$$\text{Therefore change of trim} = \frac{7200}{\frac{7}{66}} = \frac{1028}{66} = 15\frac{1}{2} \text{ ins.}$$

The new water line  $W^1 L^1$  will pass through the center of gravity of the water line  $wl$  at  $K$ , and the change of trim aft and forward must be in the ratio 47:53,

$$\text{Decrease of draft aft} = \frac{47}{100} \times 15\frac{1}{2} = 7\frac{1}{4} \text{ ins.}$$

$$\text{Increase of draft forward} = \frac{53}{100} \times 15\frac{1}{2} = 8\frac{1}{4} \text{ ins.}$$

$$\text{New draft aft} = 3 \text{ ft.} + 2\frac{1}{4} \text{ ins. [from (1)]} - 7\frac{1}{4} \text{ ins.} = 2 \text{ ft. 7 ins.}$$

$$\text{New draft forward} = 3 \text{ ft.} + 2\frac{1}{4} \text{ ins. [from (1)]} + 8\frac{1}{4} \text{ ins.} = 3 \text{ ft. } 10\frac{1}{2} \text{ ins.}$$

### CENTER OF GRAVITY.

Coincident with the calculations of the displacement and centers of buoyancy, are made calculations of the fore and aft, and vertical positions of the common center of gravity of the hull, machinery and cargo. The fore and aft position of the center of gravity of all the weights must come over the fore and aft position of the center of buoyancy. If on the first estimate it does not, then the weights must be shifted until it does.

On a profile of the vessel draw a vertical line midway between the forward and aft perpendiculars. Also draw a base line parallel to the water line, for getting the vertical distance of the center of gravity. Except when the keel is given a drag, the base line is taken as the molded line of the frames at the keel.

To find the fore and aft position of the center of gravity of the hull, lay off a table as follows:

Items	Weights	Dist. Cent. of Grav. from Amidships		Moments	
		Aft	Forward	Aft	Forward
Shell plating . . . .					
Bulkheads . . . . .					
Deck plating . . . .					
&c.					
	<i>W</i>			<i>M aft</i>	<i>M forward</i>

Assuming the moments aft to be greater than those forward then  

$$\frac{\text{moments aft} - \text{moments forward}}{W} = \text{distance center of gravity is aft of amidships.}$$

To find vertical position of center of gravity of the hull, lay off a table thus:

Items	Weight	Dist. Cent. of Grav. from Base	Moment
Shell plating.....			
Bulkheads.....			
Deck plating.....			
Web frames.....			
&c.			
	<i>W</i>		<i>M</i>

The sum of the moments divided by the sum of the weights gives the distance the center of gravity is above the base.

To find fore and aft position of the center of gravity of a ship, rule a table as below:

Items	Weights	Dist. Cent. of Grav. from Amidships		Moments	
		Aft	Forward	Aft	Forward
Hull.....					
Boilers.....					
Engines.....					
Cargo in forward hold...					
Cargo in aft hold.....					
Stores forward.....					
Stores aft.....					
Bunkers.....					
Water ballast forward...					
Water ballast aft.....					
Fresh water.....					
&c.					
	<i>W</i>		<i>M aft</i>	<i>M for'd</i>	



Assuming the moments aft to be greater than those forward then  

$$\frac{\text{moments aft} - \text{moments forward}}{W} = \text{distance of center of gravity}$$
 aft of midships.

To find vertical position of the center of gravity of a ship, lay off the following table:

Item	Weight	Dist. Cent. of Grav. Above Base	Moment
Hull.....			
Boilers.....			
Engines.....			
Cargo in forward hold.....			
Cargo in aft hold.....			
&c.			
	<i>W</i>		<i>M</i>

The sum of the moments *M* divided by the sum of the weights *W* will give the distance the center of gravity is above the base.

Care must be exercised in locating the engines, boilers, cargo, tanks and other weights in a ship. If they are placed too high, the ship will be unstable and if too low she will be very uncomfortable in a seaway, owing to too quick a return to the vertical position.

The table below gives the heights of the center of gravity of ordinary passenger and freight steamers, and of freight steamers.

Length	Breadth	Depth Molded	Center of Gravity Above Base		Metacenter Above Base
			Machinery	Equipped Vessel	
150'	30'	15'	10' 6"	11' 6"	25' 0"
200'	35'	20'	11' 0"	14' 6"	23' 0"
250'	40'	22'	12' 0"	15' 0"	18' 0"
300'	45'	24'	12' 6"	17' 6"	19' 0"
350'	48'	28'	13' 0"	19' 6"	20' 6"
400'	50'	32'	16' 0"	22' 0"	22' 0"
450'	54'	36'	18' 0"	23' 0"	23' 0"

Approximately the vertical height of the center of gravity of a ship is .50 to .70 of the molded depth.

**Effect of moving weights on the center of gravity of a vessel.**

(1) **Suppose the Weight Was Raised.**—The distance the center of gravity of the vessel was raised would be found by multiplying the weight moved by the distance it was moved and dividing the result by the total weight or displacement.

*Example.* A weight of 30 tons was raised from the hold and placed on the deck of a steamer at a distance of 20 ft. from its original position. The steamer had a displacement of 1000 tons. Find the distance the center of gravity was raised.

$$\frac{\text{weight} \times \text{distance}}{\text{displacement}} = \frac{30 \times 20}{1000} = .6 \text{ ft.}$$

(2) **The Weight Was Removed.**—In this case multiply the weight by its distance from the center of gravity of the ship, and divide the product by the displacement after the weight was removed.

*Example.* A weight of 30 tons 10 ft. below the center of gravity of a ship of 1000 tons displacement was removed. How much was the center of gravity raised?

$$\frac{\text{weight} \times \text{distance}}{\text{displacement} - \text{weight}} = \frac{30 \times 10}{1000 - 30} = .3 \text{ ft.}$$

(3) **Adding a Weight.**—Multiply the new weight by its distance from the center of gravity of the vessel and divide by the new displacement.

*Example.* A weight of 30 tons was placed on board of a steamer with an original displacement of 1000 tons 10 ft. below her center of gravity. Find the distance the center of gravity was lowered.

$$\frac{\text{weight} \times \text{distance}}{\text{displacement} + \text{weight}} = \frac{30 \times 10}{1000 + 30} = \frac{300}{1030} = .28 \text{ ft.}$$

(4) **Moving a Weight Athwartships.**—Multiply the weight by the distance moved and divide by the displacement.

*Example.* A weight of 20 tons at the center of the upper deck was moved 10 ft. to starboard. The steamer had a displacement of 1000 tons. Find the distance her center of gravity was moved.

$$\frac{\text{weight} \times \text{distance}}{\text{displacement}} = \frac{20 \times 10}{1000} = .2 \text{ ft. to starboard.}$$

(5) **Moving a Weight in Two Directions.**—The new positions of the center of gravity can be found by using formulæ (2) and (4).

*Example.* In a vessel of 4000 tons displacement, 100 tons of coal were shifted so its center of gravity moved 18 ft. transversely and 4 ft. 6 ins. vertically. Find the new position of the center of gravity.

By (2) the center of gravity will move vertically  $\frac{100 \times 4.5}{4000} = .11 \text{ ft.}$

By (4) the center of gravity will move horizontally  $\frac{100 \times 18}{4000} = .45 \text{ ft.}$

(Author not known)

In this case, however, the angle of heel is usually calculated instead of the distance the center of gravity moves. Thus in the above example assuming the steamer had a  $GM$  of 2 ft. the angle of heel would be  $\frac{20 \times 10}{1000 \times GM} = \frac{20 \times 10}{1000 \times 2} = .10$ , consulting the table of natural sines, the angle is found to be 5 degs. 75 mins.

**To Find the Center of Gravity of a Vessel by Moving Weights.\***—Even if the position of the transverse metacenter is known, it is of itself of no value in predicting a vessel's initial stability as the center of gravity of the entire vessel (hull, machinery, and cargo) must be known. The center of gravity can be calculated as outlined above, or it can be obtained by the inclining experiment as described below.

A perfectly calm day should be selected, all the crew ordered off the vessel, all movable weights made fast, and the vessel trimmed so she is perfectly upright. A plumb line is hung down one of the hatches (sometimes two at two different hatches), usually as near amidships as possible. At the end of the plumb line a horizontal batten is placed on which can be marked the deviation of the plumb line when the vessel is inclined.

A weight 1 is shifted from port to starboard on the top of weight 3, through a distance of  $d$  feet, and the deviation of the plumb line noted.

Weight 2 is shifted from port to starboard on top of weight 4 and the deviation of the plumb line noted.

The weights 1 and 2 are then replaced in their original position, the vessel returning to the upright position again.

Weight 3 is moved from starboard to port on top of 1 and the deviation of the plumb line noted, and similarly 4 is moved on top of 2. Then the weights are returned to their original position.

If  $w$  = weight moved in tons

$W$  = displacement of vessel in tons

$a$  = deviation of plumb line along the batten in ins.

$l$  = length of plumb line in ins.

$d$  = distance weight is moved in ft.

$GM$  = distance between the center of gravity and the transverse metacenter in ft.

$$\text{Then } GM = \frac{w \times d}{W \times \frac{a}{l}} = \frac{w \times d \times l}{W \times a}$$

\*From Theo. Naval Architecture, E. L. Attwood.

**Example.** A steamer has a displacement of 5372 tons, and draws 16 ft. 9 ins. forward and 22 ft. 10 ins. aft. Weight used for inclining 50 tons, which was moved 36 ft. Length of plumb line 15 ft. Two plumb lines were used.

	Deviation of Plumb line in 15 ft.	
	Forward (Inches)	Aft (Inches)
Experiment 1, 12½ tons port to starboard.....	5½	5½
Experiment 2, 12½ tons port to starboard.....	10½	10½
Weights returned to original position.....		
Experiment 3, 12½ tons starboard to port.....	5½	5½
Experiment 4, 12½ tons starboard to port.....	10½	10½

Thus the mean deviation in 15 ft. for a shift of 25 tons through 36 ft. is 10½ ins. = 10.312 ins.

$$\text{Then } GM = \frac{w \times d \times l}{W \times a} = \frac{25 \times 36 \times 15 \times 12^1}{5372 \times 10.31} = 2.92 \text{ ft.}$$

<sup>1</sup> Multiply by 12 to reduce to ins. as the deviations are in ins.

### FREEBOARD \*

The full scantling vessel is taken as of sufficient strength, and is the standard by which strength is gaged. Vessels which are less strong are required to have more freeboard. For the full scantling vessel the freeboard is determined solely by the desirable reserve of buoyancy.

The percentage of the total volume which is given on Plate I as a reserve buoyancy for a vessel of given type and dimensions will be the amount of volume that must be left out of the water. If a line be drawn upon this displacement curve at a draft sufficient to cut off the given percentage of total volume, the height of side above this draft will be the freeboard required.

In order to simplify and reduce the work that would be involved by the above mode of determining the maximum allowable draft and the consequent freeboard that corresponds to a given percentage of reserve buoyancy, tables were evolved which, for a ship that conformed to a so-called "standard" ship, gave directly the percentages of reserve of buoyancy and freeboards necessary for different sizes and types of vessel. The curves of Plates 2 and 3 are plotted from these tables.

The standard ship was considered to be a flush deck ship with a certain sheer which was termed standard or normal sheer, with a certain proportion of length to depth and with a standard

\* Published in Int. Marine Engineering by Prof. H. A. Everett, revised by him, April, 1917.

roundup of deck beams, and for this vessel the curves read directly. Deck erections contribute to safety and are taken account of as a corrective term, as are also other variations from the standard ship. In practice the freeboard is actually assigned after the ship is built and usually by one of the classification societies' agents, but its preliminary determination is an important and necessary item in the design of any vessel, as the draft plus the freeboard gives the depth.

The complete tables as issued by the British Board of Trade take up a variety of modifications and corrections which are involved by vessels differing from the arbitrarily assumed standard. The following work is based upon the rules directly, although the presentation and the wording are modified. The curves given on Plates 1-4 are a graphical representation of corresponding tables in the rules. Spar deck steamers and sailing vessels are not included as these classes are not numerous in present-day designs.

The limitations of loading as laid down by the above act (for complete text see publication issued by Marine Department of the British Board of Trade, entitled *Instructions to Surveyors, Load Line*) are represented by a disk and number of horizontal lines which are cut and painted on the side of the ship amidships as shown in Fig. 32. The upper edge of each line is the point of measurement.

The word "freeboard," legally, denotes the height of the side of the ship above the water line, measured at the middle of her length along the load water line. It is measured from the top of the deck at the side. The reserve of buoyancy necessary for flush deck steamers of full scantling and awning deckers are given by the curves on Plate 1 and these curves hold for any and every vessel regardless of proportions. For the standard vessel of these classes and within the dimensions given the freeboards required may be read directly from Plates 2 and 3.

For awning deck vessels the freeboards are determined more by considerations of structural strength than by reserve of buoyancy, and indicate the depth of loading beyond which it is probable that first class vessels of this type would be unduly stressed when at sea. Therefore the freeboards and percentages of reserve buoyancy are in excess of what would be required for full scantling vessels. They are measured to the deck below the shelter or awning deck. The freeboards given in the curves are for flush deck vessels in all cases, and for the standard ship—a ship which has no deck erections, has a proportion of length to depth of 12, has a roundup of deck

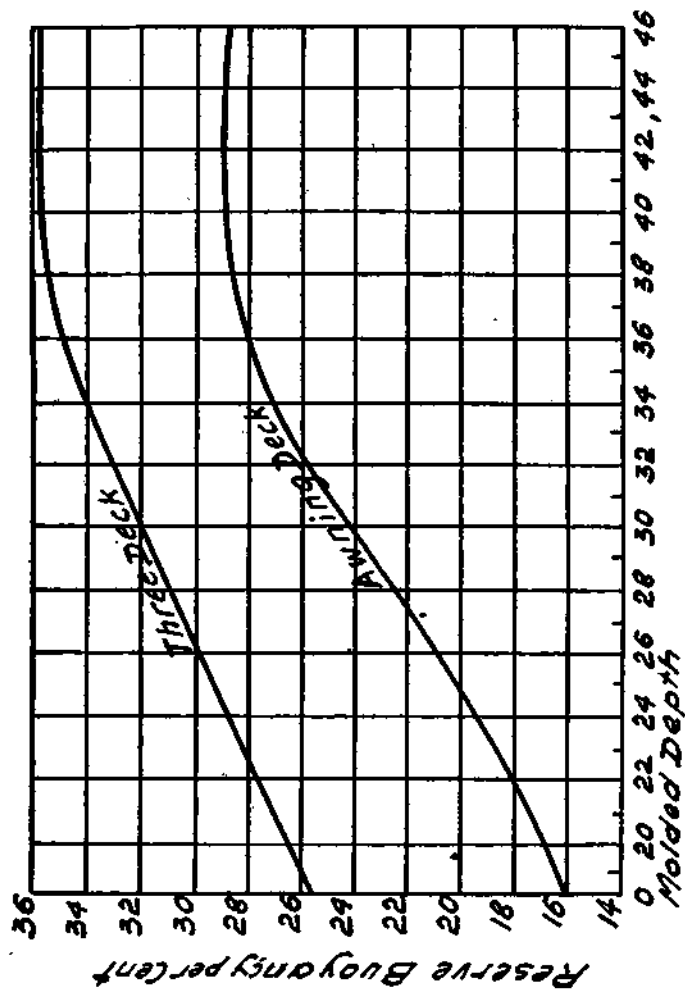

Plate 1

beams of  $\frac{1}{4}$  inch per foot of beam, and has a mean sheer in accordance with that derived from the curves shown on Plate 4.

The data required for determining the freeboard by the curves are:

1. Type of ship
2. Dimensions
3. Mean sheer
4. Round of beam
5. Description of deck (where statutory deck line is placed)
6. Coefficient of fineness

The type of ship must be agreed upon in order to ascertain which table will meet the case and whether modifications are necessary.

The length for freeboard is measured at the load line from the fore side of the stem to the after side of the sternpost in sailing ships, and the after post in steamers.

The breadth for freeboard is the extreme breadth measured to the outside of plank or plating as given on the certificate of the ship's registry.

The depth for freeboard is the depth of hold as given on the certificate of the ship's registry. This is the depth for determining the coefficient of fineness. (Upper deck beam at side in flush deck vessels, main deck beam at side in spar and awning deck vessels to top of ceiling or sheathing on double bottom.)

**Coefficient of Fineness.**—This in one-, two-, and three-deck vessels is found by dividing 100 times the gross registered tonnage of the vessel below the upper deck by the product of the length, breadth, and depth of hold. In shelter deck vessels the registered depth and tonnage are taken to the deck below the shelter deck.

**Molded Depth.**—The molded depth of an iron or steel vessel, as used in the curves, is the perpendicular depth taken from the top of the upper deck beam at side, at the middle of the length of the vessel to the top of the keel and the bottom of the frame at the middle line. This is the depth for the proportion of length to depth.

**Freeboard.**—The molded depth, taken as above described, is that used in the curves for ascertaining the amount of reserve buoyancy and corresponding freeboard in vessels having a wood deck, and the freeboard is measured from the top of the wood deck at side, at the middle of the length of the vessel. Where wood decks are not fitted on the upper decks, the freeboard should be reduced by the thickness of the wood deck or the percentage of it

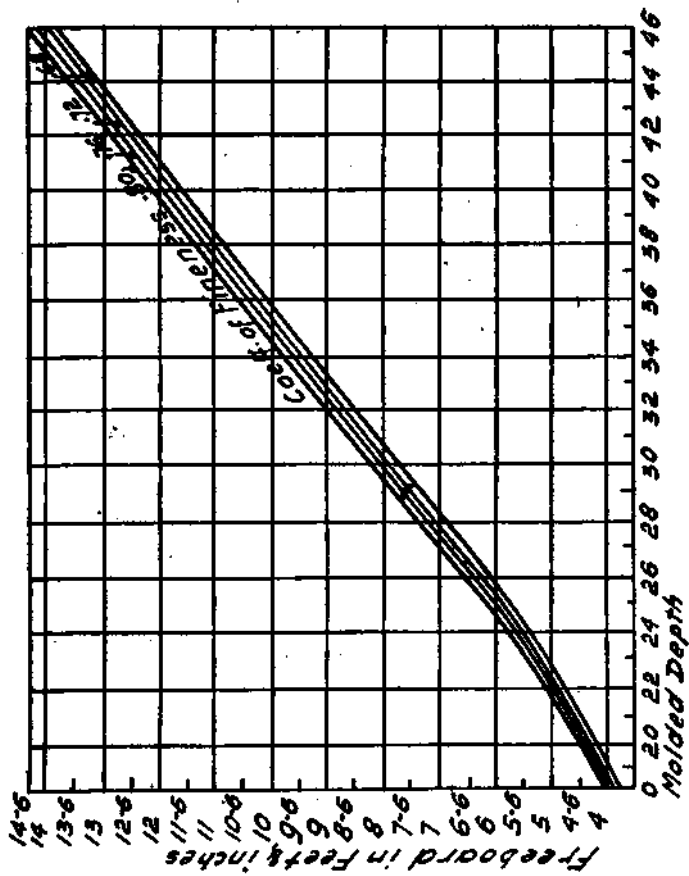

Plate 2.—Minimum Freeboard (Winter) allowed by Board of Trade for Three Deck Steamers.



corresponding to the percentage of the length covered by substantial deck erections if they cover less than 70%.

The following example will illustrate the application of the curves when dealing with a standard vessel. In a steamer 357 ft. long, extreme beam 40 ft., depth of hold 26 ft., registered tonnage under deck 2,980 tons, molded depth 29.8 ft., under deck capacity 298,000 cu. ft., which divide by 382,000—that is, the product of the length, breadth, and depth of hold—the quotient is .78 or the coefficient of fineness.

Referring to Plate 2 at 29.75 ft. molded depth and coefficient .78, the winter freeboard given for a standard steam vessel (without erections and length 12 times the molded depth) is 7 ft. 7 ins., which corresponds to a reserve buoyancy of 32% of the total bulk.

Vessels rarely conform to the proportions assumed for the standard, and the correct determination of freeboard for the actual vessel becomes a matter of properly applying the corrections to allow for the departure from the standard. The variations most commonly met with are the sheer, deck erection, and proportions of length to depth. The corrections for each of these items must be made and in the order given, as the correction for erections is based upon the difference between the freeboard for full scantling vessels corrected for sheer and the freeboard for awning deck vessels (uncorrected).

**Sheer.**—The tables are framed for vessels having a mean sheer of deck measured at the side, as shown in the sheer diagram of Plate 4.

In flush deck vessels and in vessels with erections on deck, when the sheer of deck is greater or less than the above, and is of gradual character, divide the difference in inches between it and the mean sheer provided for by 4, and the result in inches is the amount by which the freeboard amidships should be diminished or increased, according as the sheer is greater or less.

In all cases the rise in sheer forward and aft is measured with reference to the deck at the middle of the length, and where the lowest point of the sheer is abaft the middle of the length, one-half of the difference between the sheer amidships and the lowest point should be added to the freeboard specified in the tables for flush deck vessels and for vessels having short poops and forecastles only.

**Erections on Deck.**—For steam vessels with topgallant forecastles having long poops, or raised quarter decks connected with bridge houses, covering in the engine and boiler openings, the latter being entered from the top and having an efficiently con-

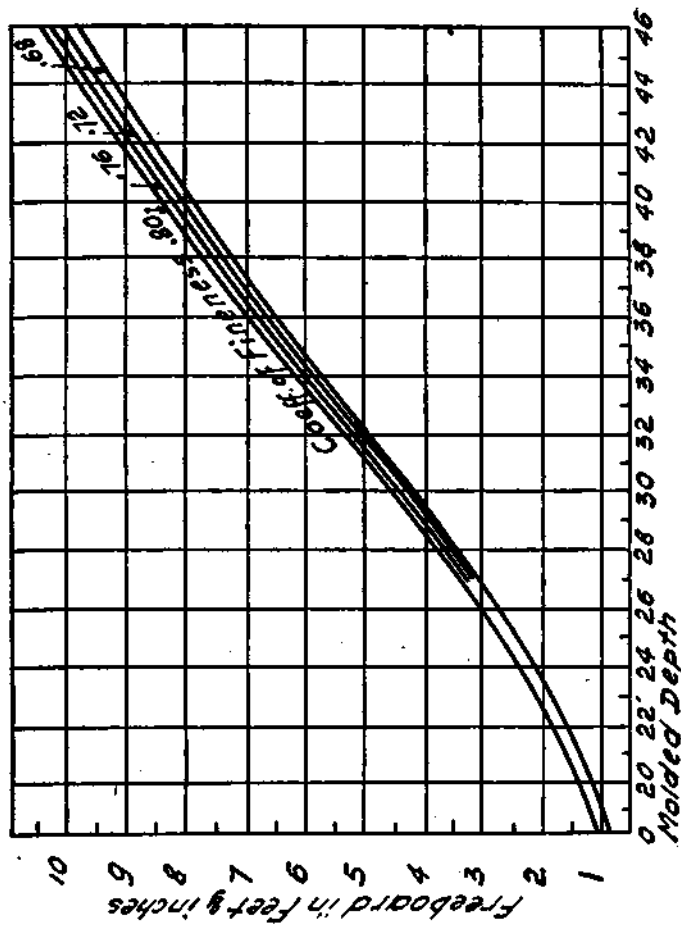

Plate 3.—Minimum Freeboard (Winter) allowed by Board of Trade for Awning Deck Steamer.

structed iron bulkhead at the fore end, a deduction may be made from the freeboard given in the curves according to Curve A, Plate 4.

When the erections on a vessel consist of a **topgallant forecastle**, a **short poop** having an efficient bulkhead and bridge house disconnected, the latter in steamers covering the engine and boiler openings, and being efficiently inclosed with an iron bulkhead at each end, a deduction may be made from the freeboard given in the curves, according to Curve B, Plate 4.

When the erections consist of a **topgallant forecastle** and **bridge house** only, the latter in steamers covering the engine and boiler openings, and being efficiently inclosed with an iron bulkhead at each end, a deduction may be made from the freeboard given in the curves according to Curve C, Plate 4.

When the erections on a steamer consist of a **short poop** or **raised quarter deck** of a height from 3 ft. to 6 ft. for lengths of ship of 250 ft. to 400 ft., and **topgallant forecastle** only, the former being inclosed at the fore end with an efficient bulkhead, and when the engine and boiler openings are entirely covered, a deduction may be made from the freeboard given in the curves according to Curve D, Plate 4.

**Vessels of Extreme Proportions.**—For vessels whose length is greater or less than 12 times the molded depth for which the curves are framed, the freeboard should be increased or diminished as specified in the following table:

TABLE 1

Correction in freeboard for a Change of 10 ft. in Length	Molded Depth Ft.	Length Ft.
1.2	20 -23	240-276
1.3	23½-25½	282-306
1.4	26 -28	312-336
1.5	28½-30½	342-366
1.6	31 -33	372-396
1.7	33½-50	402-600

For shelter deck vessels the correction is  $\frac{1}{4}$  that specified in the above table.

Thus if the vessel in the above example were 367 ft. long, the winter freeboard would be 7 ft. 7 ins. plus 1.5 ins., or 7 ft. 8.5 ins. For steam vessels with normal inclosed deck erections as on Plate 4

(Curves A and B), extending over  $\frac{1}{10}$  or more of the length of the vessel, the correction for length should be  $\frac{1}{2}$  that specified in the table.

**Round of Beam.**—In calculating the reserve of buoyancy an allowance has been made for the roundup of  $\frac{1}{4}$  inch for every foot of the length of the midship beam. When the total roundup of the beam in flush decked vessels is greater or less than given by this rule, divide the difference in inches by 2 and diminish or increase the freeboard by this amount. For vessels with erections on deck the amount of the allowance should depend on the extent of the main deck uncovered.

**Breadth and Depth.**—It has been assumed that the relation between the breadth and depth is reasonable, and for vessels of less relative breadth the freeboard should be increased to provide a sufficient range of stability. The following illustrates the application of the curves when dealing with a vessel not conforming to the standard type:

A vessel 234 ft. long, 29 ft. beam has a molded depth of 17 ft., the coefficient of fineness being .72. Suppose she has a poop and bridge house of a total length of 121 ft. and a forecastle of 20 ft., and the sheer forward measured at the side 4 ft. 6 ins., and aft 2 ft. 1 in.

	Ft.	Ins.
Freeboard by Plate 2, if of standard proportions, without erections and with the normal amount of sheer.....	2	11
The mean sheer by rule is 33.4 ins., or 6 ins. less than that in the vessel, and the reduction in freeboard is 6 ins. divided by 4.....		1½
Freeboard of vessel without erections and with 39½ ins. mean sheer.....	2	9½
Freeboard by Plate 3 as awning deck.....		9½
Difference.....	2	0

The combined length of the erections is  $\frac{1}{10}$  or six-tenths of the length of the vessel, and the allowance for erections from Curve A, Plate 4, will be four-tenths of 24 ins. or 9½ ins. Thus

	Deduct Ins.
Amount deducted from freeboard for excess of sheer....	1½
Amount deducted from freeboard for erections.....	9½
Amount deducted if vessel be fitted with an uncovered iron main deck = $\frac{1}{8} \times 3\frac{1}{2}$ .....	2
	13
The length being 30 ft. in excess of that for which the tables are framed, the addition to the freeboard for excess length is ½ of 1½ or 1.1 ins. or.....	1½
	11½

That is 11½ ins. is to be deducted from 2 ft. 11 ins. leaving a winter freeboard of 1 ft. 11½ ins. Corresponding summer freeboard 1 ft. 9 ins.

Vessels loaded in fresh water may have less freeboard than that given in the several tables, according to the following scale:

TABLE 2

Molded Depth in Ft.	Reduction in Freeboard	
	Vessels Without Erections on Deck	Shelter and Awning Deck Vessels
19 and under 22.....	4	4½
22 and under 25.....	4½	5
25 and under 28.....	5	5½
28 and under 31.....	5½	6
31 and under 34.....	6	6½

The weight of a cubic foot of salt water is taken in the above table as 64 lb. and of fresh water 62.5 lb.

In no case shall the deepest load line in salt water, whether indicating the summer or Indian summer line, be assigned at a higher position than the intersection of the top of the upper deck with the vessel's side at the lowest part of the deck. In the case of shelter deck vessels the deck next below the shelter deck is to be regarded as the upper deck.

So far the question of freeboard determination has been considered from the viewpoint of its determination for some existing ship whose characteristics are known. The most useful function of the work as presented here is to permit a solution for the depth of vessel under design. The accurate determination of freeboard



should properly be attempted only from the complete tables referred to earlier, but from the information here presented, it is possible readily to determine the freeboard and therefore depth for a proposed design which has progressed sufficiently to have its length, draft, block coefficient, and general arrangement selected. In general the coefficient of fineness is sufficiently close to the block coefficient to accept the latter for entering the curves.

In considering a vessel under design, the general procedure for determining the freeboard of a full scantling vessel should be as follows:

1. Assume a molded depth which seems reasonable, enter the curves, and for this depth read off the freeboard for the proper coefficient of fineness.

2. Correct this freeboard for sheer and erections and add the corrected freeboard to the draft to determine a revised molded depth. Multiply it by 12 and the difference between this and the actual length gives the basis for determining the corrections for proportions.

3. Determine the correction for proportions and the original freeboard corrected for these three elements (sheer, erections, and proportions), when added to the draft, should give a molded depth in agreement with that originally assumed. If it does not, repeat the solution, starting with a modified assumed depth. The first trial will rarely give agreement but the second or third should suffice.

Shelter deck steamers now form such a large proportion of the tonnage afloat that they need to be treated as a special class, and the revised rules do so take cognizance of them. The freeboard of a shelter deck steamer must in no case be less than the freeboard which would be assigned to a complete awning deck steamer of the same dimensions. The shelter deck rules are framed for a vessel having a complete superstructure covering the full length of the vessel, the deck continuous and unbroken at the side, but having one or more openings along the middle line of the deck, such openings not to have permanent means of closing in the shape of hatchways fitted with coamings, cleats, etc. The deck below the shelter deck is called the upper deck and is the one to which freeboard is measured.

For shelter deck vessels the steps for determination of freeboard are the same as in full scantling vessels, considering them as full scantling vessels with very long erections, and the freeboard is

measured to the deck below the shelter deck (upper deck). There is no correction for round up of deck beams for awning and shelter deck vessels. The order of procedure is:

1. Assume a reasonable depth (molded) and read the freeboard from the curve for this abscissa on Plate 2.

2. Correct this for sheer and use this corrected freeboard in estimating allowances for erections.

3. Correct for erections.

4. Use this newly corrected freeboard for determining the depth (molded) for proportions. Multiply it by 12 and correct for proportions.

5. Add this final freeboard to the draft and get a depth which should agree with that first assumed. If it does not, repeat the solution. Two or three trials should suffice.

In assigning freeboards to shelter deck vessels, the following rules should be observed:

1. In making the sheer correction in accordance with the paragraph on Sheer, the sheer is to be measured at the ends of the vessel and the freeboard corrected for sheer is to be used in estimating the allowance for erections.

2. (a) If there is but one opening in the shelter deck the allowance for deck erections is to be determined from Curve A, Plate 4, provided that the effective length of the shelter deck is not less than six-tenths of the length of the vessel.

- (b) If there are two or more openings in the shelter deck the allowance for deck erections is to be determined from Curve B, Plate 4, provided that the effective length of the shelter deck, excluding openings, is not less than six-tenths of the length of the vessel.

3. The effective length of the shelter deck is to be calculated in the following manner, provided the openings in the shelter deck do not exceed half the vessel's breadth at the middle of the length of the opening. The length is taken as if each opening were an open well. The value of each part is assessed in accordance with the different regulations affecting poops, bridge houses, and forecastles, open or closed. The final allowance for erections will depend upon whether or not temporary but efficient means are provided for closing the openings in the shelter deck.

- (a) If efficient means as specified below are provided for temporarily closing the openings in the shelter deck, the effective length of the shelter deck is to be reckoned as the length computed as



prescribed above, plus half the difference between that length and the length of the vessel.

(b) If efficient means for temporarily closing the openings are not provided, the effective length of the erections is to be computed by adding to the length computed as above, one-fourth, instead of one-half the difference between that length and the length of the vessel.

(c) If the openings in the shelter deck are wider than the half-beam at that point, the addition to the assumed length of erections is to be modified in proportion to the relation which the actual opening holds to the specified breadth and to a complete well.

To illustrate the method of determining the depth for a new design, and also the application of the rules to the shelter deck type of vessel, note the following: A complete shelter deck vessel 490 ft. long, 58 ft. beam, 28 ft. draft, block coefficient .80, has one tonnage opening in the shelter deck. Assume for the first trial depth

$$\frac{L}{12} \text{ or } \frac{490}{12} = 40 \text{ ft., approximately}$$

	Ft.
At 40 ft. depth and .80 coefficient of fineness the freeboard for a full scantling vessel is 11 ft. 8 ins. (Plate 2).....	11.67
The sheer forward is 9 ft. and aft 3 ft., so the mean sheer is $\frac{9+3}{2} \times 12 = 72$ ins. The standard or normal mean sheer from Plate 4 is 60 ins., so that the excess sheer is $72 - 60 = 12$ ins., and the sheer correction is $\frac{12}{4} = 3$ ins. = .25 ft.....	.25
This is to be subtracted, as the sheer is greater than the normal, then freeboard corrected for sheer is.....	11.42
Freeboard for awning deck (Plate 3) (uncorrected).....	8.41
Difference.....	3.01

The correction for erections is 90% of this (Curve A, Plate 4), as the erections cover 95% of the vessel length,  $.9 \times 3.01 = 2.71$ . The freeboard corrected for sheer and erections then becomes  $11.42 - 2.71 = 8.71$  ft. This, with a draft of 28 ft., gives a molded depth of  $8.71 + 28 = 36.71$  ft.

A standard ship of this depth would have a length 12 times as great or  $36.71 \times 12 = 440$  ft. (approximately), which is 50 ft. shorter than the actual ship, so the freeboard must be increased

to correct for proportions. From Table 1 this correction =  $\frac{1.7}{2}$  inch for every 10 ft. excess of length, and the correction in feet is

$$\frac{1.7}{2} \times \frac{1}{12} \times \frac{50}{10} = .0708 \times \frac{50}{10} = .35 \text{ ft.}$$

Therefore the freeboard corrected for sheer, erections and proportion becomes  $8.71 + .35 = 9.06$  ft., and the molded depth is  $9.06 + 28 = 37.06$  ft.

This depth does not agree with that first assumed, so a second solution will be made using the depth just found as a trial depth. Assume for the second solution a trial depth of 37 ft.

Freeboard of full scantling vessel.....	10.50
Less sheer correction.....	.25
	<hr/>
	10.25
Freeboard for awning deck vessel.....	7.25
	<hr/>
Difference.....	2.99
Correction for erections $.9 \times 2.99$ .....	2.69
Freeboard corrected for sheer and erections....	7.56
Draft.....	28.
	<hr/>
Depth of ship at 28 ft. draft.....	35.56
Corresponding length of standard ship.....	427.
Length of actual ship.....	490.
	<hr/>
Difference.....	63.
Correction for proportions $(.0708 \times 63)$ .....	.43
Final corrected freeboard $7.56 + .43$ .....	7.99
Depth at 28 ft. draft = $28 + 7.09$ .....	35.99

Repeating this process for a third trial depth of 35 ft., a resulting depth of 35.31 ft. and freeboard of 7.31 ft. is obtained.

TABLE 3

Allowable reduction from winter freeboard for summer freeboard. Double these reductions allowed for the Indian Summer line and 2 ins. more required for the Winter North Atlantic line if of 330 ft. length or less.

Molded Depth Ft.	Reduction Ins.	Molded Depth Ft.	Reduction Ins.
16.5 to 19	2	34 to 35.5	6
19 " 22	2½	36 " 37.5	6½
22.5 " 24.5	3	38 " 39.5	7
25 " 26.5	3½	40 " 41.5	7½
27 " 28.5	4	42 " 43.5	8
29 " 30	4½	44 " 45.5	8½
30.5 " 32	5	46 " 47.5	9
32.5 " 33.5	5½	48 " 50	9½

## MISCELLANEOUS NOTES

In the United States there are no standard requirements although the American Bureau of Shipping has made suggestions as to the loading as follows: "No vessel is to be loaded so that the freeboard (measured at the lowest point of sheer) from the main deck stringer plate to the water edge shall be less than is indicated in the following table:

Depth of Hold from Top of Ceiling to Under Side of Main Deck Beam	Freeboard at Lowest Point of Sheer for Each Foot Depth of Hold
8 ft.....	1½ ins.
10 ".....	2 " "
12 ".....	2¼ " "
14 ".....	2½ " "
16 ".....	2¾ " "
18 ".....	3 " "
20 ".....	3¼ " "
22 ".....	3½ " "
24 ".....	3¾ " "
26 ".....	4 " "
28 ".....	4¼ " "
30 ".....	4½ " "

"It is suggested by the Rules Committee that the minimum freeboard for hurricane deck vessels should not be less than ½ or for raised quarter deck vessels ¾ of that indicated in the table.

"The depth of hold for regulating freeboard to be measured to and the freeboard from, the second deck of hurricane deck vessels.

"The depth of hold for regulating freeboard to be measured to

and the freeboard from, the main deck of vessels having a raised quarter deck."

In Great Britain a committee was appointed by the Board of Trade in 1883, to formulate rules for the assigning of freeboard to vessels. These rules were revised in 1906, and with slight alterations remain in force today. Although Lloyd's assign freeboard to vessels yet perhaps the final authority or rather the authority Lloyd's follows are the regulations of the British Board of Trade.

Freeboards are measured from a horizontal line squared out from the inner edge of a water way of assumed width (see Fig. 32). This horizontal line is called the statutory deck line and the vertical distance between it and the deck at the side the statutory allowance which averages about  $\frac{1}{8}$  of the round of beam.

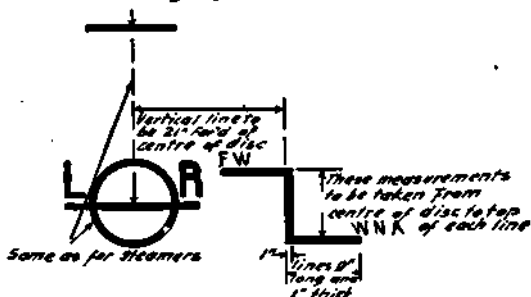
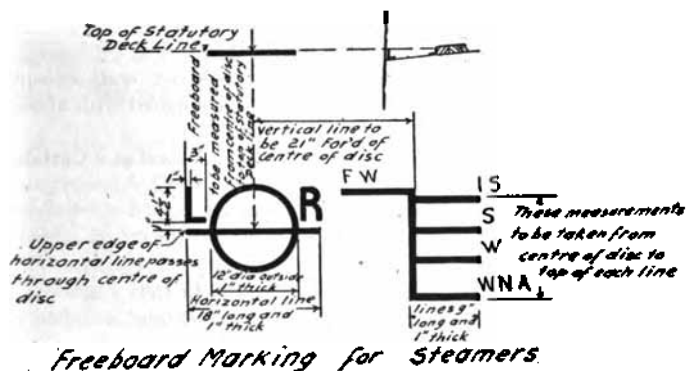

Figure 32.—Freeboard Markings

The freeboard regulations consist essentially of a number of tables which give in feet and inches the freeboards of vessels of any depth, within certain limits, that is vessels having a certain ratio of depth to length. The tables only strictly apply to standard vessels but provision is made for adapting them to those of various types. (For calculations and the assumptions made see Freeboard Tables, Board of Trade, London.)

**Freeboard Markings.**—Center of disk to be placed on both sides of vessel amidships, i.e. at the middle length of the load water line. The disks and lines must be permanently marked by center punch marks or cutting. L R indicates Lloyd's Register. If the freeboard has been assigned by the Bureau Veritas the letters used are B V. F W = Fresh Water, I S = Indian Summer, S = Summer, W = Winter, W N A = Winter North Atlantic.

### POWERING VESSELS

The following formulae apply to all power-driven craft except hydroplanes. The results obtained should be compared with those of actual ships as given in tables on pages 310-320.

To Find the Approximate I. H. P. to Propel a Vessel at a Certain Speed.

Let  $H$  = indicated horse power of the engine

$D$  = displacement in tons

$V$  = speed in knots

$K$  = coefficient for small launches = 100 to 150

yachts moderately fine and fair  
speeds = 200

merchant vessels of moderate size = 220 to  
250

larger vessels = 250 to 300

fast passenger boats = 220 to 280

torpedo boats = 200

cruisers and battleships = 200 to 250

$$\text{Then } H = \frac{V^3 \times \sqrt[3]{D^2}}{K} \quad \text{and } V = \sqrt[3]{\frac{H \times K}{\sqrt[3]{D^2}}}$$

**Example.** It is proposed to build a freight steamer 280 ft. long, displacement 3800 tons, speed 10 knots. Find the approximate indicated horse power for the engine.

Assume  $K = 220$

$$\text{Then } H = \frac{V^3 \times \sqrt[3]{D^2}}{K} = \frac{10^3 \times \sqrt[3]{3800^2}}{220} = 1190$$

Also for estimating the i. h. p. the following formula can be used, but it does not apply favorably to fast vessels but is suitable for low and moderate speeds. (See also paragraph in "Marine Engines" on estimating horse power.)

$H$  = i. h. p.

$V$  = speed in knots

$S$  = wetted surface in square feet

$K$  = coefficient for short beamy ships = 6.

merchant vessels of ordinary form = 5.

fine ships = 4.

$$\text{Then } H = \frac{K \times S \times V^3}{100000}$$

**Effective Horse Power** (e. h. p.) at a given speed is the horse power required to overcome the various resistances to a vessel's progress at that speed. Calling these resistances  $R$  and the speed in feet per minute  $S$  then the e. h. p. =  $\frac{R \times S}{33000}$ . The ratio

of effective horse power to the indicated horse power, viz.  $\frac{\text{e. h. p.}}{\text{i. h. p.}}$  at any speed, is the propulsive coefficient at that speed. For modern vessels with fine lines a propulsive coefficient of 50% may be expected. In cases with extremely fine forms and fast running engines, the percentage increases.

**Towing.**—To find the horse power required at a given speed, as, for instance, when a tug is towing a barge.

$R$  = resistance to motion in lb.

$v$  = speed in feet per minute

$V$  = speed in knots per hour

$H$  = horse power

$$\text{Then } H = \frac{R \times v}{33000} = \frac{R \times V}{320} \text{ nearly}$$

**Example.** At a speed of 10 knots per hour (or 1013 ft. per minute) the tow rope strain on a tug towing a barge was 10770 lb. Find the horse power necessary to overcome the resistance of the barge alone. Work done per minute in foot-pounds =  $R \times v = 10770 \text{ lb.} \times 1013 \text{ ft.}$

$$H = \frac{R \times v}{33000} = \frac{10770 \times 1013}{33000} = 330.$$

A 158 ft. tug, engine  $\frac{17 \times 27 \times 45}{36}$  (see table of Excursion and Harbor Vessels), can tow three barges of 1800 tons deadweight each

at a sea speed of about 7 knots per hour. A 90-ft. tug, engine  $\frac{14 \times 30}{20}$ , for harbor service can easily handle two square-ended scows 90 ft. long by 30 ft. beam. In ocean towing, the barges should be several hundred feet apart, as they tow more satisfactorily in this way than close together.

**To Find the Number of Revolutions of the Engine to Drive a Vessel at a Certain Speed.\***

$P$  = pitch of the propeller in feet

$S$  = required speed in knots

$R$  = revolutions per minute at required speed

$N$  = number of feet in a knot (6080)

$s$  = per cent of slip of propeller expressed as a decimal.

$$\text{Then } R, \text{ revolutions of engine} = \frac{6080 \times S}{60 \times P \times (1 - s)}$$

$$S \text{ the speed in knots} = \frac{60 \times P \times R \times (1 - s)}{6080}$$

*Example.* The pitch of a propeller is 16 ft. How many revolutions must it make to drive a ship at a speed of 10 knots per hour, the slip of the propeller being estimated at 10%.

From the above formula the revolutions

$$R = \frac{6080 \times S}{60 \times P \times (1 - s)} = \frac{6080 \times 10}{60 \times 16 \times (1 - .1)} = 70\frac{1}{4}$$

**To Find the Number of Revolutions per Minute at Which to Run the Engine to Give a Required Speed.\***

$R$  = revolutions per minute for a given speed

$S$  = given speed

$R_1$  = required revolutions

$S_1$  = required speed

$$\text{Then } R_1 = \frac{R \times S_1}{S}$$

*Example.* If a vessel travels at the rate of 16 knots an hour when the engine is making 64 revolutions per minute, what should be the number of revolutions per minute to reduce the speed to 14 knots? The revolutions required are given by the formula  $R_1 = \frac{R \times S_1}{S}$  substituting the above values, then  $\frac{64 \times 14}{16} = 56$  revolutions per minute.

**Formula for Estimating the Speed of a Motor Boat.**

$M$  = speed in statute miles per hour

$L$  = length over all (feet)

\*From Mariner's Handbook.

$B$  = extreme beam (feet)

$P$  = brake horse power of engine

$C$  = constant = 9.5 moderate speed type  
8.5 high speed type

$$M = \frac{C\sqrt{L \times P}}{B}$$

Thrust horse power, see Horse Powers.

Calculation of thrust, see Propellers.

**Resistance.**—The total resistance of a vessel is made up of frictional resistance, eddy making, and wave forming. The eddy making is about one-tenth of the frictional and does not exceed 5% of the power required to drive a vessel. As to the wave forming, it has been found impossible to formulate a practical law. Experiments made by Mr. Froude in England showed that the frictional resistance at a 6-knot speed is about  $\frac{1}{4}$  of a pound per square foot of wetted surface for ordinary painted ship's bottoms, and that the total resistance varies about as the square of the speed. Using Froude's value for frictional resistance as  $\frac{1}{4}$  lb. per square foot at 6 knots, then frictional resistance of a vessel = square feet of wetted surface  $\times \frac{1}{4}$  lb. per square foot  $\times \left(\frac{\text{speed}}{6}\right)^2$

and horse power =  $\frac{\text{resistance} \times \text{speed in feet per minute}}{33000}$

The actual resistance of ship to progress through the water is the *e. h. p.* (effective horse power) required, which is perhaps  $\frac{1}{2}$  of the indicated horse power. Within the lower limits of power and speed only the frictional resistance need be considered. The following applies in general from  $\frac{1}{8}$  to  $\frac{3}{4}$  full power.

1. The indicated horse power varies as the square of the speed.
2. Consumption of fuel varies as the square of the speed.

*Example.* If a steamer burns 40 tons of coal per day at a speed of 20 knots per hour, how many would she burn at 21 knots?

The consumption per knot at 20 knots is  $\frac{40}{20} = 2$  tons

Then the consumption per knot at 20 knots : to the consumption at 21 knots = square of the speed at 20 knots : is to square of speed at 21 knots.

$$2 : x = 20^2 : 21^2$$

$$x = \frac{2 \times 21^2}{20^2} = 2.2 \text{ tons per knot}$$

or 21 knots  $\times$  2.2 tons = 46.2 tons per hour.

(Author not known.)



3. Total fuel consumption for any distance varies as the square of the speed times the distance.

At half-speed the frictional resistance will be only  $\frac{1}{4}$  of the frictional resistance at full speed. Since the power required to propel a ship is proportional to the product of the frictional resistance and the speed, it follows that the power delivered by the propeller is proportional to the cube of the speed. Thus at half-speed the output from the propeller is only  $\frac{1}{8}$  of the output at full speed. This relation is not exact but is nevertheless widely used in making approximate calculations, for the power required increases at high speeds more rapidly than as the cube of the speed.

TABLE OF APPROXIMATE VALUES FOR THE FRICTIONAL RESISTANCE OF SHIPS

Displacement in Tons	Frictional Resistance in Pounds Per Ton at a Reference Speed of 20 Knots
500 .....	42
1,000 .....	34
2,000 .....	26
4,000 .....	18
8,000 .....	12
16,000 .....	9
32,000 .....	7

From the above table it will be noted that for a given speed the frictional resistance per ton gradually decreases with increasing size of ship and attains a low value in large ships.

*Example.* Find the thrust horse power of a 4000-ton ship when at a speed of 22 knots.

From the table the frictional resistance at a speed of 20 knots is given as 18 lb. per ton. For a speed of 22 knots the frictional resistance is

$$4000 \times \left(\frac{22}{20}\right)^2 \times 18 = 87120 \text{ lb.}$$

Then thrust horse power =  $\frac{87120 \times 22 \text{ knots} \times 6080 \text{ ft.}}{60 \text{ min.} \times 33000 \text{ lb.}} = 5900$  nearly.

The law of comparison, or Froude's law, states: "The resistances of similar ships are in the ratio of the cubes of their linear dimensions, when their speeds are in the ratio of the square root of their dimensions." The speeds which are connected by this relation are known as corresponding speeds. The law applies only to that resistance for which the dynamic conditions are similar irrespective

of size. However, this is not the case so far as frictional resistance of a ship is concerned and the law does not apply to it. For this reason the results of experiments with models have to be corrected for friction when they are applied to the ship. (See Ship Forms, Res. and Screw Propulsion, by B. S. Baker.)

**FROUDE'S SURFACE FRICTION CONSTANTS FOR WELL-PAINTED SHIPS  
IN SEA WATER\***

Length of Vessel in Feet	Coefficient of Friction	Power According to which Friction Varies	Length of Vessel in Feet	Coefficient of Friction	Power According to which Friction Varies
	$f$	$n$		$f$	$n$
100	.00923	1.825	350	.00889	1.825
120	.00916	1.825	400	.00886	1.825
140	.00911	1.825	450	.00883	1.825
160	.00907	1.825	500	.00880	1.825
180	.00904	1.825	550	.00877	1.825
200	.00902	1.825	600	.00874	1.825
250	.00897	1.825			
300	.00892	1.825			

Let  $f$  = coefficient of friction from the above table

$S$  = wetted area in sq. ft.

$V$  = speed of vessel in knots per hour

$R$  = frictional resistance

Then  $R = f S V^n = f S V^{1.825}$

( $V^{1.825} = \log V \times 1.825$ )

### LAUNCHING

Care must be exercised in the building so that when a vessel is ready for launching there are no heavy weights on deck or high above the keel. For a vessel in the launching condition has a light draft, great freeboard, and a high center of gravity. An estimate can be made of the metacentric height and if this is not sufficient the ship should be ballasted to lower the center of gravity. A minimum height of transverse metacenter above the center of gravity, of one foot, should be provided in the launching condition.

Vessels are launched either stern first or sideways, the latter being the practice on the Great Lakes (U. S.). Where there is a considerable rise and fall of the tide, the launching ways extend

\* From Naval Architecture, C. H. Peabody.

usually to the level of the water at low tide, but in cases where the tidal rise is small it may be necessary to carry them further out.

The ways for vessels to be launched stern first should be so located under the hull that they come under a longitudinal or a keelson. The breadth of the ways depends on the launching weight. To determine the breadth,

Let  $W$  = launching weight in tons

$l$  = length of cradle or sliding ways, which is about .8 the length of the vessel

$b$  = breadth of each way

area of sliding ways =  $2b \times l$

Then the average pressure per square foot on the ways =  $\frac{W}{2b \times l}$

The area of the ways should be such that the pressure per square foot is not more than 2.5 tons. Thus let  $2.5 = \frac{W}{2b \times l}$ —hence the

breadth of each way =  $\frac{\text{launching weight}}{5 \times \text{length of cradle}}$ . See Launching Data.

The declivity of the ways should be from  $\frac{1}{8}$  of an in. to the foot in large vessels to  $\frac{1}{4}$  in small. The camber or longitudinal curvature is from 12 to 15 ins. in 500 ft.

In launching there are two critical periods: first, when the center of gravity has passed over the ends of the ways, for there is then little support aft and the ship has a tendency to turn about the after end of the ways and so concentrate the weight at that point; and second, when the buoyancy aft is sufficient to lift the ship and cause her to turn about the fore end of the cradle, there is then a long length of structure unsupported and a great pressure is exerted over a short length at the fore end of the cradle and the launching ways.

**Launching Calculations.\***—Assuming that the vessel has no tipping moment but gradually lifts aft as she launches, when she is almost entirely in the water—say when the fore poppet is over the end of the standing ways—the force of buoyancy pressing upward will react at the fore poppet, causing a downward pressure on the ways, tending to spread out the standing ways, to break the fore poppets, or to crush in the bows of the vessel.

For calculating this pressure, first find the declivity of the ship on the ways, and of the launching ways, and also the position of the upper line of the standing ways from the keel of the ship. Ascertain the depth of water expected on the day of the launching.

\* From A Class Book of Naval Architecture, W. J. Lovett.

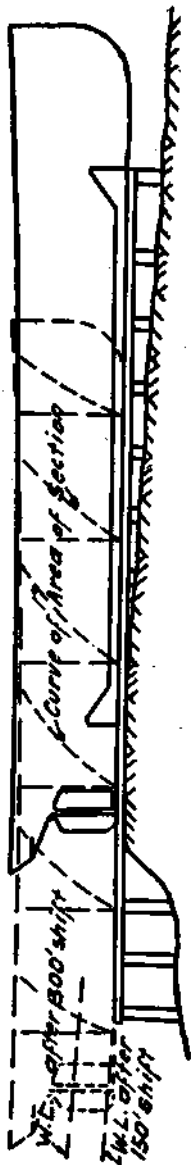

Figure 33

Make a tracing of the ship to a small scale (see Fig. 33), and divide it into displacement ordinates. Calculate the area of each section up to the several water planes and draw curves of areas at each section.

**Arrange for different positions of the ship.** Place the tracing on the first shift on the drawing (say 250 ft.) and find the volume of displacement of the ship in the water, and the position of the center of buoyancy from the after perpendicular. Do likewise for 300-, 350- and 450-foot shifts, or the shifts could be 25 ft. apart, if desired, instead of 50.

**Estimate the longitudinal position of the center of gravity of the ship.** (See Center of Gravity.) Set up to scale the moment of weight about the fore end of the sliding ways or fore poppet. This is obtained by multiplying the weight of the ship by the distance of the center of gravity from the fore end of the ways. Next find the moment of buoyancy about the fore end of the ways. This is obtained from the equation

$$\text{Moment of buoyancy about the fore end of ways} = \frac{\text{volume of displacement} \times \text{center of buoyancy from fore end of ways}}{35}$$

35 cubic feet of salt water = 2240 lb. = one ton.

Do this for each shift. Set off to the same scale the various values found for the moment of weight and the moment of buoyancy, and where they cross each other the ship will commence to rise.

Set up the **displacement** at each shift and draw a displacement curve. Find the displacement at the point where the ship commences to rise. The difference between the displacement of the ship in the water and the displacement when she begins to rise, gives the **weight bearing on the fore poppet**. Find the moment of the weight about the after end of the standing ways. Also find the moment of buoyancy about the after end of the standing ways for each shift. Draw curves as in Fig. 34. If the curve of moment of buoyancy cuts the curve of moment of weights about the after end of standing ways, there will be a tipping moment, but when they do not cut there is a lifting moment. **The different shifts** are obtained by shifting the center of gravity of the vessel so many feet aft. **The moment of weight** about the after end of the ways is calculated by multiplying the weight of the ship by the distance of the center of gravity from the end of the ways at the different shifts. Thus when the center of gravity is exactly over the end of the ways, and the displacement taken at say 6000 tons, there would

be no moment of weight about the after end, because 6000 multiplied by the distance of the center of gravity from the after end of ways, which is 0, is 0. At the 50-foot shift the moment will be  $6000 \times 50 = 300,000$  foot-tons, etc.

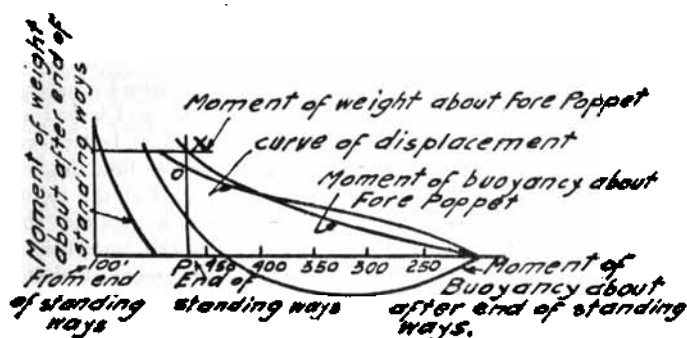

Figure 34

The moment of buoyancy is calculated by multiplying the actual displacement at the different shifts by the distance of the center of buoyancy of the various displacements from the end of the ways. The weight on the fore poppets is obtained by reading the displacement when the ship begins to rise, which in Fig. 34 is at  $x$ . The displacement is  $OP$ . Subtract  $OP$  from the displacement at the launching draft and the difference will be the weight on the fore poppets.

$$\text{Tipping lever} = \frac{\text{tipping moment}}{\text{weight of ship}}$$

The tipping lever divided by the length of the ship should have a certain ratio. A ratio of  $1/18$  is quite safe, but if more than  $1/11$  there is likely to be trouble.

**Releasing, Starting and Checking Devices.**—The former often consists of two dog shores with their heads toward the bow of the vessel and caught under a piece fastened to the sliding way. The heads and the bearings for them should be covered with steel plates. The dog shores are knocked down by simultaneously dropping weights on them, the weights being suspended by a single rope which on being cut will cause both to drop at the same time. A vessel may also be released by sawing through the sliding ways that have

been extended and fastened at the shore ends. Care must be taken that both planks are sawn at the same rate.

Should the vessel refuse to start when released, a hydraulic ram or jack may be brought to bear at the end of each launching way, and also against the stem.

To check the vessel after she has left the ways, hawsers are made fast to the hull, which are fastened to heavy chains on shore that are laid in piles at intervals. To prevent snubbing by sudden stopping, hawsers may be carried beyond the bits and lashed at intervals to another hawser on the deck, the lashings being torn away as the vessel continues to move, thus gradually bringing her to rest. In some instances a wooden shield is fixed at the stern, but care must be taken that the shield has not such an area that the vessel will be stopped on the ways when only partly waterborne. Launching velocities vary from 13.7 to 17 ft. per second, and the distance run at these velocities is about  $\frac{2}{3}$  of the length of the vessel.

The above applies to end launching, that is, stern first, which is the usual practice. For side launching the ways are given a steeper incline, and instead of only two there are several. One of the advantages of side launching is that the vessel may be built on an even keel.

## LAUNCHING DATA

	Paddle Wheel Steamer, 190' x 22' x 9'	Screw Steamer			360' x 36' x 28'	400' x 42' x 29½'
		234' x 33' x 18'	270' x 34' x 19'	330' x 43½' x 30½'		
Declivity of keel per ft.	½"	½"	½"	½"	½"	½"
Declivity of standing ways per ft.	½" to ¾"	½" to ¾"	½" to ¾"	½" to ¾"	½" to ¾"	½" to ¾"
Camber of standing ways	8"	1' 0"	1' 10"	1' 11"	1' 0"	1' 2"
Length of standing ways	195'	267'	300'	348'	367'	395'
Length of sliding ways	150'	180'	200'	240'	284'	330'
Breadth of sliding ways	1' 3"	1' 9"	1' 9"	1' 10"	1' 9"	1' 9"
Area of sliding ways in square ft.	375	630	700	880	994	1155
Total fall in length of standing ways	12' 0"	15' 4"	15' 6"	21' 6"	18' 9"	19' 7"
Water on way ends	2' 9"	2' 8"	3' 7"	3' 9"	6' 0"	4' 4"
Draft of ship forward	4' 0"	5' 9"	5' 7"	6' 6½"	11' 6"	7' 0"
Draft of ship aft	3' 10"	9' 0"	10' 8"	9' 5½"	14' 0"	10' 10½"
Mean draft	3' 11"	7' 4½"	8' 1½"	8' 0"	12' 9"	9' 0¾"
Displacement in tons	215	865	1000	1660	2500	2157
Mean pressure per sq. ft. on sliding ways in tons	.57	1.37	1.40	1.89	2.51	1.9

Above table from Design and Construction of Ships, J. H. Biles.

U. S. Battleship "Arizona," 600 ft. water line, 97 ft. beam, launching weight exclusive of cradle and ways 12,800 tons, total weight on grease 13,350 tons, sliding ways and cradle 70 ins. wide, effective length 505 ft., initial pressure per square foot on the grease 2.27 tons, maximum observed velocity 21 ft. per second, was afloat in about 42 seconds.

Freight steamer "Chokyu Maru," 277 ft. 7 ins. O. A., 268 ft. between perpendiculars, beam molded 40 ft. 9 ins., depth molded 23 ft. 6 ins.; draft loaded 19 ft. 9¼ ins., designed displacement 4887 tons, dead-weight 3067 tons, engine  $\frac{19 \times 31\frac{1}{2} \times 52}{39}$ , i. h. p. 1060, speed 11 knots.

Declivity of keel blocks.....	1/17
Declivity of launching ways.....	1/16
Length of sliding ways.....	217 ft.
Width of sliding ways.....	1 ft. 9 ins.
Width of standing ways.....	2 ft.
Center to center of sliding ways.....	14 ft. 6 ins.
Average pressure on standing ways.....	1.35 tons
Maximum pressure on fore poppet when the stern lifted.....	315 tons
Height of water at the end of standing way.....	5 ft. 6 ins.
Launching speed.....	16.2 ft. per min.
Launching weight, including cradles.....	1033 tons
Average draft when afloat.....	4 ft. 7½ ins.
Displacement when afloat.....	971 tons
Center of gravity of the hull and cradles, .83 ft. aft amidships	

## DECLIVITY OF WAYS AND LAUNCHING VELOCITY

Length of Vessel in Feet	Launching Weight in Tons	Declivity of Ways per Foot	Declivity of Keel per Foot	Camber of Ways	Launching Velocity Feet per Second
200	200	$\frac{3}{4}$	$\frac{1}{8}$	none	12 to 13
280	1,000	$\frac{1}{4}$	$\frac{1}{2}$	6 ins. in 300 ft.	15 to 17
300	2,200	$\frac{1}{8}$	$\frac{1}{8}$	9 ins. in 400 ft.	18
430	4,000	$\frac{1}{2}$	$\frac{1}{2}$		
460	5,000	$\frac{1}{2}$	$\frac{1}{8}$		
500	7,000	$\frac{1}{8}$	$\frac{1}{8}$	14 ins. in 560 ft.	16



## SECTION V

### HULL CONSTRUCTION

#### CLASSIFICATION SOCIETIES AND ORGANIZATIONS GOVERNING SHIPPING

Merchant vessels are built and maintained under the rules prescribed by any of the following societies: Lloyd's Register, American Bureau of Shipping, British Corporation, Bureau Veritas, and Norske Veritas. By so doing the owner can get more favorable insurance rates than if his vessel had not been constructed and was not kept up to the requirements of one of the above societies. Motor boats, that is, small pleasure and commercial craft, are not built according to any rules, and are consequently not classed.

Lloyd's Register of Shipping, founded in 1760, is the largest and oldest society. Its head office is in London, England, with branches all over the world. In the case of a new vessel intended for classification, the plans are first submitted to be approved by the Committee and the building proceeds under the supervision of a local surveyor. No steel is used which has not been produced at approved works and tested at the works by the surveyors. When completed a character is assigned to the vessel by the Committee upon the surveyor's report.

Vessels built according to Lloyd's Register and classed with the Society are required at intervals of four years to be given special surveys. These surveys are designated as Nos. 1, 2, and 3, and as long as the vessel maintains her structural strength she keeps her class.

Lloyd's Register issues annually to its subscribers a register book containing particulars of all seagoing vessels of 100 tons and upwards, including those to which classes have been assigned. The figure 1 after the character assigned to a vessel thus, 100 A 1, denotes that her equipment is in good condition and in accordance with the rules of the Society. The star or cross before the figure denotes that the vessel was built under special survey. If the engines and boilers were built and installed according to the rules, then it is

registered thus in the book  $\nabla$  L M C. The highest rating is  $\nabla$  100 A 1  $\nabla$  L M C.

Lloyd's, the headquarters of the British Underwriters (an organization entirely separate from Lloyd's Register of Shipping), was incorporated by act of Parliament in 1871, for the carrying on of the business of marine insurance by members of the Society. It comprises about 600 underwriting members and about 200 non-underwriting members, besides some 500 annual subscribers. The underwriters pay a large entrance fee and an annual subscription, and to place their credit beyond a doubt, they are required to deposit as a minimum \$25,000 as security with the Committee of Lloyd's. A primary object of the society is the protection of the interests of members in respect of shipping, cargoes and freight.

By no means the least important function of Lloyd's is "the collection and diffusion of intelligence and information bearing on shipping matters." It has agents all over the world, but these agents are not insurance agents; in fact they are strictly forbidden to act as such. Their duties may be broadly defined as follows: In case of shipwreck to render to masters of vessels, of which there are over 40,000 certificates in the British mercantile marine, any advice or assistance they may require. Moreover they are required to dispatch every item of information likely to be of interest to the members of Lloyd's by the most expeditious route, telegraphic or otherwise, during the day or night, Sunday and weekday. It is thus that Lloyd's is enabled to compile and print and issue numerous large and instructive books and pamphlets.

**American Bureau of Shipping.**—This society was incorporated by Act of the Legislature of the State of New York in 1862, for the purpose of collecting and disseminating information upon subjects of marine or commercial interest, of encouraging and advancing worthy and well qualified commanders and other officers of vessels in the merchant service, of ascertaining and certifying the qualifications of such persons as shall apply to be recommended as such commanders or officers, and of promoting the security of life and property on the seas. Home office in New York.

**Vessels built in conformity with the American Bureau of Shipping Rules and under its inspection are classed thus:**

First Class A 1 for 20 years.

Second Class A 1 for 16 years.

Third Class A 1 for 12 years.

If built under special survey there is a prefix +. If the machinery passes the requirements it is indicated in the registry book of the society as M. C.

**British Corporation.**—The British Corporation for the Survey and Registry of Shipping was founded in 1890 for the purpose of providing for the classification of steel ships and the registration of vessels classed with the Society, and was appointed by the Board of Trade (English) to approve and certify load lines under the Merchant Shipping Acts.

The registry is under the control of the Committee of Management which is composed of shipowners, engineers, shipbuilders and representatives of underwriting and other associations, and is incorporated under articles of association wherein provision is made that the funds of the Society cannot become a source of profit to any member or to any person claiming through any member of the corporation. The head office is in Glasgow, Scotland.

In the **British Corporation Rules**, items of longitudinal strength have their scantlings determined by the length of the vessel in conjunction with either breadth or depth. Items of transverse strength have their scantlings determined by length or breadth, or both combined, no numbers being used, the dimensions alone determining the scantlings. For example, a vessel 400 ft. long requires twenty-five fortieths of shell plating. Vessels built under these rules and surveys are classed B. S.\* If not under survey but under the rules they may be classed B. S. There is only one class and not several, as 100 A 1, 100 A, etc., as in Lloyd's. The machinery requirements are confirmed with the letters M. B. S. The highest class a steamer can receive is B. S.\* M. B. S.\*

**Bureau Veritas.**—This Society has been recognized in France by decree of the Minister of Marine Sept. 5, 1908, for carrying out the law of April 10, 1907, regarding the safety of marine navigation. Vessels holding the highest class of the Bureau Veritas are exempt, in obtaining permits of navigation, from examination and tests in connection with the hulls, engines, and boilers and their accessories; that is to say, on points which are covered by the surveys prescribed in the present classification rules.

The Bureau Veritas British Committee has been delegated by the Board of Trade in conformity with the Merchant Shipping Act of 1894 to assign and mark load lines on their behalf on British vessels, also on vessels of other nationalities trading to British

ports and which are not provided with freeboard certificates and its marks are recognized as equivalent to British requirements.

Vessels are divided into three divisions, viz., I, II, and III. In order to retain their class, vessels must be subjected to the inspection of a surveyor to the Bureau Veritas at the following periods:

Vessels of the I division every 4 years.

II division every 3 years.

III division every 3 years.

The large I denotes first division classification (out of three). Two rings around the  $\textcircled{I}$  indicate that the ship is divided into a sufficient number of watertight compartments so she will float with any two in communication with the sea. Very few vessels have the double ring, but some have the single ring  $\textcircled{I}$ , indicating they can float with any one compartment in communication with the sea.  $\frac{3}{4}$  denotes completeness and efficiency of hull and machinery; the letter following  $\frac{3}{4}$  indicates the navigation for which the vessel is intended for. The first I shows that the wood parts of the hull are entirely satisfactory and the second I refers to the masts, spars, rigging, anchors, chains and boats. Thus a vessel built to the highest class would be given the following characters +  $\textcircled{I}$   $\frac{3}{4}$  L I I.

**Norske Veritas.**—This Society was established in 1864 by various marine insurance clubs of Norway, who prior to its establishment had separate surveyors of their own. A large number of Norwegian vessels are built according to the rules of this society. I A I denotes compliance with the rules in regards the hull. M & K. V. signifies that the boilers and engines comply. The third figure, I, denotes the efficient state of the equipment, and the + that the vessel was built under special survey. Thus a vessel built to the highest class would be registered thus + I A I I + M & K. V.

**Registro Nazionale Italiano** was formed in 1910 to take over the Registro Italiano which was founded in 1861. The society has adopted the rules of the British Corporation, and has an arrangement with the British Corporation by which it can use the services of that society in British and foreign ports.

**Great Lakes Register.**—Rules under which steamers to ply on the Great Lakes, North America, are built.

**Board of Trade.**—Although not a classification society, yet the Board of Trade is the final authority on British marine matters. The Board of Trade gets its authority from the Merchant Shipping

Act of 1894. It has passed regulations on many important subjects as freeboard, tonnage, bulkheads, etc. Referring to freeboard, it has published tables giving the freeboard of vessels, and has granted the right to assign freeboards to Lloyd's, Bureau Veritas, and the British Corporation.

**United States Steamboat-Inspection Service**, a part of the Department of Commerce with headquarters at Washington, D. C. It has inspectors at all the large shipping cities in the United States. Rules and regulations are published by it pertaining to the construction and inspection of boilers, lifeboats to be carried, wireless equipment, and other matters relating to the equipment and running of motor boats, sail and steam vessels.

### TYPES AND STRUCTURAL FEATURES OF MERCHANT VESSELS

The rules published by Lloyd's Register of Shipping, American Bureau of Shipping, Bureau Veritas, or other society, specify the size of the frames, beams and other structural members. In Lloyd's, for obtaining the scantling numeral which gives the sizes of the different members, the dimensions used are length (see page 166), molded breadth and depth, the latter varying with the type of vessel. In Bureau Veritas the same dimensions are used, but in the American Bureau of Shipping the half-breadth and half-girth are also included in making up the scantling numeral. The difference in the frames, beams, etc., for a vessel built according to any society is slight, but there is variance in the height of the bulkheads.

Broadly speaking, merchant vessels have their machinery amidships, the chief exceptions being tankers, colliers, and lumber carriers. They have double bottoms which are often utilized for carrying oil fuel and water ballast. For ships which have to make long voyages in ballast, top side tanks together with the usual double bottom give a good distribution of the ballast weights.

**Merchant vessels**, according to Lloyd's, can be divided into the following classes: shelter, awning and bridge deck, one, two, three, etc., deck vessels and sailing vessels. The only reduction allowed in the above by Lloyd's is in the shelter, awning and bridge deck classes. In all cases the uppermost continuous deck has the heaviest scantlings whether shelter deck or otherwise. Freeboard on these ships where there are no regular tonnage openings is practically the same as on a full scantling freighter.

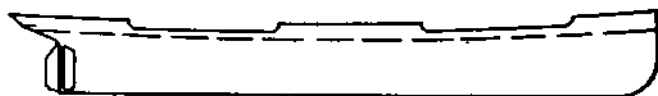

*Single Deck with poop, bridge & forecastle*

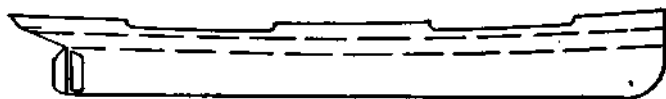

*Two Deck with poop, bridge & forecastle*

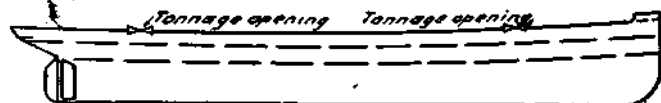

*Shelter Deck*

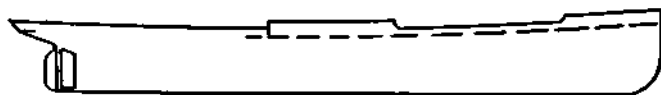

*Raised Quarter Deck*

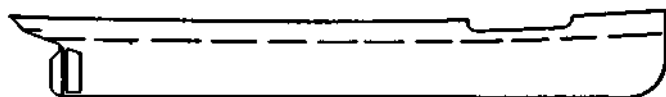

*Well Deck (single well)*



*Hurricane Deck for American coastwise, Pacific or S. American Trade*

Figure 35.—Types of Merchant Vessels.

**Shelter deck vessels** (see Fig. 35) are usually three deck vessels with a complete erection all fore and aft inclosed from the sea with the exception of a few openings for ease in loading and discharging cargoes. They have on the upper or shelter deck at the middle line one or more openings which are not fitted with permanent means of closing like ordinary covered hatchways.

A shelter deck as now constructed in large vessels is a superstructure extending all fore and aft. The peculiar feature is, that the 'tween-deck space it incloses is not included in the vessel's register tonnage, this omission being allowed by the existing British tonnage laws on the condition that somewhere in the deck there is an opening with no permanent means of closing it, and that no part of the 'tween-deck space is partitioned off or closed in a permanent manner. The necessary opening, referred to as the tonnage opening, may be formed by one of the hatchways, usually the after one which may or may not have coamings, but it must not have any permanent means of being closed. Sometimes a special hatchway is provided about 4 ft. long by half the beam of the ship.

Shelter deck vessels built to Lloyd's must have the strength members carried to the level of the shelter deck. When there are no tonnage openings the vessel may be loaded proportionately to the structural efficiency of the upper works. When there are tonnage openings in the shelter deck and transverse bulkheads are located in the 'tween-decks closely adjacent to the openings, the freeboard has been approximated to that of the normal awning deck vessel. Shelter deckers are largely used for carrying cattle, and also as bulk oil carriers. See Fig. 40.

**One, two, three, etc., deckers** have no awning or shelter decks with tonnage openings but continuous decks. These vessels have the heaviest scantlings of any built, and are designed to engage in ocean trading with the minimum amount of freeboard.

**Sailing Vessels.**—Here special attention is given to the transverse strength, heavy webs being fitted in way of the masts. The shell plating is increased .10 in. when the longitudinal number exceeds 11,000 and when the number is over 13,000 three strakes at the bilge are increased .06 in. Other special stiffening in the shape of diagonal tie plates in way of the masts and special panting stringers at the ends.

**Hurricane deck vessel** is an American term of a type built to the rules of the American Bureau of Shipping. This type is divided into two classes, viz., one for engaging in the transatlantic and

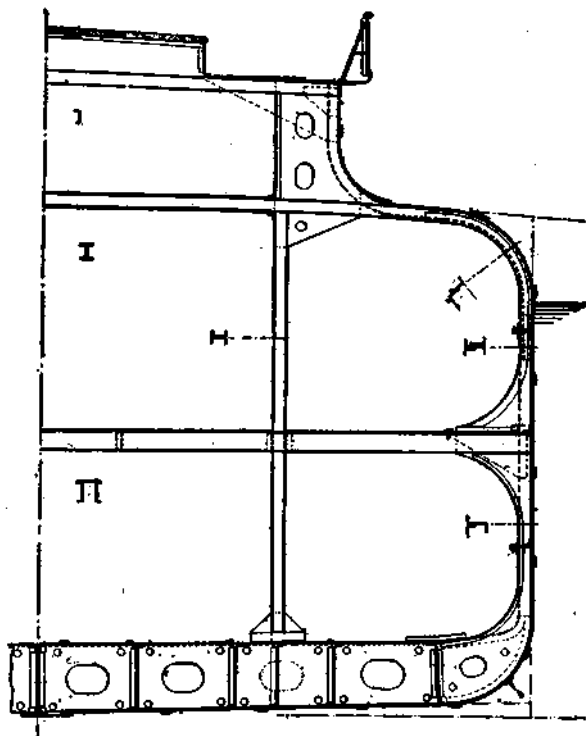

Figure 36.—Midship Section of a Turret Vessel.

general ocean trade (corresponding in many respects to Lloyd's shelter deckers except in the heights of the bulkheads) and the other for engaging in the coastwise trade, as from New York to New Orleans, the latter having lighter scantlings than the former. In all hurricane deckers, the depth is taken from the top of the keel to the top of the second deck beam amidships at middle line, and the collision bulkhead extends only to the second deck.

The important difference between the two classes is in the framing. Vessels built for the transatlantic trade have all their frames extend to the hurricane deck, while those for the coastwise extend alternately to the second and hurricane decks except for one-sixth of the length from the bow where every frame extends to the hurri-



cane deck, but in no case need this exceed 60 ft. As to the reverse frames for the transatlantic they extend to the under side of the hurricane deck stringer, and for the coastwise for a certain length alternately to the hurricane deck.

**Raised Quarter Deck.**—Here (see Fig. 35) the main deck is raised 3 ft. for vessels up to 100 ft. in length, 4 ft. up to 250 ft. and 6 ft. up to 400 ft. Although it is customary to speak of the raised quarter deck being above the main deck, yet neither plates nor beams are fitted at the main deck immediately under the raised quarter deck except for a short distance at the forward end or at the "break," as it is often called. Practically what has been done is to raise up the main deck for part of its length. This construction is particularly suitable for vessels of about 250 ft., where the machinery is amidships, for it gives additional space in the after hold (which

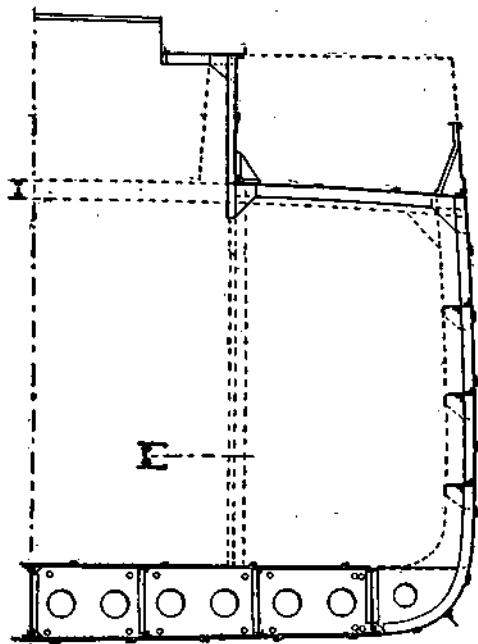

Figure 37.—Midship Section of a Trunk Vessel.

is often limited by the shaft tunnel) and thereby prevents a steamer from trimming by the head, as the after hold is larger than the forward.

**Turret Vessels.**—See Fig. 36. These were originally designed to save tonnage under the Suez Canal system of measurement. They are popular in the Far East trade and are relatively stronger than the ordinary ship of the same dimensions owing to the turret sides.

They have a continuous center turret which forms with the harbor deck an integral part of the hull. They are built without sheer, and may have on the top of the turret deck erections as poop, bridge, and forecastle, or such erections may be on the harbor deck, but in this case the turret must be continuous from the poop to the forecastle into which it is scarped. Cutting away the outboard parts of the upper 'tween-decks served the double purposes of reducing the tonnage measurement and port charges, and providing a center trunk that served as an expansion chamber and made the vessels self-trimming when loaded with grain or similar cargoes. They are inferior in stability to the usual type when heeled to an excessive angle.

**Trunk Vessels.**—These (see Fig. 37) are a modification of turret vessels and are of the heaviest type. They have on the upper deck, in addition to the poop, bridge, and forecastle, a continuous trunk.

## WAR VESSELS

The war in Europe (1914- ) showed particularly the advantages of certain types of war vessels, viz., submarines, torpedo boat destroyers, and battleships, while others which were at one time looked upon as important have proved to be of little use. With no intention of discussing the advantages and disadvantages of every type, yet there stand out preëminently submarines for preying on merchant vessels, torpedo boat destroyers for patrol purposes and to war on submarines, and battleships for shelling land fortifications while troops are landing. Modern sea fights between armored ships are fought at ranges of 3 or more miles, the guns in many cases being elevated so projectiles will drop on the decks, thus causing more damage than if fired directly at the sides which are heavily protected by armor.

Aside from the special types of construction for the different classes, there should be noted the method of propulsion and the fuels.

Referring to the former there has been a notable use of steam turbines either driving the propellers direct or by gears; or the turbines may be connected to generators which furnish current to electric motors that propel the vessel. See Electric Propulsion.

Operating conditions for war vessels are different from those of merchant. In war vessels it may be necessary to drive the vessel at maximum speed at a very short notice, hence the importance of water tube boilers for raising steam quickly. Then again a warship must have machinery that is economical in the consumption of fuel for long distance cruising. Diesel engines have been installed chiefly in submarines. As to fuels, many warships are equipped for either coal or oil. The chief advantages of oil being that it is easier to stow and contains more heat units per pound, thus giving a larger steaming radius.

In the United States Navy all large vessels are framed on the longitudinal system (this does not mean on the Isherwood system), the keel being continuous as also the fore and aft members on either side called longitudinals, while the frames are intercostal. This system of framing is carried out from the keel to the protective deck including the inner bottom which extends as far forward and aft as possible. Above the protective deck the transverse members are continuous. Forward and aft of the inner bottom the frames are continuous on both sides of the vertical keel and the longitudinals are intercostal between them.

In torpedo boats and small vessels having no inner bottoms the frames are continuous from keel to gunwale, and closely spaced to support the shell plating. Here the longitudinals are intercostal. No standard rules, as Lloyd's or British Corporation, are followed, the U. S. Navy Department, Admiralty, and the various Government Navy Departments drawing up their own plans and specifications.

**Armor.**—This may be divided into: (1) broadside extending fore and aft sufficiently to cover the ammunition rooms and the machinery space; (2) armored transverse bulkheads dividing the ship into watertight compartments; (3) armor around the large guns which are mounted in turrets; and (4) a protective deck.

The armor on the sides has a cement backing, back of which is the hull plating that in turn is reinforced with heavy frames. The armor is bolted to the hull by bolts screwed into the back of the armor. The outer face is given a hard surface while the rear has a much softer one and possesses different properties. The manu-

facture of a plate either by the Harvey or Krupp process requires great care and from 4 to 9 months, depending on the thickness. Plates made by either process are alike; that is, they have a hard outer surface to resist the penetration of a projectile and a tough back to prevent the shattering of the plate by the impact. The turret and barbette armor are supported by heavy structural shapes and plates.

The protective deck consists of special treated steel plates about  $2\frac{1}{2}$  ins. thick that slope upwards from the sides of the vessel to a flat portion amidships or the deck may extend straight to the shell plating. See Fig. 38. This deck serves to protect the machinery and other parts below it.

As an example of the armor of a battleship take the U. S. battleship *Nevada*, one of the latest types (1916). The main armor belt is  $13\frac{1}{2}$  ins. thick from its top to 2 ft. below the designed water line, whence it is tapered uniformly to 8 ins. at the bottom. Aft of the main belt the armor is 13 ins. The forward athwartship armor and aftermost armor bulkhead is 13 ins. The barbettes are 13 and  $4\frac{1}{2}$  ins. thick, the latter being amidships and out of reach of the guns of the enemy. There are 4 turrets, 2 having 3 guns each, and the other 2 having 2. The 3-gun turrets have 18- and 9-inch armor and the 2-gun, 16 and 9. The armor is of the Krupp type. There is also a protective deck.

**Armament.**—Under this heading are included the guns ranging from the 15-inch mounted in the turrets of battleships to light saluting guns and also torpedoes. Naval engagements are now fought at long ranges and this is due to the development of the modern high-powered gun, which brought about the building of the all big gun or Dreadnaught type of battleship.

In the British Navy, 15-inch guns have been installed (Royal Sovereign class, 10 15-in., 18 6-in., 12 3-in. or 12-pounders) while the largest in the United States (1916) is 14 in., altho battleships designed to carry 16-in. guns have been authorized. A popular British gun is the 9.2 and a U. S. is the 6-inch, which are largely to repel the attacks of torpedo boats and submarines.

The ammunition is either loose, that is, the powder and the projectile are put in the gun separate, or fixed, the powder being in a brass case to which the projectile is fastened. Guns 5 ins. and over generally use loose ammunition. On some battleships 14-inch guns are mounted, firing a projectile weighing about 1,200 lb. and requiring 500 lb. of powder. The powder and projectiles are

stored in ammunition rooms and are brought up to the men operating the gun by hoists driven by electric motors or through tubes operated by compressed air. The guns in the turret are raised and lowered and the turret turned by electric motors, the turret with its armor and guns resting on rollers. Guns using fixed ammunition are divided into rapid fire, semi-automatic and automatic.

Torpedo tubes are of two types, one where the tubes are on deck and the other where they are below the water line, the former for torpedo boats and the latter for submarines, cruisers, and large war vessels. The torpedoes are discharged from the deck tubes by

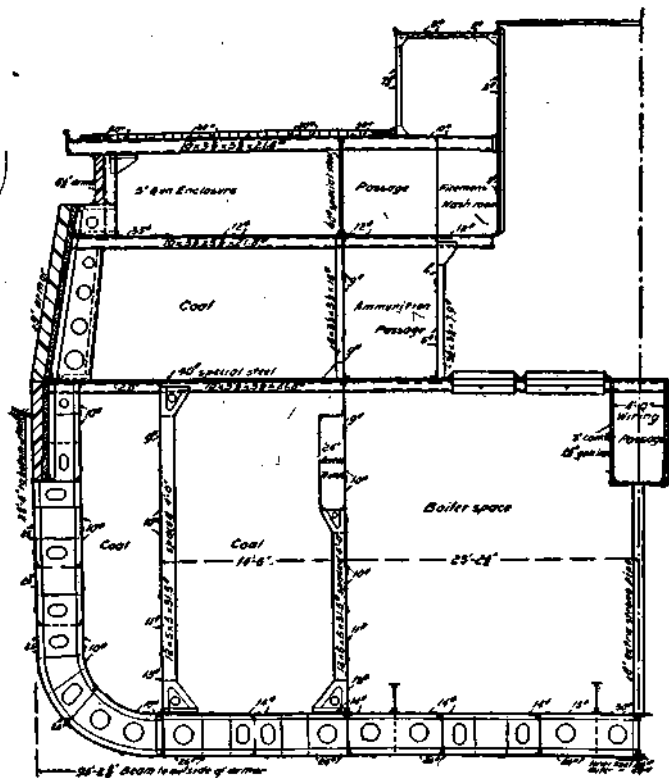

Figure 35.—Midship Section of a Battleship.

a small charge of powder, but after they have cleared the tube and the side of the vessel they travel by their own motive power operated by compressed air. The driving mechanism for keeping the torpedo in a straight line and at a given distance from the surface is very complicated. At the front is the warhead, which contains the high explosive (generally gun cotton) that is discharged when the torpedo strikes a ship. Torpedoes are 20 feet or more long, 20 ins. or so in diameter and have a range of 2 or more miles. Deck torpedo tubes are now mounted in pairs, the two tubes being placed side by side. Torpedoes from underwater tubes, as fitted on submarines and other war vessels, are discharged by compressed air, the pressure being about 1,200 to 1,800 lb. per square inch. The range and when to fire are given from the central station.

Warships may be divided into the following classes:\*

**Battleships.**—Designed to fight the most powerful ships of an adversary and thus having the heaviest armor and armament. Displacement 11,000 to 40,000 tons, speed 16 to 25 knots. The term "Dreadnaught" is often applied to a modern battleship, which simply means that she has four or more turrets with at least 13-inch guns, with a secondary battery of 5- or 6-inch. In the United States Navy the large guns are in turrets located on the fore and aft center line, while in some European countries the turrets are on each side (port and starboard). In some U. S. battleships having four turrets, two turrets have three guns each, and the other two, two guns. In the four battleships authorized in 1916, each will have a main battery of 8 16-in., 45 cal. guns. As to armor this is the heaviest carried by any vessel; in fact the weight of the armor is about 26% of the displacement. The following table gives fair values of the weights of armor, hull, etc., of a battleship.

Item	Weight as Percentage of Total Displacement
Hull.....	35.0
Armor.....	26.0
Armament.....	19.0
Propelling Machinery.....	10.5
Coal.....	5.5
General Equipment.....	4.0
	100.0

\* This division based on one in Naval Construction, by R. H. M. Robinson.

English battleships are fitted with torpedo nets as a protection against torpedoes when at anchor. One of the latest types of U. S. battleships is the *Pennsylvania*, laid down in 1914. Length over all 625 ft., water line 600 ft., beam 97 ft., draft 28 ft. 10 ins., normal displacement 31,400 tons, turbines 31,500 h. p., speed 21 knots, oil fuel only. Has 12 14-inch guns (3 in each turret), 22 5-inch, 4 3-pounders, 4 21-inch submerged torpedo tubes, 16-inch armor belt amidships. One of the latest (1915) English battleships, viz., the *Royal Sovereign*, has 15-inch guns. Length 630 ft., beam 95 ft., displacement 29,000 tons, turbines 44,000 h. p., speed 22.5 knots, bunkers 4,000 tons of coal. Ten 15-inch guns, 16 6-inch, 12 12-pounders, 5 torpedo tubes, armor belt 13½ ins., protective deck, 3 ins.

**Battle Cruisers or Armored Cruisers.**—Expected to do some advance duty, but capable of taking position in line with battleships. Have a displacement equal to a battleship, carry heavy guns with lighter armor but have a speed of 22 to 31 knots. In many instances it is difficult to distinguish between an armored or battle cruiser and a battleship. A typical example is the *Tiger* (Great Britain) laid down in 1913. She is 725 ft. over all, 87 ft. beam, maximum draft 30 ft., displacement normal 27,000 tons, full load 31,000, complement 1,000 men, turbines of 75,000 h. p., speed 27 knots, coal normal 1,000 tons, maximum 3,500 plus 1,000 tons of oil. Has 8 13.5-inch guns, 16 4-inch, 2 submerged torpedo tubes on broadside and 1 at stern, 9-inch belt amidships, 4 ins. at ends.

**Monitors.**—For coast and harbor defense, are now obsolete. Had a single turret with 12-inch guns and a secondary battery of 6- and 4-inch, small freeboard and low speed. U. S. *Ozark* (1900), 253 ft. water line, 50 ft. beam, 12 ft. 6 ins. draft, displacement full load 3,356 tons. Two 12-inch guns, 4 4-inch, 3 6-pounders, armor belt amidships 11 ins., at ends 5 ins., speed about 11 knots.

**Light Cruisers.**—These include cruisers with light side armor of 2 or 3 ins. and with a protective deck, and those without any side armor and with only a protective deck. The heaviest gun usually carried is a 6-inch. Light cruisers range from about 3,000 to 10,000 tons displacement, are speedy and are primarily for preying on merchant vessels, while in times of peace they are largely used for official business, such as representing their Government at a celebration at a foreign port. Below are descriptions of two light cruisers, one with side armor and the other without. *Nottingham*,

British (1914), 430 ft. between perpendiculars, 49 ft. 10 ins. beam, displacement 5,400 tons, Yarrow boilers, Parsons turbines of 22,000 h. p., speed 24.75 knots, coal 650 tons, can also carry oil, 9 6-in. guns, 4 3-pounders, 2 21-inch submerged torpedo tubes, 2-in. side armor, 2-in. protective deck. *Yarmouth*, British (1912), 430 ft. between perpendiculars, 48 ft. 6 ins. beam, mean draft 15 ft. 3 ins., Yarrow boilers, Curtis turbines 24,000 h. p., speed 26 knots, normal coal 750 tons, 8 6-in. guns, 4 3-pounders, 2 21-in. submerged torpedo tubes, 2-in. protective deck.

**Scouts.**—These are seagoing high speed vessels for finding out the position of an enemy's fleet. They are lightly built and the guns carried are of small sizes. They have no armor and everything has been subordinated to produce a fast seagoing vessel. U. S. *Chester* (1905), 420 ft. water line, 47 ft. 1 in. beam, 16 ft. 9 in. draft, displacement 3,750 tons, 4 screws, turbines of total 16,000 h. p., speed 26 knots, bunkers 1,250 tons. Two 5-in. guns, 6 3-inch, 2 3-pounders, 2 21-in. torpedo tubes.

**Gunboats.**—Small light draft vessels for use on shallow rivers and bays. Their displacement is seldom over 1,700 tons, and they have a speed of around 14 knots. U. S. *Paducah*, 174 ft. water line, 35 ft. beam, draft 13 ft. 6 ins., twin screw with a total of 1,000 h. p., speed 12.9 knots, coal normal 100 tons, maximum 236, displacement 1,085 tons. Six 4-in. guns, 4 6-pounders, 2 1-pounders.

**Torpedo Boats.**—About 170 ft. long, 80 to 180 tons displacement, lightly built, with a few small guns mounted, and carrying two or more torpedo tubes. Have a speed of 28 knots or better, many using oil fuel and being driven by turbines. Of recent years, owing to the development of submarines, torpedo boats have been little used for the purpose they were originally intended for, viz., discharging torpedoes at larger war vessels and then running away. As a class few are now being built. British torpedo boat (1906), 172 ft. long, 18 ft. beam, 5 ft. 3 ins. mean draft, Parsons turbines, 3 screws, total 3,750 h. p., speed 26 knots, Yarrow boilers, oil fuel, normal 20 tons, 2 12-pounders, 3 18-in. deck torpedo tubes.

**Torpedo Boat Destroyers.**—Larger and more powerful than torpedo boats, carrying heavier guns. Are primarily designed to destroy torpedo boats, are seagoing, and have a large radius of action. Many of the latest types use oil for fuel, and are driven by steam turbines. Make good patrol boats and during the European War proved of great value in destroying submarines; for on account of their speed it is difficult for a submarine to escape when once sighted.



Geared turbines were installed in the U. S. torpedo boat destroyer *Wadsworth*, which went in commission in 1915. There are 4 ahead turbines (Parsons) driving by gears, 2 shafts, while for going astern there are two other turbines that revolve in a vacuum when the destroyer is going astern. The *Wadsworth* made 33 knots on trial. She is 310 ft. long on water line, 29 ft. 8 ins. beam, mean draft 9 ft. 4½ ins., block coefficient .44, displacement 1,050 tons, turbine 17,500 s. h. p., high pressure turbine 2,495 revs. per min., low pressure 1,500, geared down to 450, propellers 7 ft. 7¾ ins. dia., pitch 8 ft. 7½ ins., oil burned per knot at speed of 30.72 knots 507 lb., water per s. h. p., 11.19 lb., carries four 4-in. rapid fire guns and four 21-in. twin torpedo tubes. Direct drive turbines are installed on many destroyers.

**Submarines.**—The war in Europe (1914–) has shown the damage these craft can do. At first they were only experimental affairs, but now they are seagoing, with a radius of operation of 3,000 to 8,000 miles or more, and speeds of 14 knots or better per hour when running on the surface and 8 or more when submerged. When running on the surface they are driven by Diesel engines, and when submerged, by storage batteries furnishing current to electric motors. Besides being armed with submerged torpedo tubes, the latest types have guns, some one or two three-inch.

The hull may be either single or double. In the former the main ballast tanks are located within a strong outer hull, which in section is in the main part circular or nearly so, with elliptical sections forward and aft. In the double hull there is a more or less complete, strong, pressure-resisting internal hull, which is surrounded by an external hull of lighter construction, the greater part of the water ballast being in the space between the two hulls. The single hull is represented by the Holland and Lake types as in the United States, British, and German navies, and the double hull by the Laubeuf. Horizontal rudders are usually fitted at the bow and stern, and are sometimes combined with one or more sets of inclining planes. In submerging the bow is always slightly depressed. The reserve buoyancy varies from 25 to 40%.

Of the types in the United States Navy are the Holland (built by the Electric Boat Co.) and the Lake (built by the Lake Submarine Boat Co.). In the former the hull proper is circular in cross section, on the top of which is built a superstructure, the water being allowed to enter and leave it of its own accord, and having nothing to do with the trimming. The superstructure is a con-

## SUBMARINES

Particulars	U. S. K Class	Eng- lish D	French Bru- maire	U. S. <sup>1</sup>	Eng- lish E	German U-33 to U-42
Length.....	153' 4"	150'	.....	230' 6"	175'	223'
Surface displacement, tons.....	389	550	400	663	730	665
Submerged displacement, tons.....	519	615	550	912	825	822
Engines.....	Diesel	Diesel	Diesel	Diesel	Diesel	Diesel
Horse power, surface.....	900	1200	850	2000	1600	2300
Speed, surface, knots.....	14	14	13	17	15-16	17
Speed, submerged, knots.....	10½	8-9 <sup>a</sup>	9	10¾	9-10	10
Armament, torpedo tubes.....	4	3	1	8	6 <sup>a</sup>	5 <sup>a</sup>
Armament, guns.....	.....	.....	.....	.....	2	2

<sup>1</sup>A late design of the Electric Boat Co. <sup>a</sup>Doubtful. From paper by L. Y. Spear, published in Trans. Am. Soc. of N. A., 1915.

venient means for handling the submarine when coming alongside a pier. There is a common tank at the lower part along the keel into which the various tanks drain, and from this common tank the water is discharged should the submarine desire to come to the surface. In some instances the water is pumped out and in others forced out by compressed air, the latter being the quickest but most expensive. With all deck fittings fast it takes about 2½ minutes for a submarine to get under the surface traveling at ¾ speed.

The crew depend for air for breathing while submerged on the free air in the submarine at the time of submerging and on the compressed air carried in the storage flasks, which is used in freeing ballast tanks of water as well as for breathing. In the average submarine at the present writing (1917) the air contained at the time of submerging is sufficient to last the officers and crew numbering say 18 men, from 9 to 12 hours. If the air from the storage flasks is used—the time may be increased from 30 to 36 hours. In computing the time, the safe C O<sub>2</sub> (carbon dioxide) that should be allowed to accumulate in the air at any time is taken at 2 per cent.

In general there are 2 or 3 pairs of rudders, the vertical ones for steering to port or starboard, and the horizontal ones for diving and rising, assisted by fins forward. In sinking the horizontal rudders are deflected when under way, water also being taken into the tanks. To come to the surface the horizontal rudders are inclined and the water is blown out of the tanks by compressed air.

In the latest Holland types (1916) there are fins on each side forward, that are extended when a torpedo is fired, tending to keep

the submarine on an even keel. Forward there are 5 separate tubes from which the torpedoes can be discharged. Over the ends of the tubes fits a cap that revolves so that a torpedo can be discharged from any tube.

The *Lake* submarine has a single hull, with tanks along the keel and also on both sides at the top, the top plating of the tanks thus forming a flat deck. There are 4 fins, 2 on each side forward and the same number aft for steadying when discharging a torpedo and keeping the submarine on a level keel. On some there is a small vertical rudder aft extending above the deck, besides the one aft of the propeller.

When running below the surface, by means of a periscope extending above the water the positions of other vessels are reflected so they can be seen by the navigator of the submarine. One of the latest models consists of a tube with lenses and at the bottom a binocular eye-piece into which the navigator looks. The periscope is only for daylight navigation, for when dusk comes it is useless. The passing of the image through the various lenses and prisms reduces the brilliancy to such an extent that even if it is magnified to above normal the image is so thin it cannot be seen. This forces the submarine to become vulnerable in making an attack at night, as it is necessary for the conning tower to be brought a sufficient distance above the surface of the water for the commanding officer to secure natural vision.

Recent practice is towards building two classes of submarines; one about 100 feet or so in length, with a comparatively small radius of action, for harbor defense only, and the other of 200 to 300 feet, that can proceed to sea with the fleet and only have to return at long intervals to the home port.

**Submarine Chasers.**—These are small seagoing high speed boats, carrying 2 or more small guns, and are primarily designed to harass and destroy submarines. On account of their size and ability to maneuver quickly they are difficult to hit with a torpedo, and with their speed they can follow the wake of a submarine when one is running submerged, and should the submarine attempt to come to the surface the chaser opens fire on her.

Several were built in the United States in 1915, and below are particulars of one of ten for the Russian Government. Sixty ft. long, 10 ft. beam, 2 ft. 10 ins. draft, V-bottom construction with the floors flattened aft, oak frames, one-inch cedar planking, 4 steel watertight bulkheads, 3 gasoline (petrol) motors each of 175 h. p.,

guaranteed speed 26.1 miles per hour, actually made 28, fuel carried in four 270-gallon tanks, total 1080 gallons, cruising radius at 26 miles an hour 500 to 600 miles, accommodations for 6 men and 2 officers; has 2 rudders, steel deck house forward for pilot, 2 small guns. The United States authorized the building of several in 1917, 110 ft. long.

**Auxiliaries.**—These include colliers, repair ships, supply ships, and tenders for submarines. They do not carry heavy guns, but may have a few small ones to repel torpedo boat and submarine attacks. Many are converted merchant vessels, while others are specially designed for the service in which they are to be used.

## STRUCTURAL DETAILS

**Systems of Construction.**—There are two systems for merchant vessels, viz., the transverse as shown in Fig. 39, following Lloyd's or other societies' rules, and the longitudinal or Isherwood as in Fig. 40. The former has a large number of comparatively small frames closely spaced, connected by brackets to beams thus forming a complete section. Broadly speaking these transverse sections are the fundamental strength members, but to obtain the requisite fore and aft strength, keelsons, longitudinals, and stringers are necessary. See paragraphs on these subjects as also on Frames. The transverse system has been universally adopted, although for oil carriers and steamers for grain and coal the longitudinal has been used mostly in late years.

In the longitudinal or Isherwood system the transverse frames and beams are at widely spaced intervals, the average distance being about 12 ft. These heavy frames form complete belts around the ship. They are riveted to the shell plating and deck, and are made of not less strength than the number of transverse frames that are fitted in ordinary vessels for corresponding length of ship. These strong frames are slotted around their outer edges to admit of continuous longitudinal stiffeners or frames being fitted not only at the deck but on the sides, bottom, and under the tank top.

The longitudinal stiffeners, being riveted to the deck plating, prevent the plating from buckling, which has happened to transverse framed vessels having no fore and aft support to the plating between the beams. In vessels with double bottoms, transverse floor plates are fitted intermediate to those at the sides and decks. Bulb angles can be used as longitudinals under the tank top and on the

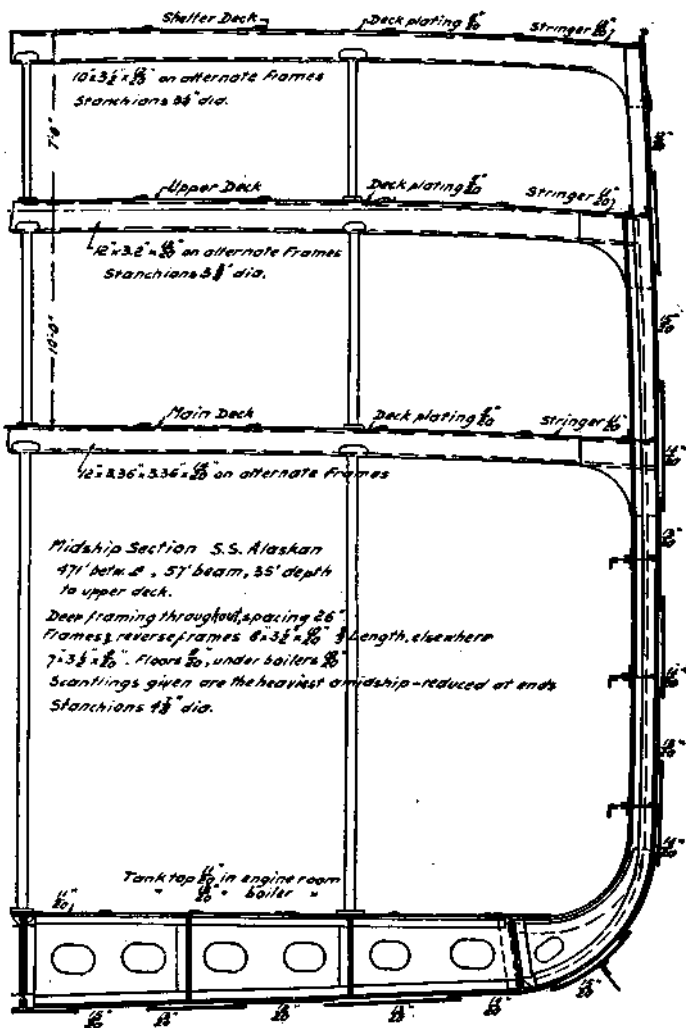

Figure 39.—Transverse System.

inside of the shell plating, thereby providing a double bottom which is easier of access than one built on the transverse system. See Fig. 40.

In the Isherwood system the inner bottom may extend to the skin of the ship whereas in a transverse framed ship it usually stops just before the lower turn of the bilge, leaving a space that is of no value for carrying cargo. Among the advantages claimed by the Isherwood system are increased longitudinal strength, increased deadweight carrying capacity, holds free from small pillars, and a reduction in the shell plating due to the increased longitudinal strength obtained by the fore and aft members.

The location and number of the bulkheads are the same irrespective of the system of construction. In the following paragraphs, excepting frames, keelsons, and those relating to transverse framing, the others, as shell plating, bulkheads, etc., in general apply to the longitudinal as well as to the transverse system.

**Framing.**—Until recent years iron and steel merchant vessels were framed on the transverse system, but in certain types, as bulk cargo and oil tankers, this has been replaced by the longitudinal or Isherwood system. The frames of a transverse framed steel ship vary in size and spacing according to the rules, viz., Lloyd's, American Bureau of Shipping, or other society, to which she is built. In Lloyd's rules the frames depend on the transverse number,  $B + D$ , which is the sum of the molded breadth  $B$  and the molded depth  $D$ , which is the depth at mid-length from top of keel to top of uppermost continuous deck, except in awning and shelter deck vessels, where it is taken to the deck next below the shelter deck provided the deck height does not exceed 8 ft., in which case it is taken to a point 8 ft. below the shelter deck. A second depth  $d$  has also to be considered in getting the size of the frames, this depth being measured from the top of the floors at the center in a single bottom ship, and from the margin plate at the side in a double bottom ship, to the top of the beams of the lowest laid deck or tier of beams at the side.

The frames vary in size from  $2\frac{1}{4} \times 2\frac{1}{4}$  angles to  $12 \times 4 \times 4$  channels, and in spacing from 20 to 33 ins. from heel to heel, while in peak tanks 24 ins., and one-fifth of the length forward to the collision bulkhead the spacing is not to exceed 27 ins.

The framing of a single bottom ship consists of a frame, reverse frame, and floor plate. The frame in this case usually extends in one length from the center line to the top deck. In deep framing

it is common practice to place a small angle at the lower edge of the floor plate overlapping the larger side frame at the bilge, and thus save weight. In most merchant vessels deep frames are used in conjunction with side stringers formed of plate and angle, thus giving a clear hold with unbroken stowage. These deep frames may be formed of two angles riveted together, but the more common is the equivalent bulb angle or channel section. Web frames and side stringers with small intermediate frames can also be used, but this construction is not much in favor on account of the interference with the cargo.

The toes of all frames forward of the midship section point aft, while those aft of the midship section have the heels aft and the toes forward. This gives open bevels and thus room for driving the rivets connecting the frames to the shell plating. The frames are in some instances joggled, in which case no liners are required even if the plating is worked in and out. In fact it is usual to joggle the frames for about three-fifths of the length amidships when they are not more than 10 ins. deep and thus save the weight of the frame liners. This makes a better job than joggling the plating which is apt to leak and work in a seaway. Joggled frames can be employed to advantage in the Isherwood system, as they are in rather short pieces, one template doing for a large number, the joggling being done cold.

Reverse frames extend from bilge to bilge doubled in engine and boiler rooms; where the framing is built up of frame and reverse frame they run up the frame above the bilge, depending on the depth *d* (see above).

The depth of the floor plates at the center line is governed by the same transverse number used for the frames. The floor plates are to be molded not less than one-half their depth at a point three-fourths the half-breadth of the vessel from the center line and to extend up the bilge in a fair curve terminating at a point on the frame not less than twice their midship depth at center line, this height to be maintained for one-fourth the vessel's length amidships; they may then be gradually lowered forward and aft until the upper edges are level; depending on the shape of the vessel from this point to the ends they may be gradually increased in depth to give better connection. In the engine room the floors must be increased .04 in. over the midship thickness and in the boiler room .10 in.

The above applies in general to vessels without double bottoms.

Double bottoms are usually built on the cellular system with solid floors either at every frame or on alternate frames, or other construction followed subject to the approval of the society to whose rules the vessel is being built. See also Double Bottom.

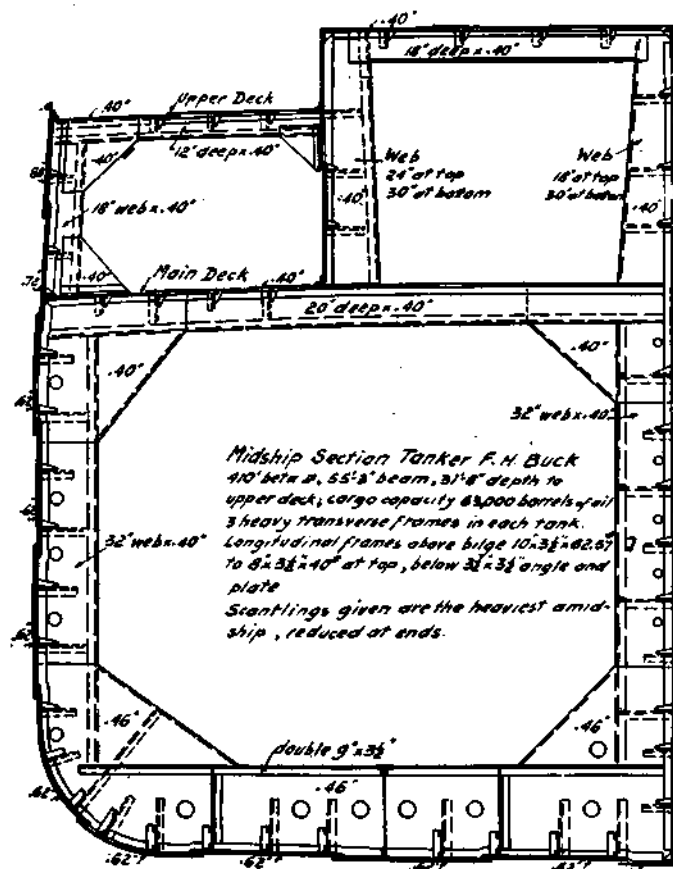

Figure 40.—Longitudinal or laborwood System.

Frames usually extend in one piece from the center line to the margin plate and if floors are on alternate frames heavier scantlings



are required for the intermediate frames. When the vessel's length exceeds 400 ft. solid floors are required at every frame and also in single deck vessels which exceed 26 ft. molded depth.

Reverse frames are generally in one length from the center line to the margin plate and doubled in the engine room to the girder or longitudinal next beyond the engine seating and under the boiler bearers. In double bottoms with floors at alternate frames the alternate reverse frames may be dispensed with provided the inner bottom plating be increased .04 in. in thickness. In the boiler room the floors are increased .10 in. When floors are on alternate frames bracket plates are to be fitted on alternate frames at the center line and at the margin plate, and additional girders are to be fitted under the engine seating.

A reduction in the thickness of the shell plating is allowed when solid floors are on every frame, provided the thickness does not exceed .66 in.

**Shell Plating.**—The shell plating may be worked as, in and out strakes, joggled, clinker, or flush as shown in Fig. 41. In and out strakes are largely adopted, the keel, bilge, and sheer strakes being made outside strakes for ease of removal in case of damage. When a vessel is so plated parallel liners are required between the frames and the out strakes. If the plating is joggled no liners are necessary, while in the clinker only tapered liners are needed. Flush plating calls for extensive lining and is chiefly for yachts for appearance' sake, as the liners materially add to the weight of the hull.

The widths of the plates selected should be as near as possible the same for all the strakes, thus making the plates interchangeable. The following table gives the maximum width of the shell plates according to Lloyd's rules.

Depth of Vessel in Feet	Maximum Breadth of Strake Plating in Inches
Not exceeding 20.....	54
Above 20, not exceeding 24.....	60
Above 24, not exceeding 28.....	66
Above 28.....	72

The widths are laid off on the midship frame of the body plan (one-half fore body and the other after body), and the plate lines sketched in, keeping the lines or sight edges parallel amidships

and tapered slightly at the ends above the water line, thus requiring as the stem and stern are approached the working in of stealers in the lower strakes, one stealer taking the place of two or more

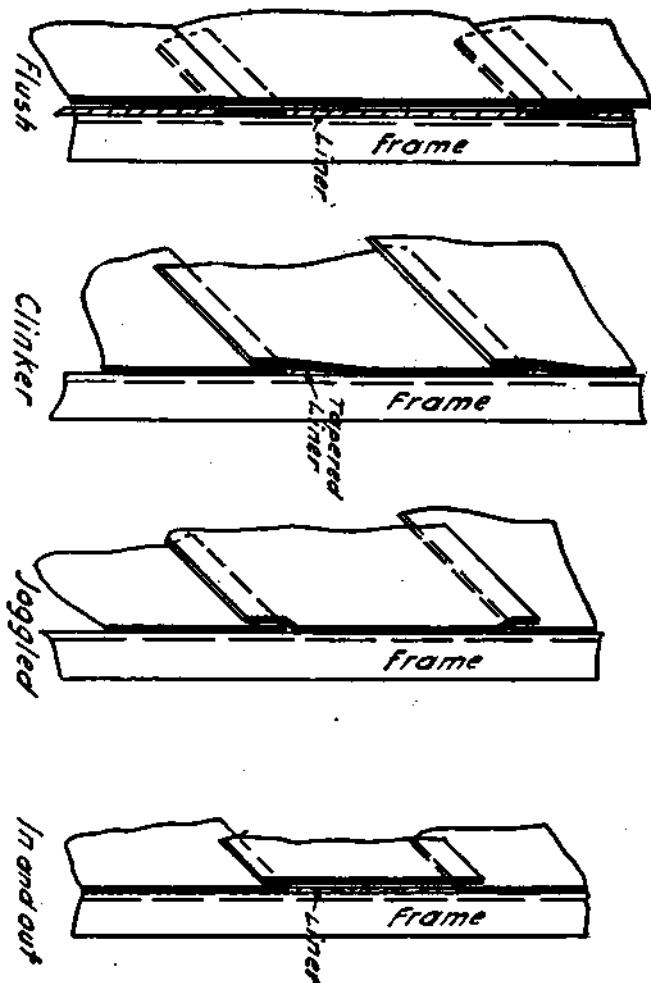

Figure 41.—Shell Plating.

narrow strakes of plating. In the after body the plating between the outer and sheer strake is divided into the same number of strakes and lines run in, stealers being employed where necessary. By so dividing the strakes, all the difficult work may be in one plate, that is, in the outer, instead of in several. The above procedure is followed in laying out the plating for a single screw vessel. In a twin, triple or quadruple screw the forebody is worked the same as for a single, but in the after body care must be taken in laying out the plating around the shaft tubes so the plates may be easily worked, short plates being selected for furnacing.

Coincident with the laying out of the shell plating on the body plan and the making of a drawing of the shell expansion, a model is made. In large vessels the plates may be 24 to 28 ft. in length, but care must be taken in selecting a length that can be easily handled. In ordering shell plates it is usual to take the widths from the mold loft and only the lengths from the model as this gives less scrap.

The thickness of the plating, sizes of laps and butts are given in the rules of the classification societies. In Lloyd's there is now no garboard strake except in the case of a vessel with a bar keel. Bottom and bilge plating all have the same thickness. In some large vessels the sheer strake is doubled for half the length amidships. The thickness of all the strakes is greatest amidships and is gradually reduced at the ends, although doubling plates are required around cargo ports, hawse pipes and other parts subject to excessive local stresses. When lap butts are selected the laps should face aft, so that when the vessel is moving alongside a pier no projecting parts will catch; and furthermore there is no resistance offered by them when the ship is moving through the water.

In laying out the shell plating a good shift of butts should be secured and they must not come in the same frame space as those of the keel, tank top plating, longitudinals or deck stringers. Lloyd's rules state: no butts of outside plating in adjoining strakes to be nearer each other than two frame spaces, and the butts of alternate strakes must not be under each other, but shifted not less than one frame space. The sheer strake must extend sufficiently above the upper deck ends to take at least two rows of rivets vertically in the butts above the upper flange of the gunwale bar.

All shell plates are flush riveted with perhaps the single exception of the sheer strake in large vessels where there are doubling plates,

in which case the riveting may be done by machine, the rivets being given button points. In fitting doubling plates tack rivets are driven along the edges as also in the middle portions of the plates.

Lloyd's requires all flush butts of plating to be planed and fitted close, all overlapped butts and edges to be sheared from the faying surfaces, or the burr caused by shearing to be carefully chipped off, and all outside edges of seams and lapped butts to be either planed or chipped fair. The rivet holes are to be punched from the faying surfaces, opposite each other in the adjoining parts, laps, lining pieces, buttstraps and frames.

In the garboard strake or the strake next to the keel brass plugs are sometimes fitted, by unscrewing which when in dry dock the inner bottom compartments may be drained.

**Bulwarks.**—These are sometimes fitted forward to keep the water off the deck, or in the wells of large vessels, or on bridge or promenade decks. The plating is usually light of about 12.5 lb. and may be supported by wrought iron stanchions, by flanged plates or by bulb angles, spaced not more than 6 ft. apart, and the top finished off with a bulb angle or channel. Teak rails are only fitted on passenger steamers and then very rarely on account of the cost. In the bulwarks are openings called freeing ports for the water to run off the deck, and also openings through which the lines for handling the vessel can pass.

**Double or Inner Bottom.**—This is important as it serves not only to prevent water from entering the ship should the shell plating be pierced, but also provides a means for carrying water ballast, or oil fuel. It extends approximately from bilge to bilge, and as far forward and aft as practical. The frames and reverse frames are usually joggled in a double bottom as they are smaller than the main frames which are connected by brackets to the margin plate, the margin plate being near the turn of the bilge. See Fig. 39.

The breadth of the bracket at the ship's side and its rivet attachment to the frame angle must in no case be less than its breadth and attachment at the margin plate. At the lower edge of the margin plate is a continuous angle riveted to the shell, while the upper part of the plate is flanged over, generally inboard, and riveted to the inner bottom plating (tank top). A gusset plate is riveted over the flange of the margin plate and also to the reverse angle of the vertical frame, depending on the size of the ship. If the ship is large enough to have gussets at every frame it is usual to carry

the double bottom plating over on the margin brackets and an angle is fitted at both the top and bottom of the margin plate.

Instead of the above construction the tank top may extend to the shell plating with an angle connection, and be flanged connected thereto at the ends. A flanged plate is employed at the ends on account of the difficulty of riveting an angle to the shell and tank top. The frame bracket is riveted to the top of the tank top, but this construction interferes with the stowage of cargo and is not adopted as extensively as the one outlined in the previous paragraph.

The thickness of the plating is specified by the rules. Under the boilers it is increased in thickness. The seams run fore and aft, and care must be taken to secure a good shift of butts that will not coincide with those of the shell, center keelson and longitudinal. The plating may be either alternately in and out or one edge in and the other out.

When a double bottom extends through the engine and boiler spaces, a well should be formed between the after engine room bulkhead and the floor immediately forward of it for drainage purposes, or open gutterways of sufficient size should be made in the wings so as always to be accessible. To give access to the floors and longitudinals manholes are fitted in the tank top; these manholes may be plates bolted to the plating or they may have hinged covers that can be bolted down.

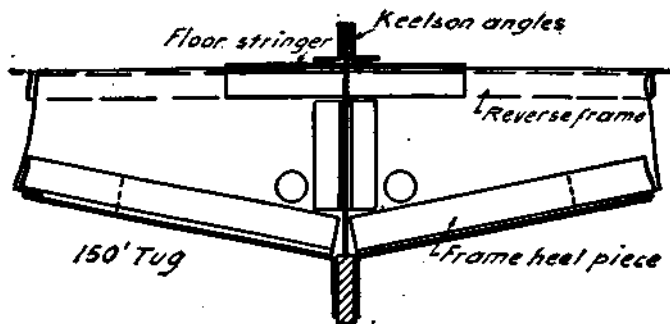

Figure 42.—Bar Keel.

Where the side girders are spaced more than 6 ft. apart the watertight floors in double bottoms are to be stiffened by vertical

angles of the size of the frame angle on the floor, spaced midway between the girders. Every floor in the engine space should have double reverse angles, as also on each floor in way of boiler bearers. They are to extend in all cases from the middle line to beyond the girder next outside the engine seating.

**Air pipes** should be fitted in sufficient number and size and wherever necessary, one being at each end of each tank on both sides of the vessel.

**The tank top** may be covered with a bituminous compound instead of a wood ceiling (see Carpenter Work), the former having the advantage of well protecting the plating when properly applied.

**Keelsons and Longitudinals or Side Girders.**—In a vessel without a double bottom there is a fore and aft center plate with angles at the top and bottom, called the center keelson, and between it and the turn of the bilge, one or more plates with angles called side keelsons, and at the bilge another of similar construction called a bilge keelson. These same members in a vessel with a double bottom are often given the names of center girder and side girders or longitudinals, which in the latter case are numbered as first longitudinal, second, and so on.

**The center girder** is continuous fore and aft and is riveted to the tank top and to the keel, and also to the stem and stern post. It is usually watertight but not necessarily caulked, although the rivets may be given a watertight spacing. In the way of tanks it is caulked. Lloyd's recommend "that keelsons be carried fore and aft continuously through bulkheads, the latter being made watertight around them. Side and bilge keelsons are fitted with intercostal plates attached to the shell plating by angles as may be required. All angle and bulb angle bars of keelsons are to be in long lengths, properly shifted and wherever butted to be connected with angles not less than 2 ft. long fitted in the throat of them, properly riveted to each flange." See section on Oil Carriers.

**Longitudinals** are intercostal in some vessels between the frames, while in others, as in battleships, they are continuous, the frames being cut. They have lightening holes, but in large vessels with several longitudinals one or more of them are made watertight. Wherever possible they should be arranged so that in the engine room they form part of the engine foundation. They should not be stopped abruptly, but be gradually reduced in size beyond the distance they are called on to extend by the rules.

Instead of running the keelsons continuously through the bulkheads they may be stopped and bracketed to them.

**Keels.**—Figs. 42 and 43 show different types. Flat plate keels for large vessels, while for tugs, lighters and other small craft, bar keels. With flat plate keels intercostal keelson plates or vertical center plates must be fitted close down on the keel plate and connected to

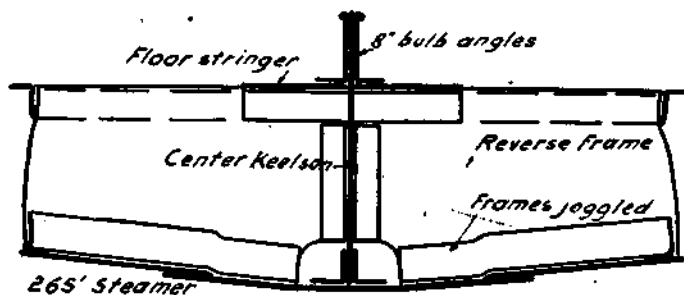

Figure 43.—Plate Keel.

it by double angles riveted all fore and aft to the keel plate and keelson. Bar keels should be worked in long lengths, connected together by right and left hand scarphs that are generally nine times the thickness of the bar in length.

**Bilge keels** may be of a single bulb angle or of a plate and angle, or bulb plate and T bar or plates arranged with a V-cross section packed with wood and riveted to angles that in turn are riveted to the shell. Bilge keels are to prevent excessive rolling and extend about two-thirds or less of the length of the vessel; they should be carefully located so as not to retard the speed. A 160-ft. steamer had fitted bilge keels consisting of a 5-in.  $\times$  4-in.  $\times$  15-lb. T bar to which was riveted a 10-in.  $\times$   $\frac{1}{2}$ -in. bulb plate. In large vessels the keels may be 24 ins. or more in width.

**Docking Keels.**—Only installed on war vessels; consist of a fore and aft timber about 12 ins. wide by 6 ins. thick, connected to the shell plating by angles. The keels should be placed under longitudinals so when the vessel rests on them in dry dock the shell plating will be well supported. They extend a little over one-half the length of the vessel.

**Deck Plating and Coverings.**—The plating is riveted to the deck beams and is laid with alternate in and out strakes, or one edge of a

strake in and the other out, or the plating may be flush or joggled. When the plating is not to be covered the strakes may be arranged in and out so that water on the deck will flow towards the waterways, and thence through the scuppers and overboard. Flush decks made by joggling down the beams and fitting joggled plating are much cheaper than flush decks with planed and fitted edge laps, equally efficient for trucking, and better from the riveting and structural point of view. Strake next to the shell; that is the stringer is heavier than the others. The plates are ordered in long lengths, the seams running fore and aft, the sizes of laps and buttstraps are given by the rules (Lloyd's, American Bureau of Shipping, etc.). All the riveting has watertight spacing and the plate edges caulked.

The deck plating is invariably continuous, the bulkheads being intercostal (see Bulkheads). When the frames extend through a watertight deck, stapling may be worked between the frames and riveted to them as well as to the deck and shell plating, after which the stapling is caulked. Or, as more usually the case, the frames are cut and bracketed to the watertight deck or flat.

**Deck planking** (see Carpenter and Joiner Work).

When vertical donkey boilers are placed on a steel deck, the deck underneath them is to be covered with fire brick or cement not less than 2 ins. thick. The deck on which fires may be drawn from a donkey boiler is also to be protected by fire brick or cement not less than 2 ins. thick.

In the galley, toilets, bathrooms, and where it is necessary to flush the floors frequently, other material than wood is laid for covering the steel deck. In some instances linoleum, it being fastened down by cement or by metal strips bolted to the deck. In the toilets and bathrooms either rubber or clay tiling embedded in cement or an asphalt flooring may be laid.

**Deck beams** are connected to the frames by knees or brackets which are in accordance with Lloyd's or other societies' rules. The beams on the upper decks are given a camber of about  $\frac{1}{4}$  of an inch to the foot in the ship's width. Those on the lower decks and in the holds are often straight.

Beams are to be fitted at every frame:

- (a) At all watertight flats;
- (b) At upper decks of single deck vessels above 15 ft. in depth;
- (c) At unsheathed upper decks when a complete steel deck is



required by the rules, also at unsheathed bridge decks, awning or shelter decks. In vessels over 450 ft. in length the beams of the upper, awning or shelter decks are to be fitted at every frame whether the plating is sheathed or not. Upper decks in way of poops, forecastles and bridges of vessels not exceeding 66 ft. in breadth may have the beams fitted at alternate frames except for one-tenth the vessel's length within each end of the bridge where they are to be fitted at every frame;

- (d) Where no wood deck is laid on a steel or iron deck (required by the rules) at sides of hatchways including those of engine and boiler room openings.

Elsewhere deck beams must in no case be spaced more than two frame spaces apart and only when the frame spacing does not exceed 27 ins. (Lloyd's requirements).

When it is intended to suspend chilled beef or similar products from the beams, the beams and the girders under them must be of extra strength. Strong beams in the machinery space are to have double angles on their upper and lower edges unless cross tie plating is fitted on them, in which case only single angles are required on the upper and lower edges.

Single deck vessels can be built according to Lloyd's without any intermediate hold beams; in fact the rules cover single deckers up to 31 ft. in depth.

**Hatchways.**—Beams forming the end of hatchways above 10 ft. in length where beams are at every frame are to be not less than the size required for beams at alternate frames. To the deck are riveted angles which are riveted to coaming plates. The thickness of these plates is according to Lloyd's or other societies' rules and the angles connecting same are to be the same thickness as the plates and welded at the corners.

**Side coamings** are to extend below the beams and be flanged for a breadth of 6 ins. under the half-beams when hatches exceed 10 ft. in length, and also are stiffened near the top by horizontal bulb angles not less than 7 ins. in depth or their equivalent. The athwartship plates may be worked with an incline or pitch, the highest part being at the center, and they are not given the camber of the deck beam as the hatch covers will fit better without it. See Hatch Covers.

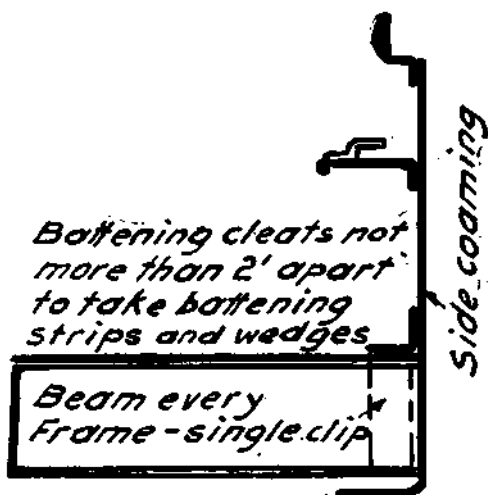

Figure 44.—Section Through Hatch Coaming.

**Height of Coamings.**—On upper, awning or raised quarter deck exposed 24 ins.

On decks of superstructures other than awning decks, where exposed to the weather, within one-quarter length from the stem 24 ins., when aft of one-quarter length, 18 ins.

On decks inside superstructures, the openings in the latter having no means of closing, 18 ins.

On decks inside superstructures the openings in the latter being closed by strong wood doors or shifting boards fitted in channels, 9 ins.

On decks below the upper or awning decks or within an intact superstructure the coaming plates need not extend above the deck, but in such cases an angle coaming should be fitted around these hatchways.

**Hatch openings** should have round corners on weather decks and on the top of the coaming plate have riveted either a special rolled section (see Fig. 44), or a Z bar. On the outside are cleats spaced about 9 ins. from the corners and 2 ft. apart, and at such a distance from the top that the tarpaulin cover can be easily

fitted when the battening bar, say  $2\frac{1}{2}$  ins.  $\times$   $\frac{1}{2}$  in., is placed in position. On the sides are two or three lashing rings.

On large hatches heavy portable fore and afters and beams are fitted (maximum spacing 4 ft. 6 ins.) to support the covers efficiently.

Pillars or stanchions are of wrought iron pipe or of plates and angles extending from the beams of one deck to the plating of the one below. In vessels with several decks or tiers of beams, in order that the stanchions develop their full efficiency they should extend from the center keelson or tank top to the upper deck as nearly as possible in a vertical line so as to form a continuous tie, the upper stanchions being lighter than those in the hold.

It is now the practice in cargo steamers to have large stanchions widely spaced; a single row for vessels up to and not exceeding 44 ft. beam, double row from 44 ft. to 50 ft. and three rows above 50 ft., which may support fore and aft girders fastened to the under side of the deck and to the deck beams. With this arrangement holds are obtained that are free from a number of small pillars. An example of a girder and pillar is shown in Fig. 45.

**Stringers.**—These are continuous angles on the inside of the frames, and when the frames exceed a certain depth, Lloyd's requires intercostal plates to be fitted, attached to the shell plating by angles of the thickness of the intercostal plates. The stringer angles are attached to each reverse frame or to angle lugs on the frames with at least two rivets, and connected by brackets to the transverse watertight bulkheads. They should be perpendicular to the shell, thus giving the maximum support to it. The outboard angles should be worked straight without any bevel. When the stringers are 18 ins. in width or over, Lloyd's requires bracket plates to be fitted below them, except, however, should the web frames in the vessel be spaced 8 ft. apart.

Panting stringers consist of plates and angles similar to side stringers and are located forward to stiffen the frames and shell plating, as the comparatively flat surfaces of the plating have a tendency to pant, that is, move in and out in a seaway. The panting stringers from both sides are connected at the stem to a common plate called a breasthook.

**Bulkheads.**—The number and height of watertight bulkheads are fixed by the rules (in Great Britain by the Board of Trade) under which the vessel will be built. Watertight transverse bulkheads are of value as they give structural strength, prevent fires

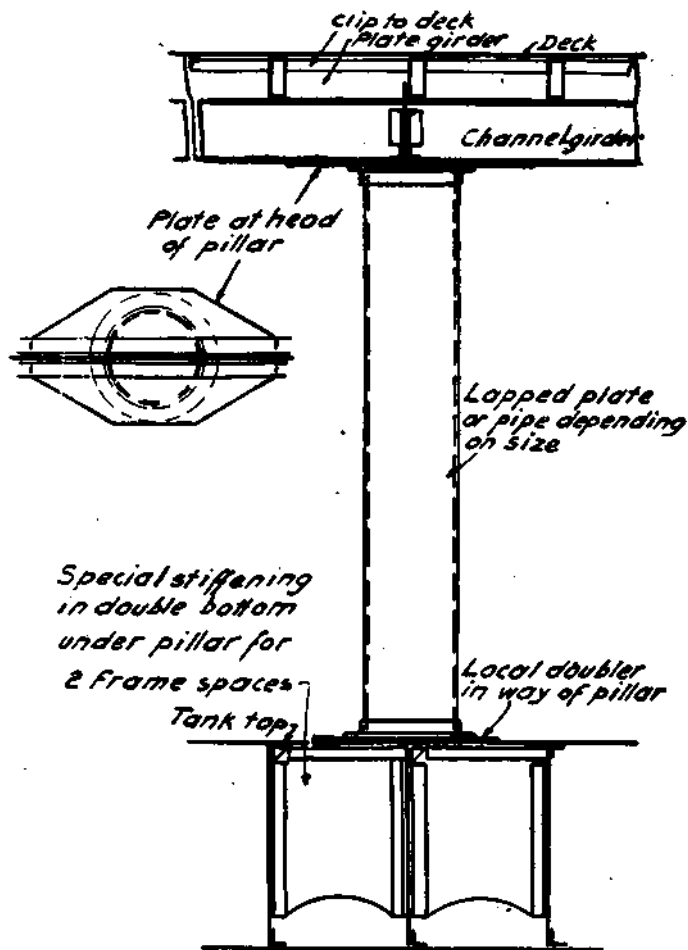

Figure 45.—Hold Pillar.

from spreading, and also prevent water from flowing into other compartments should one compartment be flooded. Longitudinal bulkheads are valuable structurally as they form a vertical web,

thus adding greatly to the fore and aft strength of a vessel. Battleships, tankers and large passenger vessels have such bulkheads.

Lloyd's states: "Screw steamers are to have a watertight bulkhead at each end of the engine and boiler space. A watertight collision bulkhead is in addition to be fitted at not less than 5% of the vessel's length abaft the fore part of the stem measured at the fore part of the stem at the load waterline and a watertight bulkhead is also to be fitted at a reasonable distance from the after end of the vessel.

"The foremost or collision bulkhead is to extend from the floor plates to the upper, awning or shelter deck and its watertightness is to be tested by filling the peak with water to the height of the load line.

"In vessels above 285 ft. and not exceeding 335 ft., an additional bulkhead is to be fitted in the main hold about midway between the collision and boiler room bulkheads.

"In vessels above 335 ft. and not exceeding 405 ft. two additional watertight bulkheads are to be fitted one in the fore hold and one in the after hold.

Vessels Above	And Not Exceeding	Additional Watertight Bulkheads to be Fitted
405 ft.	470 ft.	3
470 "	540 "	4
540 "	610 "	5
610 "	680 "	6

"Where the machinery is fitted aft in vessels above 220 ft. and not exceeding 285 ft., a watertight bulkhead is to be fitted about midway between the collision bulkhead and the bulkhead at the fore end of the engine and boiler space.

"The bulkheads are to extend to the height of the upper deck except in awning or shelter deck vessels in which cases the bulkheads with the exception of the collision, may extend to the deck next below the awning or shelter deck. In awning or shelter deck vessels with a continuous superstructure or bridge house a deep web frame or partial bulkhead is to be fitted on each side in the 'tween-decks over each of the watertight bulkheads which extend only to the deck next below the awning or shelter deck. Partial bulkheads may be dispensed with if other efficient strengthening is provided to the satisfaction of the Committee. The after col-

lision bulkhead may extend to the first deck above the load line subject to the approval of the Committee, provided this deck forms a watertight flat from the bulkhead to the stern, otherwise it must extend to the upper deck."

**American Bureau of Shipping states:** "All vessels must have a forward watertight collision bulkhead extending to the upper and to second deck in hurricane deck vessels. As to the after collision bulkhead this is to extend to the upper deck, second deck in hurricane and three deck vessels and have a watertight steel flat extending aft from it to the stern post so as to form a watertight compartment around the stern tube for the screw shaft."

The Bulkhead Committee of the British Board of Trade issued a report in 1915 requiring that all vessels carrying 12 passengers or over must be subdivided according to definite standards. The most important factor regulating the subdivision is the freeboard ratio or the ratio of freeboard to draft. If this is small, the surplus buoyancy of a vessel is small and the spacing of the bulkheads is close. If large holds are required the freeboard ratio must be considerable, which may be obtained by either limiting the draft or increasing the depth. In some cases the bulkheads are carried to a deck higher than what would otherwise be the bulkhead deck.

The plating of transverse as also longitudinal bulkheads is invariably worked intercostal between the decks. In transverse, the plating may be either in vertical or horizontal strakes, or a combination of the two. By using a vertical plate on each side at the shell, the others may be rectangular with the seams horizontal if desired. The side plates are connected to the shell by single or double angles as called for by the rules, and the upper plates to the deck by single or double angles. As the holes caused by the riveting of two angles to the shell weaken the shell, this is strengthened by adding doubling plates or liners. Lloyd's states that doubling plates between frames and outside plating in way of bulkheads are to extend in one piece from the foreside of the frame before to the afterside of the frame abaft the bulkhead frames, or they may be of an approved diamond shape. These doubling plates may be dispensed with provided the transverse watertight bulkheads are connected to the sides of the vessel by brackets, fitted at each side stringer and hold stringer.

The thickness of the plating varies, the lightest being at top. The plating is stiffened by vertical stiffeners bracketed in some instances to the deck, and to the tank top as may be required by

the rules, which also give the thickness of the plating and the riveting. Vertical stiffeners are the only ones (except in tankers which also have horizontal stiffeners) required by Lloyd's in accordance with the tables issued in May, 1915. In torpedo boats and in other high speed vessels, instead of vertical stiffeners the plates are sometimes flanged, thus saving weight.

To secure watertightness bulkheads must be caulked, and this is usually done on the after side of bulkheads forward of amidships, and on the forward side of those aft. The stiffeners are arranged so they do not come on the side to be caulked. As a rule it is necessary to caulk only one side of a bulkhead. In tankers the greatest care must be exercised to get oil tightness, not only by spacing the rivets closer but by additional care in caulking. See section in Oil Carriers.

**Stopwaters.**—These consist of packing pieces or liners applied locally. They are fitted when the caulking edge is inaccessible, as in a watertight bulkhead when stiffeners are placed on the caulking side crossing the seams of plating. Stopwaters may be of canvas, burlap, or felt soaked in red lead, in tar, or a mixture of red lead and tar. One of the best materials is hempfelt sheeting soaked in tar.

**Stem and stern frames** may be of cast steel or of forgings. In large vessels they are in two or more parts riveted together. Their sizes are specified in the rules, Lloyd's, American Bureau of Shipping, etc. In bar keel vessels the lower part of the stem is of the same molding as the keel and is fastened to it by a scarp of the same length as the keel scarp (see Keels). In flat keel vessels the center keelson extends well forward and is riveted to the stem when possible and in addition the angles on each side of the center keelson extend as far forward as practical and are riveted to the stem as well as to the flat keel.

The stern frame consists of two posts, the forward or body post and the after or stern post, that are connected at the bottom by a flattened portion, and at the top by an arch. In vessels whose longitudinal number (Lloyd's) is over 16,000 the forward or propeller post should extend sufficiently above the arch of the stern post to be efficiently connected to the plating on the beams and to a deep transom plate. In single and triple screw vessels the body post is swelled out to take the stern tube. The spur or heel for connecting to the keel (bar or flat) is usually  $2\frac{1}{2}$  frame spaces long. The center keelson is connected as outlined for the stem.

To the after or stern post are forged or cast (depending on whether the post is a forging or a casting) gudgeons for the rudder pintles. The upper gudgeon should be as near as is practical to the rudder trunk, while the others are 4 ft. 6 ins. to 5 ft. apart. One of the gudgeons in small vessels and two in large are shaped so as to form a hard-over stop for the rudder. At the bottom of the stern post there may be a spur extending aft that takes the lower rudder pintle. Gudgeons must not be less in depth than seven-tenths the diameter of the rudder head, and the thickness one-half the diameter of the pintles. The stern post must extend sufficiently above the counter to be connected to the full depth of the transom plate.

**Stern Tube.**—This in a single screw vessel extends from the stern post to the after collision bulkhead. The after end at the stern post has a composition bushing with lignum vitæ strips, with the grain set perpendicular to the shaft. The shaft in the way of the strips has a brass sleeve. At the collision bulkhead is a stuffing box.

**Propeller Struts.**—These are usually of cast steel with an elliptical cross section, the forward part having a larger radius than the after. The center of the strut should be placed on a frame so as to secure the maximum stiffness. In wake of the upper palm doubling plates should be fitted on the shell plating, while the lower palm should be riveted to the keel. Struts should be set so as to conform to the run of the water, so the arms will not cross the stream lines and interfere with the speed of the vessel.

**Simpson's formula\*** for propeller struts is as follows:

$R$  = revolutions of engines per minute

$P$  = indicated horse power for one shaft only

$l$  = outboard length of shaft from stern tube outer bearing to center of boss in ins.

$k$  = coefficient = .0633  $R$

Then area in square inches =  $\frac{\sqrt[3]{R \times P \times l}}{k}$

The proportions of the pear-shaped arm are:

Length =  $\sqrt{5.3 \times \text{area}}$

Distance maximum breadth from the forward end = .33  $\times$  length

Maximum breadth = .25  $\times$  length

Radius at forward end = .25  $\times$  maximum breadth

Radius at after end = .50  $\times$  radius at forward end.

\* From The Naval Constructor, G. Simpson.



For the lesser powers and for brackets intended for wood or composite vessels, the brackets should be of gun metal or bronze, and for higher powers and steel ships of cast steel.

**Spectacle Frames.**—These have taken the place of propeller struts in large twin and triple screw vessels. They are of cast steel and their cross section may be calculated by the same formula as for propeller struts and the result multiplied by two, as in this case there is only one arm whereas in the other there are two. The shell plating is worked completely around the frames, thus inclosing the propeller shaft. Additional strength must be obtained in wake of the spectacle frames by increasing the floors and doubling the ship's frames.

**Rudders** may be of cast steel, or a steel plate riveted to wrought iron arms, or a wrought iron frame packed with wood and then covered with steel plates. Cast steel rudders, particularly if only one is required, are expensive, while those packed with wood are heavy. The most satisfactory is a single plate riveted to arms on alternate sides, the plate varying from  $\frac{3}{8}$  to  $1\frac{1}{4}$  ins. in thickness depending on the size of the vessel.

A quick formula for calculating the diameter of the rudder stock is given in the British Corporation rules (see also Lloyd's, American Bureau of Shipping, etc.) as follows:

Let  $d$  = diameter of stock in ins.

$A$  = area of rudder in sq. ft.

$r$  = distance from center of gravity to axis in ft.

$V$  = speed in knots

Then  $d = .26 \sqrt[3]{r A V^2}$

The rudder stock may have a vertical or horizontal palm, which is bolted to a corresponding one on the frame, a key being inserted, or the parts may be scarphed together. The pintles should be separate from the rudder frame and of a cone shape (see Fig. 46) and one, called the locking pintle, must have a nut to prevent the rudder from jumping in a seaway. To the rudder stock is keyed either a tiller or a quadrant—if the steering engine is located forward. If a tiller is selected it is necessary to have sheaves to take up the slack rope, but if a quadrant no sheaves are necessary. See Steering Engines.

The forward side of the rudder frame is made preferably in one continuous line with the projections for the pintles forged or cast on, as by so doing a strong frame is obtained. To fill in the spaces

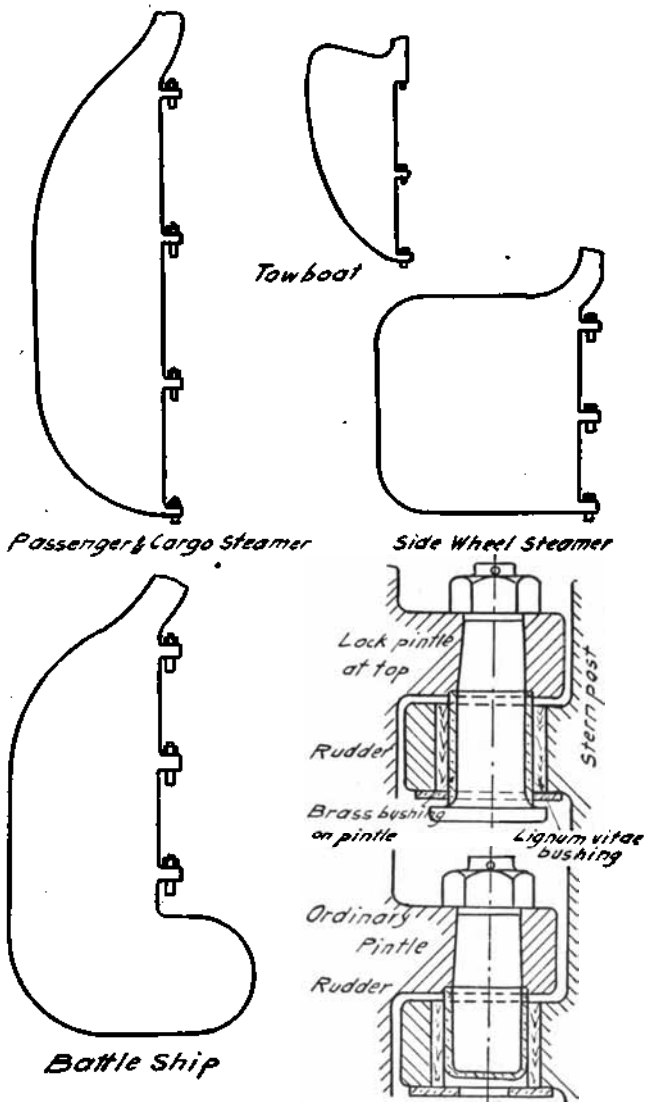

Figure 46.—Rudders.

between the pintles, plates are riveted to the outside of the frame. Rudders for sidewheelers often have a bumpkin at the after part to which the steering gear is attached. In this case the rudder is turned by pulling on the bumpkin, the rudder post serving only as a pivot.

As to shapes there is a variety as shown in Fig. 45. For tugs, lighters and side-wheel steamers the maximum width is near the load water line and the area is large. For ocean-going vessels the area is smaller in proportion to their length and the maximum width is about  $\frac{1}{3}$  from the load water line. The balanced rudder is extensively used, particularly on warships. In this type a portion of the area is forward of the rudder stock. The rudders of warships are broader and shallower than those of merchant vessels so as to keep them and the steering gear well below the water line.

Below are ratios of the areas of rudders to the areas of lateral or longitudinal planes of different types of vessels.

RATIO OF AREA OF RUDDER TO AREA OF LATERAL PLANE\*

Type of Vessel	Unbalanced Rudder	Compensated Rudder
Paddle wheel.....	.021	
Large passenger.....	.016	
Ordinary screw.....	.020	.024
Armored ships.....	.025	.030

As an example take the U. S. fuel oil ship *Cuyama*, 455 ft. long, 56 ft. beam, 35 ft. 9½ ins. depth of hold, trial displacement 14,500 tons, speed loaded 14 knots, rudder of balanced type, area to 28 ft. 4 ins., water line 190 sq. ft. abaft of pintles and 35 sq. ft. forward of pintles, total area 225 sq. ft., extreme working angle of rudder from amidship to hard over, 35°. Engine, two-cylinder, each 10 ins. dia. by 10 ins. stroke, steam 125 lb., can put rudder hard over in 30 seconds when vessel is going full speed.

Where the rudder enters the counter there is a watertight trunk, which should be of sufficient size so the rudder may be readily unshipped. For appearance' sake and to prevent the constant flowing in and out of the water, the lower part of the trunk is covered over by a bolted plate.

Suitable stops for the rudder should be securely fastened to the deck in way of the tiller or quadrant. When the quadrant is geared direct to the steam steering engine the deck stops may be dispensed

\* From Naval Architecture, C. H. Peabody.

with. The stops for the steering engine should be at a smaller angle of helm than the rudder stops.

**Machinery Foundations.**—Foundations for the engines, boilers, pumps, and auxiliary machinery should be well and strongly built. Scotch boilers should be kept up high enough to allow a man to get under them and also there should be room between them and the deck above to adjust safety valves and other boiler fittings. Care should be taken that the boiler saddles do not come in line with the circumferential seams of the boiler, as the latter at the bottom of the shell are liable to leak. The U. S. Steamboat-Inspection Rules state: "All boilers shall have a clear space of at least 8 ins. between the underside of the cylindrical sheet and the floor or keelson. All boilers shall have a clear space at the back and ends thereof of 2 ft. opposite the back connection door, provided that on vessels constructed of iron or steel with metal bulkheads the distance back of the doors and such metal bulkheads shall not be less than 16 ins."

In Scotch boilers the saddles may extend a distance of about  $\frac{3}{4}$  of the diameter of the boiler around the bottom. The boilers rest on these saddles and may be connected to them by rods from pad eyes riveted on the boiler to others on the saddles. Or instead of this, plates may be riveted to the boilers at each side and these plates bolted to I beams extending fore and aft that are fastened to the floors, in which case no rods are required. In both cases, to prevent fore and aft movement of a boiler, chocks consisting either of a casting or built up of plates and angles are fastened to the tank top at the forward and after ends.

Water tube boilers should be located so that their drums are readily accessible.

In laying off engine foundations give all heights from the center of the shaft down and allow  $\frac{3}{4}$  to 1 inch for lining up. They should if practicable be part of the longitudinals, or if this cannot be arranged they should be rigidly connected to them or else additional longitudinals fitted.

Circulating pumps, generating sets, and other auxiliaries should be securely bolted to foundations that are strongly built of plates and angles.

**Deck Erections.**—For the usual cargo steamer the deck erections above the weather deck consist of a forecastle forward, bridge amidships, and poop aft, thus giving what is commonly called "three islands." The ship's frames may extend through the deck and serve as the vertical stiffeners for the side plating, and to them

may be bracketed beams over which there may be a light steel deck with a wood deck on top, or simply tie plates with a wood deck.

There has been a general tendency to increase the length of the bridge house in the three-island type, but there are two conflicting considerations to fixing the extent of the deck erections, more especially in British-owned vessels. These are freeboard on the one hand and tonnage measurement on the other. An increase in substantially constructed and efficiently protected deck erections on a vessel of full scantlings permits of a reduction of freeboard and therefore of an increase in weight of cargo carried. But if these deck erections are permanently closed-in spaces, they must be measured for tonnage and therefore dues based upon tonnage must be paid on them.

A typical freight steamer as outlined in the table on page 311, with the machinery amidships, has a forecastle forward for the crew, then a house amidships with quarters for the engineers, and a poop aft for stores or for cargo. In some with the machinery aft and of the three-island type, the crew is forward, then in the center house or island are the officers' quarters while away aft over the machinery are the engineers and firemen. In passenger steamers carrying one class the passengers are amidships, while in those with three classes, the steerage are forward, the first class amidships, and the second aft. Here the crew are forward while the officers and engineers are partly divided with quarters amidships and aft.

Deck houses that are away from the sides of the vessel have vertical stiffeners with bracket plates riveted to the deck, while at the top are other brackets which are riveted to the deck house beams. These beams are connected by tie plates over which a light wooden deck is laid.

**Cementing.**—The entire bottom of a vessel up to the turn of bilges, and the forward and after trimming tanks should be covered with the best quality Portland cement—except in oil tankers where the cement may be omitted in the oil compartments. In the after trimming tank and in other places where a considerable depth of cement is required, a thin coating of neat cement is applied to the metal, then cork, coke or other light material is put over it, and cement poured on top until the whole mass is solid. Drinking water tanks should have three washes of neat Portland cement.

The American Bureau of Shipping Rules state: "The inside of all vessels from the keel to the turn of the bilge to be coated with approved hydraulic cement. If a mixture of Portland cement and

sand is used the cement and sand should be mixed in about equal proportions. The sand should be sharp dry river sand—salt water sand must not be used. At middle line the cement should be laid sufficiently thick to form a level surface right fore and aft flush with the lower side of the limber holes. From middle line to bilges the cement must cover all the rivet heads on flange or frames and on inside strake butt straps, being correspondingly thicker on the outside strakes of skin plating. Vessels fitted with a double bottom should have a thin coating of cement laid on the upper side of inner bottom plating. It is recommended to coat the floor plates with a cement wash in lieu of paint." Lloyd's requirements are similar to the above. Before applying the cement all mill scale and dirt must be removed from the plates.

**Painting.**—All steelwork to be painted must first be carefully scraped, scaled and cleaned. Care should be taken that no paint is applied to steel which is to be covered with Portland cement. The entire structure except as just noted should have a priming coat of red lead. After this is dry all rivet heads and flush seams and butts, and in general all exposed flush surfaces should be smoothed as necessary with an approved rivet cement.

The outer surface of the hull may be divided into three parts: (1) the under water portion, (2) the part that is under water when the vessel is loaded and out when she is light called the boot top, and (3) the top which is exposed to the weather only. The under water portion should be painted with anti-corrosive and anti-fouling paints, the boot top with a special paint that is not affected by the weather or water, and the top sides with a weather paint.

The hull of the vessel inside and out, steel decks, bulkheads and steel structures, that will be ceiled or covered with wood, should be given two good coats of red lead, the priming coat mentioned above being considered the first coat. These two coats of red lead are in addition to the finishing coats. In some vessels, compartments finished in red lead only shall be given at least three coats in all. Areas finished in white or spar color should have at least two coats of the color in addition to the red lead.

Before launching the underwater body, including the rudder, to a suitable distance above the load water line should be given one coat of anti-corrosive paint.

There are a variety of anti-fouling and anti-corrosive paints on the market, a few of which are mentioned below. The Am. Veneziani Paint Co., New York, N. Y., make a red anti-corrosive

paint that also protects the steel plates from galvanic action. On top of this is applied Lamoravia green anti-fouling composition (made by the same company) which has a grease base. This green composition is sold in a solid mass and must be heated in a boiler or kettle to a temperature of 180 degs. F. before it can be applied. When melted it is easily applied with brushes like any oil paint. One gallon of the anti-corrosive paint will cover about 28 sq. yds., and one gallon of the anti-fouling composition about 6 sq. yds.

Another anti-corrosive and anti-fouling paint for steel vessels is the **International**, the makers (Holzapfels Am. Comp. Co., New York) claiming that it dries quickly and resists the corrosive action of salt and fresh water.

A plastic paint, trade name **Tockolith**, is made by Toch Bros., New York. After the hull has been scraped and well cleaned, Tockolith is applied; it strongly resists the corrosive effects of salt water and abrasion by floating objects which the hull may come in contact with. When this is dry an anti-fouling paint consisting of copper and mercury is applied which prevents fouling by barnacles, grass, and other marine growths. For the area that is alternately exposed to the water and to the air, a special or boot topping paint may be put on. This, as made by Toch Bros., is a black, waterproof material which retains its color and body, and does not flake or peel off.

Attention should be called to **Bitumastic enamel** (American Bitumastic Enamels Co., New York) that is particularly adapted for interior surfaces as in pontoons of floating docks and of double bottoms of ships, as it can withstand the presence of oxygen and water without deterioration. Bitumastic enamel is a solidified bituminous composition applied hot to any thickness desired, forming a bright black coating that hardens quickly. The surface to be coated is first thoroughly cleaned and then given a priming coat of Bitumastic solution applied cold which is allowed to dry from 12 to 24 hours. Then Bitumastic enamel is applied, it being heated to about 380° F., and brushed on while in the molten state.

Owing to its exceptionally adhesive and penetrating nature, the priming coat forms an intimate bond with the steel, and the base of the two coatings being identical, they combine, the result being a hard, heavy and elastic coating which is absolutely impervious and practically indestructible.

On many ships Bitumastic enamel has been applied to tank tops and bilges to a thickness of  $\frac{1}{4}$  in., to double bottoms and peak

tanks  $\frac{1}{8}$  in. on vertical surfaces, and  $\frac{1}{4}$  in. on shell in double bottom, and the engine and boiler seatings covered to the height of the platforms with a thickness of  $\frac{1}{8}$  to  $\frac{1}{4}$  in.

The bottoms of wood vessels are often painted with copper paint. One maker (Holzapfels) claims that his paint is a reliable substitute for copper sheathing, and for a long time protects the wood against the ravages of the boring worm, and the surface against the adhesion of grass, barnacles and mussels. It should be applied with clean brushes on a dry and clean surface. Only one coat is required, which takes about half an hour to dry, and when it has dried, it presents a smooth and enamel-like surface.

For yachts and motor boats, great care is taken to have a perfectly smooth surface before painting, by puttying all holes and seams. Then sandpaper to an even surface and apply the first coat of paint, as Devos's metallic copper paint, allowing for brown or red six hours to dry before applying the second coat. When using green, the first coat must be thoroughly hard before applying the second coat. On new work, two coats of copper paint should be used. With brown and red copper paint, the best results are obtained by allowing the second coat 24 hours to dry before launching. When using green copper paint never launch immediately after applying the second coat, but allow time for it to become thoroughly hard.

On old boats or on boats whose bottoms are to be repainted they should be cleaned as thoroughly as possible with a steel wire brush, and when using brown and red copper paint, it may be applied to a damp surface if time and place make it imperative to paint between tides, although it is best to wait until the bottom is thoroughly dry. When repainting one coat is generally sufficient, but on bottoms where the old paint is pretty well worn off, use two coats.

When using green copper paint, never apply over old coats of brown or red copper paint. Thoroughly scrape or burn off before painting, in which case two coats are necessary. In event of green copper paint having been previously used and same being in good condition, sandpaper with No. 1 sandpaper and finish with one coat of green copper paint.

The lower parts of the engine room bulkheads and a large portion of the boiler room are painted red or brown on account of the wear and the dirt, while the upper parts may be painted white to improve the light. Black is used on the gratings, furnace fronts and various metal parts.

See also Interior Decoration and Painting of Pipes.



## WOOD VESSELS

In the coastwise trade in the United States, wood schooners are largely employed, and for harbor service, wood lighters, tugs, ferry-boats and excursion steamers. The displacement is usually calculated to the outside planking, and the mold loft lines given to the inside.

Motor boats and other small craft with rounded bilges have steam bent frames, while those with V cross sections have a straight piece to the bilge and another vertical to it.

In tugs, lighters, schooners, and barges the frames are of several pieces, that are bolted or treenailed together. All butts of timbers must be close and not less than  $\frac{1}{3}$  of their molding. Heads and heels of the timbers should be square. The frames may be of all one material as oak, although some vessels have mixed frames, that is one piece of oak and the next one of chestnut. For the curved parts as at the bilge, pieces are selected that can be trimmed, when in place, to the lines of the vessel. The sizes and spacing of the frames are given in the rules of the American Bureau of Shipping.

The keels are of oak into which is rabbeted the planking. The planking is of long leaf yellow pine or oak, and at the bilge both the ceiling (inside planking) and the outside planking are increased in thickness. Salting is recommended while building. Salt stops must be fitted in all salted vessels just above the air strakes and at the turn of the bilge. The use, however, of salt as a preservative is rapidly giving place to creosote and carbolineums. All vessels must have proper air strakes or air holes below the two upper strakes of clamps under all decks. The planking is caulked with oakum and cotton, and thus made watertight.

All vessels over 1000 tons whose length exceeds ten times their depth, must be diagonally strapped with iron plates of suitable width and thickness on the outside of the frames. The straps should be placed at an angle of  $45^{\circ}$  and extend from the covering to the heads of the floor timbers. Four at least of these diagonals should cross one another on each side in the body of the vessel. These straps should be riveted together where crossed and should be let into the timbers and fastened to every frame by two bolts; the upper end should be connected to a horizontal strap passing around the hull.

The beams are in a single piece connected to the frames or to the inside planking by wood knees. At the center they are supported by a row of wood pillars, or if the span is excessive there are two or more rows as may be required by the rules.

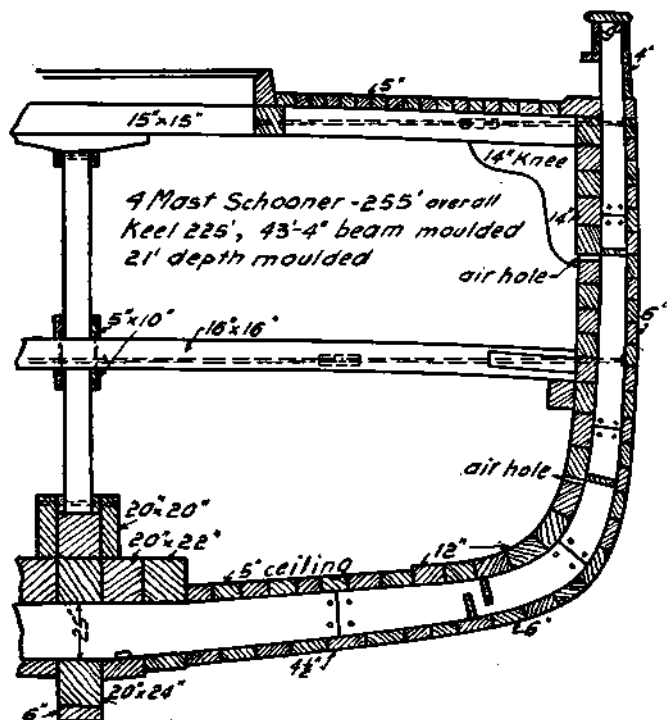

Figure 47.—Midship Section of Four Mast Schooner.

Some large schooners and barges are built with two complete decks, while others only have one, in which case if the depth in the clear from the keelson to the deck beam exceeds 13 ft., then hold beams must be installed.

Vessels for carrying lumber have bow ports, one on each side, through which the lumber is loaded and discharged. There are no cross bulkheads, thus giving a long hold. For carrying coal the arrangement is different, there being transverse bulkheads and large deck hatches through which the coal is loaded and discharged.

The maximum size of a wood schooner does not exceed as a rule 3,000 tons deadweight, for above this the stiffening required to get

the necessary structural strength is excessive when compared to the additional carrying capacity secured. As to barges for carrying coal a fair average for those along the Atlantic Coast, that are towed as from Norfolk, Va., to Boston, Mass., is about 1,800 tons deadweight, a single tug towing 3 of these barges at a speed of about 7 knots an hour.

See tables of Schooners, Tugs, Lighters and Motor Boats.

### CARPENTER AND JOINER WORK AND INTERIOR DECORATION

Carpenter work may be said to include the laying of wooden decks, installing the ceiling and cargo battens in the holds, fitting masts and spars, bitts, chocks, cleats, etc. Under the heading Joiner Work is included the building of cabins and fine cabinet work in mahogany or other expensive wood.

For data on Woods, see Shipbuilding Materials.

For feet board measure, see page 9.

**Deck Planking.**—The weather decks are usually covered with yellow pine or white pine planking. The butts should be carefully arranged so that there are at least three clear shifts between every two butts in the same beam space. When the planks are 6 ins. or under in width a single through bolt through every beam is sufficient; when they are above 6 ins. and not exceeding 8 ins. there must be two bolts in every plank one of which may be a short screw bolt, while planks exceeding 8 ins. must have two or more through bolts. The bolts must be properly sunk into the wood, and their heads

NUMBER OF DECK BOLTS PER 1,000 FEET BOARD MEASURE OF  
PLANKING  
Planks 26 ft. long

Thick- ness of Plank, Inches	Spacing of Frames in Inches								Weight of 100 Bolts	
	18	20	22	24	26	28	30	32	½ In.	¾ In.
1½	2980	2712	2492	2312	2160	2024	1912	1812	...	...
2	2235	2034	1869	1734	1620	1518	1434	1359	22.60	39.40
2½	1785	1628	1495	1385	1295	1215	1145	1086	25.48	43.60
3	1490	1356	1246	1156	1080	1012	956	906	28.92	48.00
3½	1275	1162	1067	990	924	867	818	775	32.10	52.80
4	1118	1017	934	867	810	759	717	679	34.75	57.00
4½	994	904	831	771	720	675	637	604	39.40	61.40
5	893	814	748	693	648	608	573	543	40.50	65.55

Thus for a plank 3 ins. thick by 6 ins. wide with a beam (frame) spacing of 24 ins., the number of bolts will be  $\frac{1156}{6} = 193$  per 1000 feet board measure.

covered with wood plugs of the same material as the deck planks, imbedded in white lead. The seams between the planks must be well caulked with oakum and payed with pitch or marine glue.

The **margin plank**, that is the one next to the waterway, is 8 to 12 ins. wide, and into it are nibbed at the ends the narrower widths of planking. The planks around the deck house and skylights are increased in width to 6 to 8 ins. Under the winches, windlasses, capstans, etc., the planking is increased in thickness so as to be 1 or 2 ins. above the deck.

**Cargo battens**, often referred to as open sparring or spar ceiling, are fastened to the reverse frames to prevent cargo from injury by coming in contact with the sharp edges of the reverse frames. Lloyd's requires all vessels to have cargo battens in the holds except those carrying coal, ore, oil, and wood. See Loading and Stowing of Cargoes. The battens are usually pine planks about 2 ins. thick, 6 to 9 ins. wide and spaced 9 to 12 ins. apart. They may be bolted to every third or fourth reverse frame, or they may be held in place by cleats fastened to the frames, in which case they are portable. Bulkhead stiffeners having sharp corners should be covered with battens about  $1\frac{1}{2}$  ins. thick.

**Ceiling.**—On the tank top of cargo steamers the ceiling, often spruce or yellow pine, may be omitted except under the hatches and at the bilges. If the ceiling is omitted under the hatches the tank top plating must be increased .08 in. in thickness in way of the hatchways. Vessels not having double bottoms are to be ceiled, the thickness varying from 2-inch pine planking in small vessels to  $2\frac{1}{2}$  in large, by about 10 ins. wide, arranged in portable sections approximately 9 ft. long that can be readily handled. The ceiling must not be fastened through the tank top.

**Hatch covers** are of spruce or yellow pine, made in sections about 24 ins. wide, and provided with lifting rings. Lloyd's states: "All hatches to be solid (or gratings of sufficient strength) and not less than  $2\frac{1}{2}$  ins. thick in hatchways not exceeding 16 ft. in breadth, when this is exceeded they are to be not less than 3 ins. where fore and afters are fitted. Efficient supports are to be provided having at least  $1\frac{1}{4}$ -inch bearing for the ends of the hatches. Where no fore and afters are fitted, hatches to be not less than 3 ins. and supports have not less than 3 ins. bearing for the ends of the hatches at the end coamings."

**Cabin and Stateroom Bulkheads.**—Bulkheads forming passageways are built with vertical frames which are covered on the outside

*Dome Roof**Sloping Roof**Flat Roof**Companion Way*

Figure 48.—Skylights and Companion Way.

with panels of polished hard wood or pine enameled white and on the inside with panels or tongue and groove boards. To provide for a free passage of air the upper part of the bulkhead between the beams may consist of an ornamental metal grating. The partitions between the staterooms may be of double tongue and groove boarding about  $\frac{3}{8}$  in. thick in two courses at right angles. The doors to the staterooms are 2 ft. 6 ins. to 3 ft. wide.

**Skylights.**—Different types are shown in Fig. 48.\* The dome roof over the main cabin saloon and social halls on passenger steamers makes a good appearance. The sloping roof is fitted over engine rooms and may be built of steel plates and angles instead of wood. Companionways are of steel, teak, or mahogany. For motor boats and fine yachts the skylights, companionways, and deck houses are of mahogany or teak.

**Miscellaneous Notes.**—Thwartship flights of stairs should be avoided as much as possible, for in descending a person has to meet the rolling of the vessel. In laying out stairs, take the sum of two risers from 24 ins. and the remainder will be the required tread.

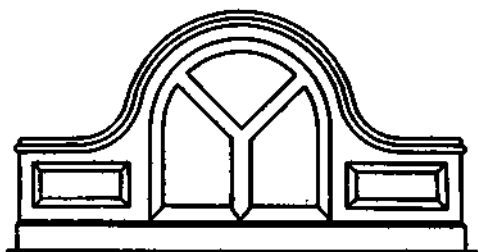
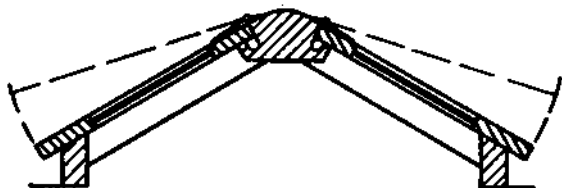
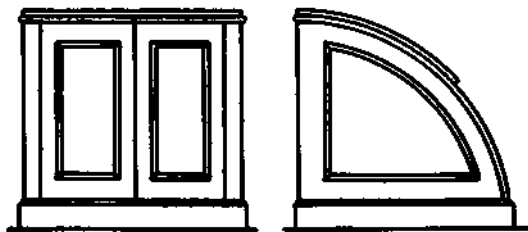
Berths in passenger quarters are of metal, about 30 ins. wide and approximately 36 ins. between the upper and lower one. In cabins *de luxe* are beds as on shore. In crew's quarters pipe berths may be installed about 2 ft. 3 ins. wide by 6 ft. 3 ins. long, the bottom of the first berth being 10 ins. from the floor and of the second 46 ins. from the floor. The U. S. Steamboat-Inspection Rules state that berths can only be two high.

The height of a chair seat or seats along the side of an excursion steamer varies from  $17\frac{1}{2}$  to 18 ins. above the deck. Depth of seat 15 to 16 ins.

Writing and dining tables are 2 ft. 5 ins. high. Mess tables and benches are of white ash.

**Interior decoration and painting** should be governed by the trade and climate. If the vessel is to run in the tropics the rooms should be light and airy and finished off in white; if in cold regions then dark woods and the reverse of the treatment for the tropics should be followed.

Staterooms are invariably finished off in white enamel paint and mahogany—and the smoking rooms in oak. If the deck heights permit, a ceiling may be built under the beams, thus giving a space in which wires and pipes may be run and yet be easily accessible by having a few panels portable.

\* From Practical Shipbuilding, A. C. Holmes.

As a vessel's saloons are seldom high enough for indirect lighting, wall brackets are necessary. The lighting of a saloon at night is improved if lights are placed around the skylight, otherwise the skylight makes a black patch and puts the middle of the room in shadow.

New wood, particularly on outside work, as deck houses, hatches, spars, etc., should first have a coat of a wood primer. Open-grained woods, as oak, ash, chestnut, mahogany, and walnut, should then be filled with a wood filler. After the filler is dry (24 hours) it should be sandpapered with the grain of the wood to a smooth surface. Close-grained woods, as cherry, birch, white wood, and maple, should have a coat of primer but the filler may be omitted. On interior work it is not necessary to use both primer and filler, the primer alone on close-grained woods or the filler alone on open-grained being sufficient. After the primer and filler or either alone have been applied, and the surface is dry, it is then ready for varnishing. Painting and varnishing should not be done on a damp or cold day. One gallon of varnish will cover about 500 sq. ft. for the first coat and about 600 sq. ft. for the second.

Ceilings, furring strips, battens and the faying surfaces of wood decking should be well painted; the wood to be painted on all sides except for decks and such work as is to be finished bright.

Below are abstracts from the specifications of a steamer for the U. S. Coast Survey. "Areas finished in white or spar color shall have at least two coats of the color in addition to the red lead specified. Soft woods in furniture details and the like will have a coat of white shellac and where painted shall have at least three coats of oil paint. Wood work to be bright shall be filled, shellacked, varnished and rubbed down to a dull finish. In all cases each coat of paint or varnish must be dry and hard before the next coat is put on.

"Cork paint shall be applied to interior surface of outside plating and to frames in living quarters, storerooms and holds.

"A wash strake 4 ins. high shall be painted around the bottom of all steel and wood bulkheads in living quarters and passages, the color to match the strips of the deck surface in the respective compartments.

"All piping whether bare or covered shall be painted to match the compartment in which it runs.

"Galvanized work may be painted with aluminum paint, as also watertight door dogs, grab rods, and steam radiators in the crew's quarters, while the radiators in the officers' will be finished in gilt.

"The waterways on the upper deck and the exposed upper deck plating way forward shall be painted buff, as also the canvas covered deck forming the top of the deck house. Linoleum shall not be painted but shall be thoroughly cleaned and heavily waxed. If directed it may be shellacked."

Cork paint is not used in holds of merchant ships as it is too expensive, but is used in the living quarters.

**Measuring Screws.**—Flat head wooden screws are measured over all, round head from under the head, and oval head from the edge of the bevel. Lag screws have square heads and are measured from under the head. Machine screws, fillister and round heads, are measured from under the head, flat heads over all, and oval heads from the edge of the bevel.

LAG SCREWS

Square heads, cone or gimlet points. Gimlet point screws only supplied from  $\frac{3}{16}$  in. to  $\frac{3}{4}$  in. dia. inclusive.

Diameter of Screw (Inches)										Approximate Length of Thread for All Diameters	
$\frac{1}{4}$ & $\frac{3}{8}$	$\frac{1}{2}$	$\frac{5}{8}$	$\frac{3}{4}$	$\frac{7}{8}$ & $\frac{1}{2}$	$\frac{1}{2}$	$\frac{3}{8}$	1	$1\frac{1}{2}$	$1\frac{3}{4}$		
Length under Head to Extreme Point (Inches)										To head	
$1\frac{1}{2}$	$1\frac{1}{2}$	$1\frac{1}{2}$	$1\frac{1}{2}$	.....	.....	.....	.....	.....	.....		.....
2	2	2	2	2	2	2	2	2	2		2
$2\frac{1}{2}$	$2\frac{1}{2}$	$2\frac{1}{2}$	$2\frac{1}{2}$	$2\frac{1}{2}$	$2\frac{1}{2}$	$2\frac{1}{2}$	$2\frac{1}{2}$	$2\frac{1}{2}$	$2\frac{1}{2}$		$2\frac{1}{2}$
3	3	3	3	3	3	3	3	3	3		3
$3\frac{1}{2}$	$3\frac{1}{2}$	$3\frac{1}{2}$	$3\frac{1}{2}$	$3\frac{1}{2}$	$3\frac{1}{2}$	$3\frac{1}{2}$	$3\frac{1}{2}$	$3\frac{1}{2}$	$3\frac{1}{2}$		$3\frac{1}{2}$
4	4	4	4	4	4	4	4	4	4		4
$4\frac{1}{2}$	$4\frac{1}{2}$	$4\frac{1}{2}$	$4\frac{1}{2}$	$4\frac{1}{2}$	$4\frac{1}{2}$	$4\frac{1}{2}$	$4\frac{1}{2}$	$4\frac{1}{2}$	$4\frac{1}{2}$		$4\frac{1}{2}$
5	5	5	5	5	5	5	5	5	5		5
$5\frac{1}{2}$	$5\frac{1}{2}$	$5\frac{1}{2}$	$5\frac{1}{2}$	$5\frac{1}{2}$	$5\frac{1}{2}$	$5\frac{1}{2}$	$5\frac{1}{2}$	$5\frac{1}{2}$	$5\frac{1}{2}$		$5\frac{1}{2}$
6	6	6	6	6	6	6	6	6	6		6
.....	.....	$6\frac{1}{2}$	$6\frac{1}{2}$	$6\frac{1}{2}$	$6\frac{1}{2}$	$6\frac{1}{2}$	$6\frac{1}{2}$	$6\frac{1}{2}$	$6\frac{1}{2}$		$6\frac{1}{2}$
.....	.....	7	7	7	7	7	7	7	7		7
.....	.....	$7\frac{1}{2}$	$7\frac{1}{2}$	$7\frac{1}{2}$	$7\frac{1}{2}$	$7\frac{1}{2}$	$7\frac{1}{2}$	$7\frac{1}{2}$	$7\frac{1}{2}$	$7\frac{1}{2}$	
.....	.....	8	8	8	8	8	8	8	8	8	
.....	.....	9	9	9	9	9	9	9	9	9	
.....	.....	.....	10	10	10	10	10	10	10	10	
.....	.....	.....	11	11	11	11	11	11	11	11	
.....	.....	.....	12	12	12	12	12	12	12	12	
Threads Per Inch											
10	7	7	6	5	$4\frac{1}{2}$	$4\frac{1}{2}$	3	3	3		
Size of Heads (Inches)											
$\frac{3}{8}$	$\frac{1}{2}$	$\frac{5}{8}$	$\frac{3}{4}$	$\frac{7}{8}$	$\frac{1}{2}$	$\frac{3}{8}$	$1\frac{1}{8}$	$1\frac{1}{2}$	1 11	$1\frac{3}{8}$	Width
$\frac{1}{4}$	$\frac{3}{8}$	$\frac{1}{2}$	$\frac{5}{8}$	$\frac{3}{4}$	$\frac{7}{8}$	$\frac{1}{2}$	$\frac{3}{8}$	$\frac{1}{2}$	1 11	1 11	Thick



IRON WOOD SCREWS

Number of Screw	0	1	2	3	4	5	6	7	8	9	10	11	12	13	14	15	16	17	18	20	22	24	26	28	30
Diameter, Inches	.067	.071	.084	.097	.110	.123	.136	.150	.163	.176	.189	.203	.215	.228	.242	.255	.268	.281	.294	.321	.347	.374	.400	.426	.452
Length, Inches	1/4	1/4	1/4	1/4	1/4	1/4	1/4	1/4	1/4	1/4	1/4	1/4	1/4	1/4	1/4	1/4	1/4	1/4	1/4	1/4	1/4	1/4	1/4	1/4	1/4
"	3/8	3/8	3/8	3/8	3/8	3/8	3/8	3/8	3/8	3/8	3/8	3/8	3/8	3/8	3/8	3/8	3/8	3/8	3/8	3/8	3/8	3/8	3/8	3/8	3/8
"	1/2	1/2	1/2	1/2	1/2	1/2	1/2	1/2	1/2	1/2	1/2	1/2	1/2	1/2	1/2	1/2	1/2	1/2	1/2	1/2	1/2	1/2	1/2	1/2	1/2
"	5/8	5/8	5/8	5/8	5/8	5/8	5/8	5/8	5/8	5/8	5/8	5/8	5/8	5/8	5/8	5/8	5/8	5/8	5/8	5/8	5/8	5/8	5/8	5/8	5/8
"	3/4	3/4	3/4	3/4	3/4	3/4	3/4	3/4	3/4	3/4	3/4	3/4	3/4	3/4	3/4	3/4	3/4	3/4	3/4	3/4	3/4	3/4	3/4	3/4	3/4
"	7/8	7/8	7/8	7/8	7/8	7/8	7/8	7/8	7/8	7/8	7/8	7/8	7/8	7/8	7/8	7/8	7/8	7/8	7/8	7/8	7/8	7/8	7/8	7/8	7/8
"	1	1	1	1	1	1	1	1	1	1	1	1	1	1	1	1	1	1	1	1	1	1	1	1	1
"	1 1/4	1 1/4	1 1/4	1 1/4	1 1/4	1 1/4	1 1/4	1 1/4	1 1/4	1 1/4	1 1/4	1 1/4	1 1/4	1 1/4	1 1/4	1 1/4	1 1/4	1 1/4	1 1/4	1 1/4	1 1/4	1 1/4	1 1/4	1 1/4	1 1/4
"	1 1/2	1 1/2	1 1/2	1 1/2	1 1/2	1 1/2	1 1/2	1 1/2	1 1/2	1 1/2	1 1/2	1 1/2	1 1/2	1 1/2	1 1/2	1 1/2	1 1/2	1 1/2	1 1/2	1 1/2	1 1/2	1 1/2	1 1/2	1 1/2	1 1/2
"	1 3/4	1 3/4	1 3/4	1 3/4	1 3/4	1 3/4	1 3/4	1 3/4	1 3/4	1 3/4	1 3/4	1 3/4	1 3/4	1 3/4	1 3/4	1 3/4	1 3/4	1 3/4	1 3/4	1 3/4	1 3/4	1 3/4	1 3/4	1 3/4	1 3/4
"	2	2	2	2	2	2	2	2	2	2	2	2	2	2	2	2	2	2	2	2	2	2	2	2	2
"	2 1/4	2 1/4	2 1/4	2 1/4	2 1/4	2 1/4	2 1/4	2 1/4	2 1/4	2 1/4	2 1/4	2 1/4	2 1/4	2 1/4	2 1/4	2 1/4	2 1/4	2 1/4	2 1/4	2 1/4	2 1/4	2 1/4	2 1/4	2 1/4	2 1/4
"	2 1/2	2 1/2	2 1/2	2 1/2	2 1/2	2 1/2	2 1/2	2 1/2	2 1/2	2 1/2	2 1/2	2 1/2	2 1/2	2 1/2	2 1/2	2 1/2	2 1/2	2 1/2	2 1/2	2 1/2	2 1/2	2 1/2	2 1/2	2 1/2	2 1/2
"	2 3/4	2 3/4	2 3/4	2 3/4	2 3/4	2 3/4	2 3/4	2 3/4	2 3/4	2 3/4	2 3/4	2 3/4	2 3/4	2 3/4	2 3/4	2 3/4	2 3/4	2 3/4	2 3/4	2 3/4	2 3/4	2 3/4	2 3/4	2 3/4	2 3/4
"	3	3	3	3	3	3	3	3	3	3	3	3	3	3	3	3	3	3	3	3	3	3	3	3	3
"	3 1/4	3 1/4	3 1/4	3 1/4	3 1/4	3 1/4	3 1/4	3 1/4	3 1/4	3 1/4	3 1/4	3 1/4	3 1/4	3 1/4	3 1/4	3 1/4	3 1/4	3 1/4	3 1/4	3 1/4	3 1/4	3 1/4	3 1/4	3 1/4	3 1/4
"	3 1/2	3 1/2	3 1/2	3 1/2	3 1/2	3 1/2	3 1/2	3 1/2	3 1/2	3 1/2	3 1/2	3 1/2	3 1/2	3 1/2	3 1/2	3 1/2	3 1/2	3 1/2	3 1/2	3 1/2	3 1/2	3 1/2	3 1/2	3 1/2	3 1/2
"	3 3/4	3 3/4	3 3/4	3 3/4	3 3/4	3 3/4	3 3/4	3 3/4	3 3/4	3 3/4	3 3/4	3 3/4	3 3/4	3 3/4	3 3/4	3 3/4	3 3/4	3 3/4	3 3/4	3 3/4	3 3/4	3 3/4	3 3/4	3 3/4	3 3/4
"	4	4	4	4	4	4	4	4	4	4	4	4	4	4	4	4	4	4	4	4	4	4	4	4	4
"	4 1/4	4 1/4	4 1/4	4 1/4	4 1/4	4 1/4	4 1/4	4 1/4	4 1/4	4 1/4	4 1/4	4 1/4	4 1/4	4 1/4	4 1/4	4 1/4	4 1/4	4 1/4	4 1/4	4 1/4	4 1/4	4 1/4	4 1/4	4 1/4	4 1/4
"	4 1/2	4 1/2	4 1/2	4 1/2	4 1/2	4 1/2	4 1/2	4 1/2	4 1/2	4 1/2	4 1/2	4 1/2	4 1/2	4 1/2	4 1/2	4 1/2	4 1/2	4 1/2	4 1/2	4 1/2	4 1/2	4 1/2	4 1/2	4 1/2	4 1/2
"	4 3/4	4 3/4	4 3/4	4 3/4	4 3/4	4 3/4	4 3/4	4 3/4	4 3/4	4 3/4	4 3/4	4 3/4	4 3/4	4 3/4	4 3/4	4 3/4	4 3/4	4 3/4	4 3/4	4 3/4	4 3/4	4 3/4	4 3/4	4 3/4	4 3/4
"	5	5	5	5	5	5	5	5	5	5	5	5	5	5	5	5	5	5	5	5	5	5	5	5	5
"	5 1/4	5 1/4	5 1/4	5 1/4	5 1/4	5 1/4	5 1/4	5 1/4	5 1/4	5 1/4	5 1/4	5 1/4	5 1/4	5 1/4	5 1/4	5 1/4	5 1/4	5 1/4	5 1/4	5 1/4	5 1/4	5 1/4	5 1/4	5 1/4	5 1/4
"	5 1/2	5 1/2	5 1/2	5 1/2	5 1/2	5 1/2	5 1/2	5 1/2	5 1/2	5 1/2	5 1/2	5 1/2	5 1/2	5 1/2	5 1/2	5 1/2	5 1/2	5 1/2	5 1/2	5 1/2	5 1/2	5 1/2	5 1/2	5 1/2	5 1/2
"	5 3/4	5 3/4	5 3/4	5 3/4	5 3/4	5 3/4	5 3/4	5 3/4	5 3/4	5 3/4	5 3/4	5 3/4	5 3/4	5 3/4	5 3/4	5 3/4	5 3/4	5 3/4	5 3/4	5 3/4	5 3/4	5 3/4	5 3/4	5 3/4	5 3/4
"	6	6	6	6	6	6	6	6	6	6	6	6	6	6	6	6	6	6	6	6	6	6	6	6	6

## BRASS AND BRONZE METAL WOOD SCREWS

Number of Screws	0	1	2	3	4	5	6	7	8	9	10	11	12	13	14	15	16	17	18	20	22	24	26	28	30
Diameter, Inches	.087	.071	.084	.097	.110	.123	.136	.150	.163	.176	.189	.203	.215	.228	.242	.255	.268	.281	.294	.321	.347	.373	.400	.426	.452
Length, Inches	1/4	1/4	1/4	1/4	1/4	1/4	1/4	1/4	1/4	1/4	1/4	1/4	1/4	1/4	1/4	1/4	1/4	1	1	1 1/4	1 1/4	1 1/4	1 1/4	1 1/4	1 1/4
"	3/8	3/8	3/8	3/8	3/8	3/8	3/8	3/8	3/8	3/8	3/8	3/8	3/8	3/8	3/8	3/8	3/8	1	1	1 1/4	1 1/4	1 1/4	1 1/4	1 1/4	1 1/4
"	1/2	1/2	1/2	1/2	1/2	1/2	1/2	1/2	1/2	1/2	1/2	1/2	1/2	1/2	1/2	1/2	1/2	1	1	1 1/4	1 1/4	1 1/4	1 1/4	1 1/4	1 1/4
"	5/8	5/8	5/8	5/8	5/8	5/8	5/8	5/8	5/8	5/8	5/8	5/8	5/8	5/8	5/8	5/8	5/8	1	1	1 1/4	1 1/4	1 1/4	1 1/4	1 1/4	1 1/4
"	3/4	3/4	3/4	3/4	3/4	3/4	3/4	3/4	3/4	3/4	3/4	3/4	3/4	3/4	3/4	3/4	3/4	1	1	1 1/4	1 1/4	1 1/4	1 1/4	1 1/4	1 1/4
"	7/8	7/8	7/8	7/8	7/8	7/8	7/8	7/8	7/8	7/8	7/8	7/8	7/8	7/8	7/8	7/8	7/8	1	1	1 1/4	1 1/4	1 1/4	1 1/4	1 1/4	1 1/4
"	1	1	1	1	1	1	1	1	1	1	1	1	1	1	1	1	1	1	1	1 1/4	1 1/4	1 1/4	1 1/4	1 1/4	1 1/4
"	1 1/4	1 1/4	1 1/4	1 1/4	1 1/4	1 1/4	1 1/4	1 1/4	1 1/4	1 1/4	1 1/4	1 1/4	1 1/4	1 1/4	1 1/4	1 1/4	1 1/4	1	1	1 1/4	1 1/4	1 1/4	1 1/4	1 1/4	1 1/4
"	1 1/2	1 1/2	1 1/2	1 1/2	1 1/2	1 1/2	1 1/2	1 1/2	1 1/2	1 1/2	1 1/2	1 1/2	1 1/2	1 1/2	1 1/2	1 1/2	1 1/2	1	1	1 1/4	1 1/4	1 1/4	1 1/4	1 1/4	1 1/4
"	1 3/4	1 3/4	1 3/4	1 3/4	1 3/4	1 3/4	1 3/4	1 3/4	1 3/4	1 3/4	1 3/4	1 3/4	1 3/4	1 3/4	1 3/4	1 3/4	1 3/4	1	1	1 1/4	1 1/4	1 1/4	1 1/4	1 1/4	1 1/4
"	2	2	2	2	2	2	2	2	2	2	2	2	2	2	2	2	2	1	1	1 1/4	1 1/4	1 1/4	1 1/4	1 1/4	1 1/4
"	2 1/4	2 1/4	2 1/4	2 1/4	2 1/4	2 1/4	2 1/4	2 1/4	2 1/4	2 1/4	2 1/4	2 1/4	2 1/4	2 1/4	2 1/4	2 1/4	2 1/4	1	1	1 1/4	1 1/4	1 1/4	1 1/4	1 1/4	1 1/4
"	2 1/2	2 1/2	2 1/2	2 1/2	2 1/2	2 1/2	2 1/2	2 1/2	2 1/2	2 1/2	2 1/2	2 1/2	2 1/2	2 1/2	2 1/2	2 1/2	2 1/2	1	1	1 1/4	1 1/4	1 1/4	1 1/4	1 1/4	1 1/4
"	2 3/4	2 3/4	2 3/4	2 3/4	2 3/4	2 3/4	2 3/4	2 3/4	2 3/4	2 3/4	2 3/4	2 3/4	2 3/4	2 3/4	2 3/4	2 3/4	2 3/4	1	1	1 1/4	1 1/4	1 1/4	1 1/4	1 1/4	1 1/4
"	3	3	3	3	3	3	3	3	3	3	3	3	3	3	3	3	3	1	1	1 1/4	1 1/4	1 1/4	1 1/4	1 1/4	1 1/4
"	3 1/2	3 1/2	3 1/2	3 1/2	3 1/2	3 1/2	3 1/2	3 1/2	3 1/2	3 1/2	3 1/2	3 1/2	3 1/2	3 1/2	3 1/2	3 1/2	3 1/2	1	1	1 1/4	1 1/4	1 1/4	1 1/4	1 1/4	1 1/4
"	4	4	4	4	4	4	4	4	4	4	4	4	4	4	4	4	4	1	1	1 1/4	1 1/4	1 1/4	1 1/4	1 1/4	1 1/4
"	4 1/2	4 1/2	4 1/2	4 1/2	4 1/2	4 1/2	4 1/2	4 1/2	4 1/2	4 1/2	4 1/2	4 1/2	4 1/2	4 1/2	4 1/2	4 1/2	4 1/2	1	1	1 1/4	1 1/4	1 1/4	1 1/4	1 1/4	1 1/4
"	5	5	5	5	5	5	5	5	5	5	5	5	5	5	5	5	5	1	1	1 1/4	1 1/4	1 1/4	1 1/4	1 1/4	1 1/4
"	5 1/2	5 1/2	5 1/2	5 1/2	5 1/2	5 1/2	5 1/2	5 1/2	5 1/2	5 1/2	5 1/2	5 1/2	5 1/2	5 1/2	5 1/2	5 1/2	5 1/2	1	1	1 1/4	1 1/4	1 1/4	1 1/4	1 1/4	1 1/4
"	6	6	6	6	6	6	6	6	6	6	6	6	6	6	6	6	6	1	1	1 1/4	1 1/4	1 1/4	1 1/4	1 1/4	1 1/4

**WEIGHT OF LAG SCREWS PER 100**

Length Under Head to Extreme Point	Diameter											
	$\frac{1}{8}$	$\frac{3}{16}$	$\frac{1}{4}$	$\frac{1}{2}$	$\frac{3}{4}$	$\frac{7}{8}$	1	1 $\frac{1}{8}$	1 $\frac{1}{4}$	1 $\frac{3}{8}$	1 $\frac{1}{2}$	
	lb.	lb.	lb.	lb.	lb.	lb.	lb.	lb.	lb.	lb.	lb.	lb.
1 $\frac{1}{2}$	4.2	6.5	9.2	13.0	...	...	...	...	...	...	...	...
1 $\frac{3}{4}$	4.7	7.1	10.0	13.8	...	...	...	...	...	...	...	...
2	5.2	7.7	10.9	14.0	23.0	24.8	...	...	...	...	...	...
2 $\frac{1}{4}$	5.7	8.4	11.8	16.1	24.5	27.3	...	...	...	...	...	...
2 $\frac{1}{2}$	6.2	9.2	12.7	17.4	26.0	29.0	43.0	...	...	...	...	...
3	7.2	10.6	14.6	19.0	29.2	32.9	48.3	75.0	...	...	...	...
3 $\frac{1}{2}$	8.2	12.0	16.6	21.5	32.5	36.9	53.8	78.5	90	...	...	...
4	9.2	13.5	18.8	24.0	35.9	41.0	59.6	82.0	99	...	...	...
4 $\frac{1}{2}$	10.2	15.0	20.7	26.5	39.3	44.9	65.5	86.0	108	...	...	...
5	11.3	16.5	22.8	29.0	42.7	48.8	71.5	90.0	118	150	...	...
5 $\frac{1}{2}$	12.4	18.0	24.9	31.5	46.1	52.7	77.5	98.0	128	163	...	...
6	13.5	19.5	27.0	34.0	49.5	56.6	83.5	106.0	138	176	240	...
7	...	...	31.1	39.0	56.3	64.5	95.5	122.5	158	203	270	...
8	...	...	35.2	44.0	63.1	72.5	107.6	139.0	178	230	300	420
9	...	...	...	49.0	69.9	80.5	119.8	155.5	198	257	332	468
10	...	...	...	54.0	76.7	88.5	131.0	172.0	219	284	365	516
11	...	...	...	...	83.5	96.5	143.1	188.5	240	311	395	564
12	...	...	...	...	90.5	104.5	155.4	205.0	261	338	425	612
13	...	...	...	...	...	112.5	167.6	221.5	282	365	459	660
14	...	...	...	...	...	121.0	179.8	238.0	304	393	493	710
15	...	...	...	...	...	129.5	192.0	255.0	326	421	527	760
16	...	...	...	...	...	138.0	204.0	272.0	348	449	562	810

**NUMBER OF LAG SCREWS IN 250-LB. KEG  
(Approximate)**

Length Under Head to Extreme Point	Diameter				
	$\frac{1}{8}$	$\frac{3}{16}$	$\frac{1}{4}$	$\frac{5}{16}$	$\frac{3}{8}$
1 $\frac{1}{2}$	5700	3700	...	...	...
2	4600	3300	1600	1000	...
2 $\frac{1}{4}$	3600	2800	1400	900	500
3	3000	2500	1300	800	450
3 $\frac{1}{2}$	2600	2300	1200	700	425
4	2300	1900	1000	625	375
4 $\frac{1}{2}$	2000	1700	850	550	325
5	1800	1500	700	500	300
5 $\frac{1}{2}$	1600	1400	650	450	275
6	1400	1250	600	375	250
7	...	1100	550	325	225
8	...	1000	475	270	200

**LAG SCREW TESTS**  
Screws drawn out of yellow pine

Diameter of Screw .....	$\frac{1}{8}$	$\frac{3}{8}$	$\frac{1}{2}$	$\frac{5}{8}$	1
Wood (deep) inches.....	$3\frac{1}{2}$	4	4	5	6
Drew out (lb.).....	4960	6000	7685	11500	12620

**STANDARD STEEL WIRE NAILS\***  
Sizes, Lengths, and Approximate Number per Pound

Sizes	Length (Inches)	COMMON		No. Per Pound
		Diameter		
		B. W. G.	Inch	
2d.....	1	16	.072	900
3d Com.....	1 $\frac{1}{4}$	14	.083	615
4d.....	1 $\frac{1}{2}$	12 $\frac{1}{2}$	.102	322
5d.....	1 $\frac{3}{4}$	12 $\frac{1}{2}$	.102	250
6d.....	2	11 $\frac{1}{2}$	.115	200
7d.....	2 $\frac{1}{4}$	11 $\frac{1}{2}$	.115	154
8d.....	2 $\frac{1}{2}$	10 $\frac{1}{2}$	.124	106
9d.....	2 $\frac{3}{4}$	10 $\frac{1}{2}$	.124	85
10d.....	3	9	.148	74
12d.....	3 $\frac{1}{4}$	9	.148	57
16d.....	3 $\frac{1}{2}$	8	.165	46
20d.....	4	6	.203	29
30d.....	4 $\frac{1}{2}$	5	.220	23
40d.....	5	4	.238	17
50d.....	5 $\frac{1}{2}$	3	.256	13 $\frac{1}{2}$
60d.....	6	2	.284	10 $\frac{1}{2}$

\* Common nails have flat heads and may be barbed or smooth. Brads have small circular heads and come in the same sizes as common nails. There is little difference in the weight of a common nail and a brad.

**SQUARE BOAT SPIKES**  
Approximate Number in a Keg of 200 Pounds

Size (In.)	Length of Spike (Inches)											
	3	4	5	6	7	8	9	10	11	12	14	16
$\frac{1}{4}$	3000	2375	2050	1825	...	...	...	...	...	...	...	...
$\frac{3}{8}$	1660	1360	1230	1175	990	890	...	...	...	...	...	...
$\frac{1}{2}$	1320	1140	940	800	660	600	525	475	...	...	...	...
$\frac{5}{8}$	...	...	...	600	590	510	400	360	320	230	...	...
$\frac{3}{4}$	...	...	...	450	375	335	300	275	260	240	...	...
$\frac{7}{8}$	...	...	...	...	...	260	240	220	205	190	175	160

## STRUCTURAL STRENGTH

As to proportions of vessels for strength, Lloyd's Rules state: "All vessels exceeding 14 lengths in depths to have special stiffening which must be approved by the Committee, and all exceeding  $13\frac{1}{2}$  depths must have a bridge extending over the midship half length of the vessel or such special compensation for extreme proportions as may be required by the Committee."

The American Bureau of Shipping Rules state: "Their rules apply only to steam vessels the length of which does not exceed 11 times their depth and to sailing vessels the length of which does not exceed ten times their depth. Vessels whose length to depth exceed these proportions must have their scantlings augmented and additional strengthening fitted."

For ordinary vessels of standard proportions built according to Lloyd's, the American Bureau of Shipping, or other recognized society, usually no strength calculations are made, but they are made for commercial craft of exceptional proportions, and for warships. Below are outlined strength calculations and the curves that can be plotted for them.

**Curve of Weights.\***—Divide the length of the vessel into a number of equal parts, and calculate the weight of the materials for one foot of length. These weights per foot are then set off from the base line on their respective ordinates and the points joined together, forming a jagged line which represents the hull weights.

Next calculate the weights of the cargo, coal, engines and boilers, and stores—and if a warship, of the guns and armor—which can be added as rectangles to the curve of hull weights. The machinery calculations can be divided as follows:

(1) **Boilers.**—Everything connected with the boilers as uptakes, funnels, pumps, etc., to be uniformly distributed over the length of the boilers.

(2) **Engines.**—Everything connected with the engines as condensers, pumps, etc., all being assumed to be uniformly distributed over the length of the bed plate.

(3) **Shafting.**—Weights are taken from the forward end of the thrust to the after end of the propeller shaft, and assumed to be distributed over this length. The weight of the bearings is to be included.

(4) **Propeller.**—The weight is assumed to be uniformly distributed over the length of the propeller boss.

\*Abstracts from Ship Cal. and Cons., G. Nicola.

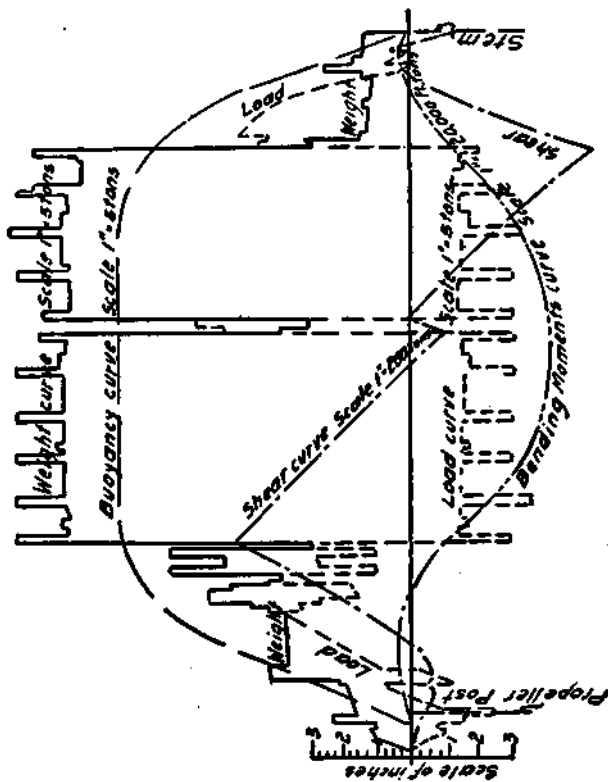

Figure 40.

The curves on Fig. 40 are of an oil tanker 474 ft. 6 in., over all, 483 ft. between perps., 60 ft. beam, depth to upper deck 36 ft. 3 in., block coefficient .805, designed to trim on an even keel with a draft of 22 ft. and a deadweight of 9000 tons, 8600 of which is oil, and the balance fuel, water and stores; has three decks. Engine  $\frac{24 \times 36 \times 51 \times 78}{81}$ , three boilers 14 ft. 4 in. dia. by 11 ft. 6 in. long, forced draught, engine indicates 3400 h. p., speed 12.3 knots, wheel 17 ft. 6 in. dia. by 10 ft. 6 in. pitch. Name of steamer John D. Rockefeller.

A curve including both the hull and machinery weights, and if a warship the guns and armor, can be plotted, the area of which is equal to the displacement of the vessel, and the center of gravity of this new curve should come over the center of buoyancy.

**Curve of Buoyancy.**—The above curve gives the weight per foot of a vessel and to find the support given it by the water, a curve of buoyancy is plotted. To do so, the displacement in tons per foot of length is calculated by finding the area of each section in square feet (the sections are preferably taken at the same intervals as selected when the calculation for the curve of weights was made), multiplying by 1, as a section is assumed as 1 ft. in length, and dividing the product by 35, to get the buoyancy in tons per foot of length in salt water. These quantities are laid off at the same intervals as selected for the curve of weights, and a curve through the points is known as the curve of buoyancy, the area of which should equal the displacement of the ship.

By examining the curve of buoyancy in conjunction with that of the curve of weights, the portion of the vessel where the weights exceed the supporting pressure due to the buoyancy of the water may be noted.

**Curve of Loads.**—By measuring the difference between the ordinates of the curves of weights and buoyancy, and laying them off on the same intervals, a curve of loads is obtained. Having this curve, a ship may be considered as a beam and the calculations pertaining to shearing and bending be made. For instance, suppose a vessel is supported at the bow and stern by a wave, leaving the middle portion unsupported. This is a case of a beam supported at the ends with a uniformly distributed load, if the weight per foot of length of the cargo and machinery space is the same. Or should the vessel be light and the machinery be amidships, this would be a case of a beam supported at the ends and loaded in the middle. Similarly a vessel may be supported at the middle by a wave, the weights at the ends tending to cause her to hog.

Thus by the formula  $\frac{p}{y} = \frac{M}{I}$  the stress on any portion of the hull may be obtained, but before using this formula there must be found: (1) the position of the neutral axis which passes through the center of gravity of the section; and (2) the moment of inertia of the section about the neutral axis.

Two calculations are necessary, one for the section under a hogging moment and the other under a sagging. In each case the posi-

tion of the neutral axis and moment of inertia of the section will be different.

As to the stresses in the materials in both instances, that above the neutral axis will be subjected to a different one than below. For materials in tension, allowance must be made for lightening and rivet holes, but in compression this is not necessary. Wood is commonly taken as being equivalent to  $\frac{1}{8}$  its area in steel for tension and compression, while armor is considered to be of no value in tension, but is in compression.

**Neutral Axis and Moment of Inertia Calculations.**—Take a plan of the midship section of a vessel with all the scantlings on it and draw a horizontal line one-half the depth of the section, assuming this line as the temporary neutral axis. Lay off a table as below, the areas being in square inches and the distance their center of gravities are from the assumed neutral axis in ft.

1	2	3	4	5	6	7	8
Items	Scantlings in Ins.	Effective Area in Sq. Ins.	Lever in Ft.	Moment	Lever in Ft.	Moment of Inertia	$\frac{1}{8} A \times h^2$
		A		M		I	i

In Column 5 some of the items are above the neutral axis and others below, hence the algebraic sum  $M$  of this column is divided by  $A$ , the sum of the effective areas, the quotient being the distance in feet the real neutral axis is from the assumed.

The levers in feet in Column 6 are the same as those in 4, and by multiplying these levers by the moments in Column 5, there is obtained the areas times the square of their distances from the assumed neutral axis, which are positive quantities, their sum being designated by  $I$ .

For the portions of the sections which are vertical as the strakes of shell plating at the water line, an addition is required for the moment of inertia of the items about axis through their own centers of gravity, which is given by the formula  $\frac{1}{8} A \times h^2$ . For portions of the sections which are horizontal as in the deck plating, where  $h$  is small, the additions may be neglected.



Thus the moment of inertia about the assumed neutral axis is  $I_A = I + i$ , and to transfer this moment to the true neutral axis, from  $I_A$  subtract the product of the effective areas  $A$  times the square of the distance  $d$ , the real neutral axis as found above is from the assumed neutral axis. Therefore the real moment of inertia  $= I_A - A \times d^2$ .

Knowing, then, the location of the neutral axis and the moment of inertia, by applying the formula  $\frac{p}{y} = \frac{M}{I}$  there can be calculated the stress on the material farthest from it.

*Example.* Steamer 350 ft. long, 50 ft. 4 ins. beam, 28 ft. molded depth, load displacement 9600 tons, draft 23 ft. 9 ins., neutral axis above base 12.82 ft., distance ( $y$ ) top of section from neutral axis 23.18 ft., moment of inertia about neutral axis 285442.

The maximum bending moment on a wave crest is usually taken as  $\frac{1}{35}$  of the displacement times the length, thus in the above steamer the maximum bending moment  $M$  is  $\frac{9600 \times 350}{35} = 96000$  foot-tons.

Using the formula  $\frac{p}{y} = \frac{M}{I}$ , where the greatest stress  $p$  in tons per square inch under a hogging strain  $= \frac{M}{I} = \frac{96000}{285442} = \frac{96000}{12314 \times 23.18} = 7.79$  tons per square inch.

Stresses as just given vary in different vessels, for in large ones a stress of 10 tons per square inch is considered safe on a standard wave length, that is, one supporting the bow and stern, for such a wave would doubtless never be encountered, while ships of 300 and 400 ft. have stresses of 6 to 7 tons.

For hogging as in the above the full area below the neutral axis is taken, and often  $\frac{1}{4}$  the full area above the axis to allow for rivet holes.

To obtain the greatest stress under a sagging strain, a new moment of inertia calculation is necessary, otherwise the work is the same. For sagging the full area above the axis is taken, and  $\frac{1}{4}$  the full area below the axis to allow for rivet holes.

**Curve of Shearing Stresses.**—Calculate the area of the curve of loads from the forward end, and at each interval (using the same intervals as when making the calculations for the curve of weights), set off the areas and draw a line through the points. The resulting curve is the curve of shearing stresses. From it the shearing force at any point in the length of a vessel may be expressed as the algebraic sum of all the stresses caused by the excess of weight or buoyancy from either end.

The shearing force in a ship amidships is usually zero, and is at a maximum about a quarter the length from each end. This in large ships calls for extra riveting, for Lloyd's Rules state: "In vessels of 480 ft. and upwards, the landing edges are to be treble riveted for one-fourth the vessel's length in the fore and after bodies for a depth of one-third the depth."

**Curve of Bending Moments.**—This is obtained from one of shearing stresses by taking the area from the forward end to any given ordinate and laying this area off perpendicular to the base line. A curve through the points gives the curve of bending moments. The bending moment at any point in the length of a vessel may be expressed as the algebraic sum of all the shearing stresses from either end.

The maximum bending moment may be approximately found by multiplying the displacement  $D$  by  $\frac{1}{16}$  to  $\frac{1}{8}$  of the length  $L$  of the ship, thus  $\frac{D \times L}{35}$ . See example above.

The minimum tension per square inch on the sheer strake equals  $\frac{\text{maximum bending moment} \times \text{distance neutral axis below sheer strake}}{\text{total moment of inertia}}$

In all the above calculations the ship is assumed to be in still water, but as this is seldom the case, the curves do not represent the true stresses as experienced when in a seaway where there is a continuous changing of excess weight over buoyancy. Hence ample factors of safety must be allowed.

**Transverse Section.**—As a vessel may be taken as a beam and calculations as outlined above made on her strength, the form of transverse or cross section is important. The average vessel may be assumed to have a rectangular one, and although such a section is a strong one, yet by adding a center longitudinal web or bulkhead its strength can be greatly increased, the web taking the strains to a large extent off the sides or shell plating, and furthermore serving as a support to the deck and deck beams.

Hence the importance of a fore and aft bulkhead, particularly in wide and shallow draft vessels, which should not be abruptly stopped but continued some distance as a girder with a gradually decreasing strength section. In many vessels it is not practical, owing to the nature of the cargo to be carried, to have a fore and aft bulkhead, and instead a heavy girder is connected to the under side of the deck beams, which is supported by widely spaced pillars. (See Pillars.) The depth from the tank top to the main deck

and the distance to the first tier of beams must not exceed a certain limit (see Lloyd's, British Corporation, etc.), for if they do the rules require the sizes of the frames and other parts to be increased.

Submarines are given circular, or nearly so, cross sections, for the reason that flat surfaces would require exceptional stiffening to prevent them from collapsing. For when a body is submerged in water every part of its surface is subjected to an equal pressure, viz., top, sides, and bottom, and the strongest form to resist these pressures is a circular one. Submarines have sufficient strength to sink to a depth of about 100 ft.; some have gone to 175 ft.

### SPECIFICATION HEADINGS

In preparing the specifications of a vessel it is often of service to have a list of the hull, engine, boiler and miscellaneous equipment that may be required. Below is a list that will serve as a guide.

#### *Introduction*

Dimensions, class and general characteristics of the vessel	Payments
Carrying capacity—passengers and freight—speed	Insurance
Classification Society	Trial
	Builder's guaranty

#### *Hull*

Frames, size of and spacing	Hatches
Web frames	Stem and stern posts
Floors	Rudder
Beams	Deck house
Beam brackets	Bridges
Keel	Masts and rigging
Keelsons	Watertight doors
Side stringers	Cement
Inner bottom	Bollards (bits) and chocks
Longitudinals	Rail and awning stanchions
Foundations for engines, boilers, pumps, etc.	Bulwarks
Pillars (stanchions)	Scuppers
Shell plating	Boat davits
Bilge keel	Anchor, chain, chain stoppers
Cargo ports	Joiner work—passengers', crew's and officers' quarters
Air ports	Cargo battens
Bulkheads	Painting
Deck plating	

*Machinery*

Engines—type, I. H. P.	Hot well
Steam	Evaporator
Revolutions	Covering of steam and exhaust pipes
Number and size of cylinders	Boilers—type and size of
Cylinders—liners	Steam
Relief valves and drains	Heating surface and grate area
Bed plate	Circulators
Columns	Gauges—steam and water
Connecting and piston rods	Fittings—safety valve, blow-off valve, feed water connections, etc.
Pistons	Grate bars
Water service	Covering
Lubricating system	Draught—natural or forced
Valves—piston—slide	Fans—capacity—turbine or steam engine driven.
Reversing gear	Uptake and stack
Turning gear	Boiler feed pumps
Throttle valve	Injectors
Separator	Floor plates in engine and boiler rooms
Shafting—crank—thrust—line	Spare parts for engine, boilers, and auxiliary machinery
Bearings—linings	Fuel oil pumps
Propeller—size—blades bolted on—material	Superheaters
Fairwater	
Condenser—type	
Sq. ft. of cooling surface	
Fittings	
Air pumps	
Circulating pump	
Feed water heater	

*Systems and Equipment*

Electric	Ventilating
Size and type of generating units	Pressure or exhaust
Location	Fans
Light and power circuits	Ducts
Wiring system—size of wires and conduits	Ventilators
Switchboard	Plumbing
Number of lights, size and where located	Toilets, washstands, bath tubs
Searchlights	Check valves on discharge pipes
Storage batteries	Drainage
Heating	Pumps
Steam, thermotank or electric	Sluice valves
	Strainers

*Systems and Equipment—Continued*

Fire systems	Signals. If a U. S. vessel, see U. S. Steamboat Inspection Rules
Water and steam	
Pumps	
Hose	
Fresh water	Navigating instruments
Pumps	
Tanks	Tarpaulin covers
Refrigeration system	Baking outfit
CO <sub>2</sub> , ammonia or dense air	
Insulation	Galley outfit
Ship machinery	Pantry outfit
Steering engine	
Capstan	Glassware
Windlass	
Winches	Dishes
Interior communication	Cutlery and plated ware
Signal system between pilot house and engine room	
Life boats, rafts and life preservers. If a U. S. vessel, see U. S. Steamboat Inspection Rules.	Linen
Carpenter's stores	Bedding
Boatswain's stores	Flags
Lights	Wireless
	Storm oil

**HULL WEIGHTS**

The difference in finished steel weights of a ship built to Lloyd's, Bureau Veritas, and British Corporation Rules is very small. For quickly determining the approximate weight of a steel hull either of the formulæ given below may be used; one is known as the cubic and the other as the surface foot.

**Cubic.**—Weight of finished steel in hull in lb. = length  $\times$  breadth  $\times$  depth  $\times$  coefficient. The coefficient varies from .0036 to .0043, the larger coefficient for vessels having the greatest ratio of length to depth and breadth to depth.

**Surface Foot.**—Let  $d$  = depth of vessel measured from the bottom of the flat plate keel to the uppermost continuous deck. Then surface foot = length  $\times$  (breadth +  $2d$ ). The pounds per square foot vary from 97 to 125 and taking a mean value of 111, the surface foot found by the formula, length  $\times$  (breadth +  $2d$ ) multiplied by 111 will give the weight in lb. of the finished steel in a vessel.

Of the total weight of hull steel, from 70 to 80% is taken up by the keel, frames, beams, keelsons, deck and shell plating. The remaining 30 to 20% represents bulkheads, engine foundations, masts, etc.

Percentages of total angles and plates for ordinary vessels of about 400 ft. long and .75 coefficient, built to Lloyd's 100 A. I. three deck class, with deep framing in lieu of hold beams, and with double bottoms, are given in the following table. C is a steamer built to British Corporation Rules of the highest class, but otherwise similar to A and B.

TABLE OF WEIGHTS\*

Items	A	B	C
	Steamer	Steamer	Steamer
	Per cent.	Per cent.	Per cent.
Main frames and reverses.....	7.5	7.6	7.2
Tank frames and reverses.....	2.1	2.2	1.5
Connecting angles, etc., in tank.....	1.8	2.0	1.7
Hatches.....	1.7	1.3	3.2
Side keelsons.....	4.4	6.2	3.8
Main deck plating.....	5.8	5.8	6.2
Upper deck plating.....	6.9	6.3	6.3
Main deck beams.....	3.3	2.7	2.2
Upper deck beams.....	2.2	2.2	1.8
Casings.....	2.4	1.7	2.4
Floors and Intercostals.....	10.4	10.0	7.8
Center longitudinal and margin plate.....	1.8	1.7	1.7
Tank top.....	4.8	4.6	3.5
Tunnel.....	1.6	2.1	1.9
Bulkheads.....	4.8	4.2	3.0
Shell.....	26.8	26.4	26.6
Erections.....	3.3	3.9	5.8

\* From A Class Book on Naval Architecture, W. J. Lovett.

## STEEL WEIGHTS OF A STEAMER\*

430 ft. long, 46 ft. beam, 34 ft. 3 ins. deep, built to Lloyd's 3-deck rule.

Part of Hull	Weight in Tons	
Keel bars and stem.....	3.5	
Stern post, rudder frame and struts	20.0	
Frames, reverse frames and doublings.....	275.0	
Floors and tail plates.....	301.0	
Beams and carlings.....	225.4	
Keelsons.....	142.5	
Bulkheads (W. T.).....	102.7	
Bunker casings.....	40.0	
Engine and boiler seats.....	25.0	
Shaft tunnel and stools.....	37.7	
Inner bottom plating.....	119.4	
Shell plating, including bulkhead liners.....	734.2	
Stringers and ties.....	217.6	
Deck plating.....	305.3	
Cargo and coal hatches.....	37.5	
Engine and boiler casings.....	77.6	
Deck houses.....	140.0	
Sundry deck and hold work.....	25.0	
Fresh water tanks.....	13.2	
Slip iron.....	57.0	
Molding and copes.....	46.5	
Rivet heads.....	44.0	
Finished steel, weight.....	2990.0	
		<i>Summary</i>
		Tons
		Forgings..... 6.0
		Angles..... 587.0
		Plates..... 2063.6
		Bulb Tee.... 168.4
		Slips..... 57.0
		Moldings.... 46.5
		Castings.... 17.5
		Rivet heads.. 44.0
		Total..... 2990.0

\* From the Naval Constructor, G. Simpson.

See also table of Merchant Vessels.

## MACHINERY WEIGHTS

Total weight of machinery (steam engine, boilers, water, etc.) is about 448 lb. per i. h. p. for forced draught boilers and 558 lb. per i. h. p. for natural draught.

The i. h. p. per ton of engines, boilers, and water (that is, water in boilers) is about 5.5. Thus the machinery weight of a steamer 460 ft. long, 58 ft. beam and 27 ft. draft, having an engine of 4,000 i. h. p. would be  $\frac{4000}{5.5} = 730$  tons approximately.

or making a preliminary estimate note the following weights:

Main engines.....	60 lb. per i. h. p.
Shafting and wheel.....	40 lb. per i. h. p.
Condensing equipment.....	15 lb. per i. h. p.
Auxiliary machinery.....	20 lb. per i. h. p.
Piping.....	15 lb. per i. h. p.

Boilers, see following tables, also section on Boilers.

Total machinery of stern wheelers built to run on the Mississippi River (U. S.) weigh from 415 to 530 lb. per i. h. p.

The sum of the cylinder diameters in feet multiplied by 2.4 to 2.5 gives an average length of the engine room in feet for a triple expansion engine. If all the pumps are independent of the engine the above length should be slightly increased.

The total length of the boiler room with single end Scotch boilers and one stokehold is equal to the length of the boilers multiplied by about 1.83. When there is a common stokehold for boilers arranged fore and aft, it is usual to allow 2 ft. to 2 ft. 6 ins. more than for a single stokehold. An approximate figure for the total weights in a boiler room in tons may be obtained by multiplying the volume of the boilers in cubic feet by .04 to .05 depending on whether the boilers have natural or forced draft.

(From Mar. Eng'g Estimates, C. R. Bruce.)

## MACHINERY WEIGHTS\*

Engines	I. H. P.	Boiler Press	Engine	Weight of Boilers	Funnel, Mounting, etc.	Water	Total	Weight Per I. H. P.
			(tons)	(tons)	(tons)	(tons)	(tons)	(tons)
19 × 30 × 50	860	160	68	35.8	8.5	20.7	133.	.154
33								
22 × 35 × 57	1383	160	105	62.5	17.6	35.	221. <sup>1</sup>	.16
42								
24 × 38 × 62	1585	160	125	64.	20.9	46.	363.9 <sup>2</sup>	.166
42								
24 × 39 × 64	1798	160	93	80.	12.4	52.	237.4	.133
33								
30 × 46 × 75	2600	160	157	116.5	31.4	80.	385.75	.148
45								
31 × 50 × 82	2850	160	251	146.	42.5	82.5	535.5 <sup>3</sup>	.184
57								

\* Marine Eng'g, Seaton. <sup>1</sup> Includes 2 tons of spare gear. <sup>2</sup> Includes 8 tons of spare gear. <sup>3</sup> Includes 3.5 tons of spare gear.



## WEIGHTS OF ENGINES ALONE\*

Horse Power	Type	Weight Lb.
12.....	Compound	290
25.....	"	590
70.....	"	1,509
90.....	"	3,050
75.....	Triple	1,075
150.....	"	2,100
200.....	"	3,050
275.....	"	4,450
325.....	"	5,900
425.....	"	10,000
550.....	"	12,992
800.....	"	17,024
1,000.....	"	22,200
1,500.....	"	32,150

\* High speed engines built by Chas. Seabury & Co., New York.

**Boiler Weights.**—Weight of Scotch boilers without water per sq. ft. of heating surface is from 25 to 30 lb., and for water tube 12 to 20. The weight of the contained water per square foot of heating surface is from 12 to 15 lb. for Scotch boilers and from 1.5 to 3 lb. for water tube. Thus Scotch boilers with water will weigh from 30 to 35 lb. per square foot of heating surface, and water tube will weigh from 13.5 to 23 lb.

Weight of 3-furnace single-end Scotch boiler, 10 ft. 6 ins. long by 13 ft. 6 ins. dia., without water	25 tons
Weight of water.....	15
<b>Total.....</b>	<b>40 tons</b>

Weight of 3-furnace double-end Scotch boiler, 18 ft. long, 13 ft. 6 ins. dia., without water.....	45 tons
Weight of water.....	25
<b>Total.....</b>	<b>70 tons</b>

Three-furnace double-end Scotch boiler, 21 ft. 10 ins. long by 16 ft. 5 ins. dia., weighed empty, 105 tons. Twenty-nine such boilers were installed on the White Star steamer *Britannic* (1915).

[Steamer *Britannic* mentioned above sunk in European War 1916.]

Four-furnace single-end Scotch boiler, 11 ft. long by 16 ft. dia., without water.....	40 tons
Weight of water.....	20
Total.....	<hr/> 60 tons

Four-furnace double-end Scotch boiler, 20 ft. long by 16 ft. dia., without water.....	70 tons
Weight of water.....	40
Total.....	<hr/> 110 tons

**Formula for Finding Weight of a Single or Double-End Scotch Boiler.**

Let  $D$  = diameter of boiler in feet

$L$  = length of boiler in feet

$P$  = working pressure

$C$  for ordinary single-end boilers = 725

$C$  for ordinary double-end boilers = 765

$$\text{Weight of bare boiler in tons} = \frac{D^2 \times L \times \sqrt{P}}{C}$$

**Formula for Finding Weight of Water (assumed to be cold) in Scotch boilers.**

Assume the water to be 7 ins. above the top of the combustion chamber

$D$  = diameter of boiler in feet

$L$  = length of boiler in feet

$$\text{Weight of water in tons} = \frac{D^2 \times L}{100}$$

**Miscellaneous Weights.**

Ordinary fire bars, 5 ft. 6 ins. long..... 66 lb.

Ordinary fire bars, 5 ft. 0 ins. long..... 60 lb.

Howden's fire bars, 5 ft. 9 ins. long..... 47 lb.

Howden's fire bars, 5 ft. 6 ins. long..... 45 lb.

Weight of fire bricks 140 lb. per cubic foot.

Weight of covering (lagging) about one-half a pound per square foot.

**WEIGHTS OF WATER TUBE BOILERS<sup>1</sup>**  
(No water included.)

Grate Surface Sq. Ft.	Heating Surface Sq. Ft.	Weight Lb.
3.5	120	1,290
4.94	222	2,170
9.5	333	4,020
12.25	516	6,520
8.48	307	3,550
12.9	521	5,500
21.0	750	8,180
33.4	1,087	9,670
41.0	1,310	14,100
39.5	1,649	16,500
53.75	1,920	22,680
77.57	2,846	29,460
52.0	<sup>2</sup> 1,650	17,000
101.0	<sup>2</sup> 3,300	30,000

<sup>1</sup> Boilers built by Chas. Seabury & Co., New York. They have a single steam drum connected to two lower or mud drums, one on each side, by two nests of bent tubes inclosing a large combustion chamber.

<sup>2</sup> Special.

Finished Weight of Machinery, "Steam Up," cargo steamer 377 ft. bet. perps., 49 ft. 3 ins. beam, 28 ft. 9 ins. deep, draft 23 ft. 6 ins., displacement 9750 tons, block coefficient .78. Two single end Scotch boilers 16 ft. dia. × 12 ft. long, 180 lbs. working pressure, each with three furnaces, Howden's forced draught, total heating surface 6200 sq. ft., total grate area 120 sq. ft., engine  $\frac{25 \times 41 \times 68}{48}$ , 68 revs. per min., 1. H. P. 1900, giving a speed of 10½ knots.

	Tons	Tons
Main Boilers (bare)	109.0	
Boiler mountings	1.2	
Furnace fittings (ex. fronts)	5.1	
Smoke boxes	6.25	
Funnel and fittings	10.15	
Ventilators	3.0	
Floor plates, gratings, etc.	4.2	
Sundries in boiler room	3.2	
Water in main boilers	57.0	
Legging	6.0	
Fire bricks and clay	2.1	207.20

	Tons	Tons
<b>Howden's Forced Draft</b>		
Fan engine.....	2.5	
Furnace fronts.....	3.15	
Retarders.....	1.75	
Air trunks and heater boxes.....	4.6	12.00
<b>Main Engines—proper.....</b>	<b>107.0</b>	
Condenser.....	9.5	
Thrust shaft and block.....	7.25	
Tunnel and propeller shaft.....	45.85	
Pipes, valves and pieces.....	9.0	
Ballast pipes and chests.....	5.7	
Floor plates, gratings, etc.....	11.8	
Special spare gear.....	12.0	
Outfit and sundries in engine room.....	5.0	
Water in engines.....	4.5	
Lagging.....	1.0	218.60
<b>Auxiliaries</b>		
Weir's pumps and heater.....	3.8	
Filter.....	.8	
Evaporator.....	2.5	
Ballast pump.....	1.6	
Donkey pump.....	.4	
Fresh water donkey pump.....	.3	
Telegraphs.....	.1	
Ash hoist.....	.8	
Auxiliary condenser.....	1.4	11.70
<b>Winch Outfit</b>		
Donkey boiler (complete).....	20.0	
Feed pump for.....	.3	
Winch pipes.....	5.2	25.50
<b>Total Weight of Machinery, "Steam Up".....</b>		<b>475.00</b>

[Above steamer from Marine Eng'g Estimates, C. R. Bruce.]

#### WEIGHTS OF DIESEL ENGINES

500 h. p. Diesel engine in motor ship *Vulcanus*, 180 r. p. m., engine alone weighed 42 tons or 188 lb. per b. h. p., entire plant with piping reservoirs, etc., 85 tons, equivalent to 380 lb. per b. h. p.

Twin Diesel engines with a total of 1,600 h. p. in motor ship *Monte Penedo*, both weighed 110 tons, engines alone, piping reservoirs, and accessories 44 tons, reserve air compressor about 6 tons, total 224 lb. per b. h. p.

See also section on Diesel Engines.

#### DATA ON VESSELS

**Merchant Vessels.**—Under this heading are included ocean-going vessels for carrying passengers and freight. See also sections on Types and Structural Features.

PASSENGER AND CARGO STEAMERS

Length between perpendiculars.....	150' 0"	170' 0"	210' 0"	250' 0"	300' 0"	350' 0"	400' 0"	405' 0"
Breadth molded.....	30' 0"	32' 0"	31' 0"	34' 0"	35' 10"	44' 0"	43' 9"	49' 9"
Depth.....	10' 0"	17' 6"	24' 1"	26' 8"	36' 10 1/2"	33' 0"	28' 6"	31' 5"
Draft loaded.....	9' 0"	9' 0"	15' 8"	20' 9"	21' 0"	23' 0"	24' 9"	22' 0"
Block-coefficient.....	.69	.69	.62	.67	.66	.67	.66	.64
Height of metacenter above top of keel.....	17.72'	.....	.....	14.2	.....	20.8	20.8	.....
Height of center of gravity above top of keel.....	9.53'	.....	.....	13.08	.....	19.16	19.92	.....
Displacement (tons, 2240).....	754	923	1721	3289	6000	6780	7243	7233
Gross tonnage (tons).....	420	713	1021	1543	3195	3616	4133	5304
Dead-weight cap (tons).....	363	420	672	1804	1039	3920	3762	2675
Cargo cap. (cu. ft.).....	22,720	36,000	.....	.....	.....	194,900	118,900	82,040
Coal (tons).....	45	47	190	303	993	517	1200	1085
Weight of hull (tons).....	300	374	804	1,185	2,212	2,380	2,619	3490
Weight, machinery and water.....	86	130	255	300	820	519	842	1050
Engines.....	Twin Screw	Twin Screw	21 X 33 X 46	26 X 46	35 X 51 X 77	30 X 45 X 70	40 X 64 X 92	42 X 66 X 92
	15 X 30	11 X 17 X 28	21 X 33 X 46	26 X 46	35 X 51 X 77	30 X 45 X 70	40 X 64 X 92	42 X 66 X 92
	21	21	36	36	44	64	60	66
I. H. P. (total).....	500	790	1,500	1,280	9,330	2,750	5,000	6500
Revolutions.....	166	146	93	109	115	71	77	66
Boiler pressure (lb.).....	100	150	170	100	130	125	140	150
Length of Engine Room.....	.....	35' 0"	23' 10"	20' 0"	51' 0"	24' 0"	28' 0"	32' 0"
Length of Boiler Room.....	.....	35' 0"	18' 4"	20' 0"	65' 0"	36' 0"	55' 0"	79' 9"
Propeller diameter.....	5' 6"	7' 0"	13' 0"	9' 0"	14' 6"	17' 9"	19' 10"	20' 0"
Propeller pitch.....	10' 0"	10' 6"	17' 6"	16' 0"	19' 0"	23' 6"	28' 6"	31' 0"
Propeller area, flat (sq. ft.).....	16.32	.....	60	68	120	80	110	130
Propeller, projected.....	10.8	.....	46	48	91	68	82	94
Speed, knots.....	9.3	.....	13.4	11.9	18	13.8	16	17
Passengers.....	12	20	.....	.....	.....	12 1st	200 1st 40 2d 1000 3d	176 1st 40 2d 396 3d

CARGO STEAMERS

Length *.....	210' 0"	315' 0"	330' 0 3/4"	380' 0"	340' 0"	340' 0"	340' 0"	340' 0"	340' 0"	470' 0 A. 485' 0" 380' 0"
Breadth.....	30' 35'	34' 11" 35' 0"	37' 38'	40' 39' 0"	40' 5" 39'	40' 5" 39'	40' 5" 39'	40' 5" 39'	40' 5" 39'	40' 5" 39'
Depth (amidships).....	15' 0"	17' 0"	17' 0"	17' 0"	17' 0"	17' 0"	17' 0"	17' 0"	17' 0"	17' 0"
Dead (load).....	1000	1200	1580	2000	2400	2400	2400	2400	2400	2400
Deadweight (Tons).....	40,000	60,000	105,000	155,000	155,000	155,000	155,000	155,000	155,000	155,000
Capacity (Tons).....	80	100	140	180	180	180	180	180	180	180
Grain Tonnage.....	87	104	140	180	180	180	180	180	180	180
Net Tonnage.....	47 1/2	56 1/2	81	105	105	105	105	105	105	105
Number of Decks.....	3	3	3	3	3	3	3	3	3	3
Number of Holds.....	2	2	2	2	2	2	2	2	2	2
Number of Hatchets.....	3-30' X 12'	15' 5" X 10' 0" 17' 3" X 10' 0" 17' 3" X 10' 0"	13' 5" X 11' 8" 22' 0" X 11' 8" 24' 11" X 11' 8" 17' 3" X 11' 8"	4-24' X 16'	4-24' X 16'	4-24' X 16'	4-24' X 16'	4-24' X 16'	4-24' X 16'	4-24' X 16'
Bowport (Tons).....	17 1/2	22 1/2	30	33	33	33	33	33	33	33
Water Ballast (Tons).....	210	200	309	406	406	406	406	406	406	406
Engines.....	17 X 25 X 46	17 X 25 X 47	17 X 20 X 45	20 1/2 X 35 X 54	21 X 40 X 60	21 X 42 X 65	21 X 39 X 60	21 X 41 X 67	25 X 43 X 65	25 X 47 X 70
I. H. P.....	750	900	1	1,720	1,720	1,720	1,720	1,720	1,720	1,720
Boilers.....	3	2	1	3	3	3	3	3	3	3
Stowage.....	140	150	150	150	150	150	150	150	150	150
Standing Berths.....	.....	.....	.....	.....	.....	.....	.....	.....	.....	.....
Consumption per 24 hours (Tons).....	12	13	9	15	15	15	15	15	15	15
Speed.....	11	11	11	11	11	11	11	11	11	11
Specification.....	4 windows	3 windows	4 windows	6 windows	8 windows	8 windows	8 windows	8 windows	8 windows	8 windows
Name.....	.....	.....	.....	.....	.....	.....	.....	.....	.....	.....
Nationality of Ship.....	.....	.....	.....	.....	.....	.....	.....	.....	.....	.....
Remarks.....	2 twin masts 2 derricks on each	160 Cases Norwegian 23 vents	Full Norwegian	Full English	Full English	Full English	Full English	Full English	Full English	Full English

\* Length = length between perpendiculars. † Deadweight includes ton in ballast. ‡ Per-  
centage ballast only.



**Harbor Vessels and Steam Yachts.**—Under this heading are included steamers engaged in the excursion business carrying passengers and freight for short distances but never out of sight of land, also tugs and lighters. See pages 314 and 315.

Excursion steamers are usually side wheelers, although stern wheelers are very common on the Mississippi River and its tributaries. Side wheelers with large deck areas are obtained by extending the decks over the hull. In estimating on the carrying capacity, 7 sq. ft. per person is a fair average. Few are built to the rules of any society or with double bottoms, the owners following the structural details of their previous vessels. The frames are often of bulb angles with the top of the floor plates flanged over, thus doing away with reverse frames. In long, shallow draft vessels, the hull is strengthened by longitudinal trusses from the floors to the main deck. Above the main deck there may be several uprights or posts over which pass rods that are connected to the hull at both ends to prevent it from sagging. The deck beams may be of bulb angles with one on every frame. The guard beams should be bracketed to the sheer strake and secured to the lodger plate instead of the main deck beams extending from outside to outside. Guard braces may be of trusses, pipe, or solid bars. Sponsons are required only on the largest steamers.

The machinery of side wheelers varies from the old simple beam engine to the modern compound and three-cylinder compound inclined and four-cylinder compound double inclined. The simple beam engine has great durability, low initial cost and low maintenance. The boilers for this type of engine are of the flue and return tubular type having a working pressure of around 55 lb., with long grates, high fire boxes, and simple forced draught, both under and over the grates. With inclined engines, they have Scotch boilers, steam 130 to 180 lb., equipped with Howden's forced draught system. Stern wheelers have horizontal engines (see section on Marine Engines).

Tugs for ocean towing are preferably of steel, while for harbor service of wood, as also are lighters. Steam yachts of 150 ft. or over have steel hulls. Tugs and yachts having steel hulls are usually built to the rules of a classification society.

**Motor Ships.**—These are built with steel hulls, classed by Lloyd's or other society, and engage in foreign and domestic trade. They are driven by Diesel or semi-Diesel engines, the auxiliaries (winches,



## EXCURSION VESSELS, TUGS,

Type of Vessel	Length Between Perpendiculars	Beam	Depth	Draft	Material of Hull	Carrying Capacity
Tug.....	70' 6" 75' 0" O.A.	18' 8"	7' 6"	4' 3"	Wood	....
Tug.....	100' 0" O.A.	23' 0"	11' 3"	....	Wood	....
Tug.....	90' 0" O.A.	20' 0"	9' 8"	9' 0"	Wood	....
Tug.....	102' 0"	23' 7"	13' 0"	12' 6"	Wood	....
Tug.....	119' 6" 130' 0" O.A.	25' 9"	16' 3"	12' 0"	Steel	....
Tug.....	158' 0" 165' 0" O.A.	29' 4"	19' 0"	....	Steel	....
Lighter.....	95' 0"	23' 0"	9' 0"	....	Steel	220 tons
Lighter.....	110' 0"	30' 0"	11' 6"	....	Steel	450 tons
Day Excursion ..	130' 0"	23' 0"	12' 0"	....	Steel	500 pas- sengers
Stern Wheel..... Western River	135' 0" 156' 0" O.A.	23' 4"	4' 6"	3' 0"	Steel	....
Side Wheel Excursion..	180' 0"	32' 0", over guards 54' 0"	9' 0"	5' 0"	Steel	1000
Side Wheel Excursion..	180' 0"	31' 0", over guards 53' 0"	12' 0"	....	Steel	....
Side Wheel Excursion..	190' 0"	34' 0", over guards 60' 0"	11' 7"	7' 0"	Wood	2300
Side Wheel Excursion..	200' 0" 211' 0" O.A.	33' 0", over guards 59' 0"	9' 0"	4' 0"	Steel	....
Screw passenger.....	200' 0" 213' 0" O.A.	35' 0", over guards 42' 0"	17' 3"	12' 0"	Steel	54 1st 46 3d
Side wheel passenger...	250' 0" 233' 0" O.A.	35' 0", over guards 63' 6"	11' 6"	....	Steel	....
Steam Yacht.....	183' 0" 185' 0" O.A.	23' 0"	11' 0"	....	Wood	....

## LIGHTERS AND STEAM YACHTS

Engines	I.H.P.	Boilers	Steam, Lb.	Speed, Miles Per Hour	Remarks
Twin screw 8 × 15 13	total 300	Water tube; grate surface, 35 sq. ft.; heating surface, 119 sq. ft.	200	11	Oil burner, 1,700 gal. of oil; fresh water, 1,300 gals; condenser, 500 sq. ft.; wheel, 3' 10" dia.
18 × 23 23	450	One 12' dia. by 11' 7" long; grate, 54 sq. ft.; heating, 1772	165	12	Condenser, 632 sq. ft.; wheel, 8' 0" dia. by 10' 9" pitch.
14 × 20 30	....	Loss, type; 8' 4" dia.; 12' 0" long; grate, 50 sq. ft.; heating, 1,300 sq. ft.	125	12	Bunker, 20 tons; fresh water, 2,000 gals; cond., 550 sq. ft.; wheel, 7' 4" dia.; 10' pitch.
15 × 23 22 138 rev.	580	One—11' 3" dia. by 12' 8" long; three 36" furnaces; grate surface, 54 sq. ft.; heating surface, 1,385 sq. ft.	160	13	Cooling surface of condenser, 843 sq. ft.; wheel, 8' 0" dia. by 10' 9" pitch; coal bunker 50 tons; fresh water, 6,900 gallons.
23 × 48 35 120 rev.	1250	Two—14' 6" dia. by 12' long	140	..	Total heating surface of boilers, 4,000 sq. ft.; grate, 168 sq. ft.; condenser, 2,500 sq. ft.
17 × 27 × 45 36	1100	Two—12' 0" dia. by 1' 2" long	175	..	Tow 3 barges of a total capacity of 4,000 tons at 9 knots; bunker, 300 tons.
13 × 25 18	....	One boiler 10' 0" dia. by 10' 0" long	125	..	Surface condensing; wheel 6' 9" dia.; 4 blades.
Single 23 — 26	....	One boiler 10' 0" dia. by 16' 0" long	125	..	.....
18 × 26 30	650	Two water tube; heating surface, 3,350 sq. ft.; grate, 100 sq. ft.	...	..	Weight of boilers and water, 20 tons.
Comp. horizontal 12" & 24" by 6' stroke	400	Western river type, 3 of, 40" dia. by 28' long	180	10	Stern wheel; Western river, 19' 6" dia., by 18' wide, 30 buckets.
Single inclined 25" dia. by 7' stroke	600	Two cylindrical, 10' 3" dia. by 10' 9" long	93	14	Paddle wheels 18' 5" dia., 7' 6" long, 3' wide. Displacement, 480 tons; surface condenser, 1,380 sq. ft.
Single, 42" dia. by 10' stroke	....	.....	60	..	Paddle wheels, 24' dia.; coal bunkers, 25 tons; fresh water, two tanks, each 750 gallons.
Single, 52" dia. by 9' stroke	1400	Two wagon top	52	19	Paddle wheels, 23' 6" dia.; 11 buckets.
Single, 51" dia. by 8' stroke	....	One wagon top, 10' dia. by 27' long	50	..	Surface condensing; wheels, 20" dia.; 35 rev. per min.
18 × 29 × 48 30	1380	Two boilers, 10' 8" dia. by 12' 9" long	...	15	26 state rooms, river service; wheel, 10' 8" dia.; 4 blades.
Single cylinder, 55" dia. by 10' stroke	1800	Two, 9' 6" dia. by 26' 6" long	50	21	Jet condenser.
15½ × 21 × 34 21	....	Two water tube; heating surface, 3,748 sq. ft. grate surface, 95 sq. ft.	...	18	Carries 10,000 gal. of water, 100 tons of coal.

**MOTOR SHIPS**  
(See also Diesel Engines)

Length between perpendiculars.....	185' 0"	875 tons deadweight. Single engine, six-cylinder, four cycle Westport Diesel, 650 h. p. at 175 rev., direct reversible, located aft. Name of ship, Lora, built to carry oil in bulk. Fuel consumption of engine about 3 pound per horse power.	Notes:
Breadth.....	32' 6"	1630 tons deadweight. Two 320 h. p. four-cylinder Babcock direct reversible engines, 250 rev. Total weight of machinery, 81 tons. Crude oil consumption on long trips fully loaded, speed, 8 knots, was 85 pound per ton in bulk.	
Depth.....	18' 0"	190' 0"	
Draft.....	11' 6"	40' 0"	
		17' 0"	
		275' 0"	Lumber vessel. Machinery, aft. Three holds; for d. 42, 600 cu. ft.; main, 51,500; aft, 45,000; total, 140,000 cu. ft. 6-cylinder Diesel, 1000 h. p.; speed, 9 to 10 knots; consumption, 3 1/2 tons of fuel oil per 24 hours. Has double bottom, fuel oil bunker, 140 tons.
		336' 0"	6550 tons deadweight. Two six-cylinder reversible four-cycle Diesel engines (Barnes & Wain), 21 1/2 in. dia. by 28 1/2 in. stroke, each 1000 h. p., total 3000. For particulars see Diesel Engines aft; engine room, 40 ft. long; speed, 11.41 knots at 2033 h. p., 158 rev.; fuel consumption, 679 pound of oil per horse power hour. Auxiliary two four-cycle Diesel engines of about 200 h. p. each at 225 rev., driving each a dynamo and a compressor for air of 300 to 375 lb. stored in two reservoirs for starting purposes. All pumps and winches electrically driven. Heating is provided by a small oil-fired donkey boiler. Total weight of all machinery about 440 tons. Name of vessel, Pacific.
		368' 0"	7000 tons deadweight. Two six-cylinder four-cycle Diesel engines (Barnes & Wain), 29 1/2 in. dia. by 44" stroke, at 100 rev., each engine develops 3000 h. p., main engines started by compressed air at 25 lb. stored in two tanks of 800 cu. ft. each. The compressors are worked from the main engines. There is an auxiliary compressor driven by a 200 h. p. electric motor. Machinery aft. Has 12 electric winches, each capable of handling from 3 to 5 tons, electric driven anchor windlass and steering gear. Name of vessel, Florida.
		220' 0" O.A. 216' 0" W.L. 25' 0" L. 25' 0" W.L. 28' 0" L. 23' 11 1/2" W.L.	U. S. Submarine tender <i>Polson</i> . Single screw, main engine two-cycle, single acting, air starting and air reversing Diesel engine (New London Shipbuilding Co.). Six working cylinders, two air compressors, 1000 h. p. at 200 revs. Speed, 12 1/2 knots.
		331' 0" O.A. 345' 0" L. 47' 0" W.L. 27' 0" L. 21' 0" W.L. 23' 4 1/2" W.L.	Kangaroo—displacement, 6640 tons; gross tonnage, 4348; net, 2777 cubic bale measurement, 301,000; grain, 327,000; bunker oil tanks, 814 tons; water ballast, 672; space for lubricating oil in double bottom under engine room, 1366 cu. ft. Two Diesel engines (Barnes & Wain) for hoisting purposes and the auxiliaries in the engine room are electric-driven.
		362' 0" O.A. 365' 0" L. 47' 0" W.L. 27' 0" L. 21' 0" W.L. 23' 4 1/2" W.L.	6520 tons deadweight. Machinery aft. Two four-cylinder, two cycle Diesel engines (Walstead Shipway & Eng'g Co.), 17 1/2 in. dia. by 23 in. stroke; 120 revs., h. p. of each engine 500. Steam driven auxiliaries. Capacity of fuel tanks 665 tons. Name of ship, Alberta.

MOTOR BOATS

Type	Length Over All	Beam	Draft	H.P.	Number of Cylinders	Bore	Stroke	Rev.	Propeller			Speed in Miles Per Hr.
									Number of Blades	Diam.	Pitch	
Dory.....	22'	.....	.....	6	1	.....	.....	.....	.....	.....	.....	8
Runabout, V bottom.....	23'	4' 8"	.....	25	4	5 1/2	.....	1000	.....	.....	.....	18
Racer.....	27'	4' 8"	.....	65	6	5 1/2	0	800	.....	.....	.....	27
Runabout.....	30'	4' 8"	2' 2"	125	12	5 1/2	6	500	.....	.....	.....	29
Cruiser.....	33'	8' 0"	2' 4"	18	3	5 1/2	6	500	.....	.....	.....	10
Cruiser.....	35'	8' 0"	2' 6"	24	4	5 1/2	6	500	.....	.....	.....	9 1/2
Speed boat.....	40'	8' 0"	1' 8"	60	6	6	8 1/2	800	.....	.....	.....	20
Cruiser.....	43'	12' 0"	3' 0"	24	4	5 1/2	6	500	.....	.....	.....	12
Work boat.....	57'	14' 6"	4' 0"	100	6	8 1/2	9	375	.....	.....	.....	10
Cruiser.....	60'	14' 0"	3' 0"	40	4	6 1/2	7	450	.....	.....	.....	11 1/2
Fast Cruiser.....	75'	10' 8"	3' 4"	300	6	10	10	350	.....	.....	.....	20
Cruiser.....	85'	20' 0"	5' 6"	60	6	9 1/2	7	500	.....	.....	.....	9 1/2

capstans, etc.) being steam or electric operated. For cost of upkeep see Internal-Combustion Engines.

**Motor Boats.**—There are no rules for their scantlings. As to the hull forms there is the V bottom for cruisers and runabouts where the cross sections are Vs, and the ordinary curved or round bottom. Hydroplanes have practically flat bottoms with steps, the hydroplane lifting and running on a step when at full speed. Gasoline engines have superseded steam for pleasure craft from 30 to 100 ft., for not only are the former easier to handle, but they take up less space and a smaller crew is required.

Motor boats over 15 tons come under the supervision of the U. S. Steamboat-Inspection Service, and are classed as steamboats. While limited as to carrying capacity motor boats are allowed more passengers than steamboats of the same size. Their operating conditions are set forth in their certificates of inspection. In some, the equipment includes air tanks, under the decks, of sufficient size to float the boat with her complete complement of passengers with the hull full of water. Boats over 65 ft. long, carrying freight for hire are required to have a licensed pilot and engineer.

After January 1, 1915, the U. S. Steamboat-Inspection Service requires that all ocean steam vessels of over 2,500 gross tons carrying passengers and whose course takes them 200 miles or so offshore shall be equipped with not less than one motor-propelled lifeboat.

See tables of Motor Ships and Motor Boats.

**Schooners and Sailing Vessels with Motors.**—The schooners in the following table are typical ones engaging in the coastwise trade in the United States, the larger sizes trading with South American countries. The fishing schooners given run out of Boston, Mass. Schooners generally have wood hulls.

Sailing vessels with motors of the larger sizes are ship rigged, have steel hulls and engage in the transatlantic or ocean trade. Many of these vessels are owned by Norwegians.

See Wood Vessels.

SAILING VESSELS FITTED WITH MOTORS

Length.....	97' 5"	135' 0"	142' 0"	165' 0"	228' 0"	308' 2"
Breadth.....	27' 3"	30' 0"	26' 9"	33' 0"	36' 0"	42' 8"
Depth.....	12' 3"	10' 10"	15' 8"	12' 9"	23' 6"	26' 10"
Deadweight (tons)....	335	500	460	750	1900	3900
Number of Engines....	1	1	1	1	2	2
Brake h. p. of each.....	80	160	120	240	120	160
Total brake h. p.....	80	160	120	240	240	320

Bolinder's engines were installed in the above.

SCHOONERS

Length * .....	121' 5"	145' 6"	163' 0"	163' 0"	169' 0"	274' 0" O.A. 251' 0" W.L.	165' 0"	195' 0"	196' 0"	211' 0"	218' 9"
Breadth .....	24' 8"	34' 6"	35'	34'	34'	45'	35' 10"	42'	38'	40' 4"	40' 8"
Depth .....	9' 9"	16' 3"	13'	17' 1"	17' 1"	25'	16' 5"	18' 6"	18' 2"	18' 2"	18' 3"
Draft .....	9' 6"	..	..	..	..	21'	17'	20'	19' 6"	21'	21'
Deadweight (tons) ..	300	800	900	950	..	3100	900	1800	1500	1800	1800
Gross Tonnage .....	191	591	667	648	648	Displacement 4530	621	1191	1005	1300	1306
Net Tonnage .....	163	516	587	583	583	.7 Block co-eff.	451	1042	954	1155	1198
Number of Decks .....	1	2	1	2	2	Single Deck with beams	3	2	2	2	2
Number of Masts .....	2	3	3	3	5	Steel	3	4	4	4	4
Remarks .....	Wood Can carry 215,000 ft. B. M. Lumber	Wood	Wood	Wood	Wood	Cubic cargo 178,000 Ballast tanks 1242 Tons	Wood Can carry 420-460 M ft. yellow pine. Aitce B. Philippe	Wood 825 M ft. yellow pine May V. Netville	Wood 675-700 M ft. Bopard Barnes	Wood 825 M ft. Lammann M. Low	Wood 20,000 standard railroad ties. Gen'l E. S. Cresley

\* Length = length on water line.

## FISHING SCHOONERS FITTED WITH MOTORS

Length.....	96'	100.1'	103'
Breadth.....	23.7'	22.7'	24'
Depth.....	11'	9.8'	11.8'
Gross tons.....	115	94	141
Net tons.....	79	64	93
Engines.....	Two 4-cycle each 37.5 h.p.	Two 4-cycle each 37.5 h.p.	Two 4-cycle each 50 h.p.
Speed.....	7½ knots	9 knots	8 knots
Consumption.....	6½ gals. of gasoline per hour	7 gals. of gasoline per hour	7½ gals. of gasoline per hour

## MISCELLANEOUS VESSELS

**Oil Carriers.**—Owing to the extensive use of oil and the finding of it in many parts of the world, several types of bulk oil carriers have been developed. Among them may be mentioned: (1) those with the usual transverse system of framing as per Lloyd's rules or other classification society; (2) those built on the longitudinal or Isherwood system; and (3) those built with large cylindrical tanks with the usual transverse framing modified to suit.

Ships built according to (1) and (2) have a complete subdivision, there being a longitudinal bulkhead with several transverse. Lloyd's specify "that oil compartments are not to exceed 24 to 28 ft. in length." As a rule oil carriers are built with the propelling machinery aft, thus giving the entire forward part of the vessel for the carrying of oil. In vessels having the machinery aft, a poop must be fitted of sufficient length to cover the machinery space. When the engines are amidships the bridge is to be of sufficient length to overlap the ends of the middle bulkhead in the oil compartments. The pump room is often amidships even when the engines and boilers are aft.

Some vessels are designed to have sufficient stability when empty or with just enough water ballast to give the proper trim, but this gives a vessel, when loaded, excessive stability and makes her an uncomfortable roller. In others when the oil is discharged and they are to proceed again to sea without a cargo it is necessary to fill several of the oil tanks with water to get the desired stability. This must only be done in port and great care must be taken.

To provide for the expansion and contraction of the oil each compartment has an expansion trunk large enough to keep the compartment always full, but with a small free surface so that the fluidity of the oil will not cause much if any loss of stability. The trunks are arranged so the surface of the oil will not fall below the sides

when the vessel is rolling or pitching in a seaway. When the breadth of the expansion trunk exceeds 60% of the breadth of the vessel or the height of the trunk exceeds 8 ft. above the top of the oil compartment, Lloyd's require the plans to be submitted to their Committee for special approval.

Cofferdams are fitted at the forward and after ends of the oil space, and when the machinery is amidships they are also fitted at each end of the machinery space so that the oil cargo will be isolated from the engine and boiler spaces. The cofferdams must not be less than two frame spaces in length and must extend from the keel to the continuous expansion trunk for the full breadth of the vessel. The cofferdams are practically additional bulkheads and are connected to the ship's bulkheads by plates and angles.

The best of workmanship is required in the building of oil carriers. The riveting must be thoroughly oiltight, the spacing never exceeding 3 or  $3\frac{1}{2}$  diameters, and the rivet points left full or convex. The caulking side of the center line bulkhead should be reversed in each tank and the transverse bulkheads should be caulked on the forward side in one case and on the after side in the next. This simplifies testing to a great extent. Portland cement is not required in compartments where oil is carried.

When cylindrical tanks are installed, these rest on the top of the tank top, the oil not coming in contact with the hull.

The American Bureau of Shipping recommends that "the three deck or spar deck type, with the main or second deck forming the crown of the oil holds and the 'tween-deck be dispensed with. Furthermore the oil holds are not to exceed 32 ft. in length and are to be divided by a longitudinal oiltight bulkhead extending to the top of the expansion trunks connected with all the oil holds. To provide for the expansion and contraction of the oil, each hold or compartment is to connect with one or two trunks extending from the deck forming the crown of the holds to the deck above."

Some of the latest bulk oil carriers are shelter deckers. All the societies insist that vessels carrying oil in bulk be well ventilated, requiring that efficient means be provided for clearing the compartments from dangerous gases by the injection of steam or other artificial ventilation.

Lloyd's Rules state: "Oil fuel the flash point of which by Abel's close test does not fall below 150° F. may be carried in ordinary cellular double bottoms either under engines or boilers or under ordinary cargo holds, also in peak tanks or in deep tanks or in oil bunkers specially constructed for this purpose.



## HULL CONSTRUCTION

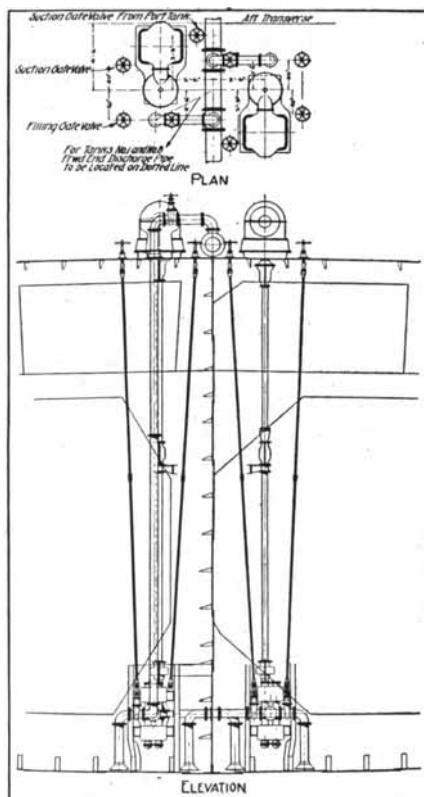

Figure 50.—Pump Installation on Tanker *La Brea*.

“Cellular double bottoms when fitted for oil fuel are to have oiltight center divisions and the lengths of these compartments are to be submitted for approval.

“All compartments intended for carrying oil fuel must be tested by a head of water extending to the highest point of the filling pipes, 12 ft. above the load line or 12 ft. above the highest point of the compartment, whichever of these is the greatest.

“Each compartment must be fitted with an air pipe to be always open, discharging above the upper deck. It is recommended

that all double bottom compartments used for oil fuel should have suitable holes and doors of approved design fitted in the outer bottom plating.

"Efficient means must be provided by wells or gutterways, and sparring or lining to prevent any leakage from any of the oil fuel compartments from coming into contact with cargo or coal, and to ensure that any such leakage shall have free drainage into the limbers or wells.

"If double bottoms under holds are used for carrying oil fuel the ceiling must be laid on transverse battens, leaving at least 2 ins. air space between the ceiling and tank top, and permitting free drainage from the tank top into the limbers.

"The pumping arrangements of the oil fuel compartments must be absolutely distinct from those of other parts of the vessel.

"If it is intended to carry sometimes oil fuel and sometimes water ballast in any of the compartments, the valves or cocks connecting the suction pipes to these compartments with the ballast donkey pump and those connecting them with the oil fuel pump must be so arranged that the oil may be pumped from any one compartment by the oil fuel pump at the same time as the ballast donkey pump is being used on any other compartment.

"All oil fuel suction pipes should have valves or cocks fitted at the bulkheads where they enter the stoke hold, capable of being worked both from the stoke hold and from the deck. Valves or cocks similarly worked are to be fitted to all pipes leading from the settling or service tanks.

"Oil fuel pipes should, where practicable, be placed above the stoke hold and engine room plates, and where they are always visible.

"No wood fittings or bearers are to be fitted in the stoke hold spaces.

"Where oil compartments are at the sides of or above, or below the boilers, special insulation is to be fitted where necessary to protect them from the heat of the boilers, smoke boxes, casings, etc.

"Water service pipes and hoses are to be fitted so that the stoke hold plates can at any time be flushed with sea water into the bilges.

"If the oil fuel is sprayed by steam, means are to be provided to make up for the fresh water used for this purpose.

"If the oil fuel is heated by a steam coil the condensed water should not be taken directly to the condensers, but should be led

into a tank or an open funnel mouth and thence led to the hot well or feed tank."

\* **General Notes on Oil Carriers.**—Oil in tankers is carried to the skin of the vessel (except those with cylindrical tanks) and in many cases no water ballast tanks are below the oil tanks but may be in the machinery space. Vent pipes must be fitted to the oil tanks, the tops of the pipes having covers of wire gauze sheets to prevent sparks or hot cinders from entering the tanks.

The pump room may be forward of the machinery space (which is usually aft), or it may be amidships with water ballast tanks below it. In some large steamers there are two pump rooms, one forward of the machinery space and the other amidships:

The oil pumps are kept entirely separate from the pumps which fill or clear the water ballast spaces of water, and no water ballast pipe passes through an oil compartment or vice versa. There are two main lines of suction pipe, one on each side of the center longitudinal bulkhead. Each line has a suction to each tank on its own side of the ship, and may have one passing through the longitudinal bulkhead to the corresponding compartment on the other side. Two valves are fitted to each suction and these are operated by rods on the weather deck. There are thus two sections in each compartment and four in each tank, an arrangement which permits both sides of the vessel to be dealt with through the same line simultaneously. In other cases each line has only one suction on each side of the center line bulkhead with valves worked from the upper deck, a master valve being in each line at the bulkheads also controlled from the upper deck.

When oil is carried in the summer tanks, these may have drop valves which permit the contents of a tank being drained into the one immediately below and then discharged through the main lines. This involves carrying the same quality of oil in the 'tween-deck spaces as is carried in the corresponding hold space. On many vessels the summer tanks have an independent line of about 4 ins. diameter.

In emptying the tanks of oil, the pumps will clear the whole of the cargo in the tanks but will leave the pipe lines full. Ordinarily this is drained into the end compartment and dealt with by a hand pump or by buckets.

Steam heating coils are often placed in the tanks, for when heavy

\* Abstracts of a pamphlet on "Description and Construction of Oil Steamers" by J. Montgomerie of Lloyd's.

viscous oil is carried it is difficult to handle it at ordinary temperatures; in fact a temperature of 120° may be required.

Steam fire extinguishing apparatus is carried by all oil vessels and provision is made for steaming out the tanks, which may consist of hoses attached to a steam line on deck. Or, instead, a system of copper pipes with 1½-in. branches extend to within a foot of the bottom of the tanks. In this case the fire extinguishing and steaming out installations may be combined in one set of pipes, by having holes cut in the pipes just below the deck.

When general cargo is carried the tanks are ventilated in the ordinary way by upcast and downcast ventilators, and when oil is carried the ventilators are closed by blank flanges. Except in vessels carrying benzine, the tanks are kept as far as possible sealed, there being only a vapor cock in the side coamings of the hatchways. When benzine is carried vapor pipes of about 2½ ins. diameter are connected to the main tanks, and of 2 ins. to the summer tanks, with cocks at each tank, the pipes being led to one of about 3 ins. which runs up one of the masts, or there may be two such pipes.

In some cases after the oil has been pumped out the heavy air mixed with the gas from the oil is partially removed by opening the hatches and fixing up a canvas ventilator the bottom of which extends nearly to the top of the floors. The fresh air entering the ventilator forces upward the heavy air out through the hatch openings. Sometimes a fan assists in the movement of the air.

See also Loading and Stowing of Cargoes.

**Piping Arrangement.**—The following system was installed on a 410-ft. steamer, the *F. H. Buck*, having a cargo capacity of 63,900 barrels of oil: "Two duplex pumps having 18 inch steam cylinders, 15 inch oil cylinders with 18 inch stroke. The suction system consists of two 12 inch mains run one on each side of the center line bulkhead with a 10 inch branch to each tank. Bypass arrangements are made so that any tank on one side of the ship can be emptied and discharged either overboard, through seacocks or into any other tank on the opposite side. Each pump can separately or together discharge into an 8-inch belt discharge main running along the top of the expansion trunk from which 3 inch branches are fitted for discharging overboard or back to the tanks by 6 inch branches. Discharges are so arranged that either pump can discharge into one side of the main or the other and division valves are provided so that one pump can be working at a heavier pressure

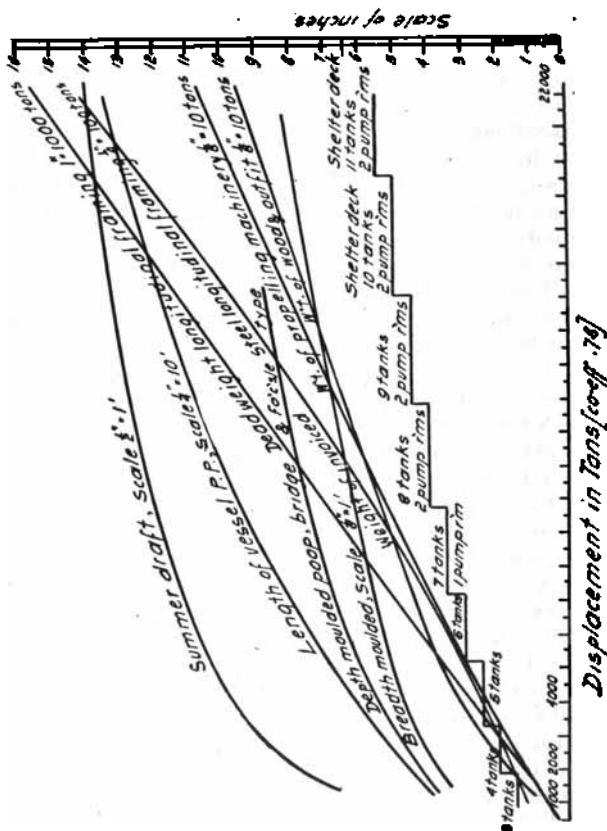

Figure 51.—Data on Oil Carriers.

To use Fig. 51, suppose particulars are wanted on an oil tanker of 4,000 tons displacement. To find the length, draw a vertical line and note where it intersects the curve of lengths, and draw a horizontal line to the scale of ins. In this case it will be noted at about 6½ ins. As the scale of the length curve is ¼ in. = 10 ft. then the length of the vessel between perpendiculars will be 260 ft. The weights and other information are found in a similar manner. (Authority, see page 324.)

than the other. An independent 6-inch suction is fitted to one set of the main cargo tanks to discharge into the fuel tanks. The discharge system is so arranged that it can be used as suction for one or both pumps. Each pair of tanks is fitted with a 6-inch equalizing valve. Two turbine fans are fitted in the pump room to discharge air either into the pump room or into 12-inch suction pipes to the cargo tanks." See Lloyd's Rules above and also General Notes. A midship section of the *F. H. Buck* is shown on page 257.

**Lumber Steamers.**—These often have only a single deck with a center longitudinal bulkhead, the machinery being aft. They are given extra beam, and the main deck is strengthened for carrying a deck cargo, and special bulwarks built. Cargoes up to 14 ft. in height may be carried on some steamers. An example of a steamer designed for the lumber trade is the *Wm. O'Brien*. She is 361 ft. between perpendiculars, 51 ft. beam, 27 ft. deep, draft loaded 21 ft. 6 ins., lumber capacity 3,000,000 ft., single deck, watertight center line bulkhead entire length of cargo holds from keel to main deck, machinery aft, 3 single-end Scotch boilers 13 ft. 8 ins. by 10 ft. 5 ins., steam 180 lb., engine  $\frac{24\frac{1}{4} \times 38\frac{1}{2} \times 67}{45}$ , 90 r. p. m., i. h. p. 2,150, speed 11 knots.

**Trawlers.**—Small steel fishing vessels common in the North Sea (Europe) built to Lloyd's rules, with machinery aft, thus giving a large hold forward for carrying fish. They are strongly built and keep at sea until they have secured a cargo of fish before returning to port. The fish are caught in a large cone-shaped net that is drawn through the water at a slow speed. A typical trawler is the following: 130 ft. long, 22 ft. beam, 11 ft. deep, gross tonnage 251, net 171, machinery aft, engine  $\frac{13 \times 22 \times 36}{27}$ , single Scotch boiler, steam 150 lb., bunkers 100 tons, speed about 10 knots on 5 tons per 24 hours.

**Dredges.**—Under this heading is included only those with steel hulls, ship-shaped, having their own motive power and designed for dredging channels to sea ports and offshore work. Many of these dredges are equipped with buckets fastened to an endless chain, which pick up the material and discharge into hoppers in the dredge. When the hoppers are filled the dredge steams out to sea and there discharges. An example of this type is the *King George*, 170 ft. long, 34 ft. beam, 13 ft. 3 ins. deep, steel hull, twin

screw, triple expansion engines each of 600 h. p. Each engine can be coupled to the dredging gear. The dredging buckets have a capacity of 9 cu. ft. each and are fastened on an endless chain. There are 32 buckets, with a cast steel body and manganese iron cutting lips. The rate of travel is about 16 buckets per minute.

Another type is the suction, where the material is drawn from the bottom through a pipe by means of a powerful centrifugal pump. Such a dredge is the *Balari*, 333 ft. long, 54 ft. 6 ins. beam, 22 ft. 3 ins. deep, has a hopper capacity of 71,600 cu. ft. The hull and machinery are built to Lloyd's highest class. Propelling machinery consists of two triple expansion engines. There are four large single-end and horizontal boilers, steam 180 lb. The pumping outfit placed forward of the hopper in an independent compartment consists of a triple expansion engine directly connected to a centrifugal sand pump designed to raise and discharge about 5,000 tons of sand and silt per hour. The pump is connected to a suction pipe at the bow. The suction end of the pipe is fitted with a specially designed nozzle to suit the character of the material to be dredged; a grid is fastened to the nozzle to exclude material which might choke or injure the pump. The suction pipe is controlled by a steam winch placed on deck. The pumping engine has its own condenser.

**Shallow Draft Steamers.**—These may be divided into stern wheelers and tunnel vessels. The former are extensively used on the Mississippi River and its tributaries in the United States, also on South American and African rivers. Those in the United States have generally wooden hulls with boilers forward and engines aft (see Marine Engines). When handling barges they push the barges ahead, which is the reverse to ocean towing. They often have three or four rudders placed forward of the stern wheel. The rudders are given a large area; in fact the immersed area of three rudders averages from 115 to 150 sq. ft. A typical example is the towboat *Warioto*, 141 ft. over all, 120 ft. between perps., 27 ft. beam, depth at side 5 ft., crown of deck 6 ins., draft with 30 tons of coal on board 3 ft. 8 ins., displacement about 270 short tons (2,000 lb.), block coefficient .78, steel hull, 4 watertight transverse bulkheads, center line bulkhead, 2 longitudinal trusses, 3 boilers, steam 200 lb., externally fired, 40 ins. diameter by 24 ft. long, three 9-inch flues, three 6-inch, grate area 48 sq. ft., heating surface 1,365 sq. ft., engine developed 304 i. h. p., 26.9 lb. of steam being required per i. h. p. per hour for the main and auxiliary engines. In another

**LIGHT DRAFT STERN PADDLE-WHEEL STEAMBOATS**  
(Flush Decks)

Length of Hull	Length over All	Beam of Hull	Width on Deck	Draft Ready for Load	Will Carry		Towing Capacity	Approximate Fuel Consumption in Ten Hours		Double Engines	
					Tons	On Draft of Inches		Tons	Wood Cords	Diameter of Cylinder and Stroke (2 Engines)	Indicated Horse Power 150 lb. Pressure
50	59	14	15½	12	10	20	30	1	2	5 x 20	30
65	76½	15	17	12	17	20	55	1¼	2¼	6 x 30	45
70	82½	16	18	14	20	21	80	1½	2½	7 x 32	62
80	94	18	20	15	25	24	110	2	3½	8 x 36	75
90	103	22	25	16	30	24	150	2½	4	9 x 42	111
110	125	25	28	18	50	28	225	3	5	10 x 48	157
135	154	30	33	22	100	32	300	4	7	12 x 60	214



towboat 125 ft. long there were installed two tandem compound engines  $\frac{12 \times 24}{72}$  which weighed complete with condensers and piping 81,345 lb., and the two boilers, including superheaters, stack, etc., 94,460 lb. The engines turned a stern wheel 22 to 24 r. p. m., 18 ft. diameter, buckets 17 ft. long, width 30 ins., 12 arms. Total weight of wheel 9,380 lb.

Tunnel vessels are driven by propellers running in tunnels, the propellers being completely surrounded with water. The hulls may be built of steel plates, that are shipped in sections and are assembled at their destination. The engines are of the usual vertical marine type. Below is outlined the *Shu Hun*, a steamer built for service on the Yangtse Kiang, China. Hull of steel, length 190 ft., beam 30 ft., draft with cargo of 300 tons 5 ft., 2 double-end water tube boilers, supplying steam to two 1,000 h. p. engines. Another tunnel boat is the following, which was built to run on the Ob River, Siberia. Length on water line 90 ft., beam 15 ft., depth 5 ft., draft loaded 2 ft.  $1\frac{1}{2}$  ins., steel hull, twin tandem engines each  $\frac{6\frac{3}{4} \times 13\frac{1}{2}}{8\frac{1}{2}}$  total h. p. of both at 280 r. p. m. 130. Jet condensing, boiler 5 ft. 8 ins. diameter by 12 ft. 4 ins. long, steam 140 lb.

### FITTINGS FOR CATTLE AND HORSE STEAMERS.

#### Weight of Fittings per Head of Cattle Carried.

Cementing on deck $1\frac{1}{2}$ ins. thick .....	185.00 lb.
Total woodwork including bolts.....	139.62
Steel angle footlock clips.....	11.43
Castings and fittings.....	37.19
Gnawing strips.....	6.00
Solid cattle stanchions.....	9.74
Hollow stanchions.....	11.02
	<hr/>
Total per head.....	400.00 lb.

Sufficient light must be provided for the proper tending of animals at all times. For ventilating purposes under deck canvas bags should be fitted to ventilators provided with iron rings at the bottom, and reaching within 18 ins. of the deck under foot.

**Weight of Fittings per Horse Carried.**

Cement on deck 1½ ins. thick.....	185.00 lb.
Total woodwork including bolts.....	273.55
Kicking pieces and bolts.....	34.11
Castings and fittings.....	200.34
	<hr/>
Total per horse (London regulation)....	693.00 lb.
Leaving an American port deduct close division boards.....	135.00 lb.
	<hr/>
Total per horse (American regulation)..	558.00 lb.

For complete specifications for the requirements for shipping cattle and horses see U. S. Regulations published by Dept. of Agriculture.

The cost of fitting a steamer with stalls averages \$8 to \$10 per head under deck and \$12 to \$15 per head on deck. It is estimated that the average expense for food for horses and attendants for a voyage from New York to Liverpool is about \$5 a head.

**PRICES, COSTS AND ESTIMATES**

In Great Britain a fair average price for medium size cargo steamers in ordinary times is from \$40 to \$45 a ton per deadweight. Similar vessels if built in the United States would cost approximately one and one-half times as much. Below are tables of steamers sold in May, 1915, and May, 1916. The rise in price being due to the European war and the demand for tonnage. In general even the prices quoted in May, 1915, are about 35% above normal.

**STEAMERS SOLD IN MAY, 1915**

Name	D.W.	Built	Price	Rate per ton
Rossia.....	7,600	1900	£52,000	£6 16
Whitgift.....	7,350	1901	51,500	7 0
Drumlanrig.....	7,300	1906	73,000	10 0
Rhodesia.....	7,200	1900	49,000	6 16
Dongola.....	7,100	1898	48,500	6 16
Whindyke.....	6,500	1901	45,000	6 18
St. Fillans.....	6,400	1900	45,000	7 0
Kalypso.....	6,000	1904	60,000	10 0
Winnfield.....	5,800	1901	40,000	6 17
Woolstan.....	5,400	1900	40,000	7 8
Denaby.....	5,100	1900	38,000	7 9
Amphitrite.....	4,400	1897	28,000	6 7
Leafield.....	4,340	1905	36,000	8 5
Hartburn.....	3,820	1900	28,000	7 6
Gledhow.....	3,800	1891	20,000	5 5
Lula.....	3,600	1890	19,250	5 6

## STEAMERS SOLD IN MAY, 1915—Continued

Name	D.W.	Built	Price	Rate per ton
Brynchild.....	3,450	1899	£30,000	£8 13
Lisl.....	3,100	1888	18,000	5 15
Girda Ambatiellos.....	2,755	1888	15,000	5 8
Axminster.....	2,750	1891	16,500	6 1
Citrine.....	2,750	1899	25,000	9 1
Karmo.....	2,300	1882	16,000	6 19
Carmelina.....	2,300	1904	24,000	10 8
Allan.....	1,900	1907	26,000	13 13
Rign.....	1,900	1897	19,000	10 0
Arena.....	1,400	1883	12,000	8 11
Roar.....	950	1904	12,000	12 12
Netta.....	480	1909	9,000	18 15
Jessie.....	180	1902	3,000	15 9

## STEAMERS SOLD IN MAY, 1916

Name	D.W.	Built	Price	Rate per ton
Daldorch.....	7,700	1907	£150,000	£19 9
New Steamer.....	7,500	1916	180,000	24 0
Globe.....	7,450	1909	135,000	18 2
Crown.....	7,335	1906	115,000	15 13
River Forth.....	7,300	1907	110,000	15 1
King.....	7,300	1906	125,000	17 2
Orkedal.....	6,650	1906	178,000	26 15
Calimeris.....	6,250	1905	140,000	22 8
Ilansannor.....	6,250	1900	175,000	28 0
Woodbridge.....	6,060	1900	90,000	14 16
Navarchus Coundouritos.....	5,550	1898	155,000	27 19
Agenorla.....	5,200	1902	70,000	13 9
Huldavore.....	5,000	1889	100,000	20 0
Zulina.....	5,000	1899	140,000	28 0
Astarloa.....	4,500	1896	101,000	22 8
New Steamer.....	3,500	1916	70,000	20 0
New Steamer.....	3,300	1916	85,800	26 0
Antonios Embiricos.....	3,100	1891	62,000	20 0
Sirte.....	2,900	1887	45,000	15 10
Bizcaya.....	2,300	1878	41,000	17 16
Harpalys.....	2,200	1895	33,000	15 0
John.....	1,600	1881	36,250	22 13
Alfred Kreglinger.....	1,500	1909	37,000	24 13
Alfred Dumois.....	1,300	1890	13,000	10 0
Artigas.....	1,100	1911	20,000	18 3
Allerton.....	830	1914	31,000	37 9
St. Katharine.....	570	1905	17,500	30 14
Portaferry.....	240	1884	6,500	27 1

The following are miscellaneous quotations made in the United States early in 1916.

Coal barge, ship shape, wood hull, 200 ft. long, 32 ft. beam, by 20 ft. deep, new to build \$35,000.

Dump scow 120 ft. by 35 ft. by 13 ft., 800 cu. yd., wood, good condition, but second-hand \$4,500.

Deck scow 90 ft. by 27 ft. by 9 ft., good condition, second-hand \$1,000.

Tug, wood hull, 72 ft. long, compound engine, good condition, second-hand \$8,000.

Motor boat 30 ft. long, 15 h. p. engine, new to build \$1,500.

Motor yacht 60 ft. long, 35 h. p. engine, new to build \$11,000.

Steamer 257 ft. between perpendiculars. 36 ft. 6 ins. beam, 17 ft. 3 ins. deep, single deck, long raised quarter deck with short well forward, forecastle, machinery amidships, 2,250 tons deadweight on 16 ft. draft, \$225,000, or if machinery aft \$190,000. Prices quoted are to build.

U. S. collier, 13,500 tons displacement, \$987,500.

186 ft. O. A., 1,000 tons displacement, twin screw, single deck vessel for U. S. Coast and Geodetic Survey, bids ranged from \$163,300 to \$266,000.

The prices asked in 1916 for delivery in New York of the wooden schooners, particulars of which are given in the table on page 319, are as follows:

	Built	
165 ft. ....	1883	\$25,000
195 ft. ....	1901	50,000
196 ft. ....	1891	50,000
211 ft. ....	1890	50,000
218 ft. ....	1894	55,000

In comparing the above prices the age and deadweight should be considered. One yard quoted a price of \$80,000 for building a single deck, 3-mast wooden schooner of 1,200 tons deadweight.

A wooden schooner 260 ft. long on water line, 46 ft. beam, 23.1 ft. deep, gross tonnage 2,556, net 2,125, built in 1901, sold in New York in May, 1916, for \$195,000. Name of schooner, *Rebecca Palmer*.

A round bottom work boat 40 ft. long, 9 ft. beam, having good lines, with no pilot house, the boat being open with short decks forward and aft, oak keel, stem, and frames, white cedar planking, galvanized iron fastenings, cost \$1,950. The same size but with a V bottom cost \$1,650, and one 50 ft. by 12 ft. round bottom cost \$3,000 and with a V bottom \$2,400. The above prices do not include motor, fuel tank, or auto top; neither do they include the installation of the motor, other than a properly constructed foundation.

ESTIMATES ON BUILDING A MOTOR SCHOONER ON THE PACIFIC  
COAST (1916) AND OF RUNNING HER FROM SEATTLE,  
WASH., TO NEW YORK\*

*Dimensions, Equipment and Capacity*

Length (custom house).....	225' 0"
Breadth.....	42' 6"
Depth.....	18' 0"
Gross tonnage, about.....	1,250
Net tonnage, about.....	1,125
Speed, knots, loaded (engine).....	7
Lumber capacity.....	1,500,000 ft. B. M.
Machinery, two oil motors, 160 h. p. each.....	320

*Cost of the Vessel*

Cost of ship complete (wood construction).....	\$85,000
Machinery installation.....	19,000
All auxiliary installations.....	18,000
Cost complete.....	\$122,000
Design, contracts, supervision at 5%.....	\$6,100

*Cost of Operating*

Crew—Captain.....	\$125 per month	
First mate.....	90	"
Second mate.....	75	"
Cook.....	50	"
Cabin boy.....	20	"
Eight sailors at \$30.....	240	"
Chief engineer.....	100	"
Assistant.....	75	"
	\$775 × 12	\$9,300
Food, at 68c per man, 15 men for 1 year.....		3,723
		\$13,023
Crew expense per day.....		\$35.67

*Engine Room Expense*

One engine: 160 h. p. × ½ lb. oil = 80 lb. per hour = ¼ bbl. at 95c per bbl.....	\$0.237
Lubricating oil at 41c.....	.060
Fuel and lubricant per hour.....	.297
Fuel and lubricant, 24 hours.....	\$7.13

\* From Shipping Illustrated, New York.

Operating cost per day, 2 engines . . . . .	\$14.26	
Operating cost per year . . . . .	5,204.80	
Engine supplies . . . . .	200.00	\$5,404.80
Taxes at $\frac{1}{2}\%$ . . . . .		600.00
Depreciation, 5% . . . . .		6,100.00
Insurance, 7% . . . . .		8,540.00
Liability, $1\frac{1}{2}\%$ . . . . .		1,830.00
Upkeep and repairs . . . . .		5,000.00
<b>Total expense per year . . . . .</b>		<b>\$40,497.80</b>
Operating cost per day (ship and engine) . . . . .		110.95
Operating cost engine per day . . . . .		14.26
<b>Operating ship only per day . . . . .</b>		<b>\$96.69</b>

*To New York with Lumber from Seattle, Wash.*

Loading time, 100,000 ft. per day . . . . .		15 days
Expense of ship loading 15 days at—		
Captain, mate, engineer, cook . . . \$12.00		
Food . . . . . 2.72		
Fixed charges per day . . . . . 60.47		
	<b>\$75.19</b> × 15 days	<b>\$1,107.85</b>
Loading, at 85c per M board feet of lumber . . . . .		1,275.00
Canal charges, \$1.20 per net ton . . . . .		1,350.00
Pilotage, canal . . . . .		22.00
18 days engines . . . . . \$256.68		
36 days ship . . . . . 3,480.84		<b>\$3,737.52</b>
Unloading N. Y., 15 days × 96.69 . . . . .		1,450.35
Unloading, stevedores . . . . .		1,275.00
		<b>\$10,217.72</b>
Laid down N. Y. per M board feet . . . . .		\$6.81

OPERATING COSTS OF DIESEL ENGINES ON THE PACIFIC COAST OF THE U. S.

Passenger boat 92 ft. long, 16 ft. beam, 5 ft. draft, driven by 180 h. p. Inseco Diesel engine, speed 16 miles. Name *Suquamish*.

The <i>Suquamish</i> ran miles per day . . . . .	132
Season's mileage, May 1 to Nov. 1 . . . . .	24,300
Season's fuel consumption, gallons . . . . .	15,000
Cost of fuel oil for season . . . . .	<b>\$325.13</b>

Cost of fuel oil per day of 12½ hours.....	\$1.76
Cost of fuel oil per mile.....	1½c
Cost of repairs, nominal.....	

Tug 70 ft. long, 18 ft. beam, 10 ft. draft, 240 h. p. Nlseco Diesel engine. Name *Chickamauga*.

Hours towing.....	662
Hours running light.....	188
Total working hours.....	850
Total fuel consumption, gallons.....	7725
Total cost of fuel.....	\$167.79
Fuel consumption per hour, gallons.....	9.1
Total cost of fuel per hour.....	19¼c
Cost of repairs, nominal.....	

Cannery tender 75 ft. long, 18 ft. beam, 8 ft. draft, 120 h. p. Nlseco Diesel engine. Name *Chomly*.

Working time.....	1489 hrs.
Gallons of fuel consumed.....	8664
Fuel consumption per hour, gallons.....	5.8
Price of fuel per barrel.....	95c
Hourly running cost.....	13.1c
Total fuel bill for season.....	\$195.97
Cost of repairs \$2.00.	

#### REPAIR COSTS OF MOTOR SHIPS

Name of ship.....	<i>Sembilan</i>	<i>Loudon</i>	<i>Myer</i>
No. of voyages made..	90 in 3 years	60 in 20 mos.	2 per month
Total cost of repairs...	About \$2,400	About \$1,600	Nil
Total time lost for repairs.....	Very little time	Very little time	Nil
Deadweight capacity..	300 tons	1750 tons	1750 tons
Horse power.....	200	1400	1400
Fuel consumption per geogr. mile.....	0.02 tons	0.08 tons	0.08 tons
Fuel consumption per i. h. p. hr.....	0.16 liter	0.18 liter	0.18 liter

The Diesel engines of the *Sembilan*, *Loudon* and *Myer* were built at the Werkspoor Works, Amsterdam. The fuel consumption at sea averaged .30 lb. per i. h. p. hour, compared with 1.20 lb. per i. h. p. for an oil-fired steamer.

**Cost of Electric Installations.**—Cost of marine generating sets only, \$60 to \$80 per kw.

Cost of electric plant complete, including apparatus and installing:

(Data from Stand. Elect. Engr's Handbook.)

Type of Vessel	Size of Generating Set	Lamps	Total Cost
Tug.....	3 kw.	50	\$1,100
Ferryboat.....	20 kw.	300	3,000
Freight steamer.....	20 kw.	150 lamps searchlight	5,000
Oil tanker.....	.....	.....	7,500
Passenger and freight steamer.....	150 kw.	1,200 lamps searchlight electric heating system	27,000

**Cost of Refrigerating Systems.**—Cork insulation alone on sides, decks, bulkheads and inner bottom averages about 70 cents per square foot of surface for an entire compartment. The cost of the insulation, refrigerating machinery, brine tanks, compressors, piping, etc., averages for a steamer for carrying frozen or chilled meat 70 to 75 cents per cubic foot. These prices could be taken for other products also.

**Prices of Steam Engines and Boilers.**—The prices of steam engines alone as given in the table Weights of Engines Alone, page 306, varied from \$1.20 to \$1.28 per i. h. p.

Scotch boilers about 10 cents a pound. Water tube boilers as in the table Weights of Water Tube Boilers, page 308, varied from 23 to 25 cents a pound.

Cost of Fitting up a Steamer for Carrying Cattle, see page 331.

**Percentage of Cost of the Parts of a Motor Boat.**—The following figures apply to motor boats up to about 100 ft. in length, built for pleasure purposes and having a speed of around 10 miles an hour.

	Per cent.
Main power plant.....	24.2
Power plant accessories.....	2.4
Electrical equipment.....	7.5
Miscellaneous equipment.....	2.7
Finished hull.....	46.0
Deck equipment.....	11.0
Cabin equipment.....	6.2
<b>Total cost.....</b>	<b>100.0</b>



The equipment items for a 33-foot raised deck cruiser are as follows:

Main power plant, 20 h. p., 4-cycle motor, magneto, fuel tanks, piping, etc.

Electrical equipment, running lights, switches, storage battery, dynamo, and fixtures.

Miscellaneous equipment, charts, marine glasses, navigating instruments.

Finished hull, planked with 1¼-inch cedar, mahogany interior and cockpit finish, eight built-in lockers, ice box, galley, brass air ports, bronze rudder and shoe, steering wheel, skylight, signal mast, ventilators, etc.

Deck equipment, dinghy, life preservers, anchors, moorings, buoys, etc.

Cabin equipment, cushions, chairs, clock, bedding, rugs, stove, galley equipment.

**Estimates.** In preparing a bid on the building of a vessel or on repair work, the bid should be divided into three parts: (1) the overhead expenses, (2) the actual cost and (3) the profit. In the overhead is included such items as taxes, insurance, rent, interest on the money invested, salaries of non-producers as clerks, etc., and trial trip expenses, preparation of slip, launching ways, etc., directly charged to the vessel bid on—or if it is a repair job then include wharfage, water, etc.

The (2) or actual cost includes the cost of the materials and the time spent by the workman in completing and putting into place the finished product.

To the overhead expenses and actual cost is added a percentage for the profit to the yard for undertaking the work. The percentage is a variable quantity depending on how close the competition is and how badly the yard wants the particular contract.

Workmen in shipyards are divided into two classes, viz., piece workers and hour or day workers. Riveting, putting on shell plates and other structural work is generally done by piece work—while the men in the machine shop, outside machinists installing engines, boilers, etc., are paid by the hour or day. Naval Cons. W. B. Ferguson, U. S. N., in his book on "Art of Estimating" states— "If an operation is to be performed by day work, the relative efficiency of the day workers and of piece workers must be taken into account in estimating. The cost per day work will average between 25 and 50% greater than piece work cost under the ordinary form of management."

The parts pertaining to the hull are estimated in detail, as the cost of the raw material of each part, and the labor on it. The labor can only be closely estimated by making a note of every operation and the men's time, laying out sheets as the following:—

ESTIMATE SHEET.						
Estimate No. For					Submitted Date of Estimate	
Item	Cost Delivered	Handling at Yard	Labor			Total Cost Material and Labor
			Time (hours)	Rate	Total Labor	

All detail figures should be checked by referring to the costs of previous similar work. In many cases the hull cost can be reduced to a pound price—and the labor bears a percentage to the cost of the raw material. For example, the figures in the table Labor Costs per Pound are for direct labor cost only for the hull work of four types of vessels. The labor costs per pound in the table are for vessels built mostly by day work, and are considerably higher on the average than would be expected for piece work, bonus or contract system. The types selected for comparison are all United States Naval vessels: (1) battleship of New York class, (2) torpedo boat destroyer of 1,000 tons, (3) collier of Jupiter class and (4) standard 500-ton Navy coal barge.

#### Relative Cost of Different Types of Marine Propelling Machinery

Type of Vessel	Description of Machinery	Cost per 1. H. P. (trial trip)	Cost per ton of Finished Wt. Steam Up
Large cargo steamers....	Twin screw, 3 cylinder, triple.	£5.5-£6.5	£27.-£33.
Medium cargo steamers..	Single screw, 3 cylinder, triple	£5.0-£5.5	£22.-£27.
Intermediate ocean liners	Twin screw, 4 cylinder, quad..	£6.25-£7.5	£33.-£39.
Medium passenger and cargo.....	Twin screw, and single screw, 3 cylinder, triple.....	£5.5-£6.25	£30.-£36.

Table from Marine Eng'g Estimates, C. R. Bruce.

In estimating on the cost of machinery (boilers, engines, etc.) sheets may be ruled similar to the one for the hull as given above, so the different parts may be itemized for obtaining the costs of the raw materials and the labor. Note the following table:

## Direct Labor Costs per Pound in Cents\*

Items.	Battleship	Destroyer	Collier	Coal Barge
Ordinary steel in hull.....	4.6	7.7	2.1	1.1
Plating, outer and inner bottoms.....	2.1	4.0	1.1	1.0
Framing.....	4.1	7.0	1.5	.7
Bulkheads.....	4.7	8.0	2.2	1.1
Decks.....	3.0	6.0	1.4	.6
Bridges, hammock berthing and cofferdams.....	9.7	15.0	3.3	
Foundations for armor, turrets and guns.....	5.9			
Work around secondary battery, etc.....	15.1	15.0		
Foundations for machinery.....	7.3	10.0		
Inclosures.....	10.4	15.0	2.0	
Metal masts and spars.....	16.0		3.0	
Rivets.....	11.1	25.0	12.1	11.0
Steel castings and forgings forming structural parts of hull.....	5.3	16.1	1.7	
Deck pillars or stanchions.....	5.5	12.1	1.7	
Deck planking and wood in docking and bilge keels.....	6.1	8.0	4.0	1.1
Linoleum, tiling, etc.....	1.4	8.0	1.2	
Joiner work.....	30.9	30.0	8.0	
Carpenter work.....	11.7	12.0	5.0	
Wood ladders.....	39.4		15.4	
Wood masts and spars.....	24.6	35.0	16.5	38.0
Metal ladders.....	13.1	25.0	3.8	4.0
Paint, cement, etc.....	11.5	13.4	4.9	2.5
Turret turning machinery, roller tracks and rollers.....	9.0			
Fixed ammunition hoist machinery and gear.....	19.2	20.0		
Rudder and steering gear.....	5.1	13.8	3.4	
Cranes, davits and other gear for handling boats.....	11.6	10.0	8.3	3.0
Cooling gear.....	10.2		10.9	
Pumping and drainage, and sea connections.....	33.7	40.0		
Plumbing work, including fresh and salt water systems.....	25.5	25.0	7.9	
Ventilation.....	34.9	51.0	17.6	
Anchor and cable gear.....	6.8	13.3	4.1	2.3
Warping and towing gear.....	6.3	15.0	1.3	0.9
Hand rails and awning stanchions, canopy frames and hatch cranes.....	28.2	30.0	17.1	
Air ports, deck lights and light boxes.....	19.0	25.0	8.7	
Water tight doors.....	15.2	44.2	16.8	
Non water tight doors.....	28.7	18.1	17.2	
Manhole covers, scuttles, etc.....	21.4	30.0	2.6	0.8
Miscellaneous hull fittings.....	15.3	25.0	13.3	

\* From "The Art of Estimating the Cost of Work." W. B. Ferguson, Naval Constructor, U. S. N.

## SECTION VI

### MACHINERY

**STEAM, FUELS, OIL, BOILERS, MARINE STEAM ENGINES,  
STEAM TURBINES, STEAM PLANT AUXILIARIES,  
INTERNAL COMBUSTION ENGINES, PIPING,  
TUBING, VALVES AND FITTINGS**

#### STEAM

One British Thermal Unit (B. t. u.) is the quantity of heat required to raise the temperature of one pound of water one degree Fahrenheit when the water is at its greatest density (39.1° F.). Thus to raise the temperature of one pound of water from 39° to 40° requires one B. t. u., and to raise the temperature of one pound of boiler feed water from 67° to 212° requires approximately 212 - 67 = 145 B. t. u.

$$1 \text{ Heat unit (B. t. u.) equals } \begin{cases} 1055 \text{ watt-seconds} \\ 778 \text{ foot-pounds} \\ .000293 \text{ kw. hour} \\ .000393 \text{ h. p. hour} \end{cases}$$

**Calorie (French or Metric Unit of Heat).**—One calorie is the quantity of heat required to raise one kilogram of water one degree Centigrade. One calorie = 3.968 B. t. u. = 4158.6 watt seconds = 3065 ft. lb. = .0015 h. p. hour. One B. t. u. = .252 calorie.

#### **Mechanical Equivalent of Heat.**

$$1 \text{ B. t. u.} = 778 \text{ foot-pounds}$$

$$1 \text{ foot-pound} = \frac{1}{778} \text{ B. t. u.}$$

**Specific Heat of Steam,** or the coefficient of its thermal capacity, is the ratio of the heat required to raise its temperature one degree to that required to raise the temperature of water one degree from the temperature of its greatest density, viz., 39.1° F.

$$\text{Specific heat of saturated steam} = .48$$

$$\text{Specific heat of superheated steam} = .77$$

**Total Heat of Steam ( $H$ )** is the quantity of heat required to generate one pound of steam from water at a temperature of 32° F. to any given temperature and pressure. It is made up of the latent heat of evaporation and the sensible heat indicated by the thermometer.

Let  $t$  = temperature of steam

Then  $H$  (total heat of steam) = 1082 + .305 times  $t$

**Latent Heat of Steam ( $L$ )** is the quantity of heat required to transform one pound of water into steam at a given pressure, together with an amount of heat required to produce the external work done by increasing the volume of the water.

internal heat + external heat = latent heat of steam

Then  $L$  (latent heat of steam) = 1114 - .7 times  $t$ , where  $t$  = temperature of the steam.

In raising the temperature of one pound of water from 67° to 212° F., 145 B. t. u. are required, but after a temperature of 212° is reached, heat can be imparted to the water until it is all changed into steam with no increase in temperature, 970.4 B. t. u. being required for the change in converting one pound of water at 212° into one pound of steam at atmospheric pressure. The value 970.4 B. t. u. is known as the latent heat of steam or the heat of vaporization of steam at 212°. Some authorities, instead of using 970.4, use 966. Thus to change or evaporate into steam one pound of water at 212° requires 970.4 (or 966) units of heat.

**Efficiency of the Steam** in an engine is the ratio of the work done on the pistons in a given time (as measured by indicator diagrams) to the energy contained in the steam passing to the engine during the same time. In good modern engines using from 14 to 18 lb. of steam per i. h. p. per hour, this corresponds with steam efficiencies of 16½ to 12½%.

**Steam Consumption per i. h. p. in condensing engines** averages about 13.65 lb.

Type of Engine	Pounds of Steam per i. h. p. per Hour
Single non-condensing.....	30
Single condensing.....	20
Compound condensing.....	15
Triple expansion condensing.....	12

(See tables under Turbines; also under Marine Engines.)

**Kinds of Steam.**—**Saturated steam** is steam of the temperature due to its pressure—not superheated.

**Superheated steam** is steam heated to a temperature above that due to its pressure. The advantages claimed are fuel economy, water economy, and consequently increased carrying capacity of the vessel. Superheated steam is more common in Europe than in the United States. The degree of superheat may be divided as follows: low from zero to 50° F.; moderate 50° to 125°; and high 125° and upwards. Generally with turbines working at a pressure of 175 to 200 lb. there is a saving in steam consumption of about one per cent. for each 10° of superheat—which is true for reciprocating engines also. In a test made on a triple expansion engine, with an average superheat of 85° at the engine, there was a saving in the coal of about 9% (see table under Superheaters). With superheated steam the pipe lines and fittings should be of steel and cast steel respectively. Other materials as copper and bronze lose their strength in high temperatures and should be avoided in piping and fittings for highly superheated steam. As to the engine valves the high pressure cylinder valve should be of the piston type, preferably with an inside admission. For equal engine power the cut-off with superheated steam must be somewhat increased above that for saturated steam.

Superheated steam is greater in volume than saturated steam of the same pressure. Linde's equation is

$$pv = .5962 T - p (1 + .0014 p) \left( \frac{150,300,000}{T^2} - .0833 \right)$$

where  $p$  = pressure in pounds per square inch,

$v$  = volume in cubic feet,

$T$  = absolute pressure.

The table on page 344 from Peabody's Steam Tables gives the mean specific heat of superheated steam from the temperature of saturation to various temperatures at several pressures.

Thus the mean specific heat of steam at 142.2 lb. pressure when superheated to 572° F. is .53. The heat required to raise one pound of steam from a saturation temperature of 354° to 572° is  $(572 - 354) .53 = 115.5$  B. t. u. The total heat of the superheated steam is the sum of this quantity and the heat in the saturated steam. See also Superheaters.

**Dry steam** is steam that contains no moisture.

**Wet steam** is steam containing intermingled moisture, mist or

Kilograms per square centimeter		1	2	4	6	8	10	12	14	16	18	20
Pounds per square inch		14.2	28.4	56.9	85.3	113.8	142.2	170.6	199.1	227.5	256.0	284.4
Temp. saturation °C.		99	120	143	158	169	179	187	194	200	206	211
Temp. saturation °F.		210	248	289	316	336	354	369	381	392	403	412
°F.	°C.											
212	100	.463										
302	150	.462	.478	.515								
392	200	.462	.475	.502	.530	.560	.597	.635	.677			
482	250	.463	.474	.495	.514	.532	.552	.570	.588	.609	.635	.664
572	300	.464	.475	.492	.505	.517	.530	.541	.550	.561	.572	.585
662	350	.468	.477	.492	.503	.512	.522	.529	.536	.543	.550	.557
752	400	.473	.481	.494	.504	.512	.520	.526	.531	.537	.542	.547

spray. It has the same temperature as dry saturated steam of the same pressure.

**Miscellaneous Notes.**—The temperature of steam in contact with water depends upon the pressure under which it is generated. At the ordinary atmospheric pressure (14.7 lb. per square inch) its temperature is 212° F. As the pressure is increased, as by the steam being generated in a closed vessel, its temperature and that of the water in its presence increases.

Absolute zero is taken by different authorities as being from 459.2° to 460.66° below the Fahrenheit zero. The value, 460°, is close enough for all engineering calculations.

**Steam Table.**—The following table contains the properties of dry saturated steam. Column 1 gives the absolute pressure of the steam in pounds per square inch, the gauge pressure being 14.7 lb. less. Column 2 gives the corresponding temperature of the steam in Fahrenheit degrees. Column 3 gives the heat of the liquid, or the heat necessary to raise one pound of water from 32° to the boiling point corresponding to the pressure. Column 4 gives the latent heat, or the heat necessary to change a pound of water at the temperature of the boiling point into steam at the same temperature. Column 5 gives the total heat of the steam, and is the sum of the quantities in Column 3 and Column 4. Column 6 is the volume of one pound of steam at the different temperatures. Column 7 is the weight of one cubic foot of steam at the different temperatures.

PROPERTIES OF SATURATED STEAM

Abs. Pressure Pounds per Sq. In.*	Temperature Degrees F.	Heat of the Liquid	Latent Heat of Evaporation	Total Heat of Steam	Specific Volume Cu. Ft. per Pound	Density Pounds per Cu. Ft.	Abs. Pressure Pounds per Sq. In.
p	t	h	L	H	v	$\frac{1}{v}$	p
.0886	32	0	1072.6	1072.6	3301.0	.000303	.0886
.2562	60	28.1	1057.4	1085.5	1207.5	.000828	.2562
.5056	80	48.1	1046.6	1094.7	635.4	.001573	.5056
1	101.8	69.8	1034.6	1104.4	333.00	.00300	1
2	126.1	94.1	1021.4	1115.5	173.30	.00577	2
3	141.5	109.5	1012.3	1121.8	118.50	.00945	3
4	153.0	120.9	1005.6	1126.5	90.50	.01106	4
5	162.3	130.2	1000.2	1130.4	73.33	.01394	5
6	170.1	138.0	995.7	1133.7	61.89	.01616	6
7	176.8	144.8	991.6	1136.4	53.58	.01867	7
8	182.9	150.8	988.0	1138.8	47.27	.02115	8
9	188.3	156.3	984.8	1141.1	42.36	.02361	9
10	193.2	161.2	981.7	1142.9	38.38	.02606	10
11	197.7	165.8	978.9	1144.7	35.10	.02849	11
12	202.0	170.0	976.3	1146.3	32.38	.03089	12
13	206.9	173.9	973.9	1147.8	30.04	.03329	13
14	209.6	177.6	971.6	1149.2	28.02	.03568	14
14.7	212.0	180.1	970.0	1150.1	26.79	.03733	14.7
15	213.0	181.1	969.4	1150.5	26.27	.03806	15
16	216.3	184.5	967.3	1151.8	24.77	.04042	16
17	219.4	187.7	965.3	1153.0	23.38	.04277	17
18	222.4	190.6	963.4	1154.0	22.16	.04512	18
19	225.2	193.5	961.5	1155.0	21.07	.04746	19
20	228.0	196.2	959.7	1155.9	20.08	.04980	20
21	230.6	198.9	958.0	1156.9	19.18	.05213	21
22	233.1	201.4	956.4	1157.8	18.37	.05445	22
23	235.5	203.9	954.8	1158.7	17.62	.05676	23
24	237.8	206.2	953.2	1159.4	16.93	.05907	24
25	240.1	208.5	951.7	1160.2	16.30	.0614	25
26	242.2	210.7	950.3	1161.0	15.71	.0636	26
27	244.4	212.8	948.9	1161.7	15.18	.0659	27
28	246.4	214.9	947.5	1162.4	14.67	.0682	28
29	248.4	217.0	946.1	1163.1	14.19	.0705	29
30	250.3	218.9	944.8	1163.7	13.74	.0728	30
31	252.2	220.8	943.5	1164.3	13.32	.0751	31
32	254.1	222.7	942.2	1164.9	12.93	.0773	32
33	255.8	224.5	941.0	1165.5	12.57	.0795	33
34	257.6	226.3	939.8	1166.1	12.22	.0818	34
35	259.3	228.0	938.6	1166.6	11.89	.0841	35
36	261.0	229.7	937.4	1167.1	11.58	.0863	36
37	262.6	231.4	936.3	1167.7	11.29	.0886	37
38	264.2	233.0	935.2	1168.2	11.01	.0908	38
39	265.8	234.6	934.1	1168.7	10.74	.0931	39
40	267.3	236.2	933.0	1169.2	10.49	.0953	40
41	268.7	237.7	931.9	1169.6	10.25	.0976	41
42	270.2	239.2	930.9	1170.1	10.02	.0998	42
43	271.7	240.6	929.9	1170.5	9.80	.1020	43
44	273.1	242.1	928.9	1171.0	9.59	.1043	44
45	274.5	243.5	927.9	1171.4	9.39	.1065	45
46	275.8	244.9	926.9	1171.8	9.20	.1087	46
47	277.2	246.2	926.0	1172.2	9.02	.1109	47
48	278.5	247.6	925.0	1172.6	8.84	.1131	48
49	279.8	248.9	924.1	1173.0	8.67	.1153	49
50	281.0	250.2	923.2	1173.4	8.51	.1175	50
51	282.3	251.5	922.3	1173.8	8.35	.1197	51
52	283.5	252.8	921.4	1174.2	8.20	.1219	52
53	284.7	254.0	920.5	1174.5	8.05	.1241	53

\* To get the gauge pressure subtract 14.7 lbs. from the absolute.



## PROPERTIES OF SATURATED STEAM—Continued

Abs. Pressure Pounds per Sq. In.	Temperature Degrees F.	Heat of the Liquid	Latent Heat of Evaporation	Total Heat of Steam	Specific Volume Cu. Ft. per Pound	Density Pounds per Cu. Ft.	Abs. Pressure Pounds per Sq. In.
<i>p</i>	<i>t</i>	<i>h</i>	<i>L</i>	<i>H</i>	<i>v</i>	$\frac{1}{v}$	<i>p</i>
54	285.9	255.2	919.6	1174.8	7.91	.1263	54
55	287.1	256.4	918.7	1175.1	7.78	.1265	55
56	288.2	257.6	917.9	1175.5	7.65	.1307	56
57	289.4	258.8	917.1	1175.9	7.52	.1329	57
58	290.5	259.9	916.2	1176.1	7.40	.1351	58
59	291.6	261.1	915.4	1176.5	7.28	.1373	59
60	292.7	262.2	914.6	1176.8	7.17	.1394	60
61	293.8	263.3	913.8	1177.1	7.06	.1416	61
62	294.9	264.4	913.0	1177.4	6.95	.1438	62
63	295.9	265.5	912.2	1177.7	6.85	.1460	63
64	297.0	266.5	911.5	1178.0	6.75	.1482	64
65	298.0	267.6	910.7	1178.3	6.65	.1503	65
66	299.0	268.6	910.0	1178.6	6.56	.1525	66
67	300.0	269.7	909.2	1178.9	6.47	.1547	67
68	301.0	270.7	908.4	1179.1	6.38	.1569	68
69	302.0	271.7	907.7	1179.4	6.29	.1591	69
70	302.9	272.7	906.9	1179.6	6.20	.1612	70
71	303.9	273.7	906.2	1179.9	6.12	.1634	71
72	304.8	274.6	905.5	1180.1	6.04	.1656	72
73	305.8	275.6	904.8	1180.4	5.96	.1678	73
74	306.7	276.6	904.1	1180.7	5.89	.1699	74
75	307.6	277.5	903.4	1180.9	5.81	.1721	75
76	308.5	278.5	902.7	1181.2	5.74	.1743	76
77	309.4	279.4	902.1	1181.5	5.67	.1764	77
78	310.3	280.3	901.4	1181.7	5.60	.1786	78
79	311.2	281.2	900.7	1181.9	5.54	.1808	79
80	312.0	282.1	900.1	1182.2	5.47	.1829	80
81	312.9	283.0	899.4	1182.4	5.41	.1851	81
82	313.8	283.8	898.8	1182.6	5.34	.1873	82
83	314.6	284.7	898.1	1182.8	5.28	.1894	83
84	315.4	285.6	897.5	1183.1	5.22	.1915	84
85	316.3	286.4	896.9	1183.3	5.16	.1937	85
86	317.1	287.3	896.2	1183.5	5.10	.1959	86
87	317.9	288.1	895.6	1183.7	5.05	.1980	87
88	318.7	288.9	895.0	1183.9	5.00	.2002	88
89	319.5	289.8	894.3	1184.1	4.94	.2024	89
90	320.3	290.6	893.7	1184.3	4.89	.2045	90
91	321.1	291.4	893.1	1184.5	4.84	.2066	91
92	321.8	292.2	892.5	1184.7	4.79	.2088	92
93	322.6	293.0	891.9	1184.9	4.74	.2110	93
94	323.4	293.8	891.3	1185.1	4.69	.2131	94
95	324.1	294.5	890.7	1185.2	4.65	.2152	95
96	324.9	295.3	890.1	1185.4	4.60	.2173	96
97	325.6	296.1	889.5	1185.6	4.56	.2194	97
98	326.4	296.8	889.0	1185.8	4.51	.2215	98
99	327.1	297.6	888.4	1186.0	4.47	.2237	99
100	327.8	298.4	887.8	1186.2	4.430	.2257	100
101	328.6	299.1	887.2	1186.3	4.389	.2278	101
102	329.3	299.8	886.7	1186.5	4.349	.2299	102
103	330.0	300.6	886.1	1186.7	4.309	.2321	103
104	330.7	301.3	885.6	1186.9	4.270	.2342	104
105	331.4	302.0	885.0	1187.0	4.231	.2364	105
106	332.0	302.7	884.5	1187.2	4.193	.2385	106
107	332.7	303.4	883.9	1187.3	4.156	.2407	107
108	333.4	304.1	883.4	1187.5	4.119	.2428	108
109	334.1	304.8	882.8	1187.6	4.082	.2450	109
110	334.8	305.5	882.3	1187.8	4.047	.2472	110

PROPERTIES OF SATURATED STEAM—Continued

Abs. Pressure Pounds per Sq. In.	Temperature Degrees F.	Heat of the Liquid	Latent Heat of Evaporation	Total Heat of Steam	Specific Volume Cu. Ft. per Pound	Density Pounds per Cu. Ft.	Abs. Pressure Pounds per Sq. In.
<i>p</i>	<i>t</i>	<i>h</i>	<i>L</i>	<i>H</i>	<i>v</i>	$\frac{1}{v}$	<i>p</i>
111	335.4	306.2	881.8	1188.0	4.012	.2493	111
112	336.1	306.9	881.2	1188.1	3.977	.2514	112
113	336.8	307.6	880.7	1188.3	3.944	.2535	113
114	337.4	308.3	880.2	1188.5	3.911	.2557	114
114.7	337.9	308.8	879.8	1188.6	3.888	.2572	114.7
115	338.1	309.0	879.7	1188.7	3.878	.2578	115
116	338.7	309.6	879.2	1188.8	3.846	.2600	116
117	339.4	310.3	878.7	1189.0	3.815	.2621	117
118	340.0	311.0	878.2	1189.2	3.784	.2642	118
119	340.6	311.7	877.6	1189.3	3.754	.2663	119
120	341.3	312.3	877.1	1189.4	3.725	.2684	120
121	341.9	313.0	876.6	1189.6	3.696	.2706	121
122	342.5	313.6	876.1	1189.7	3.667	.2727	122
123	343.2	314.3	875.6	1189.9	3.638	.2749	123
124	343.8	314.9	875.1	1190.0	3.610	.2770	124
125	344.4	315.5	874.6	1190.1	3.582	.2792	125
126	345.0	316.2	874.1	1190.3	3.555	.2813	126
127	345.6	316.8	873.7	1190.5	3.529	.2834	127
128	346.2	317.4	873.2	1190.6	3.503	.2855	128
129	346.8	318.0	872.7	1190.7	3.477	.2876	129
130	347.4	318.6	872.2	1190.8	3.452	.2897	130
131	348.0	319.3	871.7	1191.0	3.427	.2918	131
132	348.5	319.9	871.2	1191.1	3.402	.2939	132
133	349.1	320.5	870.8	1191.3	3.378	.2960	133
134	349.7	321.0	870.4	1191.4	3.354	.2981	134
135	350.3	321.6	869.9	1191.5	3.331	.3002	135
136	350.8	322.2	869.4	1191.6	3.308	.3023	136
137	351.4	322.8	868.9	1191.7	3.285	.3044	137
138	352.0	323.4	868.4	1191.8	3.263	.3065	138
139	352.5	324.0	868.0	1192.0	3.241	.3086	139
140	353.1	324.5	867.6	1192.1	3.219	.3107	140
141	353.6	325.1	867.1	1192.2	3.198	.3128	141
142	354.2	325.7	866.6	1192.3	3.176	.3149	142
143	354.7	326.3	866.2	1192.5	3.155	.3170	143
144	355.3	326.8	865.8	1192.6	3.134	.3191	144
145	355.8	327.4	865.3	1192.7	3.113	.3212	145
146	356.3	327.9	864.9	1192.8	3.093	.3233	146
147	356.9	328.5	864.4	1192.9	3.073	.3254	147
148	357.4	329.0	864.0	1193.0	3.053	.3275	148
149	357.9	329.6	863.5	1193.1	3.033	.3297	149
150	358.5	330.1	863.1	1193.2	3.013	.3319	150
152	359.5	331.2	862.3	1193.5	2.975	.3361	152
154	360.5	332.3	861.4	1193.7	2.939	.3403	154
156	361.6	333.4	860.5	1193.9	2.903	.3445	156
158	362.6	334.4	859.7	1194.1	2.868	.3487	158
160	363.6	335.5	858.8	1194.3	2.834	.3529	160
162	364.6	336.6	858.0	1194.6	2.801	.3570	162
164	365.6	337.6	857.2	1194.8	2.768	.3613	164
166	366.5	338.6	856.4	1195.0	2.736	.3655	166
168	367.5	339.6	855.5	1195.1	2.705	.3697	168
170	368.5	340.6	854.7	1195.3	2.674	.3739	170
172	369.4	341.6	853.9	1195.5	2.644	.3782	172
174	370.4	342.5	853.1	1195.6	2.615	.3824	174
176	371.3	343.5	852.3	1195.8	2.587	.3865	176
178	372.2	344.5	851.5	1196.0	2.560	.3907	178
180	373.1	345.4	850.8	1196.2	2.532	.3949	180
182	374.0	346.4	850.0	1196.4	2.506	.3990	182

PROPERTIES OF SATURATED STEAM—*Concluded*

Abs. Pressure Pounds per Sq. In.	Temperature Degrees F.	Heat of the Liquid	Latent Heat of Evaporation	Total Heat of Steam	Specific Volume Cu. Ft. per Pound	Density Pounds per Cu. Ft.	Abs. Pressure Pounds per Sq. In.
<i>p</i>	<i>t</i>	<i>h</i>	<i>L</i>	<i>H</i>	<i>v</i>	$\frac{1}{v}$	<i>p</i>
184	374.9	347.4	849.3	1196.7	2.480	.4032	184
186	375.8	348.3	848.5	1196.8	2.455	.4074	186
188	376.7	349.2	847.7	1196.9	2.430	.4115	188
190	377.6	350.1	847.0	1197.1	2.406	.4157	190
192	378.5	351.0	846.2	1197.2	2.381	.4200	192
194	379.3	351.9	845.5	1197.4	2.358	.4242	194
196	380.2	352.8	844.8	1197.6	2.335	.4284	196
198	381.0	353.7	844.0	1197.7	2.312	.4326	198
200	381.9	354.6	843.3	1197.9	2.289	.4370	200
202	382.7	355.5	842.6	1198.1	2.268	.4411	202
204	383.5	356.4	841.9	1198.3	2.246	.4452	204
206	384.4	357.2	841.2	1198.4	2.226	.4493	206
208	385.2	358.1	840.5	1198.6	2.208	.4534	208
210	386.0	358.9	839.8	1198.7	2.186	.4575	210
212	386.8	359.8	839.1	1198.9	2.166	.4618	212
214	387.6	360.6	838.4	1199.0	2.147	.4660	214
216	388.4	361.4	837.7	1199.1	2.127	.4700	216
218	389.1	362.3	837.0	1199.3	2.108	.4744	218
220	389.9	363.1	836.4	1199.5	2.090	.4787	220
222	390.7	363.9	835.7	1199.6	2.072	.4829	222
224	391.5	364.7	835.0	1199.7	2.054	.4870	224
226	392.2	365.5	834.3	1199.8	2.037	.4910	226
228	393.0	366.3	833.7	1200.0	2.020	.4950	228
230	393.8	367.1	833.0	1200.1	2.003	.4992	230
232	394.5	367.9	832.3	1200.2	1.987	.503	232
234	395.2	368.6	831.7	1200.3	1.970	.507	234
236	396.0	369.4	831.0	1200.4	1.954	.511	236
238	396.7	370.2	830.4	1200.6	1.938	.516	238
240	397.4	371.0	829.8	1200.8	1.923	.520	240
242	398.2	371.7	829.2	1200.9	1.907	.524	242
244	398.9	372.5	828.5	1201.0	1.892	.528	244
246	399.6	373.3	827.8	1201.1	1.877	.532	246
248	400.3	374.0	827.2	1201.2	1.862	.537	248
250	401.1	374.7	826.6	1201.3	1.848	.541	250
275	409.6	383.7	819.0	1202.7	1.684	.594	275
300	417.5	392.0	811.8	1203.8	1.547	.647	300
350	431.9	407.4	798.5	1205.9	1.330	.750	350

Above table from Steam Tables, by Prof. C. H. Peabody. Definitions and formulae include abstracts from *Prac. Marine Eng'g and Oil Fuel*.

**Volume of Steam.**—If water at boiling point (212° F) is evaporated into steam at atmospheric pressure, the volume of the steam will be 1577 times the volume of the water from which it was evaporated. Or one cubic inch of water will produce nearly one cubic foot (1728 cu. ins.) of steam.

**Pounds or Gallons of Water Evaporated into Dry Steam per Pound of Coal.**—Eight to ten pounds of water can be evaporated in well-designed boilers with good draft for every pound of bituminous coal used.

*Example.* The temperature of the feed water is  $110^{\circ}$ , the steam pressure 150 lb., the thermal value of the coal used is 14,000 B. t. u. per pound, and the efficiency of the boiler is .64. Find the pounds of water evaporated into dry steam per pounds of coal.

From the steam tables the heat in the water at  $212^{\circ}$  at a pressure of 150 lb. gauge or 164.7 absolute ( $150 + 14.7$ ) = 338

Heat in the feed water ( $110^{\circ} - 32^{\circ}$ ) = 78

260 difference

Latent heat of steam at 164.7 lbs. = 857

Then heat required per pound of dry steam = 1117.

The heat available per pound of coal = .64 (efficiency of boiler)  $\times$  14,000  
B. t. u. = 8960. Hence pounds of steam evaporated =  $\frac{8960}{1117}$  = 8.03.

To convert 8.03 lb. of water into U. S. gallons divide by 8.33, as one U. S. gallon weighs 8.33 lb.

$$\text{Thus } \frac{8.03}{8.33} = .96 \text{ gallon}$$

**Pounds of Coal Required to Evaporate One Pound or One Gallon of Water into Steam.**

Let  $T$  = steam temperature, and  $t$  = feed water temperature

Then units of heat =  $1115 + .3(T - t)$

*Example.* The steam pressure in a Scotch boiler is 160 lb. and the temperature  $370^{\circ}$ . The feed water temperature is  $140^{\circ}$ . Find the units of heat required to evaporate one pound of water into steam, and the number of pounds of water evaporated by one pound of coal.

Units of heat required per pound of coal =  $1115 + .3(370^{\circ} - 140^{\circ}) = 1086$ .

Assume that one pound of coal gives out 9,000 units of heat (B. t. u.)

Then  $\frac{9000}{1086} = 8.28$  lb. of water or .99 gallon are evaporated per pound of coal.

**Coal Consumption.**—The coal required per indicated horse power per hour in good practice is between 1.5 to 2.0 lb.

Let  $C$  = pounds of coal per i. h. p. per hour

$H$  = i. h. p.

$C \times H$  = pounds of coal per hour

$\frac{C \times H}{2240}$  = tons of coal per hour

Then tons of coal per day of 24 hours =  $\frac{24 \times C \times H}{2240} = \frac{C \times H}{93.3}$

Formulae from Prac. Marine Eng'g and Verbal Notes, J. W. M. Sothern.

As a quick estimate it may be assumed that a coal consumption of 1.86 lb. per i. h. p. per hour (a figure only moderately good) the coal consumed per day will be 20 tons per 1000 i. h. p. See Marine Engines, paragraph To Calculate the Coal Consumption per i. h. p.

*Example.* How many tons of coal will be required in the bunkers of a ship making a 7-day trip, with a coal consumption of 1.78 lb. per i. h. p., the engines being of 2,400 i. h. p., and a margin of 10% being allowed for emergencies.

$$\text{Coal per day using formula} = \frac{24 \times C \times H}{2240} = \frac{3 \times 1.78 \times 2400}{280} = 45.77 \text{ tons}$$

$$\text{Coal for 7 days} = 7 \times 45.77 = 320 \text{ tons}$$

$$\text{Margin 10\%} = 32$$

352 tons required

The rate of combustion in a furnace is computed by the pounds of fuel consumed per square foot of grate surface per hour. In general practice the rate for natural draft for anthracite coal is from 7 to 16 lb., for bituminous from 10 to 25 lb., and with artificial or forced draft as by a blower, exhaust blast, or steam jet, the rate may be increased from 30 to 120 lb. Consumption of fuel averages  $7\frac{1}{2}$  lb. of coal or 15 lb. dry pine wood per cubic foot of water evaporated.

Fuel (Coal or Oil) Consumption\* may be said to vary approximately as the horse power developed. The horse power varies as the cube (within certain limits) of the speed, hence it follows that the fuel consumption will vary approximately as the cube of the speed.

Let  $S$  = certain speed of vessel

$C$  = coal or oil consumption at speed  $S$

$s$  = new speed

$c$  = coal or oil consumption at speed  $s$

$$\text{Then } c = \frac{s^3 \times C}{S^3} \text{ and } s = \sqrt[3]{\frac{c \times S^3}{C}}$$

*Example.* A steamer consumes 100 tons of coal per day at a speed of 10 knots. What should be her speed if the coal consumption were cut down to 50 tons a day.

$$\text{Using the formula } s = \sqrt[3]{\frac{c \times S^3}{C}} = \sqrt[3]{\frac{50 \times 10^3}{100}} = 7.9 \text{ knots}$$

**Evaporation per Pound of Combustible.**—It is often necessary to make an allowance for ash in the coal, or for the ash and moisture, so as to obtain the evaporation per pound of actual combustible matter. This is obtained by dividing the evaporation per pound of coal by the fraction of the coal which is combustible.

\*From Mariner's Handbook.

The average multi-tubular boiler with coal evaporates 9 to 11 lb. of water per pound of coal. With oil it evaporates 15 to 16.5 lb. of water per pound of oil. (See Factor of Evaporation.)

3½ to 4 barrels of oil are equivalent in boiler evaporation to one ton of coal. The average barrel of oil holds 50 to 51 gallons. See Oil.

**Heat Values of Coal.**—In anthracite coal the proportion of volatile matter varies from 3 to 10%, in semi-anthracite and semi-bituminous from 10 to 20%, and in bituminous from 20 to 50%. The amount of ash in good coal should not exceed 8 or 10%, although occasionally it is only 5%.

Coal	Fixed Carbon	Volatile Matter	B. t. u. per Pound of Combustible	B. t. u. per Pound of Coal
Anthracite, Pennsylvania, average of 21 samples	84.25%	5.62%	14113	12685
Bituminous, Pennsylvania average of 28 samples	51.17%	34.04%	14948	13634
Pocahontas (West Virginia)	73.65%	18.30%	15682	14419

From Oil Fuel.

**Calorific Value of Coal from its Chemical Analysis.**—B. t. u. per pound of coal =  $14600 C + 62000 \left( H - \frac{O}{8} \right) + 4000 S$

Where  $C$ ,  $H$ ,  $O$  and  $S$  are the proportionate parts by weight of carbon, hydrogen, oxygen and sulphur. Take for example a coal of the following composition (Pocahontas run of mine):  $C = 85.4\%$ ,  $H = 4.39\%$ ,  $O = 3.94\%$ ,  $S = 0.62\%$ .

Then B. t. u. per lb. =  $14600 \times .854 + 62000 \left( .0439 - \frac{.0394}{8} \right) + 4000 \times .006 = 14910$ .

As tested by a calorimeter this coal had actually a calorific value of 14906. The above formula is recommended by the American Society of Mechanical Engineers.

#### Size of Coal

Anthracite coal is graduated commercially as follows:

Lump over bars set 3½ to 5 ins. apart.  
 Steamboat over 3½-inch mesh and out of screen  
 Broken over 2¾-inch mesh, through 3½-inch mesh  
 Egg over 2 -inch mesh, through 2¾-inch mesh  
 Stove over 1¾-inch mesh, through 2 -inch mesh

Chestnut	over	$\frac{3}{4}$ -inch mesh,	through	$1\frac{3}{8}$ -inch mesh
Pea	over	$\frac{1}{2}$ -inch mesh,	through	$\frac{3}{4}$ -inch mesh
Buckwheat	over	$\frac{3}{8}$ -inch mesh,	through	$\frac{1}{2}$ -inch mesh
Rice	over	$\frac{1}{4}$ -inch mesh,	through	$\frac{3}{8}$ -inch mesh
Culm, slack, or screenings	through	$\frac{1}{8}$ -inch mesh.		

Bituminous or soft coal is graduated as follows:

Run of mine in fine and large lumps.

Lump or Block goes through 6-inch screen or over.

Egg goes	over	3-inch mesh,	through	6-inch
No. 1 Roller Screened Nut	over	2-inch mesh,	through	$3\frac{1}{2}$ -inch
No. 2 Roller Screened Nut	over	$1\frac{1}{2}$ -inch mesh,	through	2-inch
No. 3 Roller Screened Nut	over	1-inch mesh,	through	$1\frac{1}{2}$ -inch
No. 1 Washed Egg	over	2-inch mesh,	through	3-inch
No. 2 Washed Stove	over	$1\frac{1}{4}$ -inch mesh,	through	2-inch
No. 3 Washed Chestnut	over	$\frac{3}{4}$ -inch mesh,	through	$1\frac{1}{4}$ -inch
No. 4 Washed	over	$\frac{1}{4}$ -inch mesh,	through	$\frac{3}{4}$ -inch
No. 1 Domestic Nut	over	$1\frac{1}{2}$ or 2-inch mesh,	through	3-inch
No. 2 Nut	over	$1\frac{1}{4}$ -inch mesh,	through	2-inch
No. 3	over	$\frac{3}{4}$ -inch mesh,	through	$1\frac{1}{4}$ -inch

Duff through  $\frac{1}{8}$ -inch mesh.

Screenings smallest sizes.

Pocahontas Smokeless generally sized as Nut, Egg, Lump and Mine Run.

**Heat Values of Wood.**—The average heat value of dry wood is 8,500 B. t. u. per pound, for wood with 25% moisture 6,000 B. t. u. and for 40% moisture 4,600.

One Cord Air Dried Hickory or Hard Maple weighs about 4,500 lb. and is equal to about 2,000 lb. coal.

One Cord Air Dried White Oak weighs about 3,850 lb., and is equal to about 1,715 lb. coal.

One Cord Air Dried Beech, Red Oak and Black Oak weighs about 3,250 lb., and is equal to about 1,450 lb. coal.

One Cord Air Dried Poplar (whitewood), Chestnut and Elm weighs about 2,250 lb., and is equal to about 1,050 lb. coal.

One Cord Air Dried Average Pine weighs about 2,000 lb., and is equal to about 825 lb. coal.

From the above it is safe to assume that  $2\frac{1}{4}$  lb. of dry wood is equal to 1 lb. average quality of soft coal, and that the full value of the same weight of different woods is very nearly the same—that is, a pound of hickory is worth no more for fuel than a pound of pine, assuming both to be dry. It is important that the wood be dry, as each 10% of water or moisture in wood will detract about 12% from its value as fuel. (Cord of wood a pile 4 ft.  $\times$  4 ft.  $\times$  8 ft.)

**Heat Value of Oil,** see section on Oil.

**Temperature of Fire.**—The following table from M. Pouillet will enable the temperature to be judged by the appearance of the fire:

Appearance	Temp. F.	Appearance	Temp. F.
Red, just visible.....	997°	Orange, deep.....	1830°
Red, dull.....	1290	Orange, clear.....	2156
Red, cherry dull.....	1470	White heat.....	2010
Red, cherry full.....	1650	White bright.....	2550
Red, cherry clear.....	1830	White dazzling.....	2910

#### QUANTITY OF AIR REQUIRED FOR COMBUSTION OF FUEL

Fuel	Air per Pound	Air per Kilogram
	Cubic Feet	Cubic Meter
Coke.....	162.06	10.09
Coal (anthracite).....	144.60	9.01
Coal (bituminous).....	143.40	8.93
Charcoal.....	133.90	8.53
Lignite.....	112.43	7.02
Peat, dry.....	92.36	5.75
Wood, dry.....	73.36	4.57
Petroleum.....	172.86	10.76
Producer gas.....	11.56	.72

See also section on Draft.

#### OIL

Crude petroleum as it comes from the well varies in physical and chemical properties in different districts and countries and at different depths in the same district. It is nearly always lighter than water. The diagram below shows how by refinement the various oils are obtained.

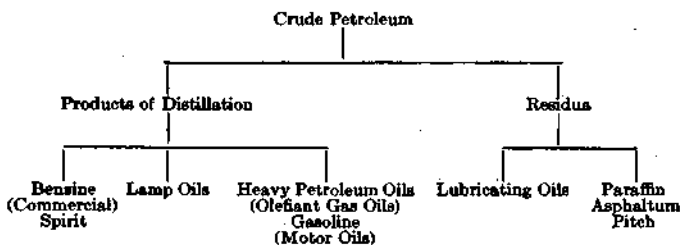



	Gravity deg. Bé.	Flash Point deg. F.	Burning Point deg. F.
Crude oil.....	12 to 45	110 to 200	120 to 220
Kerosene.....	40 to 50	90 to 125	105 to 150
Distillate (gas oil).....	28 to 38	100 to 250	110 to 325
Fuel oil.....	22 to 28	100 to 300	125 to 375
Residuum.....	10 to 20	125 to 500	200 to 600

FUEL OIL  
(60° F.)

Specific Gravity	Beaumé Grav.	Lb. per Am. Gal.	Lb. per Eng. Gal.	Cu. Ft. per Ton	Gal. Amer. per Ton	Gal. Eng. per Ton	Bbls. per Ton
1.0000	10.	8.331	10.	35.94	268.875	224.	6.40
.9956	10.5	8.302	9.995	36.09	269.81	224.75	6.42
.9930	11.	8.273	9.930	36.19	270.76	225.55	6.44
.9895	11.5	8.244	9.895	36.32	271.71	226.33	6.46
.9860	12.	8.214	9.860	36.45	272.57	227.13	6.49
.9825	12.5	8.185	9.825	36.57	273.66	227.96	6.51
.9790	13.	8.156	9.790	36.71	274.62	228.80	6.54
.9755	13.5	8.127	9.755	36.84	275.62	229.62	6.56
.9720	14.	8.098	9.720	36.97	276.67	230.49	6.58
.9685	14.5	8.069	9.685	37.10	277.47	231.16	6.60
.9655	15.	8.044	9.650	37.22	278.46	231.98	6.63
.9625	15.5	8.019	9.625	37.34	279.33	232.71	6.65
.9595	16.	7.994	9.595	37.46	280.19	233.42	6.66
.9560	16.5	7.964	9.560	37.59	281.26	234.31	6.69
.9530	17.	7.929	9.530	37.71	282.22	235.11	6.74
.9495	17.5	7.910	9.495	37.85	283.08	235.90	6.75
.9465	18.	7.885	9.465	37.97	284.08	236.66	6.76
.9430	18.5	7.856	9.430	38.11	285.13	237.52	6.76
.9400	19.	7.831	9.400	38.23	286.04	238.30	6.81
.9370	19.5	7.806	9.370	38.35	286.95	239.06	6.83
.9340	20.	7.781	9.340	38.47	287.88	239.82	6.85
.9310	20.5	7.756	9.310	38.60	288.88	240.60	6.87
.9280	21.	7.730	9.280	38.73	289.74	241.34	6.89
.9250	21.5	7.706	9.250	38.85	290.68	242.16	6.89
.9220	22.	7.680	9.220	38.98	291.62	242.95	6.94
.9195	22.5	7.660	9.195	39.09	292.42	243.61	6.96
.9165	23.	7.635	9.165	39.21	293.25	244.40	6.98
.9135	23.5	7.615	9.135	39.34	294.15	245.21	7.00
.9105	24.	7.585	9.105	39.47	295.31	246.01	7.03
.9045	25.	7.536	9.040	39.73	297.24	247.64	7.07
.8990	26.	7.490	8.990	39.97	299.06	249.15	7.08
.8930	27.	7.440	8.930	40.24	301.07	250.84	7.12
.8870	28.	7.390	8.870	40.51	303.11	252.53	7.21
.8815	29.	7.344	8.815	40.77	305.01	254.00	7.25
.8755	30.	7.294	8.755	41.04	307.10	255.85	7.31
.8700	31.	7.248	8.700	41.31	309.19	257.47	7.36
.8650	32.	7.206	8.650	41.54	310.85	258.94	7.40
.8595	33.	7.160	8.595	41.81	312.84	260.61	7.44
.8545	34.	7.119	8.545	42.05	314.65	262.14	7.46
.8490	35.	7.070	8.490	42.32	316.83	263.83	7.51
.8440	36.	7.031	8.440	42.53	318.58	265.40	7.58
.8395	37.	6.994	8.395	42.81	320.27	266.82	7.62
.8345	38.	6.952	8.345	43.06	322.67	268.42	7.70
.8295	39.	6.911	8.295	43.32	324.12	270.04	7.71
.8250	40.	6.873	8.250	43.56	325.90	271.51	7.78

*General Notes and Terms*

To find the weight of a gallon of oil multiply the weight of a gallon of water at 60° F. (8.328 lb.) by the specific gravity of the oil.

Oil barrels are usually 21 ins. in diameter at the top and bottom, 24 at the middle, 35 ins. high, and contain approximately 51 gallons. Weight of a barrel of oil = 51 gallons  $\times$  weight of a gallon of oil which at 30° Beaumé is 7.29 lb. (see table) = 373 lb. plus the weight of the barrel or 70 lb. making a total of 443 lb. See page 20.

A quick way to find the capacity of a barrel in Imperial gallons: use the formula .0014162  $\times$  length in inches  $\times$  (diameter at middle in inches)<sup>2</sup>. To convert Imperial gallons into U. S. gallons multiply by 1.2.

Heavy oils as fuel oils expand, when heated, about 1% for every 25° of temperature, corrections being made to 60° F. If temperature is above 60°, subtract, and if below, add.

The density of an oil is specified in degrees Beaumé at a temperature of 60° F. For indicating the density an instrument called a hydrometer (having an arbitrary scale the readings of which are in degrees) is allowed to float freely in the oil. The Beaumé gravity value is then read at the point where the surface of the oil intersects the scale.

Specific gravity is the ratio of the weight of a solid or liquid to an equal volume of water at 60° F. To calculate the specific gravity of an oil at any temperature, having given its specific gravity at 60° F., take the number of degrees above or below 60° and multiply them by a constant which for heavy oils of 20° Beaumé and below is .00034, for those of 30° Beaumé .0004, of 30° to 40° Beaumé .00045, and for refined oil .00050. The product is to be added to or subtracted from the original specific gravity according as the temperature is below or above 60° F.

For reducing Beaumé readings at 60° F. to specific gravity use the formula:

$$\text{Specific gravity} = \frac{140}{130 + \text{degrees Beaumé}}$$

*Example.* An oil at a temperature of 60° F., has a reading of 22 on the Beaumé scale. Find its specific gravity.

$$\text{Specific gravity} = \frac{140}{130 + 22} = .922$$

## SPECIFIC GRAVITIES AND WEIGHTS OF VARIOUS OILS

Oil	Specific Gravity	Weight Pounds per Cubic Foot
Vegetable oils.....	.91—.94	58
Mineral lubricating oils.....	.90—.93	57
Petroleum.....	.87	54
Petroleum, refined.....	.79—.82	50
Benzine.....	.73—.75	46
Gasoline.....	.66—.69	42

**Flash point** of an oil is the lowest temperature at which the vapors arising therefrom ignite, without setting fire to the oil itself, when a small test flame is quickly brought near its surface and quickly removed.

**Fire point** is the lowest temperature at which an oil ignites from its own vapors when a small flame is quickly brought near its surface and quickly removed. The fire point is about 50° above the flash point.

The **viscosity** of an oil is told by the number of seconds required for a certain quantity to flow through a standard aperture at constant temperatures, generally at 70°, 100° and 212° F. Gasoline is an example of a non-viscous oil.

Color does not indicate the quality of an oil, neither does it show if it is suitable for any particular service.

**Chill or cold test** is the lowest temperature at which an oil will pour. It gives no idea of the lubricating properties of an oil.

**Oil for Boilers.**—Oil between 15° and 30° Beaumé is, as a rule, suitable for boilers. It should not be too heavy to be easily vaporized by a jet of steam or to cause trouble in cold weather, and not so light and volatile as to be flashy.

With internally mixed burners where the oil and steam come together inside the burner it is necessary to maintain sufficient pressure of oil to overcome the back pressure of the steam and at the same time supply the proper amount of oil. This requires a pressure from 30 to 50 lb. With externally mixed burners, it is necessary to have only a pressure to insure the free passage of oil through the pipes, which is 4 to 5 lb. It is desirable in both types to heat the oil to a temperature of around 150° F.

**Heat Values of Oil.**—14 to 15 lb. of water are evaporated into steam from and at 212° F., per pound of oil. Assuming 15 lb., then

one horse power will be developed with 2.3 lb. of oil. The heat value of mineral oils and their products may be closely determined from their Beaumé gravity by the formula: B. t. u. per lb. =  $18650 + 40 (\text{Beaumé gravity} - 10)$ .

Per cent. of Total Steam Generated Used for Atomizing Oil in the Burners	Pounds of Steam for Atomizing Oil per Pound
1. ....	.15
1.5. ....	.225
2. ....	.30
2.5. ....	.375
3. ....	.45
3.5. ....	.525
4. ....	.60
4.5. ....	.675
5. ....	.75

Assume the average evaporation from and at 212° F. per pound of coal to be 7 lb., and for oil 15, then the ratio of evaporation is 7 to 15 and the pounds of oil equivalent to 2,000 lb. of coal will be  $7 : 15 = x : 2000$  or  $x = 933$  lb., which divided by 373 (assume the oil in a barrel weighs 373 lb.) equals 2.5 barrels of oil as being equivalent to one ton (2,000 lb.) of coal, or 2.8 barrels to one ton of 2,240 lb.

From one pound of crude oil there can be obtained from 1.6 to 1.7 times as many British thermal units as from a pound of coal. In other words, one pound of oil is equivalent to 1.6 lb. of coal. If 34 to 35 cu. ft. of oil weigh a ton (2,240 lb.), assuming that 42 cu. ft. of coal weighs the same amount, there is thus saved in stowage space with oil 15 to 20%. One ton of petroleum contains approximately 275 Imperial gallons or 360 U. S. gallons.

Air required for the complete combustion of fuel oil is about 200 cu. ft. per pound.

**Fuel Oils for Internal Combustion Engines.**—Crude oil is only for Diesel engines, as electrically ignited engines will not run on it, but will on distillate, gasoline, and kerosene. See Internal-Combustion Engines.

The Beaumé gravity is not always a true indication of the fuel value of the evaporation of an oil. The origin of the crude oil from which the fuel oil is obtained may also give rise to a variation in its gravity without affecting its ease in evaporation.

A practical test which shows at once the volatility of liquid fuel, is the determination of the limits of its boiling point, which consists in observing:

1. The initial boiling point.
2. Per cent. of volume distilling over at several intermediate temperatures.
3. The final boiling point.

Gasoline (in England called petrol and in France *essence*) is a colorless inflammable fluid, the first and highest distillant of crude petroleum. The specific gravity ranges from .58 to .90 compared with the unit one assumed for water at 60° F. For every 20° F. the specific gravity varies .01. Measured on the Beaumé scale higher specific gravities are denoted by lower numbers, and lower specific gravities by higher numbers without definite graduations.

Gasoline is not a simple chemical compound like water but a physical mixture of chemical compounds of carbon and hydrogen, each compound having different boiling points. In general, the higher the initial and final boiling points the more difficult will be the starting of an internal combustion engine on cold mornings, calling for the heating of the mixing chamber of the carbureter or the inlet air which passes to it.

**Lubricating Oil.**—The desirable characteristics are: (1) the oil should possess cohesion; (2) it should possess the maximum possible adhesion; (3) it should be as far as possible unchangeable; and (4) it should be commercially free from acid and be pure.

Tests have shown conclusively that no one grade however high its quality is suitable for all types of steam and internal combustion engines, because of the different surfaces to be lubricated and the systems employed in feeding the oil. Hence from the engine builder should be obtained information on the oil that is best suited for his engine.

In steam engines the amount of lubricating oil differs greatly, but from 5 to 8 lb. of oil per ton of coal may be taken as a fair average, or say from 5 to 8 lb. per 1,000 i. h. p. per hour. In small high speed engines as in torpedo boats the above amounts are exceeded.

Special oils are required for the cylinders of internal combustion engines on account of their high temperatures, ranging from 600° to 700° F. The oils must not only have good lubricating properties, but should not leave behind any carbon. A carbon deposit

and heavy exhaust smoke usually indicates that the oil is too light. The consumption of a light oil is much greater than a heavy. Under ordinary conditions the oil used for the bearings and for the cylinders should not exceed  $1\frac{1}{2}$  gallons per 1,000 i. h. p. in 24 hours.

The viscosity of an oil may be increased by a thickener as oleate of alumina, but although a thickener brings up the viscosity it does give the greasiness expected when a particular viscosity was specified.\* At ordinary temperatures, a very small quantity of oleate of alumina will considerably raise the viscosity of an oil.

If an oil is to lubricate a bearing, it must be fluid enough at the temperature of use to flow readily into the bearing. Hence it is customary to chill samples of oil and to determine the temperatures at which they become too thick to flow readily.

#### USES AND CHARACTERISTICS OF VARIOUS LUBRICATING OILS

Kind of Oil and Use	Gravity Beaumé	Flash Test Degrees F.	Fire Test Degrees F.	Viscosity at 70° F. (water = 1)
High pressure cylinder oils: for cylinders using dry steam from 110 to 210 lb.	25-24.5	600-610	645-660	175-205
General cylinder oil: for cylinders using dry steam from 75 to 100 lb. Also for air compressor cylinders when the oil is made from steam refined mineral stock and has a viscosity of 200.	26-25.5	550-585	600-630	180-190
Wet cylinder oil:† for cylinders using moist steam, especially in compound and triple expansion engines.	25.8-25.3	580-585	600-630	150-185
Gas engine cylinder oil†	26.5	320	350	300
Heavy engine and machinery oils: for heavy slides and bearings.	30.5-29.5	400	440-450	170-175
Wet service and marine oils‡	28	430	475	230

\* May contain 2 to 6% of refined acidless tallow oil in the high pressure oils and 6 to 12 in the low pressure.

† Neutral mineral oil compounded with soap. The soap will not decompose at high heat, and although not a lubricant serves as a vehicle for carrying some oil.

‡ May contain 30 to 40% of pure strained lard oil.

#### Notes on Lubricating Oil.\*

A mineral oil flashing below 300° F. is unsafe on account of causing fire.

A mineral oil evaporating more than 5% in 10 hours at 140° F. is inadmissible as the evaporation creates a viscous residue or leaves the bearing dry.

\* Notes from "Animal and Vegetable Fixed Oils and Waxes." C. R. A. Wright.

The most fluid oil that will remain in its place, fulfilling all other conditions, is the best for all light bearings at high speed.

The best oil is that which has the greatest adhesion to metallic surfaces and the least cohesion in its own particles, in this respect fine mineral oils are first, sperm oil second, neatsfoot oil third, and lard oil fourth.

Consequently the finest mineral oils are best for light bearings and high velocities.

The best animal oil to give body to fine mineral oils is sperm oil. Lard and neatsfoot oil may replace sperm oil when greater tenacity is required.

The best mineral oils should have the following properties:

Where Used	Specific Gravity at 60° F.	Evaporating Temperature Degrees F.	Flashing Temperature Degrees F.
Steam cylinders.....	.893	550	680
Heavy machinery.....	.880	443	518
Light bearings and high velocities.....	.871	424	505

Mineral oils alone are not suited for the heaviest machinery on account of want of body and high degree of inflammability.

Olive oil is foremost among vegetable oils as it can be purified without the use of mineral acids. The other vegetable oils admissible but far inferior, stated in their order of merit, are gingelly, groundnut, colza and cotton seed oils.

No oil is admissible which has been purified by means of mineral acids.

**Oil Burning Systems.**—When fuel oil has a flash point of not lower than 150° F. the oil bunkers may be on both sides of the boilers, or at the sides of the expansion trunk, or in tanks forward of the oil space. For oil having a lower flash point than 150° F. a different arrangement is required, the oil compartments being separated from the engine and boiler spaces by a cofferdam. When high flash oil is carried the fuel pumps for pumping the oil into the settling tanks and boilers are usually placed in the stokehold. When low flash, a special pump room is built in the boiler space abaft the cofferdam. This pump room is a watertight compartment, is tested by being filled with water to the top, and has no direct communication with the machinery space. It contains only the pumps and a ventilating fan (see Oil Carriers).

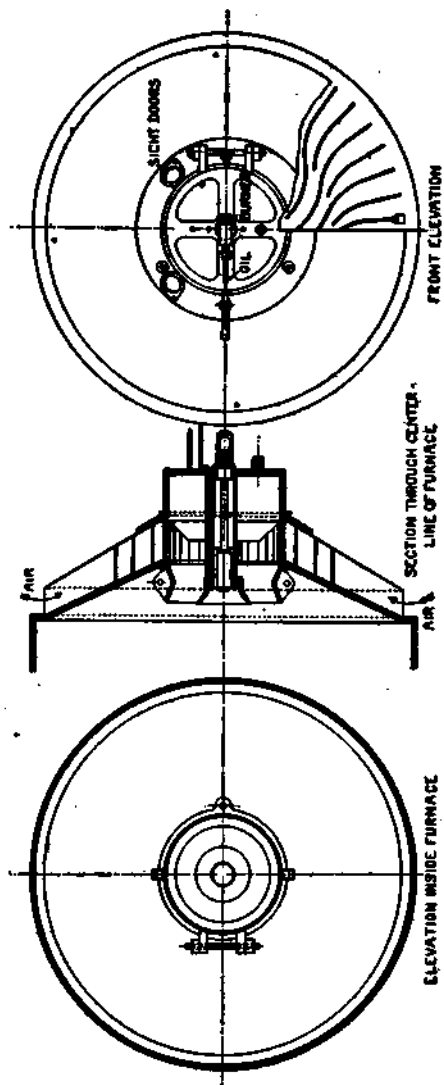

Figure 52.—Oil Burning Furnace (White Fuel Oil Engineering Co., New York).



The open system of piping to the oil burners, in which oil circulates all the time through the heater and burner pipes and back to the pump suction, is often preferable for marine installations to the dead end system in which the oil simply goes to the burners. The piping must be carefully erected, with no rubber gaskets or packings.

For the U. S. Naval Service the oil piping is seamless drawn steel, with flanges expanded on. The joints are scraped and made up metal to metal. Manila paper gaskets are allowed on suction pipes. Screwed fittings are used on connections under  $\frac{3}{4}$  in.

For merchant service extra heavy welded iron or steel pipe is used, with screwed joints and with extra heavy galvanized iron fittings. Flanges are screwed on the pipes and manila paper or cardboard is used for gaskets or special oilproof packing. Copper piping is not used, but brass and composition fittings and valves may be used.

The suction piping should be large, the practice at Newport News Shipbuilding Co., Newport News, Va., for the velocity of Mexican oil through suction pipes is not over 20 ft. per minute, the oil being heated to reduce the viscosity to about 30° Engler. For discharge pipe lines 100 ft. per minute is allowable in small pipes, the viscosity being reduced to 15° Engler or lower. It is dangerous to use a fuel oil which, to reduce its viscosity sufficiently for mechanical atomization, has to be heated beyond its flash point.

Below are brief descriptions of the Koerting, White, and Kermode oil burning systems. In the Koerting, the oil is atomized by mechanical action, it being forced by pumps through superheaters to the burners. On the way from the superheaters to the burners, the oil which is under high pressure and of the required temperature is strained. After straining it goes to burners which are fastened to adjustable air registers provided with air admission slides to regulate the air supply so as to secure a proper mixture of air and oil.

The oil leaves the burners perfectly atomized and the air for combustion is carried to the atomized oil by the air registers that are so constructed as to cause the air to form an intimate mixture with the oil, thereby securing complete combustion. The Koerting system is placed on the market by Schutte and Koerting, Philadelphia, Penn.

In the White system (see Fig. 52) the burner is designed to break up or atomize the oil as fine as possible. This is accomplished by driving

the oil along a number of flutes or passages on a cone, and without retarding its velocity impinging it on a fine-angled cone, delivering it from the orifice in a spray at a pressure of 60 lb. which can be reduced to 10, the spray being still fine enough to flame. The flame burns at about one inch from the burner due to the perfect mixture with the air, and complete combustion is obtained. The White system is installed by the White Fuel Oil Engineering Co., New York.

In the **Kermode system** there are three different types: (1) the pressure jet where the oil is atomized by pressure—with this type neither steam nor air is required to disintegrate the oil, it being effected by pressure that is brought to bear upon the oil fuel itself by means of a force pump; (2) the oil is atomized by air pressure; and (3) the oil is atomized by steam pressure. Before the oil reaches the burners it is heated and filtered. The use of compressed air in place of steam is more economical and generally hot air is to be preferred when the best results are desired. The Kermode system was brought out by Kermode's Ltd., Liverpool, Eng.

### BOILERS

There are **two types** of boilers, one where the fire goes through the tubes (fire tube boiler) and the other where the water does (water tube boiler). Of the former the most common is the Scotch boiler shown in Fig. 53. Their usual proportions are as follows:

Sectional area of tubes  $\frac{1}{4}$  to  $\frac{1}{2}$  the grate surface.

Volume of combustion chamber 3 to 4 cu. ft. per square foot of grate surface.

Grate surface 10 to 15 sq. ft. per i. h. p.

Heating surface 2 to 15 sq. ft. per i. h. p.

Ratio of heating surface to grate varies from 16 to 30.

Steam volume .3 to .4 cu. ft. per i. h. p.

Coal burned 15 to 35 lb. per square foot of grate surface per hour, or  $\frac{1}{2}$  to 1 lb. per square foot of heating surface per hour.

Water evaporated 6 to 10 lb. per pound of coal, or 4 to 10 lb. per square foot of heating surface per hour.

Sectional area of funnel  $\frac{1}{4}$  to  $\frac{1}{2}$  grate surface.

Scotch boilers may be built in 2,000 h. p. units or even larger.

For weights, see page 000.

A good boiler working under favorable conditions will absorb 85% of the heat generated by the fuel, but 75% is the usual average.

Data from Prac. Marine Engineering.

## SCOTCH BOILERS

	Board of Trade	Lloyd's	Ad- miralty	Lloyd's
Diameter, mean.....	16' 4"	16' 2"	16' 3"	15' 6"
Length over end plates.....	17' 6"	11' 0"	10' 9"	11' 0"
Working pressure, lb.....	180	220	190	215
Rules on which designed.....	Board of Trade	Lloyd's	Ad- miralty	Lloyd's
Number of furnaces.....	8	4	4	3
Diameter of furnaces, external.....	42½	45½	46¾	49¼
Thickness of furnaces.....	¾	¾	¾	¾
Number of combustion chambers.....	4	4	5	3
Number of tubes.....	840	438	578	396
Diameter of tubes.....	2¾	2¾	2¾	2¾
Length of tubes.....	6' 11"	7' 8"	7' 5½"	7' 2¼"
Surface of tubes, sq. ft.....	4,170	2,417	2,820	2,044
Total heating surface, sq. ft.....	5,031	2,961	3,287	2,508
Grate area, sq. ft.....	160	90	94.2	.....
Thickness of shell, ins.....	1½	1¾	1¾	1¾
Diameter of shell rivets.....	1½	1½	1½	1½
Pitch of shell rivets.....	10"	10"	10"	10"
Tensile test of shell plate.....	26	31-34	28-31	29-32
Thickness of top end plates.....	1½	1½	1½	1½
Thickness of front tube plates.....	¾	¾	¾	¾
Thickness of back plates.....	¾	¾	¾	¾
Thickness of combustion chamber.....	¾	¾	¾	¾
Weight as finished in tons.....	78.5	57.0	52.0	53.0
Weight per 100 sq. ft. total heating surface in tons.....	1.56	1.928	1.582	2.115

From Marine Eng'g Estimates. C. R. Bruce.

The combustion chamber of a Scotch boiler should have a water space of at least 5 ins. between it and the end of the boiler. The space should be wider at the top than at the bottom, the chamber having a slope of about ½ in. per foot of depth. Measured horizontally they should be as deep as possible, 28 and 36 ins. seem to be the smallest limits for single- and double-ended boilers respectively. The depth is about 12 ins. greater than one-half the furnace diameter for single-end boilers, and for double-end it is about 24 ins. greater.

In boilers with two furnaces the ratio of boiler diameter to furnace diameter is approximately as 10 to 3. Custom is equally divided as to leading the two furnaces into two combustion chambers or into one. In estimating the heating surface of a corrugated furnace assume it as a plain cylindrical furnace whose diameter is the mean diameter of the corrugations. For boilers with three furnaces, the ratio of boiler diameter to furnace is as 4 to 1. Usually three combustion chambers are fitted. For boilers with four furnaces the ratio of boiler diameter to furnace is as 5 to 1. Combustion chambers are generally arranged so that the two central furnaces are led into one, and the two wing into separate chambers so there would be one large and two small combustion chambers.

**Boiler Data.**

Dia. inside 16'-0"

Length 10'-5"

Pressure 160 lbs.

4 Furnaces 9'-3" dia. x 7'-0" long.

542 plain tubes 2 1/2" dia. No. 11 B. W. G.

184 stay tubes 2 1/2" dia. No. 6 B. W. G.

Heating surface tubes 2372.8 sq. ft.

Furnaces 188.5 "

Combustion chambers 226.3 "

Total 2768 "

Grate surface 88 sq. ft.

Ratio H.S. to G.S. 31.4

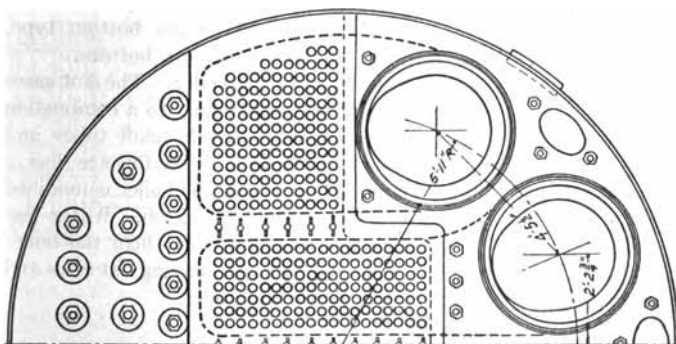
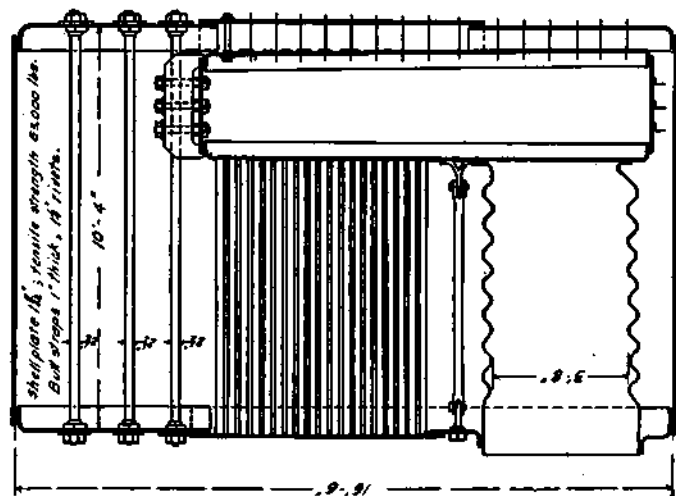

Figure 53.—Scotch Boiler.

**Particulars of Single Ended Scotch Boilers**  
Natural Draft

Mean Internal Diameter	Mean Length	Mean Internal Diameter of Furnaces	Width of Combustion Chamber	Tubes			Heating Surface	Length of Fire Bars	Grate Area
				Number	Dia.	Length			
13' 6"	10' 3"	3' 2"	2' 5 $\frac{1}{4}$ "	198	3 $\frac{1}{2}$ "	7' 0"	1608	5' 9"	54.6
14' 0"	10' 6"	3' 4"	2' 6"	204	3 $\frac{1}{2}$ "	7' 2"	1604	6' 0"	60.0
14' 6"	10' 6"	3' 6"	2' 6"	238	3 $\frac{1}{2}$ "	7' 2"	1949	6' 0"	63.0
15' 0"	10' 9"	3' 8"	2' 7 $\frac{1}{4}$ "	254	3 $\frac{1}{2}$ "	7' 3"	2100	6' 0"	66.0
15' 6"	11' 0"	3' 9 $\frac{1}{4}$ "	2' 9"	268	3 $\frac{1}{2}$ "	7' 4"	2234	6' 0"	68.2
16' 0"	11' 0"	3' 11"	2' 9"	280	3 $\frac{1}{2}$ "	7' 4"	2331	6' 0"	70.5
16' 6"	11' 3"	4' 1"	2' 10"	284	3 $\frac{1}{2}$ "	7' 6"	2425	6' 0"	73.5

**Forced Draft**

13' 6"	11' 0"	3' 2"	2' 5 $\frac{1}{4}$ "	322	2 $\frac{1}{2}$ "	7' 9"	1986	5' 0"	47.4
14' 0"	11' 0"	3' 4"	2' 6"	345	2 $\frac{1}{2}$ "	7' 8"	2098	5' 0"	50.0
14' 6"	11' 3"	3' 6"	2' 7"	386	2 $\frac{1}{2}$ "	7' 10"	2290	5' 3"	52.5
15' 0"	11' 6"	3' 8"	2' 7 $\frac{1}{4}$ "	407	2 $\frac{1}{2}$ "	8' 0"	2560	5' 3"	55.0
15' 6"	11' 9"	3' 9 $\frac{1}{4}$ "	2' 9"	425	2 $\frac{1}{2}$ "	8' 3"	2749	5' 3"	56.87
16' 0"	12' 0"	3' 11"	2' 9"	482	2 $\frac{1}{2}$ "	8' 4"	3111	5' 6"	58.75
16' 6"	12' 3"	4' 1"	2' 10 $\frac{1}{4}$ "	510	2 $\frac{1}{2}$ "	8' 6"	3352	5' 6"	61.25

Note. The boilers in the above list are fitted with three of Morison's withdrawable furnaces, each leading into a separate fire box. The center line of the top row of tubes is about one third of the boiler diameter from the top, which represents good practice for pressures from 140 to 190 lbs. For higher pressures, the steam space may be reduced, and the heating surface increased. (Above table from Marine Eng'g Estimates, C. R. Bruce.)

The locomotive type is shown in Fig. 54. Here the furnace is of a rectangular cross section, and is surrounded by the shell at the front, leaving on the sides a narrow space known as the water leg. When so constructed that there is a space at the bottom below the firebox, the boiler is known as the wet bottom type, and where there is no space, as in Fig. 54, the dry bottom.

Fig. 55 is of a flue and return tube or leg boiler. The hot gases pass from the furnace through large tubes or flues to a combustion chamber at the farther end, returning through small tubes and thence through the uptake to the funnel. The furnace has a rectangular cross section, and the front end of the boiler is modified on the sides and bottom to correspond to this form. Water legs are formed on the sides of the furnaces and from them the boiler gets its name. When built with the front end having flat sides and a rounded top it is known as a wagon top boiler.

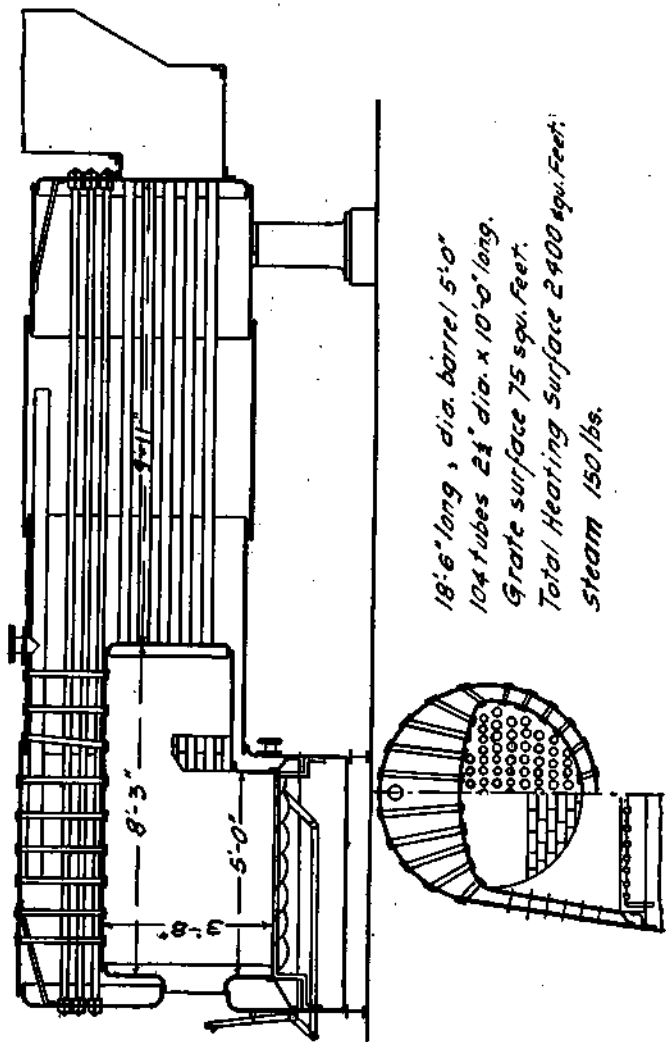

Figure 54.—Locomotive Boiler.

Locomotive and leg boilers are installed in shallow draft vessels, such as excursion steamers, where a Scotch boiler on account of its large diameter would seriously interfere with the arrangement of the decks.

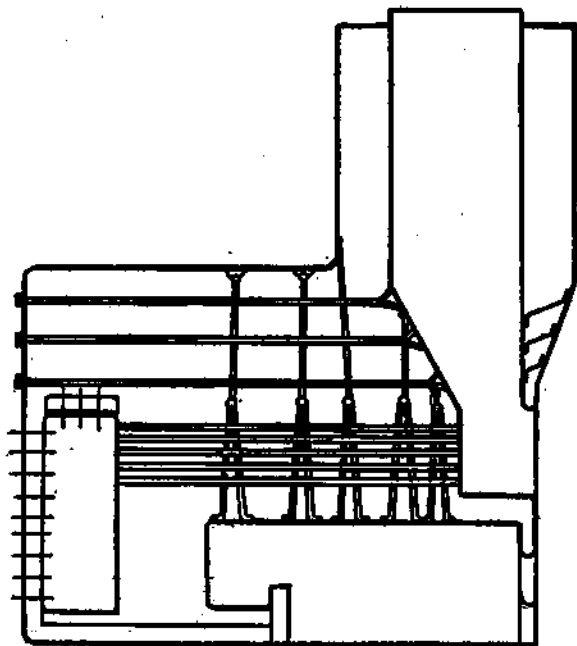

Figure 55.—Leg Boiler.

From *Prac. Marine Engineering*.

**Water-Tube Boilers.**—Here the grate lies below the tubes and frequently between the lower drums, while the tubes and drums are surrounded by a casing to prevent as far as possible the loss of heat by radiation.

The feed water enters the upper drum, then flows down certain of the tubes to the lower drums from which the water enters the upflow or steam forming tubes that are surrounded by the hot gases from the grates. During the passage of the water upward it is partly converted into steam, and the mixture of steam and water issues from the upper ends of the tubes into the drum. Here the steam is separated and enters the piping to the engine or tur-

bine, while the water mixes with that already in the drum and begins on another round.

The Yarrow has straight tubes, while the Thornycroft, Normand and White-Forster have curved tubes. In the latter there is a center and side drums (see Fig. 56), the tubes being curved to a standard radius and are interchangeable. Thus spare tubes can be carried in straight lengths and may be bent and cut as desired. The Yarrow, Thornycroft, Normand, and White-Forster boilers belong to the small tube type and have been installed in a large number of torpedo boats, destroyers, and other high speed steam vessels.

Of the large-tube water-tube boilers the Babcock and Wilcox (see Fig. 57) is well known. The tubes forming the heating surface are divided into vertical sections and to insure a continuous circulation in one direction are placed at an inclination of  $15^{\circ}$  with the horizontal. Extending across the front of the boiler and connected to the upper ends of the headers by 4-inch tubes is a horizontal steam and water drum. As the upper ends of the rear headers are also connected to this drum by horizontal 4-inch tubes each

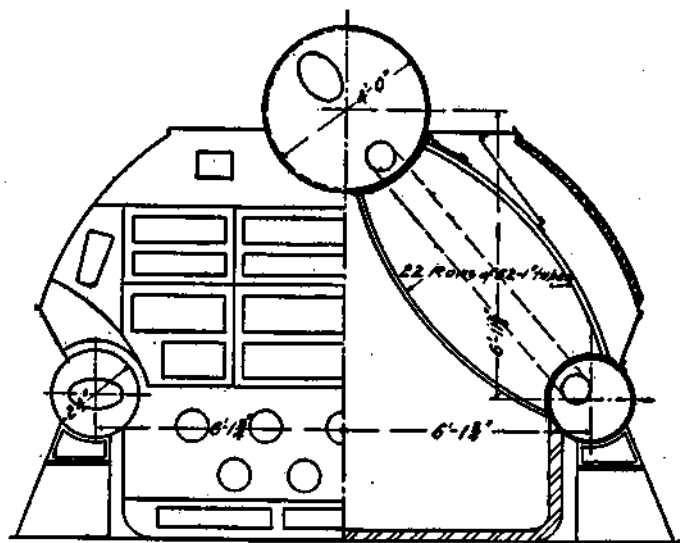

Figure 56.—White-Foster Water-Tube Boiler.



section is provided with an entirely independent inlet and outlet for water and steam. Placed across the bottom of the front header and connected thereto by similar 4-inch tubes is a forged steel box with a 6-inch square section. The box situated at the lowest corner of the bank of tubes forms a blow-off connection or mud drum through which the boiler may be completely drained. The distance traveled by the products of combustion in contact with the heating surface is about 16 ft.

The weight of Babcock and Wilcox boilers including water, as built for naval vessels and mail steamers, for 250 lb. pressure is about 25 lb. per square foot of heating surface.

WEIGHT, AND SPACE OCCUPIED BY VARIOUS MAKES OF WATER-TUBE BOILERS

Make	Name of Steamer	Length	Width	Height	Floor Space, Sq. Ft.	Outside Dia. of Tubes	Heating Surface, Sq. Ft.	Weight of Boiler and Water per Sq. Ft. Heating Surface in Lb.
Babcock and Wilcox.....	U. S. Battleship <i>Utah</i> .....	9' 13"	18' 4 1/2"	13' 11 1/2"	167.68	2" & 4"	5,359	*23.79
Babcock and Wilcox.....	U. S. Battleship <i>New Hampshire</i> .....	10' 1"	14' 10 1/2"	13' 2 1/2"	149.98	2" & 4"	3,926	*25.80
Normand.....	U. S. Torpedo Boat Destroyer <i>Trippe</i> .....	12' 6"	15' 1 1/2"	14' 2"	188.60	1" & 1 1/2"	4,780	†12.40
Thornycroft..	U. S. Torpedo Boat Destroyer <i>Terry</i> .....	10' 9 1/2"	15' 2 1/2"	12' 1 1/2"	164.30	1 1/2" & 1 1/2"	4,500	†12.20
White-Forster	Torpedo Boat Destroyer <i>Maryland</i> .....	9' 0 1/2"	14' 8 1/2"	12' 8"	133.30	1" & 1 1/2"	4,500	†12.10
Yarrow.....	Torpedo Boat Destroyer <i>Sterrett</i> .....	12' 9"	14' 2 1/2"	12' 10"	181.00	1" & 1 1/2"	4,500	†12.50

\* Includes grates—coal burning. From Steam, Babcock & Wilcox Co.

† Oil burning—no grates.

Comparison of Fire-Tube and Water-Tube Boilers.—Fire-tube boilers take longer to get up steam. For example, Scotch boilers require between five and six hours to raise steam after the fires are started, whereas water-tube require from 30 to 60 minutes. Then again fire-tube boilers are heavier than water-tube (see Weights).

Water-tube boilers can stand forcing, are suitable for high steam pressures, and can raise steam quickly. Their disadvantages are: a more rigid restriction of the feed to fresh water; the necessity of a greater regularity of feed; greater difficulty in dealing with leaky tubes; general sensitiveness to variation in the conditions of use; and perhaps they are not so durable or so efficient as Scotch boilers when on long voyages. Their maximum size is about 1,000 h. p., while Scotch have been built to about 2,000. The above applies particularly to small water-tube boilers. Large-tube, as the Babcock and Wilcox, have many of the advantages of Scotch boilers, with the additional advantage of being able to raise steam much quicker, which is of the greatest importance in warships.

**Boiler Horse Power.**—The evaporation of 34.5 lb. of water per hour from a feed water temperature of 212° F. into steam at the same temperature is a standard commercial boiler horse power and is considered as equivalent to the evaporation of 30 lb. of water per hour from a feed water temperature of 100° F. into steam at 70 lb. pressure.

For finding the approximate boiler horse power in water-tube boilers divide the total heating surface in square feet by 10. In ordinary Scotch or leg boilers, multiply the area of the grate surface in square feet by 3, or divide the number of tons of coal burned per hour by 3½. The results from the above formulæ express the evaporative capacity of a boiler in horse power based on the evaporation of 30 lb. of water per horse power per hour.

**To Find the Boiler Horse Power Required for an Engine.**

- Let *i. h. p.* = indicated horse power of the engine  
*B. H. P.* = boiler horse power required  
*s* = water rate or steam consumption in pounds per i. h. p. per hour  
*c* = ratio of steam required for the auxiliary apparatus, such as feed pumps, etc., and may be taken as 1.08 for condensing engines and 1.02 for non-condensing

$$\text{Then } B. H. P. = \frac{i. h. p. \times s \times c}{34.5}$$

*Example.* Find the boiler horse power required to supply steam to a 600 h. p. compound condensing engine.

From the table of steam consumption (see section on engines) 15 lb. of steam are consumed per i. h. p.

Using the above formula

$$B. H. P. = \frac{i. h. p. \times s \times c}{34.5} = \frac{600 \times 15 \times 1.08}{34.5} = 281.$$

The following is another example:

*Example.* Find the size of boiler required for a fore and aft compound engine with cylinders 10 and 20 ins. diameter by 14 ins. stroke, cutting off at  $10\frac{1}{4}$ -inch stroke, working pressure of boiler, 160 to 165 lb., piston speed, 600 ft. per minute.

First determine the probable indicated horse power of the engine. The general formula for mean effective pressure (MEP) (theoretical) is:

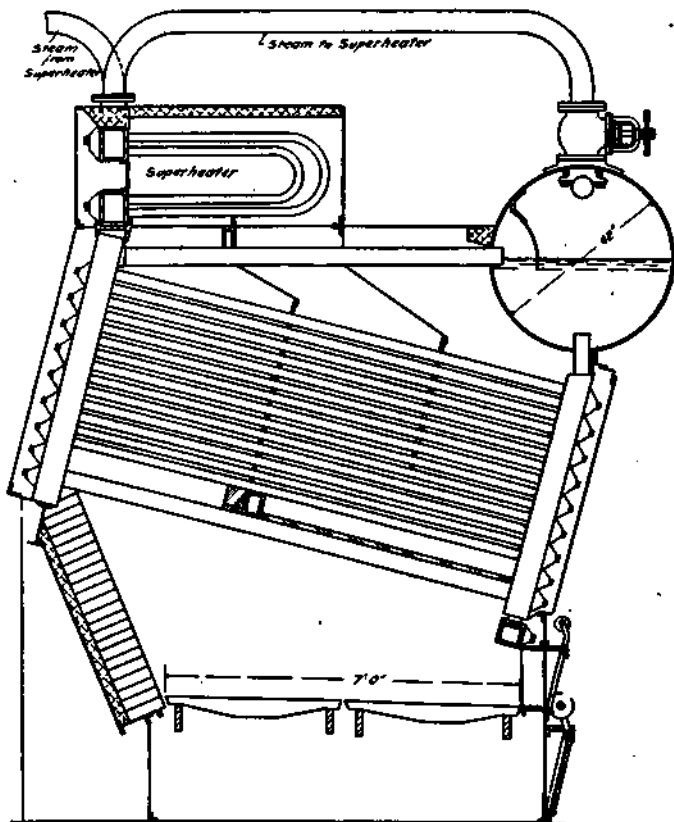

Figure 57.—Babcock and Wilcox Water-Tube Boiler.

$$MEP = p_1 \frac{1}{n} (1 + \log_e n) - p_2$$

where  $p_1$  = boiler pressure  
 $n$  = number of expansions  
 $p_2$  = back pressure

if  $p_1$  = 160 lb. per sq. in. (boiler pressure)

$$n = \frac{10 \times 10 \times \pi \times 14}{5 \times 5 \times \pi \times 10.5} = 5.33$$

and  $p_2$  = 4 lb. per square inch (assumed).

$$\begin{aligned} \text{then } MEP &= 160 \times \frac{1}{5.33} (1 + \log_e 5.33) - 4 \\ &= 160 \times \frac{1}{5.33} (1 + 1.6734) - 4 \\ &= 80.2 - 4 = 76.2 \text{ lb. per square inch.} \end{aligned}$$

The ratio of theoretical mean effective pressure to probable mean effective pressure is about .55 for the above type of engine, so that

$$\begin{aligned} \text{i. a. p.} &= \frac{MEP \times \text{piston speed} \times \text{area lower pressure cylinder}}{33,000} \\ &= \frac{41.9 \times 600 \times 314.}{33,000} = 239 \end{aligned}$$

A steam consumption including auxiliaries of 25 lb. per h. p. hour is reasonable for this type of engine used  $\left(\frac{10 \times 20}{14}\right)$  and gives  $239 \times 25 = 5,975$  lb. per hour approximately, as the evaporation of the boiler. The equivalent evaporation from and at 212° is

$$\begin{aligned} \frac{\text{Heat contents at 165 lb.} \times 6,000}{\text{Heat contents at 212°}} &= \frac{1,196 \times 6,000}{1,150} = 6,200 \text{ lb. approximately} \\ \text{Boiler horse power} &= \frac{6,200}{34.5} = 180. \end{aligned}$$

For Scotch boilers about 7 lb. of steam per square foot of total heating surface is as much as should be counted on, which would give  $\frac{6000}{7} = 857$  sq. ft., and allowing 35 sq. ft. of heating surface

per 1 sq. ft. grate, the grate area is  $\frac{857}{35} = 24.5$  sq. ft. Therefore, a Scotch boiler for the given conditions should have about 860 sq. ft. of heating surface and 24.5 sq. ft. of grate area. If forced draft is used it is probable that the horse power per square foot of grate area would be about 15, which would give a much smaller boiler.

In designing large boiler plants it is generally considered sufficient to provide boiler horse power equal to one-half the indicated horse power of the engine.

**Factor of Evaporation** for any given feed water temperature

and boiler pressure is calculated by dividing the total heat above 32° F. in one pound of steam at the given pressure minus the total heat in one pound of the feed water above 32, by the latent heat of steam at 212° which is 970.4 B. t. u.

*Example.* A boiler evaporates 5,000 lb. of water at 77° F. into steam at 91.3 lb. gauge pressure every hour. What is the boiler horse power?

From the steam table, steam at 91.3 lb. gauge pressure contains 1,187.2 B. t. u. per lb. above 32°.

Water at 77° contains  $77 - 32 = 45$  B. t. u. per lb. above 32°.

Then the factor of evaporation =  $\frac{1,187.2 - 45}{970.4} = 1.177$

5,000 lb. of feed water per hour multiplied by 1.177 = 5,885 lb. of water which would have been evaporated into steam with the same heat used to evaporate 5,000 lb. from 77° into steam at 91.3 lb. if the feed water temperature had been 212° and the boiler pressure 0 lb. The equivalent evaporation from and at 212° is 5,885 lb., and divided by 34.5 lb. gives 170.6 as the b. h. p. (From Oil Fuel).

**Boiler Efficiency** is the ratio of the heat actually transmitted to the water in the boiler to the total heat developed by the combustion of the fuel. This is determined by the quantity of feed water fed to the boiler, amount of coal burned, steam pressure in boiler, and temperature of feed water.

*Example.* In a boiler, 864 lb. of coal were burned per hour, the feed water entering the boiler 8,350 lb. per hour, temperature of feed water 100° F., and the steam was blown into the atmosphere at 275 lb. per square inch. Find the efficiency of the boiler.

The calorific value of the coal used was 15,120 B. t. u.

Total heat per pound of dry saturated steam at 275 lb.; calculated from feed water at 32° is 1,208.3 B. t. u.

The heat added per pound of feed water leaving the boiler as dry steam at 275 lb. =  $1,208.3 - (100° - 32°) = 1,140.3$  B. t. u.

Hence the heat carried away by 8,350 lb. of steam is  $1,140.3 \times 8,350 = 9,521,505$ .

The heat from combustion if 864 lb. of coal is burned is  $864 \times 15,120 = 13,063,680$  B. t. u.

Then the boiler efficiency is  $\frac{9,521,505}{13,063,680} = .73$  nearly.

The following is another example. Find the efficiency of a boiler when the evaporation from and at 212° is 7 lb. of water per 1 lb. of coal containing 12,000 B. t. u. per pound.

$7 \times 970.4$  (latent heat of steam) = 6,793 B. t. u. imparted to the water per one pound of coal.

Then  $\frac{6,793}{12,000} = .56$  or 56% efficiency.

Efficiency of small tube water tube boilers....	58%
Efficiency of large tube water tube boilers....	63 to 70%
Efficiency of Scotch boilers.....	68 to 80%

Approximate distribution of heat in a Scotch boiler burning 20 lb. of coal per square foot of grate surface, the heating surface being 30 times the grate, is as follows:

Absorbed by feed water.....	68%
Wasted in funnel gases.....	24
Wasted in unburned carbon in ashes.....	2
Wasted by radiation, etc.....	6
Total.....	100%

The heat absorbed by the feed water, viz., 68%, represents the efficiency of the boiler.

Boiler Weights, Scotch and water-tube, see Machinery Weights.

#### GALLONS OF WATER EVAPORATED PER MINUTE IN BOILERS

Based on 30 lb. or 34½ lb. per horse power. To find the gallons per minute multiply boiler horse power by .069 when evaporation is 34.5 lb. per hour and .06 when evaporation is 30 lb. per hour.

H. p. of Boiler	Gallons per Minute at 30 lb. per H. p.	Gallons per Minute at 34.5 lb. per H. p.	H. p. of Boiler	Gallons per Minute at 30 lb. per H. p.	Gallons per Minute at 34.5 lb. per H. p.
25	1.5	1.725	300	18.0	20.7
50	3.0	3.45	325	19.5	22.4
55	3.3	3.79	350	21.0	24.15
60	3.6	4.14	375	22.5	25.87
65	3.9	4.48	400	24.0	27.6
70	4.2	4.83	450	27.0	31.0
75	4.5	5.17	500	30.0	34.5
80	4.8	5.52	550	33.0	37.7
85	5.1	5.86	600	36.0	41.4
90	5.4	6.21	650	39.0	44.8
95	5.7	6.55	700	42.0	48.3
100	6.0	6.9	750	45.0	51.75
110	6.6	7.59	800	48.0	55.2
120	7.2	8.28	850	51.0	58.6
125	7.5	8.625	900	54.0	62.1
130	7.8	8.97	950	57.0	65.5
140	8.4	9.66	1000	60.0	69.0
150	9.0	10.35	1100	66.0	75.9
160	9.6	11.04	1200	72.0	82.8
170	10.2	11.75	1300	78.0	89.7
175	10.5	12.075	1400	84.0	96.6
180	10.8	12.42	1500	90.0	103.5
190	11.4	13.11	1600	96.0	110.4
200	12.0	13.8	1700	102.0	117.3
225	13.5	15.52	1800	108.0	124.2
250	15.0	17.25	1900	114.0	131.1
275	16.5	18.97	2000	120.0	138.0

## BOILER FITTINGS AND ACCESSORIES

Fitting	Location on Boiler
Main stop valve.....	On top
Auxiliary stop valve.....	On top
Steam to whistle.....	On top
Safety valve.....	On top
Gauge glass connections.....	End or side
Scum cock.....	End " "
Auxiliary feed check valve.....	End " "
Main feed check valve.....	End " "
Test cocks.....	End " "
Salinometer cock.....	End " "
Blow down cock.....	Bottom
Drain cock.....	Bottom

**Safety Valve.**—To provide for the escape of the steam should the pressure in the boiler rise above the safe working limit for which the valve is set. The valve must be direct connected to the boiler without any intermediate valves or pipe bends.

Where  $A$  = area of safety valve in square inches, per square foot of grate surface.

$W$  = pounds of water evaporated per square foot of grate surface per hour.

$P$  = absolute pressure per square inch = working gauge + 15.

The size for U. S. Steamboat-Inspection Service is determined by the formula  $A = .2074 \times \frac{W}{P}$ .

Whenever the area as found by the above formula is greater than that corresponding to  $4\frac{1}{2}$  ins. diameter, two or more safety valves, the combined area of which shall be equal at least to the area required, shall be used. This calls for a single Y fitting to the boiler with two valves, or to a twin valve. See Fig. 58.

There are two types of safety valves: (1) where the steam acts on the area of the valve when closed; and (2) where the valve disk has an additional area not exposed to the steam when the valve is closed, but acted upon by the pressure of the steam when the valve opens. The former usually has a lever and weight, while the latter is spring operated and is known as a pop safety valve. Pop safety valves are extensively used in the marine field; an example is the Ashton (Ashton Valve Co., Boston, Mass.), as shown in Fig. 58. Ashton valves have a patent blow-back head forming

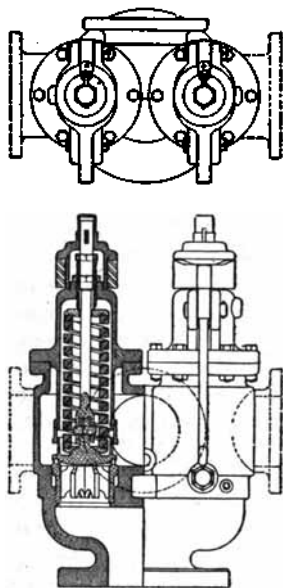

Figure 58.—Pop Safety Valve (Ashton Valve Co., Boston, Mass.)

a chamber inclosing the spring and protecting it from the steam. The spring chamber is vented at the top, thus the discharge from a number of valves may be piped together, and yet a valve will not be loaded with back pressure. If desired the pipe from the valve or valves may run down the inside of the hull to below the water line, thus giving a noiseless discharge.

**Stop Valve.**—This valve is in the pipe leading from the boiler to the main steam line to the engines, and thus controls the supply of steam from the boiler. In warships and often in merchant ships the stop-valve is a non-return valve, and is self-closing, for should the boiler be ruptured, the valve by closing would stop a sudden rush of steam from the other boilers.

**Feed Water Connections for a Scotch Boiler.**—Feed water heaters are installed in all first class vessels, and the feed water enters the boiler at about 200° F. The customary practice is to discharge



the water above the tubes just below the water level in the boiler, through two or more branches led over the tubes with the ends closed and the sides perforated with small holes, the combined area to be  $1\frac{1}{2}$  times the area of the feed pipe. In no case should the discharge terminate above the water level in the steam space, for the reason that it would produce excessive priming and also air hammer in the feed lines. Quantities of air pass into the boiler with the water at all times, which produces a certain amount of hammer in the line, and to overcome this an air chamber of ample capacity should be placed on the discharge side of the feed pump or in some convenient place in the feed line.

The U. S. Steamboat-Inspection Rules require all boilers to have two feed connections, viz., main and auxiliary. Sometimes the auxiliary is connected only with the injectors and is seldom used except for supplying the boilers sufficiently to keep the auxiliary machinery running when the main units are shut down. The auxiliary discharge should be placed above the furnaces, preferably about halfway to the top row of tubes.

**Feed Check Valve.**—The water from the feed pump goes to the boiler through the feed pipe, and at the boiler passes through the feed check valve, which is a screw-down, non-return valve, and enters the internal feed pipe (see above). A stop valve is always placed between the check valve and the boiler, so if necessary for examination or repair the check valve may be shut off from communication with the boiler. In water tube boilers the feed water enters the upper drum.

**Surface and Bottom Blows.**—Cocks or valves and connecting pipes leading overboard are fitted for blowing the grease scum and mud sediment out of the boiler. The cross-sectional area of the bottom blow may be so proportioned as to give one square inch for every 5 tons of water contained in the boiler, with a larger area for small boilers. The area for the surface blow is the same as the bottom blow.

**Steam Gauges.**—The steam pressure within the boiler, or rather the excess of pressure within over the atmospheric pressure, is shown by a gauge, which is generally of the type using a Bourdon tube. Steam does not enter the gauge nor does it come in contact with any of the working parts. The tube from the boiler is bent in a loop or U, which serves as a trap for the water condensed beyond this point. Thus the Bourdon tube and part of the connecting pipe are kept filled with water, which in turn is acted on

by the steam, and the pressure is indicated without the actual presence of steam within the gauge.

**Water Gauge and Cocks.**—The level of the water is shown by a vertical glass tube, the upper end being connected to the steam space and the lower to the water. The glass should be adjusted so that when the water is at the bottom, the water in the boiler is still 3 or 4 ins. above the level of the highest heating surface. Besides the gauge glass, small cocks are provided which, on opening, indicate the water level in the boiler.

**Boiler Circulators.**—To improve the circulation of the water—particularly in Scotch boilers—circulators are installed. Of the types on the market the Ross-Schofield and the Eckliff are worth noting. The former consists of steel plates fastened to the outside of the combustion chamber and extending to the back plate of the boiler. By means of these plates and hoods the direction of the current set up by the heating of the water and the motion imparted by the steam bubbles from the point of formation to the surface of the water are directed into a channel, and a longitudinal and elliptical flow of water takes place and is maintained as long as heat is being transmitted to the water.

The Eckliff circulator is quite different. It consists of specially formed and constructed tubes bent to conform to the curved surfaces of the furnaces. These tubes run vertically from the bottom of the boiler to the tops of the furnaces, and then horizontally along the tops, being in contact with the entire length of the furnace except for one foot at each end, where the tube is bent upward at an angle which causes the water to discharge directly against the tube sheet just above the furnace. The playing of the water against the plates prevents the cracking of the furnace flange or the combustion chamber plate at the point where the two are riveted together.

Another device often installed is a hydrokineter. This comprises a steam jet and series of nozzles, and is placed near the bottom of the boiler, thus driving upwards the cold water that collects there and causing it to circulate. The steam required for its use is furnished by another boiler.

**Fusible Plugs.**—Every boiler other than those of the water tube type shall be fitted with at least two fusible plugs. They must be so installed that the end of the banca tin on the water end of the plug is not less than one inch above the dangerous low water level. (See U. S. Steamboat-Inspection Rules.)

**Injectors and Inspirators** are for feeding water to the boiler both operating on practically the same principle, viz., the energy of the steam in a relatively large pipe is concentrated on a small jet of water, giving it a high velocity and pressure that is sufficient to overcome the boiler pressure, to open the check valves and to force the water into the boiler.

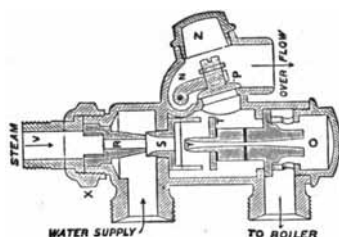

Figure 59.—Injector (Penberthy Injector Co., Detroit, Mich.).

An inspirator differs from an injector in the fact that it has two tubes, one for lifting the water and the other for forcing it into the boiler. An inspirator handling cold water with a short lift, will work through a range of over 200 lb., while with water at 100° F., and a small lift, it will work through a range of from 150 to 200 lb.

The capacity of an injector should be about 30% in excess of the maximum requirement of the boiler. A boiler horse power is the evaporation of 30 lb. of water per hour, adding 30% to this; then the required injector capacity would be about 40 lb. or 5 gallons per hour for each boiler horse power. By multiplying the number of boiler horse power by 40 lb. or 5 gallons, the capacity of the injector in pounds or gallons is obtained. When the boiler horse power is not known it can be approximated. See paragraph on boiler horse power.

With cold water and a moderate lift, say not exceeding 6 or 8-ft., a good automatic injector will start up with 25 or 30 lb. steam pressure, and will work with little or no further adjustment over a range of perhaps 100 lb. pressure. With feed water at about 100° the same injector would start at 30 or 35 lb. and would work up to about 100 lb.

Working on the same principle as boiler injectors are bilge ejectors which are used in drainage systems, see page 611.

**Hydrometer.**—The density of water can be determined by an instrument known as a hydrometer. This instrument is placed in the water to be tested and the distance it sinks noted, and readings made from a scale on the side. Average sea water contains about one part in 32 of solid matter, and hydrometers are usually graduated relative to this as a unit. That is, 2 on the scale indicates twice as much solid matter relatively as sea water; 3, three times as much and so on; while 0 indicates fresh water. The density of the water depends on its temperature so that the scale on the hydrometer can only be used with the temperature that it is graded with, which is usually 200° F. Sometimes three scales are provided, viz., 190°, 200° and 210°. The water is drawn from the boiler into a slender vessel called a salinometer pot, into which after the water has cooled to the temperature (190°, 200°, etc.) on the scale of the hydrometer, the hydrometer is placed in it, and the density of the water determined.

**Superheaters** may be classed: (1) separately fired, i. e., those using the hot gases from a source other than the furnaces of the main boilers; (2) those utilizing the gases from the boiler on their way to the stack; and (3) those utilizing the gases which have not left the main boiler evaporating surface. The two latter are more popular than the first.

The above classes may be divided structurally into the tubular, which requires the steam to pass through tubes for a greater part or all of its path during which heat is added, and the cellular, which requires the steam to pass through a chamber of irregular shape and to receive heat from gases flowing through tubes which pass through the steam chamber.

An example of Class 2 as applied to a Babcock and Wilcox water-tube boiler is shown in Fig. 57. Here the superheater is placed in a box that is arranged to form a continuation of the first and second passes of the gases of combustion as they pass around the tubes of the boiler. In order that the steam as it passes through the superheater may be thoroughly exposed to the hot gases, removable baffles or division plates are put in the headers of the superheater, two in the upper header at one-quarter of the length from each end and one in the lower header at mid-length. The result of this location of the baffles is to force the steam as it goes through the superheater tubes to pass through the hot gases 8 times. The superheater tubes are 2 ins. in diameter and are arranged in groups of 4, accessible from a single handhole.

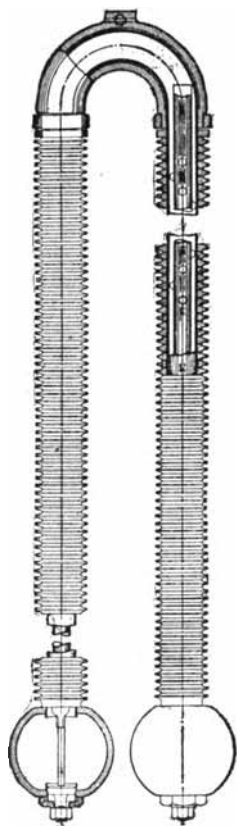

Figure 60.—Foster Superheater.

Fig. 60 is a return bend element with connection headers of a Foster superheater (Power Specialty Co., New York, N. Y.). Any number of these elements may be connected together, the number depending on the quantity of steam to be superheated, the amount of superheat and the temperature of the gases that will strike the elements. Each element consists of a seamless drawn steel tube, on the outside of which are cast iron gills or flanges close together, the mass of metal acting as a reservoir for heat. Inside of the

elements are wrought iron tubes centrally supported by knobs or buttons. These inner tubes are closed at the ends. A thin annular passage for the steam is thus formed between the inner and outer tubes, the steam clinging closely to the heating surface and is quickly heated.

Of Class 3 is the Schmidt, which when applied to Scotch boilers consists of collector castings and a system of units or elements made of U-bent cold-drawn seamless steel pipes. The collector castings are placed in either a vertical or a horizontal position and located in the uptake end of the boiler. The units are arranged in groups leading in and out of the uptake end of the boiler tubes and are expanded into flanges or collars which are in turn fastened to the collector castings. In joining the ends of the unit pipes to the collector castings one end of the pipe is in communication with the header from the boiler and the other with the steam pipe leading to the engine. Thus the steam in passing from the boiler to the engine must pass through the units in the tubes, where the superheating takes place. The most economical results are

## TESTS OF STEAMERS EQUIPPED WITH SUPERHEATERS

Name of Steamer	Engine	I. h. p.	Draft	Fuel		Superheat in Degrees F.	Type of Boiler	Type of Superheater
				Economy in Per cent.	Per I. h. p.			
<i>J. C. Wallace</i> .....	Quad- ruple exp.	1,589	Induced	6.7	1.546	88	Babcock & Wilcox	Babcock & Wilcox
<i>U. S. S. Michigan</i> ...	Triple	16,016	Forced	....	1.51	85.7	Babcock & Wilcox	Babcock & Wilcox
<i>U. S. S. Carolina</i> ...	Triple	17,651	Forced	....	1.395	47.5	Babcock & Wilcox	Babcock & Wilcox
<i>Odis</i> .....	Triple	900	Natural	....	1.303	....	Scotch	Schmidt
<i>Port Lincoln</i> * .....	Quad.	4,027	Howden	....	1.29	211	Scotch	Schmidt
<i>Port Augusta</i> .....	Triple	2,008	Howden	12.8-15	1.454	....	Scotch	Schmidt
<i>Dryden</i> .....	Triple	2,600	Natural	16.5	1.322	....	Scotch	Schmidt
<i>Mose</i> .....	Triple	1,600	Howden	....	1.10	....	Scotch	Schmidt
<i>Ferrona</i> † .....	Triple	1,925	Natural	....	1.20	200	Scotch	Schmidt

\* *Port Lincoln*, steam pressure 230 lb., temperature of steam 600°.

† *Ferrona*, steam pressure 180 lb., temperature of steam 580°.

From Marine Steam. Babcock & Wilcox Co.

obtained from the Schmidt superheater with a temperature of from 580° to 620° F. Between these temperatures it is claimed that in a quadruple expansion engine the consumption will be from 10 to 12%, in triple expansion 12 to 18%, and in compound engines

from 18 to 25% less than in similar engines using saturated steam and operating under the same conditions.

**Superheated Steam,** see section on Steam.

**Feed Pumps,** see Pumps.

**Boiler Covering,** see Insulating Materials.

**Ash Ejectors.**—Here the ashes are dumped into a hopper having a pipe curved at the upper end to a large radius that passes through the side of the vessel above the water line. To the hopper is a water connection from a pump, and by turning on the water the ashes are discharged overboard. The gallons of water required to operate ash ejectors are about as follows:

Size of discharge pipe Inches	Gallons of water per minute required to operate
3½	120 to 180
4½	160 to 240
6	210 to 360

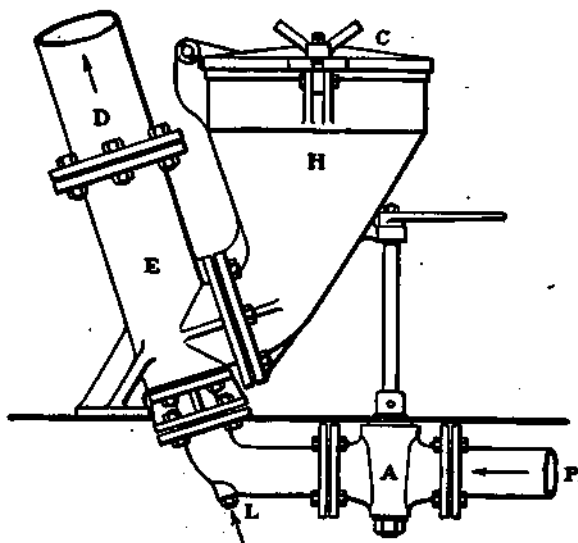

Figure 61.—Ash Ejector.

Fig. 61 is of an ash ejector built by Schutte & Koerting, Phila., Pa. *H* is the hopper into which the ashes are emptied, and *A* is the cock for turning on or off the water. The valve *L* admits air

only into the discharge pipe when the ejector is in operation and closes automatically when the discharge is stopped.

Instead of the above, on large steamers the ashes are raised in bags by a small steam engine and then dumped overboard.

**Operating.**—The amount of water fed to a boiler should be as uniform as possible. When getting under way open all the check valves to the same extent and test all the water gauges. The feed check valves should be adjusted afterwards to give the requisite uniform supply to each boiler. The feed stop valves should always be wide open when water is being fed into a boiler.

As to the temperature of the feed water the U. S. Steamboat-Inspection Rules state: "Feed water shall not be admitted into any marine boiler at a temperature less than 100° F., and every such boiler except donkey boilers, shall have an independent auxiliary feed appliance for supplying said boiler with water in addition to the usual mode employed, which auxiliary feed shall enter the boiler through an opening and a fitting which are entirely independent of the fitting and opening for the main feed."

Should any difficulty be experienced in feeding a boiler, the combustion should be checked at once by closing the dampers and, if necessary, ash pit doors. Should the water get below the lowest try cock and out of sight, the fires should be extinguished and then hauled.

Always deaden fires before hauling, which can be done by throwing on wet ashes. Fire extinguishers should be handy, which could be used in case of emergency.

**Firing.**—The intervals between successive charging of furnaces should be such that only a moderate amount of coal, not more than three shovelfuls, is required at each charging to keep the fires at the required thickness. In the U. S. Navy this interval has been found to be between four and five minutes. The rate of firing should be regular and some system of time firing be adopted.

The fires must be maintained at an even thickness. They should not be less than 6 ins. thick for natural draft, and may be increased to 12 ins. for heavy forced draft. The draft and air supply, as well as the thickness of the fires, should be regulated to suit the rate of combustion.

With a strong draft and very fine coal, it is sometimes desirable to dampen the coal before firing it, to prevent its being carried up the smoke pipe before being consumed.

The fires should be cleaned at regular intervals and the cleaning



should be started as soon as the fires show a tendency to become dirty, usually within 12 hours after starting the fires. Fires should be cleaned one after another, with a regular interval of time between. It is bad practice to clean several fires at practically the same time.

**Shutting Off Boilers.**—Fires should never be hauled except to prevent damage to a boiler in case of emergency. When steam is no longer required, fires must be allowed to die out in the furnaces, with the dampers, furnaces, and ash pits closed.

When a boiler is to be shut off, internal accumulations of dirt should first be removed by use of blow-out valves, and the boiler then pumped up again to the usual level, unless it needs emptying to carry out any repairs. Emptying by blowing down must never be resorted to.

Boilers, when not under steam or open for examination, should be kept full of fresh water of between three and four per cent. of normal alkaline strength. The boiler should be pumped full within 24 hours of completion of steaming, and should be kept so until 24 hours before being required for steaming purposes. Even if the boiler is to be examined within a few days of completion of steaming, the water should not be allowed to remain at working height, but the boiler pumped full.

When it is not practicable to keep idle boilers full of fresh water, they should be emptied, their interiors thoroughly dried out, and open trays as large as possible be filled to about half with quicklime and introduced through the manholes into the upper and lower parts of the boiler. The boiler must then be closed airtight and special precautions taken to prevent any moisture entering the interior.

**Overhauling Boilers.**—Whenever a boiler is laid up for a complete cleaning and overhauling the following operations should be carried out:

Clean fireside and overhaul all furnace fittings, brickwork, baffling, and fire parts.

Empty, open, and wash out the water spaces with fire hose.

Clean and inspect the water side and overhaul zincs (if installed) and internal fittings.

Rinse out with fresh water and close the boiler.

Overhaul all valves, gauges, cocks, and other fittings.

Examine and repair all parts of the lagging, casing, and seating.

Apply hydrostatic test for tightness of valves, gaskets, etc.

Test for tightness under steam, including tightness of casing, and adjust safety valves.

**Cleaning by Air Pressure.**—For partially cleaning the fire side of boilers, put a comparatively heavy air pressure on the fire rooms shortly before the fires die out, opening the boiler dust doors but having ash pit and furnace doors closed. This cleans the tubes and casings. Close all sources of air supply to the furnaces, and keep them closed until the boiler is cooled. The above can only be done when the wind is abeam.

**Precautions in Opening Steam Drum.**—After the boiler is empty see that the steam stop, feed and blow valves, and any other valves or cocks by which steam or water can enter the boiler are closed. Insure a complete absence of pressure by opening the air cock and test and water gauge cocks. Take off the manhole plates and ventilate the boiler for a sufficient time to allow all foul air to escape, and let no one enter the boiler until it has been ascertained that the air is pure. Owing to the possibility of the presence of an explosive mixture of hydrogen and air in boilers fitted with zincs, the air in the boiler must be diffused before applying an open light.

**Washing Out Boilers.**—Use a hose with water at a pressure of at least 50 lb. Take the hose into the steam drum and wash out the circulating tubes; that is, if the boiler is a water tube boiler. The washing out should be done as soon as possible after emptying, and before the sediment left in the tubes, nipples, and boxes becomes hardened.

**Cleaning Tubes.**—Clean the tubes with swabs, bristle brushes, wire brushes, or scrapers, unless their condition indicates the necessity of using turbine cleaners.

Hard scale containing much sulphate of lime and magnesium can be removed from the boiler tubes with a turbine water cleaner using water at a pressure of about 125 lb. per square inch. The following has given good results:

Sal soda.....	40 lb.
Catechu.....	5 lb.
Sal ammoniac.....	5 lb.

**Boiling Out.**—The amount of boiler compound to be used and the time required for boiling out depends on the nature and amount of the dirt present. If an inspection after 24 hours continuous

boiling shows that the scale is still hard, the boiling should be continued.

In boiling out, introduce steam from another boiler to the lower part of the boiler, allowing the excess to blow off through the safety valves or air cocks at about 40 lb. pressure. If it is impracticable to use steam from another boiler, maintain very light fires and carry only enough pressure in the boiler to insure circulation. If heavy fires are maintained there is danger of overheating a dirty boiler:

#### CAUSES OF SCALE AND REMEDY

Troublesome substance	Trouble	Remedy or Palliation
Sediment, mud, clay, etc...	Incrustation	Filtration; blowing off
Readily soluble salts.....	Incrustation	Blowing off
Bicarbonates of lime, magnesia, iron.....	Incrustation	Heating feed. Addition of caustic soda, lime or magnesia, etc.
Sulphate of lime.....	Incrustation	Addition of carbonate of soda, barium chloride, etc.
Chloride and sulphate of manganese.....	Corrosion	Addition of carbonate of soda, etc.
Carbonate of soda in large amounts.....	Priming	Addition of barium chloride, etc.
Dissolved carbonic acid and oxygen.....	Corrosion	Heating feed. Addition of caustic soda, slaked lime, etc.
Grease (from condensed steam).....	Corrosion	Slaked lime and filtering
Organic matter (sewage)...	Corrosion	Carbonate of soda Substitute mineral oil Precipitate with alum or ferric chloride and filter

Operating and Overhauling contain abstracts from pamphlet published by the U. S. Navy Department, also from Care of Naval Machinery. H. C. Dinger.

#### DRAFT

Natural draft is caused by the difference of weight in the heated air of the uptake and the cold air entering the furnace. To obtain a good draft the funnel and uptake temperatures must be between 600° and 700° F., this temperature being necessary to bring about the required difference of weight of air.

**Heat Absorbed in Creating Natural Draft.**—The specific heat of the funnel gases is about .23, which means that to raise one pound of the gases  $1^{\circ}$  in temperature, .23 of the heat unit (B. t. u.) is necessary. The example given below shows the loss incurred by the generation of natural draft.

*Example.* Cold air temperature  $62^{\circ}$ , uptake temperature  $700^{\circ}$  F., and allowing 24 lb. of air per pound of coal: calculate the heat units per pound of coal used in producing the draft.

$700^{\circ} - 62^{\circ} = 638^{\circ}$  increase of air temperature

B. t. u. required =  $638^{\circ} \times (24 + 1) \times .23 = 3,668.5$

The quantity  $(24 + 1) = 24$  lb. of air + 1 lb. of coal = 25 lb. of gases in all neglecting ash and clinker.

Assume that 1 lb. of coal contains 14,500 B. t. u., or 100%

Then  $14,500 : 3,668.5 = 100\% : x\%$  and  $x = 25\%$

Thus 25% of the heat units in each pound of coal are used up in producing the necessary difference in temperature of the funnel gases required to form a draft by difference of weight.

**For Increasing the Draft to a Boiler,** one of four means may be employed:

(1) Closed fireroom; air forced by blowers into the fireroom which is closed airtight except for the inlets to the furnaces. A static pressure of  $\frac{3}{4}$  to 3 ins. of water is maintained according to the rate of combustion required.

(2) Closed ash pit; the air in the stoke hold is at the same pressure as the outside atmosphere, the air handled by the blowers is led through ducts, and after passing over tubes heated by the waste gases from the boiler the air is delivered to the ash pits under pressure. An allowance of 4.5 cu. ft. of air per minute at atmospheric temperature per pound of coal burned per hour is usually enough and represents the provision of 270 cu. ft. of air per pound of coal. A well known type of this system is the Howden.

(3) Exhaust fan in uptakes or between them and the funnel. Represented by the Ellis and Eaves induced draft system, in which an exhaust fan draws the gases along the uptakes and discharges them into the funnel. Assuming that the products of combustion reach the fan at  $550^{\circ}$  F., a capacity of 9.33 cu. ft. of gases per minute per pound of coal burned per hour should be allowed, this being equivalent to 560 cu. ft. of gases per pound of coal.

(4) Steam jets in the funnel.

Data from Mechanical Draft. Am. Blower Co.

**Measurement of Draft.**—Draft is measured by a U-shaped tube located in the fireroom, one end of which is open to the air pres-

sure in the fireroom and the other connected by an iron pipe to the space under the grates. The difference between the two pressures causes the water to rise and fall in the tube. On the side of the tube is a scale with fractions of an inch marked. Instead of the U tube a steam gauge having a graduated scale from 0 to 5 lbs. may be used for forced draft.

A column of water 27.66 ins. high exerts a pressure of one lb. per sq. in. Thus if the reading is 3 ins., then the pressure of the draft is  $\frac{3}{27.66} = .108$  lbs. per sq. in. If the pressure at the fan is  $2\frac{1}{2}$  ins., the pressure under the fire bars is about  $\frac{1}{8}$  in.

VELOCITY CREATED WHEN AIR UNDER A GIVEN PRESSURE ESCAPES INTO THE ATMOSPHERE

Pressure in Inches Water Gauge	Velocity of Air in Feet per Second	Pressure in Inches Water Gauge	Velocity of Air in Feet per Second	Pressure in Inches Water Gauge	Velocity of Air in Feet per Second
.1	20.7	1.5	80.1	2.9	111.2
.2	29.3	1.6	82.7	3.0	113.0
.3	35.8	1.7	85.2	3.1	114.9
.4	41.4	1.8	87.7	3.2	116.7
.5	46.3	1.9	90.1	3.3	118.5
.6	50.7	2.0	92.4	3.4	120.3
.7	54.7	2.1	94.7	3.5	122.0
.8	58.5	2.2	96.9	3.6	123.8
.9	62.1	2.3	99.1	3.7	125.4
1.0	65.4	2.4	101.2	3.8	127.1
1.1	68.6	2.5	103.3	3.9	128.8
1.2	71.6	2.6	105.3	4.0	130.4
1.3	74.6	2.7	107.3		
1.4	77.4	2.8	109.3		

From Mechanical Draft. B. F. Sturtevant Co.

**Air Required.**—The amount of air admitted to the furnaces should be regulated so that little or no smoke issues from the stacks. To find out about the combustion get an Ellis tube and test a sample of the smoke gases for carbon dioxide. Perfect combustion produces about 16% carbon dioxide in the stack gases. If the instrument shows 14% the combustion is very good but if it drops to 6, there is either too much air going through or not enough. Another chemical is put in the tube and another sample tested for carbon monoxide. If over 3% shows, it is fairly certain that there is not enough air under the grate bars. If there is only  $\epsilon$

trace of carbon monoxide then there is too much air. There are on the market recording devices which automatically take and test samples of stack gases and trace a curve, which on a large ship is a valuable index of how the firing is being done, and shows at what times the firing was bad.

The actual amount of air passing into the furnaces is usually not less than 18 or 20 lb. per pound of coal and may considerably exceed this amount. At 12.5 cu. ft. per pound (that is, 12.5 cu. ft. of air weighs 1 lb.) this would give the volume of air required per pound of coal from 225 (18 times 12.5 cu. ft.) to 250 cu. ft. See table Quantity of Air Required for Combustion of Fuel.

**Blowers.**—There are a number of types on the market having a variety of design of runners or wheels. One that has given exceptionally good results is the *Sturtevant*, which consists of long narrow blades on the periphery of a wheel, curved forward in the direction of rotation and mounted parallel to the shaft. The blowers are driven by electric motors, by high speed steam engines running at 250 to 700 r. p. m., or by steam turbines. See Ventilation.

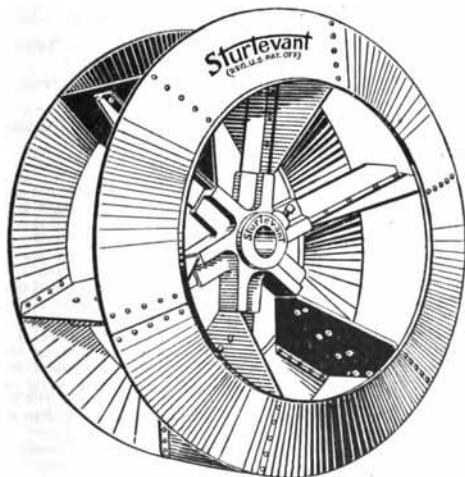

Figure 62.—Fan Rotor.

On account of the high speed it is important that all parts be properly lubricated. The speed at which the blower is to run is regulated by the water tender and is governed by the air pressure

that is to be maintained. The engines require a periodical adjustment of the working parts, and they should be tried at least once a month if the vessel does not ordinarily run on forced draft. Care must be taken that the doors of the casings, oil service, etc., are absolutely dust tight, and that no dust or dirt can get on the bearings.

When two or more turbine-driven high speed fans are in the same fireroom, the speed of each fan must be practically the same to obviate the fans' working against each other. The fan speeds may be adjusted by a single valve at each turbine and all fans slowed down or speeded up, as conditions require, by the manipulation of one valve supplying steam to all the turbines.

Below is an abstract from the specifications for 9 turbine units for the U. S. battleship *California*: "Each blower to be of the multivane, centrifugal cased double inlet type capable of discharging continuously with ease 23,000 cu. ft. of air per minute with an average pressure at the boiler fronts not exceeding 4 ins.

#### FANS BUILT FOR FORCED DRAFT INSTALLATIONS AS INSTALLED ON VARIOUS STEAMERS

(B. F. Sturtevant Co., Hyde Park, Mass.)

Cubic Feet per Minute	Revolutions per Minute	Size of Fan	Diameter of Wheel Inches	Driver
16,000	400	90 ins.	54	6 × 5 vertical single-cylinder
16,000	475	No. 9 multivane	40	5 × 4 vertical double-cylinder
16,000	350	119 ins.	66	6 × 5 vertical single-cylinder
18,000	450	100 ins.	60	6 × 5 vertical single-cylinder
18,000	450	No. 9 multivane	40	6 × 5 vertical single-cylinder
20,000	325	120 ins.	72	7 × 6 vertical single-cylinder
25,000	350	120 ins.	72	7 × 6 vertical single-cylinder
25,000	325	130 ins.	78	7 × 6 vertical single-cylinder
25,000	450	No. 9 multivane	40	7 × 6 vertical double-cylinder
30,000	500	No. 9 multivane	40	5 × 4 vertical double-cylinder
30,000	300	140 ins.	87	8 × 8 vertical single-cylinder
35,000	400	No. 10 multivane	47	8 × 7 vertical single-cylinder
17,000	900	No. 6 multivane	23	20 h. p. electric motor
23,000	1,000	No. 7 multivane	28	30 h. p. electric motor
40,000	700	No. 8 multivane	34	45 h. p. electric motor
20,000	2,000	No. 60 turbovane	25	Steam turbine
20,000	1,600	No. 6 multivane	23	Steam turbine
30,000	1,500	No. 80 turbovane	39	Steam turbine

Where the size of the fan is given in inches the fan is always of the steel plate type. The diameter of the inlet on steel plate fans is about seven-tenths the diameter of the wheel and the diameter of the inlet on multivanes and turbovanes is about 85% of the diameter of the wheel. The outlet, while of rectangular form, generally has an area about equal to the inlet area.

of water. Each blower will be driven by a direct connected steam turbine, coupled direct to the fan shaft by a flexible coupling. The turbine to be of sufficient power to run the blower at full capacity with a steam pressure of 200 lb. gauge, but will be strong enough to run continuously at 280 lb. with 50° F. superheat and with a back pressure of about 10 lb. The steam consumption per brake horse power under operating conditions not to exceed 45 lb. per hour."

#### *Miscellaneous Notes*

The size of coal must be reduced and the depth of the fire increased directly as the intensity of the draft is increased.

The frictional resistance of the surface of the funnel is as the square of the velocity of the gases. Ordinarily from 20 to 30% of the total heat of combustion is expended in the production of the stack draft, to which is to be added the losses by incomplete combustion of the gaseous portion of the fuel, and the dilution of the gases by an excess of air, making a total of fully 60%.

One square foot of grate will consume on an average 12 lb. of coal per hour under natural draft.

#### **Temperatures.—**

Furnace temperature about.....	2600° F.
Combustion chamber.....	1500° F.
Uptake.....	750° F.
Funnel.....	600° F.

In some torpedo boat destroyers the hatches to the fireroom are made with two doors, viz., an upper and a lower, so that the men on entering and leaving will not cause a loss of pressure in the fireroom.

## **MARINE STEAM ENGINES**

Marine steam engines are of the vertical type for screw propulsion, and beam or inclined for paddle wheel. The boiler pressure for compound engines is about 120 lb., for triple expansion 140 to 180, and slightly higher for quadruple. With a main steam pipe of ample size and the throttle valve wide open, the initial pressure should not be much lower than 5 lb. below the boiler pressure. The mechanical efficiency of an engine is the ratio of the work available at the propeller or at the paddle wheel to the work done on the pistons, and is from 85 to 90%.

**Vertical Engines.**—When their length must be kept at a minimum



a tandem arrangement of the cylinders may be adopted; thus a four-cylinder triple expansion engine may only have three cranks. The following table gives the ways the cylinders may be supported.

Cylinder Supported By	Condenser	Class of Vessel
Cast iron column on one side to condenser which forms part of frame, other side has steel columns to bed plate	Part of frame	Tugs and cargo steamers
Cast iron A columns	Separate from engine	Passengers and cargo steamers
Steel columns	Separate from engine	War vessels

To get the maximum work from the steam it is expanded in two or more cylinders—sometimes in as many as four, as in quadruple expansion—but the general practice in large engines is to have them triple expansion with three cylinders; if with four, besides the high and intermediate there are two low-pressure, and with five there are one high, two intermediate and two low.

The ratio of the volume of the high-pressure cylinder to the low in compound engines is about 1 to 4, and in triple expansion 1 to 7 or 1 to 7.25, the ratio to the intermediate being about 2.9.

The ratio of expansion is the ratio of the volume of the low-pressure cylinder up to the point of release and including the clearance to the volume of the high-pressure cylinder up to the point of cut-off including the clearance. Taking the high-pressure cylinder as one, then the ratio of expansion in compound engines ranges between 5 and 7; for triple expansion between 8 and 12; and for quadruple expansion between 12 and 15.

The valve controlling the admission of steam to the high-pressure cylinder is generally of the piston type, to the intermediate a single-ported or double-ported slide valve, and to the low pressure a double-ported slide valve. The great advantage of a piston valve lies in the fact that it is perfectly balanced in regard to the steam pressure.

The power developed in each cylinder depends on the cut-off of the steam by the valve. The total horse power can be altered by changing the high-pressure cut-off or the initial pressure. To

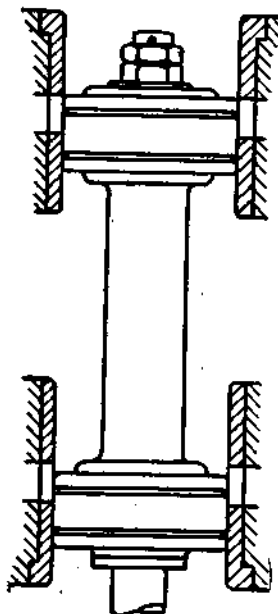

Figure 63.—Piston Valve.

cut down the horse power of an engine, it is considered more economical to cut off earlier in the high-pressure cylinder than to lower the initial pressure by throttling. (See table of Steam Used Expansively, page 405.)

#### Expansion, Cut-off and Back Pressure.

Type of Engine	Initial Pressure at Engine Absolute	Nominal Expansions	High Pressure Cut-off.	Back Pressure in lbs. per sq. in. Low Pressure Cylinder
Triple expansion naval.....	165	8	.7	5
	to 200	to 8½	to .8	to 7
Triple expansion merchant.....	165	9	.65	5
	to 185	to 12	to .75	to 6
Quadruple expansion merchant..	190	12	.65	5
	to 210	to 14	to .75	to 6

[From Marine Engine Design, by Bragg.]

The order in which the cranks pass the top center when the engine is going ahead, to a person standing forward and looking aft, is called the crank sequence. Crank sequences are given starting with the forward cylinder. Thus in a triple expansion engine with the cylinders arranged with the high pressure forward, then the intermediate, and then the low, the crank sequence is generally high pressure, intermediate pressure, and low pressure; and with a four-cylinder triple, high pressure, forward low pressure, intermediate pressure, and then low pressure.

In compound engines the cranks are  $90^\circ$  apart; in three-cylinder triple  $120^\circ$ ; and in a four-cylinder often  $90^\circ$ . Designers as far as possible endeavor to have each cylinder develop the same power, and by a suitable arrangement of the cranks and moving parts to have the engine balanced so that no parts are unduly strained or overloaded.

The distance between the piston and the bottom or top of the cylinder at the end of the stroke is the *linear clearance*. This is usually about  $\frac{1}{4}$  of an inch or so at the top and  $\frac{3}{8}$  of an inch at the bottom, the clearance always being more at the bottom to allow for the wearing down of the bearings.

The general design of an engine depends on the trade in which the vessel is to engage. For torpedo boats and other craft where

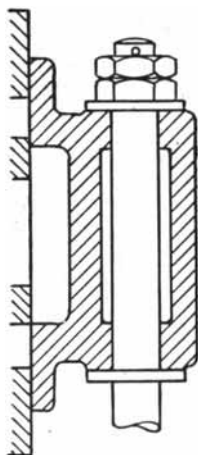

Figure 64.—Slide Valve.

high speed is essential, engines running at 400 or more revolutions per minute are not uncommon. Here the cylinders have a comparatively short stroke and there are at least four. For merchant vessels revolutions are decreased, the stroke is longer, and the cylinders are larger per horse power developed.

To secure economy in the consumption of steam and hence of coal, the steam, after leaving the low-pressure cylinder, passes into a condenser (see Condensers). In the case of surface condensers they often form part of the engine framing. The back pressure on the low-pressure piston for condensing engines is about 3 lb. per square inch absolute, and for non-condensing 18 lb. absolute.

**Paddle-wheel Engines.**—These can be divided into two classes, viz., those driving steamers with the wheels on the side and those driving steamers with wheels at the stern.

**Side-wheelers** either have the engines inclined with the connecting rods working directly on the crank shaft, or vertical with the connecting rod connected to a walking beam from which is a rod that drives the wheel shaft. When the engines are inclined there are two or more cylinders and the steam works expansively. When vertical there is only one cylinder having a stroke of several feet. (See Excursion Steamers and Paddle Wheels.)

**Simple beam engines** have double poppet valves, generally with fixed Stevens' cut-off and in some cases with adjustable Sickles' dash-pot cut-off. Double trip shafts for raising the main and exhaust valves are on the larger engines, one trip shaft being for hand use and the other for operation by steam, as may be desired. When the boat is maneuvering, or approaching or leaving a pier, the main valve eccentric gear is disconnected.

The main valves of the **inclined engines** for paddle steamers are usually of the double-beat poppet type, although in some cases there is a balanced slide valve on the high-pressure and double-ported slide valves on the low-pressure cylinders. Stephenson link gear is usually employed although the Walschaert gear has given excellent results. Piston valves have been extensively used.

The main air pumps may be worked by the main engines. The condensers, feed water heaters, filters, and auxiliaries are of the customary types. While jet condensers, in combination with water purifiers, in the past have been installed mostly on the Great Lakes, in recent years surface condensers have been adopted.

**Stern-wheel vessels** are largely used on the Mississippi and other western rivers in the United States, and on shallow rivers

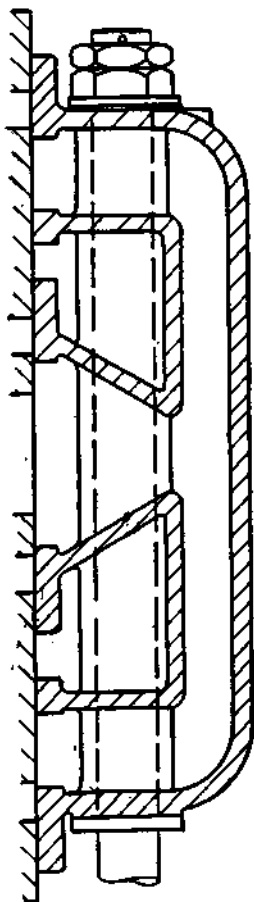

Figure 65.—Double-Ported Slide Valve.

in Africa and South America. In the United States the engines have horizontal cylinders relatively small in diameter, with a long stroke. The peculiar feature is the valve gear, the valves being of the double-beat poppet form, and each cylinder (one on each side

of the steamer) is provided with four, two for steam and two for exhaust, the valves being operated by a cam mechanism.

Valves.—Different types are shown in Figs. 63, 64, 65 and 66. The chief advantage of a piston valve is that it is perfectly balanced as regards the steam pressures which act upon it. Since a flat slide valve is forced against its seat by the pressure of the steam on its back (which pressure is equal to the difference between the pressure in the receiver and in the cylinder), there is a heavy frictional load to be overcome by the eccentric acting through the valve stem. To keep the heads of a piston valve tight, packing rings are provided. In some cases where a piston valve takes

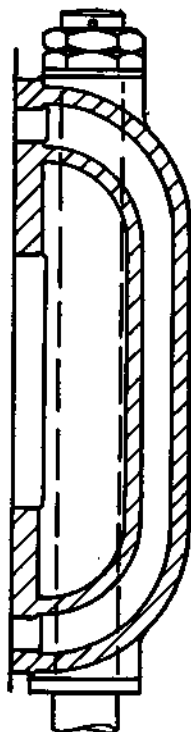

Figure 66.—Allan's Valve.

steam on the outside the steam is led to the chest at one end only, and then passes to the other end through the inside of the valve. In such cases the body of the valve is hollow, and as large as possible.

Fig. 64 shows a single-ported valve that covers but one set of ports.

Fig. 65 is a double-ported slide valve. With this valve the area of the port opening required may be obtained with a travel of valve only one-half that for a single-ported valve, or with the same valve travel twice the area of the port opening may be secured. It is for this reason that a double-ported valve is often selected when it is desired to obtain a relatively large opening with a small travel of the valve.

Trick's or Allan's valve (Fig. 66) gives a much quicker opening and also a longer duration of full opening than a plain slide valve. It is often used on compound engines.

A triple expansion engine with cylinders  $16\frac{1}{2}$ , 25 and 43 ins. in diameter by 30 stroke had the following valves:

Cylinder	Valve	Size of Port Openings
High pressure	Piston (Fig. 63)	Rectangular port openings spaced around a circle 7 ins. in diameter. The openings being $1\frac{3}{8}$ ins. high, with $\frac{5}{8}$ in. of metal between them
Intermediate pressure	Slide (Fig. 64)	Port openings on cylinder starting at top of cylinder, $1\frac{1}{2}$ steam, $3\frac{3}{8}$ exhaust, $1\frac{1}{2}$ steam by 24 ins. wide. Valve faces, top $3\frac{1}{8}$ , opening $5\frac{5}{8}$ , lower face $3\frac{1}{8}$ by 24 ins.
Low pressure	Double-ported Slide (Fig. 65)	Port openings on cylinder starting at top $1\frac{3}{8}$ , $1\frac{3}{8}$ , $4\frac{1}{2}$ , $1\frac{3}{8}$ and $1\frac{3}{8}$ by 3 ft. 5 ins. Valve face $3\frac{1}{8}$ , opening $2\frac{3}{4}$ , face $1\frac{1}{4}$ , opening $1\frac{3}{8}$ , face $3\frac{1}{8}$ , opening 7, face $3\frac{1}{8}$ , opening $1\frac{3}{4}$ , face $1\frac{1}{4}$ , opening $2\frac{3}{4}$ , face $3\frac{1}{8}$ , by 3 ft. 5 ins. wide

**Lap and Lead.**—Figs. 67 and 68 are sections through a slide valve and cylinder showing lap (Fig. 67) and lead (Fig. 68).





Expansion	Valve Travel	Lead		Steam Lap		Port Opening		Cut-Off	
		Top	Bottom	Top	Bottom	Top	Bottom	Top	Bottom

## INTERMEDIATE PRESSURE DOUBLE-PORTED SLIDE VALVE

.65 (full gear)	6	$\frac{3}{8}$	$\frac{3}{8}$	$1\frac{1}{8}$	$1\frac{1}{4}$	$1\frac{1}{8}$	$1\frac{1}{2}$	$33\frac{1}{4}$	$29\frac{1}{4}$
-----------------	---	---------------	---------------	----------------	----------------	----------------	----------------	-----------------	-----------------

## LOW PRESSURE DOUBLE-PORTED SLIDE VALVE

.53 (full gear)	8	$\frac{1}{2}$	$\frac{1}{4}$	$2\frac{1}{2}$	$2\frac{1}{4}$	$1\frac{1}{2}$	$1\frac{1}{4}$	$28\frac{1}{2}$	$22\frac{1}{2}$
-----------------	---	---------------	---------------	----------------	----------------	----------------	----------------	-----------------	-----------------

Abstracts from Verbal Notes. J. W. M. Sothorn.

**Valve Mechanism.**—The most satisfactory valve mechanism for vertical marine steam engines is the Stephenson. With it the direction of rotation of the engine may be changed at will, and the point of cut-off varied by varying the travel of the valve.

The Stephenson valve mechanism or link motion consists of two eccentrics, viz., ahead and astern, with a link connecting the ends of the eccentric rods that are fastened to the eccentric straps

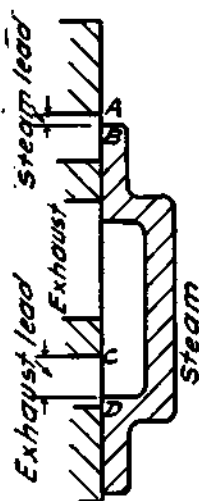

Figure 68.—Lead.

on the engine shaft, so that by varying the position of the link the valve stem may be put in direct connection with either eccentric or may be given a movement controlled partly by one eccentric and partly by the other. When the link is moved by suitable levers into a position such that the block to which the valve stem is attached is at either end of the link, the valve receives its maximum travel and when the link is in mid-position the travel is the least and the cut-off takes place early in the stroke.

The expression "open and crossed eccentric rods" is understood to mean the position of the eccentric rods when the crank is on the bottom center, as in running the rods open and cross each other alternately. For slide valves or outside steam piston valves the rods are usually arranged as open, but with inside steam piston valves the rods are fitted so that they are crossed when the crank is on the bottom center. This is to obtain the full benefit of link expansion, for if the rods were arranged the reverse way the lead would be diminished when linked up, and the range of expansion more limited.

#### EFFECTS OF LINKING UP (SLIDE VALVES)

Arrangement of Eccentric Rods	Valve Travel	Lead	Cut-Off	Release	Compression
Open rods (crank on bottom).....	Reduced	Increased	Earlier	Earlier	Earlier
Crossed rods (crank on bottom)...	Reduced	Decreased	Earlier	Earlier	Earlier

The disadvantages of linking up are: excess wire drawing of steam, due to reduced port opening, and rapid increase of compression, which reduces the effective area of the indicator diagram.

In the ordinary shifting link with open rods, the lead of the valve increases as the link is moved from full to mid-position, that is, as the period of steam admission is shortened. The variation of lead is equalized for the front and back strokes by curving the link to the radius of the eccentric rods concavely to the axes. With crossed eccentric rods the lead decreases as the link is moved from full to mid-position.

The linear advance of each eccentric is equal to that of the valve in full gear, that is, to the lap plus the lead of the valve when the eccentric rods are attached to the link in such position as to cause half the travel of the valve to equal the eccentricity.

The angle between the two eccentric radii, that is, between lines drawn from the center of the eccentric disks to the center of the shaft, equals  $180^\circ$  less twice the angular advance.

**Setting of Valves.**—Whether a valve is properly set or not can be readily told by taking indicator cards (see Indicator Cards). Many engines are supplied with steel laths marked with the setting of the valves and these are used to verify the position of the valves.

To measure the lead of a valve, put engine on center with link in full gear and measure the steam port opening for that end. If this distance corresponds with the lead given on the drawing, the valve is set as designed. The cylinders of large engines have peepholes covered with bolted plates, by removing which the valves may be observed. A long thin wooden wedge is inserted in the opening as far as it will go, the edges of the opening leaving a mark on the wedge which is the measure of the lead. When the marks left by either end are alike the leads are alike.

Owing to the wear on their collars, valves will drop, thus decreasing the lead at one end, and increasing it at the other. If the valve takes steam on the outside, a dropping down of the valve will increase the lead on top and decrease it at the bottom.

To bring the valve up into the proper position, distance pieces may be put above the shoulder of the valve stem, or liners placed under the valve stem. This takes into account the dropping down of a valve due to wear, and hence the shortening of the valve stem. Valves may also be changed by shifting the nuts holding the valve.

**To Find the Steam Pressure in a Cylinder at the End of the Stroke.**—Boyle's law states that the pressure of a gas varies inversely as the volume if kept at a constant temperature.

Let  $P$  = absolute pressure in pounds  
 $V$  = volume in cubic feet  
 $C$  = constant

$$\text{Then } P \times V = C; P = \frac{C}{V}, V = \frac{C}{P}$$

**Example.** The initial pressure in the high pressure cylinder of an engine is 185 lb. gauge pressure, the cut-off .6. Find the theoretical pressure at the end of the stroke.

$$P = 185 + 15 \text{ (atmospheric pressure)} = 200 \text{ lb.}$$

$$C = P \times V = 200 \times .6 = 120 \text{ lb.}$$

Then the absolute pressure  $P_2 = \frac{C}{V_2} = \frac{120}{1} = 120 \text{ lb.}$ , and  $120 - 15 \text{ lb. (atmospheric pressure)} = 105 \text{ lb. gauge pressure.}$

TABLE OF STEAM USED EXPANSIVELY

Initial Pressure Lb. per Square Inch	Average Pressure of Steam in Lb. per Square Inch for the Whole Stroke. Portion of Stroke at Which Steam is Cut Off.					
	$\frac{3}{4}$	$\frac{2}{3}$	$\frac{1}{2}$	$\frac{1}{3}$	$\frac{1}{4}$	$\frac{1}{5}$
30	28.9	27.5	25.4	22.2	17.9	11.5
35	33.8	32.1	29.6	25.9	20.8	13.4
40	37.5	36.7	33.8	29.6	23.8	15.4
45	43.4	41.3	38.1	33.3	26.8	17.3
50	48.2	45.9	42.3	37.	29.8	19.2
60	57.8	55.1	50.7	44.5	35.7	23.1
70	67.4	64.3	59.2	52.4	41.7	26.9
80	77.1	73.5	67.7	59.3	47.7	30.8
90	86.7	82.6	76.1	66.7	53.6	34.6
100	96.3	91.8	84.6	74.1	59.6	38.4
110	106.	101.	93.1	81.5	65.6	42.5
120	115.2	110.2	101.5	89.4	71.5	46.1
130	125.4	119.1	110.	95.3	77.5	50.
140	134.9	128.6	118.5	103.8	83.3	53.8
150	144.7	137.8	126.4	111.2	89.4	57.7
160	153.6	147.	135.4	118.2	95.4	61.5
180	173.5	164.6	152.3	132.9	107.3	69.2
200	192.7	183.7	169.3	148.3	119.3	76.9

To Find the Number of Expansions by Pressures and by Volumes.\*

(1)  $\frac{\text{High-pressure initial pressure absolute}}{\text{Low-pressure terminal pressure absolute}} = \text{number of expansions by pressures.}$

(2)  $\frac{\text{Low-pressure ratio}}{\text{High-pressure cut-off}} = \text{number of expansions by volumes}$

*Example.* Find the total number of expansions by pressures in a triple expansion engine, if the high-pressure cylinder has an initial pressure of 165 lb. (gauge) and the low-pressure cylinder a terminal pressure of 12 lb. absolute. Also the number of expansions by volume if the cylinder ratios are 1 : 2.7 : 7.2, and the high-pressure cut-off is .6

165 lb. + 15 lb. (atmospheric pressure) = 180 lb. abs.

By (1)  $\frac{\text{High-pressure initial pressure absolute}}{\text{Low-pressure terminal pressure absolute}} = \frac{180}{12} = 15 \text{ expansions by pressure.}$

(2)  $\frac{\text{Low-pressure ratio}}{\text{High-pressure cut-off}} = \frac{7.2}{.6} = 12 \text{ expansions by volume.}$

**High-Pressure Cut-Off and Coal or Steam Consumption.\***—The consumption (either coal or steam), and therefore the horse power

\* Int. Marine Engineering, New York.

developed, vary as the cube of the speed of a steamer at moderate speeds. As the high-pressure valve cut-off is the approximate rate of steam consumption and therefore of the coal consumption, then the variation in cut-off for a given speed may be approximated as follows:

*Example.* The speed of a steamer is 12 knots, with the high-pressure cylinder cut-off .6. Find the high-pressure cut-off required to reduce the speed to 11 knots.

$$12^3 : 11^3 = .6 : x \text{ (the new cut-off)}$$

$$1728 : 1331 = .6 : x$$

$$x = .46 \text{ the new cut-off}$$

Indicator Cards\* are important not only for calculating the indicated horse power (i. h. p.) but also for giving information on the work done in a cylinder. An ideal card is shown in Fig. 69.

*RS* is the line of zero pressure (called the absolute pressure line), from which all pressures are measured upward according to the scale of the diagram. *A* is the beginning of the downstroke, *B* the point of cut-off, *C* the point of exhaust, and *D* the end of the stroke. The line *AB* is the steam line and shows the steam pressure on the upper side of the piston from the beginning of the stroke to the point of cut-off. The line *BC* is the expansion line and shows the decreasing values of the pressure during that part of the stroke. At *C* the exhaust opens and the pressure drops suddenly as shown by *CD*.

For the return or upstroke, *D* is the beginning, *E* the point of exhaust closure or beginning of compression above the piston, and *F* the point of steam opening just before the beginning of the next downstroke.

*CD* is the exhaust line and shows the nearly constant pressure during the exhaust period. *EF*, the compression line, shows the increasing pressure on the return stroke after the closing of the exhaust valve. *FA*, the admission line, shows the sharp jump upward as the steam valve is opened, just before the beginning of the next downstroke.

The line *PQ* is drawn when the space below the indicator piston is shut off from the engine cylinder and connected to the air; it is the atmospheric line. The distance between *RS* and *PQ* represents the pressure of the atmosphere, viz., 14.7 lb. per square inch. Thus for the downstroke the varying pressures on the top of the piston are shown by the varying distances from *RS* to *ABCD*,

\* From Practical Marine Engineering.

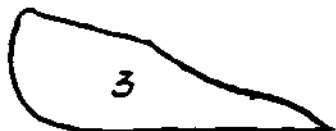
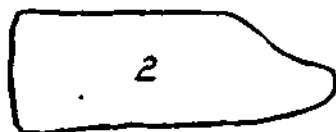
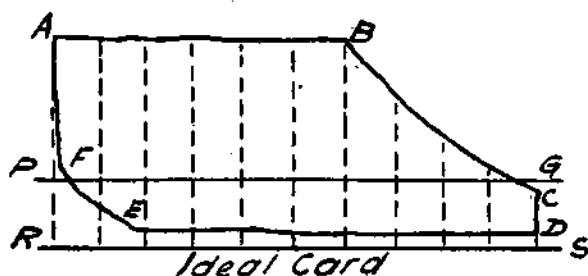

Figure 69.—Indicator Cards.

while for the upstroke the pressures on the same side of the piston are shown by the distance from  $RS$  to  $DEFA$ .

**Analysis of Different Cards** (Figs. 69 and 70).—(1) Eccentric too far from a line at right angles to the crank; i. e., angular advance is too large.

*Results.* Cut-off too early, steam lead large, exhaust opening and closure early. Whole cycle of events is ahead of time.

(2) Eccentric too near a line at right angles to the crank; i. e., angular advance is too small.

*Results.* Cut-off too late, steam lead small or negative, compression small, steam opening late, exhaust opening and closure late. Whole cycle of events behind time.

(3) Steam lap too large.

*Results.* Cut-off early, steam opening late, and lead small or even negative, port opening small with a probable wire drawing of the steam and drop of pressure on the steam line.

(4) Steam lap too small.

*Results.* Cut-off late, steam opening early and lead large and port opening large.

(5) Exhaust lap too large.

*Results.* Exhaust closure early and compression large, exhaust opening late and exhaust lead small.

(6) Exhaust lap too small.

*Results.* Exhaust closure late and compression small, exhaust opening early.

(7) Excessive compression. The pressure in the cylinder may be carried above that in the valve chest before the steam valve opens, thus forming a loop as in Fig. 1. This may be due to either (1) or (5).

(8) Excessive expansion (Fig. 7).

*Results.* The pressure in the cylinder may fall below that in the next receiver or exhaust space beyond, thus forming a loop as in Fig. 7.

(9) Valve stem too long (Fig. 8).

*Results.* The middle of the stroke of the valve is placed too high relative to the ports. The results for an outside valve will be to give too much steam lap on top and exhaust lap on the bottom and too little steam lap on the bottom and exhaust lap on top. Hence: steam opening in the top is late and small and the cut-off early; steam opening on bottom is early and full and the cut-off late; exhaust opening in the top is early and full and the closure late; exhaust opening on bottom is late and small and the closure early.

(10) Valve stem too short.

*Results.* Similar to those in (9) but oppositely related to the ends of the cylinder.

(11) Leaky piston or piston rod stuffing box.

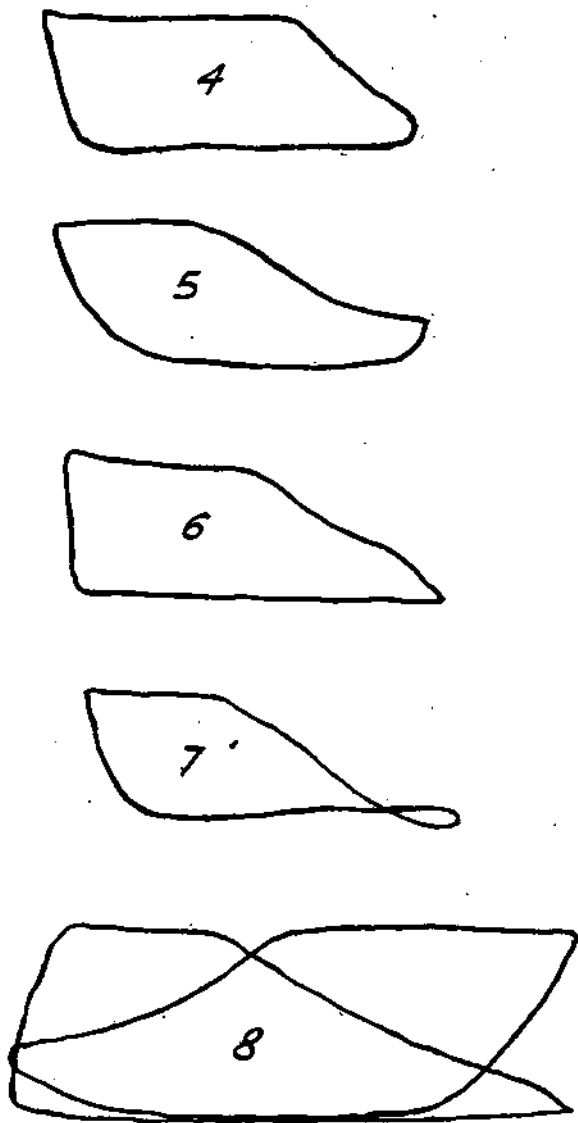

Figure 70.—Indicator Cards.



*Results.* Expansion line will be steeper than it should be. Compression line may also flatten off somewhat near the top.

(12) Port openings or passages too small.

*Results.* Wire drawing or loss of pressure on the steam line and rise of pressure on the exhaust line.

**To Calculate the Mean Effective Pressure and the Indicated Horse Power.**—Divide the curve obtained from an indicator into say 11 even parts and measure the ordinates. Take the mean length of all the ordinates, which will be in inches and a decimal, and multiply it by the scale of the spring used in the indicator; the result will be the mean effective pressure or  $P$  in the formula for indicated horse power.

Let  $L$  = length of stroke in feet  
 $A$  = area of piston in square inches  
 $N$  = number of single strokes per minute or two times the number of revolutions

$$\text{Then indicated horse power (i. h. p.)} = \frac{P \times L \times A \times N}{33,000}$$

In estimating the mean effective pressure for any multiple expansion engine, it is customary to calculate the pressure that would be required if the work were all done in the low-pressure cylinder. This is called the mean effective pressure referred to the low pressure cylinder, and the calculation for horse power then becomes identical with the calculation for a single-cylinder engine. For a compound engine the referred mean effective pressure is

$$M. E. P. (\text{referred}) = \text{low-pressure } M. E. P. + \frac{\text{high-pressure } M. E. P.}{\text{ratio low pressure to high pressure}}$$

and for a triple expansion engine

$$M. E. P. (\text{referred}) = \text{low-pressure } M. E. P. + \frac{\text{intermediate pressure } M. E. P.}{\text{ratio low pressure to intermediate pressure}} + \frac{\text{high-pressure } M. E. P.}{\text{ratio low pressure to high pressure}}$$

Below is a table showing the arrangement for calculating the i. h. p. The particular engines were installed in a twin-screw car ferry. Each engine had cylinders 19, 31, and 53 ins. in diameter by 36 stroke, piston valves on the high and intermediate cylinders

with a double-ported slide valve on the low, Stephenson link motion air pumps attached to the intermediate crossheads, r. p. m. 92, and runs jet-condensing.

			Area Sq. In.	Length In.	Spring	M. E.P.	Area of Piston	I.h.p.	I.h.p. per Cyl.	I.h.p. Total
Starboard Engine	H.P.	Top	3.35	4.13	80	64.8	283.5	153.8		
	H.P.	Bottom	2.86	4.13	80	55.8	267.6*	125.1	278.9	
	Int. P.	Top	2.13	3.75	40	22.7	754.8	143.1		
	Int. P.	Bottom	2.07	3.75	40	22.1	738.9*	136.5	279.6	
	L.P.	Top	3.58	4.20	10	8.52	2124	151.1		
	L.P.	Bottom	3.45	4.20	10	8.24	2108*	145.8	296.7	855.2
Port Engine	H.P.	Top	3.37	4.11	80	65.5	283.5	155.2		
	H.P.	Bottom	3.03	4.11	80	59.4	267.6*	132.8	288.0	
	Int. P.	Top	2.20	3.78	40	23.3	754.8	147.0		
	Int. P.	Bottom	2.18	3.78	40	23.1	738.9*	142.8	289.8	
	L.P.	Top	3.47	4.12	10	8.44	2124	150.8		
	L.P.	Bottom	3.40	4.12	10	8.26	2108*	145.7	295.7	873.5
Total										1728.7

\* Assuming piston rod =  $4\frac{1}{2}$  inches diameter and no tail rods.

To Calculate the Coal Consumption per I. H. P. per Hour.—The data necessary are: indicator cards from the engine, revolutions per minute, and coal consumed during the run. From the indicator cards the mean effective pressure may be determined and the i. h. p. for one end of the cylinder can be calculated from the formula  $\frac{P L A N}{33,000}$  (where  $N$  is one half the number of revolutions), and of the other end in the same way. The sum of the two gives the total horse power for the cylinder. Knowing the pounds of coal consumed per hour, this quantity divided into the total i. h. p. per hour gives the pounds consumed per i. h. p. per hour. See also Fuels.

## ENGINE FORMULÆ

## Estimated Horse Power.

$D$	= diameter of low-pressure cylinder in inches	
$S$	= stroke of piston in inches	
$P$	= absolute boiler pressure	
$R$	= revolutions per minute	
$Z$	= coefficient for warships	85,000
	short passage express steamers	91,000
	long passage express steamers	94,500
	passenger cargo steamers	97,000
	cargo steamers	105,000

Estimated Horse Power =  $\frac{D^3 \times \sqrt{P} \times S \times R}{Z}$ . This formula gives a very close approximation to the horse power actually indicated when at full speed.

From A Manual of Marine Engineering, A. E. Seaton.

**Shafting.**—A hollow shaft is stronger than a solid one of the same sectional area. A shaft will stand twice as much torsional stress as bending stress, the constant for torsion being 5.1 and for bending 10.2.

Lloyd's Rules state: Diameter of crankshaft and of thrust shaft under collars to be at least  $\frac{21}{20}$  of that of the intermediate shaft (see table below); thrust shaft may be tapered down at each end to same diameter as intermediate shaft. Diameter of screw (tail) shaft to be equal to diameter of intermediate shaft  $\times \left( .63 + \frac{.03P}{T} \right)$  but in no case to be less than  $1.07 T$ , where  $P$  is diameter of propeller shaft and  $T$  diameter of intermediate shaft both in ins.

- Let  $A$  = diameter of high-pressure cylinder in inches  
 $B$  = diameter first intermediate-pressure cylinder in inches  
 $C$  = diameter second intermediate-pressure cylinder in inches  
 $D$  = diameter low-pressure cylinder in inches  
 $S$  = stroke of pistons  
 $P$  = boiler pressure above atmosphere in pounds per square inch

#### DIAMETER OF INTERMEDIATE SHAFTS

Type of Engine	Diameter of Intermediate Shaft in Inches
Compound, 2 cranks at right angles...	$(.04 A + .006 D + .025) \times \sqrt[3]{P}$
Triple, 3 cranks at equal angles...	$(.038 A + .009 B + .002 D + .0165 S) \times \sqrt[3]{P}$
Quadruple, 2 cranks at right angles...	$(.034 A + .011 B + .004 C + .014 D + .0165 S) \times \sqrt[3]{P}$
Quadruple, 3 cranks.....	$(.028 A + .014 B + .006 C + .0017 D + .0155 S) \times \sqrt[3]{P}$
Quadruple, 4 cranks.....	$(.033 A + .01 B + .004 C + .0013 D + .0155 S) \times \sqrt[3]{P}$

The number of collars on a thrust shaft is roughly one collar up to 5 ins. diameter of shaft, and an extra collar for every 1.8 ins. dia.

$$\begin{aligned} \text{or number of collars} &= 1 + \frac{\text{dia. shaft} - 5}{1.8} \text{ for merchant vessels} \\ &= 1 + \frac{\text{dia. shaft} - 5}{1.25} \text{ for war vessels} \end{aligned}$$

To find the diameter of the collar,

$D$  = dia. of collar

$d$  = dia. of shaft

$N$  = number of collars

$P$  = allowable pressure in lb. per sq. in.

See Thrust Bearing.

Total thrust ( $T$ ) = total area  $\times$  allowable pressure

$$= \frac{\pi}{4} \times N(D^2 - d^2) \times P$$

$$\text{Then } D = \sqrt{\frac{T}{P \times \frac{\pi}{4} \times N} + d^2}$$

Thickness of collars = .4 ( $D-d$ )

**Cylinders.**—For ratio of diameters see page 294. If the cylinders are to be steam jacketed then liners are necessary. For a cylinder without a liner the following formula may be used.

$t$  = thickness of walls in ins.

$P$  = max. pressure in cylinder

$D$  = dia. of cylinder

$$t = \frac{(P + 25) D}{6000} + \frac{40}{100 + D}$$

When a liner is used the inner surface of the cylinder barrel  $C$  will have a diameter equal approximately to  $D + 2L + 2J$ , where  $D$  = dia. of the cylinder,  $L$  = thickness of the liner, and  $J$  = width of jacket space, which is usually  $\frac{3}{4}$  or 1 in.

**Connecting Rod.**—Length  $4\frac{1}{2}$  to 5 times the length of the crank. Diameter at upper end same as diameter of the piston rod, area of section at lower end 1.2 to 1.3 that of the piston rod.

$D$  = dia. at middle of rod in ins.

$L$  = length from center to center in ins.

$$K \text{ for merchant vessels} = .028 \sqrt{\text{effective load on piston in lb.}}$$

$$K \text{ for war vessels} = .022 \sqrt{\text{effective load on piston in lb.}}$$

$$\text{Then } D = \frac{\sqrt{L \times K}}{4}$$

## Piston Rod—

$p$  = greatest pressure on piston in lb.

$F$  = a coefficient — naval engines..... 50  
 merchant ordinary stroke..... 45  
 merchant long stroke..... 42  
 merchant very long stroke..... 41

$$\text{Dia. of rod} = \frac{\text{Dia. of cylinder}}{F} \times \sqrt{p}$$

Another formula for the piston rod diameter is:

$$5\sqrt{\frac{\text{I. H. P. of one cylinder}}{2 \times \text{length of stroke} \times \text{rev. per min.}}}$$

**Pistons.**—Often of cast steel dished or conical in form and of a single thickness of metal. The pistons of compound and triple expansion engines should as a rule have the same total depth, thus giving a steep angle to the high pressure and a flat to the low, the latter being not less than about 1:5.

**Bearing Surfaces.**—Allowable pressure in lbs. per sq. in. of projected surface using mean loads.

	Merchant vessels	Naval
Crank pin.....	200- 250	250- 300
Main bearings.....	200- 350	250- 500
Using Maximum Loads:		
Slipper guides.....	60- 80	70- 100
Crosshead pins.....	850-1200	1200-1800
Link block pin.....	750-1000	850-1200
Link block gibs.....	250- 400	350- 500
Eccentric rod pins.....	700- 950	900-1100
Drag rod pins.....	500- 700	700- 800
Eccentrics.....	150- 200	175- 225
Thrust collars.....	50- 80	80- 100

[Several of above formulae from Marine Engine Design, by Bragg.]

## ENGINE FITTINGS AND ACCESSORIES

**The Throttle Valve** is for controlling the steam to the engine and is attached to or placed close to the high-pressure cylinder. For ease in quick operating some form of a balanced or power valve is necessary.

Of the balanced type may be mentioned the double-beat, poppet, the butterfly, and the balanced piston. The former has two disks, the upper being slightly larger than the lower. The chief difficulty is to keep the disks tight, as the variations in temperatures tend

to seat the disks unequally. Butterfly valves have an elliptical disk with a spindle in the center. This type is well balanced but is difficult to keep tight. Throttle valves with balance pistons have such pistons attached to the valve stem, the piston working in a cylinder in which steam is admitted, although the valve itself is operated by hand.

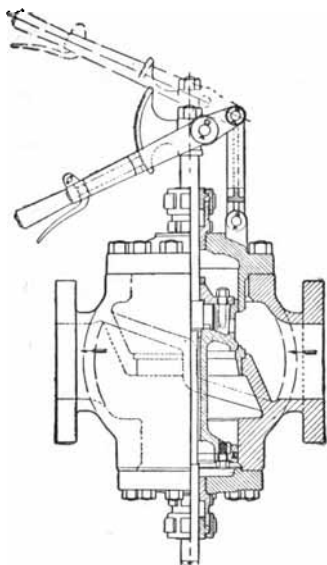

Figure 71.—Throttle Valve. [Schutte & Koerting, Phila.]

Of the power type, this consists of a separate power unit operated by steam and connected by links to the throttle valve which is controlled entirely by the power unit.

**Cylinder Drains and Relief Valves.**—As water collects in the steam chests and cylinders, drains and relief valves are fitted. The former are placed as low as possible, and are connected to a common pipe leading to the bilge or to the feed tank. Relief valves serve as safety valves, relieving the cylinders from excessive pressure by automatically opening and allowing the water to be discharged.

**Starting or Pass-Over Valves.**—To assist in starting the engine, particularly if the high-pressure crank is on or near the dead center,

a valve and pipe are provided for admitting steam direct from the steam pipe or high-pressure valve chest to the first receiver or intermediate valve chest. This will give sufficient load on the piston of the intermediate cylinder to start the engine. Either cocks or small slide valves are used, that can be opened wide by a single stroke of the lever.

**Reversing Engine.**—May be direct acting or the all around type, usually the former. Diameter of reversing cylinder .185 to .2 the diameter of the low pressure cylinder of the main engine. The direct acting consists of a steam cylinder mounted on one of the engine columns, that is, connected by rods to the links of the Stephenson valve gear. The operating lever is located close to the one on the throttle valve. Below is a table of sizes of reversing and turning engines:

Engine	I. h. p.	Reversing Engine	Turning Gear
$\frac{17 \times 27 \times 44}{30}$	1,000	9 ins. dia. $\times$ 16 ins. stroke	Worm and wheel
$\frac{23\frac{1}{2} \times 39\frac{1}{4} \times 63}{45}$	4,000	12 ins. dia. $\times$ 24 ins. stroke	Worm and wheel
$\frac{20 \times 49 \times 84}{54}$	4,100	14 ins. dia. $\times$ 24 ins. stroke	Eng. 5 in. dia. $\times$ 6 in. stroke
$\frac{29\frac{1}{2} \times 47\frac{1}{2} \times 2-58}{42}$	4,800	12 ins. dia. $\times$ 18 ins. stroke	Twin-cylinder engine each $4\frac{1}{2}$ ins. dia. $\times$ 5 ins. stroke

**Turning Gear.**—When steam is shut off, it may be necessary to turn the engine. This is done by means of a large wheel, keyed to the shaft or shaft coupling, that is driven by a worm gear, which may be turned by hand or, as in the case of large engines, by a small high-speed engine. See table above.

**Steam Separators.**—These are designed to remove water from the steam, and to prevent it from entering the high-pressure cylinder. This may be accomplished by having the steam enter a casting larger in diameter than the steam pipe, and causing it to make a sharp turn around a baffle plate; or giving the steam a whirling motion by having it come in contact with spiral plates riveted to a cylinder. In the latter case, the particles of water are thrown out by centrifugal force, falling to the bottom of the separator, and are drained off to a trap.

**Lubricating System.\***—Only the best oil, which has been filtered, should be used. See Lubricating Oil. In many engines there is a forced feed system, with a pump that is driven by the main engine, small copper pipes leading to the guide faces, crank, and piston ends of the connecting rods, and to the eccentrics. The main bearings should be oiled so there is a film of oil between the shaft and the Babbitt metal.

No internal lubrication of the cylinders is necessary other than the swabbing of the rods and the wiping out of the cylinders and vaselining them when they are opened. The addition of a small quantity of graphite from time to time as the cylinders give indications of becoming dry is advisable, but when they have once obtained a good surface there is no need of further lubrication.

Usually crank pins and eccentric straps should be oiled by hand once every 20 minutes; main bearings, link gear, etc., once every half hour. An inspection of the thrust bearing, spring bearings, and stern tube gland should be made every half hour, and the piston rods swabbed perhaps every 45 minutes.

For a triple expansion engine with cylinders 18, 29 and 47 ins. diameter by 30 stroke, of 1,000 i. h. p., the following lubricating equipment was specified: "A brass manifold shall be located on each cylinder provided with wicks and brass tubes leading to principal journals. Crank pins to be oiled by cups and tubes carried on connecting rods and taking oil from drip overhead. Cross head guides oiled by tubes leading from manifolds. Each eccentric strap to be oiled by cup and tube carried on the eccentric rod. Reverse shaft bearings to be fitted with compression grease cups. A swab cup shall be fitted to each housing for swabbing the piston rods and valve stems. All fixed bearings shall have drip cups. All moving parts shall have drip cups made of sheet brass, cast brass, or copper with brazed seams.

**Water Service.**—The water is often supplied from the circulating pump inlet and is pumped through the main bearing jackets and cross head guides. The piping is of brass or copper. A hot bearing is not always due to lack of lubrication or to a poor water service, but may be caused by the shafting being out of line.

For a triple expansion engine of the size given under the heading, Lubricating System, a water service as outlined below was specified. "From the main supply pipe there will be one ½-inch branch, with double swivel joint for each crank shaft bearing.

\* Abstracts from Care of Naval Machinery. H. C. Dinger.



"Two  $\frac{3}{4}$ -inch pipes to each crank pin, extending across on each side perforated on the bottom.

"One  $\frac{3}{4}$ -inch pipe to each cross head guide.

"One  $\frac{1}{2}$ -inch pipe to each pair of eccentrics, with double swivel joints.

"Two  $\frac{3}{4}$ -inch pipes to spring bearings.

"Each of the above branches shall have a separate valve and shall terminate either on a pivoted nozzle or a permanent connection to the part that is to be cooled, as required. All water service pipes shall be of brass.

"The water service pipe shall be connected so as to be supplied with sea water from the inlet chest of the salt water side of the condenser and to the sanitary pump. There shall be valves at these branches.

"There shall also be a steam connection for blowing out."

**Thrust Bearing.**—Directly aft of the crank shaft is the thrust shaft and its bearing, the object of which is to prevent fore and aft movement of the shafting due to the thrust of the propeller. The thrust is taken care of by collars on the shaft that bear against shoes on the thrust bearing that may be of cast iron, cast steel, or brass with a bearing surface of white metal. The collars must run in a bath of oil which is kept cool by salt water supplied by the sanitary pump circulating in the bottom of the bearing.

The mean normal thrust = i. h. p.  $\times \frac{217}{\text{speed in knots per hour}}$

The surface exposed to the thrust should be such that the pressure per square inch does not exceed 80 lb., while for tug boats and ocean-going vessels it should be about 50 lb. For the number and diameter of the collars see page 413. The following is data on a

$\frac{21\frac{1}{2} \times 30\frac{3}{4} \times 44\frac{1}{2} \times 64}{36}$  engine. Diameter thrust 12 in., thrust

bearing of cast iron with cast iron shoes faced with babbitt and fitted for water circulation; thrust pressure was taken by 4 collars with unit pressure of 60 lb. per square inch.

**Air Pump.**—This may be driven by a lever, one end of which is fastened to the upper end of one of the connecting rods of the main engine or it may be independent. See Steam Plant Auxiliaries.

**Line Shaft or Spring Bearings.**—Their chief function is to support the shafting. They are of cast iron with a lower brass or bearing piece fitted with white metal. A bearing cap or cover forms the top portion in which are grease cups or other lubricating

devices. In long lines of shafting the spring bearings are placed on each side of the shaft couplings, being at a sufficient distance so that the coupling bolts may be easily removed.

**Engine Room Floors.**—Preferably of wrought iron checkered plates instead of steel, as the former will not polish so readily by wear. These plates are supported by angle iron frames fastened to the ship's frames. The most comfortable non-slipping floor under the conditions of greasy surface and heavy weather is sheet lead. The underlying wood platform should be laid so all joints are smooth. The sheet lead is about 8 lb. per square foot or  $\frac{1}{8}$  in. thick, and is fastened down by copper nails. Care must be taken not to put heavy weights directly on top of the lead, but on mats.

#### OPERATING \*

"About an hour before the time set for getting under way, start to warm up the engine. The length of time depends on the size of the engine, for large engines more than an hour may be required and for small less.

"See that all tools, material, etc., are clear of the engine.

"Start circulating pump, making sure that the injection and discharge valves are open.

"See that all parts of the engine are in place and properly secured. Disconnect jacking gear.

"Start main air pumps and open main exhaust valves to condenser if these valves are fitted.

"Open bulkhead stops.

"Open drains to main steam line. Drain separator.

"Open boiler stop valves, just cracking them at first and then open them gradually.

"Get reversing engine ready and turn steam in it.

"Turn steam on jackets and drain them. Open cylinder drains.

"The steam being up to the throttle, move links back and forth with the reversing engine and crack open the throttle slightly. This allows a little steam to pass into the high-pressure cylinder and warms it up. Crack open pass-over valves to allow steam to enter intermediate-pressure and low-pressure cylinders.

"Circulate water through thrust bearing and slides.

"See that feed pumps are in proper condition and try all that are to be used.

\* From Care of Naval Machinery. H. C. Dinger.

"Make an inspection to see that there is plenty of steam, good fires and everything about the engines is ready.

"Get permission to try engines 15 or 20 minutes before the time set to be ready.

"Try engine both going ahead and astern and see that it reverses easily. Care must be taken not to open the throttle too wide, otherwise the engine will develop sufficient power to break the mooring lines if tied to a pier.

"The following causes may prevent the engine from working satisfactorily:

"**Water in Cylinders.** This will prevent the piston moving its full travel. The water must be got rid of by opening the drains, and moving the piston back and forth by the reversing gear until the water is out.

"**Engine on Center.** This can be guarded against by taking care when the engine is stopped that the high-pressure crank is near the middle of the stroke.

"**Valve Rods Sticking.** They may be loosened by applying oil, loosening the stuffing box or the valve stem guide.

"**Throttle** must not be suddenly opened or closed but the engine should be worked up to full power gradually.

"**Reversing.** The throttle should first be closed and engine then reversed—under ordinary conditions. However, if the emergency signal is received, the engine should be immediately reversed.

"When under way a great deal concerning the proper running of an engine can be told by the sounds heard in the engine room, as they tend to combine into a sort of *rhythm*, and from it the experienced engineer can readily tell whether the different apparatus is working properly.

"The chief sound is the heavy thump caused by the pounding of the main bearings. This can be located by noting which crank has just passed the center when the thump is heard. The main bearing will have a duller sound than the crank pin or cross head. The cross head knock is a sharper sound and is not heard at so great a distance.

"Often lost motion can be told by feeling of the bearings.

"A valve loose on its stem or piston loose on its rod causes a solid, sharp thump or a dull click.

"On starting up or slowing down, slide valves are apt to rattle or cause a clicking sound due to lack of pressure on their backs.

"Pounding may be caused by: (1) Too much clearance in a journal, slide or connection.

"(2) The use of too light oil on heavy pressure.

"(3) Power not equally distributed among the cylinders.

"(1) Can be remedied by readjusting and in part by slowing down or changing the speed.

"(2) Use heavier oil.

"(3) Readjust the cut-off."

## TRIALS

*Noronic*, passenger steamer, 362 ft. between perpendiculars, beam molded 52 ft., depth molded 28 ft. 9 ins., engine  $\frac{29\frac{1}{2} \times 47\frac{1}{2} \times 2 - 58}{42}$ ,

4 boilers each 15 ft. 6 ins. diameter by 11 ft. long.

Displacement.....	5,412	tons
Area, immersed midship section.....	776.5	sq. ft.
Wetted surface.....	21,800.	sq. ft.
Draft, forward.....	11 ft. 3 ins.	
Draft, aft.....	18 ft. 1 in.	
Draft, mean.....	14 ft. 8 ins.	
Speed, miles per hour, average.....	17.43	
Slip of propeller.....	11.6%	
Steam pressure.....	192.	lb.
First receiver pressure.....	73.	lb.
Second receiver pressure.....	15.5	lb.
Vacuum.....	23.93	ins.
Revs. per min.....	106.	
Indicated horse power, high-pressure cylinder.....	1,169.6	
Indicated horse power, intermediate-pressure cylinder.....	1,505.7	
Indicated horse power, low-pressure cylinder aft.....	711.5	
Indicated horse power, low-pressure cylinder forward.....	771.2	
Total indicated horse power.....	4,158.	
Mean effective pressure referred to low-pressure cylinder.....	34.2	lb.
I. h. p. per sq. ft. of grate.....	13.5	
Sq. ft. of heating surface per i. h. p.....	3.16	
Temperature of injection water.....	40°	
Temperature of hotwell.....	110°	
Temperature of feed from heater.....	200°	
Draft ins. of water at fans.....	3.73	
Trial lasted 6 hours.		

*Noronic* owned by Northern Nav. Co., Sarnia, Ont. Built 1914.

*Huron*, freight steamer, 439 ft. 3 ins. length over all, on keel 416 ft.,

beam 56 ft., molded depth 30 ft., engine  $\frac{19\frac{1}{2} \times 28\frac{1}{4} \times 41 \times 60}{42}$ , two

Scotch boilers each 14 ft. 9 ins. diameter by 12 ft. long.

Trial draft 18 ft. 6 ins. for'd and 19 ft. 6 ins. aft, and was loaded with 4,660 tons.

Boiler pressure.....	208.	lb.
First intermediate receiver pressure.....	86.	lb.
Second intermediate receiver pressure.....	37.5	lb.
Low pressure receiver pressure.....	9.1	lb.
Vacuum.....	21.2	ins.
R. p. m.....	84.9	
Piston speed, ft. per min.....	594.3	
Mean effective pressure, high-pressure cylinder....	81.7	
Mean effective pressure, first intermediate cylinder.	36.	
Mean effective pressure, second intermediate cylinder.....	14.97	
Mean effective pressure, low-pressure cylinder.....	10.38	
Mean effective pressure, referred to low-pressure cylinder.....	34.	
Indicated horse power, high-pressure cylinder.....	440.	
Indicated horse power, first intermediate cylinder..	406.	
Indicated horse power, second intermediate cylinder	356.	
Indicated horse power, low-pressure cylinder.....	529.	
Total indicated horse power.....	1,731.	
Ratio i. h. p. to grate area.....	16.	
Ratio heating surface to i. h. p.....	2.9	
Temperature of injection water.....	56°	
Temperature of stack.....	425°	
Temperature of hot well.....	129°	
Temperature of feed water.....	178°	
Draft at fan, ins. of water.....	1.57	
Coal consumption per hour.....	2,652.	lb.
Coal consumption per i. h. p. per hour.....	1.51	lb.
Speed in miles per hour.....	11.89	
Trial 8 hrs. 17 mins.		

*Huron* owned by Wyandotte Trans. Co., Wyandotte, Mich.  
Built 1914.

U. S. Torpedo Boat Destroyer *Cushing*, 300 ft. between perpendiculars, 31 ft. 1 in. beam, 17 ft. 1 in. molded depth, twin-screw Curtis turbines, 4 oil-burning Yarrow boilers, closed fireroom, forced draft.

Displacement.....	1,048	tons
Draft.....	9 ft. 5 ins.	
Speed.....	29.183	knots

Main turbines developed a total of 15,280 h. p. at 576 r. p. m.  
Evaporation of the boilers was 11.31 lb. per hour per sq. ft. of

heating surface, 15.61 lb. per hour per shaft horse power and 12.46 lb. per hour per pound of oil.

Oil consumption 1.259 lb. per s. h. p.

Trial, 4 hours. Built 1915.

Cattle steamer, 435 ft. between perpendiculars, 46 ft. beam, depth to main deck 37 ft. 11 ins., draft 27 ft. 10 ins., displacement 11,000 tons, wetted surface 36,050 sq. ft., draft to 27 ft. 10 ins.,

block coefficient .69, engine  $\frac{30\frac{1}{2} \times 48 \times 79}{60}$

I. h. p. ....	2,600	
R. p. m. ....	53.7	
Steam pressure .....	183	lb.
Steam first receiver .....	67.5	lb.
Vacuum .....	24	ins.
Speed .....	11.4	knots
I. h. p. per 100 sq. ft. wetted surface at 10 knots...	4.87	
Coal burned per hour .....	4,390	lb.
Coal per i. h. p. main engine per hour .....	1.68	lb.
Coal per sq. ft. grate per hour .....	17.1	lb.

The above data is the average of a 3,000 mile run.

*Bristol*, cargo steamer, 9,630 tons displacement, mean draft 24 ft.

9 ins., engine  $\frac{23\frac{1}{4} \times 38\frac{1}{2} \times 67}{45}$

I. h. p. ....	1,795	
R. p. m. ....	75	
Speed .....	10.78	knots
Vacuum .....	27	ins.
Air pressure at fan .....	1.3	ins.
Average boiler pressure .....	162.5	lb.
Temperature of gases base of stack .....	496°	
Trial 54 hours. 1916.		

*Pacific*, cargo steamer, for dimensions see table of Turbine Steamers. The trial lasted three hours at sea, with a full cargo of 8,300 tons aboard.

Draft .....	25	ft.
Speed .....	11.5	knots
Horse power .....	2,655.	
R. p. m. ....	87.	
Steam at turbine .....	207	lbs.
Temperature superheated steam (F.) .....	420°	
Temperature saturated steam .....	385°	
Temperature feed water .....	180°	
Temperature in stack .....	672°	
Vacuum .....	28	ins.
Pounds of oil per horse power hour .....	.875	
B. t. u. per horse power hour .....	16,420.	

*City of St. Louis*, passenger and freight, 397 ft. between perpendiculars, 49 ft. 6 ins. beam, gross tonnage, 6,200, engine  $\frac{26 \times 43 \times 72}{48}$ , 4 Scotch boilers, steam allowed 180 lb. At 61.8

r. p. m., steam 130 lb., engine developed 1,219 i. h. p.

Lb. of steam per hour	15,276
Lb. of steam per rev.	4.12
Lb. of steam per i. h. p. (1,219)	12.5
Propeller thrust	16.82 tons

At 80 r. p. m., steam 155 lb., engine developed 2,843 i. h. p.

Lb. of steam per hour	30,816
Lb. of steam per rev.	6.42
Lb. of steam per i. h. p. (2,843)	10.8
Propeller thrust	35.55 tons

At a boiler pressure of 152 lb., the intermediate receiver pressure was 23 lb. gauge, and low pressure 1.5 lb., vacuum 28 ins., barometer reading 29.7 ins., revs. of engine 67.3, i. h. p. 1,386.51.

Ocean Steamship Co., New York.

Steamer built in 1910, above data in 1914, on a trip from Norfolk to New York.

## PROPELLERS

**Definitions.**\*—A propeller is right- or left-handed as it turns with or against the hands of a watch when looked at when standing aft and the ship is being driven forward.

The face or **driving face** of a blade is at the rear. It is the face that acts on the water and so receives the forward thrust.

The **back** of a blade is the forward side.

**Leading and following edges** of a blade are the forward and after edges respectively when going ahead.

The **pitch** is the longitudinal distance which a vessel would travel at one revolution of the propeller, were the propeller to revolve in an unyielding medium, as, for example, in a fixed nut.

The **diameter** is the diameter of the circle swept by the tips of the blades.

**Pitch ratio** is the pitch divided by the diameter. For ordinary reciprocating engines the pitch ratio is from .8 to 1.4, but in nearly all turbine installations it is .8 or .9.

For high speed vessels the blades are elliptical in shape, with the greatest breadth about one third from the tip. For towing the blades are very broad at the tips.

\* Abstracts from Practical Marine Engineering.

The **developed area** or helicoidal area of a blade is the actual surface of the driving face.

**Projected area** is the area of the projection, on a transverse plane, of all the blades. In large ships it is usual to design the propellers for a pressure of not over 12 lb. per square inch of projected surface.

**Disk area** is the area of the circle swept by the tips of the blades.

The area of the propeller tip circle divided into the total expanded blade area is known as the expanded area ratio or **disk area ratio**, and is usually .3 to .4, but in propellers for turbines the ratio varies from .4 to .8 owing to the necessity for crowding the required blade surface into a small disk area. Below is a formula for calculating disk area ratio.

Let  $R$  = revolutions per minute  
 $D$  = diameter of propeller in feet  
 $H$  = horse power per propeller  
 $S$  = speed in knots per hour  
 $C$  = coefficient of .30

$$\text{The disk area ratio} = C + \frac{R}{10,000} \sqrt[4]{\frac{DH}{S}}$$

In the table on page 426 the calculated  $DAR$  (disk area ratio) was calculated with a coefficient of .30, and it will be noted that the results obtained are very close to the actual disk area.

**Number of Blades.**—Three blades for warships and four for merchant. If the dimensions of a three-blade and a four-blade wheel are the same, it will take 25 to 30% more power for the same number of revolutions to drive the four-blade than the three. Two blades are objectionable on account of the excessive vibration caused by them.

**Cavitation.**—This is the failure of supplying water to a propeller, due to excessive blade velocity; in other words the speed of the blades exceeds the speed of the water flowing to them, therefore the effective thrust falls off in proportion, as cavities form at the sides of the blades.

**Slip.**—The apparent slip is the difference between the speed of the propeller and of the vessel. As a propeller works in a yielding medium the speed of the vessel is less than the speed of the screw.



Name	Total I. H. P. or E. H. P.	Speed Per Knots	Average Revs. Per Min.	Propeller			Actual Disk Area Ratio	Coeff. based D. A. R. by Formulas	Remarks
				No. of Blades	Dis.	Pitch			
U. S. B. S. North Dakota	31,900	21.66	290	3	13.0	10.3	.54	.57	Twin screw, turbine.
U. S. B. S. Aransas	28,530	21.05	324	3	10.0	8.2	.58	.55	Quad. screw, turbine.
U. S. B. S. W.oming	31,440	21.22	319	3	10.0	8.2	.58	.55	Quad. screw, turbine.
U. S. B. S. Florida	40,500	22.08	364	3	9.6	8.5	.62	.60	Quad. screw, turbine.
H. M. Battleship	abt. 32,000	21.50	310	3	9.6	8.5	.51	.54	Quad. screw, turbine (approx. figure).
U. S. Scout Chester	23,960	25.90	603	3	6.0	6.0	.67	.67	Quad. screw, turbine.
Chinese Cruiser Pe-Hang	7,490	30.30	635	3	5.35	5.17	.61	.57	Triple screw, turbine.
U. S. T. B. D. Warrington	12,646	30.12	641	3	6.67	6.17	.66	.60	Twin screw, turbine.
U. S. T. B. D. Flosser	11,270	30.41	702	3	5.25	4.83	.69	.70	Triple screw, turbine.
U. S. T. B. D. Cassin	16,310	30.14	602	3	7.33	6.67	.68	.69	Twin screw, turbine.
U. S. Scout Salem	19,200	29.65	378	3	9.50	8.7	.62	.59	Twin screw, turbine.
U. S. T. B. D. Beale	11,800	29.65	783	3	5.25	4.83	.67	.70	Triple screw, turbine.
U. S. T. B. D. Preston	10,920	29.18	779	3	5.00	4.75	.68	.69	Triple screw, turbine.
U. S. T. B. D. Lamson	10,600	28.60	745	3	4.83	5.00	.69	.67	Triple screw, turbine.
U. S. T. B. D. Drayton	13,520	30.80	844	3	5.25	4.83	.69	.76	Triple screw, turbine (propulsive eff. low).
U. S. T. B. D. Benham	16,850	29.59	896	3	7.70	6.67	.69	.70	Twin screw, turbine.
U. S. T. B. D. Perkins	11,670	29.76	593	3	6.58	6.35	.65	.65	Twin screw, turbine.
U. S. T. B. D. Monaghan	12,410	30.45	817	3	5.25	4.83	.68	.72	Triple screw, turbine.
U. S. T. B. D. McCall & Burrows	13,163	30.66	816	3	5.27	4.83	.71	.73	Triple screw, turbine.
U. S. T. B. D. Patterson	12,822	29.69	782	3	5.25	4.83	.67	.71	Triple screw, turbine.
Chained Steamer	11,000	22.5	450	3	6.7	5.09	.57	.57	Triple screw, turbine.
Passenger Steamer Comden	4,530	19.0	352	3	5.0	4.5	.51	.54	Twin screw, turbine.
Crocker	7,180	16.71	243	3	10.4	8.2	.47	.47	Twin screw, turbine.
Center screw of Olympic	16,000	22.0	165	4	16.5	.....	.67	.57 (C = .4)	Triple screw, combination (approx. figures).
Center screw of liner	6,700	17.6	250	3	10.0	9.5	.59	.60 (C = .4)	Triple screw, combination.
H. M. S. Drake	31,400	24.1	123	3	19.0	23.0	.37	.43	Twin screw, reciprocating.
H. M. S. "County" Class	21,500	23.2	141	3	15.8	19.5	.41	.43	Twin screw, reciprocating.
U. S. B. S. Texas	28,373	21.05	121.6	3	18.65	20.0	.37	.43	Twin screw, reciprocating.
U. S. B. S. Delaware	26,900	21.42	126.8	3	18.25	19.75	.40	.43	Twin screw, reciprocating.
U. S. Scout Birmingham	14,700	24.00	191	3	12.5	15.3	.41	.45	Twin screw, reciprocating.
Liner	20,000	21.7	90	3	19.5	26.0	.40	.38	Twin screw, reciprocating.
Liner	22,000	19.5	90	4	21.0	24.0	.39	.39	Twin screw, reciprocating.
U. S. Collier Proteus	7,200	14.7	102	3	16.5	16.4	.42	.38	Twin screw, reciprocating.
U. S. Collier Veritas	6,900	14.0	99	3	16.0	16.4	.42	.38	Twin screw, reciprocating.
U. S. Collier Orion	6,940	14.5	95	3	16.6	15.0	.36	.38	Twin screw, reciprocating.
U. S. Collier Mars	4,150	13.2	99	4	14.75	14.25	.40	.37	Twin screw, reciprocating.
Motor Boat Daric II	170	26.0	1,120	3	1.95	2.07	.54	.51	Single screw, gasoline (petrol) racer.
U. S. Oil Barge (Gov't Ship)	178	6.23	206	3	6.75	3.5	.30	.38	Single screw.
Yacht	330	11.2	146	4	7.0	10.0	.35	.36	Single screw, reciprocating.
Yacht	101	0.1	194	4	4.63	6.23	.30	.35	Single screw, reciprocating.
Yacht	2.7	10.2	124	4	7.75	10.0	.31	.34	Single screw, reciprocating.
Yacht	2,840	15.0	161	4	9.3	10.4	.42	.39	Twin screw, reciprocating.

Let  $v$  = speed of the screw  
 $V$  = speed of the ship  
 $v - V$  = slip of the screw

$\frac{v-V}{v}$  = slip of the screw expressed as a fraction of the speed of the screw

Then  $\frac{v-V}{v} \times 100$  = percentage of slip

*Example.* A propeller having a pitch of 15 ft. and making 100 revolutions per minute would advance 1,500 ft. per minute without slip. If the actual speed of the ship is 12 knots, she would travel  $12 \times \frac{6,080}{60} = 1,215$  ft. per minute. The apparent slip is therefore  $1,500 - 1,215 = 285$  ft. per minute or  $\frac{285}{1,500} = .19$  or 19%.

The real or true slip is somewhat different from the apparent slip, in that the passage of the ship through the water causes some of the water astern to follow the ship. This current of water is called the wake, and its speed is dependent upon the shape of the afterbody of the ship. Since this current is moving in the same direction as the ship, the distance that the propeller advances through the moving water in a given time will be less than if the water were still. The slip through the moving water, or wake, is called the real or true slip, and is greater than the apparent slip. Suppose that the wake had a speed of 10% of the ship (it ranges from 10 to 20%), or 122 ft. per minute. The propeller would then advance through the wake at a speed of  $1,215 - 122 = 1,093$  ft. per minute, and the real slip would be  $1,500 - 1,093 = 407$  ft. per minute, or  $\frac{407}{1,500} = .27$  or 27%.

The difference between real and apparent slip may be expressed thus:

$$1 - S_r = (1 - S_a)(1 - W)$$

Where  $S_r$  = real slip  
 $S_a$  = apparent slip  
 $W$  = wake

For the case noted above  $1 - S_r = (1 - .19)(1 - .10) = .81 \times .9 = .729$ . Therefore  $S_r = .27$  or 27%.

The apparent slip varies from 5 to 30%, the average being about 10. Owing to the slip a propeller must be run at a higher number of revolutions than would otherwise be the case.

**Example.** In a certain ship the revolutions of the engine averaged about 78 a minute. The wheel was 14 ft. 6 ins. diameter and 15 ft. pitch, the speed of the steamer being 10 knots. Find the slip of the screw.

The apparent slip is  $\frac{\text{Pitch} \times \text{r. p. m.} - \text{speed in ft. per min.}}{\text{pitch} \times \text{r. p. m.}}$

$$= \frac{15 \times 78 - \frac{6,080 \times 10}{60}}{15 \times 78} = .134 \text{ or about } 13\frac{1}{4}\%.$$

**Formulae for Finding Slip, Speed, Revolutions, and Pitch of Propellers.\***

Where  $p$  = pitch of propeller in feet  
 $N$  = revolutions per minute  
 $V$  = speed in knots of ship  
 $s$  = slip ratio (that is, the apparent slip in per cent)

(1) To find the slip, having given the pitch, revolutions, and speed in knots.

$$s = \frac{p N - 101.3 V}{p N}$$

(2) To find the speed, having given the pitch, revolutions, and slip.

$$V = \frac{p N (1 - s)}{101.3}$$

(3) To find the revolutions, having given the speed, pitch, and slip.

$$N = \frac{101.3 V}{p (1 - s)}$$

(4) To find the pitch, having given the speed, slip, and revolutions.

$$p = \frac{101.3 V}{N (1 - s)}$$

**Approximate Rule for Finding the Pitch of a Propeller.**—The pitch of a propeller will equal the length of a circumference at the place where the slope of the face is  $45^\circ$ , or where it is equally inclined to the shaft and to the transverse direction. Starting near the shaft, the inclination to the longitudinal is small, but increases toward the tip, passing at some point through the value of  $45^\circ$ . At this point let the radius be  $r$ . Then the pitch of the propeller is equal to  $2 \times 3.1416 \times r$  very nearly.

\* From Practical Marine Engineering.

**To Find the Helicoidal and Projected Area of a Propeller in Place.**  
 —Stretch a large piece of ordinary brown manila paper smoothly over the driving face of one blade and press it down around the edges to get the contour. Trim the paper to the crease and calculate the area either by the trapezoidal or by Simpson's rule. If by the former and one breadth is located at the extreme tip, the area is the sum of half the tip and hub breadths plus all the others, multiplied by the distance radially between successive breadths. The projected area may be determined from the developed area with a reasonable amount of accuracy by either of two formulæ, the first proposed by S. Barnaby and the second by D. W. Taylor, chief constructor, U. S. N.

$$(1) \text{ Projected area} = \frac{\text{Developed area}}{\sqrt{1 + .0425 \frac{\text{Pitch}}{\text{Diameter}}}}$$

$$(2) \text{ Projected area} = \text{Developed area} \left( 1.067 - \frac{.229 \text{ Pitch}}{\text{Diameter}} \right)$$

The first is not accurate for pitch ratios (pitch divided by diameter), varying much from 1. The second holds over a range of pitch ratios from .6 to 2, which is all that is customarily met with.

**To Find the Thrust of a Propeller upon the collars of a thrust shaft,** use the formula:

$$\text{Total thrust in pounds} = \frac{\text{h. p. of engine} \times \text{propeller efficiency} \times 33000}{\text{speed of vessel in feet per minute}}$$

See also Thrust Bearing.

*Example.* A 120 h. p., internal combustion engine running at 450 r. p. m. drives a boat at 20 miles an hour. What is the total thrust in pounds upon the thrust collars.

Assume the propeller efficiency is about 60% and substituting in the above formula,

$$\frac{120 \times .6 \times 33,000}{20 \times 5,280} = \frac{2,376,000}{1,760} = 1,350 \text{ lb. which is the total thrust.}$$

### Wheels for Turbine Ships.

$R$  = revolutions of the screw per minute

$V$  = speed of the vessel in knots per hour

$S. h. p.$  = shaft horse power developed in the shaft and delivered to the screw

*E. T. P.* = effective thrust power = *S. h. p.* × suitable factor.  
The effective thrust is the power required to propel the vessel and is equal to the *S. h. p.* times a coefficient varying from .55 to .52. The effective thrust in pounds is given by the formula.

$$\frac{S. h. p. \text{ on one shaft} \times 33,000 \times .52 \text{ or } .55}{V \times 101.3}$$

$$\text{Diameter of propeller in feet} = \frac{\sqrt{\text{effective thrust in pounds}}}{C}$$

For value of *C* see following table.

Apparent slip of propeller per cent. = .0206 *R* + 12.

Pitch.—Suppose it is required to find the pitch of a propeller to drive a ship at 23 knots, the turbines making 520 revolutions per minute.

The apparent slip = .0206 × 520 + 12 = 22.712 per cent.

Speed of screw at 23 knots =  $23 + \frac{22.7}{100} \times 23 = 28.22$  knots.

Pitch =  $\frac{28.22 \times 101.3}{520} = 5.49$  ft., say 5 ft. 6 ins.

Pressure per square inch of developed surface = .00563 *R* + 7.5

Type of Vessel	Speed in Knots	Revolutions of Turbines per Minute	<i>E. T. P.</i> <i>S. H. P.</i>	Apparent Slip of Propeller Per cent	Pressure per Sq. In. on Developed Surface in Pounds	Ratio of Developed Surface to Disk Area	<i>C</i> = Coefficient for Diameter
Large ocean mail str.	24 to 25	190 to 200	.53	16.5	8.75	.....	23
Intermediate mail str.	21 to 23	330	.55	18.8	9.35	.55	24.6
Cross channel steamer	24	500 to 550	.53	20.5	10.3	.535	25
Fine-lined fast vessel..	28	760	.52	27.5	11.72	.73	30

**Taper in Propeller Boss.**—Taper of shaft hole in boss to be not less than  $\frac{3}{4}$  in. per foot.

**Propeller Key.**—Width of key =  $\frac{\text{shaft dia.}}{6} + .6$ . Thickness of key = width of key × .5.

**Propeller Nut.**—Diameter of nut = shaft dia. at screw × 1.5. Thickness of nut = shaft dia. at screw × .75. The nut is left handed for a right hand propeller, and right for a left hand.

**Motor Boat Propellers.**—Those in the following table have three blades. A two-blade should be about two inches larger in diameter to hold the engine to the same number of revolutions as a three-blade of the same pitch and style. The table is based on speed wheels up to and including 35 ins. in diameter, while above this size it is based on a towing wheel having broader tips.

Horse Power of Engine	Revolutions per Minute					
	300		400		500	
	Dia.	Pitch	Dia.	Pitch	Dia.	Pitch
	Ins.	Ins.	Ins.	Ins.	Ins.	Ins.
2	18	20	14	19	12	18
3	18	26	16	20	14	17½
4	20	26	18	22½	16	18
5	20	30	20	20	16	20
6	22	24	20	25	18	19
7	22	30	18	30	18	22
8	24	30	20	27	18	25
10	26	30	22	27½	18	28
12	28	28	24	26	20	25
14	28	30	26	30	22	24
16	30	30	28	28	24	24
18	30	33	28	30	24	26
20	30	36	30	30	24	28
22	30	39	30	31½	24	30
25	30	42	30	33	26	28
28	32	37	30	35	26	30
30	32	38	30	37½	26	32
32	32	39	32	31	28	30
35	34	39	32	32	28	32
38	34	40	34	32	30	30
40	34	41	34	33	30	31
42	34	42	34	34	30	32
45	34	43	34	35	30	33
50	38	38	36	33	30	35
55	38	40	36	34	30	37
60	40	38	36	35	30	39
65	40	40	36	36	32	33
70	40	42	38	36	34	32
75	42	42	38	38	34	34
80	44	42	38	40	34	36
85	44	44	40	38	36	34
90	46	44	40	40	36	36
95	46	46	42	40	36	38
100	48	46	42	42	38	38

The areas of all three blades of the speed and towing wheels are as follows:

Diameter, Ins.	Area Speed Wheel in Sq. Ins.	Area Towing Wheel, Sq. Ins.
12	45	...
14	63	...
16	78	...
18	99	...
20	126	...
22	159	180
24	193	212
26	229	247
28	267	290
30	309	340
32	353	390
34	399	440
36	451	490
38	...	545
40	...	600
42	...	660
44	...	730
46	...	800
48	...	870

Above data from Columbia Brass Foundry Co., New York.

For larger wheels see table of Merchant Ships, also the table on page 426.

Blade thickness if continued to shaft center line

$$= \sqrt{\frac{\text{shaft dia.}^2}{\text{number of blades} \times \text{boss length}} \times \text{constant } 4 + .5. \text{ Thickness at tip} = \text{constant } .04 \times \text{propeller dia. in ft.} + .4.$$

Diameter and length of boss = constant 2.7  $\times$  shaft dia. Boss diameter varies from  $\frac{1}{4}$  to  $\frac{1}{2}$  propeller diameter, curve of boss radius is taken with a radius equal to boss dia.  $\times$  .8.

[Formulae for Taper, Key, Blade thickness, etc., from Verbal Notes. J. W. M. Sothorn.]

#### WEIGHTS OF PROPELLERS

Weights of cast iron propellers are given in the table, but if the weight of any other material is wanted it can be obtained by the formula.

Weight of new wheel =

$$\frac{\text{weight of cast iron wheel} \times \text{weight per cu. ft. of new material}}{\text{weight per cu. ft. of cast iron}}$$

The pitch is  $1\frac{1}{2}$  times the diameter.

Dia., Ins.	Two Blades, Lb.	Three Blades, Lb.	Four Blades, Lb.
12	9	12	15
14	12	19	20
16	19	24	24
18	21	26	32
20	22	28	44
22	25	35	55
24	30	51	67
26	55	68	92
28	80	110	120
30	100	132	124
32	...	140	196
34	...	...	220
36	...	...	225
38	...	...	282
40	...	...	330
42	...	...	350
44	...	...	370
46	...	...	380
48	...	...	510
50	...	...	525
52	...	...	545
54	...	...	575
56	...	...	595
58	...	...	680
60	...	...	900
62	...	...	925
64	...	...	950
66	...	...	1,050
68	...	...	1,220
72	...	...	1,380
76	...	...	1,450
78	...	...	1,650
80	...	...	1,870
84	...	...	2,000
88	...	...	2,150
92	...	...	2,760
96	...	...	3,150
120	...	...	5,600
144	...	...	7,600
150	...	...	8,450

Sheriffs Mfg. Co., Milwaukee, Wis.

**Speed Table.**—This gives the speed in miles per hour of boats with propellers of ordinary pitches at common engine speeds, and also the percentages of slip and theoretical speed of the propeller. Four speeds are given for each pitch at each engine speed, corre-





## Pitch of Propeller in Inches

R. p. m.	Per Cent of Slip	Pitch of Propeller in Inches															
		14"	16"	18"	20"	22"	24"	26"	28"	30"	32"	33"	34"	36"	40"	45"	50"
600	Nose	7.06	9.09	10.23	11.36	12.50	13.64	14.77	15.91	17.05	18.18	18.75	19.32	20.46	22.75	25.57	28.41
	10%	7.16	8.18	9.20	10.27	11.25	12.27	13.29	14.32	15.34	16.36	16.87	17.39	18.41	20.46	23.01	25.57
	20%	6.37	7.27	8.18	9.00	10.00	10.91	11.82	12.73	13.64	14.54	15.00	15.46	16.37	18.18	20.46	22.75
	30%	5.57	6.36	7.16	7.95	8.75	9.54	10.34	11.14	11.93	12.73	13.13	13.52	14.32	15.91	17.90	19.89
650	Nose	8.62	9.85	11.08	12.31	13.54	14.77	16.00	17.24	18.47	19.70	20.31	20.93	22.16	24.62	27.70	30.78
	10%	8.76	9.97	11.08	12.19	13.29	14.40	15.52	16.62	17.73	18.28	18.84	19.94	21.66	24.62	27.70	
	20%	6.90	7.89	8.96	9.85	10.83	11.82	12.80	13.79	14.78	15.76	16.74	17.73	19.70	22.16	24.62	
	30%	6.03	6.89	7.76	8.62	9.48	10.34	11.20	12.07	12.93	13.79	14.22	14.65	15.61	17.23	19.39	
700	Nose	9.28	10.61	11.93	13.26	14.58	15.91	17.24	18.56	19.89	21.22	21.87	22.54	23.98	26.52	29.83	33.14
	10%	9.35	9.53	10.74	11.93	13.12	14.32	15.52	16.70	17.80	19.10	19.68	20.29	21.87	23.87	26.85	29.83
	20%	7.42	8.49	9.54	10.61	11.66	12.73	13.79	14.85	15.91	16.98	17.50	18.03	19.09	21.22	23.98	26.51
	30%	6.50	7.43	8.35	9.28	10.21	11.14	12.07	12.99	13.92	14.86	15.31	15.78	16.70	18.57	20.88	23.20
750	Nose	9.94	11.36	12.78	14.20	15.63	17.05	18.47	19.89	21.31	22.73	23.44	24.15	25.57	28.41	31.96	35.51
	10%	9.95	10.22	11.50	12.78	14.07	15.34	16.62	17.90	19.18	20.46	21.10	21.73	23.01	25.87	28.76	31.96
	20%	7.93	9.09	10.23	11.36	12.50	13.64	14.78	15.91	17.05	18.18	18.76	19.32	20.46	22.75	25.57	28.41
	30%	6.96	7.95	8.96	9.94	10.94	11.93	12.93	13.92	14.92	15.91	16.41	16.91	17.90	19.89	22.37	24.86
800	Nose	10.61	12.12	13.64	15.15	16.67	18.18	19.70	21.21	22.73	24.24	25.00	25.76	27.27	30.30	34.09	37.98
	10%	9.55	10.61	12.27	13.69	15.00	16.36	17.73	19.09	20.46	21.82	22.50	23.18	24.54	27.27	30.68	34.09
	20%	8.46	9.70	10.91	12.12	13.34	14.64	15.76	16.97	18.18	19.39	20.00	20.61	21.82	24.24	27.27	30.30
	30%	7.43	8.48	9.54	10.61	11.67	12.73	13.79	14.85	15.91	16.97	17.50	18.03	19.09	21.21	23.86	26.52
900	Nose	11.98	13.64	15.34	17.06	18.75	20.45	22.16	23.86	25.57	27.27	28.13	28.98	30.68	34.09	38.35	42.62
	10%	10.74	12.28	13.80	15.34	16.87	18.41	19.94	21.47	23.01	24.54	25.32	26.08	27.61	30.68	34.52	38.36
	20%	9.54	10.91	12.37	13.64	15.00	16.37	17.73	19.09	20.46	21.82	22.50	23.19	24.54	27.27	30.68	34.10
	30%	8.35	9.55	10.74	11.93	13.13	14.32	15.51	16.70	17.90	19.09	19.66	20.29	21.48	23.86	26.85	29.83
1000	Nose	13.26	15.15	17.06	18.94	20.83	22.73	24.62	26.52	28.41	30.30	31.25	32.20	34.09	37.98	42.62	47.35
	10%	11.93	13.63	15.34	17.05	18.76	20.46	22.16	23.87	25.57	27.27	28.13	28.98	30.68	34.09	38.36	42.61
	20%	10.61	12.12	13.64	15.15	16.66	18.18	19.70	21.21	22.73	24.24	25.00	25.76	27.27	30.30	34.10	37.98
	30%	9.28	10.61	11.93	13.26	14.58	15.91	17.23	18.57	19.89	21.21	21.87	22.54	23.98	26.52	29.83	33.15

From Columbia Brass Foundry Co., New York.

sponding to four percentages of slip. The percentage marked "None" indicates no slip and is the theoretical speed of the propeller. Thus a 20-inch diameter by 30-inch pitch wheel at 500 revs. per min. shows in the 30-inch pitch column a theoretical speed of the boat as 14.2 statute miles per hour.

To find the percentage of slip for a boat traveling 10 miles per hour, engine making 500 revs. per min., the propeller having a pitch of 28 ins., follow the column for 28-inch pitch down to the line 500; 10 miles per hour is not shown by the percentage of slip for 10.61 miles is 20% and for 9.28 is 30%; therefore the percentage for 10 miles would be about 25%.

For a new boat, knowing the revolutions of the engine and the desired speed in miles per hour, to find the pitch of the propeller, first estimate the percentage of slip according to the type of boat then for the known r. p. m. and percentage follow the line to the right to the figure nearest the desired speed. Follow the column up and the pitch will be found at the top.

### PADDLE WHEELS

In the old type of harbor and bay steamers the wheels consisted of iron frames with boards fastened transversely to them. The present practice is to have feathering paddles, the bottom of the floats being about one-third of the draft. The breadth of each paddle in side wheelers is about one-third the breadth of the steamer, while in stern wheelers the paddles are nearly the entire breadth.

**Formulas for Finding Slip, Speed, Revolutions, and Pitch of Paddle Wheels.\***

Where  $\pi = 3.1416$   
 $s$  = slip ratio  
 $V$  = speed in statute miles per hour  
 $N$  = revolutions per minute  
 $D$  = diameter of pitch circle

For the same properties as given under the section on Propellers.

$$(1) s = \frac{DN - 88V}{\pi DN}$$

$$(2) V = \frac{\pi DN(1-s)}{88}$$

$$(3) N = \frac{88V}{\pi D(1-s)}$$

\*From Practical Marine Engineering.

$$(4) D = \frac{88 V}{r N (1 - s)}$$

Immersion of floats should not be less than  $\frac{1}{8}$  their breadth and for general service should be  $\frac{1}{2}$ .

Number of floats varies with the diameter. With fixed radial floats the usual proportion is one for each foot of diameter, and if feathering, number of floats =  $\frac{\text{Diameter} + 2}{2}$  or  $\frac{60}{\sqrt{\text{revolutions}}}$

$$\text{Breadth of float} = \sqrt{\frac{\text{area}}{r}}$$

$$\text{Length of float} = r \sqrt{\frac{\text{area}}{r}}$$

In practice,  $r$ , the ratio of length to breadth, is 4 to 5 with fixed radial wheels and 2.6 to 3.0 with feathering.

#### PADDLE WHEELS

Speed, Knots	Indicated Horse Power	Area of Paddle, Sq. Ft.	Diameter to Centers of Paddles, Feet	Revolutions per Minute	Slip	Name
13.	717	12.55	23.9	21.8	.197	Nantucket
13.	902	19.56	18.9	29.0	.234	Uncatena
13.5	966	27.48	18.5	26.4	.141	Gay Head
18.3	2520	34.00	16.4	41.0	.155	
18.3	2680	34.10	17.0	47.0	.265	
18.8	3400	45.20	18.7	40.0	.170	Tashmoo
18.9	6472	48.00	24.5	33.3	.250	City of Erie

#### STEAM TURBINES

The fundamental difference in the operation of a reciprocating steam engine and a steam turbine is that in the former the steam does work by its pressure overcoming resistance, and in the latter the steam does work by its kinetic energy.

In turbines the velocity of the jet or jets is utilized to produce rotation of vanes. Velocity is produced in a steam jet only by expanding from one pressure to a lower one, so that regardless of the type of turbine there must always be a pressure drop to gen-

erate the velocity which is utilized. The velocity imparted to the jet may be utilized in two ways: (1) by impinging on a vane and driving the vane by impulse; or (2) by driving backwards the nozzle in which expansion has taken place owing to the reaction or kick-back of the steam in coming to a high velocity from a low one by expanding through the pressure drop. No. 1 is basic for impulse turbines and No. 2 for reaction turbines. If a large pressure drop is available, this means a high nozzle velocity, and in some cases it is difficult to utilize efficiently a high velocity, so recourse is had to making the pressure drop occur a small amount at a time, each drop in pressure and attendant increase in velocity being but a fraction of the over-all drop; this is known as pressure compounding.

The same result may be obtained by arranging several rows of vanes so that each row takes out a certain fraction of the velocity of the jet, as, for example, if a pressure drop of 150 lb. gives a

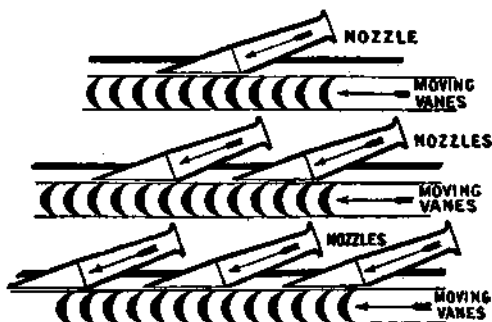
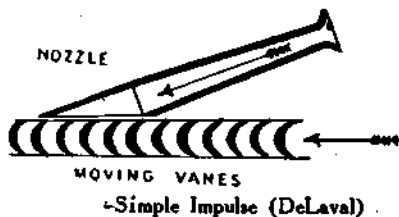

Figure 72.—Arrangement of Vanes.

nozzle velocity of 3,600 ft. per second, the peripheral velocity of one row of vanes, to utilize all of it, would be 1,700 ft. per second, but if there were four wheels, the velocity of each would be but one-fourth of this, or 425 ft. per second. This is called velocity compounding. (See Fig. 73.) Frequently both pressure and velocity compounding occur in one turbine, as, for instance, the Curtis type, where the turbine as a whole is of the compound pressure type with each pressure stage of the compound velocity type.

There are no turbines of the pure reaction type in commercial use. The turbine most commonly classed as of the reaction type is the Parsons (see Fig. 74) in which there is a small pressure drop in the first row of vanes, the reaction from which tends to cause the vanes to rotate away from the direction of discharge. In the next row the same action takes place, but the vanes being fixed, the jet impinges against the following rows of moving vanes which feel the compound effect of this impulse and the reaction due to the further expansion through the second moving row. This cycle is repeated throughout the rest of the turbine.

The usual number of expansions (this refers to large turbines of the Parsons type) is four in the high-pressure turbine, and eight in each low-pressure, the total number of rows of blades being the same for each separate turbine. Thus if the high-pressure turbine is made up of say four expansions, each containing 16 rows of blades, then each low-pressure turbine will have eight expansions, each containing eight rows of blades. A pair of rows, consisting of one row of fixed and one of moving blades, is usually called a stage. The sectional areas of the steam passages in Parsons turbines increase from the high pressure end to the low, so advantage is taken of the expansive properties of the steam.

(Above paragraphs from Int. Mar. Eng'g, 1916.)

In a modern triple expansion engine with cylinder areas of say high pressure to low pressure as 1 is to 7.5, and with a cut-off in the high pressure of one-third the stroke, the total number of steam expansions would be  $7.5 \times 3 = 22.5$ . In turbines the expansions of steam are much more than this, as 125 to 140 expansions are readily obtained. With a high-pressure turbine having an initial pressure of 150 lb. and a condenser vacuum of 29 ins. or back pressure of say 1 lb., the steam would expand about 150 times. Thus more work can be got out of the steam by the increased number of expansions, and hence the importance of having a high vacuum in the condensers.

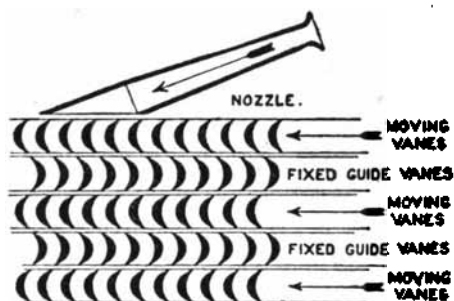

Velocity Compounding (A. E. G. (Small), Electric and Terry)

Figure 73.

Impulse turbines which are directly connected to generators for lighting consist of a row of nozzles which are fixed and a single row of moving vanes. For marine purposes they are not built much larger than 250 Kw. (See section on Electricity.)

In turbines the velocity of the steam is about 300 ft. per second or 18,000 ft. per minute.

An arrangement often adopted, in steamers of 400 ft. or so in length, is to install five turbines, three for ahead and two for reverse running. There are three shafts with one propeller on each,

#### NOTABLE SHIPS DRIVEN BY PARSONS TURBINES

Name	Length Feet	Displacement in Tons	Horse Power	Steam Consumption per s. h. p. Hour for All Purposes in Pounds	Speed in Knots	When Built
<i>Turbania</i> .....	100	44½	2,300	15.	32.75	1897
<i>King Edward</i> *	250	650	3,500	16.	20.48	1901
<i>H. M. S. Amethyst</i> .....	360	3,000	14,000	13.6	23.63	1905
<i>H. M. S. Dreadnought</i> .....	490	17,900	24,712	15.3	21.25	1906
<i>Mauretania</i> .....	785	40,000	74,000	14.4	26.	1907
<i>Aquitania</i> *.....	901	49,430	56,000	....	24.	1914

\* For further particulars see Turbine Ships.

the reversing turbines being placed within the low-pressure ahead casings. When running ahead the reverse turbines revolve inertly in a vacuum of 24 to 26 ins., and when going astern the ahead

turbines run in a vacuum. The transatlantic liner *Mauretania* has four shafts and six turbines. The extreme outboard shafts are driven by the high-pressure turbines, while the inboard are driven by the low-pressure, forward of which are the astern turbines. An arrangement of five turbines as installed in an English Channel steamer is as follows: Speed 22 knots, shaft horse power 6,500, boiler pressure 160 lb., high-pressure turbine 140 lb., low-pressure

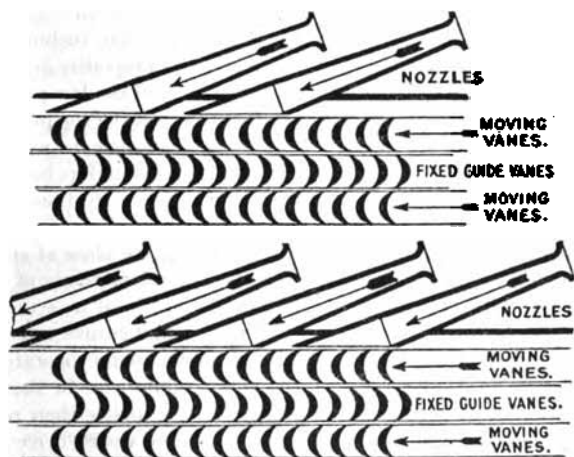

Pressure Compounding with Velocity Compounding  
(Curtis Marine Type and large A. E. G.)

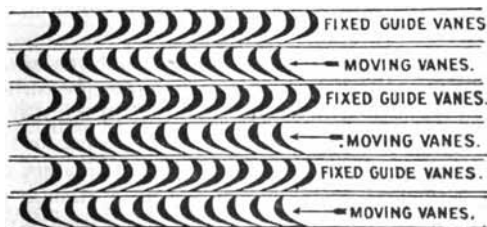

Reaction (Parsons)

Figure 74.—Arrangement of Vanes.



turbine port 20 lb., low-pressure starboard 20 lb., condenser vacuum 24½ ins., low-pressure port astern turbine 23 ins. vacuum, and the same for the low-pressure starboard astern, revolutions 630 per minute, propeller pitch 4 ft. 6 ins., slip 21%.

**Geared Turbines.**—In recent practice the driving of the propeller shaft by the turbine through intermediate gears has been tried in both merchant and war vessels. By means of gearing, a high-speed turbine occupying a small space can drive a large diameter propeller at a slow speed. This arrangement admits of economy at low ship speeds owing to the fact that turbines are more efficient when running at a high speed and propellers at a low. In single-screw vessels both the high-pressure and the low-pressure turbines have pinions meshing directly with the gear on the propeller shaft. Experience has shown that there is no reason to expect a loss of energy of more than 1½ to 2% in the gearing and its bearings.

For cargo steamers of 15 knots or under, geared turbines have proved satisfactory. At higher speeds few have been installed. Confining attention to vessels of the cargo carrying class at speeds below 15 knots, the margin between the several methods of propulsion (see table on page 496) is so small that local or economic conditions which have no bearing on engineering features are often the deciding factors. Geared turbines undoubtedly operate on increased steam economy, but there is little difference in the machinery weight and space, and the first cost is higher than reciprocating engines. Below is data on a cargo vessel driven by geared turbines. See also table of Turbine Ships.

Cargo vessel, 275 ft. long, 38 ft. 9 ins. beam, 21 ft. 2 ins. deep, draft 19 ft. 8 ins., displacement 4,350 tons. Two boilers 13 ft. diameter by 10 ft. 6 ins. long, heating surface 3,430 sq. ft., grate surface 98 sq. ft., steam 150 lb., natural draft, condenser cooling surface 1,165 sq. ft.

Two turbines in series, one high pressure and one low, former on starboard side and latter on port. High-pressure turbine 3 ft. diameter by 13 ft. over all; low-pressure 3 ft. 10 ins. diameter by 12 ft. 6 ins., the reversing turbine being in the casing for the low.

Gear wheel (cast iron) on propeller shaft, 8 ft. 3½ ins. diameter of pitch circle, 398 teeth double-helical with a circular pitch of .7854. Total width of face of wheel 24 ins., inclination of teeth 20° to the axis. Pinion shafts of chrome nickel steel, 5 ins. diameter of pitch circle with 20 teeth, .7854 circular pitch. Ratio of gear to pinion 19.9 to 1.

Propeller wheel 14 ft. diameter, 16.35 ft. pitch, expanded area 70 sq. ft.

Speed by log.....	10.22 knots
Revolutions per minute.....	70.6
Boiler pressure.....	140 lb.
High-pressure turbine, initial pressure.....	111 lb.
Vacuum in inches.....	28.4
Barometer, inches.....	29.88
Water, pounds per hour consumed by turbine.....	14,510.
Shaft horse power.....	960.
Water consumed in pounds per s. h. p.....	15.1

#### COMPARATIVE PERFORMANCE OF GEARED TURBINES AND RECIPROCATING ENGINES\*

Steamer 370 ft.  $\times$  51 ft.  $\times$  27.8 ft., 9,950 tons displacement, on 23.4 ft. mean draft, block coefficient .779. Single screw, driven by geared turbines. Three boilers, steam 180 lb., speed 10 knots. Name, *Cairncross*; type, cargo steamer.

Sister ship, same as above, but with reciprocating engines,  $\frac{24 \times 40 \times 66}{45}$ . Name, *Cairngowan*. Results of a 36-hour trial follow:

	Geared Turbines	Reciprocating Engines
Mean revs. of screw per minute.....	61.76	61.68
H. p. developed.....	1,570 s.h.p.	1,790 i. h. p.
Steam.....	138 lb.	140 lb.
Temp. of sea water F.....	50°	50°
Temp. of discharge from condenser....	70°	95°
Temp. of hot well.....	79°	104°
Temp. of feed water.....	203°	221°
Vacuum in condenser.....	28.75 ins.	26.80 ins.
Coal consumed per 24 hours, tons.....	27.8	32.7
Coal consumed per i. h. p. hour, lb....	1.45	1.704
Coal consumed per sq. ft. of grate, lb..	17.9	21
Water consumed per hour, lb.....	22,400	27,200
Water consumed per i. h. p. hour, lb...	12.57	15.18
Ash from coal as measured, per cent...	8.50	8.97

See also table of Comparative Performances of Different Systems of Propulsion.

The Föttinger hydraulic transmitter for turbines consists of a high-speed turbo-centrifugal pump with a water turbine designed for a low speed. The pump is coupled direct to the steam turbine,

\* From Marine Steam Turbines. J. W. M. Sothorn.

and the water turbine to the propeller shaft, both being in one casing so designed that frictional and eddy losses are reduced to a minimum. The transmission efficiency of this transformer is about 90%, and it has the advantage of being able to employ a non-reversible turbine.

In Alquist gearing, the gear is built up of a number of plates machined to a form which gives them the desired degree of lateral flexibility. Each disk or plate operates independently and is free to deflect laterally under the side pressure which results from its diagonal engagement with the pinion. A very small amount of this lateral deflection is sufficient to afford the desired distribution of the load, and this amount can be given without approaching dangerous periodic strains. With gears of the Alquist type very small teeth can be used without any danger of incurring excessive strains on the individual teeth. Alquist gears are built by the General Electric Co., Schenectady, N. Y. Below are tests of two steamers of the same size and model, both using oil fuel, one being driven by turbines with Alquist gears and the other by reciprocating engines.

	S. S. <i>La Brea</i> Alquist Gear	S. S. <i>Los Angeles</i> Reciprocating Engine
Average speed, knots .....	10.9	10.27
Total lbs. of oil used in steaming.....	8,270,000	7,310,000
Total shaft horse power hours.....	8,029,000	5,538,000
Lbs. of oil per shaft horse power hour....	1.03	1.32
Rev. of propeller per min.....	90	65

Steamers owned by Union Oil Co., Los Angeles, Cal.

**Turbo-Electric Propulsion.**—Here the turbine drives a generator which furnishes the current to an electric motor directly connected to the propeller shaft. Where a wide range of high efficiency is required for a variety of speeds, electric propulsion has proved satisfactory. The advantages of this method of propulsion are: the loss due to the electrical machinery is more than counterbalanced by the gains secured with high-speed turbines and suitable reduced speeds of propellers; full effective power is available for going astern; the turbines always run in one direction, the reversing being done by changing the direction of the current at the motor; an improved

economy at low speeds is secured, which in war vessels means an increased radius of action.

In the U. S. collier *Jupiter*, the generating unit (turbine and generator) is similar in design and construction to units on shore, the generator being a three-phase, 2,300-volt, 5,000 kw., furnishing current to two electric motors one on each shaft, there being two propeller shafts. The motors are of the three-phase induction type and have 36 poles. Each is installed in a well surrounded by a coaming, so that it cannot easily be filled by sea water. The windings are waterproof and not at all sensitive to moisture. When prompt reversal is required it is desirable to cut in the resistance in the motor circuit. This is done by levers attached to the motor frames. Reversal under such conditions is accomplished by first opening the field switch which deenergizes the circuit, then moving the levers which cut in the resistances, then throwing the reversing switches, and lastly reestablishing the field circuit. These operations are simple and can be accomplished in a very few seconds. Locking devices are provided so that no error can be made.

The following table gives data on three U. S. colliers, viz., *Jupiter*, *Neptune* and *Cyclops*. The former is electrically driven, the *Neptune* is driven by geared turbines and the *Cyclops* by reciprocating engines.

	<i>Cyclops</i>	<i>Jupiter</i>	<i>Neptune</i>
Displacement.....	20,000	20,000	20,000
I. h. p. at 14 knots.....	5,800	.....	.....
Engine or turbine speed at 14 knots.....	88 r. p. m.	2,000 r. p. m.	1,250 r. p. m.
Propeller, r. p. m., at 14 knots.....	88	110	135
Weight driving machinery in tons.....	280	156	.....
Character of driving machinery.....	2 triple expansion engines	1 turbo-generator and 2 motors	2 turbines each with gearing
Steam consumption in pounds per shaft horse power per hour.....	14 (estimated)	11.2	.....
Speed maintained on 48-hour trial.....	14.6 knots	.....	13.9 knots

One of the largest electric installations is in the 30,000-ton U. S. battleship *California*. Here the current for propelling the battleship is generated by two 18,000 h. p. turbo-generator sets running at 2,200 r. p. m., furnishing the current to four 7,500 h. p. induction motors, giving a speed of 22 knots. At 14 knots only 7,000 h. p. is required. Due to the high efficiency of the electric speed adjustment system employed it is claimed that the steam

**POUNDS OF STEAM PER HOUR PER EFFECTIVE HORSE POWER**  
**For Direct Drive Turbines, Reciprocating Engines, and Turbo-**  
**Electric Units**

Name	How Driven	Speed in Knots			Revolutions of Propellers at 21 Knots
		12	19	21	
U. S. Battleship <i>Florida</i> .....	Parsons Turbines	lb. 31.8	lb. 24.	lb. 23.	323
U. S. Battleship <i>Utah</i> .....	Parsons Turbines	28.7	20.3	21.	323
U. S. Battleship <i>Delaware</i> ....	Reciprocating engines.....	22.	18.7	21.	122
U. S. Battleship <i>California</i> ..	Turbo-Electric..	17.3	15.	16.4	175

Estimated weight of the propelling machinery of the *California* without condensing auxiliaries is 530 tons. The contract price with auxiliaries was \$431,000.

consumption per horse power hour will be approximately the same at both speeds. Seventy-five per cent. of the power generated theoretically by the ship's turbines will be delivered to the generators, and it is estimated that there will be a loss of only 8% in the electrical equipment. In addition to the electric power for propulsion, all of the engine room auxiliaries will be electrically driven by direct current taken from the small, non-condensing turbo-generators that supply excitation for the main generators. It is said that the use of electric drive on the *California* represents a saving of about \$200,000 in the first cost of the propelling machinery, and that it offers superior economy in operation, besides reducing the weight of the propelling machinery and providing full power for reversing without the addition of astern turbines as is the case in direct turbine drive.

**Efficiency.**—Marine steam turbines have an efficiency of 55 to 65% when running at their designed speeds. At other speeds they are not, as a rule, as efficient as the ordinary reciprocating engine.

**Steam Consumption.**—When running at their designed speed turbines use about 11.85 lb. of steam per shaft horse power, while reciprocating engines use about 13.65 lb. per i. h. p.

**Weights.**—With turbines there is a saving of weight chiefly due to a decrease of 15 to 20% of the boiler capacity required for full power, owing to the increased economy of turbine machinery. There is also a saving in weight over those of reciprocating engines and in the space occupied.

## COMPARATIVE PERFORMANCES OF DIFFERENT SYSTEMS OF PROPULSION

Losses Given in Per cent of Total Power Developed	Turbine Connected Direct to Propeller Shafting	Turbine Drive Through Mechanical Reduction Gear	Turbine and Electric Transmission	Turbines and Hydraulic Transmission Fettinger Type	Combination—2 Reciprocating Engines and 1 Low-Pressure Turbine
Turbine water rates, lb. per s. h. p. hour	11½ to 12	10½ to 11	10½ to 11	10½ to 11	10½ to 11
Mechanical reduction gear losses	.....	2%	.....	.....	.....
Generator and motor losses	.....	.....	10%	.....	.....
Hydraulic transformer losses	.....	.....	.....	14%	.....
Reciprocating engine losses in combination	.....	.....	.....	.....	5.3%
Losses in thrust line and propeller shafting	1½%	2½%	2½%	2½%	2½%
Propulsive efficiencies	63%	66%	65%	60%	60%
Water rate, lb. per s. h. p. . . .	22 to 23	17 to 17.7	18.4 to 19.3	20.8 to 21.9	19 to 19.9

See also the table, Pounds of Steam to Main Engines per Hour per Effective Horse Power.  
See also the table, Comparative Performances of Geared Turbines and Reciprocating Engines.

**Horse Power.**—To calculate the horse power of a turbine an instrument called a torsion meter is used, which measures the torsional movement of the propeller shaft.

Let  $C$  = pounds per square inch, being the coefficient of rigidity depending on the material of the shaft

$F$  = torsion or turning movement on shaft in foot-pounds

$\theta$  = angle of distortion in circular measure between the two points on the shaft which were originally in the same straight line parallel to the shaft axis

$L$  = distance in feet the points are apart

$I_a$  = moment of inertia of the shaft cross section in inch units when calculated from the dimensions of the shaft

by the formula  $I_a = \frac{\pi}{32} (d_1^4 - d_2^4)$  where  $d_1$  and  $d_2$  are the external and internal diameters of the shaft.

If the shaft is solid then  $I_a = \frac{\pi d_1^4}{32}$

$N$  = revolutions of shaft per minute

$F$  = the torsion or turning movement on the shaft in foot-pounds =  $\frac{C \times I_a \times \theta}{144 \times L}$

Hence the shaft horse power (s. h. p.) =  $\frac{2 \pi N}{33,000} \times \frac{C \times I_a \times \theta}{144 \times L}$

Or the horse power may be calculated if the steam consumption, heat drop per pound of steam, and turbine efficiency are known—thus:

$$\text{calculated shaft horse power} = \frac{\text{lbs. of steam per min.} \times \text{heat drop} \times 778 \times \text{turbine efficiency.}}{33000}$$

The shaft or brake horse power is usually taken as .9 of the indicated.

$$\text{Then s. h. p.} = \frac{A \times S \times P}{11.85}$$

**To Find the Quantity of Steam used in Pounds per Shaft Horse Power.**

$Q$  = quantity of steam used in pounds per shaft horse power

$A$  = available heat in B. t. u.'s per pound of steam within a certain pressure limit  $P_1 - P_2$

$E$  = efficiency, which in marine turbines is from 55 to 65%

$$\text{Then } Q = \frac{\text{ft. lbs. per hour}}{A \times 778 \times E} = \frac{1,980,000}{A \times 778 \times E}$$

**Auxiliaries.**—These are practically the same as for steam engines with slight modifications, the chief being in the condenser, as a greater steam volume issues from a turbine since it operates at a higher vacuum than a steam engine. The condensers are invariably of the contraflow type, the steam and cooling water circulating in opposite directions.

A large circulating pump is required, and besides the usual air pump a dry vacuum pump is often installed. Sometimes, instead of the dry vacuum pump there is a vacuum augments, the chief purpose of which is to condense the vapor and draw off the air from the main condenser.

On account of the high speed at which turbines run, an efficient oiling system is essential. The oil is supplied by forced lubrication at pressures varying from 15 to 35 lb. to the turbine bearings as well as to the line shaft bearings.

See section on Auxiliaries.

### STEAM PLANT AUXILIARIES

**Atmospheric Pressure.**—At sea level the pressure of the atmosphere varies from 14.5 to 15 lb. per square inch, a fair average being 14.7. Atmospheric pressure is measured by the barometer.

**Gauge Pressure** is pressure measured above that of the atmosphere. Ordinary steam gauges indicate pressures above the atmosphere.

**Gross or Absolute Pressure** is the gauge pressure plus the atmospheric.

**Vacuum**, see Vacuum and Vacuum Gauge.

**Thermodynamics of Condensers.**—To condense steam, its latent heat of evaporation must be transferred to a sufficient weight of water cold enough to absorb the heat. At 90° F., which corresponds to an absolute pressure of 1.42 ins. of mercury or 28.58 ins. of vacuum referred to a 30-in. barometer, steam contains about 1,040 latent heat units (B. t. u.) per pound. If this heat is transferred to water entering the condenser at 60° and the water thereby heated to 90°, which is the utmost possible with 90° steam, each pound of water will absorb 30 B. t. u. Therefore, for each pound of steam condensed there will be required  $\frac{1040}{30} = 34.7$  lb. of water as the least quantity theoretically possible to condense the steam.

If the water enters at 70°, each pound can only absorb 20 B. t. u., and  $\frac{1040}{20} = 52$  lb. of water which will be required per pound of

steam. For example, suppose a 10,000 kw. turbine, or engine and turbine plant uses 15 lb. of steam per kw. hour. If the average summer temperature of the cooling water is 70° and a steam temperature of 90° is specified at that season, then  $\frac{10,000 \times 15 \times 1040}{20}$   
 = 7,800,000 lb. of cooling water per hour, theoretically required.

As the cooling water in actual practice never rises fully to the temperature of the steam, it is necessary to allow for a certain **temperature difference** between the outgoing water and the steam. In most instances condensers are designed for a difference or temperature head of 5° F. or over, depending on the steam and on the temperature of the incoming water, but being greater for a low vacuum (where less water is handled) than for a high, and greater in winter than in summer.

Owing to **condensation** in the turbine, due partly to radiation and partly to expansion, the steam exhausted into the condenser must contain a certain amount of moisture ranging from 5 to 15%; that is, the steam gives up part of its latent heat before it reaches the condenser. It is therefore sufficiently accurate to assume that the condenser receives 950 B. t. u. per pound of steam used at the



throttle when the latter reaches the turbine saturated, and 1,000 B. t. u.'s when it is moderately superheated.

The smallest quantity of water will be required when the cooling water leaves the condenser at a temperature as close as possible to that of the entering steam. No condenser produces a perfect vacuum. A closed vessel exhausted completely of air and partially filled with water contains water vapor whose pressure will depend on its temperature. For a temperature of 60° F. it is .52 in. of mercury, or 29.48 ins. of vacuum referred to a 30-in. barometer; for 80°, 1.029 ins. of mercury and so on. In a steam condenser there is always present a certain amount of air in addition to the water vapor. Some of this is carried through with the steam from the feed water; a large quantity is added by leaks around the piston rod and valve stem of the low-pressure cylinder of reciprocating engines, or it is admitted through the shaft stuffing boxes of turbines, also by air leaks in the joints of the exhaust pipe. In jet condensers a third source of air, larger than either of the others, is the cooling water itself, whose absorbed air is set free by the reduced pressure and increased temperature in the condenser. (Notes from C. H. Wheeler Mfg. Co., Philadelphia, Pa.)

Condensers convert the exhaust steam from the engine and turbine into water. There are three types, viz., jet, surface, and keel. The former consists of a cone-shaped chamber in which the steam and cold condensing water are mingled, the steam giving up its heat to the relatively cool water, and being reduced to the liquid state again. The condensing water enters at the top of the chamber and falls upon a plate pierced with a large number of small holes and known as the scattering plate. The condensed steam and condensing water fall together to the bottom of the condenser and are pumped by the boiler feed pump to the boilers. Should there be a superfluous amount this is discharged overboard by another pump. It is evident that jet condensers can be installed only in vessels running on fresh water. See also Jet Condensers.

Surface Condensers are cylindrical or rectangular in shape. When the latter they may form part of the frame supporting the engine cylinders. In either case they contain a large number of small brass tubes, fastened at each end to tube sheets. The condensing water is driven by a circulating pump (generally a centrifugal one) through the tubes, the water being drawn from the sea. The steam entering the condenser at the top comes in contact with baffles or diaphragm plates preventing it from rushing through

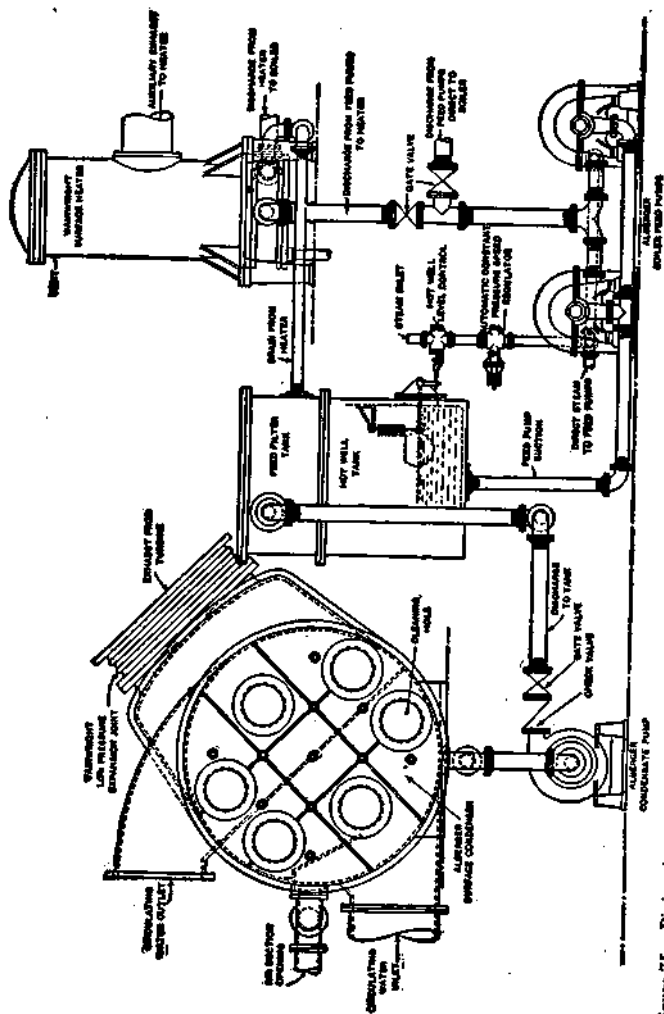

Figure 75.—Piping Arrangement of Surface Condenser and Feed Water Heater (Alberger Pump and Cond. Co., New York).

the condenser to the bottom and causing it to be broken up and to pass around the tubes through which the cold water is flowing, thus condensing the steam into water which is pumped to the hot well by an air pump. The coldest water usually enters at the bottom, meeting the steam at the lowest temperature, and the warmest water at the top comes in contact with the tubes which are surrounded by the hottest steam. The cooling water often flows through the condenser two or three times, and travels in an opposite direction to the steam.

#### SIZES OF SURFACE CONDENSERS, AIR AND CIRCULATING PUMPS

Size of Engine	Cooling Surface in Condenser in Sq. Ft.	Air Pump	Circulating Pump
17 × 27 × 43 24	1,350	Independent—2 single acting cylinders—steam 7½ ins. dia., 2 air cylinders, 16½ ins. dia. by 10-in. stroke.	Centrifugal, 8-in. suc., 8-in. dia. engine, 7 × 7
Twin 17 × 27 × 43 24	2 cond. total cooling surface, 2,750	One air pump for the 2 condensers, 12 in. dia. steam cylinder with 2 20-in. buckets with stroke of 12 ins.	2 circulating pumps, one for each cond., centrifugal, 8-in. suc., 8-in. dia., engine 7 × 7
25 × 41 × 68 42	4,500	Vertical duplex Blake, 10 × 22 × 25	Cent., 10-in. suc., 10-in. dia. engine 12 × 10
24 × 40 × 63 49½	3,000	23½ in. dia. × 23½ in. stroke.	14-in. dia. × 23½ in. stroke.
20 × 33 × 64 40	1,563	20 ins. dia. × 14-in. stroke	Cent., 9-in. suc., 8-in. dia., engine 7 × 7
29 × 49 × 84 64	6,800	30 ins. dia. × 24-in. stroke	Cent., 12-in. suc., 12-in. dia., engine 9 × 10
Triple screw turbine, total s.h.p. 25,000	2 cond. each 13,046	One pump for each cond., twin beam, vert., single acting Blake—air cylinders, 32 ins. dia., steam 14 ins. dia. by 21 ins. stroke.	Cent. pump, 26-in. suc., 26-in. dia.

**Structural Features of Surface Condensers.**—In modern ships with triple expansion engines the area of the cooling surface in a condenser is from 1 to 1.25 sq. ft. per i. h. p. In warships, 1 sq. ft. per i. h. p. has been found sufficient. With steam turbines where a higher vacuum can be more advantageously utilized than with reciprocating engines, the cooling area may be 1.2 sq. ft. per shaft

horse power for turbine warships. In torpedo boats the area is sometimes as low as .75 sq. ft.

The shells are made of cast iron, sheet brass, or steel plates. The tubes are of thin brass, usually  $\frac{5}{8}$  to  $\frac{3}{4}$  inch outside diameter. They are fastened to tube sheets by ferrules which by screwing down compress a packing, thereby making a watertight joint.

Surface condensers are provided with the following fittings and connections:

**Main air pump suction**

Suction from some fresh water pump, as hot well pump, for keeping condenser clear when main engines are stopped

Drain cocks for both salt and fresh water ends

Air cocks to allow any accumulation of air to escape

A boiling out connection so steam can be admitted to boil out the condenser

A connection for admitting soda in solution

A vacuum gauge and a water gauge

Zincs are fitted in the salt water side and should have a good metallic contact with the heads

Hand holes. Connection for making up feed from fresh water tank.

**Operating.\***—To remove grease and dirt which accumulates on the outside of the tubes, the condenser should be boiled out. This is done by admitting potash or soda through the soda cock, the soda being first dissolved in water. Live steam is then turned into the condenser through the boiling out connection. The mixture of soda and steam dissolves the grease, forming a soapy substance which can be drained off. Additional water is introduced to wash away the accumulation and remove the extra soda.

The vacuum may be lost through the following causes:

Head or bucket valves of air pump broken;

Injection pipe stopped up;

Division plate in condenser door carried away;

Leaky low pressure gland;

Leaks in shell and joints.

To find the probable cause of the loss of vacuum feel both ends of the condenser. If both are cold, the air pump valves are broken or there is a leaky low-pressure gland. If both are warm, either a broken circulating pump valve or a choked injection valve is the cause. If one end is cold and the other warm, the division plate in the condenser door is most likely carried away.

\* Abstracts from Care of Naval Machinery. H. Dinger.



In reciprocating engines only a slight gain is obtained thermodynamically in a vacuum above 26 ins., owing to increased cylinder condensation caused by the difference in the inlet and outlet temperatures of the steam. If the condenser is tight and the air pump in good condition, 26 ins. should be maintained even in hot weather.

In turbines 28 to 29 ins. are obtainable, and with a Parsons vacuum augmenter installed the vacuum is one inch less than the barometer reading.

**To Find the Vacuum under Given Working Conditions.**—If the temperature of the condenser is 101° F., and the barometer stands at 30 ins., equivalent to a pressure of 14.7 lb. per square inch, the vapor pressure corresponding to 101° (see table below) is .980 lb. per square inch; thus the greatest vacuum possible would be 14.7 - .980 = 13.72 lb. per square inch below the atmosphere, equivalent to 27.5 ins. on the vacuum gauge.

Vacuum Measured in Inches of Mercury	Absolute Pressure in Inches of Mercury	Absolute Pressure in Pounds per Square Inch	Temperature of Boiling Point in Degrees F.	Latent Heat of Evaporation in B. t. u.	Sensible Heat of Evaporation from 32° F. in B. t. u.	Total Heat of Evaporation from 32° F. in B. t. u.
29½	½	.245	59.1	1072.8	27.1	1100.0
29	1	.490	79.3	1058.8	47.3	1106.1
28½	1½	.735	92.0	1049.9	60.1	1110.0
28	2	.980	101.4	1044.4	69.5	1112.8
27	3	1.470	115.3	1033.7	83.4	1117.1
26	4	1.96	125.6	1026.5	93.8	1120.3
25	5	2.45	134.0	1020.6	102.2	1122.8
24	6	2.94	141.0	1015.7	109.3	1125.0
23	7	3.43	147.0	1011.5	115.3	1126.8
22	8	3.92	152.3	1007.8	120.2	1128.4
21	9	4.41	157.0	1004.5	125.4	1129.8
20	10	4.90	161.5	1001.3	129.9	1131.2
19	11	5.39	165.6	998.4	134.1	1132.4
18	12	5.88	169.2	995.9	137.7	1133.5
17	13	6.37	172.8	993.4	140.3	1134.6
16	14	6.86	176.0	991.1	144.5	1135.6
15	15	7.35	179.1	988.8	147.7	1136.5
14	16	7.84	182.0	986.9	150.6	1137.4
12	18	8.82	187.4	983.1	156.0	1139.1
10	20	9.80	192.3	979.6	161.0	1140.6
5	25	12.25	203.0	972.1	171.8	1143.9
0	30	14.70	212.0	965.7	180.9	1146.6

14.7 lb. = atmospheric pressure = 30 inches of mercury.

Table from Marine Steam Engine. R. Sennett and H. J. Oram.

## VACUUM AND CORRESPONDING STEAM TEMPERATURE IN CONDENSER

Vacuum inches	Temperature (Fahrenheit) degrees	Vacuum inches	Temperature (Fahrenheit) degrees
20	161.5	26	125.4
21	157.0	26½	120.4
22	152.2	27	115.1
23	146.8	27½	108.6
24	140.8	28	101.2
25	133.7	28½	91.8
		29	79.1

**Miscellaneous Notes.**—The pressure in the condenser can be determined from the hot well temperature by noting the hot well temperature and looking in the table of saturated steam for the corresponding pressure.

*Example.* The temperature of the water in the hot well is 141°. Find the pressure in the condenser.

On looking up in the table of Saturated Steam, the pressure at this temperature is 3 lb. absolute, which is then the pressure in the condenser.

The actual pressure on the low-pressure cylinder is from 1 to 2 lb. in excess of this, as a difference of pressure must exist for the steam to flow. Thus it is impossible to have a high vacuum and hot well temperature at the same time, as the two vary in inverse ratio. With a high temperature of the hot well water the vapor corresponding to the temperature is also high with a proportionally reduced vacuum in the condenser.

Under ordinary conditions and with 25 to 26 ins. of vacuum, the temperature of the condenser discharge should be about 110° F. A lower temperature would indicate that an unnecessary amount of water is being pumped. See table under Circulating Pump.

It is estimated that 20 volumes of water absorb one volume of air; hence if means were not taken to remove this air from the condenser, it would fill it and destroy the vacuum. For this reason dry vacuum pumps are installed.

One square foot of cooling surface in a surface condenser is allowed to condense 10 lb. of steam with the temperature of the circulating water at 70°, based on obtaining a vacuum of 25 ins.

**Jet Condensers.**—The capacity of a jet condenser should not be less than one-fourth of the cylinder or cylinders exhausting into it, one-third the capacity being generally sufficient. The objection

to a large condenser, besides its cost and weight, is that a longer time is necessary to get a good vacuum. See Condensers.

With a jet condenser a vacuum of 24 ins. is considered fairly good, and 25 good. The temperature corresponding to 24 ins. or 3 lb. absolute pressure is 140°. In actual practice the temperature in the hot well varies from 110° to 120° and sometimes 130° is maintained by a careful engineer.

**To Calculate the Quantity of Cooling Water Required for Either a Surface or a Jet Condenser.\***

Let  $T_1$  = temperature of steam entering the condenser

$L$  = the latent heat of the steam

$T_0$  = the temperature of the circulating water

$Q$  = the quantity of circulating water

$T_2$  = temperature of the water leaving the condenser

$T_3$  = temperature of the feed water

The heat to be absorbed by the cooling water is  $(T_1 + L) - T_2$  and is equal to  $966 + .7 \times 212 + .3 (T_2 - T_0)$  or  $Q (T_2 - T_0)$ .

$$\text{Hence } Q (T_2 - T_0) = (T_1 + L) - T_2$$

$$Q = \frac{1114 + .3 T_1 - T_2}{T_2 - T_0}$$

*Example.* To find the amount of circulating water required by an engine with an exhaust at 8 lb. absolute pressure, the temperature of the sea being 60°. Also find the amount of water required when the sea temperature is 75°. The temperature of the water at the discharge is 100°, and of the feed 120°. The temperature corresponding to 8 lb. is 183°.

At 60°

$$Q = \frac{1114 + .3 \times 183 - 120}{100 - 60} = 26.22; \text{ that is, the water required is 26.22}$$

times the weight of the steam.

At 75°

$$Q = \frac{1114 + .3 \times 183 - 120}{100 - 75} = 41.95 \text{ times.}$$

The quantity of sea water will depend on its initial temperature, which in actual practice varies from 40° in the winter of temperate zones to 80° in the West Indies and tropical seas. In the latter case a pound of water requires only 20 thermal units to raise it to 100°, while 60° are required in the former. Thus the quantity of circulating water required in the tropics is three times that required in the North Atlantic in the spring of the year.

A rough approximation is 27 lb. of circulating water for every

\* From Practical Marine Engineering.



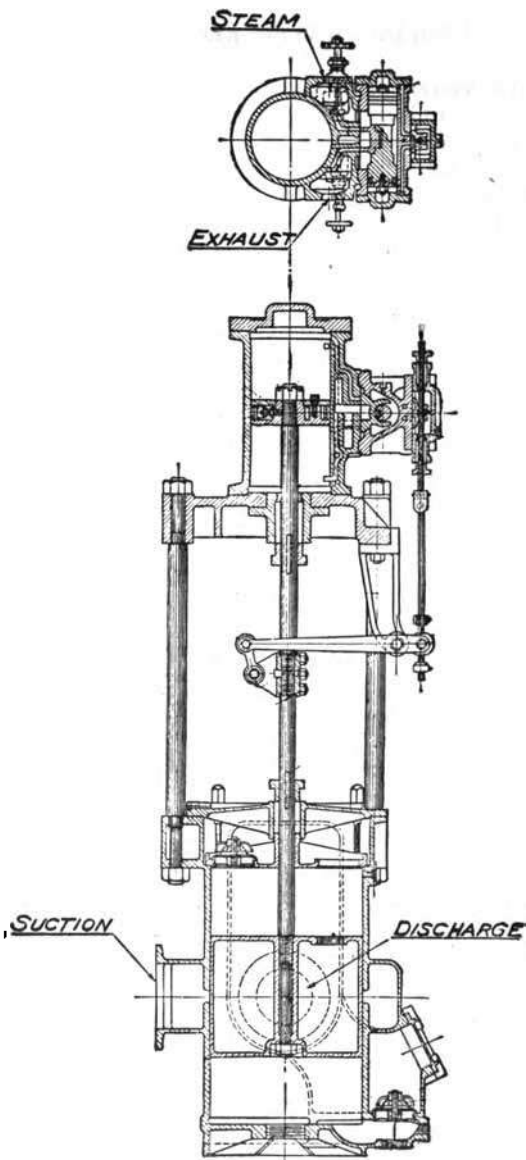

Figure 77.—Air Pump (Worthington Pump Co., New York).

pound of steam condensed. About 25 gallons of water are required to condense the steam represented by one gallon of water evaporated, or one to one and a half gallons per minute per one h. p. Jet condensers do not require so much water for condensing as surface condensers.

**Keel or Outboard Condensers** consist of pipes on the outside of the hull near the keel, into which the engine exhausts. They are often installed in launches, tugs, lighters, and small passenger steamers, and are of iron, brass, or copper pipe with an air pump operated by the engine—or, instead, the air pump may be independently steam driven. Neither copper nor brass should be used for keel condensers on vessels running in salt water, unless the stern bearing, propeller wheel, and tail shaft are of bronze. Neither should iron nor steel pipe be used if the vessel is coppered or has a bronze outboard bearing.

**Air Pump.**—The function of an air pump is to draw out the air and water from a condenser and by the vacuum formed reduce the back pressure on the low-pressure piston. The air pump is often driven direct from the main engine, or it may be separate, having its own steam cylinder.

There are two types, viz., single- and double-acting. The former is vertical and is usually selected. In the **single-acting** there is a reciprocating bucket or piston with orifices covered by non-return valves which move in a cylindrical barrel at each end of which are covers with orifices and non-return valves. These three sets of valves lift vertically and allow the passage of water or air in only one direction. The suction pipe of the air pump communicates with the bottom of the condenser, the pump being placed lower than the condenser to get the most satisfactory results. The valves at the lower end are called foot or suction valves, those in the moving bucket, bucket valves, while those in the top are the head or discharge valves.

The stroke of a vertical air pump when driven from the main engine is  $\frac{1}{3}$  to  $\frac{1}{2}$  that of the engine, but its speed should not exceed 300 ft. per minute, and for continuous running should be about 275 ft.

Edward's air pump is a single acting vertical pump with valves only at the top to check the discharged water and air from returning to the pump on the down stroke. This pump is very simple and gives a good vacuum. See Fig. 78.

**Double-acting air pumps** are of the horizontal type and have an

efficiency ranging from 30 to 50%, a fair average being about 35. Single-acting, 40 to 60% with an average of 50.

The capacity of an air pump is generally taken as  $\frac{1}{15}$  to  $\frac{1}{10}$  of the capacity of the low-pressure cylinder. One authority, Mr. Le Blanc, states that for turbines with a 29-inch vacuum the air pump must handle 21 times the volume of feed water, and for a reciprocating engine with a 26-inch vacuum the pump must handle 12 times the volume of water.

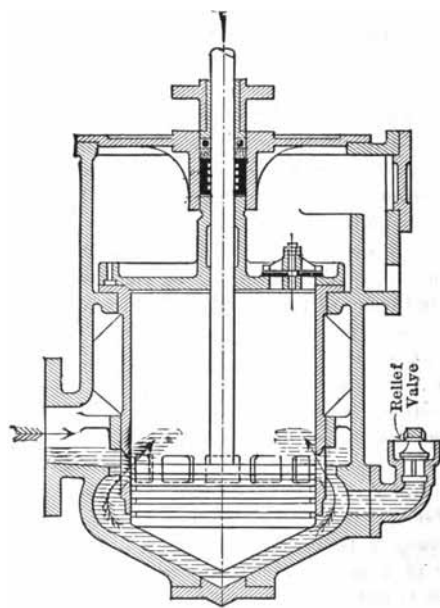

EDWARDS AIR PUMP  
AS NOW EXTENSIVELY USED ON MERCHANT SHIPS

Figure 78.

Independent from main engine, vertical twin-cylinder air pumps for jet and surface condensers, having 2 steam and 2 water cylinders,

are given in the following table. The pumps are single-acting, and the capacities given are the capacities per revolution for each side; for a complete revolution the capacity is twice that per side. The pumps can be run at 100 ft. per minute, but for constant a speed of 75 ft. or less is recommended.

Steam Cylinders, Inches	Air Cylinders, Inches	Stroke, Inches	Gallons per Stroke	Steam Pipe, Inches	Exhaust Pipe, Inches
8	16	12	10.44	1½	2½
10	16	12	10.44	1½	2½
12	16	12	10.44	2½	3
8	18	12	13.22	1½	2½
10	18	12	13.22	1½	2½
12	18	12	13.22	2½	3
10	20	12	16.32	1½	2½
12	20	12	16.32	2½	3
10	22	15	24.68	1½	2½
12	22	15	24.68	2½	3
14	22	15	24.68	2½	3
12	24	18	35.25	2½	3
14	24	18	35.25	2½	3
12	30	18	55.08	2½	3
14	30	18	55.08	2½	3
16	30	18	55.08	3	3½
14	36	18	79.32	2½	3
16	36	18	79.32	3	3½
18	36	18	79.32	3½	3½
16	38	20	98.20	3	3½
18	38	20	98.20	3½	3½
20	38	20	98.20	3½	3½
18	40	24	130.58	3½	3½
20	40	24	130.58	3½	3½
24	40	24	130.58	4	4
24	48	24	188.04	4	4
30	48	24	188.04	4½	4½
30	58	24	274.00	4½	4½

Dean Bros., Indianapolis, Ind.

See table of Sizes of Condensers, Air and Circulating Pumps.

A new type of air pump (trade name Radojet, C. H. Wheeler Mfg. Co., Phila., Pa.) is shown in Fig. 76. This pump is a substitute for any air pump working on the dry air principle. It has no piston nor valves, and is operated by live steam jets which by passing through nozzles of patented design obtain a high velocity that entrain the air and non-condensable gases from the condenser.

The ordinary reciprocating air pump may be replaced by a Radojet removing the air, while a small, direct acting, hot well pump removes the condensed steam from the condenser. The arrangement is practically the same for either reciprocating engines or turbines, only in the latter a direct acting duplex reciprocating pump is employed for removing the condensed steam from the condenser.

**Circulating Pump.**—This forces the cooling water through the condenser tubes, and is either of the reciprocating or centrifugal type; if the latter, is driven by a steam engine running at about 200 revs. per minute or it may be driven by a turbine at a higher speed. The water should be pumped through the tubes at a velocity of about 115 ft. per minute, when the sea water is at 60°, and 170 ft. when at 75°, the speed of the pump being so regulated that the temperature of the discharge water is about 20° below the temperature corresponding to the vacuum that is to be maintained.

Vacuum, Inches	Temperature of Discharge Water Corresponding to Vacuum, Degrees
28	100
26	125
24	140
22	152
20	161

If the circulating pump breaks down, connect up the donkey pump to the condenser for circulating the water, but if this cannot be done, or if no other pump can be connected up, then the engines must be run jet condensing if the steamer runs in fresh water, or non-condensing if in salt water. To do this draw a number of the condenser tubes, and open up the air pump discharge valve. To find the number of tubes to draw, use the formula 
$$\frac{\text{Injection pipe diameter}^2}{\text{Condenser tube diameter}^2}$$

= number of tubes.

See section on Pumps; also table of Sizes of Condensers, Air and Circulating Pumps.

**Feed and Filter Tank (Hot Well).**—The air pump discharges the condensed water from the condenser into a combined feed and filter tank. In large vessels this tank has sufficient capacity for 10 to 15 minutes running at full boiler power. The tank is divided into several compartments. See Fig 76.

As to filtering materials, coke in bags of burlap or heavy toweling is fairly satisfactory. When the coke is to be renewed the bags are washed with soda and refilled with fresh coke.

Zincs are suspended in the feed tanks to absorb oxygen.

**Steam Traps.**—As steam condenses in the pipes through which it passes it is necessary to drain the condensed water off, and this is accomplished by pipes leading to traps where the water is collected and from which the water goes to the filter tank for use over again in the boiler.

The best way to specify the size of a trap is to specify the size of the orifice in the valve and the maximum pressure the trap will work under. The orifice in the valve is always the capacity of the trap and no more condensation can pass through the trap than will pass through the orifice, regardless of the size of the pipe connections. Hence the only accurate way of deciding on a steam trap for any service is to know its discharge capacity in pounds or gallons per hour.

Under ordinary conditions 9 ounces of condensation per linear foot of one-inch pipe per hour are allowed. To compute the equivalent in one-inch pipe of a given quantity of pipe of other sizes, multiply the number of linear feet of a certain size by the figure underneath that size, as in the table below.

Size of Pipe, Ins.	1¼	1½	2	2½	3	3½	4	4½	5	6	7	8	9	10	12
Multipliers.....	1.26	1.44	1.81	2.19	2.66	3.04	3.42	3.80	4.23	5.43	5.80	6.55	7.34	8.18	9.72

To find the rated allowance of condensation in ounces per linear foot per hour of any steam trap, take the rated discharge capacity in pounds per hour, and compute same in ounces; then divide by the number of rated linear feet and the result is the allowance of condensation per linear feet per hour.

The rating in feet of one-inch pipe of a steam trap, based on a fixed amount of condensation per foot per hour, will be materially reduced when the condensation is severe, say 25 ounces of condensation per foot per hour.

To determine the number of linear feet a trap will take care of, compute the capacity of condensation in pounds per hour and then in ounces; next decide on the allowance of condensation per foot per hour and divide it into the capacity. The quotient will be the

number of linear feet. Thus suppose a trap is rated at 4,380 lb. per hour and the allowance per foot of one-inch pipe is 25 lb.; then

$$\frac{4,380 \text{ lb. per hour (capacity)}}{16} \\ \hline 70,080 \text{ oz. per hour.}$$

$$\frac{70,080}{25} = 2,803 \text{ linear feet of 1-inch pipe}$$

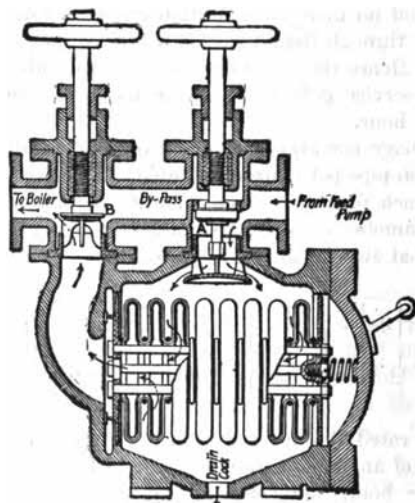

Figure 79.—Feed Water Filter.

**Feed Water Filter.**—Referring to the filter in Fig. 79 (Ross Valve Co., Troy, N. Y.) the water enters the right hand pipe at the top and flows into the chamber below. The central portion of the chamber is occupied by the filter. The filtering material is known as linen terry or Turkish toweling. The toweling is over a bronze

circular frame, the filtering surface being from 150 to 1000 times the area of the feed pipe according to the service required. When a feed water heater is used, water should first pass through the filter.

**Feed Water Heaters.**—These are either open (jet) or closed (surface). Open heaters consist of a closed chamber into which the feed water is delivered by a pump. In this chamber it overflows a series of trays and condenses the exhaust steam in the same manner as a jet condenser. The resulting hot water is pumped by the boiler feed pump to the boiler. With this type the temperature of the feed water cannot be above about 180°, as a higher temperature would cause vapor to form and the feed pump would not have a proper suction.

The closed type of heater operates like a surface condenser. It consists of a cast iron chamber containing brass or copper tubes through which the water from the hot well is forced by the boiler feed pump on its way to the boiler. The space around the tubes is filled with exhaust steam (from the main units or the auxiliaries); the water entering the tubes either cold or at hot well temperature. When there is an excess of exhaust steam, the water goes to the boiler within a few degrees of the exhaust steam temperature. When the exhaust steam supply is limited, practically all is condensed in the heater, and its latent heat transferred to the water, thereby determining the resultant temperature of the water. Two systems are in use, one where the heater is on the suction side of the feed pump and the other where it is on the discharge side. With the heater on the suction side of the pump a hot well pump is needed. To get 220° temperature a pressure of around 5 lb. above the atmosphere is necessary. Ordinarily a saving of one per cent. is made by each increase of 11° F. in the temperature of the feed water, which is about .09 per cent. per degree. That is, an approximate rise of 10° in the temperature of the feed water gives a saving of 1 per cent. in the amount of coal used. An efficient heater will give the feed water a temperature within 10° of the temperature of the steam.

*Example.* The temperature of the feed water entering a heater is 70° F., and on leaving 81°, steam 100 lb. at the gauge, containing 1,189 B. t. u. per pound. Find the saving in per cent if the temperature is raised 11°.

Let  $H$  = total heat in one pound of steam at the boiler pressure

$H_1$  = total heat in one pound of feed water before entering the heater

$H_2$  = total heat in one pound of feed water after leaving the heater



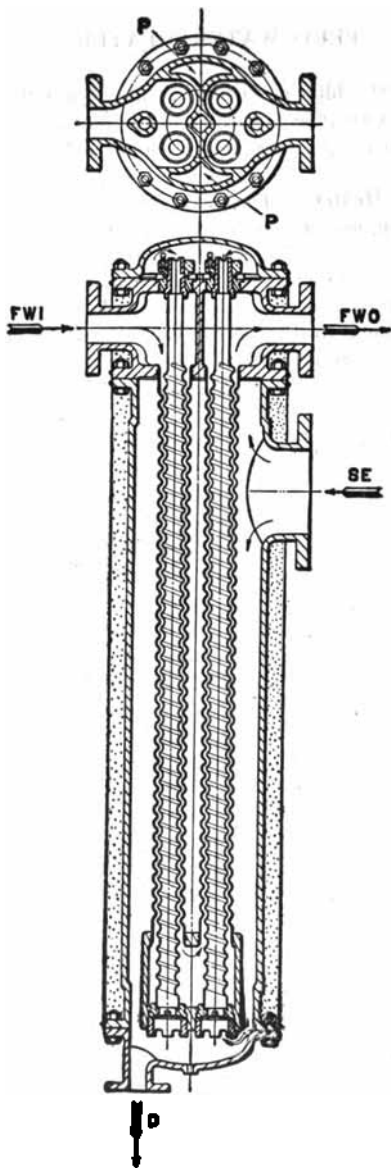

Figure 90.—Feed Water Heater.

$$\text{Then per cent saved} = \frac{H_2 - H_1}{H - H_1}$$

Temperature of feed water entering heater = 70° and contains 70° - 32° = 38 B. t. u. per lb.

Temperature of feed water leaving heater = 81° and contains 81° - 32° = 49 B. t. u. per lb.

$$\text{Saving in raising temperature } 11^\circ = \frac{H_2 - H_1}{H - H_1} = \frac{49 - 38}{1,189 - 38} = .96\%$$

Fig. 80 is of a feed water heater built by Schutte & Koerting, Phila., Pa., of concentric spiral corrugated tubes. This construction besides agitating the water and so preventing the formation of cold cores, keeps the water in a thin film between two heated copper surfaces. This gives an exceedingly high rate of heat transmission, and yet at the same time a light and efficient heater. The heater may be arranged either vertical or horizontal.

PERCENTAGE SAVING IN FUEL BY HEATING FEED WATER WITH  
EXHAUST STEAM  
100 lb. Boiler Pressure

Initial Temp. of Feed Water	Final Temperature of Feed Water											Initial Temp. of Feed Water	
	120°	130°	140°	150°	160°	170°	180°	190°	200°	210°	220°		230°
° F.	%	%	%	%	%	%	%	%	%	%	%	%	° F.
40°	8.8	7.65	8.72	9.35	10.45	11.05	12.20	13.07	13.95	14.80	15.70	16.55	40°
50°	5.95	6.85	7.92	8.57	9.70	11.28	11.45	12.32	13.20	14.10	15.00	15.85	50°
60°	5.1	6.04	7.12	7.67	8.90	9.50	10.70	11.60	12.45	13.35	14.25	15.15	60°
70°	4.25	5.23	6.27	6.97	8.07	8.72	9.87	10.76	11.65	12.55	13.45	14.35	70°
80°	3.4	4.39	5.43	6.16	7.24	7.91	9.06	9.95	10.85	11.75	12.70	13.60	80°
90°	2.55	3.54	4.57	5.32	6.40	7.09	8.22	9.13	10.05	10.95	11.90	12.80	90°
100°	1.7	2.68	3.68	4.47	5.63	6.26	7.38	8.30	9.22	10.15	11.05	12.00	100°
110°	0.85	1.8	2.78	3.61	4.65	5.41	6.52	7.43	8.38	9.30	10.25	11.15	110°
120°	.....	0.91	1.89	2.73	3.75	4.55	5.63	6.56	7.50	8.45	9.40	10.30	120°
130°	.....	.....	0.95	1.84	2.84	3.68	4.74	5.68	6.63	7.60	8.55	9.45	130°
140°	.....	.....	.....	0.92	1.90	2.92	3.83	4.80	5.75	6.70	7.65	8.60	140°
150°	.....	.....	.....	.....	0.97	1.97	2.90	3.85	4.83	5.80	6.75	7.72	150°

Evaporators are for treating salt water so that it can be used in the boilers. All types work on the same principle; that is, the salt water is heated by steam from the boilers. The boiler steam to the coils of an evaporator is merely a medium for carrying heat to the apparatus, and is returned to the boiler as hot feed after it is condensed in the coils. The quantity of steam or coal required to produce a ton of distilled water depends on the temperature of the

evaporator feed and the pressure of the steam in the coils. Neglecting radiation, there is always a loss in heating an evaporator, due to blowing down, but under ordinary working conditions this loss is only about 5%.

The following table shows the pounds of boiler steam required to produce one pound of pure water at various pressures and feed temperatures, working single effect and under normal conditions, and neglecting radiation loss. The figures do not include steam used by feed pump or circulating pump.

Boiler Steam Pressure to Coils	Temperature of Feed Water							
	50°	75°	100°	125°	150°	175°	200°	225°
75 lb. ....	1.30	1.26	1.22	1.17	1.14	1.10	1.06	1.03
100 lb. ....	1.31	1.27	1.23	1.19	1.15	1.11	1.07	1.04
125 lb. ....	1.32	1.29	1.25	1.21	1.17	1.13	1.09	1.05
150 lb. ....	1.34	1.31	1.27	1.23	1.19	1.14	1.10	1.06
175 lb. ....	1.36	1.33	1.29	1.25	1.20	1.16	1.12	1.08
200 lb. ....	1.38	1.35	1.31	1.26	1.22	1.18	1.14	1.10
225 lb. ....	1.41	1.37	1.33	1.28	1.24	1.20	1.15	1.11
250 lb. ....	1.43	1.39	1.35	1.30	1.26	1.22	1.17	1.13

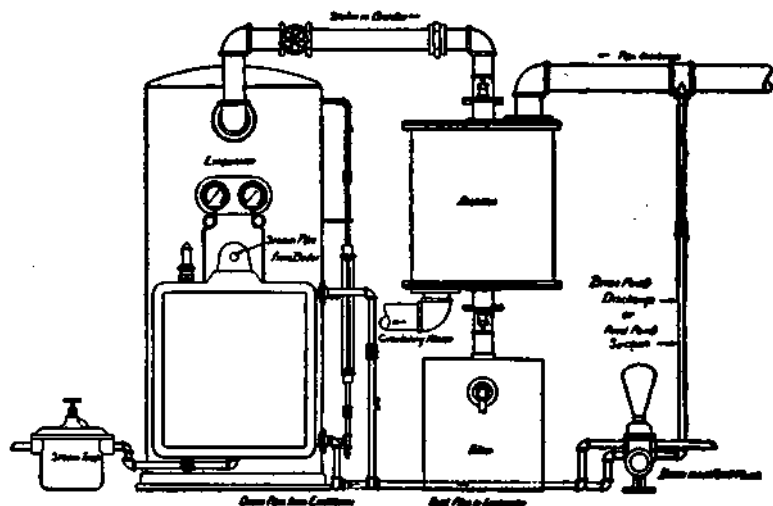

Figure 81.—Piping of Distiller and Evaporator (M. T. Davidson & Co., New York).

## DIMENSIONS OF EVAPORATORS\*

Size No.	Diameter of Shell	Height of Shell		Diameter of Connections				
				Steam Inlet	Vapor Outlet	Feed Inlet	Blow Off	Drain from Coils
	Inches	Ft.	In.	Inches	Inches	Inches	Inches	Inches
1	10	5	0	$\frac{1}{2}$	1	$\frac{1}{2}$	$\frac{3}{4}$	$\frac{1}{2}$
2	13	5	0	$\frac{3}{4}$	$1\frac{1}{4}$	$\frac{1}{2}$	$\frac{3}{4}$	$\frac{1}{2}$
3	15	5	3	1	$1\frac{1}{4}$	$\frac{3}{4}$	$\frac{3}{4}$	$\frac{3}{4}$
4	18	5	6	1	$1\frac{1}{4}$	$\frac{3}{4}$	$\frac{3}{4}$	$\frac{3}{4}$
5	24	6	0	1	$1\frac{1}{2}$	1	1	$\frac{3}{4}$
6	30	6	6	$1\frac{1}{4}$	2	$1\frac{1}{4}$	1	1
7	30	6	6	$1\frac{1}{4}$	2	$1\frac{1}{4}$	1	1
8	36	7	0	$1\frac{1}{2}$	$2\frac{1}{2}$	$1\frac{1}{2}$	$1\frac{1}{4}$	1
9	36	7	0	$1\frac{1}{2}$	$2\frac{1}{2}$	$1\frac{1}{2}$	$1\frac{1}{4}$	1
11	40	7	6	2	3	2	$1\frac{1}{2}$	1
12	40	7	6	2	$3\frac{1}{2}$	2	$1\frac{1}{2}$	1
13	45	7	9	2	$3\frac{1}{2}$	2	$1\frac{1}{2}$	$1\frac{1}{4}$
14	50	8	0	$2\frac{1}{2}$	4	$2\frac{1}{2}$	$1\frac{1}{4}$	$1\frac{1}{2}$
16	60	8	0	$2\frac{1}{2}$	4	$2\frac{1}{2}$	$1\frac{1}{2}$	$1\frac{1}{2}$
17	60	8	3	$2\frac{1}{2}$	4	$2\frac{1}{2}$	$1\frac{1}{2}$	$1\frac{1}{2}$

## CAPACITIES OF EVAPORATORS

Size No.	Diameter of Shell	Tons per 24 Hours		Gallons per 24 Hours		Weight
		Minimum	Maximum	Minimum	Maximum	
	Inches					Pounds
1	10	.83	.....	200	.....	200
2	13	1.20	.....	300	.....	400
3	15	2.08	2.50	500	600	548
4	18	3.66	4.17	880	1,000	630
5	24	5.00	5.62	1,200	1,350	960
6	30	7.08	8.33	1,700	2,000	1,295
7	30	8.54	9.58	2,050	2,300	1,450
8	36	10.42	12.08	2,500	2,900	1,697
9	36	13.33	15.00	3,200	3,600	1,830
11	40	14.58	16.67	3,500	4,000	2,286
12	40	18.75	20.83	4,500	5,000	2,600
13	45	22.66	25.62	5,440	6,150	2,740
14	50	27.92	31.67	6,700	7,600	3,558
16	60	33.33	37.50	8,000	9,000	5,600
17	60	45.00	50.00	10,840	12,000	5,845

Minimum capacities represent quantity of pure drinking water; maximum capacities represent quantity of make-up boiler feed water.

\* Raily multicoil evaporators, Griscom-Russell Co.

As to the size to be installed, a fairly good rule is to allow one ton of water per day per 100 i. h. p. of the engine. The Reilly multicoll evaporators (Griscom-Russell Co., New York) have a rated capacity based on a steam pressure of 75 lb. in the coils with a feed temperature of 75° and a pressure of 15 lb. maintained in the vapor space in the shell. Increase of steam pressure in the coils materially increases the capacity with slightly diminished efficiency.

Feed water may be made by a single effect evaporator (that is, using only one evaporator), for only a nominal consumption of coal, preferably the drain from the coils is led to the hot well and the heat of the drain is saved. If the vapor from the shell is also led to the hot well and there condensed, this heat is also saved, and practically the only loss during the operation is due to blowing down and radiation.

Another method that is not so economical is leading the vapor to the low-pressure casing of the main engine. The least economical method is to lead the vapor direct into the main engine condenser.

The figures given below show the efficiency of the three methods. To produce 2,000 lb. of feed water with good coal, neglecting radiation, would require:

Vapor leading to hot well or feed water heater.....	15 lb. of coal
Vapor leading to low-pressure cylinder.....	175 lb. of coal
Vapor leading to main engine condenser.....	235 lb. of coal

Sometimes evaporators are used in multiple effect as by installing three, viz., high-pressure, intermediate, and low.

## PUMPS

There are two types, reciprocating and centrifugal, each being particularly adapted for certain conditions; the former where the water has to be lifted by suction say a distance of 20 ft. and the latter for delivering a large volume under a small head as in supplying the cooling water to a marine surface condenser.

In reciprocating pumps the pressure or head depends directly on the steam pressure in the cylinder (omitting loss of head by friction and turns), and in centrifugal the theoretical head against which a pump can deliver is represented by the pressure in the water leaving the impeller plus the pressure due to converting the velocity energy of the water leaving the impeller into pressure.

A pump should be located as near the water to be pumped as possible, and when pumping from the sea it should be placed below

the water line so that the water may flow to it by gravity. All suction pipes from the sea must be fitted with a cock or valve and a strainer placed over the outboard opening. The cock or valve should be near the hull or attached to it, so that the suction pipe to the pump can be removed for renewal or repairs. In pipes discharging overboard, unless the pump is above the water line, check valves are installed in the pipes.

When pumps are some distance above the water line, a foot valve is frequently placed in the suction. This is a check valve opening toward the pump and is put next the cock or valve attached to the hull. Its purpose is to prevent the emptying of the suction pipe while the pump is at rest. When pumps are below the water line a foot valve is not required.

If drawing or forcing water long distances or at high speeds, the diameters of the pipes should be greater than the openings on the pump.

**Suction Head** is the distance from the surface of the suction water to the center of the pump plus frictional resistance through the piping and fittings. The suction head should not exceed 25 ft.

**Discharge Head** is the distance above the pump shaft up to the point of discharge plus frictional resistance in the pipe. To find the discharge head in feet, multiply the pressure by 2.31.

$$\text{Water horse power} = \frac{\text{Gallons per minute} \times \text{head in feet}}{3960}$$

$\text{Efficiency} = \frac{\text{Water horse power}}{\text{Brake horse power}}$  Efficiency of reciprocating pumps varies from 60 to 70% and of centrifugal pumps 30 to 50.

For estimating size of boiler feed pumps, the formula  $\text{Gallons per minute} = \frac{\text{Boiler horse power}}{16.6}$  could be used.

**Reciprocating Pumps.**—Vertical reciprocating pumps are preferable to horizontal, for marine purposes, on account of the small horizontal space available on a vessel. The vertical type is extensively used for boiler feed, drainage systems, fire purposes, etc. Duplex pumps are practically two single pumps placed side by side, the valve movement of one pump being actuated by connections with the piston rod of the other.

The height to which a pump will lift water depends on atmospheric pressure. One pound per square inch corresponds to a head of water of 2.309 ft. Therefore, to find the lift of a pump, multiply

the pressure per square inch, obtained from the barometer reading, by 2.309.

*Example.* At sea level the barometer stands, say, at 30 ins., and the corresponding pressure is 14.72 lb. Thus the theoretical lift of a pump would be  $14.72 \times 2.309$  ft. = 34 ft. But in actual practice it requires a good pump to draw to a height of 28 ft.

To find the discharge of a pump in gallons per minute,

Let  $T$  = piston travel in feet per minute

$d$  = diameter of cylinder in inches

$G$  = number of U. S. gallons discharged per minute

Then  $G = .03264 \times T \times d^2$

To find the horse power necessary to elevate water to a given height, multiply the total weight of the water in pounds delivered per minute by the distance in feet between the suction and discharge water level and divide the product by 33,000. To this quotient 25% should be added for water friction, and 25% for loss in steam cylinder.

The area of the steam piston multiplied by the steam pressure gives the total amount of pressure that can be exerted. The area of the water piston multiplied by the pressure of water per square inch gives the resistance. There must be a margin between the power and the resistance to move the pistons at the required speed, say from 20 to 40% according to the speed and other conditions.

The duty of a pump is the number of foot-pounds of work actually done by 100 lb. of coal burned.

$$\text{Thus duty} = 835.53 \frac{\text{Gallons per min.} \times \text{lift in ft.}}{\text{Weight of coal burned in pounds}}$$

To find the quantity of water elevated in one minute, running at a piston speed of 100 ft. (a fair average) per minute, square the diameter of the water cylinder in inches and multiply by 4. Suppose the capacity of a 5-inch cylinder is desired; the square of the diameter is 25, which, multiplied by 4, gives 100, which is the approximate gallons per minute.

To find the diameter of a pump cylinder to move a given quantity of water per minute (assume piston speed of 100 ft. per minute), divide the number of gallons by 4, then extract the square root, and the result will be the diameter in inches.

## SINGLE-CYLINDER HORIZONTAL BOILER FEED PUMPS

Steam Cylinder	Water Cylinder	Stroke Inches	Gallons per Stroke	H.p. of Boiler, Based on 30 Lb. of Water per H.p. per Hour, which the Pump will Supply with Ease	Steam Pipe	Exhaust Pipe	Suction Pipe	Discharge Pipe
2½	1½	3	.022	12	¼	⅜	¾	½
2½	1¾	4	.041	20	¼	⅜	1	¾
3	2	4	.05	25	¼	⅜	1¼	1
3½	2¼	4	.069	30	⅜	½	1¼	1
4	2½	6	.13	60	⅜	½	1½	1¼
4½	3	6	.183	85	½	¾	2	1½
5	3¼	8	.28	135	½	¾	2	1½
6	4	8	.435	200	¾	1	2½	2
6	4	10	.54	250	¾	1	2½	2
7½	5	10	.85	400	¾	1	3	2½
8	5¼	12	1.12	550	1	1¼	3	2½
9	6	12	1.47	700	1	1¼	4	3
10	7	12	2.00	1,000	1	1½	5	4
12	8¼	12	2.77	1,350	1½	2	6	5
12	8¼	14	3.23	1,600	1½	2	6	5
14	9¼	16	4.66	2,250	1½	2	7	6
14	10	14	4.76	2,300	1½	2	8	7
14	10	16	5.44	2,700	1½	2	8	7
16	10½	18	6.74	3,300	2	2½	8	7
18	11½	18	8.09	4,000	2½	3	9	8
18	11½	20	9.00	4,500	2½	3	9	8
18	12	20	9.79	.....	2½	3	9	8
20	13	20	11.49	.....	2½	3	10	9
20	13	22	12.64	.....	2½	3	10	9
22	14	24	16.00	.....	2½	3	10	10
24	15	24	18.36	.....	3½	4	10	10
24	16	24	20.88	.....	3½	4	10	10

This rating is based on slow speed necessary when pumping water of high temperature from open heater. When pumping low temperature water, pump can be run at twice this speed.

M. T. Davidson and Co., New York. The above pumps could also be used for drainage purposes.

Hot water cannot be lifted by suction any desirable height, and the difficulty increases with the temperature. To handle hot water efficiently it should flow by gravity to the pump.



Vertical duplex pumps, as given in the following table, have 2 steam and 2 water cylinders. The water ends are of cast iron, composition lined, or may be entirely of composition. For boiler feeding these pumps have a speed of 30 to 50 single strokes per minute, but for other services they should be run at 60 to 80.

Steam Cylinder	Water Cylinder	Stroke Inches	Gallons per Single Stroke of Each Piston	Steam Pipe	Exhaust Pipe	Suction Pipe	Discharge Pipe
4	2½	4	.084	½	¾	2	1½
4½	3	6	.184	½	¾	2½	2
5	3½	6	.249	¾	1	3	2½
6	4	6	.326	1	1¼	3	2½
6	4	8	.435	1	1¼	3	2½
7	4½	8	.55	1¼	1½	4	3
8	5	10	.85	1½	2	4	3½
8	5	12	1.02	1½	2	4	3½
9	5½	10	1.03	1½	2	4½	4
9	6	10	1.225	1½	2	5	4½
9	6	12	1.469	1½	2	5	4½
10	7	12	2.00	2	2½	6	5
12	8	12	2.61	2	2½	7	6
12	8½	12	2.94	2	2½	7	6
14	9	14	3.85	2½	3	7	6

M. T. Davidson and Co., New York.

**Centrifugal Pumps.**—When the head for a centrifugal pump exceeds 100 ft. including the suction, one of the stage type should be installed. This consists of two or more impellers in separate casings mounted on the same shaft and so constructed that the water passes successively from one into the other, each impeller raising the pressure.

Centrifugal pumps are often designated as **low-lift** and **high-lift**, and sometimes are called **volute** and **turbine** pumps, but in all the theory of operation is the same.

For ordinary marine purposes a **single-stage pump** is sufficient and below is a table of direct connected centrifugal pumps of the **volute type** as built by the Worthington Steam Pump Co. Steam turbines and electric motors could be used instead of steam

engines if desired, particularly if the head is high, as steam engine driven pumps are suitable for comparatively low heads because of the limited speed of the engines which run at about 400 r. p. m. while turbines and motors run at 800 and over. On account of the small space occupied and light weight, turbine driven pumps have become popular. Besides handling the intake water for condensers, they have also worked satisfactorily for boiler feeding and for fire purposes.

One of the chief advantages of centrifugal boiler feed pumps is that they deliver a uniform pressure and volume at a given speed, eliminating the vibration in the unit and piping that is common with reciprocating pumps. Furthermore, the pressure being kept constant, a much lower margin of difference between the pump pressure and the boiler pressure is obtained than with reciprocating pumps.

A volute pump has no diffusion vanes, whereas a turbine pump has, while its casing may be either of a spiral or a circular form.

#### CENTRIFUGAL PUMPS (VOLUTE TYPE) DIRECT CONNECTED TO STEAM ENGINES

(Worthington Steam Pump Co., New York)

Dia. Steam Cyl.	Engine					Pumps		
	Stroke	Rev.	H.p.	Steam Pipe	Ex. Pipe	Suct. Pipe	Disch. Pipe	Capacity per Min.
Ina.	Ina.				Ina.	Ina.		Gallons
4	4	500	6.25	1	1¼	4	4	450
5	5	500	12.5	1½	2	6	6	1,000
6	6	400	17.5	2	2	8	8	1,800
7	6	400	23.75	2	2½	10	10	2,800
8	10	325	42.75	2½	3	12	12	4,000
9	10	325	54.	3	3½	14	14	5,500
10	10	325	66.75	3	3½	16	16	7,500
11	10	325	81.	3½	4	18	18	9,500
12	10	325	96.	3½	4	20	20	12,000
14	12	325	156.	4½	6	24	24	18,000

The capacities given in the above table are maximum and are for pumps working under heads not exceeding 20 ft. An efficiency of 65 to 75% is guaranteed by the builders on their pumps having a discharge of over 6 ins.

**CENTRIFUGAL DREDGING PUMPS**  
(Worthington Steam Pump Co.)

No. Pump (Diameter Discharge Opening)	Diameter Suction	Cubic Yards Material per Hour, 10 to 20 Per Cent. of Solids			Approximate Horse Power Required for Each 10 Feet Elevation	Will Pass Solids, Diameter, Inches
		10%	15%	20%		
4	4	14	21	28	4	2
6	6	30	45	60	8	4½
8	8	60	90	120	15	6
10	10	90	135	180	25	8
12	12	125	190	250	30	10
15	15	210	315	420	50	10
18	18	300	450	600	70	10

**Priming.**—Centrifugal pumps that are placed above the suction water level must be primed before starting; that is, all the air driven out of the pump and suction pipe and the space filled with water. When steam is available either an ejector or syphon could fill the pump and suction pipe with water, but when so doing the air cock on the pump must be open.

The peripheral speed in feet per minute necessary to lift water to a given height depends on the form of the vanes. If *a* is a straight radial vane, *b* a straight vane bent backwards, *c* a curved vane its extremity making an angle of 27 degs. with a tangent to the impeller, *d* a curved vane with an angle of 18 degs., and *e* is a vane curved in the reverse direction so that the outer end is radial, then

the peripheral speed in feet per min. for *a* =  $481 \sqrt{h}$

the peripheral speed in feet per min. for *b* =  $554 \sqrt{h}$

the peripheral speed in feet per min. for *c* =  $610 \sqrt{h}$

the peripheral speed in feet per min. for *d* =  $780 \sqrt{h}$

the peripheral speed in feet per min. for *e* =  $394 \sqrt{h}$

where *h* is the head or lift in feet. As the coefficient varies with the shape of the vanes, different speeds are necessary to hold water to the same height. To obtain the revolutions of the vanes, divide the peripheral speed by the circumference of the circle swept over by the vanes (Mech. Eng'r's Pocket Book, W. Kent).

**Doctor.**—On steamers navigating the Mississippi River and its tributaries, a combined feed pump and feed water heater called

a "doctor" is installed. This consists of a vertical beam engine with crank and flywheel operating four pumps. Two are simple lift pumps drawing water from the river and delivering it into the heating chambers overhead, while the other two are feed pumps taking their supply from the heater and delivering the water to the boilers. Each lift and force pump is of sufficient capacity to supply the entire battery of boilers, so that one pump of either kind may be disconnected for examination or repair without disturbing the regularity of the boiler feed supply.

Air Pump, see page 459.

#### PUMPS INSTALLED IN A FREIGHT STEAMER

For particulars of the steamer *Pacific* (geared turbine), see page 312.

##### Pumps

1 Main air,	Vertical twin beam, 14 ins., 28 ins., 18 ins.
1 Circulating,	Centrifugal 42-inch runner, 14 ins. dia. of suction, engine 10 inch by 10 inch.
1 Main feed,	Centrifugal, turbine-driven, 37 h. p.
1 Auxiliary,	Centrifugal, turbine-driven, 37 h. p.
1 Fire and bilge,	Duplex horizontal, 12 ins., 8½ ins., 12 ins.
1 Ballast,	12 ins., 10½ ins., 12 ins.
1 Trimming,	10 ins., 7 ins., 10 ins.
1 Sanitary,	7½ ins., 5 ins., 6 ins.
1 Fresh water,	7½ ins., 5 ins., 6 ins.
1 Evaporator,	4½ ins., 2¾ ins., 4 ins.
1 Engine room bilge,	6 ins., 5¾ ins., 6 ins.
2 Fuel oil,	6 ins., 4 ins., 6 ins.

**Installing and Operating Pumps.**—Blow out with steam all chips and dirt in steam pipe before making final connection to pump.

Never use a smaller pipe on the suction than the list calls for.

Avoid right angles in the pipe, where it is possible.

Where it is practicable, make bends with a large radius and use Y's instead of T's.

Put a foot valve and strainer on the end of the suction pipe.

Do not place the pump more than 25 ft. above the water.

Where hot water is pumped, the supply must be above the pump.

Make all joints in the suction air tight.

Keep the stuffing boxes well and evenly filled with packing.

Oil the pump before starting it, and keep the oil wiped off where it is not needed.

In cold weather drain the steam and water cylinders to prevent freezing.

For high-speed pumping and on long suction lines, have a vacuum chamber near the pump.

Ordinarily do not run pump (reciprocating) more than 100 ft. piston speed per minute.

For feeding boilers do not run piston (reciprocating pump) more than 50 ft. per minute.

For boiler feeding, a check valve must be placed in the discharge pipe near the boiler.

A pump, which when starting has pressure on its discharge valves, will often fail to lift water. This is caused by the accumulated air in the pump cylinder, which is not dislodged but merely compressed by the movement of pump piston or plunger. To get rid of this air, place a check valve in discharge near the pump and a waste cock between this check valve and the pump. Run the pump with the waste cock open until it picks up the water. If the pump has a heavy lift, connect a priming pipe (containing a good valve) from a supply of water to the suction pipe near the pump. A few strokes of the pump with the priming valve and waste cock open will enable it to catch its water.

A single double-acting pump will usually give less trouble on heavy lifts than a duplex pump.

### INTERNAL COMBUSTION ENGINES

Internal combustion engines, commonly called motors, run on a variety of fuels, as gasoline (petrol), kerosene, distillate, and producer gas. Crude oil can be successfully used only in Diesel and semi-Diesel engines. Along the Atlantic Coast engines run on gasoline and kerosene, with more running on the former than on the latter. On the Pacific Coast distillate is popular and excellent results are secured with it. In Europe the fuel is petrol, which is another name for gasoline. See Oil.

Kerosene is generally cheaper than gasoline, although it is not so powerful. Engines using kerosene do not start so quickly as those on gasoline, and they cannot be controlled as easily. With kerosene the engine has one certain speed at which it runs better than at any other; consequently this fuel is suitable only for boats running for long periods at a constant speed. It is doubtful whether an engine using kerosene has any advantages over one using gasoline, when considering the adaptability to changes of speed of the engine and freedom of carbonisation that is obtained with gasoline, even if it costs more.

Engines running on producer gas have been installed on some small commercial craft the builders of which have claimed low operating costs. But gas producers take up considerable room, and as a whole, liquid fuels are much more popular for marine use.

Engines operating on gasoline consume on an average about one pint per horse power per hour. Kerosene engines require about 6% more fuel than gasoline to get the same power. Diesel engines have been run on only .54 of a pint of crude oil per horse power per hour.

The limit of size for engines running on gasoline, kerosene, or producer gas, where the ignition is electric or hot torch, is about 500 h. p., while those running on crude oil and operating on the Diesel principle have been built up to 4,500 h. p.

**Operation.**—Engines operate on the two-cycle, four-cycle and Diesel principle. In the former, on the upstroke of the piston the air in the cylinder is compressed; then the fuel enters and is ignited, thus forcing the piston down and giving the power stroke. In the two-cycle engine there is a power stroke at every revolution of the crank shaft.

In the four-cycle the piston draws into the cylinder on the downstroke the explosive mixture of air and oil vapor, which is compressed on the upstroke and then ignited, the resulting explosion driving the piston down and the return upstroke driving out the burnt gases.

#### GAS OR GASOLINE ENGINES

##### Two-Cycle

First revolution—Downstroke: Ignition and expansion power stroke

Lower portion of downstroke: Exhausting gases and taking pure air in cylinders for cleaning, and air and gas charge.

Upstroke: Compression of charge.

##### Four-Cycle

First revolution—Downstroke: Suction of air and gas.

Upstroke: Compression of air and gas.

Second revolution—Downstroke: Ignition and expansion power stroke.

Upstroke: Exhaust.

The compression just prior to the explosion varies from 50 to 80 lb. per square inch (in Diesel engines it is about 750), and the pressure of the explosion is from 150 to 300 lb. The temperature

in the cylinders ranges from 1,900 to 2,000° F., except in Diesel engines where it is from 1,000 to 1,100.

The advantages of high compression are: (1) more power obtained from a given size of cylinder as the particles of gas and air are forced closer together; their temperature being raised by compression, ignition is more rapid and a better explosion is secured; (2) gas (fuel) of poorer quality may be used with a greater certainty of the charge igniting, for gas which will not ignite at ordinary temperature and pressure may be made more combustible at high and rapid compression; (3) higher thermal efficiency, for a high explosive pressure allows a greater range of expansion to follow without allowing the pressure to fall unduly low.

In the Diesel engine the air in the cylinder is first compressed to a pressure of 450 to 600 lb. per square inch, and the liquid fuel is forced directly into the cylinder at a pressure of about 750 lb. The heat due to the high compression (depending on the temperature required to ignite the fuel) ignites the fuel, thus forcing the piston down and giving the power stroke. The fuel is pumped under pressure into the cylinder in an extremely finely divided state by a stream of air from 150 to 300 lb. higher than that in the cylinder. This mingling with the highly heated air charge in the cylinder immediately ignites the fuel.

In the paragraphs immediately following are data on engines where the mixture in the cylinders is ignited by an electric spark, on page 492 Hot Bulb, and on page 495 Diesel.

Engines (electric ignition) may be divided into three classes, viz., high speed, for racing boats and fast runabouts, medium speed, for cruisers, and slow speed heavy duty, for towboats, lighters, and small passenger vessels. Below is a table of representative types and on page 317 is a table of motor boats.

#### Horse Power Formulae for Two- and Four-Cycle Engines.

##### Formula.

Let  $P$  = mean effective pressure, in slow speed engines about 80 lb.

$A$  = area of piston in square inches

$S$  = piston speed in feet per minute (obtained by multiplying the revolutions per minute by two times the stroke in inches and dividing by 12)

$N$  = number of cylinders

$E$  = mechanical efficiency taken at .75

$C$  = 2.5 for two-cycle engines  
4.0 for four-cycle engines

$$\text{B. h. p.} = \frac{P \times A \times S \times N \times E}{33,000 \times C}$$

## INTERNAL COMBUSTION ENGINES (ELECTRIC IGNITION)

Class of Motors	Horse Power	Number of Cylinders	Bore	Stroke	Revolutions per Minute	Length from Fly-wheel to Coupling for Propeller Shaft	Weight in Lb.
High Speed	65	4	5½	6	1,200	5' 4"	950
(Van Blerck Motor Co.) Special	90	4	5½	6	1,600	5' 4"	940
	100	6	5½	6	1,200	6' 6"	1,120
	135	8	5½	6	1,200	7' 8"	1,450
Special.....	180	8	5½	6	1,600	7' 8"	1,425
Medium Speed	3-5	1	4¾	5	550	2' 0"	325
(Frisbie Motor Co., Middletown, Conn.)	5-7	1	6	6	450	2' 3"	500
	6-10	2	4¾	5	550	2' 6"	430
	10-14	2	6	6	450	2' 9½"	700
	12-18	3	4¾	5	600	3' 2½"	680
	18-25	3	6	6	500	3' 7½"	1,050
	25-30	4	4¾	5	800	3' 6"	725
	30-40	4	6	6	550	4' 2"	1,200
	35-50	6	4¾	5	600	4' 6¼"	985
	50-75	6	6	6	550	5' 5½"	1,000
Heavy Duty Wol-verine	12-14	2	6½	7	400	5' 0"	1,550
	18-21	3	6½	7	400	5' 10"	2,470
	27	3	7½	9	350	7' 8"	3,823
	36	3	8½	9	350	7' 8"	3,925
	50	3	9½	12	300	9' 0"	6,538
	75	3	11	12	300	9' 0"	7,025
	100	3	12½	14	280	10' 3"	10,260

The horse powers in the above are based on using gasoline.

## Another Formula.

Let  $d$  = diameter of cylinder  
 $l$  = length of stroke  
 $r$  = revolutions per minute  
 $N$  = number of cylinders

Then h. p. for a two-cycle engine =  $\frac{d^3 \times l \times r \times N}{13,500}$

Then h. p. for a four-cycle engine =  $\frac{d^3 \times l \times r \times N}{1,800}$  or h. p. =

$\frac{d^3 \times N}{2.5}$  this being based on a piston speed of 100 ft. per minute.

## 1917 Formula of the American Power Boat Association.

$A$  = area of one piston in square inches  
 $N$  = number of working pistons  
 $S$  = length of stroke in inches  
 $R$  = maximum number of revolutions obtainable under racing conditions



$C$ = for 4-cycle gasoline engines	12,000
2-cycle gasoline engines	9,000
4-cycle Diesel engines	9,600
2-cycle Diesel engines	6,000

$$\text{For cruisers and open boats h. p.} = \frac{A \times N \times S \times R}{C}$$

$$\text{displacement racers and hydroplanes, h. p.} = \frac{A \times N \times S}{9}$$

**Carburetors and Vaporizers.**—The former is for gasoline and the latter for kerosene, but both have the same object, viz., to mix the fuel with the proper amount of air to form a suitable explosive mixture. There are a variety of carburetors on the market designed for high and low speed engines and for heavy and light fuels. The carburetor selected should be adapted to the speed of the engine and to the fuel.

In one type for high speed gasoline engines the fuel is controlled by a needle valve working automatically with the throttle. In another there is a jacket around the body of the carburetor through which the exhaust gases from the cylinders pass, thus heating the gasoline and vaporizing it. In another make, instead of the exhaust gases, the hot water from the cylinder jackets is circulated around it.

Before installing be sure that the gasoline tank and piping are clean and contain no particles of dirt or scale. Connect the carburetor to the intake pipe so it is about 6 ins. below the bottom of the gasoline tank; for the best results it should be as close to the cylinder as possible, and in case of multicylinder engines equidistant from each if practicable. The carburetor should be adjusted to the normal running temperature of the motor.

The ordinary gasoline carburetor will not vaporize kerosene satisfactorily, hence a special vaporizer is required. The kerosene and air pass through a nest of heated copper tubes and by so doing a vaporized mixture is secured. Just before the mixture enters the cylinders a few drops of water are mixed with it, the water, being drawn with the mixture into the cylinders, forms steam at the time of combustion, thus permitting high compression without preignition. To heat the copper tubes it is necessary to start the engine on gasoline, and after it is warmed up to shut off the gasoline and turn on the kerosene.

**Starting.**—Engines of 50 h. p. and over are started by compressed

air or by an electric motor. In the former, when the engine is running it drives a small air compressor that compresses air which is stored in a tank. From this tank pipes lead to the different cylinders. In the pipes are valves for controlling the air supply.

In the case of electric starting, the electric motor gets its energy from a storage battery. The motor turns by means of a chain the crank shaft of the engine, and when the latter is running the motor is either stopped entirely or reversed, that is, turned into a generator, and as such recharges the storage battery.

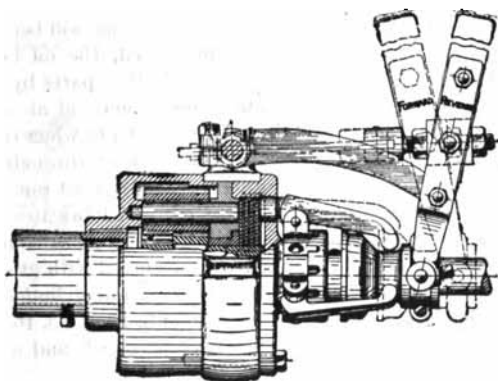

Figure 82.—Reverse Gear.

**Reverse Gears.**—In motor boats the motors run in one direction, a boat being made to go ahead or astern by changing the direction of rotation of the propeller shaft irrespective to that of the motor. This is accomplished by a lever controlling gears housed in a casing directly aft of the engine. The gearing is designed so that for full speed ahead the lever is thrown way forward, for astern way aft, and when neutral or perpendicular the boat is not under headway although the engine may be running. For small launches, sometimes propellers with reversible blades are installed.

Fig. 82 is of a reverse gear built by Snow & Petrelli, New Haven, Conn. The engine sleeve carries one of the central gears, into which meshes a short pinion, which meshes with a long pinion, that meshes with another central gear that is attached to the propeller sleeve. Whichever way the engine runs the propeller will be turned in the opposite direction. With this gear four revolutions

of the engine make three revolutions of the propeller in the reverse direction.

**Lubricating Systems.**—Nearly every engine builder has a different system. Some builders of two-cycle engines claim to have secured satisfactory cylinder, connecting rod, and crank bearing lubrication by mixing with the gasoline lubricating oil. Other builders use the splash system, which consists of partly filling the bottom of the crank case with oil, and as the cranks revolve, the oil is splashed over the bearings and connecting rods. Care must be taken that the dippers on the connecting rods barely dip into the oil, for if there is too much oil thrown, the igniters or the spark plugs will become foul.

Most builders have adopted the force feed, the oil being distributed through pipes to the bearings and other parts by a pump, driven from the engine shaft. The cylinder gets oil at about the center, the oil entering at the level of the wrist pin when the piston is down, and spreading over the cylinder wall through grooves in the piston. Some of the oil enters the hollow wrist pin, to which the end of the connecting rod is fastened, and lubricates it. The gears in the reversing gear in many instances run in a heavy oil, while the bearings outside of the engine are fitted with grease cups.

The consumption of oil for the bearings and cylinders should not exceed one and a half gallons per 1,000 b. h. p. A 16 h. p. engine has been run 820 miles on four gallons of oil, and a 32 h. p. 1,300 miles on ten gallons. (See section on Oil.)

Cooling water required for the cylinders is approximately 8 to 10 gallons per b. h. p. The cylinders should be hot, for if they are kept too cool there is a loss of efficiency and power. The water is forced through the jackets by a centrifugal pump driven by the engine, although sometimes a plunger pump is used.

**Valves.**—The valves controlling the entrance of the explosive charge into the cylinder in two-cycle engines have two or three ports. In the former, on the upstroke of the piston the charge enters the crank case through a check valve which closes on the downstroke. In the three-port, the check valve is not required.

In four-cycle engines the inlet and exhaust valves are usually operated in either of two ways: (1) the exhaust valve is cam operated with the suction of the piston operating the inlet valve on the second or charging stroke (often known as the automatic or suction inlet); or (2) the inlet and exhaust valves are mechanically operated. The latter arrangement is adapted for high speed engines, while the former (1) is for slow speed heavy duty.

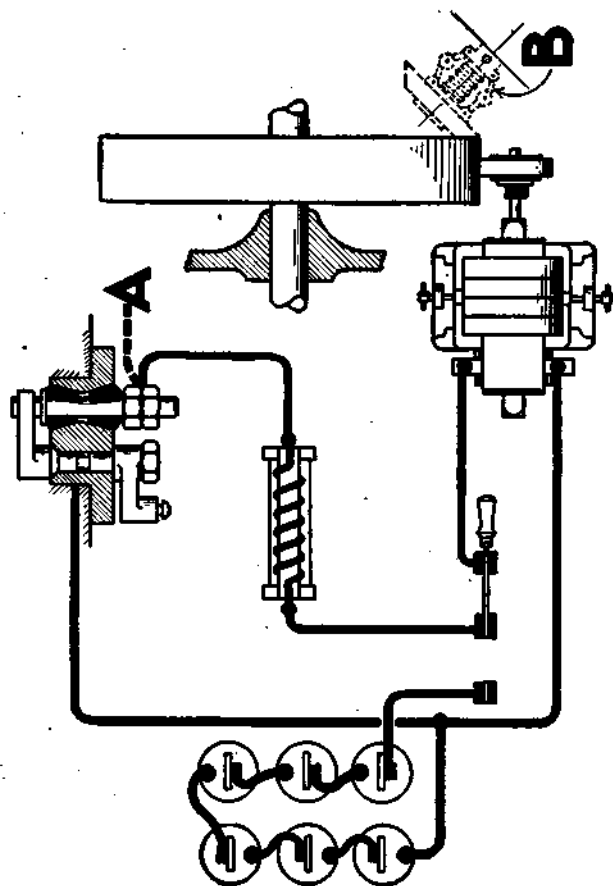

Figure 83.—Make and Break Wiring Diagram for a Single Cylinder Engine. For two or more cylinders connect the insulated terminals together by the additional wire A. B shows the position for a bevel friction governor. (Holtzer-Cabot El. Co., Boston, Mass.)

When the valves are on the opposite sides of the cylinder, the cylinder is known as the T type, and when they are both on the same side, the L; in the T two cam shafts are required while in the L only one. Another type has the valves inverted and seated directly on the top of the cylinder, but in this arrangement either an overhead cam shaft or long valve lifters are required.

It is most important that the valves be correctly timed, the exhaust valve opening soon enough that the gases will quickly pass out and will not foul the plugs, the exhaust valve closing before the inlet valve is opened.

**Ignition.**—The explosive charge may be ignited either by a hot bulb or an electric spark. In the former a bulb in the cylinder head is heated by a torch (see Hot Bulb Engines) requiring from 4 to 5 minutes before the proper temperature is reached. Electric ignition is preferable to torch for pleasure boats. An idea of the number of sparks required can be obtained from the fact that in a four-cycle engine running at 800 r. p. m. about 400 sparks are needed per minute for each cylinder.

**Make and Break Ignition.**—Electric ignition is either of the make and break (low tension) system or the jump spark (high tension). In the former a spark is produced by the breaking of an electric circuit the contact points of which are in the combustion chamber of the cylinder. There is required a battery or a magneto for generating the current, a coil, and an igniter (one for each cylinder). (See Fig. 83.)

The current is led to a coil consisting of a core of soft iron wires around which are wound several layers of heavy insulated copper wire. The current, after passing through the coil, goes to the terminals of the igniter which consists of a fixed and a movable electrode, the latter being operated by the rise and fall of a rod the end of which bears on a shaft that is driven by the main shaft of the engine by gears. The contact points of the igniter are often tipped with platinum-iridium, which insures long wear and clean points.

One of the advantages of the make and break system is that it is not easily affected by dampness and is consequently largely adopted for engines installed in open boats. Its disadvantages are that there are moving parts within the cylinder, and it is only suitable for slow speed engines.

**Jump Spark or High Tension System.**—Here (see Fig. 84) the current is transformed from a primary or low tension to a high tension

by a spark coil, and then as a high tension current it is led to the spark plug in the top of the cylinder, the current jumping across the gap between the points of the plug and by so doing creating a spark. It is evident that the spark must be controlled, otherwise there would be one continuous spark between the points of the plug. The controlling of the spark is accomplished either by a timer or a distributor.

Spark coils for high tension ignition are different from those of low tension ignition in that they are covered with another winding of fine insulated copper wire; that is, they consist of a core of soft iron wire around which is wound a few layers of coarse copper wire called the primary coil, on top of which is wound a great many layers of fine insulated copper wire called the secondary coil but not connected with the primary. When a low voltage current is broken in the primary coil, a high voltage one is induced in the secondary, and this goes to the spark plugs.

A coil is necessary for each spark plug, hence for each cylinder when a timer is used. The coils can either all be placed in a common box or a combined coil and plug made which is screwed into the top of the cylinder just like an ordinary spark plug. With a distributor (see Timers and Distributors) only a single coil is required.

High tension systems are particularly adapted for high speed engines, and there are several types on the market. For instance, the dual, where the cylinders have two plugs, one when running on the batteries and the other when on the magneto.

**Timers and Distributors.**—The time of ignition can be controlled in the jump spark system by a timer driven from the engine shaft, which completes the primary circuit between the battery or magneto and the spark coil at the proper instant at which the ignition of the charge in the cylinder must take place. If a timer is used without any other device, then a separate coil is required for each cylinder.

A distributor is a modification of a timer enabling a single coil to ignite a multicylinder engine. The distributor gives the proper distribution of the secondary current of the induction coil to each cylinder at the proper time.

Thus a timer works on the primary or low tension current, and with a timer, coils are required for each cylinder, while a distributor works on a secondary or high tension current, requiring only one coil for a multicylinder engine.

A system which has proved satisfactory is the Kent (A. Kent

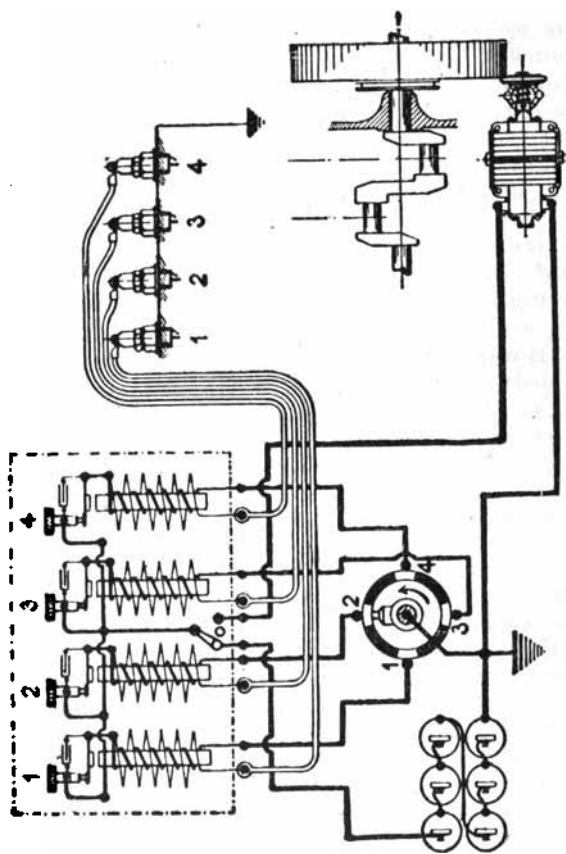

Figure 84.—Jump Spark Wiring (Holtzer-Cabot El. Co., Boston).

Mfg. Co., Philadelphia, Pa.), in which, in addition to the usual battery or magneto for generating the current, there is a device called a **unisarker**, consisting of a mechanical contact maker, a high tension distributor, and a non-vibrating spark coil. The unisarker is driven from the engine, giving one spark per revolution, the important feature in its construction being that it produces a spark of constant strength irrespective of the speed of the engine, and that the battery circuit is never closed except at the instant of the spark. Thus the engine can never stop so as to leave the ignition circuit closed if the switch is accidentally left on. As a result of the small current consumed, a set of ordinary dry cells will last several weeks.

**Timing the Ignition.**—The timing of the ignition of a single-cylinder jump spark engine is outlined below, but the same procedure is followed irrespective of the number of cylinders.

Open the priming cup or take off one of the spark plugs and put a piece of stiff wire in the cylinder so that one end rests on the top of the piston. Then by noting the rise and fall of the wire as the crank shaft is turned, the position of the piston at any part of the stroke can be determined. (1) Turn the engine so that the piston is on the top of the compression stroke. (2) Turn the flywheel about  $10^{\circ}$  more, always in the direction in which the engine is to run, so that the piston is about  $10^{\circ}$  past the high center point, and then put the timer in place with the contact points of the timer together forming a circuit. Now wire the timer to the spark coil (see section on Electricity).

**Magnetos** are small generators for furnishing the current for ignition purposes and are driven from the main engine by belts, gears, or by direct contact with the flywheel. There are two types, viz., low and high tension. The low is for either jump spark or make and break ignition, while the high is only for jump spark. A low tension magneto generates a primary current, hence a coil is required to increase it to a higher voltage. By having the proper ratio between the revolutions of the shafts of the low tension magneto and of the engine, as say four to one, the engine may be started without a battery. A low tension magneto in a jump spark circuit requires a separate spark coil for each cylinder, but when in a make and break only one coil is needed.

**High tension magnetos** are only for jump spark ignition and differ radically from the low as neither a spark coil nor a timer is necessary. In the high tension there are two windings, a high and a low, and a circuit breaker that breaks the circuit in the high



tension winding. This is located at the end of the magneto shaft and can be rocked backward and forward, thus serving to advance or retard the spark. The function of the circuit breaker is to interrupt the primary current, thereby causing an induced high tension current in the secondary winding which goes direct from the distributor binding post to the spark plug. No coil or timer is necessary, as these magnetos have a complete ignition system within themselves, having their own windings and a circuit breaker that takes the place of a timer.

The advantage of a high tension magneto is that a hot spark is generated and as there is only one circuit breaker for the primary circuit which is alike for all cylinders, more accurate timing is secured than by separate vibrating coils. These magnetos are gear driven from the engine, and as they are more sensitive than the low they must be carefully protected from the weather. On small engines that can be cranked 50 or more revolutions a minute, the engines can often be started direct on high tension magnetos, no batteries being required, but for larger sizes batteries are generally necessary.

Spark plugs are for igniting the explosive mixture in the combustion chamber. Preferably the spark between the points should be in the form of a flat sheet rather than a ball, for a spark with an extensive surface or area will ignite a greater number of mixture particles in a given time than will a thin threadlike spark. The plug should be located near the intake valve in such a manner that it will be surrounded by the fresh gas that enters during the inlet stroke. If on the exhaust side, dead gas is liable to collect around the points and cause missing.

If the engine misses, examine the spark plugs. Clean off the mica or porcelain and see that the points are about  $\frac{1}{8}$  of an inch apart. To test the plug, unscrew it and lay it on the cylinder head or other part of the engine where there is no paint. Attach a wire to the plug, but only let the outside or shell of the plug rest on the cylinder. Turn the flywheel until contact is made at the timer. If the vibrator does not buzz, adjust the screw until it works properly, then notice the size of the spark at the points of the plug. If no spark occurs take the plug apart and clean it. Then if, on reassembling, again no spark occurs, look for bad vibrator points or exhausted batteries, broken wire, or loose connections. Too much or too poor cylinder oil, and too rich a mixture, will cause the plug to foul and become sooted.

**Batteries.**—See section on Electricity.

**Motor Trouble.**—The following applies to two- and four-cycle electric ignited gasoline engines. If after cranking the engine four or five times it does not start, see that the fuel is turned on, that the electric switch is thrown in, and that there is nothing caught in the shafting. If the engine starts, then slows down, and finally stops, the fuel supply is choked or the batteries have given out.

Should the compression be weak, see if any of the spark plugs are loose, or perhaps the valves leak, or there may be a broken piston ring. If the valves leak they should be reground. This is done by taking out the valve, putting a grinding compound on the seat, replacing the valve and turning it to the right and left until a clean smooth surface is on the valve face. Care should be taken in grinding that none of the compound gets into the cylinder; if it does it should be removed.

If the engine will not start, begin a systematic search for trouble, beginning with the carburetor and then going over the ignition system.

Part	Trouble
Carburetor	Water in gasoline or in carburetor.
Ignition System	Air valve or the needle valve is out of adjustment.
	Spark plugs dirty or short circuited (see Spark Plugs).
	Broken cable or poor connection at the terminals.
	Vibrator out of adjustment or points burned.
	Weak batteries.
Engine runs but misses	Timer dirty.
	See if magneto is revolving in the direction of rotation stamped on the end.
	Open the circuit breaker and see that it is not flooded with oil and there is no oil on the contact points.
	Dirty spark plugs.
	Backfires in carburetor, too lean a mixture.
Engine pounds	Valves leak.
	Batteries weak.
	Wrong spark plug gap.
	Connections loose.
	Engine not bolted firmly to its foundation.
Cylinders get very hot	Piston ring broken.
	Shaft bearing loose.
	Connecting rod loose.
	Water circulation stopped. See if sea cock is open, pump working, and the pipes not clogged up.
	Cylinder getting no oil.

If the engine begins to backfire, this indicates that the gasoline tank is empty or the supply pipe is stopped up. Should the engine stop suddenly this may be caused by the electric circuit being accidentally broken or the supply of fuel stopped.

Abstracts from *Motor Boats*, by Chas. H. Hughes, perm. Am. Tech. Soc., Chicago.

### Hot Bulb Engines

In hot bulb (sometimes called semi-Diesel) engines no electric ignition is required, there being instead a bulb which is first heated by a torch. After the engine has started the torch may be put out, as the heat produced by the explosion of the fuel in the cylinder is sufficient to keep the bulb hot. The compression is from 85 to 215 lb. per square inch, and the pressure from the explosion 260 to 350 lb.

Engines of this type have proved very satisfactory for medium size seagoing vessels and have been installed in many sailing vessels (see page 318). They are reliable, their fuel consumption is low and a cheap grade can be used. They are built in sizes up to about 500 h.p. A well-known make is the Bolinder (built by J. and C. G. Bolinder, New York) which is of the two-cycle type with a working pressure of about one-third that of a Diesel engine. Complete combustion is obtained by mixing the fuel with air before injecting it into the cylinder. For this purpose a special nozzle has been constructed in which the fuel oil is automatically mixed with air. No water injection in the cylinders is necessary at normal load or 10% overload. The engine can run on cheap and heavy oils.

All Bolinder engines having more than one cylinder are started by compressed air. The ignition balls are heated (from 7 to 15 minutes being necessary, depending on the size of the engine), and when ready to start, open the cylinder cocks to avoid compression in the cylinders and turn the flywheel until the mark on it is on top, in which position the piston has just commenced its downward stroke. Next close the cylinder cocks. The stop valve on the air receiver is now opened and the hand wheel of the starting valve is opened 2 or 3 turns, after which by means of a hand lever the valve is opened for a moment, allowing air to enter the cylinder, and is quickly closed, the engine readily starting.

This engine is also direct reversible, the reversing being accomplished as follows:

1. The clutch is thrown out by means of a hand lever.
2. The reversing lever is pulled aft (for going astern). This

movement causes the engine to slow down at once; a charge of oil is automatically injected at the appropriate stage of the cycle and the movement of the piston is immediately reversed.

3. The reversing lever is returned to its central position.

4. The clutch is thrown in again.

The reversing is done by two hand levers. To change from astern to ahead the procedure is exactly the same except that the reversing lever is thrown over in the opposite direction.

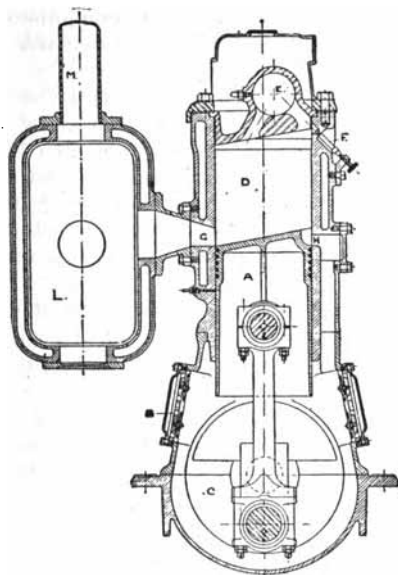

Figure 85.—Hot Bulb Engine (Bolinder Co., New York).]

The following table gives particulars of the engines.

**BOLINDER'S 4-CYLINDER DIRECT REVERSIBLE ENGINES**

Brake horse power.....	80	100	160	240	320	500
Revolutions per minute.....	425	385	325	275	225	160
Weight in pounds (approx.)....	8,700	12,600	22,800	33,600	44,400	89,600
Diameter of propeller (3 blades) inches.....	42	45	55	63	75	106

Another hot bulb engine is the two-cycle Skandia built by the Skandia Motor Works, Lysekil, Sweden. One of the features of this engine is that it works without water injection. When running without load or with a small load many engines require no water injection owing to the fact that only a small quantity of heat is imparted to the walls of the combustion chamber. If the load is increased, the heat will rise to a high degree, especially in case of overload, so that the walls, if not water cooled, become red hot, thereby causing advance ignition. Apart from the space required by water tanks, the water injection has an injurious influence upon the life of an engine. In a Skandia, the water-cooled cylinder cover makes water injection unnecessary.

In direct connection with the governor is the fuel pump which is worked through the medium of a cam. By means of an adjusting screw, combined with the governor, the fuel feed may be regulated instantaneously while the engine is running, and after the stroke of the pump has been adjusted to suit the load of the engine the engine will run continuously with the same number of revolutions. When the fuel supply is properly adjusted the exhaust gases are smokeless.

All engines of 25 h.p. and over are supplied with a starting device consisting of a starting valve and steel air tank connected by copper piping. The engine can be started by a pull on the handle of the starting valve.

Skandia engines are built in three types: (1) direct reversible like a steam engine, which is secured by means of compressed air; (2) with a reversing gear; and (3) with a reversible propeller.

SKANDIA OIL ENGINES (Direct Reversible)

Number of Cylinders	Brake Horse Power	Revolutions per Minute	Cons. of Fuel in Lb. per B.H.P. Hour at Full Load	Approximate Gross Weight, Pounds
4	90	375	6.6	14,960
4	120	375	6.38	15,906
4	140	325	6.38	18,480
4	200	300	6.38	20,570
4	240	300	6.27	29,700
4	385	250	6.16	56,100

### Diesel Engines

Engines working on the Diesel principle do not require an ignition system, as the fuel is ignited by being forced into cylinders of compressed air. The pressure in the cylinders is from 400 to 600 lb. per square inch (depending on the fuel) and as the fuel must be injected at a higher pressure, say 750 lb., an air compressor is required. These engines are started and reversed in many instances by compressed air, and the space occupied by them is about 80% of a steam engine and boiler of the same power.

Diesel engines have been installed in many freight vessels (see page 316), and on account of their low operating costs (see page 335) due to cheap fuel and the small number of men required, they have proved very satisfactory on certain routes. Submarines are driven by them when running on the surface.

Care must be exercised in the selection of fuel, because one which is suitable for one make of engine may not be for another having a different compression or system of atomization. It is an object to use the cheapest fuel possible but in a general way Diesel engines cannot use crude oils. The fuels which they do require are easily obtainable and cost very little more than crude oil. Most Diesel engines are guaranteed to run on crude oil of a certain gravity, but this gravity is so high that there are few crude oils that will comply with it. When an engine runs well on an oil of a given viscosity, it is advisable to get oil as near this viscosity as possible, otherwise the entire adjustment of the injection valves must be altered. However, a heater may be installed utilizing the warm gases from the exhaust for heating the oil.

A fair average consumption in a Diesel engine on the basis of brake horse power per hour when using fuel with a heating capacity of 18,500 B. t. u. per pound can be taken as .40 lb. per horse power hour for large engines and .46 for small. On this basis, considering that oil weighs 7.5 lb. per gallon, the fuel consumption per 100 b. h. p. hours would be about 6 gallons.

The table on page 496 gives a comparison of Diesel engines, ordinary reciprocating marine engines, and geared turbines. Allowance has been made for the difference in tonnage measurement and deadweight capacity which the systems involve. The vessel chosen is 400 ft. long between perpendiculars, 52 ft. beam, 29 ft. 9 ins. deep, and 26 ft. 1 in. draft. Total deadweight carrying capacity in tons, 8,640 (steam), 8,775 (Diesel), 8,805 (geared turbines). Speed  $10\frac{1}{2}$  knots, radius of action 3,500 miles, fuel consumption 1.6

lb. per i. h. p. per hour (reciprocating), 1.2 lb. per i. h. p. per hour (turbine), .61 lb. per i. h. p. per hour (Diesel).

Capital Invested	Oil Engine		Steam Engine		Geared Turbine	
	\$381,000		\$308,000		\$351,000	
	Per Voyage	Per Month	Per Voyage	Per Month	Per Voyage	Per Month
Insurance.....		\$2,390		\$1,800		\$2,050
Fuel (oil at \$9.77, coal at \$3.66).....	\$1,756		\$2,170		\$1,738	
Wages and provisions.....		1,700		2,000		1,950
Wear and tear.....		537		488		439
Deck and engine room stores.....		537		488		488
Port charges, at \$1.22 per ton.....	3,680		3,590		3,590	
	\$5,436	\$5,164	\$5,760	\$4,776	\$5,328	\$4,927
16 voyages.....	87,000		92,200		85,300	
12 months.....	62,000		57,300		59,200	
	\$149,000		\$149,500		\$144,500	
5% depreciation.....	19,000		15,400		17,550	
Management.....	2,440		2,440		2,440	
	\$170,440		\$167,340		\$164,490	
Freight-earning cargo carried, tons.....	16 × 8,530 = 136,480		16 × 7,890 = 126,080		16 × 7,910 = 126,560	
	170,440.00 136,480.00 = \$1.25 per ton		167,340.00 126,080.00 = \$1.33 per ton		164,490.00 126,560.00 = \$1.30 per ton	

In general, for moderate speed ships which would be driven by a single reciprocating engine, a Diesel engine ship is more costly as the machinery is more expensive and the hull also, on account of the twin screws, oiltight work, etc., but the space occupied by propelling machinery is less and the weight is less, so that there is a gain in cargo-carrying capacity and weight. See Costs. At the present state of development, Diesel engines are not suitable for high-powered vessels from engineering rather than economic reasons.

**General Features.**—For a given horse power the cylinder of a Diesel engine is  $\frac{1}{2}$  to  $\frac{1}{3}$  the diameter of a steam cylinder, while the rods and bearings are about the same size as in a steam engine of the same power. The pistons fit the cylinders very closely and are usually  $\frac{1}{100}$  of an inch smaller in diameter at the top than at

the bottom, to allow for the expansion due to heat. Six to eight rings are fitted having lapped joints, so that there is no leakage past the piston.

Diesel engines are either two- or four-cycle. In the two-cycle engine there is one working or power stroke with every revolution. This type of engine has a scavenger pump operated directly from the main engine, or scavenger pistons which are extensions of the power pistons that furnish the air required for clearing the working cylinder of its burnt gases and for filling it with fresh air which is then compressed on the return of the piston. When the exhaust valves are open, air from the scavenger pump is admitted through mechanically

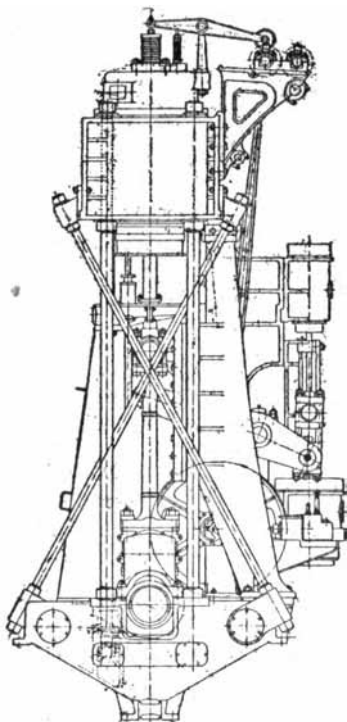

Figure 86.—End Elevation—Werkspoor Diesel Engine.



operated valves at the piston end of the cylinder, and sweeps before it the products of combustion, leaving the cylinder filled with fresh air which is then compressed on the return stroke of the piston. The two-cycle engine is more complicated than the four, and has in some cases 10% higher fuel consumption. However, it has the advantage of saving considerably in weight.

In the four-cycle type, on the down or intake stroke the air is admitted through mechanically controlled air inlet valves. On the up or return stroke this air is compressed to 400 to 600 lb. per square inch, and thereby becomes heated to a temperature of around 1,000° F. A few degrees before the completion of the compression stroke, the liquid fuel is injected into the engine cylinder through the oil injection valves and atomizers by means of highly compressed injection air, furnished by an independent high pressure compressor. This high-pressure air atomizes the oil, breaking it up into a mist which on coming in contact with the hot air in the engine cylinder is burned and gasified. The gases force the piston down on the third or working stroke, expanding gradually, much as steam expands in a cylinder after being cut off. On the fourth stroke the burned gases are expelled through the discharge or outlet valve into the exhaust pipe. The piston sweeps all the gases before it and acts as an efficient scavenger. The fuel inlet valve in the four-cycle engine is built very heavy and as it operates against high pressures it has a small movement and remains open from about  $\frac{1}{8}$  of the stroke to the minimum cut-off.

Below are cycles of Diesel engines in a tabular form.

Two-Cycle		
First Revolution	Downstroke	Injection of charge and ignition by heated air.
	Lower portion of downstroke	Exhausting gases and taking in pure air for cleaning cylinders.
	Upstroke	Compression of air to 1,000° F.
Four-Cycle		
First Revolution	Downstroke	Suction of pure air.
	Upstroke	Compression to 1,000° F.
Second Revolution	Downstroke	Injection of fuel charge, ignition by contact with heated air, expansion, power stroke.
	Upstroke	Exhaust of gases.

The fuel to the injection valves is usually pumped by a twin

**plunger**, one plunger doing most of the work and discharging the excess through an escape valve back into the suction. The second plunger is somewhat smaller and accurately measures the fuel forced through the injection valve. On the largest engines these plungers are about  $\frac{1}{4}$  to  $\frac{1}{2}$  inch in diameter with a small stroke.

The fuel is atomized by air pressure varying from 600 to 1,200 lb. per square inch, according to the make of engine and the fuel. This pressure is obtained by a three- or four-stage compressor sometimes attached to the main engine, or to an auxiliary engine, and in some cases to both. The air from the compressor is stored in steel bottles for starting, the bottles having sufficient capacity to turn over the engine for about 10 minutes.

**Injection Valve.**—This valve may be raised by cams and returned to its seat by powerful springs. Various devices have been resorted to in order to minimize friction in the stuffing box. Some companies use an oil lantern in the middle of the stuffing box; others eliminate the stuffing box entirely, having instead a stem about  $1\frac{1}{2}$  ins. in diameter and 18 ins. long, fitting closely in a sleeve with oil grooves instead of packing. The timing of the injection valve, its control by the governor, and the timing of the fuel pumps are the most delicate adjustments on Diesel engines.

**Timing of Valves.**—For the air inlet and exhaust valves the only adjustment actually necessary is to compensate for the wear of the valves, and this is done by lengthening the valve stems by sleeves.

Suction valves open about  $5^\circ$  below top center and close on the bottom center. Exhaust valves open  $10^\circ$  or  $12^\circ$  below the bottom center and close near the top center. All valves are closed during compression, expansion, and ignition, except the fuel inlet which has a lead of  $5^\circ$  to  $10^\circ$  depending on the speed of the engine, the fuel, and the type of injection valve.

**Operating Notes.**—To start a Diesel engine the air valve to the compressed air supply is opened, and after the engine has made a few revolutions the governor lever is moved and the injection valves begin to act. It is then run slowly until warmed up, as one of the greatest troubles with Diesel engines is the cracking of the cylinders owing to the constant changes of temperature.

During this period a round of the engine should be made to inspect the action of the valves, try the pet cocks, examine jacket water for temperature, and otherwise make sure that the engine is running satisfactorily. The engine should run for about 20 minutes at less

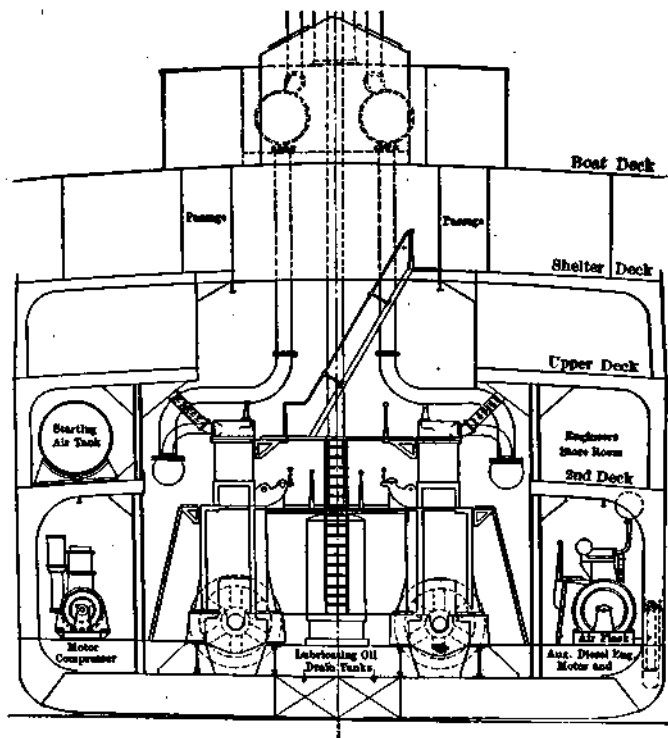

Figure 87a.—Section of motor ship, 401.5 ft. between perpendiculars; displacement at 26 ft. draft 12,100 tons; 2, 6-cylinder Burmeister & Wain engines, 24.8 in. diameter by 37.75 in. stroke, 130 r. p. m., each developing 1550 h. p. (Fig. from Int. Mar. Eng'g, New York.)

than full speed, but if necessary can be brought up to full speed in 4 or 5 minutes, but it should not be unless means are provided for circulating hot water through the engine jackets.

Engines which have failed on certain kinds of oil have run well by raising the pressure of the atomizing air, or by preheating the oil, or in other ways improving the atomization. If an engine smokes and shows carbon, this may be caused by one of the following causes:

- (1) The fuel is not being atomized.
- (2) The compression is not high enough.
- (3) There is an excess of fuel.

If the fuel does not atomize it may be because the viscosity is too high. In some cases this can be remedied by preheating the fuel or increasing the amount and pressure of the air for atomizing, but some of the heavier residual fuel oils are so viscous and have such surface tension that it is impossible to atomize them into the fine mist necessary for clean combustion. If the engine has not sufficient compression use a lighter fuel that is more easily ignited.

**Types.**—Tables 1 and 2 are of engines built by the New London Shipbuilding Co., which are of the two-cycle type. Table 1 gives data on engines for Navy use and for high speed yachts where minimum weight is required, which runs from 45 to 50 lb. per h. p. depending on the size. This weight includes all auxiliary machinery and apparatus as water and oil pumps, fuel pumps, air pumps, coolers and filters, as well as the entire reversing apparatus with compressed air receivers. Engines of the same over-all dimensions can be furnished of heavier weight, viz. 60 to 65 lb. per h. p. for medium duty, while heavy weight slow speed engines averaging 97 lb. are given in Table 2.

The above engines are of the single acting two-cycle type. On the upstroke of the piston pure air is compressed in the working cylinder to a high pressure and thereby becomes heated to a temperature above the flash point of the fuel oil. Shortly before the end of the upstroke, a spray valve opens and fuel oil is delivered, for a short time at the beginning of the downstroke, into the cylinder, and begins to burn. This downstroke is the real working stroke. At the end of this stroke the burned gases are exhausted, and the cylinders are scavenged and filled with pure air which is then compressed and the cycle repeated.

Another engine operating on the Diesel principle and of the two-cycle type is the Southwark-Harris valveless engine. The cycle of operations is as follows: (1) the fuel pump places a small quantity of crude or fuel oil in the atomizer at a certain time in the revolution of the engine and leaves it there; (2) the scavenging pump blows out the previous charge through the exhaust and leaves a charge of pure air in the cylinder when the piston is at the end of its outward stroke; (3) the piston then compresses the charge of pure air into such a small space that it becomes very hot; and (4) the atomizer spindle is lifted by the cam shaft, opening the passage

TABLE 1—DATA FOR LIGHT WEIGHT HIGH SPEED ENGINES

Number of Cylinders	Normal Brake Horse Power	Maximum Brake Horse Power	Normal R. p. m. About	Fuel Consumption Lb. About	Weight Lb. About
6	300	330	480	0.52	14,500
6	450	500	450	0.50	22,550
6	600	660	425	0.49	27,000
6	900	975	390	0.48	39,000
6	1,200	1,275	370	0.48	52,000
6	1,500	1,600	300	0.47	65,000
6	2,000	2,150	270	0.47	86,000

TABLE 2—DATA FOR HEAVY WEIGHT MODERATE SPEED ENGINES

Number of Cylinders	Normal Brake Horse Power	Maximum Brake Horse Power	Normal R. p. m. About	Fuel Consumption Lb. About	Weight Lb. About
6	300	350	300	0.49	32,000
6	600	650	275	0.47	62,000
6	900	1,000	235	0.46	91,000
6	1,200	1,300	210	0.46	115,000
6	1,500	1,600	180	0.45	140,000
6	2,000	2,100	165	0.44	188,000

The weights given include all auxiliary machinery and apparatus, such as water and oil pumps, fuel pumps, coolers and filters, as well as the compressed air starting and injecting apparatus, and thrust block.

New London Shipbuilding Co.

into the cylinder, and the injection air forces the oil lying in the atomizer into the hot charge in the form of a spray. The oil immediately ignites and further heats the charge of air and causes same to expand behind the piston and thereby transmit power to the crank shaft as steam does in a steam engine. There is no explosion and the pressure does not materially exceed the 500 lb. compression pressure, but owing to the additional heat supplied by the burning of the oil the expansion creates the power.

The important features in the Southwark-Harris engine are that cold high-pressure air is never admitted into the working cylinders, and that the engine can be started from stone cold to full power in 10 seconds and can be started or reversed without cutting off the fuel from any of the main or working cylinders.

The scavenging pump or low-pressure compressor is of the

step piston type; that is, the piston of the scavenging pump is an enlarged extension of the main piston, working in its own cylinder below the working cylinder. It is while reversing and starting the engine on compressed air that the scavenging cylinder and step piston play an important part. The using of the step piston in air starting does away with the necessity of air starting valves in the cylinder head, the scavenging air being admitted to the working cylinder through ports in its circumference. The exhaust gases pass out through ports located opposite the scavenging ports and so arranged that the piston opens and shuts them at the correct time during its travel.

The table below gives data on Southwark-Harris engines.

SOUTHWARK-HARRIS DIESEL ENGINES\*

Number of Cylinders	Dia. of Cylinder, Ins.	Stroke, Ins.	Dia. of Shaft, Ins.	Normal Revolutions per Minute	Approximate Weight Without Wheel, Lb.	I. h. p.
2	9	13	5	300	14,000	120
4	9	13	5	300	21,500	240
6	9	13	5	300	31,000	360
8	9	13	5	300	40,000	480
4	12	21	8	200	47,000	450
6	12	21	8	200	68,000	675
8	12	21	8	200	85,000	900
4	16	28	11	150	.....	800
6	16	28	11	150	.....	1,200
8	16	28	11	150	.....	1,600

\* Southwark-Harris Co., Philadelphia, Pa.

Diesel engines, built by Burmeister and Wain, Copenhagen, Denmark, have been installed on many large vessels. These engines are of the 4-cycle type, and all the large sizes have 6 cylinders cast in blocks of 3. With the present design it is claimed there is no danger of cracked cylinders as liners are fitted of special grade cast iron similar to the heads of the piston. The air compressors are self-contained and are operated from the end of the crank shaft. Six A frames support the cylinders and to them are bolted the cross-head guides. The frames have through bolts on both sides which extend from the top of the cylinders to the under side of the bed plate bearings. The pistons are only long enough to contain the

rings and are cooled with sea water like the cylinders. One of the largest built (1916) was a 6-cylinder, 4-cycle with cylinders 29.6 ins. diameter by 44 ins. stroke, giving 340 h. p. per cylinder at 100 r. p. m., with a total of 2,040 h. p. for the engine. See Fig. 87a.

Refer to the table of Motor Ships and note the 336-footer in which were installed two **Burmeister and Wain** engines. Each is of the 4-cycle type with six cylinders  $21\frac{1}{4}$  ins. diameter by  $28\frac{3}{4}$  ins. stroke, and develops about 1,000 h. p. The engines are inclosed and are fitted with a high-pressure oiling system. The valve gear is reversible by sliding the cam shaft and substituting a special set of cams for reversing. Each cylinder has its own fuel pump, which draws from day settling tanks of 12-hour capacity. In the exhaust lines are two mufflers, one at each engine and one in the deck house above with branches to the masts, the masts being hollow and of steel.

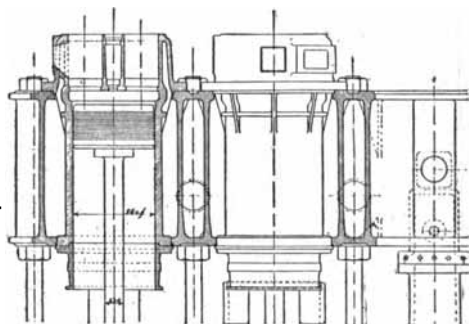

Figure 87.—Section Through Cylinder of a Werkspoor Engine.

Another make of Diesel engine which has been built in sizes up to 2,000 h. p. is the **Werkspoor**, built by the Netherlands Eng'g Co., Amsterdam, Holland, and by the Newport News Shipbuilding Company, and New York Shipbuilding Company, in the United States. One of the features of this engine is its accessibility, it being of the open type with the cylinders mounted on steel columns on both sides, and at the back are cast iron frames on which are the crosshead guides. The cylinder design (see Fig. 87) differs from other four-cycle Diesels, there being no detachable heads, and the absence of flanges affords proper water cooling all around that part of the combustion chamber which is exposed to the

greatest heat. The engine can be reversed from full ahead to astern in about 5 seconds, and can be started up from cold in 3 to 5 seconds, on an air pressure of 250 lb. per square inch. The engine is self-contained and does not require a large amount of separate auxiliary machinery. The exhaust gases are led in some vessels to a donkey boiler and sufficient heat is obtained to maintain a pressure of 100 to 120 lb. when at sea. The average consumption of Werkspoor engines including auxiliaries is about .3 lb. of oil per i. h. p. per hour.

## WERKSPoor DIESEL ENGINES

Number of Cylinders	Diameter of Cylinders	Stroke	Revs. per Min.	Approximate Weight with Compressor and Pumps, Pounds	Normal B. H. P.	Normal I. H. P.
4	12 $\frac{1}{2}$	23 $\frac{1}{2}$	200	51,520	200	265
3	15 $\frac{1}{8}$	26 $\frac{3}{8}$	200	67,200	250	300
4	15 $\frac{1}{8}$	26 $\frac{3}{8}$	175	80,640	340	450
4	19 $\frac{1}{2}$	31 $\frac{1}{2}$	140	134,400	450	600
6	15 $\frac{1}{8}$	26 $\frac{3}{8}$	175	130,000	475	635
6	20 $\frac{1}{2}$	35 $\frac{1}{2}$	130	215,040	825	1100
6	22	39 $\frac{3}{8}$	125	273,280	1020	1360
6	24 $\frac{1}{2}$	43 $\frac{1}{2}$	120	349,440	1320	1760
6	26	47 $\frac{1}{4}$	110	425,600	1500	2000

Still another make is the Craig (James Craig Engine and Machine Works, Jersey City, N. J.), the builder guaranteeing less than one half pound of fuel per brake horse power per hour. Almost any grade of fuel oil can be burned, but there are some, owing to high sulphur content, great viscosity, etc., that are undesirable. Craig engines are of the 4-cycle, direct reversible type and are built in sizes from 180 to 1,000 h. p. with 6 to 8 cylinders, each cylinder being a separate casting bolted to a rigid table carried on stanchions mounted in the bed plate. This style of framing affords an open crank case.

The valves in the cylinder heads are operated by push rods and rockers, so arranged that the heads can be detached and replaced without disturbance of any adjustments. At the back of the cylinders are located the lower exhaust ports, controlled by valves through which the exhaust pressure is released at the end of the power stroke.



A compressor furnishes the air for the injection fuel and for replenishing the storage bottles containing the air for starting and reversing. The compressor is of the two-stage type with intermediate and final air coolers of large surfaces.

The engine is reversed by affixing to the front cam shaft suitable cams arranged to function the valves for the ahead motion and suitable cams to function the valves for the astern motion, together with suitable inclines on the sides of the cams to lift and lower the push rods when necessary; and by arranging the cam shaft to move longitudinally in its bearings.

Fuel is fed to the injection valves by a single pump with a stroke that is variable at will, giving close regulation of the engine speed. From the pump the fuel is forced through adjustable distributor valves with graduated scales, fitted in convenient positions on the engine. Below are tables of sizes.

## HEAVY DUTY SERIES

B. h. p.	Cylinders	Dimensions	R. p. m.	Wt. of Engine
200	Six	9½" × 12"	420	16,500 lb.
360	Six	12½" × 15"	375	28,000 lb.
500	Eight	12½" × 15"	380	37,000 lb.

## SLOW SPEED SERIES

200	Six	9¾" × 15"	320	21,600 lb.
300	Six	12" × 18"	260	34,000 lb.
540	Six	16" × 24"	200	64,500 lb.

**Diesel Engine Installations.**—The auxiliaries may be grouped under two headings: (1) those for operating the ship; and (2) those pertaining to the propelling equipment.

Under (1) is included bilge, ballast, fire, sanitary, and fresh water pumps common to both Diesel and steam driven vessels, as also the refrigerating plant and the electric outfit, although the latter may have a direct connected Diesel engine and generator. Cargo winches, windlasses, capstans, and steering gear are generally steam operated but could be electric, the steam being furnished by a donkey boiler.

The propelling equipment includes air starting reservoirs that

may be arranged vertically against the bulkheads or horizontally in tiers, while the fuel injection air tank is close to the engine, the piping being of copper.

The main engine cylinders are cooled by sea water supplied by a pump driven from the engine. The water may be discharged into a tank above the engine, thus flowing by gravity through the cylinder jackets and thence overboard.

Exhaust piping is led to a muffler that may be placed in a stack extending above the deck. The piece next to the engine is of cast iron, so as to withstand the high temperatures of the exhaust gases, although the rest of the piping may be ordinary wrought iron which should be covered with asbestos or other insulating material.

The turning gear is generally arranged with teeth in the periphery of the flywheel and may be operated by hand, steam, compressed air, or electricity.

See table of Motor Ships and Fig. 87a.

### PIPING, TUBING, VALVES AND FITTINGS

**Piping and Tubing.**—When the size of a wrought iron pipe is given as  $\frac{1}{2}$  inch, neither the actual outside nor inside diameter is this dimension; this is an arbitrary dimension that has been fixed by the pipe manufacturers. See tables on pages 508-9. Wrought iron pipe is usually joined by screwed couplings on all sizes below 5 ins., and above this size by flanges with bolts.

Butt-welded wrought iron pipe is 70% as strong as similar butt-welded steel pipe, and lap-welded wrought iron pipe is 60% as strong as similar lap-welded steel pipe. In steel the butt weld averages 73% of the tensile strength and the lap weld 92% of the tensile strength of the material.

The principal advantage claimed for wrought iron pipe over steel is its resistance to rust and corrosion. To distinguish wrought iron pipe from steel, after removing all marks of the cutting off tool and having the end of the pipe smooth, suspend the pipe so that the end will dip into a solution of 10 parts water and 4 parts sulphuric acid, 1.84 sp. gr., say  $\frac{1}{2}$  ounce acid and  $1\frac{1}{4}$  ounces water. Keep immersed for about an hour. Remove the pipe, wash off the acid and dry quickly with a soft rag. If the pipe is steel, the end will present a solid unbroken surface, if iron the end will show ridges or rings indicating different layers of iron and streaks of cinder.

There are certain trade customs as follows: The permissible variation in weights is  $2\frac{1}{2}$ % below standard weights given in tables

STANDARD WROUGHT STEAM, GAS AND WATER PIPE  
Table of Standard Dimensions

Nominal Internal Diameter	Diameter		Nominal Thickness	Circumference		Transverse Areas			Length of Pipe per Sq. Ft. of		Length of Pipe Containing One Cubic Foot	Nominal Weight per Ft.		Number of Threads per Inch of Screw
	External	Approximate Internal Dia.		External	Internal	External	Internal	Metal	External Surface	Internal Surface		Plain Ends	Threaded and Coupled	
1/8	1.060	0.824	0.068	1.272	0.845	Sq. Ins. 1.29	Sq. Ins. 0.57	Sq. Ins. 0.72	Feet 9.431	Feet 14.199	Feet 2533.775	244	245	27
1/4	1.315	1.049	0.088	1.696	1.144	2.229	1.104	1.125	7.073	7.483	1383.789	424	425	18
3/8	1.660	1.360	0.091	2.121	1.549	3.358	1.191	1.167	5.658	7.477	784.360	567	568	18
1/2	2.375	2.067	0.109	2.639	1.954	5.54	3.04	2.950	4.547	6.141	473.906	850	852	14
3/4	3.500	3.068	0.113	3.209	2.589	8.66	5.53	3.333	3.637	4.635	270.034	1,130	1,134	14
1	4.500	4.026	0.133	4.131	3.296	1.358	1.864	4.94	2.904	3.641	166.618	1,678	1,684	11 1/2
1 1/4	5.563	5.047	0.140	5.215	4.335	2.164	2.660	6.60	2.301	2.767	96.275	2,272	2,281	11 1/4
1 1/2	6.625	6.065	0.145	5.968	5.058	2.836	2.036	7.99	2.010	2.372	70.733	2,717	2,731	11 1/2
2	8.625	8.071	0.154	7.461	6.494	4.430	3.355	10.73	1.608	1.847	42.913	3,682	3,678	11 1/2
2 1/2	10.750	10.192	0.203	9.032	7.757	6.492	4.788	13.74	1.328	1.547	30.077	5,788	5,819	8
3	12.750	12.090	0.216	10.996	9.638	9.621	7.393	2.229	1.091	1.245	19.479	7,575	7,616	8
3 1/2	14.625	13.812	0.226	12.566	11.146	12.566	9.696	2.660	1.076	1.076	14.565	9,108	9,202	8
4	16.500	15.594	0.237	14.137	12.648	15.904	12.730	3.174	0.954	0.948	11.312	10,790	10,889	8
4 1/2	18.375	17.477	0.247	15.708	14.156	19.633	15.947	3.683	0.848	0.847	9.030	12,533	12,642	8
5	20.250	19.477	0.258	17.277	15.856	22.306	20.006	4.300	0.756	0.756	7.198	14,417	14,810	8
6	24.125	23.352	0.268	20.813	19.054	34.472	28.991	5.381	0.639	0.639	4.864	18,974	19,185	8
7	28.000	27.227	0.301	23.955	22.063	45.664	39.738	6.926	0.543	0.543	3.717	23,544	23,769	8
8	31.875	31.102	0.327	27.096	24.356	58.426	51.161	7.265	0.473	0.473	2.815	24,698	25,000	8
8 1/2	35.750	35.077	0.342	29.096	25.073	68.426	60.027	8.399	0.427	0.427	2.294	28,554	28,909	8
9	39.625	39.041	0.342	31.096	27.076	77.760	67.756	9.974	0.374	0.374	1.765	33,007	34,188	8
10	43.500	42.916	0.370	33.096	29.079	90.763	81.585	11.559	0.355	0.355	1.310	37,201	38,000	8
10 1/2	47.375	46.791	0.387	35.096	31.082	103.766	94.406	13.144	0.355	0.355	0.910	41,395	42,000	8
11	51.250	50.666	0.404	37.096	33.085	116.769	107.227	14.729	0.355	0.355	0.510	45,589	46,200	8
11 1/2	55.125	54.541	0.421	39.096	35.088	129.772	120.048	16.314	0.355	0.355	0.110	49,783	50,400	8
12	59.000	58.416	0.438	41.096	37.091	142.775	132.869	17.900	0.355	0.355	0.010	53,977	54,600	8
13	62.875	62.291	0.455	43.096	39.094	155.778	145.690	19.485	0.355	0.355	0.010	58,171	58,800	8
14	66.750	66.166	0.472	45.096	41.097	168.781	158.511	21.070	0.355	0.355	0.010	62,365	63,000	8
15	70.625	70.041	0.489	47.096	43.100	181.784	171.332	22.655	0.355	0.355	0.010	66,559	67,200	8

## EXTRA STRONG WROUGHT PIPE. Table of Standard Dimensions

Diameter		Approximate Internal Diameter	Nominal Thickness	Circumference		Transverse Area			Length of Pipe Per Sq. Ft. of		Length of Pipe Containing One Cubic Foot	Nominal Weight per Foot Plain Ends
Nominal External	Internal			External	Internal	External	Internal	External	External Surface	Internal Surface		
1/2	1/2	3/8	1/16	1 1/2	1 1/2	1 1/2	1 1/2	1 1/2	1 1/2	1 1/2	1 1/2	1 1/2
3/4	3/4	5/8	1/16	1 3/4	1 3/4	1 3/4	1 3/4	1 3/4	1 3/4	1 3/4	1 3/4	1 3/4
1	1	7/8	1/16	2	2	2	2	2	2	2	2	2
1 1/4	1 1/4	1 1/8	1/16	2 1/4	2 1/4	2 1/4	2 1/4	2 1/4	2 1/4	2 1/4	2 1/4	2 1/4
1 1/2	1 1/2	1 1/4	1/16	2 1/2	2 1/2	2 1/2	2 1/2	2 1/2	2 1/2	2 1/2	2 1/2	2 1/2
2	2	1 3/4	1/16	3	3	3	3	3	3	3	3	3
2 1/2	2 1/2	2	1/16	3 1/2	3 1/2	3 1/2	3 1/2	3 1/2	3 1/2	3 1/2	3 1/2	3 1/2
3	3	2 1/4	1/16	4	4	4	4	4	4	4	4	4
3 1/2	3 1/2	2 3/4	1/16	4 1/2	4 1/2	4 1/2	4 1/2	4 1/2	4 1/2	4 1/2	4 1/2	4 1/2
4	4	3	1/16	5	5	5	5	5	5	5	5	5
4 1/2	4 1/2	3 1/4	1/16	5 1/2	5 1/2	5 1/2	5 1/2	5 1/2	5 1/2	5 1/2	5 1/2	5 1/2
5	5	3 1/2	1/16	6	6	6	6	6	6	6	6	6
5 1/2	5 1/2	3 3/4	1/16	6 1/2	6 1/2	6 1/2	6 1/2	6 1/2	6 1/2	6 1/2	6 1/2	6 1/2
6	6	4	1/16	7	7	7	7	7	7	7	7	7
6 1/2	6 1/2	4 1/4	1/16	7 1/2	7 1/2	7 1/2	7 1/2	7 1/2	7 1/2	7 1/2	7 1/2	7 1/2
7	7	4 1/2	1/16	8	8	8	8	8	8	8	8	8
7 1/2	7 1/2	4 3/4	1/16	8 1/2	8 1/2	8 1/2	8 1/2	8 1/2	8 1/2	8 1/2	8 1/2	8 1/2
8	8	5	1/16	9	9	9	9	9	9	9	9	9
8 1/2	8 1/2	5 1/4	1/16	9 1/2	9 1/2	9 1/2	9 1/2	9 1/2	9 1/2	9 1/2	9 1/2	9 1/2
9	9	5 1/2	1/16	10	10	10	10	10	10	10	10	10
9 1/2	9 1/2	5 3/4	1/16	10 1/2	10 1/2	10 1/2	10 1/2	10 1/2	10 1/2	10 1/2	10 1/2	10 1/2
10	10	6	1/16	11	11	11	11	11	11	11	11	11
10 1/2	10 1/2	6 1/4	1/16	11 1/2	11 1/2	11 1/2	11 1/2	11 1/2	11 1/2	11 1/2	11 1/2	11 1/2
11	11	6 1/2	1/16	12	12	12	12	12	12	12	12	12
11 1/2	11 1/2	6 3/4	1/16	12 1/2	12 1/2	12 1/2	12 1/2	12 1/2	12 1/2	12 1/2	12 1/2	12 1/2
12	12	7	1/16	13	13	13	13	13	13	13	13	13

## DOUBLE EXTRA STRONG WROUGHT PIPE. Table of Standard Dimensions

Diameter		Approximate Internal Diameter	Nominal Thickness	Circumference		Transverse Area			Length of Pipe Per Sq. Ft. of		Length of Pipe Containing One Cubic Foot	Nominal Weight per Foot Plain Ends
Nominal External	Internal			External	Internal	External	Internal	External	External Surface	Internal Surface		
1/2	1/2	3/8	1/16	1 1/2	1 1/2	1 1/2	1 1/2	1 1/2	1 1/2	1 1/2	1 1/2	1 1/2
3/4	3/4	5/8	1/16	1 3/4	1 3/4	1 3/4	1 3/4	1 3/4	1 3/4	1 3/4	1 3/4	1 3/4
1	1	7/8	1/16	2	2	2	2	2	2	2	2	2
1 1/4	1 1/4	1 1/8	1/16	2 1/4	2 1/4	2 1/4	2 1/4	2 1/4	2 1/4	2 1/4	2 1/4	2 1/4
1 1/2	1 1/2	1 1/4	1/16	2 1/2	2 1/2	2 1/2	2 1/2	2 1/2	2 1/2	2 1/2	2 1/2	2 1/2
2	2	1 3/4	1/16	3	3	3	3	3	3	3	3	3
2 1/2	2 1/2	2	1/16	3 1/2	3 1/2	3 1/2	3 1/2	3 1/2	3 1/2	3 1/2	3 1/2	3 1/2
3	3	2 1/4	1/16	4	4	4	4	4	4	4	4	4
3 1/2	3 1/2	2 3/4	1/16	4 1/2	4 1/2	4 1/2	4 1/2	4 1/2	4 1/2	4 1/2	4 1/2	4 1/2
4	4	3	1/16	5	5	5	5	5	5	5	5	5
4 1/2	4 1/2	3 1/4	1/16	5 1/2	5 1/2	5 1/2	5 1/2	5 1/2	5 1/2	5 1/2	5 1/2	5 1/2
5	5	3 1/2	1/16	6	6	6	6	6	6	6	6	6
5 1/2	5 1/2	3 3/4	1/16	6 1/2	6 1/2	6 1/2	6 1/2	6 1/2	6 1/2	6 1/2	6 1/2	6 1/2
6	6	4	1/16	7	7	7	7	7	7	7	7	7
6 1/2	6 1/2	4 1/4	1/16	7 1/2	7 1/2	7 1/2	7 1/2	7 1/2	7 1/2	7 1/2	7 1/2	7 1/2
7	7	4 1/2	1/16	8	8	8	8	8	8	8	8	8
7 1/2	7 1/2	4 3/4	1/16	8 1/2	8 1/2	8 1/2	8 1/2	8 1/2	8 1/2	8 1/2	8 1/2	8 1/2
8	8	5	1/16	9	9	9	9	9	9	9	9	9
8 1/2	8 1/2	5 1/4	1/16	9 1/2	9 1/2	9 1/2	9 1/2	9 1/2	9 1/2	9 1/2	9 1/2	9 1/2
9	9	5 1/2	1/16	10	10	10	10	10	10	10	10	10
9 1/2	9 1/2	5 3/4	1/16	10 1/2	10 1/2	10 1/2	10 1/2	10 1/2	10 1/2	10 1/2	10 1/2	10 1/2
10	10	6	1/16	11	11	11	11	11	11	11	11	11
10 1/2	10 1/2	6 1/4	1/16	11 1/2	11 1/2	11 1/2	11 1/2	11 1/2	11 1/2	11 1/2	11 1/2	11 1/2
11	11	6 1/2	1/16	12	12	12	12	12	12	12	12	12
11 1/2	11 1/2	6 3/4	1/16	12 1/2	12 1/2	12 1/2	12 1/2	12 1/2	12 1/2	12 1/2	12 1/2	12 1/2
12	12	7	1/16	13	13	13	13	13	13	13	13	13

and not over 5% above standard weights. All standard weight pipe unless otherwise ordered, is shipped in random lengths, threaded and furnished with couplings. Extra strong and double extra strong pipe, unless otherwise ordered, is shipped with plain ends and in random lengths without couplings. Random lengths for strong and double extra strong are considered to be from 12 to 24 ft., mill to have the privilege of supplying not exceeding 5% of the total order in lengths from 6 to 12 ft. For bundling schedule see page 20.

**"NATIONAL" STATIONARY AND MARINE BOILER TUBES**  
All Weights and Dimensions are Nominal

Outside Diameter, Inches			Thickness Inches	Thickness Birmingham Wire Gauge	Weight per Foot, Pounds	Test Pressure, Lb.	
Seamless		Lap Weld				Seamless	Lap Weld
Hot Finish	Cold Finish						
...	1	....	.095	13	.918	1000	...
...	1 $\frac{1}{4}$	....	.095	13	1.171	1000	...
...	1 $\frac{1}{2}$	....	.095	13	1.425	1000	....
...	1 $\frac{3}{4}$	1 $\frac{3}{4}$	.095	13	1.679	1000	750
2	2	2	.095	13	1.932	1000	750
2 $\frac{1}{4}$	2 $\frac{1}{4}$	2 $\frac{1}{4}$	.095	13	2.186	1000	750
2 $\frac{1}{2}$	2 $\frac{1}{2}$	2 $\frac{1}{2}$	.109	12	2.783	1000	750
2 $\frac{3}{4}$	2 $\frac{3}{4}$	2 $\frac{3}{4}$	.109	12	3.074	1000	750
3	3	3	.109	12	3.365	1000	750
3 $\frac{1}{4}$	3 $\frac{1}{4}$	3 $\frac{1}{4}$	.120	11	4.011	1000	750
3 $\frac{1}{2}$	3 $\frac{1}{2}$	3 $\frac{1}{2}$	.120	11	4.331	1000	750
3 $\frac{3}{4}$	3 $\frac{3}{4}$	3 $\frac{3}{4}$	.120	11	4.652	1000	750
4	4	4	.134	10	5.532	1000	750
4 $\frac{1}{2}$	4 $\frac{1}{2}$	4 $\frac{1}{2}$	.134	10	6.248	1000	500
5	5	5	.148	9	7.669	1000	500
...	...	6	.165	8	10.282	....	500
...	...	7	.165	8	12.044	....	500
...	...	8	.165	8	13.807	....	500
...	...	9	.180	7	16.955	....	500
...	...	10	.203	6	21.240	....	500
...	...	11	.220	5	25.329	....	500
...	...	12	.229	.	28.788	....	500
...	...	13	.238	4	32.439	....	500

In tubing the actual outside diameter is given. Boiler tubes are generally of charcoal iron, lap welded. The physical properties of boiler tubes as manufactured by the National Tube Co., Pittsburgh, Pa., are as follows:

	"National" Spellerised	Shelby Seamless Cold-drawn	Shelby Seamless Hot finished
Tensile Strength, lb. per sq. in.....	58,000	52,000	62,000
Elastic Limit, lb. per sq. in.....	36,000	32,000	42,000
Elongation in 8 inches, per cent....	22	22	22
Reduction of area, per cent.....	55	50	48

## IRON AND STEEL LAP-WELDED BOILER TUBES

External Diameter in Inches	Imperial Wire Gauge	Equiva- lents in Inches	External Diameter in Inches	Imperial Wire Gauge	Equiva- lents in Inches
1 $\frac{1}{4}$	13	.092	5 $\frac{3}{4}$	7	.176
1 $\frac{3}{8}$	13	.092	6	7	.176
1 $\frac{1}{2}$	13	.092	6 $\frac{1}{4}$	7	.176
1 $\frac{5}{8}$	13	.092	6 $\frac{1}{2}$	7	.176
1 $\frac{3}{4}$	13	.092	6 $\frac{3}{4}$	7	.176
1 $\frac{7}{8}$	13	.092	7	7	.176
2	12	.104	7 $\frac{1}{4}$	5	.212
2 $\frac{1}{8}$	12	.104	7 $\frac{1}{2}$	5	.212
2 $\frac{1}{4}$	12	.104	7 $\frac{3}{4}$	5	.212
2 $\frac{3}{8}$	11	.116	8	5	.212
2 $\frac{1}{2}$	11	.116	8 $\frac{1}{4}$	3	.252
2 $\frac{5}{8}$	11	.116	8 $\frac{1}{2}$	3	.252
2 $\frac{3}{4}$	11	.116	8 $\frac{3}{4}$	3	.252
2 $\frac{7}{8}$	11	.116	9	3	.252
3	11	.116	9 $\frac{1}{4}$	3	.252
3 $\frac{1}{4}$	10	.128	9 $\frac{1}{2}$	3	.252
3 $\frac{1}{2}$	10	.128	9 $\frac{3}{4}$	3	.252
3 $\frac{3}{4}$	10	.128	10	3	.252
4	9	.144	10 $\frac{1}{4}$	2	.276
4 $\frac{1}{4}$	9	.144	10 $\frac{1}{2}$	2	.276
4 $\frac{1}{2}$	9	.144	10 $\frac{3}{4}$	1	.300
4 $\frac{3}{4}$	8	.160	11	1	.300
5	8	.160	11 $\frac{1}{2}$	1	.300
5 $\frac{1}{4}$	8	.160	12	1	.300
5 $\frac{1}{2}$	7	.176			

Brass tubes have a maximum tensile strength of 40,000 lb. per square inch when made with a mixture to the ratio of 60 lb. of copper to 40 lb. of zinc, and will stand bending on themselves and flanging when either hot or cold without fracture.

Copper tubes made from absolutely pure copper have a maximum tensile strength of 30,000 lb.

DIMENSIONS AND AREAS OF STANDARD BOILER TUBES—Both Charcoal Iron and Steel

Diameter	Thickness		Circumference		Transverse Areas			Lenth. of Tube per Sq. Ft.		Nominal Weight per Foot-Pounds	
	Outside	Inside	Nearest B. W. G.	External	Internal	External	Internal	Metal	Ex. Surf.		In. Surf.
1	.810	.095	13	3.142	3.545	7.854	5.153	.2701	3.819	4.715	90
1 1/4	1.040	.095	13	3.927	3.330	1.2272	.8825	.3447	3.056	3.603	1.15
1 1/2	1.310	.095	13	4.712	4.115	1.7671	1.3478	.4193	2.547	2.916	1.40
1 3/4	1.560	.095	13	5.498	4.901	2.4053	1.9113	.4940	2.183	2.448	1.66
2	1.810	.095	13	6.283	5.686	3.1416	2.5730	.5686	1.909	2.110	1.91
2 1/4	2.060	.095	13	7.069	6.472	3.9761	3.3329	.6432	1.696	1.854	2.16
2 1/2	2.282	.109	12	7.854	7.160	4.8087	4.0899	.8188	1.528	1.674	2.75
2 3/4	2.532	.109	12	8.639	7.954	5.6396	4.9047	.9047	1.369	1.508	3.04
3	2.782	.109	12	9.425	8.740	6.4740	5.7286	.9787	1.273	1.373	3.33
3 1/4	3.010	.120	11	10.210	9.456	7.3088	6.5669	.9869	1.175	1.269	3.96
3 1/2	3.260	.120	11	10.996	10.242	8.2958	7.4211	1.1901	1.091	1.171	4.28
3 3/4	3.510	.120	11	11.781	11.027	9.3255	8.3669	1.360	1.018	1.088	4.6
4	3.732	.134	10	12.566	11.724	10.456	9.3762	1.627	.955	1.024	5.47
4 1/4	4.232	.134	10	14.137	13.295	15.904	14.063	1.838	.849	.902	6.17
4 1/2	4.704	.148	9	15.708	14.778	19.635	17.379	2.256	.764	.812	7.58
5	5.070	.165	8	18.850	17.813	26.274	23.249	3.025	.687	.673	10.16
6	6.670	.165	8	21.991	20.954	36.485	34.941	3.544	.546	.573	11.9
7	7.870	.165	8	25.133	24.096	50.265	46.204	4.061	.477	.498	13.65
8	8.640	.180	7	28.274	27.143	63.617	58.629	4.988	.424	.442	16.76
9	9.594	.203	6	31.416	30.175	78.840	72.201	6.249	.382	.398	21.00
10	10.560	.220	5	34.558	33.175	95.633	87.582	7.451	.347	.362	25.00
11	11.542	.229	4 1/4	37.699	36.260	113.10	104.63	8.47	.319	.330	28.50
12	12.524	.238	4	40.841	39.545	132.73	123.19	9.54	.294	.305	32.06
13	13.594	.248	3 1/2	43.982	42.424	153.94	143.22	10.72	.273	.283	36.00
14	14.852	.259	3	47.124	45.496	176.71	164.72	12.00	.254	.264	40.60
15	15.490	.270	2 1/2	50.265	48.569	201.06	187.71	13.35	.239	.247	45.20
16	17.432	.284	2	56.549	54.764	254.47	238.66	15.81	.212	.219	53.00
18	19.376	.312	1	62.832	60.873	314.16	294.86	19.30	.190	.197	63.00
20	21.314	.343	0	69.115	66.960	380.13	356.90	23.33	.173	.179	78.00
22	23.25	.375	0	75.398	73.042	452.39	424.56	27.83	.159	.164	93.00
24	25.25	.375	0	81.681	79.325	530.93	500.74	30.10	.147	.151	101.00
26	27.25	.375	0	87.965	85.608	615.75	583.21	32.54	.136	.140	109.00
28	29.25	.375	0	94.248	91.892	706.86	671.96	34.00	.127	.130	117.00

TABLE SHOWING THEORETICAL THICKNESS OF SEAMLESS COPPER TUBES FOR WORKING PRESSURES FROM 25 TO 300 LB. PER SQUARE INCH—Factor of Safety, 10

Working Pressure in Pounds per Square Inch	Inches														O. D.										
	1	1 1/4	1 1/2	1 3/4	2	2 1/4	2 1/2	2 3/4	3	3 1/4	3 1/2	3 3/4	4	4 1/4		4 1/2	4 3/4	5	5 1/4	5 1/2	5 3/4	6	6 1/4	6 1/2	6 3/4
25	36	35	34	33	33	33	31	31	31	28	28	28	26	26	26	25	25	25	24	24	24	23	23	23	23
50	33	31	30	27	27	27	24	24	24	22	22	22	20	20	20	19	19	19	19	19	19	18	18	18	18
75	30	27	26	23	23	23	21	21	21	19	19	19	18	18	18	17	17	17	17	17	17	16	16	16	16
100	28	27	25	23	21	21	19	19	19	17	17	17	16	16	16	15	15	15	15	15	15	14	14	14	14
125	26	25	23	21	19	19	17	17	17	15	15	15	14	14	14	13	13	13	13	13	13	12	12	12	12
150	23	21	19	18	18	18	16	16	16	14	14	14	13	13	13	13	13	13	13	13	13	12	12	12	12
175	22	19	18	17	17	17	15	15	15	13	13	13	12	12	12	11	11	11	11	11	11	10	10	10	10
200	21	18	17	16	16	16	14	14	14	12	12	12	11	11	11	11	11	11	11	11	11	10	10	10	10
225	20	17	16	15	15	15	13	13	13	11	11	11	10	10	10	10	10	10	10	10	10	9	9	9	9
250	19	16	15	14	14	14	12	12	12	10	10	10	9	9	9	9	9	9	9	9	9	8	8	8	8
275	18	15	14	13	13	13	11	11	11	9	9	9	8	8	8	8	8	8	8	8	8	7	7	7	7
300	17	14	13	12	12	12	11	11	11	9	9	9	8	8	8	8	8	8	8	8	8	7	7	7	7

Working Pressure in Pounds per Square Inch	Inches										O. D.		
	7	7 1/4	7 1/2	7 3/4	8	8 1/4	8 1/2	8 3/4	9	9 1/4		9 1/2	9 3/4
25	21	21	21	20	20	19	19	19	19	18	18	18	17
50	17	17	17	16	16	15	15	15	15	14	14	14	13
75	14	14	14	13	13	12	12	12	12	11	11	11	10
100	12	12	12	11	11	10	10	10	10	9	9	9	8
125	10	10	10	9	9	8	8	8	8	7	7	7	6
150	8	8	8	7	7	6	6	6	6	5	5	5	4
175	7	7	7	6	6	5	5	5	5	4	4	4	3
200	6	6	6	5	5	4	4	4	4	3	3	3	2
225	4	4	4	3	3	3	3	3	3	2	2	2	1
250	3	3	3	2	2	2	2	2	2	1	1	1	0
275	2	2	2	1	1	1	1	1	1	0	0	0	0
300	1	1	1	0	0	0	0	0	0	0	0	0	0

Seamless Brass Tubes of corresponding thickness calculated to stand 17 per cent. greater pressure. The table is theoretically correct. From Catalogue of U. T. Hungerford Co.



**TABLE SHOWING APPROXIMATE WEIGHT**  
**Stubs' of Birmingham Gauge**  
 (To ascertain the weight of Seamless Copper Tubing)

Gauge No.	3	4	5	6	7	8	9	10	11	12	13	14
Thickness of each No. in Decimal Parts of Inch	.259	.238	.220	.203	.180	.165	.148	.134	.120	.109	.095	.083
Frac. of Inch, Corresponding Closely to Gauge Nos.	$\frac{1}{4}$	$\frac{11}{48}$	..	$\frac{13}{64}$	$\frac{7}{32}$	$\frac{11}{64}$	$\frac{3}{16}$	..	$\frac{1}{8}$	..	$\frac{1}{16}$	$\frac{1}{8}$
Dia. Tubes, Ins.												
$\frac{1}{8}$												
$\frac{1}{16}$												
$\frac{3}{16}$									.18	.177	.170	.160
$\frac{1}{2}$									.27	.256	.238	.220
$\frac{5}{8}$									.35	.335	.307	.280
$\frac{3}{4}$									.44	.413	.376	.340
$\frac{7}{8}$					.70	.66	.64	.60	.57	.53	.492	.444
$1\frac{1}{8}$				.84	.79	.76	.71	.66	.61	.571	.513	.460
$1\frac{1}{4}$	1.00	1.06	1.03	.99	.92	.88	.81	.76	.70	.649	.581	.520
$1\frac{3}{8}$	1.28	1.23	1.19	1.31	1.05	.99	.92	.86	.79	.728	.650	.580
$1\frac{1}{2}$	1.47	1.41	1.35	1.28	1.18	1.11	1.03	.95	.87	.807	.718	.640
$1\frac{5}{8}$	1.65	1.58	1.50	1.43	1.31	1.23	1.13	1.05	.96	.886	.787	.700
$1\frac{3}{4}$	1.84	1.75	1.66	1.57	1.44	1.35	1.24	1.15	1.04	.964	.855	.759
$2\frac{1}{8}$	2.03	1.92	1.82	1.72	1.57	1.47	1.35	1.24	1.13	1.042	.924	.819
$2\frac{1}{4}$	2.22	2.09	1.98	1.87	1.70	1.59	1.45	1.34	1.22	1.12	.99	.88
$2\frac{3}{8}$	2.60	2.44	2.30	2.16	1.96	1.83	1.67	1.53	1.39	1.28	1.13	1.00
$2\frac{1}{2}$	2.97	2.78	2.61	2.45	2.22	2.07	1.88	1.73	1.56	1.44	1.27	1.12
$2\frac{5}{8}$	3.35	3.12	2.93	2.75	2.48	2.30	2.10	1.92	1.74	1.59	1.40	1.24
$2\frac{3}{4}$	3.72	3.47	3.25	3.04	2.74	2.54	2.31	2.11	1.91	1.75	1.54	1.36
$3\frac{1}{8}$	4.09	3.81	3.57	3.33	3.00	2.78	2.52	2.31	2.08	1.91	1.68	1.48
$3\frac{1}{4}$	4.47	4.15	3.88	3.62	3.26	3.02	2.74	2.50	2.26	2.06	1.82	1.60
$3\frac{3}{8}$	4.84	4.50	4.20	3.92	3.52	3.26	2.95	2.69	2.43	2.22	1.95	1.72
$3\frac{1}{2}$	5.21	4.84	4.52	4.21	3.78	3.50	3.16	2.89	2.60	2.38	2.09	1.84
$3\frac{5}{8}$	5.59	5.18	4.84	4.50	4.04	3.73	3.38	3.08	2.78	2.54	2.23	1.96
$3\frac{3}{4}$	5.96	5.53	5.15	4.80	4.30	3.97	3.59	3.27	2.95	2.69	2.36	2.08
$4\frac{1}{8}$	6.34	5.87	5.47	5.09	4.56	4.21	3.80	3.47	3.12	2.85	2.50	2.20
$4\frac{1}{4}$	6.71	6.21	5.79	5.38	4.82	4.45	4.02	3.66	3.30	3.01	2.64	2.32
$4\frac{3}{8}$	7.08	6.56	6.11	5.67	5.08	4.69	4.23	3.85	3.47	3.17	2.77	2.44
$4\frac{1}{2}$	7.46	6.90	6.42	5.97	5.34	4.92	4.44	4.05	3.64	3.32	2.91	2.56
$4\frac{5}{8}$	7.83	7.24	6.74	6.26	5.60	5.16	4.66	4.24	3.81	3.48	3.05	2.68
$4\frac{3}{4}$	8.20	7.59	7.06	6.55	5.86	5.40	4.87	4.43	3.99	3.64	3.19	2.79
$5\frac{1}{8}$	8.58	7.93	7.38	6.85	6.12	5.64	5.08	4.63	4.16	3.79	3.32	2.91
$5\frac{1}{4}$	8.95	8.27	7.69	7.14	6.38	5.88	5.30	4.82	4.33	3.95	3.46	3.03
$5\frac{3}{8}$	9.33	8.62	8.01	7.43	6.64	6.11	5.51	5.01	4.51	4.11	3.60	3.15
$5\frac{1}{2}$	9.70	8.96	8.33	7.72	6.90	6.35	5.72	5.21	4.68	4.27	3.73	3.27
$5\frac{5}{8}$	10.07	9.30	8.65	8.02	7.16	6.59	5.94	5.40	4.85	4.42	3.87	3.39
$5\frac{3}{4}$	10.45	9.65	8.96	8.31	7.42	6.83	6.15	5.59	5.03	4.58	4.01	3.51
$5\frac{7}{8}$	10.82	9.99	9.28	8.60	7.68	7.07	6.37	5.79	5.20	4.74	4.15	3.63

To determine weight per foot of a tube of a given  
 weights given below under

Gauge No.	3	4	5	6	7	8	9	10	11	12	13	14
Increase in Lb. per Ft.	1.5487	1.8077	1.1174	.9514	.7480	.6285	.5057	.4145	.3324	.2743	.2084	.1500

*The above Weights are theoretically correct, but variations must be*

**PER FOOT OF SEAMLESS BRASS TUBING**

Measured in Outside Diameters.

Add 5 per cent to the Weights of Brass Tubing.)

Gauge No.	15	16	17	18	19	20	21	22	23	24	25	26	27
Thickness of each No. in Decimal Parts of Inch	.072	.065	.068	.049	.042	.035	.032	.028	.025	.022	.020	.018	.016
Frac. of Inch, Corresponding Closely to Gauge Nos.	..	1/16	..	1/16	..	..	1/16	..	..	..	..	..	1/16
Di. Tubes, Ins.													
1/8		.045	.045	.043	.040	.036	.034	.031	.029	.026	.024	.022	.020
1/8	.006	.062	.067	.078	.070	.062	.057	.051	.047	.042	.039	.035	.032
1/8	.148	.139	.129	.114	.101	.087	.080	.072	.065	.058	.053	.049	.043
3/8	.200	.186	.170	.149	.131	.112	.104	.092	.083	.074	.067	.061	.055
3/8	.252	.233	.212	.184	.161	.137	.127	.112	.101	.090	.082	.074	.066
3/8	.304	.279	.254	.220	.192	.163	.150	.132	.119	.106	.096	.087	.078
1/2	.356	.326	.296	.255	.222	.188	.173	.152	.137	.121	.111	.100	.089
1/2	.403	.373	.338	.290	.252	.213	.196	.173	.155	.137	.125	.113	.101
1/2	.460	.420	.380	.326	.283	.238	.219	.193	.173	.153	.140	.126	.112
1/2	.511	.467	.421	.361	.313	.264	.242	.213	.191	.169	.154	.139	.124
1/2	.563	.514	.463	.396	.343	.289	.265	.233	.209	.185	.169	.152	.136
5/8	.645	.561	.505	.432	.373	.314	.288	.253	.227	.201	.183	.165	.148
5/8	.667	.608	.547	.467	.404	.339	.311	.274	.245	.217	.197	.178	.159
5/8	.719	.655	.589	.502	.434	.365	.334	.294	.263	.232	.211	.191	.171
1	.77	.70	.63	.54	.46	.389	.358	.314	.281	.248	.226	.204	.182
1	.87	.79	.71	.61	.52	.439	.404	.351	.317	.280	.255	.230	.205
1 1/8	.96	.80	.80	.68	.59	.490	.450	.395	.354	.312	.284	.256	.228
1 1/8	1.08	.98	.88	.75	.65	.540	.496	.435	.390	.343	.313	.282	.251
1 1/8	1.19	1.08	.96	.82	.71	.591	.542	.476	.426	.375	.342	.306	.274
1 1/8	1.29	1.17	1.05	.89	.77	.641	.588	.516	.462	.407	.371	.334	.....
1 1/8	1.39	1.26	1.13	.96	.83	.692	.635	.556	.498	.439	.399	.360	.....
1 1/8	1.50	1.36	1.22	1.03	.89	.742	.681	.597	.534	.470	.428	.386	.....
2	1.60	1.45	1.30	1.10	.95	.793	.727	.637	.570	.502	.457	.412	.....
2 1/8	1.71	1.55	1.38	1.17	1.01	.843	.773	.678	.606	.534	.486	.....	.....
2 1/8	1.81	1.64	1.47	1.24	1.07	.894	.819	.718	.642	.566	.515	.....	.....
2 1/8	1.91	1.73	1.55	1.32	1.13	.944	.866	.758	.678	.597	.544	.....	.....
2 1/8	2.02	1.83	1.63	1.39	1.19	.995	.912	.799	.714	.629	.573	.....	.....
2 1/8	2.12	1.92	1.72	1.46	1.25	1.045	.958	.839	.750	.661	.....	.....	.....
2 1/8	2.23	2.01	1.80	1.53	1.31	1.096	1.004	.880	.786	.693	.....	.....	.....
2 1/8	2.33	2.11	1.89	1.60	1.37	1.146	1.050	.920	.822	.724	.....	.....	.....
3	2.43	2.20	1.97	1.67	1.43	1.197	1.096	.960	.859	.756	.....	.....	.....
3 1/4	2.54	2.30	2.05	1.74	1.49	1.247	1.143	1.001	.895	.788	.....	.....	.....
3 1/4	2.64	2.39	2.14	1.81	1.55	1.298	1.189	1.041	.931	.820	.....	.....	.....
3 1/4	2.74	2.48	2.22	1.88	1.62	1.348	1.235	1.082	.967	.851	.....	.....	.....
3 1/4	2.85	2.58	2.30	1.95	1.66	1.399	1.281	1.122	1.003	.883	.....	.....	.....
3 1/4	2.95	2.67	2.39	2.02	1.74	1.449	1.327	1.162	1.039	.915	.....	.....	.....
3 1/4	3.06	2.76	2.47	2.09	1.80	1.50	1.373	1.203	1.075	.946	.....	.....	.....
3 1/4	3.16	2.86	2.56	2.16	1.86	1.55	1.42	1.243	1.111	.976	.....	.....	.....

Inside Diameter, add to weights in above list the corresponding gauge numbers.

Gauge No.	15	16	17	18	19	20	21	22	23	24	25	26	27
Increase in Lb. per Ft.	.1197	.0975	.0777	.0554	.0407	.0283	.0236	.0181	.0144	.0111	.0082	.0075	.0060

expected in practice. From Catalogue of U. T. Hungerford Co.

TABLE SHOWING APPROXIMATE WEIGHT  
 Stubs' or Birmingham Gauge.  
 (To ascertain the weight of Seamless Copper Tubing)

Gauge No.	3	4	5	6	7	8	9	10	11	12
Thickness of each No. in decimal Parts of Inch	.259	.238	.220	.203	.180	.165	.148	.134	.120	.109
Frac. of Inch, Corresponding Closely to Gauge Nos.	$\frac{1}{4}$	$\frac{11}{48}$	..	$\frac{15}{64}$	$\frac{1}{8}$	$\frac{11}{64}$	$\frac{9}{64}$	..	$\frac{1}{8}$	..
Dia. Tubes, Ins.										
4	11.19	10.33	9.60	8.90	7.94	7.31	6.58	5.98	5.37	4.89
4½	11.57	10.68	9.91	9.19	8.20	7.54	6.79	6.17	5.55	5.05
4¾	11.94	11.02	10.23	9.48	8.46	7.78	7.01	6.37	5.72	5.21
5	12.32	11.38	10.55	9.77	8.72	8.02	7.22	6.56	5.89	5.37
5¼	12.69	11.71	10.87	10.07	8.98	8.26	7.43	6.75	6.06	5.52
5½	13.06	12.05	11.18	10.36	9.24	8.50	7.65	6.94	6.24	5.68
5¾	13.44	12.39	11.50	10.65	9.50	8.73	7.86	7.14	6.41	5.84
6	13.81	12.74	11.82	10.95	9.76	8.97	8.07	7.33	6.58	6.00
6¼	14.18	13.06	12.14	11.24	10.02	9.21	8.29	7.53	6.76	6.15
6½	14.56	13.42	12.45	11.53	10.28	9.45	8.50	7.72	6.93	6.31
6¾	14.93	13.77	12.77	11.82	10.53	9.69	8.71	7.91	7.10	6.47
7	15.31	14.11	13.09	12.12	10.79	9.92	8.93	8.11	7.28	6.62
7¼	15.68	14.45	13.41	12.41	11.06	10.16	9.14	8.31	7.45	6.78
7½	16.05	14.80	13.72	12.70	11.31	10.40	9.35	8.49	7.62	6.94
7¾	16.43	15.14	14.04	13.00	11.57	10.64	9.57	8.69	7.80	7.10
8	16.80	15.48	14.36	13.29	11.83	10.88	9.78	8.88	7.97	7.25
8¼	17.17	15.83	14.67	13.58	12.09	11.12	9.99	9.07	8.14	7.41
8½	17.52	16.51	15.31	14.17	13.01	11.59	10.42	9.46	8.49	7.72
8¾	17.87	17.20	15.94	14.75	13.13	12.07	10.85	9.86	8.84	8.04
9	18.22	17.89	16.58	15.34	13.65	12.54	11.28	10.23	9.18	8.35
9¼	20.16	18.57	17.21	15.92	14.17	13.02	11.70	10.62	9.53	8.67
9½	20.91	19.26	17.85	16.51	14.69	13.50	12.13	11.01	9.87	8.98
9¾	21.66	19.95	18.48	17.10	15.21	13.97	12.56	11.39	10.22	9.30
10	22.41	20.64	19.12	17.68	15.73	14.45	12.98	11.78	10.57	9.61
10¼	23.07	21.27	19.69	18.20	16.33	15.03	13.49	12.22	10.96	9.97
10½	23.82	21.95	20.32	18.80	16.87	15.51	13.91	12.62	11.32	10.30
10¾	24.56	22.62	20.96	19.37	17.38	15.99	14.35	13.01	11.66	10.61
11	25.30	23.30	21.60	19.97	17.90	16.47	14.47	13.40	12.00	10.92

To determine weight per foot of a tube of a given  
 weights given below under

Gauge No.	3	4	5	6	7	8	9	10	11	12
Increase in Lb. per Foot	1.5487	1.3077	1.1174	.9614	.7480	.6285	.6057	.4145	.3324	.2743

The above Weights are theoretically correct.

## BRASS TUBING

517

## PER FOOT OF SEAMLESS BRASS TUBING

Measured in Outside Diameters.

Add 5 per cent to the Weights of Brass Tubing.)

Gauge No.	13	14	15	16	17	18	19	20	21	22	23	24
Thickness of Each No. in Decimal Parts of Inch	.095	.083	.072	.065	.058	.049	.042	.035	.032	.028	.025	.022
Frac. of Inch, Corresponding Closely to Gauge Nos.	$\frac{3}{32}$	$\frac{3}{32}$	..	$\frac{1}{4}$	..	$\frac{3}{64}$	..	..	$\frac{1}{16}$	..	..	..
Dia. Tubes, Ins.												
4	4.28	3.75	3.26	2.95	2.64	2.23	1.92	1.601	1.466	1.284	1.147	1.010
4½	4.42	3.87	3.37	3.05	2.72	2.30	1.98	1.651	1.512	1.324	1.183	..
4¾	4.56	3.99	3.47	3.14	2.81	2.38	2.04	1.702	1.558	1.364	1.219	..
4⅞	4.69	4.11	3.58	3.23	2.89	2.45	2.10	1.752	1.604	1.405	1.255	..
5	4.83	4.23	3.88	3.33	2.97	2.52	2.16	1.803	1.650	1.445	1.291	..
5¼	4.97	4.35	3.78	3.42	3.06	2.59	2.22	1.853	1.697	1.486	..	..
5½	5.11	4.47	3.89	3.52	3.14	2.66	2.28	1.904	1.743	1.520	..	..
5¾	5.24	4.59	3.99	3.61	3.22	2.73	2.34	1.954	1.789	1.568	..	..
5⅞	5.38	4.71	4.09	3.70	3.31	2.80	2.40	2.005	1.835	1.607	..	..
6	5.52	4.83	4.20	3.79	3.39	2.87	2.46	2.055	1.881	..	..	..
6¼	5.65	4.95	4.30	3.89	3.48	2.94	2.52	2.106	1.928	..	..	..
6½	5.79	5.07	4.41	3.98	3.56	3.01	2.58	2.156	1.974	..	..	..
6¾	5.93	5.19	4.51	4.08	3.64	3.08	2.65	2.207	2.02	..	..	..
6⅞	6.07	5.31	4.61	4.17	3.73	3.15	2.71	2.257	..	..	..	..
7	6.20	5.43	4.72	4.26	3.81	3.22	2.77	2.308	..	..	..	..
7¼	6.34	5.55	4.82	4.36	3.99	3.29	2.83	2.358	..	..	..	..
7½	6.48	5.67	4.93	4.45	3.98	3.37	2.89	2.409	..	..	..	..
7¾	6.62	5.81	5.13	4.64	4.15	3.51	..	..	..	..	..	..
7⅞	7.03	6.15	5.34	4.83	4.31	3.65	..	..	..	..	..	..
8	7.30	6.39	5.55	5.01	4.48	3.79	..	..	..	..	..	..
8¼	7.57	6.63	5.76	5.20	4.65	3.93	..	..	..	..	..	..
8½	7.85	6.87	5.96	5.30	..	..	..	..	..	..	..	..
8¾	8.12	7.11	6.17	5.58	..	..	..	..	..	..	..	..
8⅞	8.40	7.35	6.38	5.76	..	..	..	..	..	..	..	..
9	8.71	7.63	6.64	7.05	..	..	..	..	..	..	..	..

Inside Diameter, add to weights in above list the corresponding gauge numbers.

Gauge No.	13	14	15	16	17	18	19	20	21	22	23	24
Increase in Lb. per Ft.	.2084	.1590	.1197	.0975	.0777	.0554	.0407	.0283	.0236	.0181	.0144	.0112

but variations must be expected in practice.

Copper pipes over 5 ins. diameter are usually of sheet copper with the edges brazed together.

### SEAMLESS BRASS AND COPPER PIPE—IRON PIPE SIZES

Made to Correspond with Iron Pipe and to Fit Iron Pipe Size Fittings

Same as Iron Size	Outside Diameter	Inside Diameter	Weight per Foot	
			Brass	Copper
Inches	Inches	Inches	Lb.	Lb.
$\frac{1}{8}$	.405	.281	.25	.260
$\frac{1}{4}$	.540	.375	.43	.450
$\frac{3}{8}$	.675	.494	.62	.650
$\frac{1}{2}$	.840	.625	.90	.960
$\frac{3}{4}$	1.05	.822	1.25	1.310
1	1.315	1.062	1.70	1.790
$1\frac{1}{4}$	1.66	1.368	2.50	2.630
$1\frac{1}{2}$	1.90	1.600	3.00	3.150
2	2.375	2.062	4.00	4.200
$2\frac{1}{2}$	2.875	2.500	5.75	6.04
3	3.50	3.062	8.30	8.72
$3\frac{1}{2}$	4.00	3.500	10.90	11.45
4	4.50	4.000	12.29	13.33
$4\frac{1}{2}$	5.00	4.500	13.90	14.60
5	5.563	5.062	15.75	16.54
6	6.625	6.125	18.45	19.23

To determine the Safe Working Pressure for seamless brass and copper tubing in pounds per square inch, multiply the tensile strength (see above) by the thickness of the metal in inches or decimal parts of an inch, and divide the product by the radius (one-half the inside diameter of the tube) expressed in inches, and the quotient will be the bursting pressure in pounds per square inch. Divide this bursting pressure by a factor of safety, say 6, which will give the safe working pressure. See Strength of Materials.

The U. S. Steamboat-Inspection Rules give the following formula for the thickness of copper steam pipes. Thickness in inches =  $\frac{P \times D}{6,000} + .0625$ , where  $P$  = working pressure in lb. per sq. in., and  $D$  = inside diameter of the pipe in inches.

## SEAMLESS COPPER TUBE

Hard Drawn, in 12-Foot Lengths

Stubs' Gauge	Outside Diameter Inches	Weight per Ft. in Lb.	Stubs' Gauge	Outside Diameter Inches	Weight per Ft. in Lb.
21	$\frac{1}{8}$	.036	10	$2\frac{1}{4}$	3.43
21	$\frac{3}{16}$	.060	12	$2\frac{1}{4}$	2.82
20	$\frac{1}{4}$	.091	10	$2\frac{1}{2}$	3.84
20	$\frac{5}{16}$	.118	12	$2\frac{1}{2}$	3.16
19	$\frac{3}{8}$	.169	14	$2\frac{1}{2}$	2.44
19	$\frac{7}{16}$	.202	10	$2\frac{3}{4}$	4.25
18	$\frac{1}{2}$	.268	12	$2\frac{3}{4}$	3.49
18	$\frac{5}{8}$	.304	11	3	4.19
18	$\frac{3}{4}$	.342	14	3	2.93
17	$\frac{7}{8}$	.486	10	$3\frac{1}{4}$	5.06
17	$1$	.574	10	$3\frac{1}{2}$	5.47
16	$1\frac{1}{8}$	.730	14	$3\frac{1}{2}$	3.43
16	$1\frac{3}{8}$	.830	10	$3\frac{3}{4}$	5.87
15	$1\frac{1}{4}$	1.03	10	4	6.28
14	$1\frac{3}{8}$	1.30	14	4	3.94
14	$1\frac{1}{2}$	1.43	10	$4\frac{1}{4}$	6.69
14	$1\frac{5}{8}$	1.55	10	$4\frac{1}{2}$	7.09
13	$1\frac{3}{4}$	1.91	10	$4\frac{3}{4}$	7.50
13	2	2.20	10	5	7.91
14	2	1.93	10	6	9.52

**Bending Pipes and Tubes.**—The radius a pipe or tube is bent to should never be less than 5 diameters, and a length of straight pipe equal to 2 or 3 diameters should be provided at each end for handling in the process of bending. When bending welded pipes the weld should always be on the side of the pipe when bent, never on the outside of the curve and not on the inside if it can be avoided.

**Flow of Water through Pipes and Sizes of Pipes.**—A fair velocity is 100 ft. per minute. To find the velocity in feet per minute necessary to discharge a given volume of water in a given time, multiply the number of cubic feet of water by 144 and divide the product by the area of the pipe in inches.

To find the area of a required pipe, the volume and velocity of water being given, multiply the number of cubic feet of water by 144 and divide the product by the velocity in feet per minute. The area being found, to get the diameter refer to table of areas

or divide by .7851 and take square root of the quotient. Or diameter of pipe =  $4.95 \sqrt{\frac{\text{Gallons per minute}}{\text{velocity in feet per minute}}}$

## VELOCITY OF FLOW OF WATER

In Feet per Minute, Through Pipes of Various Sizes, for Varying Quantities of Flow

Gallons per Minute	¼ In.	1 In.	1¼ Ins.	1½ Ins.	2 Ins.	2½ Ins.	3 Ins.	4 Ins.
5	218	122½	78½	54½	30½	19½	13½	7½
10	436	245	157	109	61	38	27	15½
15	653	367½	235½	163½	91½	58½	40½	23
20	872	490	314	218	122	78	54	30½
25	1090	612½	392½	272½	152½	97½	67½	38½
30	...	735	451	327	183	117	81	46
35	...	857½	549½	381½	213½	136½	94½	53½
40	...	980	628	436	244	156	108	61½
45	...	1102½	706½	490½	274½	175½	121½	69
50	...	...	785	545	305	195	135	76½
75	...	...	1177½	817½	457½	292½	202½	115
100	...	...	...	1090	610	380	270	153½
125	...	...	...	...	762½	487½	337½	191½
150	...	...	...	...	915	585	405	230
175	...	...	...	...	1067½	682½	472½	268½
200	...	...	...	...	1220	780	540	306½

## LOSS IN PRESSURE

Due to Friction in Pounds per Square Inch for Pipe 100 Feet Long

By G. A. Ellis, C. E.

Gallons Discharged per Minute	¼ In.	1 In.	1¼ Ins.	1½ Ins.	2 Ins.	2½ Ins.	3 Ins.	4 Ins.
5	3.3	0.84	0.31	0.12	...	...	...	...
10	13.0	3.16	1.05	0.47	0.12	...	...	...
15	28.7	6.98	2.38	0.97	...	...	...	...
20	50.4	12.3	4.07	1.66	0.42	...	...	...
25	78.0	19.0	6.40	2.62	...	0.21	0.10	...
30	...	27.5	9.15	3.75	0.91	...	...	...
35	...	37.0	12.4	5.05	...	...	...	...
40	...	48.0	16.1	6.52	1.60	...	...	...
45	...	...	20.2	8.15	...	...	...	...
50	...	...	24.9	10.0	2.44	0.81	0.35	0.09
75	...	...	56.1	22.4	5.32	1.80	0.74	...
100	...	...	...	3.90	9.46	3.20	1.31	0.33
125	...	...	...	...	14.9	4.30	1.99	...
150	...	...	...	...	21.2	7.0	2.85	0.69
175	...	...	...	...	28.1	9.46	3.85	...
200	...	...	...	...	37.5	12.47	5.02	1.23

TABLE OF COMPARATIVE AREAS OF PIPE

	$\frac{3}{4}$	1	$1\frac{1}{4}$	$1\frac{1}{2}$	$1\frac{3}{4}$	2	$2\frac{1}{2}$	3	$3\frac{1}{2}$	4	5	6	7	8	9	10
$\frac{3}{4}$	1.															
$\frac{1}{2}$	1.8															
$\frac{1}{4}$	3.3	1.8														
$\frac{3}{8}$	5.3	2.9	1.5													
$\frac{1}{2}$	9.3	5.1	2.7	1.7												
$\frac{3}{4}$	15.0	8.3	4.5	2.8	1.6											
1	26.1	14.3	7.8	4.9	2.8	1.7										
$1\frac{1}{4}$	35.3	19.5	10.6	6.7	3.8	2.4	1.4									
2	58.6	32.2	17.5	11.0	6.3	3.9	2.2	1.6								
$2\frac{1}{2}$	83.5	45.9	24.4	15.7	9.0	5.5	3.2	2.3	1.4							
3	129.0	71.0	33.3	24.2	13.8	8.6	5.0	3.6	2.2	1.5						
$3\frac{1}{2}$	172.6	90.6	51.6	32.4	18.5	11.4	6.6	4.8	2.9	2.1	1.3					
4	222.1	122.3	66.3	41.8	23.9	14.8	8.5	6.2	3.8	2.7	1.7	1.3				
5	348.5	192.0	104.2	65.6	37.5	23.2	13.4	9.8	6.0	4.1	2.7	2.0	1.6			
6	504.1	277.5	150.7	94.8	54.1	33.5	19.3	14.2	8.6	6.0	3.9	2.9	2.3	1.4		
7	676.6	372.1	202.1	127.0	72.6	44.9	25.9	19.0	11.2	8.1	5.2	3.9	3.0	1.9	1.3	
8	873.2	480.7	261.1	164.0	93.8	58.0	33.4	24.5	14.9	10.5	6.8	5.2	3.9	2.5	1.8	1.3
9	1094.7	602.6	327.2	205.9	117.6	72.7	41.9	30.8	18.7	13.1	8.5	6.3	4.9	3.1	2.1	1.6
10	1375.8	757.3	411.3	258.6	147.8	92.0	52.7	33.7	23.5	16.5	10.7	7.9	6.2	3.9	2.8	2.0
																1.3

(Thus a  $\frac{1}{4}$ -inch pipe is equivalent to 1.8  $\frac{1}{8}$ -inch pipe, a  $\frac{3}{8}$ -inch to 1.8  $\frac{1}{4}$ -inch or 3.3  $\frac{1}{8}$ -inch.)



Flanges for wrought iron pipe are attached in a variety of ways, the most common for sizes from 1¼ to 15 ins. is to screw the flanges on the pipe. Or for sizes larger than 6 ins. the flanges may be shrunk on and the pipe peened over or expanded into a recess in the flange face, after which the flange is sometimes faced off on a lathe.

Flanges for copper pipe may be brazed on. The U. S. Steamboat-Inspection Rules state: "The flanges of all copper steam pipes over 3 ins. in diameter shall be made of brass or bronze composition, forged iron or steel, or open hearth steel castings and shall be securely brazed or riveted to the pipe. Flanges shall not be

STANDARD COMPANION FLANGES FOR STEAM: WORKING PRESSURES UP TO 125 LB.

Flanges of cast iron, ferro-steel, forged steel, and malleable iron, for wrought iron pipe

Size of Pipe, Ins.	Dia. of Flange, Ins.	Thick-ness of Flange, Ins.	Dia. of Hub, Ins.	Length of Thread, Ins.	Dia. of Bolt Circle, Ins.	Number of Bolts.	Size of Bolts, Ins.	Length of Bolts, Ins.	Dia. of Bolt Holes, Ins.
¾	3½	7/16	1½	5/8	2½	4	3/8	1½	½
1	4	7/16	1½	11/16	3	4	7/16	1½	7/16
1¼	4½	1½	2½	3/4	3⅝	4	1	1½	11/16
1½	5	1½	2⅝	7/8	3⅞	4	1½	1¾	5/8
2	6	5/8	3⅝	1	4¾	4	5/8	2	3/4
2½	7	11/16	3⅝	1 1/16	5½	4	5/8	2¼	3/4
3	7½	3/4	4 5/16	1 1/8	6	4	5/8	2½	3/4
3½	8½	11/16	4 7/8	1 1/8	7	4	5/8	2½	3/4
4	9	15/16	5 3/8	1 3/16	7½	8	5/8	2¾	3/4
4½	9¼	15/16	5 13/16	1¼	7¾	8	3/4	3	7/8
5	10	15/16	6 7/16	1 1/8	8½	8	3/4	3	7/8
6	11	1	7 1/16	1 1/16	9½	8	3/4	3	7/8
7	12½	1 1/8	8 5/8	1 1/2	10¾	8	3/4	3	7/8
8	13½	1 1/8	9 1/8	1 5/8	11¾	8	3/4	3	7/8
9	15	1 1/8	10 5/8	1¾	13¼	12	3/4	3¼	7/8
10	16	1 3/8	11 11/16	1 7/8	14¼	12	7/8	3½	1
12	19	1 1/4	14 1/8	2 1/16	17	12	7/8	3¾	1
14	21	1 3/8	15 7/16	2 1/16	18¾	12	1	4¼	1 1/8
15	22¼	1 3/8	16 7/16	2 1/16	20	16	1	4¼	1 1/8
18	23½	1 7/8	17½	2 1/16	21¾	16	1	4¼	1 1/8
18	25	1 15/16	19 9/16	2 5/8	22¾	16	1 1/8	4¾	1 1/4
20	27½	1 11/16	21¾	2¾	25	20	1 1/8	5	1 1/4
22	29½	1 13/16	23 3/8	2 7/8	27¼	20	1 1/4	5½	1 3/8
24	32	1 7/8	26	3	29½	20	1 1/4	5½	1 3/8

From Crane Co., Chicago.

less than 4 times the required thickness of pipe, plus one-fourth of an inch, and shall be fitted with such number of good and substantial bolts as shall make the joints at least equal in strength to all parts of the pipe."

The tensile strength per square inch of various materials for pipe flanges is as follows: ordinary grade cast iron 14,000, high grade cast iron 22,500, ferro-steel 33,500, malleable iron 37,000, forged steel 51,000, cast steel 67,000.

Flanges may have the following faces: plain face, raised face smooth finish for gaskets, raised face finished for ground joint, tongue and groove, male and female, plain face corrugated and plain face scored. Plain straight face is for pressures less than 125 lb., and raised smooth face or tongue and groove for high pressures.

**EXTRA HEAVY COMPANION FLANGES FOR WORKING PRESSURES UP TO 250 LB.**

Flanges of cast iron, ferro-steel, cast steel, and malleable iron, for wrought iron and steel pipe

Size of Pipe, Ins.	Dia. of Flange, Ins.	Thick-ness of Flange, Ins.	Dia. of Hub, Ins.	Length of Thread, Ins.	Dia. of Bolt Circle, Ins.	Number of Bolts	Size of Bolts, Ins.	Length of Bolts, Ins.	Dia. of Bolt Holes, Ins.
1	4½	1½	2½	1	3¼	4	½	2	5/8
1¼	5	1¾	2½	1¼	3¾	4	½	2¼	5/8
1½	6	1¾	2½	1¼	4½	4	5/8	2½	5/8
2	6½	1¾	3½	1¾	5	4	5/8	2½	¾
2½	7½	1	4	1¾	5½	4	¾	3	¾
3	8¼	1½	4½	1½	6½	8	¾	3¼	¾
3½	9	1¾	5¼	1½	7¼	8	¾	3½	¾
4	10	1¼	5¾	1¾	7¾	8	¾	3½	¾
4½	10½	1½	6¾	1½	8½	8	¾	3½	¾
5	11	1¾	6¾	1¾	9¼	8	¾	3¾	¾
6	12½	1¾	7½	2	10½	12	¾	3¾	¾
7	14	1½	9	2½	11¾	12	¾	4	1
8	15	1½	10½	2½	13	12	¾	4¼	1
9	16¼	1¾	11½	2¼	14	12	1	4¾	1½
10	17½	1¾	12½	2½	15¼	16	1	5	1½
12	20½	2	14½	2½	17¾	16	1½	5½	1½
14	23	2½	15½	2½	20¼	20	1½	5¾	1¾
15	24½	2½	16½	2½	21½	20	1¾	6	1¾
16	25½	2¼	18	2½	22½	20	1¾	6	1¾
18	28	2¾	20½	3½	24¾	24	1¾	6¼	1¾
20	30½	2½	22½	3¼	27	24	1¾	6¾	1½
22	33	2¾	24½	3½	29¼	24	1½	7	1½
24	36	2¾	26¾	3½	32	24	1½	7½	1¾

**Screw Threads for Bolts and Nuts.**—In the United States the standard is the Sellers, having a thread angle of 60 degs., the thread being flattened at the top and filled in at the bottom, the width of the flat in both cases being one-eighth of the pitch and the depth of thread is  $.649 \times$  pitch. In Great Britain the standard is the Whitworth, having a thread angle of 55 degs., round at top and bottom, and a depth of  $.640 \times$  pitch.

## BOLTS AND NUTS

U. S. Standard screw threads, for dia. at root and tests see page 93.

Dia. of Bolt, In.	Threads Per In.	Hexagonal Heads and Nuts		Square Heads and Nuts		Height, Hex. or Sq. Head or Nut
		Long Dia.	Short Dia.	Long Dia.	Short Dia.	
$\frac{1}{4}$	20	$\frac{11}{16}$	$\frac{1}{2}$	$\frac{11}{16}$	$\frac{1}{2}$	$\frac{1}{4}$
$\frac{5}{16}$	18	$\frac{11}{16}$	$\frac{13}{16}$	$\frac{11}{16}$	$\frac{13}{16}$	$\frac{5}{16}$
$\frac{3}{8}$	16	$\frac{11}{16}$	$\frac{11}{8}$	$\frac{11}{16}$	$\frac{11}{8}$	$\frac{3}{8}$
$\frac{7}{16}$	14	$\frac{11}{16}$	$\frac{11}{8}$	$\frac{11}{16}$	$\frac{11}{8}$	$\frac{7}{16}$
$\frac{1}{2}$	13	1	$\frac{7}{8}$	$\frac{11}{16}$	$\frac{7}{8}$	$\frac{1}{2}$
$\frac{9}{16}$	12	$1\frac{1}{8}$	$\frac{7}{8}$	$\frac{11}{16}$	$\frac{7}{8}$	$\frac{9}{16}$
$\frac{5}{8}$	11	$1\frac{1}{8}$	$1\frac{1}{8}$	$1\frac{1}{2}$	$1\frac{1}{8}$	$\frac{5}{8}$
$\frac{3}{4}$	10	$1\frac{1}{8}$	$1\frac{1}{4}$	$1\frac{1}{2}$	$1\frac{1}{4}$	$\frac{3}{4}$
$\frac{7}{8}$	9	$1\frac{1}{8}$	$1\frac{1}{8}$	$2\frac{1}{2}$	$1\frac{7}{8}$	$\frac{7}{8}$
1	8	$1\frac{1}{8}$	$1\frac{1}{8}$	$2\frac{1}{2}$	$1\frac{5}{8}$	1
$1\frac{1}{8}$	7	$2\frac{1}{8}$	$1\frac{1}{4}$	$2\frac{1}{2}$	$1\frac{11}{16}$	$1\frac{1}{8}$
$1\frac{1}{4}$	7	$2\frac{1}{8}$	2	$2\frac{1}{2}$	2	$1\frac{1}{4}$
$1\frac{3}{8}$	6	$2\frac{1}{8}$	$2\frac{1}{8}$	$3\frac{1}{2}$	$2\frac{1}{8}$	$1\frac{3}{8}$
$1\frac{1}{2}$	6	$2\frac{3}{4}$	$2\frac{3}{8}$	$3\frac{1}{2}$	$2\frac{3}{8}$	$1\frac{1}{2}$
$1\frac{5}{8}$	$5\frac{1}{2}$	$2\frac{3}{4}$	$2\frac{3}{8}$	$3\frac{6}{8}$	$2\frac{3}{8}$	$1\frac{5}{8}$
$1\frac{3}{4}$	5	$3\frac{1}{8}$	$2\frac{3}{4}$	$3\frac{6}{8}$	$2\frac{3}{4}$	$1\frac{3}{4}$
$1\frac{7}{8}$	5	$3\frac{1}{8}$	$2\frac{11}{16}$	$4\frac{1}{2}$	$2\frac{11}{16}$	$1\frac{7}{8}$
2	$4\frac{1}{2}$	$3\frac{5}{8}$	$3\frac{1}{8}$	$4\frac{1}{2}$	$3\frac{1}{8}$	2
$2\frac{1}{4}$	$4\frac{1}{2}$	$4\frac{1}{16}$	$3\frac{1}{2}$	$4\frac{1}{2}$	$3\frac{1}{2}$	$2\frac{1}{4}$
$2\frac{1}{2}$	4	$4\frac{1}{2}$	$3\frac{7}{8}$	$5\frac{1}{2}$	$3\frac{7}{8}$	$2\frac{1}{2}$
$2\frac{3}{4}$	4	$4\frac{3}{8}$	$4\frac{1}{4}$	6	$4\frac{1}{4}$	$2\frac{3}{4}$
3	$3\frac{1}{2}$	$5\frac{3}{8}$	$4\frac{5}{8}$	$6\frac{1}{2}$	$4\frac{5}{8}$	3
$3\frac{1}{4}$	$3\frac{1}{2}$	$5\frac{3}{4}$	5	$7\frac{1}{8}$	5	$3\frac{1}{4}$
$3\frac{1}{2}$	$3\frac{1}{4}$	$6\frac{1}{4}$	$5\frac{3}{8}$	$7\frac{3}{8}$	$5\frac{3}{8}$	$3\frac{1}{2}$
$3\frac{3}{4}$	3	$6\frac{3}{4}$	$5\frac{3}{4}$	$8\frac{1}{2}$	$5\frac{3}{4}$	$3\frac{3}{4}$
4	3	$7\frac{3}{8}$	$6\frac{1}{8}$	$8\frac{1}{2}$	$6\frac{1}{8}$	4

## SCREW THREADS—WHITWORTH OR BRITISH STANDARD

Dia.	Threads Per In.	Dia.	Threads Per In.	Dia.	Threads Per In.	Dia.	Threads Per In.	Dia.	Threads Per In.
$\frac{1}{4}$	20	$\frac{5}{16}$	11	1	8	$1\frac{1}{4}$	5	3	$3\frac{1}{2}$
$\frac{3}{8}$	18	$\frac{11}{16}$	11	$1\frac{1}{4}$	7	$1\frac{1}{2}$	$4\frac{1}{2}$	$3\frac{3}{4}$	$3\frac{3}{4}$
$\frac{1}{2}$	16	$\frac{3}{4}$	10	$1\frac{1}{2}$	7	2	$4\frac{1}{2}$	$3\frac{1}{2}$	$3\frac{1}{2}$
$\frac{5}{8}$	14	$\frac{11}{8}$	10	$1\frac{3}{4}$	6	$2\frac{1}{4}$	4	$3\frac{3}{4}$	3
$\frac{3}{4}$	12	$\frac{7}{8}$	9	$1\frac{1}{2}$	6	$2\frac{1}{2}$	4	4	3
$\frac{7}{8}$	12	$\frac{15}{16}$	9	$1\frac{3}{4}$	5	$2\frac{3}{4}$	$3\frac{1}{2}$		

**Screw Threads for Pipe.**—The standard in the United States is the Briggs. The thread has an angle of 60 degs., is rounded at top and bottom, so that the depth of the thread =

$$\frac{.8}{\text{number of threads per inch}}$$

The thread is perfect for a distance

from the end of the pipe =  $\frac{.8 \text{ dia. of pipe} + 4.8}{\text{number of threads per inch}}$ , then there

are two threads flat at the top but perfect at the bottom, and then four threads imperfect at the top and bottom. The taper of the pipe at the end is  $\frac{1}{16}$  in. per in., that is  $\frac{1}{32}$  in. on each side. In Great Britain the standard is the Whitworth, having the same thread form as for Whitworth bolts and nuts, the threads being cut either straight or with a taper of  $\frac{1}{16}$  in. per in.

## STANDARD U. S. PIPE THREADS

Nominal Size of Pipe, Ins.	Dia. of Pipe at Top of Thread, Ins.	Dia. of Pipe at Bottom of Thread, Ins.	Number of Threads Per In.	Nominal Size of Pipe, Ins.	Dia. of Pipe at Top of Thread, Ins.	Dia. of Pipe at Bottom of Thread, Ins.	Number of Threads Per In.
$\frac{1}{8}$	.393	.334	27	$3\frac{1}{2}$	3.938	3.738	8
$\frac{1}{4}$	.522	.433	18	4	4.434	4.234	8
$\frac{3}{8}$	.656	.568	18	$4\frac{1}{2}$	4.931	4.731	8
$\frac{1}{2}$	.815	.701	14	5	5.490	5.290	8
$\frac{3}{4}$	1.025	.911	14	6	6.546	6.346	8
1	1.283	1.144	$11\frac{1}{2}$	7	7.540	7.340	8
$1\frac{1}{4}$	1.626	1.488	$11\frac{1}{2}$	8	8.534	8.334	8
$1\frac{1}{2}$	1.866	1.728	$11\frac{1}{2}$	9	9.527	9.327	8
2	2.339	2.201	$11\frac{1}{2}$	10	10.645	10.445	8
$2\frac{1}{2}$	2.819	2.619	8	11	11.639	11.439	8
3	3.441	3.241	8	12	12.632	12.432	8

## WHITWORTH OR BRITISH STANDARD PIPE THREADS

Nominal Size of Pipe, Ins.	Dia. of Pipe at Top of Thread, Ins.	Dia. of Pipe at Bottom of Thread, Ins.	Number of Threads Per In.	Nominal Size of Pipe, Ins.	Dia. of Pipe at Top of Thread, Ins.	Dia. of Pipe at Bottom of Thread, Ins.	Number of Threads Per In.
$\frac{1}{8}$	.383	.337	28	3	3.460	3.344	11
$\frac{1}{4}$	.518	.451	19	$3\frac{1}{4}$	3.700	3.584	11
$\frac{3}{8}$	.656	.589	19	$3\frac{1}{2}$	3.950	3.834	11
$\frac{1}{2}$	.825	.734	14	$3\frac{3}{4}$	4.200	4.084	11
$\frac{5}{8}$	.902	.811	14	4	4.450	4.334	11
$\frac{3}{4}$	1.041	.950	14	$4\frac{1}{4}$	4.950	4.834	11
$\frac{7}{8}$	1.189	1.098	14	5	5.450	5.334	11
1	1.309	1.193	11	$5\frac{1}{2}$	5.950	5.834	11
$1\frac{1}{4}$	1.650	1.534	11	6	6.450	6.334	11
$1\frac{1}{2}$	1.882	1.766	11	7	7.450	7.322	10
$1\frac{3}{4}$	2.116	2.000	11	8	8.450	8.322	10
2	2.347	2.231	11	9	9.450	9.322	10
$2\frac{1}{4}$	2.587	2.471	11	10	10.450	10.322	8
$2\frac{1}{2}$	2.960	2.844	11	11	11.450	11.290	8
$2\frac{3}{4}$	3.210	3.094	11	12	12.450	12.290	8

**Packing and Gaskets for Pipe Flanges.**—The flanges are first covered with plumbago or lamp black, and then the gasket put on; after which the nuts on the flange bolts are tightened up. Packing comes in rolls from which the gaskets are cut, or the gaskets can be purchased already cut to size. For high-pressure superheated steam, a packing composed of long fiber asbestos and rubber with a brass wire insertion has given satisfactory results. For low-pressure steam and cold water, rubber packings are used. In some cases metal packing is required, and here corrugated copper has given good service.

**LENGTH OF THREAD ON PIPE THAT IS SCREWED INTO VALVES OR FITTINGS TO MAKE A TIGHT JOINT**

Size of Pipe, Ins.	Length of Thread, Ins.	Size of Pipe, Ins.	Length of Thread, Ins.
$\frac{1}{8}$	$\frac{1}{4}$	$3\frac{1}{2}$	$1\frac{1}{4}$
$\frac{1}{4}$	$\frac{3}{8}$	4	$1\frac{1}{8}$
$\frac{3}{8}$	$\frac{3}{8}$	$4\frac{1}{2}$	$1\frac{1}{8}$
$\frac{1}{2}$	$\frac{1}{2}$	5	$1\frac{3}{8}$
$\frac{3}{4}$	$\frac{1}{2}$	6	$1\frac{1}{4}$
1	$\frac{5}{8}$	7	$1\frac{5}{8}$
$1\frac{1}{4}$	$\frac{5}{8}$	8	$1\frac{5}{8}$
$1\frac{1}{2}$	$\frac{5}{8}$	9	$1\frac{3}{8}$
2	$1\frac{1}{4}$	10	$1\frac{1}{2}$
$2\frac{1}{2}$	$1\frac{1}{2}$	12	$1\frac{5}{8}$
3	1	....	....

**Nipples and Couplings.**—Nipples are pieces of standard pipe threaded at each end. When the threads meet at the center the pipe is called a close nipple, and if a small amount of unthreaded surface is left a short nipple. Other nipples are classified as long and extra long, the latter ranging from 4 to 12 ins., the length increasing by even inches. Nipples are threaded either right hand or right and left hand.

Couplings are of wrought iron and are threaded internally for receiving the ends of the pipes to be joined. They are threaded either right hand or right and left hand.

Unions are classed under two headings, viz., nut unions and flange unions. The former are ordinarily for 2-inch pipe and smaller, and are of malleable iron, brass and malleable iron, or all brass. Flange unions are for sizes larger than 2 ins. and are of cast iron or malleable iron, in three weights, standard, extra heavy, and hydraulic.

**Materials for Piping Systems.**

Fire main	copper
Water service	brass
Boiler feed	copper
Steam	copper or steel
Exhaust steam	copper or wrought iron
Main drain	wrought iron
Steam heating	wrought iron
Ammonia and brine	wrought iron or mild steel

The fittings in ammonia piping when screwed should be of extra heavy malleable iron with recessed ends for soldering. Flanged fittings should have a male and female portion.

In some instances where there is little pressure and the temperature is not much above the normal atmosphere, the pipe may be of lead. Its indifference to iron and steel as regards galvanic action makes it a suitable material for bilge suction pipes. Lead piping is often used for the discharge from toilets on motor boats, where, owing to the cramped quarters, it is impossible to fit any other kind.

The factor of safety for steam piping should never be less than 6, for there are stresses due to expansion and contraction, water hammer and vibration which must be allowed for. Corrosion must also be considered. In laying out a steam line, care must be taken to give it easy bends to allow for contraction and expansion. In some instances slip joints are fitted. According to one authority, Briggs, the effect of each right angle bend is equivalent to increasing the

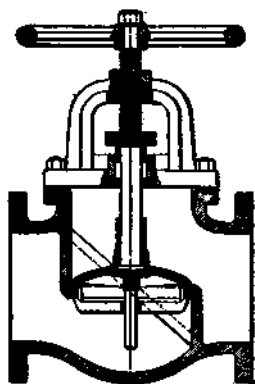

Figure 88.—Globe Valve—Rising Wheel.

length 40 diameters, and that of each globe valve is equivalent to increasing the length 60 diameters.

Valves, Cocks and Fittings are of cast iron, malleable iron, composition, and of cast steel either screwed or flanged. They may be classified as follows:

1. Low pressure for pressures up to 60 lb. per square inch.
2. Standard pressure for working pressures up to 125 lb. per square inch.
3. Medium pressure for working pressures up to 125-175 lb. per square inch.
4. High pressure for working pressures up to 175-250 lb. per square inch.
5. Hydraulic for water pressure up to 800 lb.

All fittings on wrought iron pipe over 6 ins. should be flanged and should have gaskets between the flanges. Even when the piping is of small size and with screwed couplings, there should be an occasional flanged fitting for ease in making up the piping.

The distinguishing feature between a valve and a cock is the amount of bearing and tightening surface. Valves bear and grind upon a narrow and small seat when closed, whereas cocks bear and grind upon a wide and long seating surface. The wear in valves is much less, and they are kept tight much easier under high pressure than cocks. Cocks, however, can be opened quicker.

In purchasing a valve the following points should be noted: that it has sufficient weight of metal to prevent its being bent or sprung when connected with the piping; that it has valve seats that are easily repaired, freedom from pockets, and is arranged so the stem can be packed under pressure.

Valves of 3 ins. and smaller usually have screw tops, while those of larger sizes have yokes. For high pressure, the outside yoke and screw pattern is preferable as the engineer is able to tell at once the position of the gate. Valve bodies are generally of brass for small sizes up to 2½ ins. and of cast iron, semi-steel, or steel for those larger. There are two kinds of stems, one rising when the hand wheel is turned, the hand wheel remaining stationary, and the other has the hand wheel rise with the valve stem. Valves of 6 ins. and over should have by-passes for ease in opening.

Globe and angle valves have circular seats, and their important features are strength and tightness. Globe valves should be set to close against pressure, for if placed the opposite way they could not be opened if the valve became detached from the stem. An

angle valve is a form of globe valve with the inlet at the bottom and outlet at the side.

**Check Valves.**—When the flow of steam or water is always in one direction check valves are installed, the valves closing themselves should the direction of flow be changed. There are several forms on the market, some with a swing valve, others spring controlled.

**Gate Valves.**—Here the closing portion slides in a groove, and their face to face distance is less than in globe valves of the same size. They should never be placed in a steam line with the spindle down. They are made either with a rising stem or a rising wheel.

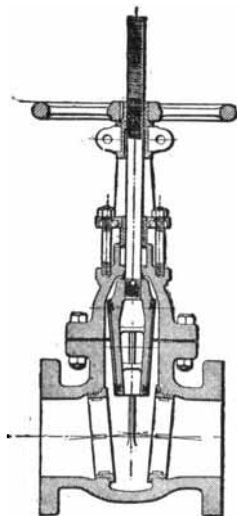

Figure 89.—Gate Valve—Rising Stem.

**Reducing Valves.**—To reduce the pressure from a higher to a lower, as to reduce the steam from the boiler to a pressure of 15 lb. or less for heating purposes.

**Butterfly valves** have the valve pivoted. Sometimes a valve of this type is placed near the engine throttle valve. Is, however,



largely for ventilating systems and elsewhere where the pressure is small. In butterfly and in gate valves the passages through them are straight, thus forming practically a section of the pipe to which they are fitted.

**Throttle Valve**, see Engine Fittings.

**Blow-off Valves** should always be installed on the boiler so that the pressure will come on top of the disk. They should be opened wide when blowing off, so as to save the disks and seats from wear. These valves are liable to be cut by scale and other boiler impurities, and hence it is essential to select one so constructed that it can be repaired quickly. Some have removable seat rings.

**Atmospheric Exhaust Relief Valves** are placed in branches from the main exhaust line leading to the atmosphere. They remain closed while the vacuum is maintained in the condenser, but should the vacuum be lost the valve will automatically open, permitting the engine to exhaust freely into the atmosphere until the vacuum is restored, when the valve will close again.

**Kingston Valve**.—Here water enters when the valve disk is pushed outward from its seat. Should the valve stem break, the disk would be forced back on its seat again and thus act as a non-return valve. These valves are chiefly for sea injection, and have been installed on many submarines.

**Manifold**.—A rectangular cast iron chest containing several valves by which compartments and pumps may be so connected that one or more pumps may be used to pump out a compartment. At the bottom of the manifold are connections to the suction pipes, and at the upper part at either end is the pump suction.

**Pipe Coverings**, see Insulating Materials.

## SECTION VII

### ELECTRICITY

**Ohm ( $R$ )**, the unit of resistance, is represented by the resistance offered to an unvarying electric current by a column of mercury 14.452 grammes in mass, of a constant cross-sectional area, 106.3 cm. long, at a temperature of melting ice. It may be conceived as about the resistance of the following lengths of copper wire of the Brown and Sharpe gauge given.

94 ft. No. 20 B. and S.	380 ft. No. 14 B. and S.
124.4      19	605          12
150         18	961          10
239         16	1529         8

**Amperes ( $C$ )**, the unit of current, is represented by the unvarying current which when passed through a solution of nitrate of silver (according to a specification adopted by the International Congress of Electricians, Chicago, Ill., 1893) in water deposits silver at the rate of .001118 gramme per second.

**Volt ( $E$ )**, the unit of electromotive force, is the electromotive force that, steadily applied to a conductor whose resistance is one ohm, will produce a current of one ampere.

**Coulomb ( $Q$ )**, the unit of quantity, is the quantity of electricity transferred by a current of one ampere in one second.

**Farad**, the unit of capacity, is the capacity of a conductor charged to a potential of one volt by one coulomb of electricity.

**Joule**, the unit of work, is the energy expended in one second by a current of one ampere against a resistance of one ohm.

**Watt**, the unit of power, is the work done at the rate of one joule per second.

**Henry**, the unit of induction, is the induction in the circuit when the electromotive force induced in the circuit is one volt

while the inducing current varies at the rate of one ampere per second.

Let  $C$  = current in amperes  
 $E$  = electromotive force in volts  
 $R$  = resistance in ohms

Then  $C = \frac{E}{R}$  (often called Ohm's Law)

Amperes  $\times$  volts = watts

746 watts = 1 horse power

One watt =  $\frac{1 \text{ h. p.}}{746}$

1,000 watts = one kilowatt (kw.)

One kilowatt =  $\left\{ \begin{array}{l} 1.34 \text{ h. p.} \\ 2,654,200 \text{ ft.-lb. per hour} \\ 44,240 \text{ ft.-lb. per minute} \\ 737.3 \text{ ft.-lb. per second} \\ 3,412 \text{ heat units per hour} \\ 56.9 \text{ heat units per minute} \\ .948 \text{ heat units per second} \end{array} \right.$

One megohm = 1,000,000 ohms

**Voltage.**—This is either 100–110 or 200–220 volts for steamers. For the latter voltage the wiring is on the three-wire system, the large motors being connected across the outers, and small motors and lighting being connected between each outer and the middle wire. In the low-pressure or voltage system there is less danger of shock to passengers and crew, and less risk of fire and leakage. In the high-pressure the cost of wiring is considerably reduced, but the high pressure requires better insulation.

On war vessels 220 volts have proved very satisfactory. For installations of 1,000 kw. and upwards, the higher pressure is adopted from an economical standpoint. For motors, the high voltage can be chosen to advantage as a 220-volt machine is slightly superior in efficiency to a 110, the size of commutator is reduced in length, and the size of brushes is approximately halved. The 220-volt machines are, as a rule, smaller, lighter and cheaper. Heaters can be run equally well off either voltage but lighting is better off low owing to the lamps being stronger and cheaper. Small motors up to say  $\frac{1}{2}$  h. p. are better suited for low voltage owing to the difficulties in insulating and construction details for high.

The following table contains data on electric installations.

Ship	Owner	Generating Units	Voltage
<i>Aquitania</i> .....	Cunard S. S. Co.....	Four 400 kw. turbogenerators, 1,500 r. p. m.	220 3-wire
<i>Mauretania</i> .....	Cunard S. S. Co.....	Four 375 kw. turbogenerators, 1,200 r. p. m.	110
<i>Britannic and Olympic</i> .....	White Star Line.....	Four 400 kw., 3-crank compound inclosed engines, 325 r. p. m.	100
<i>Albatron and Calgarian</i> .....	Allan S. S. Co.....	Three 250 kw. turbo-generators at 3,000 r.p.m.	220 3-wire
<i>Missanabi and Metagama</i> .....	Canadian Pacific R. Co.	Three 100 kw. turbogenerators	100
<i>Camilo and Coronado</i> .....	Elders & Fyffes.....	Three 90 kw., 2-crank compound engines, 450 r. p. m.	100
<i>Eloby and Elele</i> .....	Elder, Dempster Co.	Two 20 kw., single-cylinder engines, 600 r. p. m.	100

**Wires.**—Copper is used more than any other material for transmitting electricity. The size of a wire depends on the current it has to carry, that is, on the number of amperes, while the insulation depends more on the voltage. Conductors up to No. 8 B. & S. gauge may be of single wires, but above this size the necessary conductivity should be obtained by conductors made up of several small wires.

The wires should be well insulated by a material that is not affected by salt water, and preferably should be run in conduits instead of being fastened to the deck beams with cleats. All wires should be kept out of coal bunkers if possible.

The unit of measurement in measuring the cross-sectional area of a wire is the circular mil, which is the area of a circle one mil (.001 inch) in diameter.

Lloyd's Rules state: "Except for wiring fittings the sectional area of any copper conductor must not be less than No. 18 Stubs wire gauge (S. W. G.). All copper conductors of a greater sectional area than No. 14 S. W. G. must be stranded.

"The insulating material must be either vulcanized rubber of the best quality or must be equally durable.

"The insulation must be such that when the cables have been immersed in water for 24 hours it will, while still immersed, withstand 1,000 volts for half an hour between the conductors and the water.

"The insulating resistance should not be less than 600 megohms per statute mile at 60° Fahr., after the cables have been immersed in water for 24 hours, the test being made after one minute's electrification at not less than 500 volts and while the cable is still immersed."

SIZES OF WIRES  
(Table from Lloyd's)

Number of Wires and Gauge in S. W. G. or in Inches	Nominal Sectional Area of Conductors in Square Inches	Maximum Current Permissible Amperes	Number of Wires and Gauge in S. W. G. or in Inches	Nominal Sectional Area of Conductors in Square Inches	Maximum Current Permissible Amperes	
Fittings Wires	3/25	.0009	3.7	19/17	.046	70.
	3/24	.0011	4.5	7/.097"	.050	74.
	3/23	.0013	5.3	19/.058"	.050	74.
	1/18	.0018	7.2	19/16	.060	83.
	3/22	.0018	7.2	19/15	.075	97.
	7/25	.0022	8.6	19/14	.094	113.
	3/21	.0024	9.5	19/.083"	.100	118.
	1/17	.0025	9.8	37/16	.117	130.
	7/24	.0026	10.4	19/13	.125	134.
	3/20	.0030	12.0	37/15	.150	152.
	7/23	.0031	12.4	19/.101"	.150	152.
	1/16	.0032	12.9	37/14	.182	172.
	3/19	.0037	14.8	37/.083"	.200	184.
	1/15	.0041	16.3	37/13	.250	214.
	7/22	.0042	17.0	37/12	.300	240.
	1/14	.0050	19.	37/.112"	.350	264.
	3/18	.0053	20.	61/13	.400	288.
	7/21	.0055	21.	61/.097"	.450	310.
	7/20	.0070	24.	61/12	.500	332.
	7/19	.0086	28.	61/.108"	.550	357.
7/18	.0125	34.	61/112	.600	384.	
7/17	.017	40.	61/118	.650	410.	
19/20	.019	43.	91/.098"	.700	434.	
7/16	.022	46.	91/.101"	.750	461.	
19/19	.023	47.	91/.108"	.800	488.	
7/.068"	.025	50.	91/.112"	.900	540.	
7/15	.028	53.	91/.118"	1.000	595.	
19/18	.034	59.	127/.101"	1.000	595.	
7/14	.035	60.				

The above sizes provide security against undesirable rise of temperature. For long leads larger wires will be required to prevent undue drop of voltage.

The following table (representing United States practice) showing the allowable carrying capacity of copper wires and cables of 98% conductivity, according to the standard adopted by the American Institute of Electrical Engineers, should be followed.

ALLOWABLE CARRYING CAPACITIES OF WIRES

B. & S. Gauge Number	Diameter of Solid Wire in Mils	Area in Circular Mils
18	40.3	1,624
16	50.8	2,583
14	64.1	4,107
12	80.8	6,530
10	101.9	10,380
8	128.5	16,510
6	162.0	26,250
5	181.9	33,100
4	204.3	41,740
3	229.4	52,630
2	257.6	66,370
1	289.3	83,690
0	325	105,500
00	364.8	133,100
000	409.6	167,800
		200,000
0000	460	211,600
		300,000
		400,000
		500,000
		600,000
		700,000
		800,000
		900,000
		1,000,000
		1,100,000
		1,200,000
		1,300,000
		1,400,000
		1,500,000
		1,600,000
		1,700,000
		1,800,000
		1,900,000
		2,000,000

The volt loss in a given length is directly proportional to the transmitted current.

The distance that a wire will transmit a current with a certain volt loss is inversely proportional to the current.

In the table below (from Standard Wiring, J. J. Cushing), the column headed Feet per Volt Ampere gives the number of feet that the adjacent size of wire will transmit one ampere with a loss of one volt; this is a constant quantity for each size of wire.

WIRING TABLE FOR DIRECT CURRENT

Size of Wire B. & S. Gauge	Feet per Volt Ampere
0000	10068.4
000	7998.7
00	6339.5
0	5025.1
1	3974.5
2	3166.5
3	2495.0
4	1980.0
5	1347.0
6	1248.7
7	986.7
8	779.6
9	618.4
10	495.0
11	394.0
12	312.3
13	246.7
14	194.0

If it is desired to know how far a given wire will transmit a given current at a certain line loss, select from the second column opposite the size of the wire constant in the Feet per Volt Ampere column and multiply this figure by the desired loss and divide by the current to be transmitted.

To find how much current can be transmitted a given distance with a certain line loss, multiply this constant by the line loss and divide by the distance.

If it is desired to know the line loss that will occur when transmitting a certain current through a given size of wire, multiply the distance and current together and divide by the constant for the size of wire which it is desired to use.

## COPPER WIRE TABLE

Resistance per Mil-Foot 10.4 Ohms at 75° F. (24° C).  
 Temperature coefficient + .0021 per degree F.  
 Specific Gravity 8.9. Weight per cubic inch 0.321 lb.

Brown & Sharpe	Diameter in Inches	Area in Circular Mila. c. m. = D <sup>2</sup>	Feet per Lb.	Resistance	
				Ohms per Lb.	Ohms per Ft.
1	0.2893	83,690.	3.947	0.0004883	0.0001237
2	0.2576	66,370.	4.977	0.0007765	0.0001560
3	0.2294	52,630.	6.276	0.001235	0.0001967
4	0.2043	41,740.	7.914	0.001963	0.0002480
5	0.1819	33,100.	9.980	0.003122	0.0003128
6	0.1620	26,250.	12.58	0.004963	0.0003944
7	0.1443	20,820.	15.87	0.007892	0.0004973
8	0.1285	16,510.	20.01	0.01255	0.0006271
9	0.1144	13,090.	25.23	0.01995	0.0007908
10	0.1019	10,380.	31.82	0.03173	0.0009972
11	0.09074	8,234.	40.12	0.05045	0.001257
12	0.08081	6,530.	50.59	0.08022	0.001588
13	0.07196	5,178.	63.79	0.1276	0.001999
14	0.06408	4,107.	80.44	0.2028	0.002521
15	0.05707	3,267.	101.4	0.3225	0.003179
16	0.05082	2,583.	127.9	0.5128	0.004009
17	0.04526	2,048.	161.3	0.8153	0.005055
18	0.04030	1,624.	203.4	1.296	0.006374
19	0.03589	1,288.	256.5	2.061	0.008038
20	0.03196	1,022.	323.4	3.278	0.01014
21	0.02846	810.1	407.8	5.212	0.01278
22	0.02535	642.4	514.2	8.287	0.01612
23	0.02257	509.5	648.4	13.18	0.02032
24	0.02010	404.0	817.6	20.95	0.02563
25	0.01790	320.4	1,031.	33.32	0.03231
26	0.01594	254.1	1,300.	52.97	0.04075
27	0.0142	201.5	1,639.	84.23	0.05138
28	0.01264	159.8	2,067.	133.9	0.06479
29	0.01126	126.7	2,607.	213.0	0.08170
30	0.01003	100.5	3,287.	338.6	0.1030
31	0.008928	79.70	4,145.	538.4	0.1299
32	0.007950	63.21	5,227.	856.2	0.1638
33	0.007080	50.13	6,591.	1,361.	0.2066
34	0.006305	39.75	8,311.	2,165.	0.2605
35	0.005615	31.52	10,480.	3,441.	0.3284
36	0.0050	25.0	13,210.	5,473.	0.4142
37	0.004453	19.83	16,660.	8,702.	0.5222
38	0.003965	15.72	21,010.	13,870.	0.6586
39	0.003531	12.47	26,500.	22,000.	0.8304
40	0.003145	9.888	33,410.	34,980.	1.047



## DIAMETERS BY DIFFERENT WIRE GAUGES

See also Sect. 3

Diameters in Mils. 1 Mil. = 0.001 Inch

Gauge Number	Brown & Sharpe	Birmingham	British Imperial
0000	460	454	400
000	410	425	372
00	365	380	348
0	325	340	324
1	289	300	300
2	258	284	276
3	229	259	252
4	204	238	232
5	182	220	212
6	162	203	192
7	144	180	176
8	128	165	160
9	114	148	144
10	102	134	128
11	91	120	116
12	81	109	104
13	72	95	92
14	64	83	80
15	57	72	72
16	51	65	64
17	45	58	56
18	40	49	48
19	36	42	40
20	32	35	36
21	28.5	32	32
22	25.3	28	28
23	22.6	25	24
24	20.1	22	22
25	17.9	20	20
26	15.9	18	18
27	14.2	16	16.4
28	12.6	14	14.8
29	11.3	13	13.6
30	10.0	12	12.4

*Examples.* How far will a No. 6 wire transmit 20 amperes with a line loss of 15 volts? The constant (see table) for No. 6 wire is 1,248.7, multiply this by the line loss of 15 volts, which gives 18,730.5, and dividing this product by 20 amperes, the quotient is 936.5, which is the required distance in feet.

Suppose a current of 20 amperes is to be transmitted 936.5 feet, what will be the line loss, if No. 6 wire is used? Multiply the distance of 936.5 ft. by the current to be transmitted, viz. 20 amperes, which gives a product of 18,730. Divide this by the constant for No. 6 wire, which is given in the table as 1,248.7, and the quotient is 14.999; that is, the line loss is practically 15 volts.

In a distance of 936.5 ft. the conditions are such that a line loss of 15 volts must not be exceeded. How many amperes can be transmitted with a No. 6 wire? Multiply the constant of No. 6 wire, 1,248.7, by the line loss of 15 volts, giving 18,730.5, and dividing this by the distance 936.5 ft., the quotient of 20 amperes is obtained.

Assume that the resistance per mil-foot for copper is 10.4, which is a fair average, then

$$\text{Circular mils} = \frac{10.4 \times \text{feet} \times 2 \times \text{amperes}}{\text{volts lost}}$$

$$\text{Volts lost} = \frac{10.4 \times \text{feet} \times 2 \times \text{amperes}}{\text{circular mils}}$$

$$\text{Amperes} = \frac{\text{circular mils} \times \text{volts lost}}{\text{feet} \times 2 \times 10.4}$$

In the above, feet refers to the actual length of the circuit and is multiplied by 2 to obtain the total length of wire.

#### Size of wire for motor circuits.

Let  $D$  = length of motor circuit from fuse block to motor

$E$  = voltage at the motor

$L$  = drop in percentage of the voltage at the motor; which in marine installations is small, say 3%

$K$  = efficiency of the motor expressed as a decimal. The average values of  $K$  are about as follows: one h. p. = .75; 3 h. p. = .80; 10 h. p. and over = .90.

21.6 = ohms per foot run in circuit where wires are one mil in diameter

746 watts = one h. p.

H. p. = horse power of motor

$$\text{Then the circular mils} = \frac{\text{h. p.} \times 746 \times D \times 21.6}{E \times L \times K}$$

**Wiring Systems.**—The wiring may be either on the two-wire or three-wire system (see Fig. 90), the former being more common

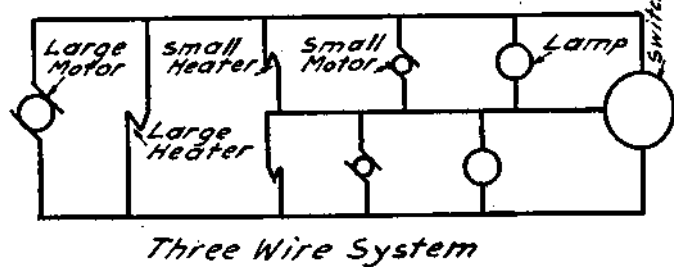
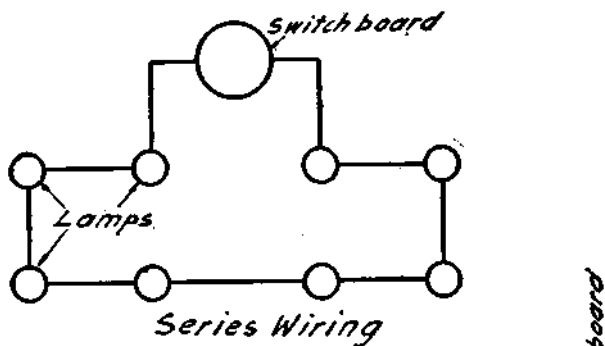
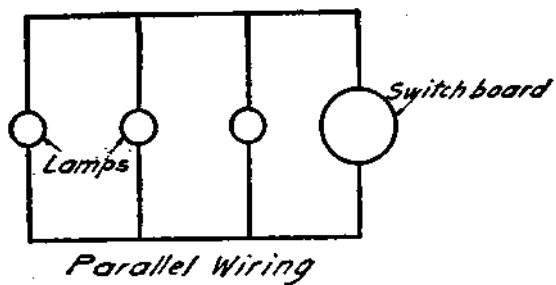

Figure 90.—Wiring Diagrams.

than the latter. In general, in the three-wire system the lighting and small motors not exceeding  $\frac{1}{2}$  h. p. are connected between the outers and the middle wire as near as may be practicable, to equalize the load on each outer and keep low the out-of-balance current; this also applies to small heaters. Large motors are supplied from the outers as well as large heaters.

In some steamers two dynamos are run together on the three-wire system. Here the positive wires of one dynamo are connected to the negative wires of the other dynamo, and from this point is a central or neutral wire that serves as a common return for both. The voltage is usually 220, but as this is divided between the two, the working voltage for the circuits is 110. The lamps are arranged so that they are equally divided between the two outside wires and the center one, to balance each other and divide the current. If the same number of lamps are run on each side, the middle wire will carry no current, but should more lamps be switched in on one side than on the other, the difference of current resulting will then be carried by the central wire. All three wires are of the same size. In the three-wire system the main switches and cut-outs are of the three-pole type.

The following notes are on the wiring of U. S. battleships, the latest types of which are wired on the three-wire system. "Twin conductors on all circuits of 60,000 circular mils cross section or less, and all branches on lighting circuits for single lights shall be of 4,170 circular mils cross section twin conductor. The wiring is designed on a basis of maximum allowable drop of not over  $2\frac{1}{2}\%$  for lighting circuits, calculated from adjacent dynamo room and 3% from distant dynamo room, and 5% for power and circuit (including heating and cooking circuits) calculated from adjacent dynamo room, and 6% from distant dynamo room, the drop to be reckoned from the bus bars on generator switchboard. The specified drops for power circuits are calculated on the basis of full battle load; for lighting circuit the full cruising load forms the basis. The wiring for lighting system is calculated on a basis of one-half ampere for each 16 candle power lamp."

**Conduits.**—These may be of steel enameled, brass enameled and flexible rubber-lined hose. The steel and brass enameled conform in their metal parts to the dimensions for standard steam, gas and water pipes. The fittings for steel enameled conduit are of malleable or cast iron, and for brass enameled, brass or the beaded malleable pattern.

## STANDARD SIZE OF CONDUITS FOR THE INSTALLATION OF WIRES AND CABLES

As adopted and recommended by The National Electrical Contractors' Association of the United States.

Conduit sizes based on the use of not more than three 90° elbows in runs taking up to and including No. 10 wires; and two elbows for wires larger than No. 10. Wire No. 8 and larger are stranded.

## Number of Wires in System

Size B. & S.	Capacity Amperes	One Wire in a Conduit. Size Conduit, Ins.		Two Wires in a Conduit. Size Conduit, Ins.		Three Wires in a Conduit. Size Conduit, Ins.		Four Wires in a Conduit. Size Conduit, Ins.	
		Inter'l	Exter'l	Inter'l	Exter'l	Inter'l	Exter'l	Inter'l	Exter'l
14	15	1½	.84	1½	.84	1½	.84	¾	1.05
12	20	1½	.84	¾	1.05	¾	1.05	¾	1.05
10	25	1½	.84	¾	1.05	¾	1.05	1	1.31
8	35	1½	.84	1	1.31	1	1.31	1	1.31
6	50	1½	.84	1	1.31	1½	1.66	1½	1.66
5	55	¾	1.05	1½	1.66	1½	1.66	1½	1.66
4	70	¾	1.05	1½	1.66	1½	1.66	1½	1.9
3	80	¾	1.05	1½	1.66	1½	1.66	1½	1.9
2	90	¾	1.05	1½	1.66	1½	1.9	1½	1.9
1	100	¾	1.05	1½	1.9	1½	1.9	2	2.37
0	125	1	1.31	1½	1.9	2	2.37	2	2.37
00	150	1	1.31	2	2.37	2	2.37	2½	2.87
000	175	1	1.31	2	2.37	2	2.37	2½	2.87
0000	225	1½	1.66	2	2.37	2½	2.87	2½	2.87
CM.									
250000	237	1½	1.66	2½	2.87	2½	2.87	3	3.5
300000	275	1½	1.66	2½	2.87	2½	2.87	3	3.5
400000	325	1½	1.66	3	3.5	3	3.5	3½	4.
500000	400	1½	1.9	3	3.5	3	3.5	3½	4.
600000	450	1½	1.9	3	3.5	3½	4.	...	...
700000	500	2	2.37	3½	4.	3½	4.	...	...
800000	550	2	2.37	3½	4.	4	4.5	...	...
900000	600	2	2.37	3½	4.	4	4.5	...	...
1000000	650	2	2.37	4	4.5	4	4.5	...	...
1250000	750	2½	2.87	4½	4.5	4½	5.	...	...
1500000	850	2½	2.87	4½	5.	5	5.56	...	...
1750000	950	3	3.5	5	5.56	5	5.56	...	...
2000000	1050	3	3.5	5	5.56	5	6.62	...	...

## Duplex Wire

14	15	1½	.84	¾	1.05	1	1.31	1	1.31
12	20	1½	.84	¾	1.05	1	1.31	1½	1.66
10	25	¾	1.05	1	1.31	1½	1.66	1½	1.66

*Example.* To ascertain the size of conduit for three No. 4-0 wire, follow down the wire column to No. 4-0 and then across to the section headed "Three wires in a conduit" and it will be seen that 2½-inch conduit is the size to use and that the external diameter is 2.87 inches.

**Switchboards.**—Switchboards have their panels of marble or slate firmly supported by a substantial frame fastened to the deck. They should be about 2 ft. away from any bulkhead so that access can be had to the back of the board. The size depends on the electric equipment of the vessel, and as to location the main switchboard should be in the same compartment as the generators. The following is a list of instruments and apparatus found on most boards:

**Main switch,** the connecting link through which the current must pass from the generator to the distributing system.

**Ammeter,** an instrument indicating the output of the plant in amperes.

**Voltmeter,** an instrument indicating the voltage of a circuit.

**Wattmeter,** an instrument for measuring electrical power, indicating in watts.

**Field Rheostat,** a resistance device, usually adjustable, placed in series with the generator field windings for regulating the voltage of the generator.

**Fuse,** a device designed to melt at a predetermined current, and to protect apparatus against abnormal conditions of current. Fuses are rated at 80% of their capacity so that an overload of 25% will cause them to burn out.

**Ground detector,** consisting of two lamps for giving the operator a warning signal when a wire is grounded.

**Instrument lamps,** for lighting the board.

An automatic circuit breaker may also be installed, which is a device for automatically opening a circuit when the current exceeds the maximum amount desired. There are two kinds of circuit breakers, depending on the method employed for rupturing the arc; in the magnetic blow-out the arc is extinguished by a strong magnetic field, while in the carbon break the arc is ruptured at a secondary set of carbon contacts which may be easily renewed.

See also abstracts from Lloyd's Rules on page 549, and General Notes, page 544.

**Determination of Output.**—The usual way of determining output for installations up to 100 kw. is to add together the power required for all the motors on full load, lighting, heating, wireless, etc., plus 10 to 15% for future additions. One or more units of the capacity thus obtained is installed according to the day load and the desired degree of security against breakdown. The capacity of large main generating plants may be settled from the probable

day load curve, a set being of sufficient capacity to deal with the load for the lighter part of the day and supplemented by one or more sets during the heavier part.

Although engine sets cost less and have a slightly less steam consumption when new than turbo sets, there are many advantages in favor of the latter, as less space is required, and the foundations for them need not be so heavy as the weight is less.

As to the rating of turbogenerators: The most economical output of the turbine (i. e., the output at which it attains its maximum steam economy) should not correspond with the generator rating in kilowatts except under special circumstances. In general, it will be found preferable, when ordering a combined set, to specify that the most economical output of the turbine shall be equal to 80% of the kilowatt rating of the generator as defined in these Rules, i. e., equal to 80% of the maximum continuous output of the generator in kw. The average output of the alternator is usually something between three-quarters of the rated output, and the rated output and the average output of the combined set should clearly be the most economical output for the prime mover. It should further be stated that for mechanical reasons the steam inlets should be capable of by-pass or otherwise of dealing continuously with outputs of 12% in excess of the rated output which is 40% in excess of the economical output as defined above. (From Report No. 72, Engineering Standards Committee, British.)

#### GENERAL NOTES FOR LAYING OUT ELECTRIC INSTALLATIONS

Before laying out an installation the following notes should be read over. They are from the National Electrical Code of the National Board of Fire Underwriters of New York. A list of inspected electrical appliances published by the Underwriters' Laboratories, New York (under the direction of National Board of Fire Underwriters), can often be consulted to advantage for information relative to electrical materials and devices which have been tested and found to comply with standard requirements.

**"Generators.**—a. Must be located in a dry place and provided with protecting hand rails.

b. Must be provided with a name plate giving the maker's name, the capacity in volts, amperes and kilowatts, the normal speed in revolutions per minute, and whether shunt, series or compound.

c. Generators of storage batteries employed for auxiliary (emergency) lighting or power must be located as far above the load water line as practicable.

**"Wires.**—a. Must, except around generators, at switchboards and in wire tunnels, be enclosed in approved metal conduits unless covered with approved metal armor or metallic braid.

b. All conductors larger than No. 12 B. & S. gauge must be stranded. Except in fixture wiring no single conductor smaller than No. 14 B. & S. gauge shall be employed.

c. Except at fixtures, conductors must not be spliced unless special permission in writing is given in advance.

d. Except at fixtures, and as provided in the preceding paragraph, splices and taps shall be made by means of approved connection blocks enclosed in approved fittings. Those fittings shall be located in readily accessible places and will not be permitted in bunkers.

e. Must be led through metallic stuffing tubes where passing through watertight bulkheads and through alt decks, deck tubes being extended to a height of 18 ins. above the surface of the deck.

f. Must not be drawn in until all mechanical work on the vessel has been, as far as possible, completed. Pull boxes shall be installed at sufficient intervals to permit of the drawing in of conductors without undue strain. These pull boxes shall be provided with gasketed watertight covers, the length of the opening in the box to be at least ten times the diameter of the largest conductor contained therein.

g. Must when closed in metal molding, flexible metal conduit, metal armor or metallic braid be provided with additional mechanical protection where passing through coal bunkers and where otherwise exposed to severe mechanical injury.

h. Where metallic braid cable passes through beams or non-watertight bulkheads it must be protected from abrasion. All sharp bends in such cable must be avoided.

**"Portable Conductors.**—Must be made of two or more stranded conductors, each having a carrying capacity equivalent to No. 14 B. & S. gauge or larger and each provided with an approved insulation and covering.



- "Bell or other Signaling Wires.**—a. Must be of not less than No. 16 B. & S. gauge and must not be run in the same conduit, molding or armor with light or power wires.
- b. Where radio systems are employed, all permanent wiring in the radio room and above the top metal deck must be magnetically shielded. Any protection placed around antennæ leads to prevent ready access to same must be of metal, permanently and effectually grounded.
- c. It is strongly recommended that all metal work above the top metal deck be permanently and effectually grounded.
- "Switchboards.**—a. Must be made of approved non-combustible non-absorptive insulating material.
- b. Must be kept free from moisture and so located as to be accessible from all sides.
- c. Must have a main switch, automatic cut-out, and ammeter for each generator and at least one voltmeter and one ground detector.
- d. Each circuit leading from the board must be protected by a cut-out and controlled by a switch.
- "Cut-outs and Switches.**—a. Must, except on switchboards and in living spaces, be enclosed in moisture proof cases. Must be arranged to break all poles of the circuit and must not be located in bunkers or other inaccessible places.
- b. Must be so arranged that each freight compartment may be separately protected and controlled.
- c. Must be enclosed in metal cabinets when located elsewhere than on switchboards.
- d. Must, except for motors, searchlights and diving lamps be so placed that no group of lamps or other current consuming devices requiring more than 660 watts shall be dependent upon one cut-out.
- "Removable Fittings.**—In vessels having any space allotted alternately to passengers and cargo, the fixtures and wiring in such space shall be so designed as to be removable and the points of disconnection so arranged that they can be properly insulated and covered up. Main fuses and switches shall not be located within these spaces.
- "Signal Lights.**—a. Must be provided with approved telltale board located preferably in pilot house which will immediately indicate a burned out lamp. Each side of all signal circuits shall be carried through the telltale board and fused at this point.

b. Signal circuits shall in no case supply other than signal lights.

**"Motors.**—Must each be provided with a name plate giving the maker's name, the capacity in volts, amperes and kilowatts, and the normal speed in revolutions per minute."

**Distributing Systems.\***—These may be divided into lighting and motor circuits. In the former, feeders are led from the switch-board to distribution cabinets and branch leads are then distributed to groups of lamps, not more than 660 watts being assigned to one branch line. The usual allowable voltage drop to the farthest outlet is 3%.

**Motor Circuits.**—Feeders are led direct from the main switch-board to a double-pole switch and cut-out placed in the line to protect the starting box and motor. The cut-out switch and double-pole switch are not necessary for motors of  $\frac{1}{4}$  h. p. or less.

There is briefly outlined, below, the circuits a steamer of about 400 ft. long might be divided into. Directly following this section is one on Motor Boat Circuits and abstracts from Lloyd's Rules.

Positive wires or terminals are marked + and painted red, while negative are marked - and painted black.

(1) **Machinery space circuit**, which includes the main engine room, refrigerating engine room, boiler rooms, forced draught fan rooms, and the shaft tunnels.

(2) **Navigating circuit**, which includes the ship's signal lamps, viz., foremast head, mainmast head, side and stern lights, also the lights fitted to telegraphs, compasses, and other instruments to illuminate the dials at night, and the Ardois signals.

(3) **Cargo light circuit**, which includes the portable arc lamps and the fixed lights in the holds, which are only lighted when the ship is being loaded or-unloaded.

(4) **Starboard saloon circuit**, which takes in the principal saloons and staterooms on the starboard side.

(5) **Port saloon circuit**, similar to the starboard.

(6) **Forward circuit**, which usually includes the crew's quarters and the third-class passenger accommodations.

(7) **The amidship circuit**, which serves the lower central portion of the ship, including officers' and engineers' rooms, stores, galleys, etc.

(8) **After circuit**, taking in the after accommodation, usually occupied by second-class passengers and ship stewards.

\* Abstracts from Ship Wiring and Fitting. T. M. Johnson.

(9) **Miscellaneous circuit**, for ventilating fans, galley and laundry machinery.

It is not necessary for all the circuits to be controlled by separate switches on the main board. For instance, the circuits just enumerated could be combined into say four main circuits thus: (A) forward, (B) amidships, (C) after, and (D) machinery space. If this arrangement were adopted, separate auxiliary switchboards would then be fitted in the four sections of the ship referred to. The sections would be split up into separate individual circuits controlled from the auxiliary boards.

(1) **Machinery Space Circuit**.—Here the main cables are run from the main switchboard to the section board, and from this section board cables are run to three distribution boards located as follows:

Distribution board 1a is in the stokehold for supplying lamps there, also for those in the passages between the boilers, lamps in fan rooms, portable lamps and clusters in the bunkers.

Distribution board 2a would be in the forward end of the main engine room, and would supply about half of the engine room lights, that is, those at the forward end.

Distribution board 3a would be at the after end of the engine room and would supply the remainder of the engine room lights and also those in the shaft tunnel.

It is impossible to give a definite figure for the number of lights required, owing to the variation in the sizes and shapes of machinery spaces on different ships, but on an average a fairly good light can be obtained by arranging 8 candle power lamps about 8 ft. apart.

(2) **Navigating Light Circuit**.—Here the main cables are run from the main switchboard to the chart house. From the board in the chart house are wires to the regulation lights, viz., foremast head, mainmast head, port and starboard side lights, and stern light, also lights to engine and docking telegraphs, steering and standard compasses and Ardois lights.

(3) **Cargo Light Circuit**.—The distribution boards to which the cables from the main switchboard run are generally located on the deck above. When the engines and boilers are amidships there are two boards, one for the forward cargo hold and the other for the after. In this circuit are often clusters of incandescent lamps or one or more arc lamps.

(4) and (5) **Starboard and Port Saloon Circuits** are very much alike, the cables from the main switchboard going to a distribut-

ing board on the starboard side and to another board on the port side.

(6) **Forward Circuit.**—Here the cables from the main board run to a board forward. From the latter is the circuit for lighting the various compartments.

(7) **Amidship Circuit.**—From the distribution board will be circuits for both light and power. Invariably small motors will be installed for running laundry machinery, and other machinery in the galley.

(8) **After Circuit.**—Similar to the forward.

(9) **General Motor Circuit.**—This is required on large vessels where the ventilating fans are driven by electric motors, and there are installed electric elevators and other special machinery requiring motors.

The method adopted for distributing electricity depends on the purpose for which it is to be used. For incandescent lamps and motors the parallel distribution is invariably adopted, as shown in Fig. 90. Here each lamp has its own bridge across the mains and can be turned on and off independently of the others.

Note the following abstracts from Lloyd's Rules: "The main switchboard should be fitted if possible in the dynamo room, to which all the main circuits throughout the ship should be brought, a switch and fuse being fitted thereon for each circuit. The auxiliary switchboards for further subdivision of the current should be placed in conveniently accessible positions, and each such switchboard should be similarly fitted with a separate switch and fuse for each sub-circuit. Fuses should be fitted to each lamp circuit when these are made with reduced size of wire. If vessels are wired on the double-wire system (this is invariably the case) fuses should be fitted to each cable of these circuits.

"The switchboards should be of slate or other incombustible non-conducting and moisture proof material. The switches should be on the quick-break principle and be so constructed that they must be either full on or off, that is, they must not remain in an intermediate position.

"Fuses should be fitted to each main or auxiliary circuit on the switchboards, as near as possible to the switches of these circuits. If the switchboard is not near the dynamo or if more than one dynamo is used on any one circuit, then fuses should also be fitted to the main cable as near as possible to each of the dynamo terminals. They should be mounted on slate or other incombust-

tible bases and be arranged so that the fused metal may not be a source of danger and where they are fitted with covers these should be incobustible.

"All fuses should be of easily fusible and non-oxidizable metal, and be so proportioned as to melt with a current 100% in excess of that which the cables they protect are capable of carrying as shown in table of Sizes of Wires, page 536. The terminals must be spaced apart or screened, so that an arc cannot be maintained when the fuse is blown. Separate single fuses and not double-pole fuses must be used on circuits where the voltage exceeds 125 volts.

"In shaft passages and in damp places, all lamp switches and fuses should be of a strong watertight pattern, or should be placed in watertight boxes having hinged or portable watertight covers. No switches or cut-outs are to be placed in bunkers.

"There should be no joints in the cables leading from the dynamo to the main switchboard, nor in those leading from the main to the auxiliary switchboards, nor should branches to single lamps be taken off these cables.

"The position and type of dynamos and electric motors should be such that the compasses will not be affected. Dynamos and large motors should be at least 30 ft. from the standard compass."

**Wiring of Motor Boats.**—The wiring of motor boats is comparatively simple compared to that of steamers. For example, take the wiring of a 45-footer. An engine for a boat of this size would be say electric started, the motor serving as a generator after the engine was under way, charging a set of storage batteries. These batteries, by means of suitable connections at the switchboard, would be used for lighting. Where the wiring is supported on cleats, they should be spaced about 4 ft. 6 ins. apart. Preferably the wires should be run in moldings, and when liable to injury should be in conduits.

The lighting circuit of a motor boat say from 30 to 50 ft. long, may be one of 6 volts, but for larger craft where there is room for the installation of a direct connected gasoline engine and generator the voltage may be 110, for this voltage is better adapted for electric motors, and cooking and heating devices.

As a 45-ft. motor boat would have no occasion to require electric motors, except perhaps small ventilating fans that could be attached to lamp sockets, there would be only one distributing circuit from the switchboard and that would be for lighting. The parallel system would be adopted, on which would be the running lights and

also those to the staterooms. The boat can be well lighted by twelve 4 c. p. Mazda lamps (see page 552). The running lights and the anchor light would each contain a 6 c. p. lamp, the binnacle light a 2 c. p. and the searchlight a 20 c. p., thus making a total of 100 c. p. The efficiency of a 6-volt Mazda lamp is about  $1\frac{1}{4}$  watts per c. p., therefore the total electric energy consumed would be 125 watts, which at 6 volts would mean a current of approximately 21 amperes. As not more than 60% of the lamps would be in use at one time, this would call for a current of 13 amperes. Hence a storage battery with a capacity of 100 ampere hours would run the lamps continuously for say 8 hours. For a larger boat, the lamps would be 8 or 16 c. p. Above arrangement from bulletin issued by General Electric Co.

**Wiring of Gasoline Engines.**—As mentioned in the section on internal combustion engines, there are two systems of electric ignition, viz., the jump spark (Fig. 84) and the make and break (Fig. 85). The former as applied to a single-cylinder engine is as follows: Starting from the battery, the current goes to a switch thrown to connect with a spark coil, then to a spark plug in cylinder head, with a return connection from the engine to the battery. There is also a connection between the timer (which controls the time of the sparks) and the spark coil. Should it be desired to use a magneto for ignition purposes, then the switch mentioned above would be thrown, cutting out the batteries, and the current generated by the magneto (driven by the engine) would go to the spark coil, thence to the spark plug as before with a return wire connection from the engine to the magneto. If the engine has two cylinders there would be two spark coils, one for each, making two connections to the timer, one for each cylinder; otherwise the wiring is the same.

A make and break system for a single-cylinder motor is as follows: Starting from the battery, then the switch, coil, and wire to make-and-break connection on the side of the cylinder, with a return wire to the battery. If a magneto is installed, throw switch to start on the battery, and when the motor is running, throw switch on magneto circuit which consists of a wire from magneto to coil, thence to make-and-break connection with return to magneto. If the motor has one or more cylinders, the connections to the make-and-break devices would be made by branches from the same main wire from the coil.

In both the jump spark and make-and-break systems, when the motor is running on the magneto the battery is cut out.

**Incandescent Lamps and Searchlights.**—Common sizes of incandescent lamps are 8 and 16 c. p. of 110 volts. A 16 c. p. of 110 volts requires  $\frac{1}{2}$  ampere of current, calling for approximately 55 watts. Roughly, 10 such lamps can be operated per 1 h. p. at the engine. Arc lamps are seldom installed on a ship, and when they are, are wired in series. These lamps require 50 to 60 volts and a current of 50 to 150 amperes, corresponding from 5 to 12 h. p. at the engine.

The efficiency expressed in watts per candle power is the quotient obtained by dividing the watts consumed by a lamp by the candle

## INCANDESCENT LAMPS

(Direct Current)

*Carbon*

Volts	Candle power	Watts	Amperes
110	2	10	.191
110	4.8	20	.182
110	8.1	25	.227
110	9.3	30	.273
110	16.8	50	.455
110	20.2	60	.546

*Gem Lamps*

110	5	20	.1818
110	10.	30	.2727
110	15.6	40	.364
110	20.	50	.455
110	24.	60	.546
110	32.	80	1.727
110	40.7	100	1.909

*Mazda (Tungsten)*

110	7.1	10	.0909
110	11.5	15	.1363
110	16.	20	.1818
110	21.4	25	.228
110	34.2	40	.364
110	53.6	60	.546
110	92.6	100	.909
110	146.0	150	1.364

power it gives. The lower the watts per candle power the higher the efficiency. For example, 1.10 watts per candle power is a higher efficiency than 1.17 watts.

Besides the ordinary incandescent lamp with a carbon filament as above, there are manufactured (General Electric Co., New York) one known as the *Gem* with a metallized carbon filament, and another, the *Mazda*, with a filament of tungsten wire which instead of being in vacuum is surrounded by an inert gas at a pressure of about one atmosphere. Both the *Gem* and *Mazda* are more efficient than ordinary carbon filament lamps.

**Searchlights** for motor boats and other small craft consist of a high-powered incandescent lamp placed in front of a reflecting mirror. In boats having no electric equipment other than a 6-volt storage battery for ignition and a minimum amount of lighting with low voltage, incandescent searchlights can be supplied (General Electric Co., New York) 6 to 10 ins. in diameter, the current required being around 4 amperes.

For steamers and war vessels a powerful light is necessary and this is obtained by carbon arcs. As to the effective range one maker (Carlisle & Finch, Cincinnati, O.) states that on perfectly clear dark nights their 7-inch projector will illuminate objects at about  $\frac{1}{2}$  mile, the 9-inch  $\frac{1}{2}$  to  $\frac{3}{4}$  of a mile, the 14-inch 1 to  $1\frac{1}{2}$  miles, the 19-inch  $1\frac{1}{2}$  to 2 miles, the 24-inch 3 miles, the 32-inch 4 miles, and the 38-inch 5 miles. Under the most favorable conditions the range may exceed the distances given.

There are three types of control: (1) the local hand control; (2) the distant mechanical, in which the operator controls the searchlight from below (or from one side or rear if preferred) by means of hand wheels, gears and shafting; and (3) the distant electric, where the searchlight is moved by electric motors, the controller being at any convenient distance from the searchlight. Both (1) and (2) may be hand controlled if desired.

In the Argentine battleship *Moreno* of 27,566 tons displacement and 594 ft. long, there were 12 motor-operated, remote, electrically controlled 110 cm. searchlights and one portable signaling projector of 35 cm., all supplied with current of 110 volts. For quickly changing from a dispersed to a closed beam of light there was a double disperser consisting of two parallel systems of plano-convex cylindrical lenses that could be drawn together or separated. A complete horizontal cycle of a searchlight could be made in 28 seconds, or in 15 minutes, if desired, by the electric remote control.



## SEARCHLIGHTS

Diameter of Shell Inches	Diameter of Reflector Inches	Candle Power	Current Amperes	Range Miles	Height Over all Inches	Height Center of Mirror	Width Over all Inches	Length Over all Inches	Net Wt. Lb.
9	8	1200	6	$\frac{1}{2}$	24	$17\frac{3}{4}$	$10\frac{1}{4}$	$11\frac{3}{4}$	25
10	$9\frac{1}{2}$	2000	10	$\frac{3}{4}$	$42\frac{1}{2}$	$35\frac{3}{4}$	$12\frac{1}{8}$	$13\frac{1}{2}$	85
15	13	4000	20	1	44	$33\frac{3}{8}$	$17\frac{1}{8}$	$16\frac{1}{8}$	115
20	19	7000	35	2	$51\frac{1}{2}$	39	$24\frac{1}{4}$	24	250

Engberg El. Co., St. Joseph, Mich.

## SEARCHLIGHTS

Effective Dia. of Mirror, Ins.	Current in Amperes
24	45-50
30	80-90
36	110-120
48	140-150
60	180-200

Carlisle and Finch, Cincinnati, Ohio.

**Batteries.**—In a primary battery or cell, chemical energy is transformed direct into electrical energy. Such a battery consists essentially of two metallic conductors or poles dipping into an electrolyte. Copper or carbon is commonly employed for the positive pole and zinc for the negative. The electrolyte may be sulphuric or nitric acid or sal ammoniac, caustic soda, or other salt.

There are two types of primary batteries, viz., wet and dry. An example of the former is the Daniels, which has a voltage of 1.07 to 1.14 and an internal resistance of .3 ohm. For marine purposes the dry has many advantages over the wet. In a dry battery the negative pole, which also serves as a container, is a hollow zinc cylinder, a common size being 6 ins. high by  $2\frac{1}{2}$  ins. diameter. The positive pole is a carbon rod, and the electrolyte is sal ammoniac and zinc chloride. In new cells the electromotive force is between 1.5 and 1.6 volts, and the internal resistance .1 ohm which may be increased to .5 ohm. Dry batteries are extensively used for ignition purposes in gasoline engines.

**Storage Battery.**—A secondary or storage battery is one which

can be regenerated after exhaustion by passing a current through it in a direction opposite to the direction of current flow when the battery is delivering current to a circuit.

There are two types; the lead, and the alkaline or Edison. In the former the active material on both the positive and negative plates is applied in the form of a paste to a stiff lead-antimony alloy supporting grid, and the electrolyte is a dilute solution of sulphuric acid. The specific gravity of the electrolyte when the battery is fully charged varies from about 1.210 for stationary batteries to about 1.300 for automobile and motor boat ignition batteries. The voltage when being charged is from 2. to 2.5 volts, and when being discharged it decreases from 2. to 1.7 volts.

The normal capacity of a storage cell is usually expressed in ampere-hours at the 8-hour rate at 70° F. down to a certain voltage per cell. For instance, when it is said that a cell has a capacity of 100 ampere-hours it is usually meant that this cell can be discharged at a rate of 12½ amperes continuously for 8 hours at 70° F., down to the limiting voltage specified by the battery manufacturer. In lead cells this limiting voltage may be taken at 1.75 volts per cell. The watt-hour capacity of a battery is equal to the ampere-hour capacity multiplied by the average voltage during discharge.

In addition to taking care that the temperature of the cells does not exceed 110° F. when being charged, precautions are also necessary to prevent the temperature of the battery falling too low, as a drop in temperature causes a falling off in efficiency. In the case of the lead cell, freezing must be guarded against in cold weather. To avoid this, the battery should always be kept fully charged in cold weather, as a charged cell will not freeze in the temperatures ordinarily experienced.

Quite different from the lead storage battery is the one manufactured by the Edison Storage Battery Company. Here the positive plate is a steel grid with steel tubes containing nickel hydrate and metallic nickel, and the negative plate a steel grid with steel pockets containing iron oxide. The electrolyte is an alkaline solution in water.

This battery requires watering occasionally to keep the solution at the proper level. At long intervals the solution should be renewed by standard renewal solution obtained only from the Edison Company. This is required after each period of 250 discharges, about two years in ordinary marine service. In putting the battery

out of commission there is nothing to be done except to see that the solution is a good half-inch above the plates. If too low bring to proper level by adding distilled water. In putting the battery in commission, see that each cell has sufficient electrolyte to cover the plates and give the battery a 12-hour charge at normal rate. After the first discharge the battery may then be fully charged in 7 hours at normal rate.

**EDISON STORAGE BATTERIES FOR YACHT LIGHTING**  
(Approximate equipment based on 10-hour service)

Approximate Length of Boat	Voltage	Number of Cells	Lamps	
			Number	Candle Power
18 ft. to 30 ft.....	6	5	6 12 18	6 6 6
30 ft. to 45 ft.....	12 to 20	10-20	12 to 18 18 to 24 24 to 30	10 10 10
50 ft. to 75 ft.....	30	28	26 32 40	10 10 10
90 ft. to 250 ft.....	110	100	30 to 200	16

Where 60-volt or 80-volt systems are required, 55 cells and 75 cells, respectively, are recommended.

**Notes on Storage Batteries.**—All compartments where storage batteries are installed should be well ventilated and have a constant temperature of about 70°.

Operate a battery only in accordance with the rules furnished by the manufacturer.

Acid should never be added to a battery except upon the recommendation of the manufacturer.

Never bring a lighted match or other open flame near a battery.

Locate the battery so that no acid can get on any wood work.

The best way to ascertain the condition of a battery is to test the specific gravity (density) of the solution in each cell with a

hydrometer. To take a reading insert the end of a rubber tube in a cell. Squeeze and then slowly release the rubber bulb, drawing up the electrolyte from the cell until the hydrometer floats. The reading on the graduated stem of the hydrometer at the point where it emerges from the solution is the specific gravity of the electrolyte. After testing, the electrolyte must be returned to the cell from which it was drawn.

The gravity reading is expressed in points; thus the difference between 1,250 and 1,275 is 25 points. When all the cells are in good order the gravity will test about the same (within 25 points) in all. Gravity below 1,150 indicates that the battery is completely run down or discharged, below 1,200 but above 1,150 less than half charged, and above 1,200 more than half charged.

A battery charge is complete when, with charging current flowing at the rate given on the instruction sheet on the battery, all cells are gassing (bubbling) freely and evenly and the gravity of all cells has shown no further rise during one hour. The gravity of the solution in cells fully charged as just mentioned is 1,275 to 1,300.

The best results in both starting and lighting service (the former relates to the starting of gasoline engines) will be obtained when the system is so designed and adjusted that the battery is normally kept well charged. A battery which is to stand idle should first be fully charged.

**Grouping of Battery Cells, (1) Series.**—When it is desired to obtain a voltage greater than that of a single cell, two or more are connected together in series; that is, the positive terminal of one cell is connected to the negative terminal of the next, and so on until the number of cells required to produce the voltage wanted are connected. For instance, to get a voltage of 11 volts, 10 dry batteries with a voltage of 1.1 each would be required.

**(2) Multiple.**—If it is desired to obtain more current, that is, more amperes without changing the voltage, then more cells must be placed alongside the others, that is, parallel with the first row, each row producing the same voltage and joined at the ends, positive terminals to positive, and negative terminals to negative, thus adding their currents together at the same voltage.

**Generating Sets.**—These consist of a gasoline engine, steam engine or turbine direct connected to a generator. Steam is supplied by the main boilers and is often reduced by a valve to about 100 lb. at the engine. The engines are of the vertical high

speed type, particulars of which are given in the table on page 559. On the same page are sizes of turbogenerator sets, and it should be noted that they are much lighter in weight. In large U. S. steamers there is installed besides the main generating set an emergency one on the deck above, as required by the U. S. Steamboat-Inspection Service whose rules state: "After January 1, 1915, all steamers carrying passengers subject to the inspection of this service which are provided with a plant for electric lighting purposes, the dynamos of which plant are located below the deep load line, shall have on board an auxiliary plant located above the deep load line, capable of thoroughly lighting the vessel in case of an emergency."

Gasoline engine sets are only installed in small craft as motor boats. With gasoline engines the same close regulation as with steam turbines and reciprocating engines is seldom obtainable, so the gasoline units invariably charge storage batteries which furnish the current direct to the lamps.

Generators of the direct current multipolar type are of 100-110 or 200-220 volts for steamers. (See Voltages.) As to the windings, when a constant current at a variable voltage is required as in series arc lamp circuits, then a series wound generator is specified, but on a constant voltage circuit where the distances from the generator to the load is not great and where there is a small line loss, then a shunt wound machine is installed and this type is invariably selected for marine service. In a compound wound generator there is compensation for line loss; that is, the voltage at the terminals is constant and lamps can be run at a constant voltage even if they are at a considerable distance from the generator.

To find the Horse Power required for the Engine.

- Let  $I$  = total current required in amperes  
 $V$  = voltage  
 $G$  = efficiency of the generator taken as .9 to .95  
 $M$  = efficiency of the engine taken as .85 to .90

$$\text{Then h. p.} = \frac{I \times V}{746 \times G \times M}$$

$$\text{Kilowatts (kw.)} = \frac{I \times V}{1,000}; \text{ and substituting this value in the above equation}$$

$$\text{h. p.} = \frac{\text{kw.} \times 1,000}{746 \times G \times M}$$

See also Determination of Output.

Sizes.—The tables below give data on gasoline, steam engine, and turbine electric generating sets. The voltage of the gasoline may be from 32 to 110, while the steam units are either 110 or 220, 110 volts being for the lighting circuits and 220 for power.

## GASOLINE

Kw.	Number of Cylinders	Diameter Inches	Stroke Inches	Revolutions per Minute	Net Weight Pounds
5	4	3¼	5	900	1,400
10	4	4	6	750	2,600
15	6	4	6	750	3,175

Sturtevant Co., Boston, Mass.

## STEAM ENGINE

Size of Engine	Steam Pressure Required	Revolutions per Minute	Dia. of Pipes Inches		Kw.	Number 16 c. p. 55-watt Lamps	Weight Complete Set Pounds
			Steam	Exhaust			
6¼—10¼×6¼	100	450	2	2½	17½	320	5,600
7—12×7	100	400	2½	3½	25	450	7,300
8—14×8	100	400	3	5	35	640	10,000
8—14×8	150	400	3	5	50	910	14,000
10—18×10	150	350	4	6	100	1,820	22,000

Sturtevant Co., Boston, Mass.

STEAM ENGINE  
(U. S. Navy requirements)

Kw.	Normal Steam Pressure Pounds	Water (Steam) Consumption, Pounds per kw. hour, full load
2½	100	105
5	100	90
8	100	70
16	100	44
24	100	41
32	100	39
50	150	35
100	150	31

## TURBINES

Kw.	Steam Pressure	Diameter Pipes		Speed R. p. m.	Overall Dimensions			Weight Not Packed	
		Steam	Exhaust		Length	Width	Height	125 Volts	250 Volts
1	75 to 200	1½	4	4000	49	30	28	790	790
2	75 to 200	1½	4	4000	49	30	28	810	810
2½	75 to 200	1½	4	3600	49	30	28	845	845
4	75 to 200	1½	4	4000	50	30	28	870	870
5	75 to 200	1½	4	3600	52	30	28	935	935
7½	75 to 200	1½	4	3600	53	30	30	1000	1000
10	75 to 200	1½	4	3600	64	30	30	1125	1125
	75 to 200	2	6	3600	68	37	35	1725	1725
15	75 to 200	2	6	3000	70	37	35	1985	1985
	75 to 200	2½	8	3000	72	45	45	2735	2735
25	75 to 200	2	6	3000	78	37	35	2315	2315
	75 to 200	2½	8	3000	100	45	45	3065	3065
35	75 to 200	2	6	3000	69	37	35	2550	2550
	75 to 200	2½	8	3000	83	45	45	3300	3300
50	75 to 200	2½	8	2800	93	45	45	3575	3500
	75 to 200	3½	8	2800	112	52	53	5025	4950
75	75 to 200	3½	8	2200	120	62	53	5000	5500
	75 to 200	4	10	2200	123	55	59	6700	6600
100	75 to 200	3½	8	2200	125	52	53	6000	5900
	75 to 200	4	10	2200	128	55	59	7100	7000
125	75 to 200	4	10	2200	128	55	59	7475	7150
150	75 to 200	4	10	2000	138	55	59	8100	7950

Sturtevant Co., Boston, Mass.

## TESTS OF CONDENSING TERRY TURBOGENERATOR SETS

Kw. Rating	Kw. Output	Steam Pressure	Vacuum	Speed	Pounds Steam per kw.
300	300	200	27	1,250	28.6
	225	200	27	1,265	30.2
	150	200	27	1,280	34.2
100	100	200	23	1,735	36.08
85	85	150	27	2,240	32.
	32	143	27	2,240	38.
7½	10	200	25	3,800	53.5
	7.5	200	25	3,800	54.8
	3.7	200	25	3,800	69.4

The steam used in the above tests was dry saturated, no moisture, no superheat. Terry Turbine Co., Hartford, Conn.

Operating and General Notes.\*—As all electrical machinery runs

\* Abstracts from Care of Naval Machinery. H. C. Dinger.

at high speeds, be sure that the lubrication is reliable, and the oil cups filled before starting.

Become acquainted with the usual temperatures of the different parts when running, so that any abnormal rise of temperature will be noticed at once and the cause located.

Use only brass or copper oil cans.

Keep all small tools away from the generator.

Violent sparking of the commutator may be caused by a broken armature coil or a broken armature and commutator connection.

If the sparking cannot be controlled by the brush adjustments the machine should be shut down and examined. In some cases the sparking may be due to a dirty commutator. If the pressure of the brushes on the commutator is too light, they may jump and run irregularly, thus causing sparking.

A very small amount of lubricant on the commutator is usually found to aid in smooth running and save the surface from scoring.

If the generator has become demagnetized it will refuse to generate current when the speed is up. To remedy this, either tap the field with a light hammer or, if this fails to produce the desired result, reverse the brushes, that is, turn them around 180° of the commutator circle (if a two-pole machine) so that they change places with each other, and run the machine for a short period with reversed current. This tends to restore the residual magnetism; afterwards replace the brushes in their original positions.

In starting it is advisable to open the throttle gradually and bring the engine or turbine up to speed slowly.

When turbines are running on part load, it is recommended that instead of partly shutting all the steam nozzles, a few be shut tight, leaving wide open a sufficient number to give the requisite power.

Electric motors are series, shunt, and compound wound. Series motors are for immediate loads, are easily started even under heavy loads, but a variation of the load causes a great variation in the speed. Hoists and cranes are operated by series motors.

Shunt motors have their speed nearly constant for a variable load. They do not start so easily under a heavy load as series motors, and a variation of load causes little variation of speed. This type is for driving blowers, ventilating fans, centrifugal pumps, and machine tools.

Compound wound start on heavy loads, the variation of the speed being proportional to the load. They are suitable for



elevators and machines that have to be constantly started and stopped.

Motors for ship work are generally of 110-120 volts, the large sizes having starting boxes. The type of frame selected, viz., open, semi-enclosed, or enclosed, depends on the location of the motor in service. When with an enclosed frame it must be larger than with an open or semi-enclosed, to offset the lack of ventilation and consequent excess of heat in the armature. In other words, an enclosed motor has less output than a semi-enclosed, but it has the advantage of being practically dust and moisture proof.

All motors should have an efficient oiling system, and should carry an overload of say 25% for two or more hours without an extreme rise in temperature. Care should be taken that when running there is no sparking at the commutator.

In sizes above 5 h. p. multipolar motors are specified by the U. S. Navy Department, and below 5 h. p., bipolar. A special type known as the interpole has been developed by the Diehl Manufacturing Company, of New York. Here commutation is secured by means of separate poles placed midway between the main poles and fitted with a winding carrying full armature current to establish a field for commutation entirely independent of the main field. The primary object of the interpoles is to assist in the commutation so that all sparking may be avoided. Where the duty is extremely light, or where the series winding of the main poles is sufficient to provide necessary commutation characteristics, interpoles may be omitted to reduce weight and cost.

#### To Calculate the Horse Power of Motors.

Direct current

$$\text{Brake horse power} = \frac{\text{volts} \times \text{amperes} \times \text{motor efficiency}}{746}$$

Alternating current

$$\text{Brake horse power} = \frac{\text{volts} \times \text{amperes} \times \text{power factor} \times \sqrt{\text{number of phases}} \times \text{motor efficiency}}{746}$$

Average motor efficiency 85%.

**Weight of Motors.**—The following table, furnished by the B. F. Sturtevant Co., Boston, gives the approximate weight of 110-volt, direct-current motors for various speeds and horse powers:

## SIZES AND WEIGHTS OF SHIP MOTORS

Speed	Horse Power	Weight, Pounds
1,630	4	448
1,295	3	
1,070	3	
790	2	
510	1.5	
1,440	6	517
1,110	4	
903	4	
700	3	
478	2	
1,366	9	650
1,015	6	
804	5	
563	3.5	
383	2.5	
1,386	10	826
978	7.5	
852	6	
611	5	
409	3	
1,190	14	1,107
988	14	
733	8	
579	6	
478	6	
1,267	16	1,475
1,007	14	
834	14	
710	10	
488	6	
984	26	1,896
790	22	
655	18	
557	12.5	
424	10	
947	30	2,330
727	22	
534	15	
423	15	
823	35	2,899
630	25	
465	18	
368	18	

## CURRENT TAKEN BY 110-VOLT DIRECT CURRENT MOTORS

Horse Power	Amperes	Horse Power	Amperes
$\frac{1}{2}$	4.5	15	113
$\frac{3}{4}$	6.8	20	150
1	9.0	25	188
$1\frac{1}{2}$	13.6	30	226
2	16.9	40	301
3	25.4	50	376
4	33.8	60	452
5	42.3	70	527
$7\frac{1}{2}$	56.5	80	602
10	75.3	90	678

Motors for Ship Work.—The horse powers given are for open and semi-inclosed motors; for an inclosed motor it is 30% less.

*Installations of Motors on Warships\**

**Boat Cranes.**—Both rotating and hoisting motors are series wound, interpole type, of 400 r. p. m., the hoisting motor being 50 h. p. and rotating 40 h. p. (U. S. battleships *Arkansas* and *Texas*).

**Deck Winch.**—35 h. p., 350 r. p. m., compound wound 50% series and 50% shunt, without interpoles (U. S. *Montgomery*, *Virginia*, *Florida*, *Arkansas* and *Texas*).

**Ammunition Hoist.**—3 h. p., 400-530 r. p. m., shunt wound without interpoles (U. S. *Arkansas* and *Texas*).

**Ventilating Fans.**—For small fans of 600 cu. ft. and under, motors as a rule series wound. All others shunt.

**Forced Draught Fans.**—39 h. p., 630-795 r. p. m., nominal capacity 28,500 cu. ft. per min. (U. S. *Florida*).

**Fresh Water Pump.**—3 h. p., 1,100 r. p. m., compound wound (U. S. *Utah* and *Arkansas*).

**Steering Gear Motors.**—For some cruisers of about 5,500 tons, motors of 40 h. p., 300 r. p. m. have been installed, while for battleships 150 h. p., 250 r. p. m. All compound wound.

**Motors for Turning Turbines.**—Special winding, 5 h. p., 300-600 r. p. m. (U. S. *Florida* and *Arkansas*).

**Turret Turning Motors.**—The differential gear as applied to 12-, 13- and 14-inch guns covers the use of two motors for each gear, the larger one rated at 25 h. p., adjustable speed 300-900 r. p. m., and the smaller one 10 h. p., adjustable speed 300-900 r. p. m.

\* Abstracts from Naval Electrician's Handbook. W. H. G. Bullard.

**Gun Elevating Motors.**—Shunt wound.

Electric Capstan installed on the U. S. *New York* and part of equipment of latter battleships, designed to hoist 4,000 lb. at a speed of 200 ft. per minute, or a load of 16,000 lb. at 50 ft.

**Anchor Windlass.**—150 h. p., 250 r. p. m., 120 volts, 6-pole, compound wound with interpoles, reversible (U. S. *Nevada*).

See also Ship Machinery.

**Motor Starting and Controlling Devices.\***—A rheostat is an internal shunt for reducing the amount of current passing through a circuit by interposing resistance in it. Rheostats for intermittent service will carry a much larger current for a short time than those which are used continuously.

A controller is a device for making the proper electrical connections between the main supply lines and a motor, so as to control the direction and speed of rotation. They are for the control of heavy currents in motors of above 10 h. p., as in such equipments as boat cranes, deck winches, turret turning motors, ammunition hoists, and in general where there are continuous starting and stopping and changes of direction and speed.

There are three classes of controllers designed according to the work they are to do. Those built by the General Electric Co. of New York are arbitrarily designated as the R, B and P types.

The **R controllers** are rheostatic in their method of operation, and are for starting, stopping, reversing, and controlling the speed of motors. They are particularly adapted for motors that carry a heavy load in either direction.

**B controllers** are designed to give electric braking; that is, the motor is made to run as a generator by the momentum of its armature or load, and in this way reduces its speed or stops itself.

**P controllers** are installed where the voltage of the generator is to be varied, to obtain a change of speed of the motor.

**Panels** are to protect motors against the following conditions: (1) overload, (2) failure of voltage on line, (3) excessive rush of current caused by too rapid starting, and (4) running on resistance which is only designed for starting. A standard panel for the U. S. Navy for motors of 10 h. p. or less consists of an enameled slate 12 ins. wide by 24 ins. long and 1 in. thick, supported on iron side frames. On the panel is a main switch, rheostat switch, circuit breaker, and two inclosed fuses. All small parts not in

\* Abstracts from Naval Electrician's Handbook. W. H. G. Bullard.

magnetic circuit are of noncorrosive material, and where necessary moving steel parts are copper plated. The weight of a panel as outlined is approximately 100 lb. For motors larger than 10 h. p. the same apparatus is required, only the parts are larger.

**Solenoid Brakes.**—These are fitted on motors designed for hoisting and lowering weights and are intended to check the speed or even stop the motor and hold the load in case of failure of current, and to prevent the load from falling and running the motor as a generator. Motors for cranes, deck winches, turret ammunition hoists, and similar equipment have solenoid brakes. There are two types: (1) an electrically operated band brake, and (2) an electrically operated friction disk brake. The former is fitted to chain ammunition hoists, and with a modification to deck winches, and the latter with modifications to other forms of hoists.

**Ardots Signals.**—These are installed on warships for night signaling and consist of four double lanterns, each containing a red light and a white light, that are hung from the top of a mast, one under the other and several feet apart. By means of a special controller any number of lanterns may have either red or white lamps lighted, thus producing combinations by which a code can be signaled.

**Electric Heaters and Cooking Devices,** see page 573.

**Electric Turbine Propulsion,** see Turbines.

**Electric Steering Gear, Capstans, etc.,** see Ship Machinery.

**Heating by Electricity,** see Heating.

**Costs of Electric Installations,** see Costs, Prices and Estimates.

## SECTION VIII

### HEATING, VENTILATION, REFRIGERATION, DRAINAGE, PLUMBING, FIRE EX- TINGUISHING SYSTEMS

#### HEATING

**To Calculate the Heat Passing Through a Ship's Side or Through a Bulkhead.**—Assume the temperature of the stateroom to be maintained at 70°, while the outside temperature will depend on the route the steamer follows or, say, a minimum temperature of 30° for the sea and 40° for the air outside the staterooms, as the air in the passageways is about 10° above that of the outside atmosphere.

For example, take a stateroom 12 ft. long, 11 ft. 6 ins. wide, and 8 ft. high, having a cubic capacity of 1,104 cu. ft. The surface along the side of the hull will be 12 ft. by 8 ft. or 96 sq. ft.; that exposed to passageways or other staterooms will be 8 ft. by 35 ft. or 280 sq. ft.; the deck above, 12 ft. by 11 ft. 6 ins. or 138 sq. ft.; and the same amount on the deck below.

Of the ship's side 96 sq. ft. is subject to a difference of 40° (70° inside and 30° outside). Iron has a conductivity of about 233 B. t. u. per sq. ft. per hour per one degree Fahrenheit. Thus the quantity of heat passing out would be  $233 \times 96 \times 40 = 894,720$  B. t. u. per hour, requiring a very large heating apparatus for the ship.

From the above will be noted the difficulty in warming parts of a ship where one side of a compartment is exposed to the weather, and the advantages of wood vessels in cold climates. To reduce the heat loss through the shell plating, a wood lining is fitted, between which and the plating are subdivisions forming air spaces. In this manner the leakage of heat may be reduced to .5 B. t. u. per hour per degree Fahrenheit difference of temperature for each square foot; or if wood alone one inch thick, the loss would be about .8 B. t. u.

Assuming that a wood lining with air spaces is fitted and that the loss of heat is .5 B. t. u. per hour per degree Fahrenheit, then the loss along the ship's side having an area of 96 sq. ft. would be

$40^\circ \times .5 \text{ B. t. u.} \times 96 \text{ sq. ft.} = 1,920 \text{ B. t. u. per hour}$ , and the remaining 556 sq. ft. of the other 5 sides ( $40^\circ \times .5 \text{ B. t. u.} \times 556 \text{ sq. ft.} = 11,120 \text{ B. t. u.}$ ) making a total of 13,040 B. t. u. per hour. As a change in temperature of one degree corresponds to 965.7 B. t. u., thus the temperature of the room would be lowered  $\frac{13,040}{965.7} = 13.5^\circ$ .

Suppose it is required to find the capacity of an electric heater for the above room. One watt = 3.41 B. t. u. per hour, then the heater must deliver  $\frac{13,040}{3.41} = 3,806$  watts per hour.

Or suppose the room is to be steam heated, the steam having a temperature of  $210^\circ$ . The square feet of radiation required

$$= \frac{\text{total B. t. u. lost from the room per hour}}{1.7 \text{ (temp. of steam in radiator - temp. outside radiator)}}$$

$$= \frac{13,040}{1.7 (210 - 30)} = 42.6 \text{ sq. ft.}$$

(The above is from *Heating and Ventilating of Ships*, C. B. Walker.)

Vessels are heated by steam, hot air (thermotanks), and by electricity.

**Heating by Steam.**—The steam may be taken from the auxiliary steam line or there may be an independent line run, in both cases calling for a reducing valve for reducing the steam to about 15 lb. Beyond this valve the steam goes direct to the radiators.

There are two systems of piping, viz., the two-pipe and the one-pipe. In the former there is a supply pipe to the radiators and a return from them to a tank from which the condensed steam is pumped to the hot well. There should be a by-pass from the return to the condenser to suck the radiators and pipe line dry, thus preventing any remaining water from freezing and bursting the radiators if the steamer is laid up in cold weather. When the steam pipe is less than 3 ins. diameter, it is customary to make the return one or two sizes smaller. If the steam is over 3 ins., the area of the return may be about one-quarter that of the steam. In the one-pipe system the steam is delivered to the radiators, and the condensed water is drawn off by cocks.

It is usual with steam heating systems to have air pipes connected to the radiators, so that the air that is brought by the steam can escape.

**Steam Heating System on U. S. Vessels.**—Radiator coils one-inch seamless drawn brass pipe, iron pipe size.

Radiators consisting of pipes along the decks, 2-inch brass pipe, iron pipe size.

Circuit steam and drain pipes seamless drawn brass pipes, iron pipe size, connected by composition fittings.

The heating plant will work at a pressure of about 50 lb.

The number of cubic feet of space to be heated allowed per square foot of radiator surface will be as follows:

	Cubic Feet
Pilot and chart houses.....	50
Captain's cabin, staterooms, bath and water closet.....	60
Sick bay and bath room.....	60
Wardroom country and staterooms.....	80
Wardroom officers' staterooms.....	80
Staterooms.....	100
Dispensary.....	80
Berth and main decks forward of barbettes, crew's lavatory.....	100
Main deck inside armor.....	100
Steering engine room.....	125
Berth deck and inside redoubt.....	125

Radiators and heaters will be arranged in circuits, each circuit being so connected that it can be operated independently of the other.

For a 160-foot steamer the following steam heating system was specified: "Steam for the radiators shall be taken from the auxiliary steam pipe through reducing valves and manifolds. Each steam circuit shall be plainly marked. There will be one steam trap located in the lower engine room, so as to drain all the heaters. This trap shall be connected up and provided with a suitable by-pass. A branch shall be led outboard.

"All heater pipes shall be of wrought iron, and so led that there will be no pockets where water can collect.

"The area of the radiators shall be apportioned as follows:

Chart room,	1 square foot to 30 cubic feet
Captain's cabin,	1 square foot to 60 cubic feet
Wardroom,	1 square foot to 60 cubic feet
Crew's quarters,	1 square foot to 50 cubic feet
Officers' rooms,	one small heater in each
Petty officers' rooms,	one small heater in each room

"Galvanized iron drip pans shall be fitted under all radiators.

"The radiators shall be of cast iron."

**Size of Radiators.**—Experiments have shown that the ordinary



cast iron radiator located in a room and surrounded with comparatively still air gives off heat at the rate of 1.7 B. t. u. (1.6 to 1.8 or 1.7 average) per square foot per degree difference between the temperature of the surrounding air and the average temperature of the heating medium per hour. This is called the rate of transmission.

To find the square feet of radiation for any room, divide the calculated heat loss in British thermal units per hour by the quantity 1.7 times the difference in temperature between the inside and the outside of the radiator. Thus

square feet of radiation =

Total B. t. u. lost from the room per hour

1.7 (Temp. of steam in radiator - Temp. outside radiator)

A radiator under stated conditions and under a heavy service requires one-fourth of a pound of steam per square foot of surface per hour. To determine approximately the amount of radiating surface a pipe will supply, assume 100 sq. ft. for each square inch of sectional area of pipe.

One square foot of steam-radiating surface is often estimated to give off 250 B. t. u. per hour when operating under a pressure from 2 to 5 lb. per square inch in a room temperature of 70°. Assuming a steam temperature of 220° which corresponds to a pressure of about 3 lb., the total difference in temperature is 220 - 70 = 150°,  $\frac{250}{150} = 1.67$  B. t. u. per degree difference per square foot per hour. This factor is not constant and varies with the type of radiator and difference in temperature.

A single-column radiator is more efficient than a 2- or 3-column, because the surface is more exposed to the surrounding air. Also a low radiator is more efficient than a high one as there is in the

#### SIZES OF TAPPINGS FOR RADIATORS

1-Pipe System		2-Pipe System		
Surface, Sq. Ft.	Size, Ins.	Surface, Sq. Ft.	Steam, Ins.	Return, Ins.
25	1	30	$\frac{3}{4}$	$\frac{3}{4}$
25-50	$1\frac{1}{4}$	30-50	1	$\frac{3}{4}$
50-90	$1\frac{1}{2}$	50-100	$1\frac{1}{4}$	1
100-160	2	100-160	$1\frac{1}{2}$	$1\frac{1}{4}$

former a continuous upward current of air around the surface of the radiator. The air in its passage from the bottom to the top becomes heated and as it reaches the top the transmission of heat is less rapid because of the less difference in temperature between the steam and the air.

APPROXIMATE B. T. U. TRANSMITTED PER SQUARE FOOT PER DEGREE DIFFERENCE PER HOUR FOR VARIOUS TYPES OF RADIATION WHEN THE DIFFERENCE OF TEMPERATURE IS 150° F.

Type of Radiator	Height			
	22 Ins.	26 Ins.	32 Ins.	38 Ins.
1-column.....	1.90	1.86	1.83	1.80
2-column.....	1.80	1.75	1.71	1.67
3-column.....	1.70	1.65	1.60	1.54
4-column.....	1.60	1.55	1.50	1.45
Window radiator.....				1.85
Wall radiator, horizontal.....				1.95
Wall radiator, vertical.....				1.90
Pipe coils.....				2.00

EQUIVALENT SQUARE FEET OF HEATING SURFACE IN ONE LINEAR FOOT OF STANDARD WROUGHT IRON PIPE

Diameter of Pipe, Ins.	Square Feet of Heating Surface
$\frac{3}{4}$	.275
1	.346
$1\frac{1}{4}$	.434
$1\frac{1}{2}$	.494
2	.622
$2\frac{1}{2}$	.753
3	.916
4	1.175
6	1.739

**Heating by Thermotanks.**—These consist of coils of pipes around which air is drawn that is forced through ducts by a fan to the different parts of the vessel. There are three forms of thermotanks, viz., bottom suction and top suction when installed exposed to the weather as on decks, and the 'tween-deck form which takes the air from a duct leading to any convenient supply of fresh air. The pipes are connected to steam mains, hence hot air can be delivered to any part of the vessel. See Figs. 91 and 92.

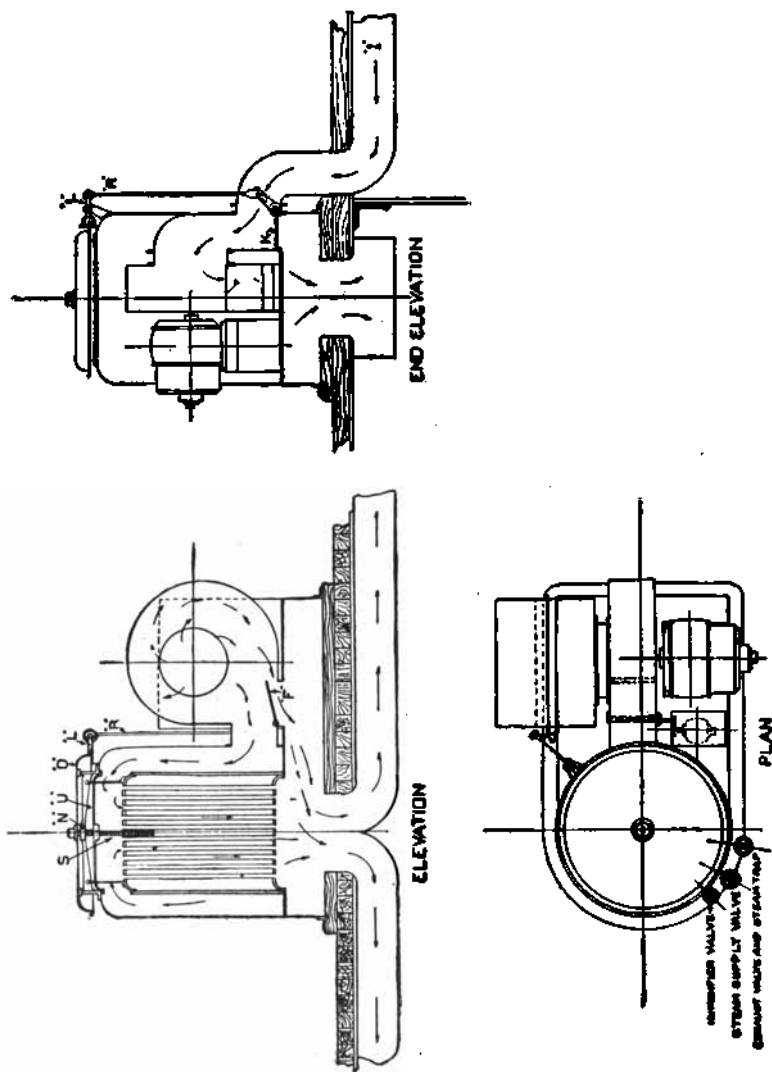

Figure 91.—Thermofan (Schutte &amp; Koerting).

**Heating by Electricity.**—All electric heating apparatus is based on the fact that when a current of electricity passes through a conductor heat is liberated in direct proportion to the resistance of the conductor and the square of the strength of the current,

Let  $H$  = quantity of electricity delivered in time  $t$   
 $R$  = resistance of conductor in ohms  
 $C$  = current in amperes  
 $E$  = the difference of pressure in volts at the terminals of the conductor or heater

Then  $H$  (the quantity of electricity liberated) =  $C^2 \times R \times t$

$$\text{and from Ohm's Law } C = \frac{E}{R} \text{ and } R = \frac{E}{C}$$

$$\text{Hence } C^2 \times R \times t = C^2 \times \frac{E}{C} \times t = C \times E \times t = \frac{E^2 \times t}{R}$$

As  $H$  can be expressed in watts and as one B. t. u. equals 17.58 watts (one watt = .0568 B. t. u. per minute or 3.41 B. t. u. per hour) then the heat given off from an electric heater can be calculated from the above formula.

Suppose it is required to find the number of heat units (B. t. u.) given off by an ordinary 16 candle power incandescent lamp working at 100 volts and taking a current of .6 ampere.

Electric energy (watts) = volts  $\times$  amperes =  $100 \times .6 = 60$ .  
 The heat given off or the B. t. u. per minute =  $60 \times .0568 = 3.408$ .

For electric heating there are two kinds of radiators, viz., luminous and non-luminous. The former are practically several large incandescent lamps, the light from which is of secondary importance to the heat given off. They are adapted for intermittent service, as removing the chill from a room, but for a room where it is required to maintain a high steady temperature for several

Device	Watts per Hour Required
Coffee percolator (2½ pints).....	380
6-in. disk stove.....	500
8-in. disk stove.....	800
Chafing dish.....	500
Small luminous heater.....	500
Non-luminous heater.....	3,000
Frying pan.....	300
Toaster.....	500
Tea samovar.....	500

hours a non-luminous heater is more satisfactory, consisting of resistance coils by passing a current through which heat is given off.

Working on the same principle as non-luminous heaters are stoves, coffee percolators, and other domestic appliances. On page 573 is a table showing the current, which should be 110 volts, required for various devices.

**Special Systems.**—Among the special systems that have been installed for heating is the *Nuvacuumette* (Ashwell & Nesbit, Leicester, Eng.) in which the steam admitted to the radiators is automatically controlled on its admission, there being no valve on the outlet of the radiator. This method causes the vacuum carried in the return pipes to extend into the radiator itself, making it possible completely to fill the radiator with water vapor at a temperature of 180° F. In large installations a vacuum pump is provided which may be dispensed with in small. The pump is placed

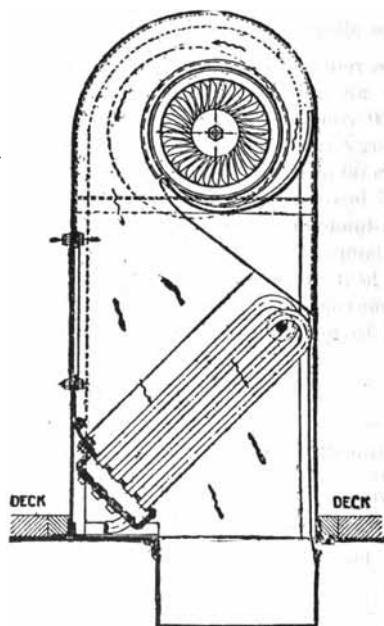

Figure 92.—Fan and Heating Coils.

at the end of the return condensed vapor main into which all the returns from the heating units are directly connected without the interposition of any valve. A further development of the above is the fitting, on the inlet to the radiator, of a device which automatically shuts off the supply of steam when the temperature has reached a predetermined point, and should it fall below, the valve opens allowing steam to enter.

Another system sold under the trade name **Highlow** (A. Low & Sons, Glasgow) has been installed on many steamers. The pressure in the steam mains may be from 5 to 50 lb., and the supply may be taken at the same pressure as other auxiliaries, or a connection may be taken from the exhaust main and the vessel heated by exhaust steam. The advantage of having steam at a high pressure instead of a pound or two is that smaller mains may be fitted. Each radiator is fitted with an exhaust valve. The steam mains are usually carried overhead and the exhaust mains below. The steam enters the radiator through a stop valve and then a thermostatic valve, the latter being designed to give a large opening with a small variation in temperature. This valve is set for the desired temperature in the radiator and as soon as enough steam has been admitted to obtain this it automatically closes, not opening again until the temperature has dropped in the radiator below that for which the valve is set. As it is impossible on board ship to have sufficient run on the exhaust pipe to clear it of condensed water, it is necessary to fit a vacuum pump. To provide against the possible breakdown of this pump a connection is made to the condenser, or a duplicate pump is fitted which is installed in the engine room, and the discharge is led into the hot well. A vacuum regulator is fitted to control this pump and when the desired vacuum is reached the steam supply is automatically cut off by the valve which opens again immediately the vacuum decreases.

On some torpedo boat destroyers, instead of having a return drain from the radiators the condensed water is discharged directly overboard. This arrangement saves weight, that is, the weight of the return piping and its fittings.

## VENTILATION

Sea air, which is taken as the purest form of air, contains about 3 volumes of carbonic acid gas in 10,000 volumes of air. The limit on shore is from 8 to 10 volumes in 10,000 of air.

For perfect ventilation the air should circulate at a velocity of

from 4 to 6 ft. per second. In lavatories and cattle spaces, ozone-making apparatus is often installed for purifying the air. An average person requires about 1,800 cu. ft. of air per hour, so that the amount of air needed for the ventilation of staterooms and living quarters may be obtained by the formula; quantity of air in cubic feet per hour = 1,800 × number of people. Below is the time specified to remove the air from different compartments of a war vessel.

	Minutes
Quarters on orlop deck.....	10 to 12
Water-closets.....	4 to 6
Staterooms.....	8 to 12
Magazines.....	6 to 8
Engine room.....	2
Ice machine room.....	3
Dynamo rooms.....	¾

The velocity of air in ventilating systems on shore is about 7 ft. per second. A steamer running at 8 to 10 knots produces an air current of 13 to 17 ft. per second, at 16 knots 27 ft., while in the *Mauretania*, a 24-knot Atlantic liner, the velocity is about 40 ft. per second. In hot climates the air current produced by the speed of the vessel is useful for cooling the compartments between decks, but in cold climates the air must be warmed as by thermostats or shut off.

**Air Pressure.**—This is measured by a U tube having water in the bent portion, one end of the tube being open to the air and the other connected to the duct whose pressure is to be measured. The readings are inches and fractions; thus a reading of 1 in. water gauge is equal to .55 of an ounce pressure per square inch.

Every duct through which a fan delivers air offers a certain resistance to the flow of the air. This resistance is due to the friction between the air and the surfaces that it comes in contact with, and for a given duct varies directly as the square of the volume delivered. A certain pressure is required to overcome this resistance and this pressure is known as the static pressure and is measured in inches of water gauge.

**Systems.**—Compartments above the water line having air ports can be ventilated by natural means, but those below must be by artificial, either of two systems, viz., plenum or exhaust, being selected. In the plenum, fresh air is drawn down the ventilators by fans and forced through sheet iron ducts to the various compartments. In the exhaust system, fans draw the foul air from the

## PRESSURE IN OUNCES PER SQUARE INCH, CORRESPONDING TO VARIOUS HEADS OF WATER IN INCHES

## Decimal Parts of an Inch

Head in Ins.	.0	.1	.2	.3	.4	.5	.6	.7	.8	.9
0		0.06	0.12	0.17	0.23	0.29	0.35	0.40	0.46	0.52
1	0.58	0.63	0.69	0.75	0.81	0.87	0.93	0.98	1.04	1.09
2	1.16	1.21	1.27	1.33	1.39	1.44	1.50	1.56	1.62	1.67
3	1.73	1.79	1.85	1.91	1.96	2.02	2.08	2.14	2.19	2.25
4	2.31	2.37	2.42	2.48	2.54	2.60	2.66	2.72	2.77	2.83
5	2.89	2.94	3.00	3.06	3.12	3.18	3.24	3.29	3.35	3.41
6	3.47	3.52	3.58	3.64	3.70	3.75	3.81	3.87	3.92	3.98
7	4.04	4.10	4.16	4.22	4.28	4.33	4.39	4.45	4.50	4.56
8	4.62	4.67	4.73	4.79	4.85	4.91	4.97	5.03	5.08	5.14
9	5.20	5.26	5.31	5.37	5.42	5.48	5.54	5.60	5.66	5.72

From Heating and Ventilation, B. F. Sturtevant Co.

compartments and exhaust it up the cowls, the fresh air entering through the ventilating ducts. Toilets, kitchens, and rooms where it is necessary to remove odors, smoke, dust, or gases should be ventilated by the exhaust system. As a whole the pressure system is preferable, as the leaking in of foul air from one room into another is prevented by the pressure of the air.

Air which has been breathed is warmer and more moist than pure air and hence rises to the top of a compartment. Exhaust openings, therefore, are located near the top. The supply and exhaust openings are placed as far away from each other as may be practical, to prevent the entering air from escaping through the exhaust opening.

Another system, or rather a combination of ventilating and heating, is known as the *thermotank*. This consists of a fan and pipes through which steam flows, all inclosed in a suitable casing. Air is drawn from the outside, is warmed by coming in contact with the hot pipes, and is then forced by the fan through ducts to the various parts of a vessel. By using brine instead of steam a vessel could be cooled. See Figs. 91 and 92.

Many engineers recommend that the ventilation system should be considered apart from the heating. The advantages claimed are: (1) the steam required in the warming system is reduced, as only that volume is condensed which is necessary to maintain the desired temperature of the compartment, thus saving coal; and (2) the ventilating units being periodically out of commission, there is saved the power needed by them.



The Nesbit system (Ashwell & Nesbit, Leicester, Eng.) of warming and ventilating is separate, as just outlined. During cold weather it is necessary to temper the air and this is done by passing it over a series of air heaters, the temperature of the latter being about 212° F. To maintain the purity of the air in the various compartments, exhaust fans draw out the vitiated air. In hot climates the air heaters are transformed into coolers by passing through them a cooling mixture.

**Ventilation of Oil Steamers.**—Upon emptying an oil tank quantities of gas are given off from the oily bulkheads, and as this gas is about three times as heavy as air it accumulates and lies at the bottom. This may be removed by using as conduits the large oil suction pipes after the oil is withdrawn, the impure air being withdrawn by the pumps. To secure a quicker action a centrifugal

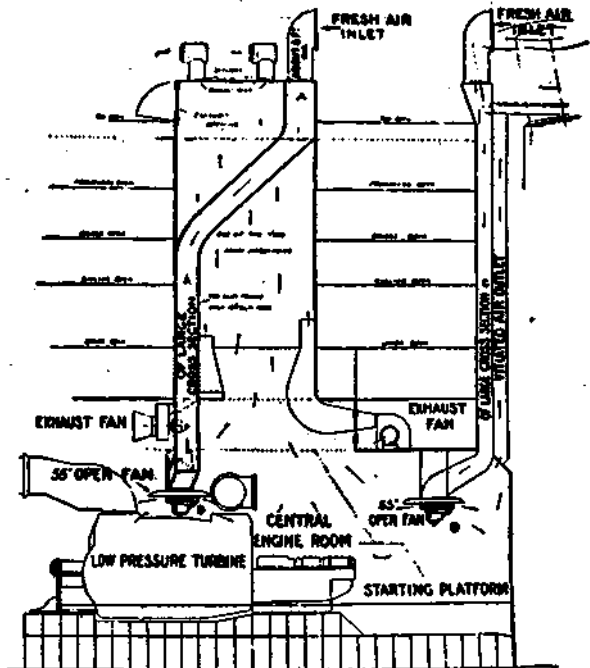

Figure 93.—Arrangement for Ventilating Engine Room.

fan may be substituted for the ordinary piston pumps, or instead the tanks may be cleaned by steam in connection with a system of continuous ventilation. See Oil Carriers.

**Engine Room Ventilation.**—Here, if natural ventilation is relied on, the ventilators should extend as far down in the engine room as practical without interfering with the machinery, with branches, if feasible, to both sides of the ship. In large vessels there may be a system of ducts and ventilators, air being circulated by a fan or fans. In fine weather the skylights are kept open, but even if they are closed the ventilators should be of sufficient size to prevent the engine room from becoming too hot.

On several transatlantic liners (*Aquitania*, *Transylvania*, *Tuscania*, etc.), for distributing the air around the engine room, at the bottom of the ventilators extending above the upper deck are large open fans as shown in Fig. 93. When desired the air may be changed 120 times an hour without uncomfortable drafts. The air is drawn, not forced, down from the upper deck and is delivered latterly by an open fan which is placed as low down in the engine room as practical so as to flood the entire engine room with air, the cool incoming air falling towards the floor displacing the heated air and expelling it up the main hatch or hatches or other exits, no exhaust fans being required. The impellers for these open fans are scooped on the inlet side and are of such shape that they slice into the incoming air and divert it gently from the axial into the radial direction. Outfits as just outlined are built by J. Keith & Blackman, London.

**Ventilators.**—These may consist of cylindrical steel plates extending to just below the deck, with an upper part that can be turned by hand so the mouth of the ventilator can face any direction. This type is for holds, engine and boiler rooms. Instead of the large mouth there may be vertical flues, which type is used for galleys, while for staterooms those with a mushroom top that can be raised and lowered by a screw are often installed. The ventilators to the firerooms of some torpedo boat destroyers have a cylindrical part of steel plates riveted to the deck and a hinged top. In bad weather the top can be brought down so that it is horizontal, and air may enter between the top and the cylindrical sides.

Ventilators to stokeholds should have an aggregate transverse area of .45 sq. in. for each pound of fuel burned per hour, or .675 sq. in. per i. h. p. for ordinary merchant vessels, or .75 sq. in. per i. h. p. for fast steamers on short runs and for warships. The

areas of the ventilator mouths should not be less than the following proportions:

Sq. in per pound of fuel	Vessels
1.35	10 -knot
1.24	12½-knot
1.13	15 -knot
1.03	17½-knot
.93	20 -knot
.85	22½-knot

**Fans.**—Theoretically there should be a difference in the form of the wheel designed for pressure and exhaust, but practically the difference between a blower and an exhauster is one of adaptation rather than construction. A blower forces the air into a given space, while an exhauster removes the air. (See also Draft, page 391.)

A fan for induced draft must be larger, in the sense that it must allow a larger volume of air to pass through it, than one for forced draft, because the volume of the hot gases is larger than the volume of the air that is to be delivered to the fan. In the ventilating of saloons, cabins, etc., the difference in the volume of the air will not be great, but care must be taken not to make the outlets smaller than the inlets. The liner *Lusitania*, in addition to the thermo-tanks, had 12 exhaust fans connected to the trunks of the galleys and lavatories, the fans being of sufficient capacity to change the air at least 15 times per hour.

There are certain trade definitions for describing a fan; thus, angular discharges are designated as top angular up blast discharge, top angular down blast discharge, bottom angular up blast or bottom angular down blast discharge. As one stands facing the outlet of a fan, a motor or an engine appearing on the right side of the fan characterizes the fan as being right-handed, and if on the left, left-handed.

Of the types manufactured those sold under the trade name *Strocco* have given excellent results. The runner is of the drum form with a large inlet chamber inclosed by a large number of long narrow blades that are curved forward. A peculiar feature of this fan is that the air leaves the blades at a higher velocity than the speed of the runner. This type is particularly adapted for high pressures, and where the air has to be forced through long ducts. It is not, however, reversible. The *Sicorro* is built by the American Blower Co., Detroit, Mich.

Another type of multivane fan is one where the blades are curved radially, and in addition each blade has several cup-shaped depressions which grip the air and overcome largely the tendency of the air to slip along the blades to the side opposite the inlet. This type is very efficient and is built by the B. F. Sturtevant Co., Hyde Park, Mass.

In other fans the blades are shaped somewhat like a screw propeller and the action is the same. While the air is being rotated, at the same time, owing to the obliquity of the vanes, it is propelled parallel to the axis of the fan. These fans do not deliver the pressure nor are they as efficient as multivane fans when the air has to travel through long ducts with curves. They are reversible.

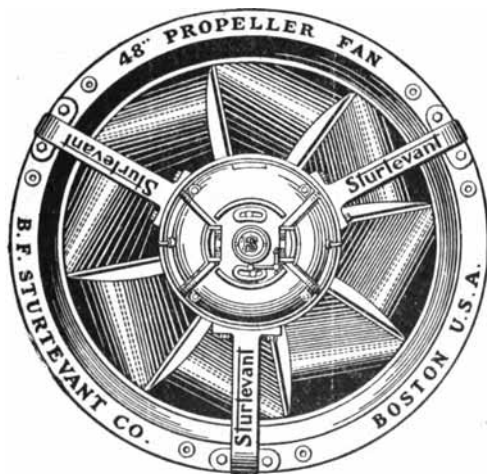

Figure 94.—Propeller Fan.

Fans are direct connected to steam engines, turbines, and electric motors (see Electricity); in many cases the latter are preferable. In motor boats small fans 18 to 24 ins. in diameter, driven by an electric motor taking the current from the lighting system, are often installed, the current required being only a fraction of a horse power.

Besides the thermotank outfits (see Systems above), there are also plenum ventilating cased fans (trade name *Rhigothermo*, built by J. Keith & Blackman, London) (see Fig. 92), consisting of a fan and

heater coils, the air flowing around the coils and thence to the distributing ducts. The mechanical efficiency of a Rhigothermo unit may be stated: that with a difference of temperature of 40° F. between the outside air in cold weather and of the air delivered into the main ducts, every 1,000 cu. ft. of air so delivered at a constant pressure of 2 ins., requires for electrical current the expenditure of  $\frac{1}{2}$  h. p., the fan assumed to be driven by an electric motor.

**To Find the Horse Power Required to Drive a Fan.**—Here the pressure on the entire cross-sectional area of the duct must be taken. For instance, if the air is moving at the rate of 500 ft. per minute under a pressure of 2 ins. water gauge, the duct being 4 ins. by 3 ins., having an area of 12 sq. ins., the total pressure will be  $12 \times 2 = 24$  ins. water gauge or 13 ounces, as one inch water gauge is equal to .55 ounce per square inch. Let the total pressure in pounds per square inch = 13 ounces or .81 lb. =  $p$ , and  $v$  = velocity of the air in feet per minute = 500.

Then the h. p. =  $\frac{p \times v}{33,000} = \frac{.81 \times 500}{33,000} = .012$ , which is the horse power for the air only. Hence in estimating the actual h. p. required, the result obtained from the formula should be doubled.

For practical purposes the capacity of a fan in cubic feet per revolution will equal .4 the cube of the diameter in feet. The volume of air delivered by a fan varies directly as the speed, while the power required varies as the cube of the speed. That is, doubling the speed doubles the volume of air, and the power required is increased eight times.

Ducts are made of light galvanized iron sheets with the inside laps in the direction of the air current. The resistance offered to the air depends directly on the length of the duct, and inversely as the cross-sectional area. The loss due to friction of air on the sides increases with the square of the velocity of the flow, so if the velocity is doubled the loss due to friction is increased four times. The smaller the duct the greater is the resistance to the air.

In galvanized iron, pipe turns of 90° should be constructed with at least 5 pieces and with a radius of curvature on the inner side of the elbow at least equal to the diameter of the pipe. Branches should lead from the main duct at an angle of about 30° so that the direction of air flow entering a branch will not be suddenly changed. Whenever it is necessary to change the size of a pipe, this should be done by a gradually tapering connection.

**VELOCITY, VOLUME AND HORSE POWER REQUIRED WHEN AIR  
UNDER GIVEN PRESSURE IN OUNCES PER SQUARE INCH IS  
ALLOWED TO ESCAPE INTO THE ATMOSPHERE**

Pressure in Ounces per Square Inch	Velocity of Dry Air at 50° F. Escaping into the Atmosphere through any Shape of Orifice in any Pipe or Reservoir in Which the Given Pressure is Maintained, in Feet per Minute	Volume of Air in Cu. Ft. Which May be Discharged in One Minute Through an Orifice Having an Effective Area of Discharge of 1 Sq. In.	Horse Power Re- quired to Move the Given Volume of Air Under the Given Conditions
1/8	1828.4	12.69	.00043
1/4	2585.0	17.95	.00122
3/8	3165.1	21.98	.00225
1/2	3653.8	25.37	.00346
5/8	4084.0	28.36	.00483
3/4	4472.6	31.06	.00635
7/8	4829.7	33.54	.00800
1	5161.7	35.85	.00978
1 1/8	5473.4	38.01	.01166
1 1/4	5768.0	40.06	.01366
1 3/8	6047.9	42.00	.01575
1 1/2	6315.2	43.86	.01794
1 5/8	6571.3	45.63	.02022
1 3/4	6817.6	47.34	.02260
1 7/8	7055.0	49.00	.02505
2	7284.4	50.59	.02759
2 1/8	7506.7	52.13	.03021
2 1/4	7722.2	53.63	.03291
2 3/8	7931.8	55.08	.03568
2 1/2	8135.7	56.50	.03852
2 5/8	8334.4	57.88	.04144
2 3/4	8528.3	59.22	.04442
2 7/8	8717.6	60.54	.05058
3	8902.8	61.83	.05058
3 1/8	9084.0	63.08	.05376
3 1/4	9261.5	64.32	.05701
3 3/8	9435.4	65.52	.06031
3 1/2	9606.1	66.71	.06368
3 5/8	9773.3	67.87	.06710
3 3/4	9938.0	69.01	.07058
3 7/8	10099.6	70.14	.07412
4	10258.6	71.24	.07771
4 1/4	10568.8	73.39	.08507
4 1/2	10869.5	75.48	.09264
4 3/4	11161.5	77.51	.1004
5	11445.5	79.48	.1084
5 1/4	11722.0	81.40	.1166
5 1/2	11991.5	83.24	.1249
5 3/4	12254.8	85.10	.1335
6	12511.9	86.89	.1422

From Heating and Ventilation, B. F. Sturtevant Co.

By means of the following table, the duct area in square inches may be found when the number of minutes for one air change, the velocity of air in the duct in feet per minute, and the size of the room are given.

DUCT AREA, IN SQUARE INCHES, FOR 1,000 CUBIC FEET OF CONTENTS FOR GIVEN VELOCITY AND AIR CHANGE  
(B. F. Sturtevant Company)

Number of Minutes to Change Air	Velocity of Air in Duct in Feet per Minute												
	300	400	500	600	700	800	900	1,000	1,100	1,200	1,300	1,400	1,500
4	120.0	90.0	72.0	60.0	51.6	45.0	40.0	36.0	32.2	30.0	27.6	25.6	24.4
5	96.0	72.2	57.6	48.0	41.1	36.1	32.0	28.8	26.2	24.0	22.2	20.5	19.2
6	80.0	60.0	48.0	40.0	34.3	30.0	26.6	24.0	21.8	20.0	18.5	17.1	16.0
7	68.6	51.4	41.1	34.3	29.4	25.7	23.9	20.6	18.7	17.2	15.7	14.7	13.7
8	60.0	45.0	36.0	30.0	25.8	22.5	20.0	18.0	16.1	15.0	13.8	12.8	12.0
9	53.3	40.0	32.0	26.6	22.9	20.0	17.8	16.0	14.5	13.3	12.3	11.4	10.7
10	48.0	36.0	28.8	24.0	20.6	18.0	16.0	14.4	13.1	12.0	11.1	10.3	9.6
11	43.6	32.2	26.2	21.8	18.7	16.1	14.6	13.1	11.9	10.9	10.1	9.5	8.7
12	40.0	30.0	24.0	20.0	17.2	15.0	13.3	12.0	10.9	10.0	9.2	8.6	8.0
13	36.9	27.7	22.2	18.5	15.7	13.8	12.3	11.1	10.1	9.2	8.5	7.9	7.4
14	34.3	25.7	20.6	17.2	14.7	12.8	11.4	10.3	9.5	8.6	7.9	7.4	6.9
15	32.0	24.0	19.2	16.0	13.7	12.0	10.7	9.6	8.7	8.0	7.4	6.9	6.4
16	30.0	22.5	18.0	15.0	12.9	11.2	10.0	9.0	8.2	7.5	6.9	6.4	6.0
17	28.2	21.2	16.9	14.1	12.1	10.6	9.4	8.5	7.7	7.0	6.5	6.1	5.6
18	26.6	20.0	16.0	13.3	11.5	10.0	8.9	8.0	7.3	6.6	6.2	5.7	5.3
19	25.3	18.9	15.2	12.6	10.8	9.5	8.4	7.6	6.9	6.3	5.8	5.4	5.1
20	24.0	18.0	14.4	12.0	10.3	9.0	8.0	7.2	6.5	6.0	5.5	5.1	4.8

Thus area of duct in square inches =  $\frac{\text{contents of room in cubic feet}}{1,000}$

× factor in table corresponding to the time of air change and the desired air velocity. The area can also be found when the air supply in cubic feet per person ( $S$ ), number of persons ( $N$ ) in the room, and the velocity ( $V$ ) of the air in feet per minute by the formula,

$$\frac{2.4 SN}{V}$$

**Laying Out Ventilating Systems.**—The location of the fans depends on the arrangement of the vessel. For instance, if there are a number of transverse bulkheads which cannot be pierced, then the compartments between these bulkheads must either have a separate system with its own fan, or there may be a common duct over the bulkheads with branches down to the compartments to be ventilated.

Ducts should be close up to the deck beams wherever possible. In one transatlantic liner the supply ducts extended down the passageways to the staterooms, discharging air overhead toward the side

**PRESSURE AND HORSE POWER LOST BY FRICTION OF AIR IN PIPES  
100 FEET LONG**

Dia. of Pipe Ins.	Loss of Pressure and Horse Power	Velocity of Air in Feet per Minute										
		1000	1200	1400	1600	1800	2000	2200	2400	2600	2800	3000
12	In. of Water.	.159	.229	.312	.408	.517	.638	.772	.920	1.080	1.250	1.420
	Ounces.....	.092	.133	.181	.237	.300	.370	.448	.533	.626	.728	.833
18	H. p. ....	.0198	.0343	.0544	.0812	.1156	.1586	.2111	.2741	.3495	.4353	.5354
	In. of water..	.107	.154	.208	.273	.345	.426	.516	.613	.719	.835	.959
24	Ounces.....	.062	.089	.121	.158	.200	.247	.299	.356	.417	.484	.556
	H. p. ....	.0297	.0512	.0816	.1218	.1735	.2380	.3167	.4112	.5226	.6530	.8031
30	In. of water..	.079	.116	.157	.205	.258	.319	.386	.460	.539	.626	.719
	Ounces.....	.046	.067	.091	.119	.150	.185	.224	.267	.313	.363	.417
40	H. p. ....	.0397	.0686	.1068	.1624	.2313	.3173	.4223	.5483	.6971	.8706	1.0708
	In. of water..	.064	.091	.126	.164	.207	.255	.308	.367	.431	.500	.577
44	Ounces.....	.037	.053	.073	.095	.120	.148	.179	.213	.250	.290	.333
	H. p. ....	.0496	.0857	.1360	.2031	.2891	.3966	.5279	.6855	.8714	1.0884	1.3388
48	In. of water..	.048	.066	.093	.122	.155	.191	.231	.276	.324	.376	.431
	Ounces.....	.028	.040	.054	.071	.090	.111	.134	.160	.188	.218	.250
52	H. p. ....	.0661	.1142	.1814	.2707	.3855	.5288	.7038	.9138	1.1618	1.4510	1.7847
	In. of water..	.043	.062	.085	.119	.141	.174	.212	.250	.295	.342	.391
56	Ounces.....	.025	.036	.049	.069	.082	.101	.122	.145	.171	.198	.227
	H. p. ....	.0727	.1256	.1995	.2938	.4240	.5817	.7742	1.0051	1.2779	1.5961	1.9632
60	In. of water..	.039	.057	.078	.102	.129	.160	.193	.231	.269	.312	.359
	Ounces.....	.023	.033	.045	.059	.075	.093	.112	.133	.156	.181	.208
64	H. p. ....	.0798	.1371	.2217	.3249	.4626	.6346	.8446	1.0965	1.3941	1.7412	2.1416
	In. of water..	.036	.053	.072	.095	.119	.146	.178	.212	.248	.289	.331
68	Ounces.....	.021	.031	.042	.055	.069	.085	.103	.123	.144	.168	.192
	H. p. ....	.0859	.1485	.2360	.3520	.5011	.6874	9.150	1.1879	1.5103	1.8864	2.3201
72	In. of water..	.034	.050	.067	.088	.110	.136	.165	.205	.232	.269	.308
	Ounces.....	.020	.029	.039	.051	.064	.079	.096	.119	.134	.156	.179
76	H. p. ....	.0925	.1590	.2539	.3790	.5406	.7403	.9854	1.2793	1.6265	2.0314	2.4970
	In. of water..	.033	.047	.062	.081	.104	.128	.150	.185	.216	.250	.288
80	Ounces.....	.019	.027	.036	.047	.060	.074	.090	.107	.125	.145	.167
	H. p. ....	.0691	.1213	.1721	.2461	.3482	.4932	.6832	9.1607	1.3706	1.7427	2.1765

From Heating and Ventilation, B. F. Sturtevant Co.

of the ship. Positive circulation throughout a stateroom was accomplished by extending an exhaust pipe down behind a dressing case, and providing it at the bottom with a suitable opening. The stateroom door had a latticed panel, thus giving a ready passage for the air.

First prepare deck, inboard profile and cross section plans of the vessel. Next calculate the amount of air required for each compartment. Then locate the fans and sketch on the arrangement plans the ducts which should be as straight as possible.

At the first outlet make the pressure 5 lb. per sq. ft., and the velocity about 2,000 cu. ft. per minute. This pressure is for standard conditions of air with a density corresponding to a barometric height of 30 ins., a temperature of 70° F., and a relative humidity of 70%. Under these conditions a cubic foot of air weighs .07465 lb. The



pressure of 5 lb. is equivalent to a pressure head of 67 ft. of air of standard density. A velocity of 2,000 ft. per minute corresponds to a velocity head of 17.27 ft. The total head against which air is delivered to the supply main is therefore 84.27 ft.\*

As the branches lead off, do not change the size of the main until sufficient air has been removed to reduce the velocity to a value between 1,200 and 1,500 ft. per minute. Then contract the mains with a taper of  $1\frac{1}{2}$  ins. to the foot until the area is so reduced that the velocity again becomes about 2,000 ft. per minute. Repeat the contraction wherever necessary but do not reduce the final diameter of the main to less than twice the diameter of the last branch.

$$\text{Air velocity in feet per minute in a duct} = \frac{\text{volume}}{\text{area}}$$

Loss of head in a round or square pipe is given by the formula:

$$H_F = 4 F \frac{L}{d} V_1^2$$

Where  $H_F$  = loss of head in feet of air due to friction

$F$  = coefficient of friction

$L$  = length of pipe in feet

$d$  = diameter of pipe in feet

$V_1$  = velocity of flow through the pipe in feet per second

If  $V_1$  is changed to  $V$  or velocity in feet per minute, and taking the value of  $F = .00008$  for first class piping, the above formula becomes

$$H_F = \frac{L V^2}{11,250,000 d}$$

Branches should make an angle of about  $30^\circ$  with the main. At the extreme end of the main, where the velocity is reduced, the angle may be increased, the last branch leading off at say  $90^\circ$ .

In cargo steamers at least one ventilator is required at each end of each hold, one serving as the intake and the other as the exhaust. If the hold is large there are two pairs. If a thorough ventilation of the cargo is desired, one of the two ventilators should extend to the bottom of the hold and the other to the deck only, but generally surface ventilation is sufficient, both ventilators stopping at the deck. In temperate climates the ventilation is ample if it merely removes or prevents the formation of heated or vitiated air. In the tropics it is necessary to have a constant movement of air.

\* This and following paragraph from The Naval Constructor, G. Simpson.

## REFRIGERATION

Different substances require different temperatures for their preservation. Mutton, lamb, rabbits, and some other meats may be frozen hard and if carefully thawed out when required for use are apparently not affected. Beef, though it can be frozen and is quite eatable, when thawed out does not command so high a price as if merely chilled, that is, reduced to a temperature a little above the freezing point of the meat. Chilled meat is hung on hooks while frozen can be stowed in piles; in both cases, however, the meat must be covered. Juicy fruits, eggs, and vegetables must not be frozen.

Dry still air is the best insulator known and other materials that are good insulators owe their property very largely to the fact that they contain a large number of very small air cells. The best insulating materials for refrigerating rooms are cork, silicate of cotton or slag wool (obtained from the slag iron melting furnaces), and finely divided charcoal. See Insulating Materials.

The space taken up by the insulation and the refrigerating machinery in a steamer designed for carrying meat or other perishable products, is from 18 to 20% of her cubic capacity, that is, the space available for carrying cargo without the insulation or the refrigerating machinery being considered.

In the steamer *Procida*, 3,928 gross tons, insulated capacity of spaces 210,000 cu. ft., 2,100 tons of frozen meat carried, carbon dioxide (CO<sub>2</sub>) brine circulating system, the insulation was as follows: "The insulating materials were regranulated cork, sheet cork, and mineral wool. The ship's side insulation consisted of 3 in. by 3 in. grounds bolted to the face of the frames and covered by  $\frac{1}{8}$  tongue and groove boards. The 9-in. space between the boards and the shell plating was tightly packed with regranulated cork. Over the  $\frac{1}{8}$ -in. boarding was placed 1 $\frac{1}{2}$ -in. sheet cork with nailing strips, and the whole covered with waterproof paper and a layer of 1 $\frac{1}{8}$ -in. tongue and groove boards, thus making an over-all thickness of approximately 12 $\frac{3}{8}$  ins.

"The insulation on the under side of the decks consisted of 6 in. by 2 in. grounds bolted to alternate frames by inch bolts and covered by  $\frac{1}{8}$ -in. tongue and groove boards. The space between the deck plating and  $\frac{1}{8}$ -in. boards was packed with regranulated cork. Below the  $\frac{1}{8}$ -in. boarding was a layer of 1 $\frac{1}{2}$ -in. cork with nailing strips, and the whole covered with waterproof paper and  $\frac{1}{8}$ -in. tongue and groove boards.

**COLD STORAGE TEMPERATURES\***  
(In Degrees Fahrenheit)

Substance	Degrees Fahrenheit	Substance	Degrees Fahrenheit
Ale.....	33-42	Hops (frozen).....	28
Apples.....	32-36	Honey.....	36-45
Apple and peach butter.....	40	Lard.....	34-36
Asparagus.....	33-35	Lemons.....	33-48
Bananas.....	34-35	Liver.....	30
Beans.....	32-40	Maple syrup and sugar.....	40-45
Beef (fresh).....	35-39	Margarine.....	18-35
Beer in casks.....	32-42	Meat (brined).....	35-40
Beer in bottles.....	45	Meat (canned).....	30-35
Berries (fresh).....	35-40	Meat (fresh).....	34-40
Buckwheat flour.....	40-42	Melons.....	35
Butter.....	14-38	Milk.....	32
Butterine.....	20-35	Mutton.....	33-36
Cabbages.....	32-35	Mutton (frozen).....	25-28
Cantaloupes.....	40	Nuts in shell.....	35-40
Carrots.....	33-35	Oatmeal.....	40-42
Celery.....	32-35	Oleomargarine.....	20-35
Cheese.....	28-35	Oil.....	35-45
Chestnuts.....	33-40	Onions.....	32-40
Cider.....	32-40	Oysters in tubs.....	25-35
Cigars.....	35-42	Oysters in shells.....	33-43
Clarets.....	45-50	Oxtails.....	32
Corn meal.....	42	Paranips.....	32-35
Cranberries.....	32-36	Peaches.....	34-55
Cream.....	35	Pears.....	40-45
Cucumbers.....	38-40	Plums.....	32-40
Currants.....	32	Porter.....	33-42
Dates.....	45-55	Pork.....	34
Eggs.....	30-35	Potatoes.....	34-40
Ferns.....	28	Poultry (frozen).....	20-40
Figs.....	35-55	Poultry (to freeze).....	5-22
Fish (fresh).....	20-30	Poultry (long storage).....	10
Fish (frozen).....	14-17	Sardines.....	35-40
Fish (canned).....	35	Sauerkraut.....	35-38
Fish (dried).....	35-40	Sausage casings.....	30-35
Fish (to freeze).....	5	Sugar.....	40-45
Flour.....	36-46	Syrup.....	35-45
Fruits.....	26-55	Tenderloin.....	30-35
Fruits (dried).....	35-40	Tomatoes.....	32-42
Fruits (canned).....	30-35	Tobacco.....	35-42
Furs (dressed).....	25-32	Veal.....	32-36
Furs (undressed).....	35	Vegetables.....	34-40
Grapes.....	32-40	Watermelons.....	34-40
Ginger ale.....	35-38	Wheat flour.....	40-42
Hams.....	20-35	Wines.....	40-50
Hops.....	30-35	Woolens.....	25-35
Hops.....	32-40		

\* Sanitary Refrigeration and Ice Making, J. J. Cosgrove.

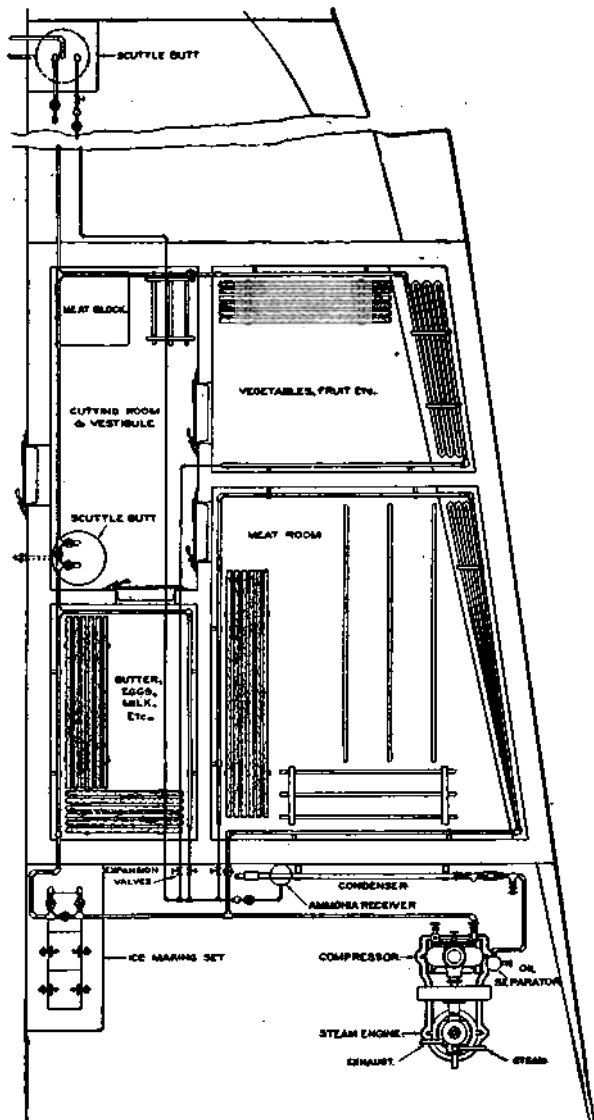

Figure 95.—Layout of a Refrigerating Plant.  
 (Brunswick Refrigerating Co., New Brunswick, N. J.)

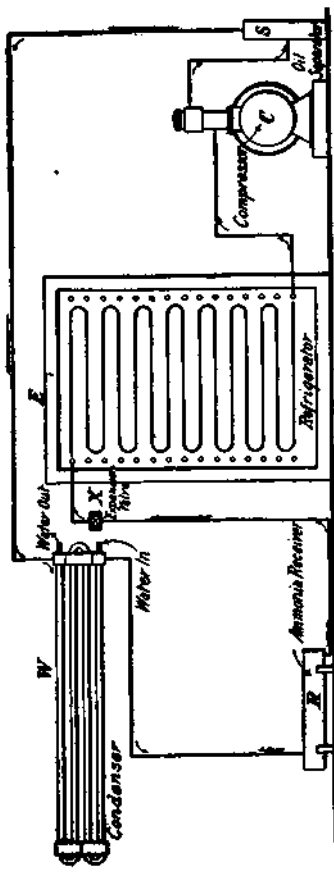

Figure 96.—Direct Expansion System.

"The margin plates of decks and bulkheads were insulated by a heavy hard wood ribband, fitted and bolted watertight to the top side of the margin plate at 4 ft. from the shell, carrying 2-in. tongue and groove boarding fastened to the ship's side insulation. The space between the 2-in. boarding and the deck was packed with sheet cork and grouted in with a plastic mixture of granulated cork and pitch.

"The insulation in way of beam knees was left portable for easy renewal of insulation filling in case of settlement. The bulkheads were insulated, the boiler and engine room bulkheads being insulated with mineral wool to minimize the danger of fire. The insulated limber hatches extended the whole length of the bulges. They had frames and coamings working from solid timbers. Each hatch section was 6 ft. long and had two lifting rings. All the steel work was galvanized.

"To prevent the meat from coming in contact with the cold pipes on the ceilings, bulkheads, and sides, wood gratings were attached to the pipe supports by lag screws, and arranged to allow an unrestricted air circulation about the pipes." \*

For the ventilating of refrigerating rooms the plenum or forced draft system is preferable to the induced. As to the quantities of air required, authorities differ. Some say that an introduction of a volume of air equal to that of the room should take place every day, while others say twice a day. The outlet for the escape of the foul air should be near the floor and the inlet near the ceiling. Below are outlined different refrigerating systems.

**Compression System.**—Here the refrigerating process takes place during the transformation of ammonia from a liquid to a gas, and is accomplished by allowing the liquid, compressed to 150 to 170 lb., to pass through a special valve known as the expansion valve to the expansion piping or brine coolers in which a much lower pressure is maintained.

The ammonia tends to vaporize at the lower pressure, but in order to do so it must be supplied with a certain amount of heat, namely, its latent heat of vaporization. The heat is absorbed from the surrounding substances by the ammonia in its passage through the piping or coolers after leaving the expansion valve. Through the expansion side of the plant the now vaporized ammonia returns to the compressor, is recompressed and forced through a condenser where the latent heat is absorbed. From the condenser the ammonia

\* Data on *Provida* from *International Marine Engineering*, June, 1916.

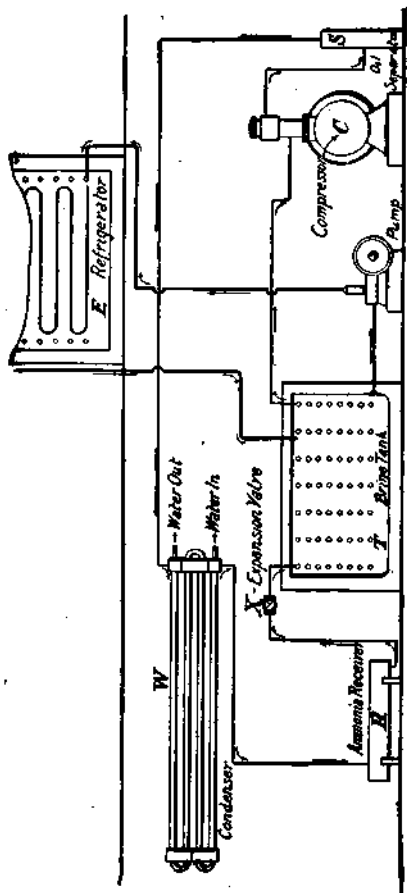

Figure 97.—Brine Circulating System.  
 (Brunswick Refrigerating Co., New Brunswick, N. J.)

flows to the receiving tank and from there to the expansion valve to commence again its cycle.

The expansion takes place either in the piping that is in direct communication with the substance to be cooled or in coolers submerged in a solution of brine. In the latter case, the brine is reduced to a very low temperature, and by means of a pump is circulated through the piping in the refrigerators or tanks. These two systems are known as the **direct expansion** and **brine circulating** respectively, and are shown in Figs. 96 and 97. The former is generally for small units and its chief advantages are simplicity, economy, ease of operation, and compactness.

The liquid ammonia stored in the receiver *R* (see Fig. 96), passes through the expansion valve *X* into the coils or piping located in the compartment to be cooled *E*, and after expanding returns to the compressor *C* where it is compressed and forced through the oil separator *S* to the condenser *W*. In *W* the ammonia is condensed by water circulation, and returned in liquid form to the receiver *R*.

In the brine circulating system the ammonia expands in pipes submerged in a brine tank as shown in Fig. 97, or in a cooler designed for the purpose and in conjunction with a smaller tank. The brine, cooled to a low temperature by the ammonia in the expansion piping or cooler, is pumped through the piping in the refrigerating compartment.

When it is desired to shut down the plant for a few hours daily, the brine tank is made sufficiently large for the storage of the cold brine, the temperature being maintained, when the compressor is shut down, by continuing the circulation with the pump.

The brine circulating system is recommended in large installations where the various compartments to be cooled are widely scattered. On account of the additional apparatus such as tank, cooler, pump, etc., more room is required, but the temperatures in the various compartments can be regulated more easily and uniformly.

The brine flows through the coils at the rate of about 3 ft. per second and is kept at a temperature  $8^{\circ}$  to  $10^{\circ}$  lower than that required in the chamber. For instance, if fruit is to be maintained at  $30^{\circ}$ , then the brine should be about  $22^{\circ}$ . The difference in temperature between the outgoing and return brine should be from  $3^{\circ}$  to  $5^{\circ}$ . A temperature of  $10^{\circ}$  requires double the length of pipe necessary for a temperature of  $32^{\circ}$ . Brine containing 25% chloride of calcium has been found satisfactory for ordinary marine use.



Plants operating on the ammonia compression system are built by the Brunswick Refrigerating Co., New Brunswick, N. J., in  $\frac{1}{2}$ -, 1-, 2-, 4-, 6-, 8-, 12- and 15-ton sizes.

In the systems just outlined ammonia is the refrigerant but instead carbonic anhydride (also known as carbon dioxide and carbonic acid,  $\text{CO}_2$ ) could have been. The greatest drawback to  $\text{CO}_2$  is the high pressure necessary, ranging from 200 to 1,000 lb. per square inch, while ammonia at a gauge pressure slightly above 15 lb. can be liquefied at a temperature of  $0^\circ\text{F}$ . Ammonia, if it escapes, has the disadvantage of affecting meat or other food products it comes in contact with, although  $\text{CO}_2$  does not.  $\text{CO}_2$  will not act on copper or iron pipes.

Owing to the lower temperature and greater rapidity of circulation of ammonia gas, less pipe surface is necessary in a direct expansion ammonia coil to produce a given refrigeration effect than would be required in a brine coil.

It is to be noted that the higher the sea temperature the higher the pressure required in the compressor. Ammonia ( $\text{NH}_3$ ) evaporates at  $-28^\circ\text{F}$ . when the pressure is 14.7 lb. (atmospheric), and has a latent heat of evaporation of 555 B. t. u. Carbonic anhydride evaporates at  $-110^\circ$  when the pressure is 14.7 lb., and has a latent heat of evaporation of 130 B. t. u.

The following is a description of apparatus using  $\text{CO}_2$  as built by J. & E. Hall, Ltd., of Dartford, Eng. The apparatus consists of three parts, viz., a compressor, a condenser, and an evaporator. The compressor draws in heated and expanded gas from the evaporator and compresses it. The compressed gas then passes to a condenser consisting of coils in which the warm compressed gas is cooled and liquefied by reduction of temperature caused by the action of the cooling sea water. From the condenser the cool liquid carbonic anhydride is conveyed into the evaporator consisting of coils, where it vaporizes and expands, absorbing heat in the process and cooling the surrounding brine which is in contact with the coils. This cold brine is circulated by a small pump to the refrigerating chamber where it is conducted through a long series of rows of cooling pipes termed grids, which are placed at the top of the chamber. The cold brine grids in this position set up a circulation of air, the cold air descending and being replaced by air not so cold which is cooled in its turn. Any moisture in the air is condensed on the grids and appears as frost on the pipes. The  $\text{CO}_2$  is supplied in steel cylinders.

The compressor may be either horizontal or vertical, and driven

either by a steam cylinder or by an electric motor. Modern war vessels often have installed electrically driven machines which have the advantage that they can be conveniently arranged in positions in which steam-driven cannot be. Thus the cooling units in a battleship may be placed close to the magazines they are to cool, avoiding the loss of cold from the transmission of low temperature brine through long length of pipe.

Below is a list of Kroeschell Bros.' (Chicago, Ill.) horizontal double-acting CO<sub>2</sub> compressors, with their refrigerating capacity.

Refrigerating Capacity of Machine in 24 Hours Tons	Ice Making Capacity of Machine in 24 Hours Tons	Horse Power Required
3	1.5	6
5	2.5	9
8	4	13
10	5	15
12	6	17
16	8	22
20	10	26
25	12.5	32
35	17.5	43
40	20	48
50	25	60
60	30	72
70	35	84
80	40	96
90	45	108
100	50	120
120	60	140

One ton of refrigeration is the amount of cooling done by the melting of one ton of ice at 32° F. into 1 ton of water at 32° F. This is equivalent to 284,000 B. t. u. The power in the above table is based on condensing water having a temperature of 70°.

**Cooling by Air.**—The Allen dense air machine (built by H. G. Roelker, New York City) produces cold by the expansion of air which has previously been compressed and then cooled by water. It uses air of about 65 lb. pressure and compresses it to approximately 235 lb., then cools it by passing it through a coil immersed in water; then an expanding engine brings the air back to 65 lb. and to a very low temperature. This cold air goes to the coils in the refrigerating room and after passing through them returns to the suction side of

the air compressor, where it is again compressed and the cycle just outlined is gone through again. The machines are built in  $\frac{1}{2}$ -, 1-, 2- and 3-ton sizes.

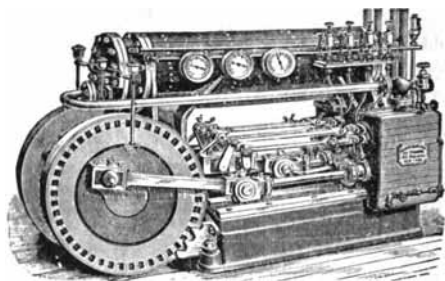

Figure 98.—Allen Dense Air Machine.

A practical rule for the square feet of refrigerating pipe required in a meat chamber to keep it at the freezing point is 1 sq. ft. of pipe surface for every  $2\frac{1}{4}$  to  $2\frac{3}{4}$  sq. ft. of interior surface of a well insulated meat chamber, omitting interior divisions. The piping should be so arranged that the air is compelled to pass all surfaces with a fair velocity.

**Pipe, Valves, and Fittings** for refrigerant piping are different from steam and water. If the refrigerant is ammonia, no brass enters into the design of any part of the valves and fittings. The operating principles of the valves are the same as for steam and water but they are made heavier and entirely of iron, or iron and aluminum.

On account of the high pressure under which refrigerating plants operate, extra strong wrought iron pipe is used for ammonia and double extra strong for  $\text{CO}_2$ . Ordinary steam and water fittings are suitable for brine circulation.

See also section on Piping.

**Linear Feet of Pipe Required.**—For direct cooling coils where the pipe surface is simply exposed to the air of the room to be cooled, Lorenz recommends a transmission allowance of not over 30 B. t. u. per square foot per hour. For an average room temperature of  $30^\circ$  and average brine temperature of  $10^\circ$ , this would correspond to  $\frac{30}{20} = 1.5$  B. t. u. transmitted per square foot per hour per degree difference.

*Example.* How many linear feet of 1¼-inch direct refrigerating coils would be required to keep a cold storage room at 30° if the refrigeration loss is 8,000 B. t. u. per hour and the temperatures of the brine entering and leaving the coils are 10° and 20° respectively? Average brine temperature 15° and a transmission constant of 1.5 allowed.

$$\begin{aligned} \text{Square feet of refrigeration} &= \frac{\text{Total B. t. u. lost}}{1.5 (\text{Temp. inside pipe} - \text{temp. outside})} \\ &= \frac{8,000}{1.5 (15 - 30)} = 355 \text{ sq. ft.} \end{aligned}$$

Circumference of 1¼-inch pipe = 5.2 ins., hence 1 ft. of pipe has an area of  $5.2 \times 12 = 62.4$  sq. ins. or .43 sq. ft.

$$\text{Then } \frac{355}{.43} = 825 \text{ ft. (nearly) of } 1\frac{1}{4} \text{ ins. pipe required.}$$

[Above from Cold Storage, Heating and Ventilating, S. F. Walker.]

**Capacity of Ammonia Compressors.**—The refrigerating capacity of a compressor depends on the number of pounds of gas it will handle in a given unit of time. The weight of ammonia gas handled depends upon the efficiency of the compressor and upon the suction pressure or the pressure at which the gas is delivered into the compressor.

Since the weight of ammonia gas varies approximately as the absolute pressure, it follows that the refrigerating capacity of a compressor varies with the absolute suction (or back) pressure. Thus a compressor working under a suction pressure of 30 lb. (gauge pressure) will have approximately 50% greater capacity than one working under 15 lb. gauge pressure, but the same low temperature cannot be obtained.

To determine the refrigerating effect produced by the evaporation of one pound of liquid ammonia at a given back pressure, a deduction must be made from the latent heat of evaporation at that pressure for the work required to cool the ammonia itself, from the temperature at which it enters the evaporating coils to the temperature at which the evaporation takes place. The temperature at which the ammonia enters the evaporating coils should be approximately that of the water used for condensing purposes.

The table given below shows the number of cubic feet of gas that must be pumped per minute at different suction and condensing pressures to produce one ton of refrigeration in 24 hours. The values given are theoretical ones; it is assumed that the temperature of the ammonia entering the evaporating coils corresponds to the temperature of condensation at the pressures given, and no allowance is made for unavoidable losses.

## NUMBER OF CUBIC FEET OF GAS

That must be pumped per minute at different condenser and suction pressures to produce one ton of refrigeration in 24 hours

Temperature of Gas in Degrees F.	Corresponding Suction Pressure Lb. per Sq. In.	Temperature of the Gas in Degrees F.								
		65	70	75	80	85	90	95	100	105
		Corresponding Condenser Pressure (gauge) lb. per Sq. In.								
		103	115	127	139	153	168	184	200	218
	G. P.									
- 27	1	7.22	7.3	7.37	7.46	7.54	7.62	7.70	7.79	7.88
- 20	4	5.84	5.9	5.96	6.03	6.09	6.16	6.23	6.30	6.43
- 15	6	5.35	5.4	5.46	5.52	5.58	5.64	5.70	5.77	5.83
- 10	9	4.66	4.73	4.76	4.81	4.80	4.91	4.97	5.05	5.08
- 5	13	4.09	4.12	4.17	4.21	4.25	4.30	4.35	4.40	4.44
0	16	3.59	3.63	3.66	3.70	3.74	3.78	3.83	3.87	3.91
5	20	3.20	3.24	3.27	3.30	3.34	3.38	3.41	3.45	3.49
10	24	2.87	2.91	2.93	2.96	2.99	3.02	3.06	3.09	3.12
15	28	2.59	2.61	2.65	2.68	2.71	2.73	2.76	2.80	2.82
20	33	2.31	2.34	2.36	2.38	2.41	2.44	2.46	2.49	2.51
25	39	2.06	2.08	2.10	2.12	2.15	2.17	2.20	2.22	2.24
30	45	1.85	1.87	1.89	1.91	1.93	1.95	1.97	2.00	2.01
35	51	1.70	1.72	1.74	1.76	1.77	1.79	1.81	1.83	1.85

Crane Co., Chicago.

To obtain the net refrigerating effect of a compressor it is necessary to determine: (1) the suction or back pressure, (2) the temperature at which the ammonia enters the refrigerating coils, (3) the percentage of allowance to cover unavoidable losses.

In the operation of a plant it has been found that the following conditions represent a fairly average practice: back or suction pressure 15.67 lb. above atmosphere (at which pressure ammonia evaporates at 0° F.); condensing water at 60° F., which gives ammonia liquid a temperature of about 65° F. Under these conditions it requires the handling of about 7,500 cu. ins. of gas per minute to produce the effect equal to the melting of one ton of ice in 24 hours.

**Refrigeration Required for the Cold Storage Room.\***—To find the number of British thermal units to be withdrawn to maintain a constant temperature in a storage room, multiply the area of the floor, walls, and ceiling in square feet by the constant 3, and the product by the number of degrees the rooms are to be lowered in temperature.

\* From Sanitary Refrigeration and Ice Making, J. J. Coagrove.

Let  $H$  = number of B. t. u. of refrigeration effort required  
 $A$  = area of floor, walls and ceiling in square feet  
 $T$  = temperature of adjoining compartments or outside air  
 $t$  = temperature to be maintained in cold storage room  
 $3$  = a constant for leakage of heat through the walls  
 Then  $H = 3 A (T - t)$

*Example.* How many British thermal units of refrigeration will be required a cold storage room 40 ft. by 50 ft. by 12 ft. high, to keep it at a temperature 35° F. when the outside temperature is 70° F.

$$\text{Area of wall} = [40 + 40 + 50 + 50] \times 12 = 2160$$

$$\text{Area of floor and ceiling} = 40 \times 50 \times 2 = 4000$$

$$\text{Total square feet} \quad \underline{6160}$$

$$\text{Temperature outside, } 70^\circ \text{ F.}$$

$$\text{Temperature inside, } 35^\circ$$

$$\text{Difference} \quad \underline{35^\circ}$$

Substituting in formula  $H = 3 A (T - t) = 3 \times 6160 (70^\circ - 35^\circ) = 646,800$  B. t. u.

There are 284,000 B. t. u. to one ton of refrigeration; hence to reduce British thermal units to tons divide 646,800 by 284,000 = 2.27 tons.

An empirical formula is to allow one ton of refrigeration to 2,000 cu. ft. of space for small installations, but more is required for large.

**Refrigeration Required to Cool Stored Goods.\***—Multiply the weight of the goods by their specific heats and the product by the difference between the ordinary heat of the stored goods and temperature of storage room.

Let  $H$  = number of British thermal units of refrigeration effort required  
 $W$  = weight of stored goods  
 $S$  = specific heat of stored goods  
 $T$  = temperature of goods when put in storage  
 $t$  = temperature of cold storage room  
 $H = W S (T - t)$

When several kinds of goods are stored, each having a different specific heat, then the sum of all their weights and specific heats is required and the formula is  $H = W S (T - t) + W_1 S_1 (T - t)$ , etc., where  $W S$ ,  $W_1 S_1$ , etc., refer to different goods, as  $W S$  would equal the weight times the specific heat of beef,  $W_1 S_1$  the weight times the specific heat of pork, etc.

*Example.* Find the refrigeration required to cool 25,000 lb. of lean beef from a temperature of 95° F. to 35° F.

From the table of Specific Heats the specific heat of beef above the freezing point is .77, and the difference in temperature between 95° and 35° = 60°. Substituting these values in the formula,

$$H = W S (T - t) = 25,000 \times .77 \times 60 = 1,155,000 \text{ B. t. u.}$$

Dividing 1,155,000 by 284,000 (the number of B. t. u. in a ton of refrigeration),

the quotient will be  $\frac{1,155,000}{284,000} = 4.06$  tons.

\* From Sanitary Refrigeration and Ice Making, J. J. Caspary.

## SPECIFIC HEAT AND LATENT HEAT OF VARIOUS FOOD PRODUCTS

Substance	Composition		Specific Heat Above Freezing in Heat Units	Specific Heat Below Freezing in Heat Units	Latent Heat of Freezing in Heat Units
	Water	Solids			
Lean beef.....	72.	28.	0.77	0.41	102
Fat beef.....	51.	49.	.60	.34	72
Veal.....	63.	37.	.70	.39	90
Fat pork.....	39.	61.	.51	.30	55
Eggs.....	70.	30.	.76	.40	100
Potatoes.....	74.	26.	.80	.42	105
Cabbage.....	91.	9.	.93	.48	129
Carrots.....	83.	17.	.87	.45	118
Cream.....	59.25	30.75	.68	.38	84
Milk.....	87.50	12.50	.90	.47	124
Oysters.....	80.38	19.62	.84	.44	114
Whitefish.....	78.	22.	.82	.43	111
Eels.....	62.07	37.93	.69	.38	88
Lobster.....	76.62	23.38	.81	.42	108
Pigeon.....	72.40	27.60	.78	.41	102
Chicken.....	73.70	26.30	.80	.42	105

The specific heat of a substance is the ratio of the heat required to raise the temperature of a certain weight of the substance one degree Fahrenheit, to that required to raise the temperature of the same weight of water one degree. As the specific heat is not constant at all temperatures it is generally assumed that it is determined by raising the temperature from 62° to 63° F. For most substances it is practically constant for temperatures up to 212° F.

**Horse Power required.**

I. h. p. of engine for steam-driven compressor = 1.4 × rating of ice machine in tons of refrigeration per 24 hours.

or

I. h. p. = 2.8 × rating of machine in tons of ice per 24 hours.

Three tons of coal per 24 hours were required to operate the refrigerating plant of the steamer *Procida* (see page 587).

**Operating and Miscellaneous Notes.**—Refrigerating machines are rated in two ways, viz., ice-making capacity or tons of ice they will produce in one day of 24 hours, and refrigerating capacity or cooling done by one ton of ice melting per day of 24 hours. Thus a machine which, if operated 24 hours a day, will do the work of the melting of one ton of ice in 24 hours is called a one-ton machine. Roughly, the ice-making capacity is about one-half of the refrigerating capacity.

The power required for refrigerating machinery varies from 2. h. p. per ton of refrigeration up to 5. h. p.

Meat and other products must not be handled any more than can possibly be helped. In many instances when frozen sheep are brought from New Zealand to England, each is inclosed in a linen bag.

The Rules of the Board of Trade (British) require that machines using ammonia and other poisonous gases shall be placed in an isolated and well ventilated space entirely apart from the engine room or other part of the vessel to which the crew or passengers have free access, whereas a CO<sub>2</sub> refrigerating machine may be and is frequently erected in the main engine room.

For the cooling effect it is necessary that a difference of temperature should exist between the gas in the condenser coils and the circulating sea water, the latter having the lower temperature so that the excess heat picked up by the refrigerant from the brine in the evaporator may be transferred to the circulating water and so carried overboard.

If the sea water rises to a temperature of say 80° F., then the temperature of the ammonia or CO<sub>2</sub> must be in excess of this by 8° or 10° to allow of heat transfer, and to obtain this difference of temperature the pressure of the gas must be increased in due proportion.

For a gas temperature of 90° the ammonia pressure should be about 180 lb. and the CO<sub>2</sub> pressure 1,140 lb., and if the sea temperature rises to 85° and the gas temperature is to be say 93°, the ammonia pressure would need to be 200 lb. and the CO<sub>2</sub>, 1,180 lb. per square inch, so that the higher the sea temperature the higher the pressure required in the compressor to maintain the necessary difference in temperature.

Costs, see Prices, Costs and Estimates.

### DRAINAGE SYSTEM

For removing the water that collects in the bilges from the sweating of the hull and other causes, a drainage system is necessary. In motor boats and other small craft a portable pump with a rubber suction pipe is all that is required. In larger vessels the pump is permanently fastened to the deck with pipes leading to the bilge. In both cases the pumps are hand operated.

For vessels say 120 ft. or over there is required a steam-driven pump, and often other pumps, as the donkey, are connected to the



drainage system. The piping generally consists of a main drain between the engine and boiler rooms and an auxiliary drain running fore and aft with branches to the different compartments, or a pipe to each compartment, the pipes being connected to a common manifold.

All suction pipes must have perforated nozzles at their ends or lead into strainers to prevent cotton waste and other materials from being drawn into the pump.

**Main Drain.**—This consists of a large pipe from the forward boiler room to the engine room bilge with an opening to each boiler room fitted with a sluice valve and a non-return check valve. In the engine room bulkhead are also sluice valves.

If the boiler room is flooded and it is desired to pump it out, it is only necessary to open the sluice valve from the flooded boiler room to the main drain and the sluice valve at the engine room bulkhead and to start up the drain pump. Care must be taken that no water is allowed to drain into the engine room bilges that cannot be handled by the pump.

Drain pipes may be installed at the forward end of the ship, the pipes discharging into the forward boiler room bilge, and similar pipes installed at the after end discharging into the engine room bilges. Sluice valves are fitted to the pipes at the boiler and engine room bulkheads, screw-down valves at the other main bulkheads, and screw-down non-return valves at the end of each branch.

**Auxiliary Drain.**—Besides the main there is an auxiliary drain of about 6 ins. in moderate size vessels and 10 or 12 ins. in large size vessels, that extends fore and aft along the tank top. It is connected to the fire and bilge pumps and the hand pumps, and has branches to the various compartments including the double bottom. Compartments, as the wing spaces which have no branches to the auxiliary drain, are drained to adjacent compartments by sluice valves which should be arranged so as to be operated from above the water line.

The auxiliary drain has screw-down valves at each main bulkhead, screw-down non-return valves to the branches to the compartments, and similar valves to the double bottom. To pump out any compartment to which a branch leads, open the valve at the end of the branch, all the bulkhead valves on the main suction between the compartment and the pump it is desired to use, the valve between the pump and the main suction, and the valve between the pump and the discharge overboard. It is necessary that

all the valves on the other branches shall be tightly shut; otherwise the pump would draw air through them.

Instead of an auxiliary drain as above, pipes may be run to every compartment, all the pipes being connected to a common manifold usually located in the engine room. This manifold in turn is connected to the drain pump and to other pumps, as the donkey. With this arrangement any compartment can be drained entirely independent of any other, which is preferable to a large auxiliary drain with branches.

**Notes.**—The U. S. Steamboat-Inspection Rules (1916) state: "Each and every steam vessel shall be fitted with a bilge pipe leading from each compartment and connecting with a suitable marked valve to the main bilge pump in the engine room, and each compartment of all steam vessels shall be fitted with suitable sounding pipe, the opening of which shall be accessible at all times, except that in compartments accessible at all times for examination no sounding tubes are necessary. Steam siphons may be substituted in each compartment for the bilge pipes."

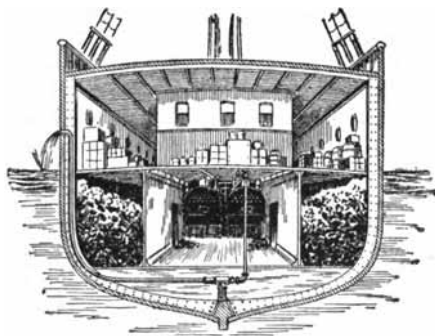

Figure 99.—Draining by Bilge Ejector.

Lloyd's Rules state: "A bilge injection or a bilge suction to the circulating pump is to be fitted. The engine bilge pumps are to be fitted capable of pumping from each compartment of the vessel, the peaks excepted. All bilge suction pipes are to be fitted with strum boxes or strainers, so constructed that they can be cleared without breaking the joints of the suction pipes. The total area of the perforations in the strainers should be not less than

double that of the cross-section of the suction pipe. The mud boxes and roses in the engine room are to be placed where they are easily accessible.

**"Hold with Double Bottoms.**—In the double bottom of each compartment of the holds and of the engine and boiler spaces a steam pump suction is to be fitted at the middle line, and one on each side to clear the tanks of water when the vessel has a heavy list.

"Where there is a considerable rise of floor towards the ends of vessels, the middle line suction only will be required. A steam pump suction and a hand pump are also to be fitted to each bilge in each hold where there is no well. Where there is a well one or three steam pump suctions are to be fitted in the same according as there is considerable or little rise of floor, and hand pump suctions are to be fitted at the bilges.

**"Holds without Double Bottoms.**—Where there is considerable rise of floor, one steam pump suction and one hand pump are to be fitted in each hold. Where there is little rise of floor 2 or 3 steam pump suctions and at least one hand pump suction are to be fitted to each hold.

**"Engine and Boiler Space.**—Where a double bottom extends the whole length of the engine and boiler space, 2 steam pump suctions are to be fitted to the bilge on each side. Where there is a well, one steam pump suction should be fitted in each bilge and one in the well. Where there is no double bottom in the machinery space center and wing steam pump suctions should be fitted.

The rose box or strum of the bilge injection is to be fitted where easily accessible. The main engine bilge pump and the donkey pump are to be arranged to draw from all compartments, and the donkey pump is to have a separate bilge suction in the engine room which can be used at the same time as the main engine bilge pumps are drawing from any part of the vessel.

**"Fore and After Peaks.**—If the peaks are fitted as water ballast tanks, a separate steam pump suction is to be led to each. If not used for water ballast an efficient pump is to be fitted in the fore peak. If the after peak is used as a ballast tank, no sluice valve or cock is to be fitted to the after bulkhead, but if it is not so used, and if no pump is fitted in it a sluice valve or cock is to be fitted to the after bulkhead to allow water to reach the pumps when required.

**"Tunnel.**—The tunnel well is to be fitted with a steam pump suction.

"All Hand Pumps are to be capable of being worked from the upper or main decks or above the load water line, the bottoms of the pump chambers are not to be more than 24 ft. above the suction rose and the pumps are to be tested by the surveyors to ensure that water can be pumped from the limbers. The sizes of the hand pumps are to be not less than those in the following table:

Tonnage Under Upper Deck	Hand Pumps in Holds	
	Dia. of Barrel, Ins.	Dia. of Tail Pipe, Ins.
In vessels not exceeding 500 tons.....	4	2
Above 500 tons but not exceeding 1,000 tons.....	4½	2¼
Above 1,000 tons but not exceeding 2,000 tons.....	5	2½
Above 2,000 tons.....	5½	2¾

"In lieu of hand pumps in each compartment an approved fly-wheel pump may be fitted if it is connected to the steam pump bilge suction pipes of these compartments.

"The hand pumps may be dispensed with in vessels which have 2 independent boiler rooms, or a donkey boiler above the bulkhead deck, and steam pumps (workable from either source of steam) in 2 separate compartments connected to the suctions.

"The bilge injection should not be less than two-thirds of the diameter of the sea inlet to the circulating pump. The inside diameter of other bilge suction pipes should not be less than those below:

Tonnage Under Upper Deck	Engine Room Center Suction, Separate Donkey Suction and Hold Center Suction	Wing Suction in Holds Where no Center Suctions are Fitted and Wing Suctions in Engine Room	Wing Suctions in Holds Where Center Suctions are Also Fitted
	Inches	Inches	Inches
In vessels not exceeding 500 tons.....	2	2	2
Above 500 but not exceeding 1,000 tons.....	2¼	2	2
Above 1,000 but not exceeding 1,500 tons.....	2½	2¼	2
Above 1,500 but not exceeding 2,000 tons.....	3	2¾	2¼
Above 2,000 but not exceeding 3,000 tons.....	3½	3	2½
Above 3,000 tons.....	3½	3½	2¾

"In cases where more than one suction to any one compartment are connected to the pumps by a single pipe, this pipe should be not less than the size required for the center suction."

As the frequent thumpings of a sounding rod are likely to damage the plating below it, a small doubling plate should be riveted under each rod.

A sluice valve should never be fitted to the collision bulkhead, nor should one be fitted to a watertight bulkhead unless the valve is readily accessible at all times.

In warships the wings and coal bunkers are drained on to the inner bottom, in which are pockets formed to catch the water, the pockets being pumped out by branches from the main suction and from the fire and bilge pumps. The double bottom spaces are drained from one to the other through drain holes cut in the non-watertight longitudinals, and sluice valves are fitted on the watertight longitudinals. To allow the air to escape from the double bottom compartments while they are being filled with water, escape pipes are fitted at the top of each compartment.

## PLUMBING

Under this heading are included all pipes and fittings connected to lavatories or conveying fresh water for drinking purposes.

**Fixtures.**—Fittings on the hull through which salt water is drawn should have a perforated plate at the outboard end to prevent sticks and other foreign matter being drawn in. The connection between the hull and the suction of the pump should be of copper.

For motor boats and small yachts a wash stand with a tank on top, or a pitcher nearby, serves to hold the fresh water, the discharge from the basin running into a pail below. Others are made so as to fold up, thus taking up a minimum amount of room. Some have hand pumps which draw the water from the fresh water tanks; others have faucets, thus requiring the water to be under pressure.

Either of two types of bathtubs may be installed, viz. Roman, which slopes at both ends and usually has the connections at the back, and the French, which slopes at one end only. The former is adapted for placing along a wall away from corners, while the latter is for corners. The best grade is made of porcelain or earthenware lined with enamel; the second, cast iron painted or

lined with porcelain enamel; and the cheapest, tinned sheet copper lining over a cast iron base. Sizes about 5 ft. long, 2 ft. 5 ins. wide by 2 ft. high.

Sinks for kitchen and pantry should have little wood work around them, and are deeper than shore outfits. The kitchen sinks are of cast iron or sheet metal and the pantry of copper.

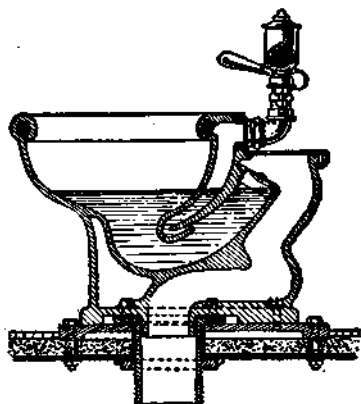

Figure 100.—Closet. (*J. L. Mott Co., New York.*)

**Closets.** These may be divided into (1) syphon jet, washdown and washout and (2) pump closets. In the former (1) it is necessary to supply the closet with water by a direct pressure system (compressed air or steam operated ejector) or a tank for a gravity supply. In the latter (2) by working a pump, the discharge is forced out. Closets with a pressure discharge are usually installed on large vessels,—one maker advises that he has furnished more syphon closets than washout, and another maker recommends that on ocean steamers the washdown bowl be used instead of the washout.

Pump closets are for small yachts and motor boats. The inlet for the water should be below the discharge and over the inlet at the side is a perforated plate. When the closet is set so the top of the bowl is below the water line, the discharge pipe should have its highest point at least 6 ins. above the water line, for by so doing flooding is prevented should any obstruction become lodged under the valve. In large vessels the closets may be flushed by water from overhead tanks, requiring a complete salt water flushing

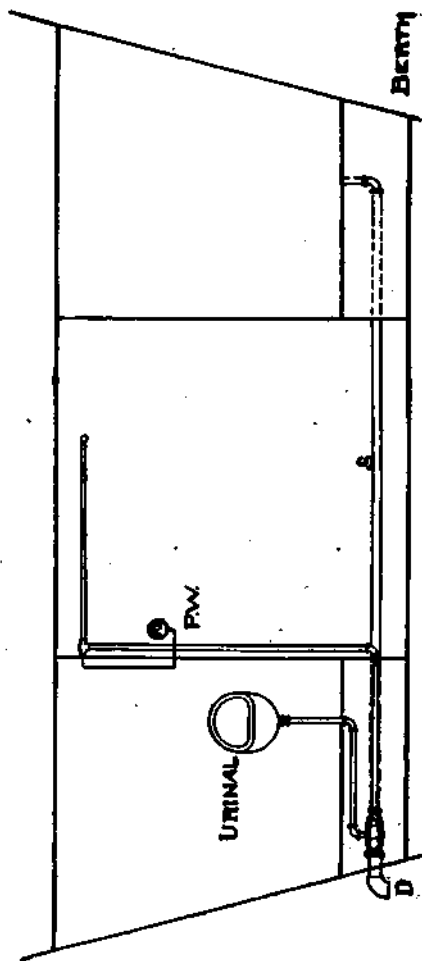

Figure 101.—Elevation Showing Piping to Water-jet Eductor.

system with a sanitary pump. Closet bowls should have a back water check valve.

Waste lines should be of galvanized iron pipe or lead pipe with brass clean out plugs at the bends. As far as practicable the discharge from each fixture in the toilets and bathrooms should be separately trapped and have a separate branch to the discharge pipe. The number of discharge pipes should be kept at a minimum to reduce the number of openings in the shell plating, the openings being just above the load water line, and having at the lower end a flap valve. Where possible, the waste from bathtubs, lavatories, and shower baths should connect with the deck scuppers, but in no case should the drains from the water-closets and sinks connect with the scuppers.

For discharging soil from baths, urinals, etc., a water jet eductor may be used as shown in Fig. 101. The pressure water is brought to the eductor through the pipe *PW*, and the various drains and soil pipes connected to pipe *S*. To start the eductor all that is necessary to do is to turn on the pressure water. The pressure in pounds per square inch at the eductor, when in operation, should not be less than  $2\frac{1}{2}$  times the elevation in feet. Thus for an elevation of 10 ft., there should be a pressure of 25 lbs. Fig. 101 is from Schutte & Koerting, Philadelphia.

**Fresh Water Service.**—This consists of pipes to the fresh water tanks and pumps for drawing from same and discharging into the fresh water system with branches to drinking stands and to lavatories. The faucets at the lavatories and drinking stands should be automatically closing to prevent waste of water. A strainer should be fitted in the suction pipe close to the pump, the pump maintaining a constant pressure in the system, by means of a governor valve set at 20 to 50 lbs. according to the size of the vessel. The pressure line should also have a connection through a safety valve to the suction of the fresh water pump, which carries off the surplus water.

For supplying hot fresh water, Ashwell & Nesbit, Leicester, Eng., install copper heaters supplemented by a large copper storage cylinder. The water is heated in the heaters by steam and is circulated by mechanical means, continually flowing out of the storage cylinder around the ship and returning to the heaters again. Each draw-off has thus an immediate supply of hot water when a faucet is opened, and there is no waste due to drawing off a large volume of tepid water before hot water is available.



Or instead of the above there may be calorifiers located in different parts of the ship. As built by A. Low & Sons, Glasgow, they consist of a casing in which is steam surrounding the water to be heated. No steam trap is required as the calorifiers are designed in such a way as to condense all the steam supply, and when fitted with an automatic control valve one may supply several baths or basins. They are made of copper and brass, and may be silver or nickel plated. The table given below contains data from actual tests.

Size of Calorifier		Size of Steam Connection Ins.	Gallons per Minute Heated to 100° F. Steam Pressure			
Length Ins.	Diameter Ins.		65 Lb.	50 Lb.	30 Lb.	20 Lb.
12	2¼	¾	4¾	4	2½	2
12	3	¾	9½	8	6	4½
16½	3½	½	13½	11	7½	5½
19	4½	¾	38	30	20½	15½
21½	5	¾	45	35	25	20

### FIRE EXTINGUISHING AND ALARM SYSTEMS

**General Requirements.**—Every steamer permitted by her certificate of inspection to carry as many as 50 passengers or upward, and every steamer carrying passengers which also carries cotton, hay, or hemp, shall be provided with a good double-acting steam fire pump, or other equivalent apparatus for throwing water. Such pump or other apparatus shall be kept at all times in good order, having at least two pipes of suitable dimensions, one on each side of the vessel, to convey the water to the upper decks, to which pipes there shall be attached by means of stop cocks or valves, both between decks and on the upper deck, good and suitable hose to stand a pressure of not less than 100 lb. per sq. in., long enough to reach all parts of the vessel and properly provided with nozzles.

Every steamer exceeding 200 tons burden and carrying passengers shall be provided with two good double-acting fire pumps to be worked by hand, each chamber of such pumps shall be of sufficient capacity to contain not less than 100 cu. in. of water; and such pumps shall be placed in the most suitable parts of the vessel for efficient service, having suitable well-fitted hose to each pump, of at least one-half the vessel in length. On every steamer not

exceeding 200 tons, one of such pumps may be dispensed with. Each fire pump thus prescribed shall be supplied with water by a pipe passing through the side of the vessel so low as to be at all times under water when she is afloat. Every steamer shall also be provided with a pump which shall be of sufficient strength and suitably arranged to test the boilers. (Abstracts from U. S. Steamboat-Inspection Rules, sec. 4471.)

**Fire Main (Water).**—This consists of a pipe running fore and aft practically the entire length of the ship with numerous vertical branches called risers. At each riser a valve is fitted close to the main line so that any riser can be shut off if desired. A special fire pump is connected to the fire main as are also other pumps, as the donkey, which can be started should the fire pump break down.

The U. S. Steamboat-Inspection Rules (1916) state: "All pipes used as mains for conducting water from fire pumps on board vessels in place of hose shall be of wrought iron, brass, or copper pipe, with brass or composition hose connections.

"Steamers required to be provided with double-acting steam fire pumps or other equivalents for throwing water shall be equipped with such pumps according to their tonnage as follows: Steamers over 20 tons and not exceeding 150 gross tons shall have not less than 50 cu. ins. pump cylinder capacity. Steamers of over 150 gross tons and under 3,000 tons shall have not less than one-third of one cubic inch pump cylinder capacity for every gross ton. Steamers of 3,000 gross tons and over shall have pump cylinder, of not less than 1,000 cu. ins. capacity.

"Upon such steamers fire mains shall be led from the pumps to all decks, with sufficient number of outlets arranged so that any part of the steamer can be reached with water with the full capacity of the pumps and by means of a single 50-foot length of hose from at least one of the outlets. On all classes of steamers every such pump shall be fitted with a gauge and a relief valve adjusted to lift 100 lb.

"All steam fire pumps required shall be supplied with connecting pipes leading to the hold of the vessel with stopcocks or shut-off valves attached and so arranged that such pumps may be used for pumping and discharging water overboard from the hold.

"All fire hose shall be tested to a pressure of 100 lb. to the square inch at each inspection."

For Pumps, see section on Pumps.

**WATER STREAMS**  
**Discharge from Nozzles at Different Pressures**

Nozzle, Dia. Ins.	Height of Stream Ft.	Pressure at Play Pipe Lb.	Horizontal Projection of Streams Ft.	Gallons per Minute	Friction per 100 Ft. of Hose Lb.	Friction per 100 Ft. of Hose— Net H'd Ft.
1	70	46.5	59.5	203	10.75	24.77
1	80	59.	67.	230	13.	31.1
1	90	79.	76.6	267	17.70	40.78
1	100	130.	88.	311	22.50	54.14
1 1/8	70	44.5	61.3	249	15.50	35.71
1 1/8	80	55.5	69.5	281	19.4	44.7
1 1/8	90	72.	78.5	324	25.4	58.52
1 1/8	100	103.	89.	376	33.8	77.88
1 1/4	70	43.	66.	306.	22.75	52.42
1 1/4	80	53.5	72.4	343	28.4	65.43
1 1/4	90	68.5	81.	388	35.9	82.71
1 1/4	100	93.	92.	460	57.75	86.98
1 3/8	70	41.5	77.	368	32.5	71.88
1 3/8	80	51.5	74.4	410	40.	92.16
1 3/8	90	65.5	82.6	468	51.4	118.43
1 3/8	100	88.	92.	540	72.	165.89

See Flow of Water in Pipes; and Loss of Pressure.

**Fire Main (Steam).**—The U. S. Steamboat-Inspection Rules (1916) state: "The main pipes and their branches on steamers carrying passengers or freight, to convey steam from the boilers to the hold and separate compartments of the same shall be not less than 1 1/2 ins. in diameter. Steam pipes of not less than 3/4 of an inch in diameter shall be led to all lamp lockers, oil rooms and like compartments, which lamp lockers, oil rooms and compartments, in all classes of vessels shall be wholly and tightly lined with metal. All branch pipes leading into the several compartments of the hold shall be supplied with valves, the handles distinctly marked to indicate the compartment or parts of the vessel to which they lead.

"These valves or their handles shall be placed in the most accessible part of the main deck of the vessel and so arranged that all can be inclosed in a box or casing, the door of which shall be plainly marked with the words—Steam fire apparatus.

"On all oil-tank steamers the valves instead of being located near the hatches on the upper deck, shall be all in an accessible house in which the operator is well protected from heat and smoke; Provided, That on oil-tank steamers a main line of steam smothering

pipe of sufficient area to supply all branch pipes leading from the same to the tanks may be run the entire length of the deck, and only the main stop valve of the main line shall be required to be housed. All branch pipes shall be provided with valves which shall be left open at all times, so that the steam may enter all compartments simultaneously. Such branches as may not be required after the fire is definitely located may be shut off, in order that the entire system may be concentrated on one tank.

"Provided, That carbonic acid gas or other extinguishing gases or vapors may be substituted in place of steam as aforesaid and for the above described purposes, when such gas or vapor and the apparatus for producing and distributing the same shall have been approved by the Board of Supervising Inspectors; Provided, That the use of such apparatus shall be allowed by law.

"Provided further, That pipes for conveying steam from the boilers, or pipes for conveying carbonic acid gas or other extinguishing vapors for the purpose of extinguishing fire, shall not be led into the cabins or into passengers' or crew's quarters."

**Sulphur Dioxide and Sprinkler Systems.**—Of the former is Grimm's fire extinguishing and fumigating apparatus built by A. Low & Sons, Glasgow. Here commercial sulphur, or roll brimstone as it is known in the trade, is put into a furnace into which air is forced in such quantities as to form perfect combustion, the continuance of which is dependent only upon the periodical supply of sulphur, and this is accomplished by a patented device on top of the machine through which no sulphur fumes can escape. The furnace is placed inside a water jacket of rectangular form through which water is circulated. The gas is forced from the dome of the furnace by its elasticity, and after passing through cooling tubes in the water jacket it is then discharged from the machine in a dry, cool condition, whence it is conveyed through a pipe or hose to its destination. One of the features of this system is that the air only is pumped and that into the furnace where the gas is generated; thus the gas is discharged under pressure, so that it does not come in contact with the blower.

The following is a description of an installation on the steamer *Minnesota* of the American-Hawaiian Co. The gas machine is placed in a steel deck house 8 ft. by 13 ft., on the upper deck just abaft the funnel; from this a 3-in. main discharge pipe extends on the starboard side forward and aft under the shelter deck. The main pipe leads to 6 valve chests, all on the shelter deck, from

which 2½-in. branch pipes extend to 2 ft. from the floor of each hold. The vertical branch pipes are laid well up against the bulkheads or against the ship's frames. All the piping is of galvanized iron.

**Sprinkler Systems.**—There are two types, viz., the wet and the dry pipe. In the former, water is always in the pipes and when the valves open, due to the rise in temperature caused by a fire, it rushes out at once. One of the disadvantages of this system is that if the pipes are not well covered the water will freeze in winter and burst them.

In the dry pipe system, pressure tanks are provided containing sufficient water for a primary supply, the water being held in check by a specially designed valve, which is made inoperative by the water under pressure on the one side and air under pressure on the other side. When the heat from the fire melts the solder on the sprinkler, the head opens, liberates the air in the pipes and reduces the air pressure, allowing the valve to open and the water to fill the pipes and flow out of the open head. The fire pumps being connected to the sprinkler system are immediately started and reinforce the water supply to the sprinklers.

**Fire Alarms.**—Of the alarms the one sold under the trade name Aero (Aero Automatic Fire Alarm Co., New York) should be noted. This consists of a small hollow tube extending around the moldings in the passageways, staterooms, and holds, the tube leading to a cabinet that contains a sensitive diaphragm and electric contacts.

The heat from a fire heats the air in the tube, causing expansion through its entire length, thus moving a diaphragm and closing an electric circuit that causes bells to ring, and furthermore shows by an indicator the room the fire is in. The alarm can be given in as many places as desired and connected by electric wires to a central station or fire headquarters that may be located convenient to the captain's and chief engineer's rooms.

## SECTION IX

### SHIP EQUIPMENT

**Steering Gear.**—The requirements of a steering gear are: (1) to move the rudder to any position with as little delay as possible; (2) to hold the rudder in position under the stresses imposed in maneuvering the ship; (3) to give way before any abnormal stress such as caused by a wave, and automatically to return to its former position; (4) to be absolutely reliable; and (5) to be economical. Savings of as much as 6% of the running distance of vessel per annum can be secured with the most sensitive steering gear. Steam, hydraulic, and electric power have been employed, steam more than any other.

Steam steering gears may be divided into two classes, viz., direct and indirect connected. In the former the engine is direct connected by gears to the rudder quadrant as in Fig. 104, the steam to the cylinders being controlled by a valve operated from the pilot house or bridge, the piston being direct connected to the tiller ropes and chains. In the indirect, which is more common, the rope or chain to the tiller or quadrant passes over a drum which is turned by a pair of steam cylinders having a controlling valve connected to the steering wheel in the pilot house. See also Arrangement and Transmission.

Usually eight turns of the steam steering wheel are required to put the rudder from hard over on one side to hard over on the other, and 24 turns on the hand wheel are required on some vessels and 16 on others.

For steamers 250 ft. in length Lloyd's rules state "that they are to be fitted with two independent steering gears, one of which must be a steam or other mechanical steering gear, and it is recommended that the two controlling wheels of the mechanical gear be placed one at the gear and the other one on the navigating bridge."

Steam steering gear using the follow-up system of control has been installed for many years on naval vessels. In this system, the arrangement of the valve gear is such as automatically to cut off the steam when the rudder has reached an angle corresponding to a position determined by the helmsman. In the follow-up control system as applied to electric steering gears there is a master

## STEAM STEERING ENGINES (STEAM ONLY TYPE)\*

(American Engineering Co.)

Cylinders Ins.	Length	Width	Height	Weight Lb.	Vessels Suitable for
3½ × 3½	3' 1¼"	3' 3½"	2' 5¼"	1,650	Tugs or yachts
4½ × 4½	3' 10¾"	3' 4¾"	2' 9¼"	1,850	Tugs or yachts
5 × 5½	4' 2½"	4' 0¾"	3' 3¼"	3,150	Steamers up to 1,500 tons
6 × 6	4' 7¾"	4' 2"	3' 5¾"	4,100	Steamers up to 2,500 tons
7 × 7	5' 7"	5' 0¼"	4' 2¼"	4,850	Steamers over 2,500 tons
8 × 7	5' 11"	5' 2"	4' 5½"	5,650	Steamers over 2,500 tons
10 × 8	.....	.....	.....	7,000	Steamers over 2,500 tons
12 × 8	.....	.....	.....	8,000	Steamers over 2,500 tons

\* Engines for combined steam and hand are the same size only they weigh about 800 lb. more in the large sizes. In both cases the weight of the engine and steering column is included in the weight given. All the engines have two steam cylinders. "Steam only" type means that the engines have neither steam nor hand wheels, being controlled from a distant standard.

controller located in the steering room and connected to the steering wheel by shafting and ropes, making it possible for the helmsman to set the steering gear at any desired angle as the motor will automatically accelerate and move the rudder to the predetermined angle at which the follow-up control will automatically stop the motor.

In the non-follow-up control with electric steering gears a master switch or switches are supplied, making it possible for the operator to start the motor by a small movement of the master switch from any desired station and shut the motor down as soon as the rudder has reached the desired angle. With this form of control it is necessary to have a helm angle-indicating device. The non-follow-up control is installed on many of the latest vessels of the U. S. Navy.

Electric steering gears\* may be divided into two classes: (1) the variable voltage and (2) contactor rheostatic. In the former the equipment consists of a rudder motor, motor generator, switchboard, steering stands, selective switch and limit switch. The speed of the motor is controlled by varying the field strength of the generator. There is no follow-up device. In (2) the equipment required consists of a steering motor, contactor controller with rheostats, limit switch, and any desired number of master steering controllers. U. S. battleships so equipped are the *Texas* and *New York*.

\* From Naval Electrician's Handbook. W. H. G. Bullard.

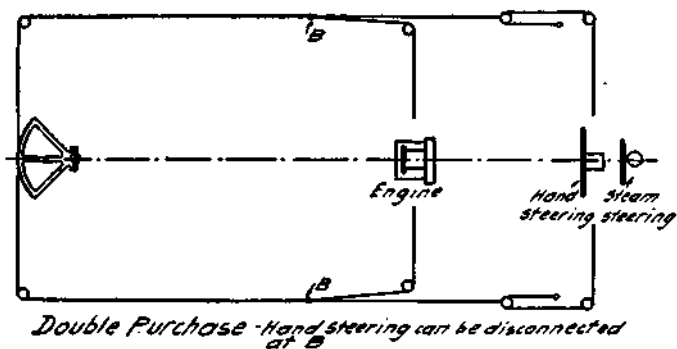
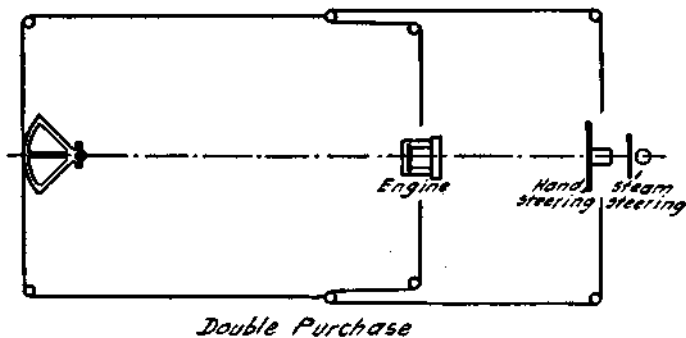
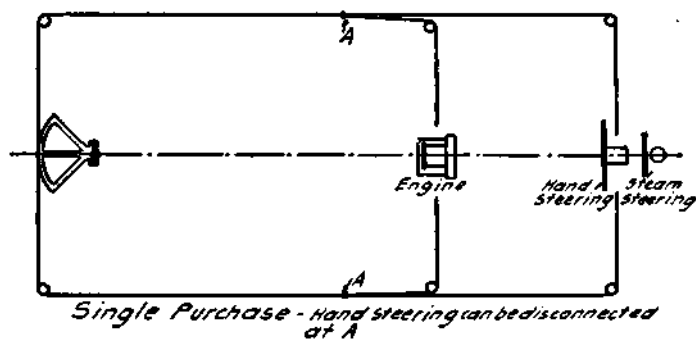

Figure 102.—Hand and Steam Steering Arrangements.



## INSTALLATIONS

Type of Vessel *	Length Between Perpendiculars, Feet	H. P. of Steering Engine
Tugs up to.....	80	5
Small screw passenger steamers up to....	100	5
Steam lighters and tugs.....	80-100	7
Steam lighters and tugs.....	100-140	10
Screw passenger steamers.....	180-210	15

\* Rated H. P. as installed by Dake Engine Co.

Length*	Speed, Knots	Diameter Rudder Stock, Inches	Size of Steering Engine Cylinders (2)	Name of Steamer	Owner
280	18½	7¾	6 × 8	Dover.....	London, Chatham & Dover Ry.
310	14	9¾	8 × 8	Moana.....	New Zealand Co.
360	13	9	7½ × 12	Queen Olga....	Russian Volunteer Fleet
400	13	10	7 × 8	Trieste.....	Austrian Lloyds
425	13	11	9 × 12	Tintagel Castle	Castle Line
480	14½	11	7½ × 12	Southwark....	American Line
552	18	15¾	7½ × 11	Korea.....	Pacific Mail
600	22	18	12 × 12	Lucania.....	Cunard

\* Steamers in this table have Brown's steam tiller and telemotor installed.

The distinguishing features of the contactor rheostatic control are: (a) direct application of power to the screw gear by a motor taking current direct from the ship's power mains; (b) steering by means of a master lever with steadying grip for the helmsman, the lever automatically returning to the off position if released when moved in either direction; (c) the elimination of the follow-up feature, the rudder starting promptly and continuing to move in the direction indicated by the master steering lever, until the lever is returned to the off position. The rudder is stopped almost instantaneously by a powerful dynamic brake and a magnetic disk brake on the armature shaft.

Among the advantages claimed for an electric steering gear are the reduction of the weight and space occupied by the driving mechanism, and the obtaining of a mechanism more efficient in its operation than steam.

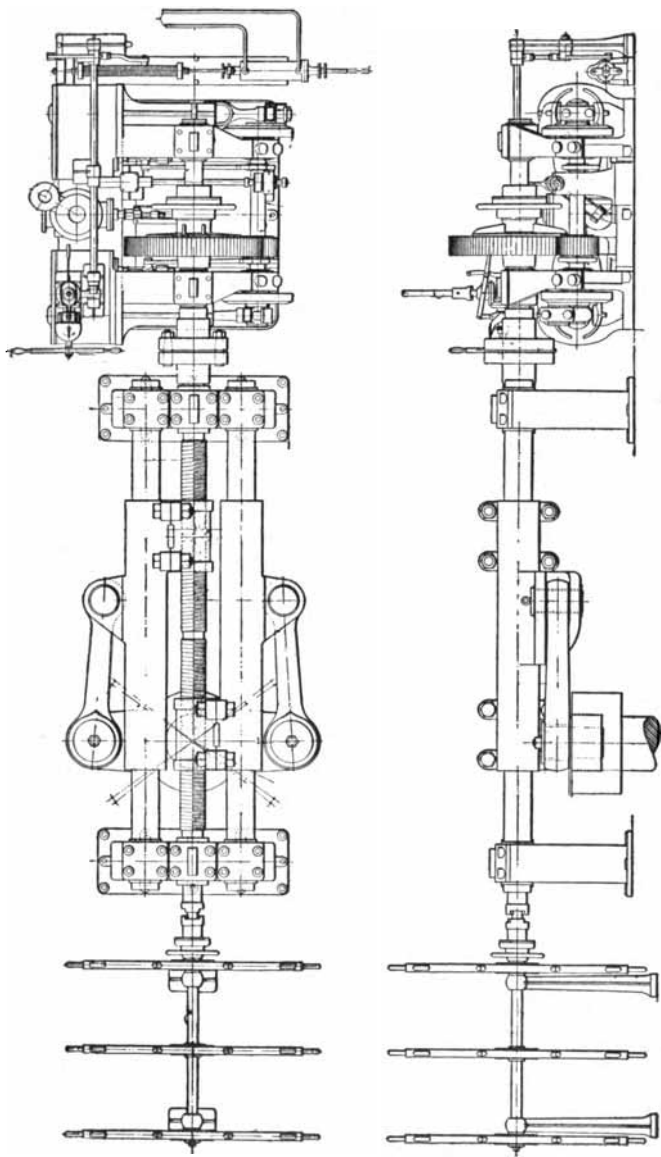

Figure 103.—Steering Engine with Screw Steering Gear. (Hyde Windlass Co., Bath, Me.)

**Arrangements.**—The steering engine may be in the pilot house with the steering wheel standard, or in the engine room with rope and rods from the standard to the throttle of the engine, or the engine may be in the compartment directly below, or in the compartment aft with the quadrant. When the relative position of the steering wheel and engine requires long transmission the steam-only type of engine with separate hand wheel is installed.

Tugs and harbor craft generally have the quadrant and the engine so connected that when the wheel in the pilot house is turned to port the rudder turns to starboard. In steamers, the connections are such, if the wheel is turned to port the rudder goes to port.

The Brown steam tiller (built by Hyde Windlass Co.), equipped with hydraulic telemotor transmission for controlling the engine valves from the pilot house and bridge, has been installed on many large steamers. It consists of two steam engines mounted on a movable tiller. The engines by means of a worm and wheel and friction clutch drive a pinion (which is connected to the clutch) along a toothed segment. At the other end of the tiller is another segment with teeth that mesh with a pinion fastened to the rudder stock. When a heavy sea strikes the rudder the clutch slips, allowing the rudder to move out of position, but by so doing the steam valve is opened and the engines bring the rudder back to its normal position.

One of the oldest direct connected types is the Napier screw. Here the rudder crosshead is operated by two links connected to a block actuated by a right and left hand screw. The screw may be operated from the engine by helical gears or by spur gears or by worm and wheel. The throttle of the engine is controlled from the standard in the pilot house.

Another arrangement is to have teeth on the rudder quadrant which mesh with pinions driven by a steam engine or an electric motor. A quadrant with springs may be used, the springs absorbing the shocks between the rudder and the engine. The Hyde Windlass Co. build their quadrant and gear type of steering engine with a friction clutch on the gear shaft similar to the one outlined above for the Brown steam tiller. See Fig. 104a.

In electric steering gears the master controller may be located in the pilot house, the motor being in the steering compartment aft.

**Transmission.**—Shafting and gears between the steering engine and the standard in the pilot house are undesirable owing to the settling and moving of the decks resulting in throwing the shafting

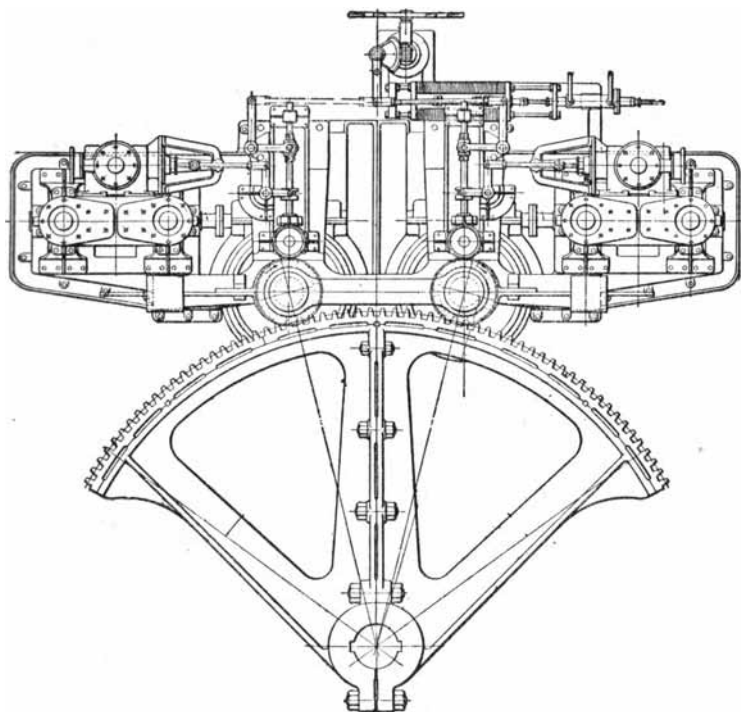

Figure 104a.—Plan of Steering Engine with Quadrant. Elevation shown on page 622. (Hyde Windlass Co., Bath, Me.)

out of line. A satisfactory transmission for long distances consists of a drum forward and another aft connected by a  $\frac{3}{8}$ -inch wire rope, provision being made for taking up the slack; by means of fair leads the rope can be run around obstructions and other places, which would be impossible with shafting.

When a clear runaway is available a sliding shaft transmission has been successfully employed. The shaft running fore and aft is supported on rollers and has a rack fitted at each end. These racks engage with pinions of which the forward one rotated by the wheel in the pilot house gives endwise motion to the shaft. The motion thus transmitted rotates the after pinion, thus controlling the opening of the steam valve by operating through suitable lever connections.

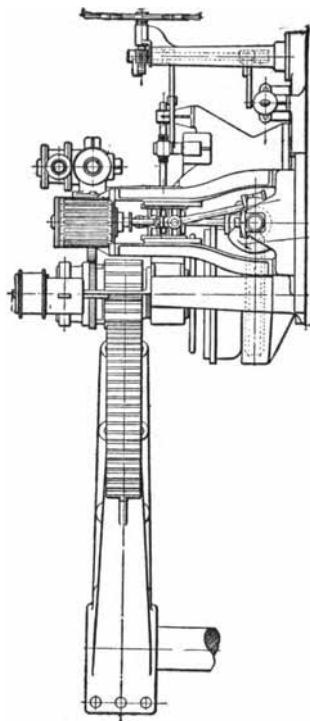

Figure 104b.—Elevation of Steering Engine Shown in Place on Page 621.

Another flexible transmission is the hydraulic telemotor, where the transmitting cylinder in the pilot house is connected with the controlling valve at the steering engine by copper pipe of small diameter. The whole system is charged with water and refined glycerine in equal parts, or with a special telemotor oil.

Some builders put a specially designed check valve at the engine for cutting off the steam when the engine is at rest.

In electric installations only small wires for conducting the current are required, thus making a very neat arrangement which is preferable to long steam lines.

**To Calculate the Power Required to Turn the Rudder of a Vessel.**

Let  $m$  = moment of pressure of water on rudder relative to its axis in foot-pounds

$A$  = area of rudder in square feet

$V$  = speed of boat in knots per hour

$d$  = distance of center of gravity of rudder surface from axis of rudder in feet

$C$  = constant = 2.8523

$\theta$  = angle rudder makes with center line of boat

Then  $m = A \times C \times V^2 \times d \times (\sin \theta)$

The above formula will give the strain on the rope and the resistance to be overcome by the steering engine.

When the steering engine is of the usual two-cylinder type with cranks at right angles the American Bureau of Shipping gives the formula

$$D^2 = \frac{p d^3 l n}{2,000}$$

Where  $p$  = steam pressure at steering engine in pounds

$d$  = diameter of cylinder in inches

$l$  = stroke of cylinder in inches

$n$  = number of revolutions of steering engine required to move helm from mid-position to hard over

$D$  = diameter of rudder head in inches

To find the force exerted by the man at the wheel, multiply the radius of the wheel by about 100 or 125 lb. Rudders in large steamers seldom turn beyond  $15^\circ$  on account of the power required to turn them.

**Pressure and Horse Power.**—The pressure on a rudder at right angles ( $90^\circ$ ) to the ship's direction is found from the formula,

$$1.12 \times \frac{11}{10} \text{ speed of ship in feet per second} \times \text{area of rudder.}$$

The correction for any angle of rudder is to multiply the pressure just given by the sine of the angle. This gives the pressure on the rudder in pounds, and to get it in tons divide by 2,240. Speed is in feet per second and the area in square feet. The pressure per square foot of rudder area increases as the square of the speed so that in comparing 22 and 18 knots the proportion of pressure for equal areas is  $\frac{22^2}{18^2} = \frac{484}{324} = 1.5$ , that is, an increase of 50%.

$$\text{Moment to be resisted} = \frac{3.1416 d^3}{16} \times \frac{\text{torsional strength of rudder stock}}{\text{factor of safety}}$$

where  $d$  = diameter of rudder stock.

The moment to be resisted determines the net horse power of the engine, as

1 unit of work = 1 foot-pound

1 horse power = 550 units per second, or 33,000 ft.-lb. per minute.

Then the net horse power required by the steering engine will be  $\frac{\text{moment to be resisted}}{550}$

If this equation is followed out it is found that the slower the rudder has to be turned the less is the power required and vice versa. To the net horse power must be added the power to overcome friction of tackle, gear, etc.

Rudders, see Structural Details.

**Steering Chain and Rod.**—The following formula is given by the American Bureau of Shipping,  $d = .4 \sqrt{\frac{D^3}{R}}$

Where  $d$  = diameter of chain in inches

$D$  = diameter of rudder head in inches

$R$  = radius of quadrant or length of tiller in inches

The diameter of the steering rods are one-quarter larger than the chain links as determined by the above rule.

**Windlasses** may be steam or electric driven, but generally steam. On large sizes the wildcats over which the anchor chain passes can be operated by power or by hand. The wildcats are independent and are set up close against the side bitts, with the compressors (sometimes called friction brake bands) next the bitts. The engines are usually reversible, which permits the anchor chains to be drawn from the lockers by power. When letting go an anchor its weight will take the chain from the locker, the wildcat being unlocked from the windlass shaft.

As to **methods of drive**, this may be by spur gears, worm and wheel, or by messenger chain. Among the advantages claimed by one builder in a compound spur-gear windlass are 54% greater chain speed than in the worm gear type, 14% excess pulling power at high speed, and smaller deck space and height. Messenger chains consisting of a sprocket wheel on the engine and another on the windlass shaft over which runs a chain are used only when the engine and windlass cannot be placed close together or as one unit.

**Chain stoppers** are fitted to relieve the strain on the wildcats when a vessel is riding at anchor. They should be placed high enough to cause the chain to rest hard on the bridge under the

pawl. As a guide for setting a stopper, draw a line from the bottom of the hawse pipe to a point 4 ins. above the bottom of the chain groove in the wildcat. Place wood chocks on this line and bolt them securely to the deck. Then fasten the chain stopper to the chocks.

Speed for lifting loaded cable should not exceed 25 ft. per minute.

Speed for lifting slack cable should not exceed 38 ft. per minute.

A windlass is sometimes combined with a capstan; that is, the windlass is on one deck and on the deck above is the capstan driven from the windlass shaft by means of bevel gears and a vertical shaft.

#### DIMENSIONS OF STEAM PUMP BRAKE WINDLASSES

Engines are vertical with two cylinders, drive windlass shaft by worm and gear, built by American Engineering Co.

Size of Chain Ins.	Diameter of Gypsy Head Ins.	Deck Space Ins.	Engine Ins.	Weight Lb.
$\frac{5}{8}$	5	39 × 52	4 × 4	1,850
$\frac{3}{4}$	6	45 × 62	4 × 4	2,550
$\frac{7}{8}$	6	52 × 74	5 × 5	4,200
1	8	57 × 72	5 × 5	5,250
$1\frac{1}{8}$	9	68 × 84	5 × 5	6,900
$1\frac{1}{4}$	10	70 × 87	5 × 7	8,400
$1\frac{3}{8}$	$11\frac{1}{2}$	70 × 89	6 × 8	9,000
$1\frac{1}{2}$	$11\frac{1}{2}$	77 × 103	7 × 8	13,000
$1\frac{5}{8}$	13	77 × 111	8 × 8	13,600
$1\frac{3}{4}$	15	81 × 113	9 × 9	17,500
$1\frac{7}{8}$	15	81 × 113	9 × 9	17,600
2	15	100 × 141	10 × 10	32,600
$2\frac{1}{8}$	18	100 × 141	10 × 10	33,100
$2\frac{1}{4}$	18	110 × 147	12 × 12	39,600

With electric operated windlasses the controller is so designed as to give several speeds in either direction and if there is a heavy overload the motor will automatically be slowed down; when the overload is removed the motor will accelerate to the speed desired by the operator. Powerful disk brakes are usually supplied with anchor windlass equipments. On some requiring large horse power there are two motors with one controller, and the controller is arranged so that the motors may be operated individually, in parallel or in series. With the latter connection, torque may be



obtained on the windlass equivalent to the torque of both motors, without using more current than is required by one motor.

Winches or hoisting engines are primarily for handling freight, although when fitted with a gypsy head they are employed for warping a vessel into a dock or alongside a pier. Steam deck winches may be either spur-gearred or friction-gearred; that is, the drum is driven by the engine by gears or by some kind of frictional device. The spur-gearred has three different methods of operation: (1) by means of a cone friction drum, (2) by link motion, and (3) by a positive clutch on the crank shaft.

In the first or cone friction type (as built by the American Engineering Co.), the cones are thrown out of contact and the drum which is loose on the shaft would be overhauled by the load except for a powerful adjustable strap brake which controls the drum and is operated by a foot lever. The drum can also be controlled, while lowering its load, by the cone friction arrangement. This, however, causes the cones to wear very rapidly, and necessitates frequent renewals. It is preferable, then, that the cone friction be used only for hoisting and that the brake be depended upon for lowering the load.

The second or link motion is for reversing winches when the load is lowered by reversing the engine, thus keeping the load at all times under the control of the engine. This type is often called a winding or an elevator winch. The link motion can also be used for ordinary hoisting, but the lowering is much slower than when lowering by gravity.

With the clutch winch, the drum and gear wheel are keyed fast

CONE FRICTION DECK WINCHES

Cylinder		Drum		Size of Bed Plate Ins.	Hoisting Capacity in Lb.	Weight Lb.
Dia. Ins.	Stroke Ins.	Dia. Ins.	Length Ins.			
5	5	8	16	36 × 32	1,200	1,800
6	6	10	18	48 × 38	2,000	2,500
7	7	12	24	50 × 47	3,000	3,700
8	8	15	24	66 × 48	4,000	4,200
10	10	18	30	69 × 56	6,000	6,000

Double-cylinder engines, single drum.

American Engineering Co., Philadelphia, Pa.

to the shaft, the former having a flange for a strap brake. The gear wheel is driven by a pinion clutched to the crank shaft. In hoisting, the load is raised to the desired height and the winch stopped. The strap brake is then applied to the drum and the clutch on the crank shaft thrown out of gear with the pinion. This puts the load, when being lowered, under the control of the strap brake.

Friction geared winches are designed for fast hoisting and quick operation. They are adapted for general cargo and wharf purposes and are faster than spur-gearred winches. The weight hoisted is thus less for a given size of engine but the speed is correspondingly greater.

FRICION GEARED HOISTING WINCHES

Cylinder		Drum		Size of Bed Plate Ins.	Hoisting Capacity in Lb.	Weight of Winch Lb.
Dia. Ins.	Stroke Ins.	Dia. Ins.	Length Ins.			
4	4	5	12	34 × 28	700	1,000
5	5	8	16	36 × 30	1,000	1,800
6	6	10	18	47 × 38	1,800	2,500
7	7	12	18	60 × 42	2,000	3,000
7	8	15	18	66 × 42	2,500	3,500
8	8	18	18	66 × 39	3,000	4,200
8	10	24	24	54 × 50	3,000	5,000
10	10	24	30	69 × 60	3,500	6,500

The winches have double cylinders, single drum.  
American Engineering Co., Philadelphia, Pa.

FRICION WINCHES

Horse Power	Weight Hoisted Single Line Lb.	Speed Feet per Minute	Size of Hoist Drums		Weight Lb.
			Diameter Ins.	Length of Body Between Flanges	
5	670	185	6	11½	800
7	1,045	166	8	15	1,200
10	1,510	164	9	17	1,950
15	2,290	162	10	22	2,600
20	3,300	150	12	21	3,300
30	5,591	133	14	20	4,000

The above winches have two drums each of the size given. The winches could be double-gearred, thus increasing the lifting capacity twice and decreasing the lifting speed to one-half the ratings given. (Dake Engine Co., Grand Haven, Mich.)

In electric driven winches the controller is placed near the winch or is attached to it. As the motor is commonly direct connected to the winch, it gives extremely smooth running. The controller may be of the full reverse type, in which case the motor is reversed by moving the handle of the controller to either side of the off position, or reversing may be obtained by means of an auxiliary reversing switch mounted in the same drum with the main operating cylinder of the controller.

## ELECTRIC WINCHES

Drums		Horse Power	Hoisting Speed Feet per Min.	Hoisting Capacity on One Line Lb.	Shipping Weight
Diameter Ins.	Length Ins.				
12	22	10	150	2,000	4,200
12	22	15	150	3,000	4,800
14	26	20	150	4,000	5,800
14	26	25	150	5,000	7,000
14	27	35	150	6,500	8,500
16	32	50	150	9,000	12,000

The above have two drums. (American Engineering Co., Philadelphia, Pa.)

## Horse Power Required to Raise a Load at a Given Speed.

$$H. p. = \frac{\text{Gross weight in lb.}}{33,000} \times \text{speed in feet per minute.}$$

To this add 25 to 40% for friction, contingencies, etc.

## ROPE CAPACITY OF A DRUM IN FEET

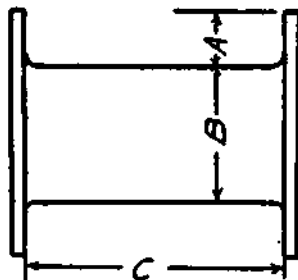

Figure 105.

Dimensions *A*, *B* and *C*, to be in inches

**Rule:**

Add the depth of flange *A* to diameter of drum *B*.

Multiply the sum by the depth of the flange *A*.

Multiply the result by the width *C* of the drum between the flanges.

Multiply product by figure in column opposite rope size.

*Example.*  $(A + B) \times A \times C \times \text{Multiplier}$ .

**MULTIPLIERS**

Ins.		Ins.	
$\frac{1}{4}$	4.16	$1\frac{3}{8}$	.138
$\frac{3}{8}$	1.86	$1\frac{1}{2}$	.116
$\frac{1}{2}$	1.37	$1\frac{5}{8}$	.099
$\frac{3}{4}$	1.05	$1\frac{3}{4}$	.085
$\frac{1}{2}$	.828	$1\frac{7}{8}$	.074
$\frac{5}{8}$	.672	2	.066
$\frac{3}{4}$	.465	$2\frac{1}{8}$	.058
$\frac{7}{8}$	.342	$2\frac{1}{4}$	.052
1	.262	$2\frac{3}{8}$	.046
$1\frac{1}{8}$	.207	$2\frac{1}{2}$	.042
$1\frac{1}{4}$	.167		

Increasing the diameter of the drum will give an increased speed of hoisting with constant revolutions of the engine or motor, but the size of the load hoisted will be decreased in the same ratio.

**Warping Winch.**—Here there are no drums but only gypsy heads which are for hoisting and hauling where it is not required to coil the hoisting rope on the drum.

**STEAM CAPSTANS**

Diameter		Height of Capstan Ins.	Double Cylinders Diameter and Stroke Ins.	Engine Deck Space Ins.	Circumference of Rope Ins.	Weight in Lb.
Of Barrel Over Whelps Ins.	Base Ins.					
8	21	$27\frac{1}{2}$	4 × 4	27 × 32	4	900
$8\frac{1}{2}$	$24\frac{1}{4}$	$31\frac{1}{2}$	4 × 6	38 × 42	$4\frac{1}{2}$	1,750
$9\frac{1}{2}$	$27\frac{1}{4}$	$33\frac{1}{2}$	4 × 6	38 × 42	5	1,950
$10\frac{1}{2}$	$29\frac{1}{4}$	37	5 × 7	44 × 51	6	2,900
$11\frac{1}{2}$	$31\frac{1}{4}$	37	6 × 8	50 × 60	$7\frac{1}{2}$	3,850
$12\frac{1}{2}$	33	43	7 × 8	53 × 61	$9\frac{1}{2}$	5,500
$15\frac{3}{4}$	42	40	8 × 8	57 × 66	11	5,800

Capstans on deck, engines below deck. (American Engineering Co., Philadelphia, Pa.)

Capstans and Gypsy Capstans are either steam or electric driven and are for warping a vessel alongside a dock. If a capstan is power driven, means are provided for disconnecting the motive power so that by inserting bars in the capstan head it can be turned by hand. When no provision is made for hand operating and no wildcat is fitted, it is called a gypsy capstan and may be operated by steam or electricity. Many tugboats have gypsy capstans for the quick handling of their tows.

Horse Power	Purchase on Line Fast Speed Lb.	Purchase on Line Slow Speed Lb.	Shipping Weight Lb.
5	5,890	17,670	1,100
7	6,790	20,380	1,550
10	11,000	33,000	2,370
15	12,300	37,120	2,600
20	19,400	58,230	2,950

Fast speed 10 h. p., 15 ft. per min.; slow, 5. (Dake Eng. Co., Grand Haven, Mich.)

In electric drives there may be a main contactor panel providing for automatic acceleration and stalling of the motor on heavy overloads. If desired, controllers may be furnished similar to those for electric winches.

#### ELECTRIC CAPSTANS

Diameter of Capstan Barrel Over Whelps Ins.	Worm or Bevel Gear	Height From Bottom of Bed Plate to Top of Capstan Head Ins.	Width of Bed Plate Ins.	Length of Bed Plate Ins.	Motors Horse Power	Pull in Lb.	Speed in Feet per Min.
10	Bevel	70	47½	97	30	5,300	150
						13,300	60
10	Bevel	52¼	47½	73	22	3,900	75
						8,500	30
13	Worm	61	40	74	30	5,940	90
						15,440	34
13	Worm	61	55	32½	22	3,000	92
						7,710	35
13	Worm	61	55	101½	30	3,762	100
						9,405	40

Capstan and motor on deck. (American Engineering Co., Philadelphia, Pa.)

**Towing Machines.**—In towing, either Manila or steel hawsers are used. The former are frequently 12 or more inches in circumference, are elastic and will stretch considerably before breaking, but they are heavy, bulky, and difficult to handle, particularly when frozen. Furthermore it is often not practicable to stow a Manila hawser on a drum, because of its bulk, hence it is coiled or stretched on deck when not in use.

A steel hawser is stronger than one of Manila of equal weight and can be stowed by winding it on a drum. However, it has little elasticity and will break under sudden and severe stresses. Thus steel hawsers should not be fastened to two rigid connections as from a bitt on a tug boat to a bitt on a barge, but instead on the tug should be a steam towing machine which supplies the elasticity the wire hawser lacks and permits the rapid shortening or lengthening of the towline when the tug and barge are under way.

Towing machines are steam operated, usually by two cylinders with cranks at right angles. The steam is admitted to the cylinders through an automatic valve that opens wide as the towline pays out under the stresses on it, and begins to close when the engine winds it in, stopping the engine when the towline has reached a predetermined length.

In the machines built by the American Engineering Co., the distinctive features are the combination of the elastic steam cushion

TOWING MACHINES  
(American Engineering Co.)

Diameter of Rope Ins.	Diameter and Length of Drum Ins.	Deck Space of Bed Plates Ins.	Size of Each Engine Ins.	Weight in Pounds
$\frac{1}{8}$	17 dia. $\times$ 18 long	45 $\times$ 63	7 $\times$ 7	4,400
1	19 dia. $\times$ 20 long	71 $\times$ 71	8 $\times$ 8	7,300
$1\frac{1}{4}$	21 dia. $\times$ 24 long	64 $\times$ 65	10 $\times$ 10	12,800
$1\frac{1}{2}$	25 dia. $\times$ 28 long	70 $\times$ 73	12 $\times$ 12	17,800
$1\frac{3}{4}$	28 dia. $\times$ 32 long	82 $\times$ 82	14 $\times$ 14	24,700
2	34 dia. $\times$ 40 long	83 $\times$ 90	16 $\times$ 16	37,800
$2\frac{1}{4}$	.....	.....	18 $\times$ 18	48,000
$2\frac{1}{2}$	.....	.....	20 $\times$ 20	62,000

The above machines include the winding attachment which for the small sizes averages about 200 lb. and for the large 700 lb. All the machines have two steam cylinders.

and the automatic relief to the hawser, without which the latter would be continually straining and frequently breaking. There is also installed an automatic guiding device that winds the hawser on the drum in even layers.

### ROPE

The following are trade terms:

**Yarn**, fibers twisted together.

**Strand**, two or more large yarns twisted together.

**Rope**, several strands twisted together.

**Hawser**, a rope of three strands.

**Shroud laid**, a rope of four strands.

**Cable**, three hawsers twisted together.

**Lay**, this means the direction or twist of the wires and strands composing a rope. A rope is right or left lay according to the direction in which the strands are laid. The regular lay of a wire rope is to have the wires in each strand twist in the opposite direction from the strands themselves. The term "Lang's lay" is given to a rope in which the wires of each strand and the strands themselves all twist in the same direction. The chief advantage of this lay is in the increased distribution of the surface wear due to the longitudinal direction of the wires.

The principal wear comes from badly set sheaves and excessive loads. If the rope wears on the outside and is good on the inside it shows that it has been injured in running over the pulley blocks or rubbing against some obstruction. If the blocks are very small the wear of the rope internally will be increased. The size of the rope selected should be larger than is needed to bear the strain from the load. Thus a rope twice as strong as needed for strength alone could be used until one-half its strength was worn away before it would be required to be renewed.

**Speeds.**—Slow, derrick and crane, 50 to 100 ft. per minute.

Medium, wharf and cargo, 150 to 300 ft.

Rapid, 400 to 600 ft.

Under ordinary conditions of hoisting coal from a vessel a rope hoists from 5,000 to 8,000 tons, and under favorable circumstances up to 12,000. Coal is usually hoisted with what is called a "double whip," that is, with a running block that is attached to the tub, which reduces the stress on the rope to one-half the weight of the load hoisted plus the friction losses. Hoisting ropes are not spliced,

as it is difficult to make a splice that will not pull out while running over sheaves. The following table gives the usual sizes of hoisting rope and the proper working load.

Diameter of Rope in Ins.	Economical Working Load on the Rope in Lb.	Nominal Size of Coal Tube, Double Whip, Tons
1 1/8	500	1/8 to 1/4
1 1/4	600	1/4 to 1/3
1 3/8	750	1/2 to 3/4
1 1/2	900	3/4 to 1
1 3/4	1,250	1 to 1 1/2

**Knots and Hitches.\***—See Fig. 106. The principle of a knot is that no two parts that would move in the same direction if the rope were to slip should lie alongside and touching each other. This principle is shown in the square knot I. A great number of knots have been devised, of which a few of the most useful are illustrated on page 635. In the cuts they are shown open, or before being drawn taut, in order to show the position of the parts. The names usually given to them are:

- |                                |                                |
|--------------------------------|--------------------------------|
| A. Bight of a rope             | P. Flemish loop                |
| B. Simple or overhand knot     | Q. Chain knot with toggle      |
| C. Figure 8 knot               | R. Half-hitch                  |
| D. Double knot                 | S. Timber hitch                |
| E. Boat knot                   | T. Clove hitch                 |
| F. Bowline, first step         | U. Rolling hitch               |
| G. Bowline, second step        | V. Timber hitch and half-hitch |
| H. Bowline completed           | W. Blackwall hitch             |
| I. Square or reef knot         | X. Fisherman's bend            |
| J. Sheet bend or weaver's knot | Y. Round turn and half-hitch   |
| K. Sheet bend with a toggle    | Z. Wall knot commenced         |
| L. Carrick bend                | AA. Wall knot completed        |
| M. Stevedore knot completed    | BB. Wall knot crown commenced  |
| O. Slip knot                   | CC. Wall knot crown completed  |

The bowline (H) is one of the most useful knots, as it will not slip and after being strained is easily untied. To tie it, begin by making a bight in the rope, then put the end through the bight and under the standing part as shown, then pass the end again through the bight, and haul tight.

Knots H, K, and M are easily untied after being under strain. The knot M is useful when the rope passes through an eye and is

\* From C. W. Hunt & Co., New York.



held by the knot, as it will not slip, and is easily untied after being strained.

A wall knot is made thus: Form a bight with strand 1 and pass strand 2 around the end of it, and strand 3 around the end of 2, and then through the bight of 1, as shown in Fig. Z. Haul the ends taut, as shown in AA. The end of the strand 1 is now laid over the center of the knot, strand 2 laid over 1, and 3 over 2, when the end of 3 is passed through the bight of 1 as in BB. Haul all the strands taut as in CC.

In the stevedore knot (M), N is used to hold the end of a rope from passing through a hole. When the rope is strained the knot draws up tight, but it can easily be untied when the strain is removed.

To Find the Tension in a Hoisting Rope, the Acceleration (or Hoisting Speed) Being Uniform.

Here  $W$  = weight to be lifted in pounds  
 $s$  = speed in feet per second  
 $g$  = acceleration due to gravity = 32.2 ft.  
 $t$  = times in seconds

Then the tension in the rope is  $\frac{2 \times W \times s}{g \times t} + W$

*Example.* A weight of 4,000 lb. is to be raised 100 ft. in 5 sec. Find the tension in the hoisting rope, the hoisting speed being constant.

$$\begin{aligned} \text{Tension} &= \frac{2 \times W \times s}{g \times t} + W = \frac{2 \times 4,000 \times 100}{32.2 \times 5^2} + 4,000 \\ &= 994 + 4,000 = 4,994 \text{ pounds.} \end{aligned}$$

**Kinds of Rope.**—Ropes for marine purposes are made of Manila, hemp, wire, and wire and hemp. Manila is obtained from the leaf stalks of the *musa textilis* or textile banana, found in the Philippine Islands. The fiber is strong and durable but not very flexible, and therefore is not so well adapted to the manufacture of small cordage as it is for mooring lines, towing hawsers, etc.

**Hemp** is from the fiber of a plant of the same name. The fiber is more flexible than Manila but is not so strong nor as durable. It decays quite rapidly when wet, and hence for marine purposes is tarred.

**Wire ropes** usually have a hemp center, the hemp forming a cushion around which are the strands. Rope with a wire center is about 10% heavier. The differences in construction are mainly dependent upon the number of strands, the number of wires in each strand, and their shape and arrangement.

Knots, Hitches, Bends

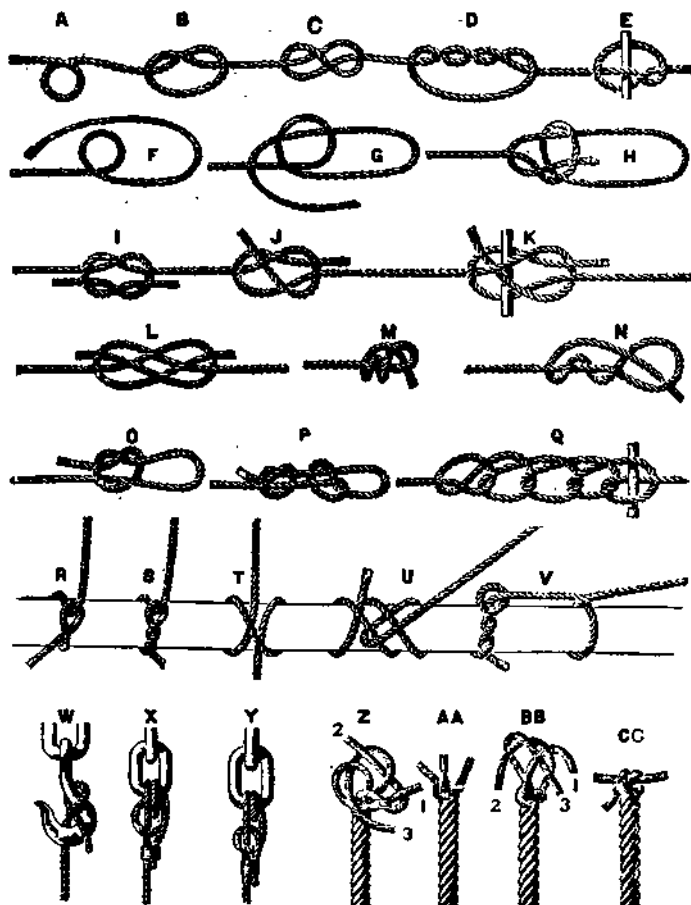

Copyright © C. W. Reed Company, New York.

Figure 106.

Digitized by Google

## APPROXIMATE WEIGHT AND STRENGTH OF PURE MANILA \*

Size in Circumference Inches	Size in Diameter Inches	Weight of 1,000 ft. in Lb.	Strain Borne by New Manila Rope	Length of Manila Rope in one pound
$\frac{3}{4}$	$\frac{1}{4}$	18.34	620	55 ft.
1	$\frac{1}{3}$	24.17	1,000	41 ft.
$1\frac{1}{8}$	$\frac{2}{8}$	36.67	1,275	27 ft.
$1\frac{1}{4}$	$\frac{1}{2}$	54.17	1,875	18 ft. 6 in.
$1\frac{1}{2}$	$\frac{3}{8}$	75.	2,400	13 ft. 4 in.
$1\frac{3}{4}$	$\frac{1}{2}$	104.17	3,300	9 ft. 7 in.
2	$\frac{5}{8}$	133.34	4,000	7 ft. 6 in.
$2\frac{1}{4}$	$\frac{3}{4}$	165.	4,700	6 ft. 1 in.
$2\frac{1}{2}$	$\frac{11}{8}$	195.	5,600	5 ft. 1 in.
$2\frac{3}{4}$	$\frac{7}{8}$	225.	6,500	4 ft. 5 in.
3	1	270.	7,500	3 ft. 8 in.
$3\frac{1}{4}$	$1\frac{1}{8}$	315.	8,900	3 ft. 2 in.
$3\frac{1}{2}$	$1\frac{1}{6}$	360.	10,500	2 ft. 9 in.
$3\frac{3}{4}$	$1\frac{1}{4}$	420.	12,500	2 ft. 5 in.
4	$1\frac{1}{3}$	480.	14,000	2 ft. 2 in.
$4\frac{1}{4}$	$1\frac{1}{6}$	540.	15,400	1 ft. 10 in.
$4\frac{1}{2}$	$1\frac{1}{2}$	600.	17,000	1 ft. 8 in.
$4\frac{3}{4}$	$1\frac{7}{8}$	675.	18,400	1 ft. 6 in.
5	$1\frac{5}{8}$	750.	20,000	1 ft. 4 in.
$5\frac{1}{2}$	$1\frac{3}{4}$	900.	25,000	1 ft. 1 in.
6	2	1080.	30,000	11 in.
$6\frac{1}{2}$	$2\frac{1}{8}$	1260.	33,000	9½ in.
7	$2\frac{1}{4}$	1470.	37,000	8 in.
$7\frac{1}{2}$	$2\frac{1}{2}$	1680.	43,000	7 in.
8	$2\frac{6}{8}$	1920.	50,000	6¼ in.
$8\frac{1}{2}$	$2\frac{7}{8}$	2158.34	56,000	5½ in.
9	3	2429.17	62,000	5 in.
$9\frac{1}{2}$	$3\frac{1}{8}$	2700.	68,000	4½ in.
10	$3\frac{1}{4}$	3000.	75,000	4 in.

\* Moon & Co.—Plymouth rope.

Hemp-clad wire rope consists of wire rope with the strands served or covered with tarred hemp marline, which prevents friction between the strands when the rope is in use and affords a protection against moisture. For marine use this rope has many advantages over Manila, as it is 3 to 5 times as strong when of equal size; thus for ropes of equal strength the hemp-clad is about  $\frac{1}{3}$  the size of a Manila rope, is 50% lighter than Manila rope of equal strength, and can be readily handled and coiled. Following is a table of sizes.

## HEMP-CLAD WIRE CABLE LAID HAWSER\*

Composed of Five Ropes, with Hemp Centers, Five Strands to the Rope, Seven Wires to the Strand

Diameter of Each Rope in Inches before Serving	Approximate Outside Diameter of Hawsers after Serving with Marline	Approximate Outside Circumference after Serving	Approximate Breaking Strain in Pounds	Approximate Weight per Foot in Pounds
--	--	---	---------------------------------------	---------------------------------------

## Crucible Cast Steel

$\frac{5}{8}$	$2\frac{5}{8}$	$8\frac{1}{4}$	103,000	3.80
$\frac{3}{4}$	$2\frac{7}{8}$	$7\frac{1}{4}$	80,000	3.20
$1\frac{1}{2}$	2	$6\frac{1}{4}$	60,000	2.59
$1\frac{3}{4}$	$1\frac{7}{8}$	6	50,000	2.30
$2\frac{1}{8}$	$1\frac{1}{2}$	$5\frac{3}{4}$	38,000	2.12

## Mild Plough Steel

$\frac{5}{8}$	$2\frac{5}{8}$	$8\frac{1}{4}$	115,000	3.80
$\frac{3}{4}$	$2\frac{7}{8}$	$7\frac{1}{4}$	92,000	3.20
$1\frac{1}{2}$	2	$6\frac{1}{4}$	67,000	2.59
$1\frac{3}{4}$	$1\frac{7}{8}$	6	56,000	2.30
$2\frac{1}{8}$	$1\frac{1}{2}$	$5\frac{3}{4}$	42,000	2.12

## Plough Steel

$\frac{5}{8}$	$2\frac{5}{8}$	$8\frac{1}{4}$	128,000	3.80
$\frac{3}{4}$	$2\frac{7}{8}$	$7\frac{1}{4}$	105,000	3.20
$1\frac{1}{2}$	2	$6\frac{1}{4}$	76,000	2.59
$1\frac{3}{4}$	$1\frac{7}{8}$	6	64,000	2.30
$2\frac{1}{8}$	$1\frac{1}{2}$	$5\frac{3}{4}$	48,000	2.12

\* Crescent rope, G. C. Moon & Co., New York.

Marline (tarred hemp) is for serving ropes and splices, cotton line for halliards of sailing yachts when a very soft rope is required, serving twine for whipping the ends of ropes.

In a flattened strand wire rope the construction is such that the outer wires conform to a circle, and instead of only one wire in each strand being exposed to contact there are from 2 to 6, depending upon the style of construction. This distribution of

wear minimizes the tendency to brittleness and lighter wire can be used, which results in extreme flexibility.

**FLATTENED STRAND HOISTING ROPE\***  
6 Strands of 25 Wires Each

Diameter in Inches	Approximate Breaking Strength in Tons of 2,000 lb.	Usual Working Load in Tons of 2,000 lb.	Approximate Weight per Foot	Advised Diameter of Drum or Sheave in Feet
$\frac{3}{8}$	7.4	1.5	.25	2
$\frac{1}{2}$	13.3	2.7	.45	2 7/8
$\frac{5}{8}$	16	3.2	.58	3
$\frac{3}{4}$	21	4.2	.72	3.50
$\frac{7}{8}$	29	5.8	1.00	4
1	39	7.8	1.38	4.50
1 1/8	50	10.0	1.80	5
1 1/4	62	12.4	2.30	6
1 1/2	76	15.2	2.80	7
1 3/4	92	18.4	3.45	7.50
1 7/8	108	21.6	4.00	8
2	121	24.2	4.75	8.50
2 1/4	146	29.2	5.60	9
2 1/2	183	36.6	7.25	11
2 3/4	231	46.2	9.20	12
3	289	58	11.2	14
3 1/4	317	63.5	12.5	15
3 1/2	345	69	13.8	16

\*Trade name, "Hercules," A. Leschen & Sons, St. Louis, Mo.

Round strand wire rope is composed of a number of wires twisted into a round strand, which are laid around a hemp or wire center. These strands usually consist of 6 or 8, which are in turn composed of 7, 9, 12, 19 or 37 wires, although other combinations may be selected. Rope of 6 strands with 19 wires in each strand is the number generally selected for the round strand (see table of Cast Steel Wire Rope). For ship's rigging, 7 strands and 12 wires.

Experience has shown that wear increases with speed, therefore true economy results from increasing the load within the safety limit and diminishing the speed.

For a working factor one-fifth of the ultimate strength of the rope is usually considered safe, although frequently a greater factor is required.

**FLATTENED STRAND CAST STEEL ROPE\***  
**Hoisting**  
**6 Strands of 25 Wires Each**

Diameter in Inches	Approximate Breaking Strength in Tons of 2,000 lb.	Usual Working Load in Tons of 2,000 lb.	Approximate Weight per Foot	Advised Diameter of Drum or Sheave in Feet
$\frac{3}{8}$	5.3	1.06	.25	1
$\frac{1}{2}$	9.3	1.86	.45	1.50
$\frac{5}{8}$	11	2.2	.58	1.75
$\frac{3}{4}$	13.8	2.76	.72	2.25
$\frac{7}{8}$	19.3	3.86	1.00	3
1	25	5.0	1.38	3.50
1	33	6.6	1.80	4
$1\frac{1}{8}$	42	8.4	2.30	4.50
$1\frac{1}{4}$	52	10.4	2.80	5.
$1\frac{3}{8}$	62	12.4	3.45	5.50
$1\frac{1}{2}$	70	14.0	4.00	5.75
$1\frac{5}{8}$	79	15.8	4.75	6.25
$1\frac{3}{4}$	94	18.8	5.60	7.25
2	117	23.4	7.25	8
$2\frac{1}{4}$	146	29.2	9.20	8.50
$2\frac{1}{2}$	187	37	11.2	10
$2\frac{5}{8}$	210	42	12.5	11
$2\frac{3}{4}$	232	46	13.8	12

\* A cheaper grade than Hercules.

Wire rope must not be coiled or uncoiled like hemp rope. When not on a reel, roll on the ground like a wheel or hoop to prevent kinking.

Cast steel wire rope is standard for ordinary work, being of moderately high tensile strength and quite flexible. It works to good advantage over small sheaves or drums, but the greater the diameter of the sheaves and drums the longer the rope will last. The grooves should be slightly larger than the rope so that the rope will not bind.

Plough steel wire rope gets its name from a quality of steel originally used in ploughing, requiring a rope that could be dragged over stones and rough ground without abrasion. The tensile strength is high and this rope gives good service where heavy work is done and where large drums and sheaves are practicable.

Iron rope is much more pliable, is softer, and of a lower tensile

## APPROXIMATE COMPARISON OF STRENGTH\*

Manila Rope			Crescent Hemp-Clad Wire Rope— Diameter			
Circumference	Diameter	Approximate Breaking Strain	Iron	Crucible Steel	Extra Strong Crucible Steel	Plough Steel
1¾	$\frac{3}{8}$	2,250	$\frac{1}{4}$	...	...	...
2	$\frac{5}{8}$	3,000	...	...	...	...
2¼	$\frac{3}{4}$	4,000	$\frac{3}{8}$	$\frac{1}{4}$	...	...
2½	$\frac{7}{8}$	5,000	...	...	$\frac{1}{4}$	...
2¾	$\frac{1}{8}$	5,800	...	$\frac{1}{8}$	...	$\frac{1}{4}$
3	1	7,000	...	...	$\frac{1}{8}$	...
3¼	$1\frac{1}{8}$	8,000	$\frac{1}{2}$	...	...	$\frac{5}{8}$
3½	$1\frac{1}{8}$	9,200	...	$\frac{5}{8}$	...	...
3¾	$1\frac{1}{4}$	11,000	...	...	$\frac{3}{8}$	...
4	$1\frac{1}{4}$	12,000	$\frac{5}{8}$	...	...	$\frac{3}{8}$
4¼	$1\frac{1}{2}$	13,500	...	$\frac{1}{8}$	...	...
4½	$1\frac{1}{2}$	15,500	...	...	$\frac{1}{8}$	...
4¾	$1\frac{3}{4}$	17,000	$\frac{3}{4}$	$\frac{1}{2}$	...	$\frac{1}{4}$
5	$1\frac{5}{8}$	19,000	...	$\frac{1}{4}$	$\frac{1}{2}$	...
5½	$1\frac{3}{4}$	23,500	$\frac{7}{8}$	...	$\frac{1}{8}$	$\frac{1}{2}$
6	2	27,000	...	$\frac{5}{8}$	...	...
6½	$2\frac{1}{8}$	31,500	1	...	$\frac{5}{8}$	$\frac{5}{8}$
7	$2\frac{1}{4}$	37,000	$1\frac{1}{8}$	$\frac{3}{4}$	...	...
7½	$2\frac{1}{2}$	42,000	...	...	$\frac{3}{4}$	...
8	$2\frac{5}{8}$	48,000	$1\frac{1}{4}$	$\frac{7}{8}$	...	$\frac{3}{4}$
8½	$2\frac{7}{8}$	54,000	...	...	$\frac{7}{8}$	...
9	3	61,000	$1\frac{3}{8}$	1	...	$\frac{7}{8}$
9½	$3\frac{1}{8}$	67,000	$1\frac{1}{2}$	...	1	...
10	$3\frac{3}{8}$	75,000	...	$1\frac{1}{8}$	...	1

\* G. C. Moon &amp; Co., New York.

strength than steel. It is used principally on elevators and sometimes in the transmission of power.

Tiller rope is made of a large number of small, fine bronze wires and is the most pliable wire rope manufactured.

For protection against the action of salt air and the weather, the wires in the ropes are frequently galvanized, as for guys, hawsers, and ships' rigging.

How to Measure Wire Rope.—It is always understood that the diameter of a wire rope is that of a circle inclosing the rope. Care should be taken, in measuring, to obtain this diameter. See Fig. 107.

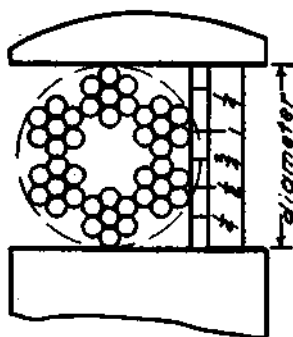

Figure 107.—Method of Measuring Wire Rope.

## CAST STEEL WIRE ROPE

Six strands, 19 wires each, around a hemp center hoisting rope,  
round strand

Diameter Ins.	Circum- ference Ins.	Approximate Weight per Foot	Approximate Strength in Tons of 2,000 lb.	Proper Working Load in Tons of 2,000 lb.	Advised Diameter of Drum or Sheave in Feet
$\frac{1}{4}$	$\frac{3}{4}$	.10	2.2	.44	1.
$\frac{5}{16}$	1	.15	3.1	.62	1.25
$\frac{3}{8}$	$1\frac{1}{8}$	.22	4.8	.96	1.50
$\frac{7}{16}$	$1\frac{1}{4}$	.30	6.5	1.30	1.75
$\frac{1}{2}$	$1\frac{1}{2}$	.39	8.4	1.68	2.
$\frac{9}{16}$	$1\frac{3}{4}$	.50	10.	2.	2.25
$\frac{5}{8}$	2	.62	12.5	2.5	2.5
$\frac{3}{4}$	$2\frac{1}{4}$	.89	17.5	3.5	3.
$\frac{7}{8}$	$2\frac{3}{4}$	1.20	23.	4.6	3.5
1	3	1.58	30.	6.	4.
$1\frac{1}{8}$	$3\frac{1}{2}$	2.	38.	7.6	4.5
$1\frac{1}{4}$	4	2.45	47.	9.4	5.
$1\frac{3}{8}$	$4\frac{1}{4}$	3.	56.	11.2	5.5
$1\frac{1}{2}$	$4\frac{3}{4}$	3.55	64.	12.8	6.
$1\frac{5}{8}$	5	4.15	72.	14.4	6.5
$1\frac{3}{4}$	$5\frac{1}{2}$	4.85	85.	17.	7.
$1\frac{7}{8}$	$5\frac{3}{4}$	5.55	96.	19.	8.
2	$6\frac{1}{4}$	6.30	106	21.2	8.
$2\frac{1}{4}$	$7\frac{1}{8}$	8.	133.	26.6	9.
$2\frac{1}{2}$	$7\frac{3}{8}$	9.85	170.	34.	10.
$2\frac{3}{4}$	$8\frac{5}{8}$	11.95	211.	42.2	11.



## GALVANIZED STEEL MOORING LINES \*

Composed of 6 Strands and a Hemp Center, each Strand composed of 24 Wires around a Hemp Core

Diameter in Inches	Approximate Circumference in Inches	Approximate Weight per Foot	Approximate Strength in Tons of 2,000 lb.
2 1/8	6 1/2	5.81	113
2	6 1/4	5.51	106
1 7/8	6	5.09	98
1 7/8	5 3/4	4.48	88
1 3/4	5 1/2	4.24	82
1 7/8	5 1/4	3.86	76
1 5/8	5	3.63	74
1 1/2	4 3/4	3.10	63
1 7/8	4 1/2	2.92	55
1 3/8	4 1/4	2.62	50
1 1/4	4	2.15	42
1 1/8	3 3/4	1.93	38
1 1/8	3 1/2	1.75	34
1 1/8	3 1/4	1.54	27
1	3	1.38	25
7/8	2 3/4	1.05	20
7/8	2 1/2	.90	17
3/4	2 1/4	.78	14

\* J. Roebling & Sons, New York.

## Formulas for Size and Weight of Rope.\*

Let  $c$  = circumference in inches

$d$  = diameter in inches

Weight in pounds per fathom of flexible wire rope =  $.8 \times c^2$

Weight in pounds per fathom of hemp rope =  $\frac{c^2}{5}$

Weight in cwt. per 100 fathoms of chain cable =  $d^2 \times 50$

Approximate strength of a hemp hawser in tons =  $\frac{d^2}{5}$

(1) To find the safe working load for a rope (hemp or Manila), square the circumference in inches and divide by 7 for the load in tons.

(2) To find the size of rope for a given load. Multiply the load

\* Modern Seamanship. A. M. Knight.

GALVANIZED CAST STEEL YACHT-RIGGING AND GUY ROPES \*  
 Composed of 6 Strands and a Hemp Center, either 7 or 19 Wires  
 to the Strand

Diameter in Inches	Approximate Circumference in Inches	Approximate Weight per Foot	Approximate Strength in Tons of 2,000 lb.	Circumference of Equal Strength Manila Rope
1 1/4	4	2.45	42	13
1 1/8	3 3/4	2.21	38	12
1 1/8	3 1/2	2	34	11
1 1/8	3 1/4	1.77	31	10
1	3	1.58	28	9
7/8	2 3/4	1.20	22	8 1/2
3/4	2 1/2	1.03	19	8
3/4	2 1/4	.89	16.8	7
5/8	2	.62	11.7	6
7/8	1 3/4	.50	9	5 1/4
1/2	1 1/2	.39	7	4 3/4
1/2	1 3/8	.34	6	4 1/2
1/2	1 1/4	.30	5	4 1/4
1/2	1 1/8	.22	4.2	3 3/8
1/2	1	.15	3.2	3

\* J. Roebling & Sons, New York.

in tons by 7 and take the square root of the product for the circumference of the rope in inches.

(3) To find the size of rope when reeved as tackle to lift a weight. Add to the weight one-tenth of its value for every sheave to be used in hoisting. This gives the total resistance, including friction. Divide this by the number of parts at the movable block for the maximum tension on the fall. Reeve the fall of a size to stand this tension as a safe working load.

(4) To find the weight which a given purchase will lift with safety. Find the safe working load for the rope to be used (Rule 1). Multiply this by the number of parts at the movable block, thus giving the total resistance including friction. Multiply the total resistance by 10 and divide by 10 plus the number of sheaves used. The result is the weight that may be lifted.

(5) For the safe working load of wire rope take one-sixth of the breaking strain as given by the manufacturer.

*Examples.* Find the size of fall needed to lift 10 tons with a three-fold purchase, the fall of which coming from the upper block is taken through an extra sheave on the deck for a fair lead.

## GALVANIZED STEEL HAWSERS \*

Composed of 6 Strands and a Hemp Center, 37 Wires to the Strand

Diameter in Inches	Approximate Circumference in Inches	Approximate Weight per Foot	Approximate Strength in Tons of 2,000 lb.
$2\frac{3}{8}$	$7\frac{1}{2}$	8.82	188
$2\frac{1}{8}$	$7\frac{1}{4}$	8.36	182
$2\frac{1}{4}$	$7\frac{1}{8}$	8	171
$2\frac{1}{8}$	$6\frac{3}{4}$	7.06	155
$2\frac{1}{8}$	$6\frac{1}{2}$	6.65	140
2	$6\frac{1}{4}$	6.30	132
$1\frac{11}{8}$	6	5.84	125
$1\frac{11}{8}$	$5\frac{3}{4}$	5.13	112
$1\frac{3}{4}$	$5\frac{1}{2}$	4.85	104
$1\frac{11}{8}$	$5\frac{1}{4}$	4.42	97
$1\frac{5}{8}$	5	4.15	87
$1\frac{1}{2}$	$4\frac{3}{4}$	3.55	76
$1\frac{1}{8}$	$4\frac{1}{2}$	3.24	72
$1\frac{3}{8}$	$4\frac{1}{4}$	3	66
$1\frac{1}{4}$	4	2.45	54
$1\frac{1}{8}$	$3\frac{3}{4}$	2.21	47
$1\frac{1}{8}$	$3\frac{1}{2}$	2	42
$1\frac{1}{8}$	$3\frac{1}{4}$	1.77	38
1	3	1.58	31.5
$\frac{7}{8}$	$2\frac{3}{4}$	1.20	26
$\frac{11}{16}$	$2\frac{1}{2}$	1.03	22
$\frac{3}{4}$	$2\frac{1}{4}$	.89	20

\* J. Roebling &amp; Sons, New York.

$$\text{Total resistance including friction} = 10 + \frac{7 \times 10}{10} = 17 \text{ tons}$$

$$\text{Maximum tension on fall} = \frac{17}{6} = 2.8 \text{ tons}$$

$$\text{Size of fall (Rule 2)} = \sqrt{7 \times 2.8} = 4.4 \text{ inches}$$

What weight can be lifted by a fall of  $4\frac{1}{2}$ -inch Manila rope reeved as a three-fold purchase, the fall of which leads from the upper block through an extra leader on the deck.

$$\text{(Rule 1) Safe working load} = \frac{4.5^3}{7} = 2.9 \text{ tons}$$

$$\text{Total resistance including friction} = 6 \times 2.9 = 17.4 \text{ tons}$$

$$\text{(Rule 4) Weight to be lifted} = \frac{17.4 \times 10}{10 + 7} = \frac{174}{17} = 10.2 \text{ tons}$$

**GALVANIZED SHIPS' RIGGING AND GUY ROPES\***  
 Composed of 6 Strands and a Hemp Center, 7 or 12 Wires to the Strand

Diameter in Inches	Approximate Circumference in Inches	Approximate Weight per Foot	Approximate Strength in Tons of 2,000 lb.	Circumference of Equal Strength Manila Rope
1 3/4	5 1/2	4.85	42	11
1 11/16	5 1/4	4.42	38	10 1/2
1 5/8	5	4.15	35	10
1 1/2	4 3/4	3.55	30	9 1/2
1 1/16	4 1/2	3.24	28	9
1 3/8	4 1/4	3	26	8 1/2
1 1/4	4	2.45	23	8
1 1/8	3 3/4	2.21	19	7 1/2
1 1/8	3 1/2	2	18	6 1/2
1 1/16	3 1/4	1.77	16.1	6
1	3	1.58	14.1	5 3/4
7/8	2 3/4	1.20	11.1	5 1/4
11/16	2 1/2	1.03	9.4	5
3/4	2 1/4	.89	7.8	4 3/4
5/8	2	.62	5.7	4 1/2
7/16	1 3/4	.50	4.46	3 3/4
1/2	1 1/2	.39	3.39	3
1/16	1 1/4	.30	2.35	2 1/2
3/8	1 1/8	.22	1.95	2 1/4
5/16	1	.15	1.42	2
3/16	7/8	.125	1.20	1 3/4
1/4	3/4	.09	.99	1 1/2
1/16	5/8	.063	.79	1 1/4
3/16	1/2	.04	.61	1 1/8

\* J. Roebling & Sons, New York.

### BLOCKS

The swallow of a block is the space through which the rope passes. The side pieces of the frame are the cheeks, and the end of the block opposite the swallow the breech.

The size of a block is measured by the length of the shell and the length of the shell is determined by the size of rope to be reeved through it. For ordinary purposes three times the size of the rope to be reeved gives the size of the block. Where it is important to minimize friction, as in boat falls, 3 1/2 x the size of the rope gives the size of block.

## GALVANIZED STEEL HAWERS\*

Composed of 6 Strands and a Hemp Center, each Strand consisting of 12 Wires and a Hemp Core

Diameter in Inches	Approximate Circumference in Inches	Approximate Weight per Foot	Approximate Strength in Tons of 2,000 lb.	Size of Manila Hawers of Equal Strength
2 $\frac{1}{8}$	6 $\frac{1}{2}$	4.43	83	....
2	6 $\frac{1}{4}$	4.20	77	....
1 $\frac{11}{8}$	6	3.89	71	....
1 $\frac{7}{8}$	5 $\frac{3}{4}$	3.42	66	....
1 $\frac{3}{4}$	5 $\frac{1}{2}$	3.23	61	13.5
1 $\frac{11}{8}$	5 $\frac{1}{4}$	2.94	57	13
1 $\frac{5}{8}$	5	2.76	53	12.5
1 $\frac{1}{2}$	4 $\frac{3}{4}$	2.36	45	12
1 $\frac{1}{8}$	4 $\frac{1}{2}$	2.16	41	11.5
1 $\frac{3}{8}$	4 $\frac{1}{4}$	2	38	11
1 $\frac{1}{4}$	4	1.63	31	10
1 $\frac{1}{8}$	3 $\frac{3}{4}$	1.47	28	9.25
1 $\frac{1}{8}$	3 $\frac{1}{2}$	1.33	26	8.75

\* J. Roebling & Sons, New York.

## LENGTH OF ROPE REQUIRED FOR SPLICES

Circumference of Rope Inches	Allowance for Iron Wire Rope Inches	Allowance for Steel Wire Rope Inches	Manila
1	9	12	} An average allowance of 15 inches
1 $\frac{1}{2}$	12	18	
2	15	21	
2 $\frac{1}{2}$	18	24	
3	20	30	
3 $\frac{1}{2}$	22	33	} 18 inches or over
4	24	36	
4 $\frac{1}{2}$	27	39	
5	30	42	
6	35	48	
7	40	54	

Snatch blocks are single metal or iron-bound wooden blocks, with the shell cut away immediately over the swallow so that a rope can be lifted in and out of the block without reeving its end through first. The iron strap over the swallow has a hinged flap which is clamped and pinned when not in use.

Swivel blocks are metal or iron-bound blocks supported by a swivel so they can turn in any direction.

Gin blocks have metal pulleys in metal frames.

Cat and fish blocks are heavy double or treble blocks with large open hooks for catting and fishing for an anchor.

Blocks with different connections are shown in Fig. 108.

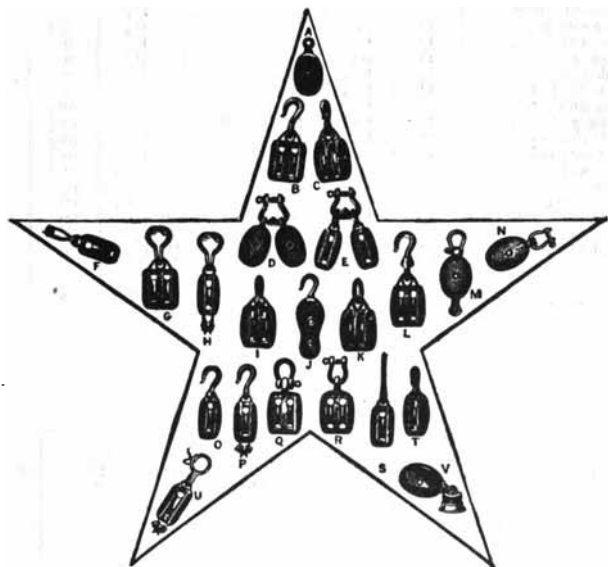

Figures 108.—Types of Blocks. (Boston & Lockport Co., Boston.)

- |                                    |                             |
|------------------------------------|-----------------------------|
| A Solid eye                        | L Loose swivel hook         |
| B Loose hook                       | M Regular shackle           |
| C Loose front hook                 | N Upset shackle             |
| D Jib sheet blocks to side         | O Stiff swivel hook         |
| E Jib sheet blocks fore and aft    | P Loose side hook           |
| F Span and bridle block attachment | Q Reverse shackle           |
| G Side sister hook double block    | R Reverse upset shackle     |
| H Side sister hook single block    | S Deck leader, bolt and nut |
| I Regular shackle                  | T Stiff front hook          |
| J Fiddle block                     | U Coleman hook              |
| K Ring, front or side              | V Deck leader               |

## WOOD BLOCKS FOR MANILA ROPE

Type of Block	Nominal Size Inches	Width of Shell Inches	Thickness of Block Inches	Capacity Tons	Size of Rope Inches (Diameter)	Outside Diameter of Sheave	Weight of Block
Single with hook.....	8	5½	4½	2	¾	4½	15
Double with hook.....	8	5½	6¾	4	¾	4½	20
Single with hook.....	12	8½	5½	5	1¼	7½	45
Double with hook.....	12	8½	8¾	7	1¼	7½	70
Triple with hook.....	12	8½	11½	8	1¼	7½	95
Single with hook.....	14	10½	6	6	1½	9	70
Double with hook.....	14	10½	8¾	10	1½	9	115
Triple with hook.....	14	10½	13¼	12	1½	9	150
Quadruple with shackle.	14	10½	18¾	14	1½	9	190
Single with hook.....	16	11½	6½	8	1½	10¼	90
Double with hook.....	16	11½	10½	12	1½	10¼	140
Triple with hook.....	16	11½	13¾	15	1½	10¼	190
Quadruple with shackle.	16	11½	17¾	20	1½	10¼	270
Single with hook.....	20	14	8½	15	2 or 2¼	12½	170
Double with hook.....	20	14	12¾	22	2 or 2¼	12½	230
Triple with hook.....	20	14	17¼	30	2 or 2¼	12½	360
Quadruple with hook...	20	14	21¾	35	2 or 2¼	12½	430
Snatch block.....	20	8½	5	5	1½-1¾-1½	8	50
Snatch block.....	20	9½	6½	5	1½-1¾-2-2¼	9	95

American Bridge Co., New York.

## STEEL BLOCKS FOR WIRE ROPE

Type of Block	Width of Shell	Thickness of Block	Capacity Tons	Size of Rope (Diam.)	Outside Diam. Sheave	Weight
Snatch block with hook	17	7¾	8	¾ & ¾	14	260
Single block with shackle	21	6	10	¾	14	250
Double block with shackle.....	21	8¾	20	¾	14	390
Triple block with shackle	21	11¾	30	¾	14	590
Quadruple block with shackle.....	21	14¾	40	¾	14	820
Six sheave block with shackle.....	21	20¾	60	¾	14	1,260

American Bridge Co., New York.

## SUITABLE WORKING LOAD FOR BLOCKS

A suitable working load is not the greatest load a pair of blocks will sustain, but a load with which such blocks may be used until worn out. For heavy lifts shackles should be used wherever possible.

## REGULAR BLOCKS—WITH LOOSE HOOKS

Size Inches	Diameter Rope Inches	2 Singles Pounds	2 Doubles Pounds	2 Triples Pounds
5	$\frac{1}{8}$	150	250	400
6	$\frac{3}{4}$	250	400	650
8	$\frac{1}{8}$	700	1,200	1,900
10	1	2,000	4,000	6,000
12	$1\frac{1}{8}$	4,000	8,000	12,000
14	$1\frac{1}{4}$	7,000	12,000	19,000

## EXTRA HEAVY—WITH SHACKLES

Size Inches	Diameter Rope Inches	2 Doubles Tons	2 Triples Tons	2 Fourfolds Tons
18	2	25	30	40
20	$2\frac{1}{4}$	30	35	45
22	$2\frac{1}{2}$	35	40	55
24	3	40	50	70

## WIDE MORTISE—WITH LOOSE HOOKS

Size Inches	Diameter Rope Inches	2 Singles Tons	2 Doubles Tons	2 Triples Tons
8	1	$\frac{1}{2}$	1	2
10	$1\frac{1}{4}$	2	3	4
12	$1\frac{1}{2}$	4	6	8
14	$1\frac{3}{8}$	6	8	10
16	$1\frac{3}{4}$	10	12	14

## WIRE ROPE BLOCKS—LOOSE HOOKS

Size Diameter of Sheave Inches	2 Singles Tons	2 Doubles Tons	2 Triples Tons
8	3	4	5
10	4	5	6
12	5	6	7
14	6	7	8
16	7	8	10
18	8	10	12



## WIRE ROPE BLOCKS—WITH SHACKLES

Size Diameter of Sheave Inches	2 Singles Tons	2 Doubles Tons	2 Triples Tons	2 Fourfolds Tons
8	4	5	6	8
10	6	8	10	12
12	8	10	12	15
14	10	12	15	20
16	12	15	20	25
18	15	20	25	28
20	20	25	30	30
22	25	30	35	40
24	30	35	40	50

Boston & Lockport Block Co., Boston, Mass.

## TACKLES

A combination of ropes and blocks for the purpose of multiplying power constitutes a tackle. Tackles in common use are shown in Figs. 109 and 110.

**Single whip.** A single fixed block. No power gained.

**Double whip.** Two single blocks. Power gained double.

**Runner.** A single movable block. Power gained double.

**Runner and tackle.** Two single and one double block. Power gained eight times.

**Gun tackle.** Two double blocks.

**Luff tackle.** A single and a double block, sometimes called a watch tackle. Power gained three to four times depending on which is the movable block.

**Spanish burton.** Two single blocks, one fixed and the other movable. Power gained three times.

**Jiggers.** Light tackles for miscellaneous work. Generally a double block with a tail and a single block with a hook.

**Twofold purchase.** Two double blocks.

**Threefold purchase.** Two treble blocks. This is about the heaviest tackle used. Power gained six to seven times.

**Deck tackle.** Usually a twofold purchase used for heavy work on deck.

Let  $W$  = weight to be raised  
 $P$  = pull or force exerted

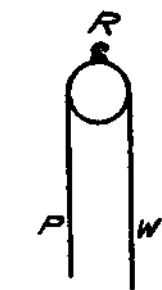

*Single Whip*



*Runner*

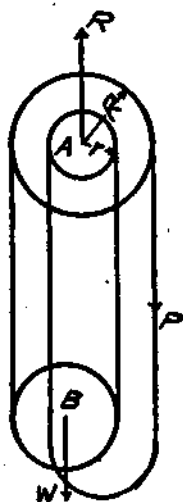

*Differential Pulley*

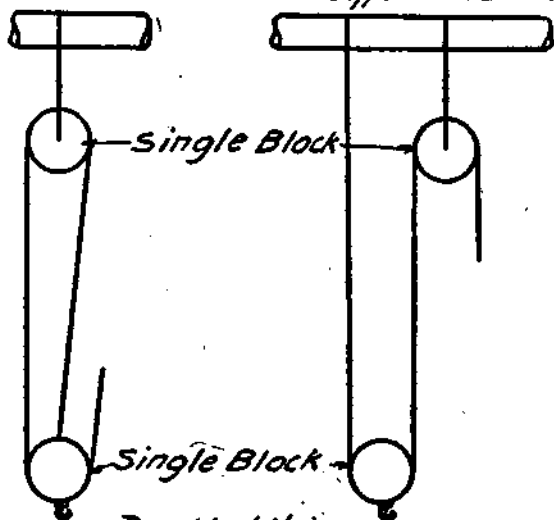

*Double Whip*

Figure 109.

**Single Fixed Pulley.** (See Fig. 109.) Used like a single whip for raising light weights. The pulley is suspended at  $R$ .

$$P = W$$

$$R = P + W = 2P$$

$$\text{Velocity of } W = \text{velocity of } P$$

**Single Movable Pulley.** (See Fig. 109.) Tacks and sheets on light sails are examples of this form of purchase. One end of the rope around the pulley is fastened to  $D$ .

$$W = 2P$$

$$R = P = \frac{W}{2}$$

$$\text{Velocity of } W = \frac{1}{2} \text{ velocity of } P$$

**Luff Tackle.** (See Fig. 110.) This consists of two sheaves at  $A$  and one at  $B$ . The rope is led from  $B$  up around one of the sheaves,  $A$ , then down around the sheave  $B$  and up over the other sheave  $A$  to  $P$  where the power is applied.

$$W = 3P$$

$$R = 4P$$

If upper block is fixed then velocity of  $W = \frac{1}{3}$  velocity of  $P$   
 If lower block is fixed then velocity of  $R = \frac{1}{4}$  velocity of  $P$

To obtain the greatest advantage with this purchase the lower block  $B$  should be the fixed block.

In a pair of blocks, as in a luff tackle, with any number of sheaves in either block,

$\frac{W}{P}$  = total number of ropes at the lower block passing through and attached

$\frac{R}{P}$  = total number of ropes at the upper block passing through and attached

Thus in the figure the number of ropes at the lower block is 3 and the number at the upper 4, which according to the rule would give the same relations between  $P$ ,  $R$  and  $W$  as in the above equations.

**Differential Pulley.** (See Fig. 109.) Here there are two sheaves at  $A$  fastened together and one at  $B$ .

$R$  = radius of large upper pulley  
 $r$  = radius of small upper pulley

$$\text{Then } \frac{W}{P} = \frac{2R}{R-r}$$

$$W = \frac{2R}{R-r} \times P$$

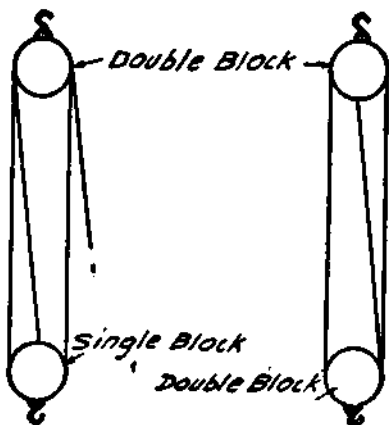

*Luff Tackle*

*Gun Tackle*

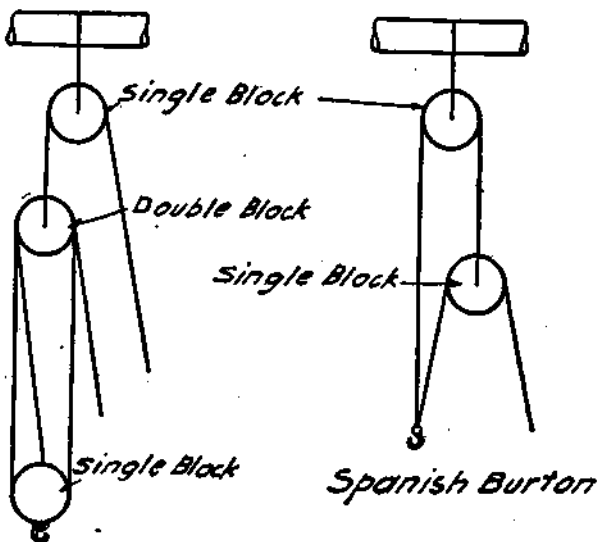

*Runner's Tackle*

*Spanish Burton*

$$\text{Velocity of } W = \frac{R-r}{2R} \times \text{velocity of } P$$

The loss of power in tackles due to friction and rigidity of the rope amounts to at least 10% of the load to be raised, for every sheave used.

In the case of a simple tackle the power gained is represented by the sum of all the returns which act immediately on the movable block. In a combination of tackles where one acts on the running end of another, the power gained is found by multiplying together the value of the several simple tackles. Hence all calculations relating to tackles can be worked out by the following formulæ.

Let  $S$  = strain on running end or strain which rope will take  
 $P$  = power of the tackle  
 $n$  = number of sheaves  
 $W$  = weight  
 The allowance for friction for each sheave in motion is taken as  $\frac{1}{8} W$

$$\text{Then } S \times P = W + \frac{n W}{8}$$

$$\text{and } S \text{ or strain on rope} = \frac{W(8+n)}{8 \times P}$$

$$\text{Weight } (W) \text{ that could be lifted} = \frac{S(8 \times P)}{8+n}$$

Knowing  $W$  and  $S$ , if required to find the number of sheaves necessary,

Put  $P = n$  if the running end comes off from the standing block

$P = n + 1$  if the running end comes off from the movable block

Hence the sheaves  $n$  necessary when the running end comes off the standing block are  $\frac{8W}{8S-W}$  and if off the movable block  $\frac{8(W-S)}{8S-W}$

If a snatch block is used to alter the direction of the lead, the strain on the running end must be found and one eighth added for the friction of the snatch block. In other words, multiply the strain on the fall passing through the snatch block by  $\frac{9}{8}$

*Examples.* A weight of 10 tons is to be lifted by shears with a tackle consisting of two treble blocks. What is the strain on the running end of the rope?

$$W = 10 \text{ tons; } n = 3 \times 2 = 6; P = 3 \times 2 = 6$$

$$\text{Strain } S = \frac{W(S+n)}{S \times P} = \frac{10(S+6)}{3 \times 6} = 2 \frac{11}{12} \text{ tons}$$

In the above, if the running end was led through a snatch block to a winch, what would be the pull on the drum of the winch?

$$\text{Pull} = \text{strain } S \times \frac{9}{8} = 2 \frac{11}{12} \times \frac{9}{8} = \frac{35}{12} \times \frac{9}{8} = 3 \frac{9}{32} \text{ tons}$$

A pair of rope blocks with two sheaves in each block lifts a weight of  $1\frac{1}{2}$  tons. Find the pull on the end of the rope neglecting friction. One ton = 2,240 lb.

With two sheaves in the bottom block, if the weight is raised 1 ft. the pull moves 4 ft. Applying the principle of work, pull  $\times$  distance it moves = weight  $\times$  distance it moves.

$$\text{pull} \times 4 = 1\frac{1}{2} \times 2,240 \times 1$$

$$\text{Pull} = \frac{3}{2} \times \frac{2,240}{4} = 840 \text{ lb.}$$

(Abstracts on Tackles from Practical Marine Engineering and Manual of Seamanship.)

## CHAIN

The distance from the center of one link to the center of the next, which is the pitch of the chain, is equal to the inside length of the link.

To find the weight a chain will lift when reeved as a tackle, multiply the Ordinary Safe Load General Use in the following table by the number of parts at the movable block, and subtract one-quarter for resistance.

To find the size of chain necessary to lift a given weight, divide the weight by the number of parts at the movable block and add one-third for friction; then find from the column of Ordinary Safe Load General Use the corresponding strain and the size of the chain. In case of heavy chain, or where the chain is unusually long, the weight thereof should be taken into account.

The life of a chain can greatly be increased by frequent annealing and lubricating, and if the wear is not uniform throughout the length, the chain should be cut and pieced where partially worn, so that when finally discarded every link shall have done its full share of work without exceeding the limit of perfect safety.

The diameter of sheaves or drums should not be less than 30 times the diameter of the chain iron used.

Hooks and rings (see Strength of Materials) should be made from the best hammered iron, and will appear clumsy and out of

proportion to the size of chain when made to equal its strength. For instance, a hook for  $\frac{3}{4}$ -inch chain should be made from  $2\frac{1}{4}$ -inch iron and will weigh about 20 lb. The ring, if less than 6 ins. diameter, should be made double the size of the iron in the chain, and if greater in diameter, the size of iron must exceed this proportion. (Above proportions recommended by Bradlee & Co., Phila.)

TABLE OF PITCH, BREAKING, PROOF AND WORKING STRAINS OF CHAIN\*

Size of Chain	Dist. From Center of One Link to Center of Next	Weight per Foot in Lb. Approximately	Out-side Width	D. B. G. Special Crane			Crane		
				Proof Test Lb.	Average Breaking Strain Lb.	Ordinary Safe Load General Use	Proof Test Lb.	Average Breaking Strain Lb.	Ordinary Safe Load General Use Lb.
$\frac{1}{4}$	$\frac{3}{8}$	$\frac{3}{4}$	$\frac{1}{2}$	1,932	3,864	1,288	1,680	3,360	1,120
$\frac{1}{2}$	$\frac{1}{2}$	1	$1\frac{1}{2}$	2,896	5,796	1,932	2,520	5,040	1,680
$\frac{3}{4}$	$\frac{3}{4}$	$1\frac{1}{2}$	$1\frac{1}{2}$	4,186	8,372	2,790	3,640	7,280	2,427
$1$	$1\frac{1}{4}$	2	$1\frac{1}{2}$	5,796	11,592	3,864	5,040	10,080	3,360
$1\frac{1}{4}$	$1\frac{1}{2}$	$2\frac{1}{2}$	$1\frac{1}{2}$	7,728	15,456	5,152	8,720	13,440	4,480
$1\frac{1}{2}$	$1\frac{3}{4}$	$3\frac{1}{2}$	2	9,660	19,320	6,440	8,400	16,800	5,600
$1\frac{3}{4}$	$2$	$4\frac{1}{2}$	$2\frac{1}{2}$	11,914	23,828	7,942	10,360	20,720	6,907
$2$	$2\frac{1}{4}$	5	$2\frac{1}{2}$	14,490	28,980	9,660	12,800	25,200	8,400
$2\frac{1}{4}$	$2\frac{1}{2}$	$6\frac{1}{2}$	$2\frac{1}{2}$	17,388	34,776	11,592	15,120	30,240	10,080
$2\frac{1}{2}$	$2\frac{3}{4}$	$6\frac{3}{4}$	$2\frac{1}{2}$	20,286	40,572	13,524	17,640	35,280	11,760
$2\frac{3}{4}$	$3$	$8\frac{1}{2}$	$2\frac{1}{2}$	22,484	44,968	14,989	20,440	40,880	13,627
$3$	$3\frac{1}{4}$	9	$3\frac{1}{2}$	25,872	51,744	17,248	23,520	47,040	15,680
$3\frac{1}{4}$	$3\frac{1}{2}$	$10\frac{1}{2}$	$3\frac{1}{2}$	29,568	59,136	19,712	26,880	53,760	17,920
$3\frac{1}{2}$	$3\frac{3}{4}$	12	$3\frac{1}{2}$	33,264	66,528	22,176	30,240	60,480	20,160
$3\frac{3}{4}$	$4$	$13\frac{1}{2}$	$3\frac{1}{2}$	37,578	75,152	25,060	34,160	68,320	22,773
$4$	$4\frac{1}{4}$	$13\frac{3}{4}$	4	41,888	83,776	27,925	38,080	76,160	25,387
$4\frac{1}{4}$	$4\frac{1}{2}$	16	$4\frac{1}{2}$	46,200	92,400	30,800	42,000	84,000	28,000
$4\frac{1}{2}$	$4\frac{3}{4}$	$16\frac{1}{2}$	$4\frac{1}{2}$	50,512	101,024	33,674	45,920	91,840	30,613
$4\frac{3}{4}$	$5$	$19\frac{1}{4}$	$4\frac{1}{2}$	55,748	111,496	37,165	50,880	101,360	33,787
$5$	$5\frac{1}{4}$	$19\frac{1}{2}$	$4\frac{1}{2}$	60,368	120,736	40,245	54,880	109,760	36,587
$5\frac{1}{4}$	$5\frac{1}{2}$	$23$	$5\frac{1}{2}$	66,528	133,056	44,352	60,480	120,960	40,320
$5\frac{1}{2}$	$5\frac{3}{4}$	25	$5\frac{1}{2}$	70,762	141,524	47,174	65,520	131,140	43,180
$6$	$6\frac{1}{4}$	28	$5\frac{1}{2}$	74,382	148,764	49,588	68,320	136,640	45,080
$6\frac{1}{4}$	$6\frac{1}{2}$	30	$5\frac{1}{2}$	78,733	157,466	52,468	71,840	143,680	47,180
$6\frac{1}{2}$	$6\frac{3}{4}$	31	$5\frac{1}{2}$	82,320	164,640	54,880	74,800	149,600	48,800
$6\frac{3}{4}$	$7$	33	$6\frac{1}{2}$	88,256	176,512	59,504	81,280	162,560	53,280
$7$	$7\frac{1}{4}$	35	$6\frac{1}{2}$	94,360	188,720	62,906	86,080	172,160	56,387
$7\frac{1}{4}$	$7\frac{1}{2}$	38	$6\frac{1}{2}$	100,800	201,600	67,200	91,200	182,400	60,480
$7\frac{1}{2}$	$7\frac{3}{4}$	40	$6\frac{1}{2}$	107,520	215,040	71,680	96,800	193,600	64,800
$8$	$8\frac{1}{4}$	43	$6\frac{1}{2}$	114,240	228,480	76,160	102,800	205,600	69,280
$8\frac{1}{4}$	$8\frac{1}{2}$	$46\frac{1}{4}$	$7\frac{1}{2}$	121,240	242,480	80,823	109,200	218,400	73,733
$8\frac{1}{2}$	$8\frac{3}{4}$	$49\frac{1}{2}$	$7\frac{1}{2}$	128,576	257,152	85,750	116,320	232,640	78,400
$8\frac{3}{4}$	$9$	$52\frac{1}{4}$	$7\frac{1}{2}$	136,080	272,160	90,720	124,000	248,000	83,280
$9$	$9\frac{1}{4}$	$58\frac{1}{4}$	$8\frac{1}{2}$	151,580	303,160	101,053	133,280	266,560	90,080
$9\frac{1}{4}$	$9\frac{1}{2}$	$64\frac{1}{2}$	$8\frac{1}{2}$	168,000	336,000	112,000	144,000	288,000	98,400
$9\frac{1}{2}$	$9\frac{3}{4}$	70	$8\frac{1}{2}$	180,544	361,088	120,382	156,800	313,600	107,200
$10$	$10\frac{1}{4}$	73	$9\frac{1}{2}$	193,088	386,176	128,725	170,400	340,800	116,800
$10\frac{1}{4}$	$10\frac{1}{2}$	76	$9\frac{1}{2}$	205,408	410,816	136,938	185,600	371,200	126,800
$10\frac{1}{2}$	$10\frac{3}{4}$	81	$9\frac{1}{2}$	217,728	435,456	145,152	199,200	398,400	137,200
$11$	$11\frac{1}{4}$	86	$9\frac{1}{2}$	230,048	460,096	153,366	214,400	428,800	148,000

\* Bradlee & Co., Philadelphia, Pa.

**Chains for hoisting purposes** should be made of short links in order to wrap snugly around drums without risk of bending, and should have oval sides so that when the chain surges each link will act as a spring, yielding a trifle.

To find the **outside length of any number of lengths**, multiply the inside length of one link by the number of links and add two thicknesses of the iron.

Tests have shown that the **ultimate breaking strength of a chain with studded links is less than that of an unstudded chain**. The principal function of the stud is to prevent the chain from kinking and catching.

**Swivels** are inserted in a chain to prevent the accumulation of turns as a ship swings around her anchor. There may be three or four swivels in a cable, the first being about five fathoms from the anchor. Total length of cable varies from 90 to 200 fathoms. (See Lloyd's Rules.)

#### ANCHORS AND ANCHOR DAVITS

There are two types of anchors, viz. stock and stockless. The latter can be stowed in hawse pipes instead of on billboards on the deck. All the following anchors except grapnel and mushroom may be of the stockless type. The number and size of anchors to

#### ANCHORS FOR YACHTS AND MOTOR BOATS

L.	Size of Boat		D.	No. of Anchors	Weight Bower		Weight Kedge	
	B.							
30	× 5	× 4		1			1	50
35	× 8	× 5		1			1	100
40	× 10	× 5½		2	1	100	1	50
40	× 10	× 6		2	1	110	1	50
50	× 11	× 6		2	1	110	1	50
55	× 11½	× 6		2	1	120	1	50
60	× 12	× 6		2	1	130	1	50
65	× 13	× 6		2	1	130	1	60
70	× 14	× 6½		2	1	150	1	60
75	× 15	× 7		2	1	170	1	75
80	× 16	× 8		2	1	200	1	90
90	× 18	× 10		3	2	250	1	90
100	× 19	× 12		3	2	325	1	110
110	× 20	× 13		3	2	400	1	150
120	× 20	× 13		3	2	400	1	150
130	× 20	× 13		3	2	450	1	170
140	× 20	× 14		3	2	450	1	170
150	× 20	× 14		3	2	500	1	200

All weights are net.

In accordance with insurance regulations.



TABLE OF ANCHORS REQUIRED FOR STEAM VESSELS  
According to their Tonnage, also Number of Anchors and Size of  
Cable.

Ton- nage	Number Required			Weight of Each			Second Kedge	Fath- oms of Cable	Size of Cable
	Bower	Stream	Kedge	Bower	Stream	Kedge			
100	2	1	..	392	112	....	...	105	1 1/8
150	2	1	..	504	200	....	...	120	1 1/8
200	2	1	..	672	225	....	...	120	1 1/8
250	2	1	..	840	280	....	...	120	1 1/8
300	2	1	..	1008	300	....	...	120	1
350	2	1	..	1176	336	....	...	120	1 1/8
400	2	1	1	1344	530	250	...	135	1 1/8
450	2	1	2	1512	560	280	...	135	1 1/8
500	2	1	2	1680	675	335	...	150	1 1/4
600	2	1	2	1848	730	360	...	150	1 1/8
700	2	1	2	2016	790	390	...	165	1 3/8
800	2	1	2	2184	900	450	225	165	1 1/8
900	2	1	2	2380	1000	500	250	180	1 1/2
1000	2	1	2	2600	1120	560	280	180	1 1/8
1200	2	1	2	2850	1175	580	310	180	1 1/8
1400	2	1	2	3100	1230	615	310	180	1 1/8
1600	2	1	2	3350	1350	675	335	180	1 3/4
1800	2	1	2	3600	1450	730	360	180	1 1/8
2000	3	1	2	3800	1500	760	360	180	1 1/8
2300	3	1	2	4100	1550	785	390	180	1 1/8
2600	3	1	2	4250	1625	815	390	270	2
3000	3	1	2	4400	1680	850	420	270	2 1/8
3500	3	1	2	4600	1800	900	475	270	2 1/8
4000	4	1	2	4800	1960	950	500	270	2 1/8
4500	4	1	2	5000	2130	1050	530	270	2 1/4
5000	4	1	2	5200	2250	1100	560	270	2 1/8
5500	4	1	2	5400	2400	1170	585	300	2 3/8
6000	4	1	2	5600	2520	1250	625	300	2 1/8
6500	4	1	2	5800	2650	1320	660	300	2 1/2
7000	4	1	2	6000	2800	1400	700	300	2 1/8
8000	4	1	2	6300	3000	1500	750	330	2 5/8
9000	4	1	2	6650	3250	1620	800	330	2 1/8
10000	4	1	2	7000	3500	1750	870	360	2 3/4

Size of anchors based on requirements of American Bureau of Shipping.

TABLE OF ANCHORS REQUIRED FOR SAILING VESSELS  
According to their Tonnage, also Number of Anchors and Size of Cable

Ton- nage	Number Required			Weight of Each			Second Kedge	Fath- oms of Cable	Size of Cable
	Bower	Stream	Kedge	Bower	Stream	Kedge			
75	2	1	1	600	170	110	...	90	1 1/4
100	2	1	1	700	200	110	...	105	1 1/2
125	2	1	1	800	225	110	...	105	1 1/2
150	2	1	1	900	280	140	...	120	1
175	2	1	1	1000	330	170	...	120	1 1/4
200	2	1	1	1100	400	200	...	120	1 1/2
250	2	1	1	1300	450	225	112	135	1 1/4
300	2	1	1	1450	500	250	125	135	1 1/4
350	2	1	1	1625	560	280	140	150	1 1/4
400	2	1	1	1850	600	300	155	150	1 1/4
450	2	1	1	1900	675	340	170	165	1 1/2
500	2	1	1	2125	775	400	195	165	1 1/4
600	3	1	1	2450	900	450	225	180	1 1/2
700	3	1	1	2800	1000	500	250	180	1 1/4
800	3	1	1	3125	1125	615	280	180	1 1/2
900	3	1	1	3350	1225	650	310	180	1 1/4
1000	3	1	1	3575	1250	675	335	180	1 1/4
1200	3	1	1	3800	1450	725	360	180	1 1/2
1400	3	1	1	4000	1550	780	395	180	1 1/4
1600	3	1	1	4250	1600	840	420	180	2
1800	3	1	1	4500	1800	900	450	180	2
2000	3	1	1	4700	1900	950	500	180	2 1/4
2500	3	1	1	5000	2100	1120	560	180	2 1/2
3000	3	1	1	5400	2350	1230	615	180	2 1/4
3500	3	1	1	5800	2600	1300	650	180	2 1/4

Size of anchors based on requirements of American Bureau of Shipping.

be carried are given by the classification rules. Below are the names of the different anchors.

**Bower anchor**, the heaviest carried, is for anchoring in exposed positions.

**Stream anchor**, about one-third the weight of the bower, is for use in bays and rivers.

**Kedge anchor**, about one-half the weight of the stream, is for anchoring in sheltered positions.

**Grapnel**, a small anchor with several flukes, carried by small yachts and motor boats.

**Mushroom anchor** has a circular dished end and is only for small craft.

**Anchor Davits.**—To get an anchor on deck after it has been raised above the water by the windlass, a tackle (called a fish tackle) suspended from the davit or crane (see Fig. 111) is hooked into an eye on the shank of the anchor, which is then run up and laid on the billboard where it is lashed down to ring bolts. Stockless anchors may be drawn into the hawse pipes, hence do not require billboards. For calculations for davits see *Strength of Materials*.

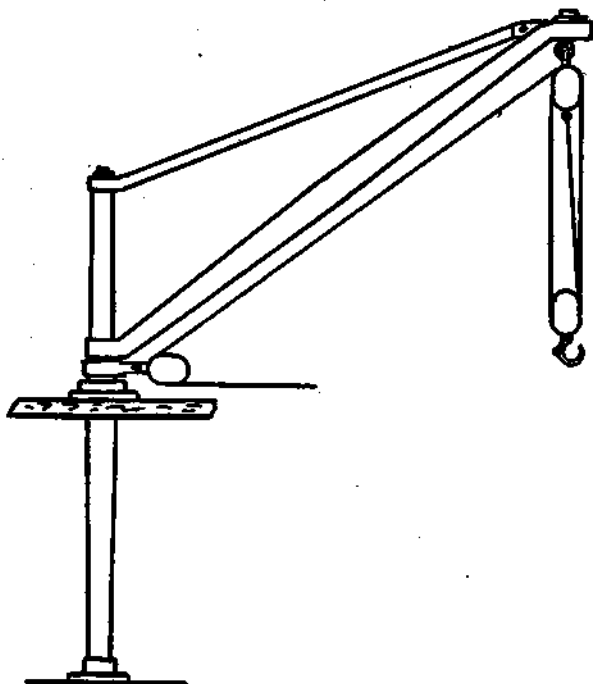

Figure 111.—Anchor Crane.

**SIZES OF ANCHOR CRANES**  
(Lloyd's Requirements)

Weight of Anchor including Stock, in Cwts.*	Spread of Crane in Feet						
	9	10	11	12	13	14	15
	Diameter of Main Post at Deck in Inches						
20	6	6 $\frac{1}{4}$	6 $\frac{1}{2}$	6 $\frac{3}{4}$	6 $\frac{3}{4}$	7	7 $\frac{1}{4}$
25	6 $\frac{1}{2}$	6 $\frac{3}{4}$	7	7 $\frac{1}{4}$	7 $\frac{1}{4}$	7 $\frac{1}{2}$	7 $\frac{3}{4}$
30	7	7 $\frac{1}{4}$	7 $\frac{1}{2}$	7 $\frac{3}{4}$	7 $\frac{3}{4}$	8	8 $\frac{1}{4}$
35	7 $\frac{1}{4}$	7 $\frac{1}{2}$	7 $\frac{3}{4}$	8	8	8 $\frac{1}{4}$	8 $\frac{1}{2}$
40	7 $\frac{1}{2}$	7 $\frac{3}{4}$	8	8 $\frac{1}{4}$	8 $\frac{1}{2}$	8 $\frac{3}{4}$	9
45	8	8 $\frac{1}{4}$	8 $\frac{1}{2}$	8 $\frac{3}{4}$	9	9 $\frac{1}{4}$	9 $\frac{1}{2}$
50	8 $\frac{1}{4}$	8 $\frac{1}{2}$	8 $\frac{3}{4}$	9	9 $\frac{1}{4}$	9 $\frac{1}{2}$	9 $\frac{3}{4}$
55	8 $\frac{1}{2}$	8 $\frac{3}{4}$	9	9 $\frac{1}{4}$	9 $\frac{1}{2}$	9 $\frac{3}{4}$	10
60	8 $\frac{3}{4}$	9	9 $\frac{1}{4}$	9 $\frac{1}{2}$	9 $\frac{3}{4}$	10	10 $\frac{1}{4}$

\* One cwt. = 112 lb.

**CORRESPONDING DIMENSIONS OF MAIN POST, TIE ROD AND JIB**  
OF ANCHOR CRANES

Main Post, Dia. at Deck, Ins.	Tie Rod, Dia., Ins.	Jib, Dia. at Middle, Ins.
6	1 $\frac{3}{4}$	3
6 $\frac{1}{2}$	1 $\frac{7}{8}$	3 $\frac{1}{4}$
7	2	3 $\frac{1}{2}$
7 $\frac{1}{2}$	2 $\frac{1}{8}$	3 $\frac{3}{4}$
8	2 $\frac{1}{4}$	4
8 $\frac{1}{2}$	2 $\frac{3}{8}$	4 $\frac{1}{4}$
9	2 $\frac{1}{2}$	4 $\frac{1}{2}$
9 $\frac{1}{2}$	2 $\frac{5}{8}$	4 $\frac{3}{4}$
10	2 $\frac{3}{4}$	5
10 $\frac{1}{2}$	2 $\frac{7}{8}$	5 $\frac{1}{4}$

If two tie rods are fitted, the diameter of each is to be  $\frac{3}{4}$  that of the single rod required.

The steel of which the anchor davits are made has a tensile strength of 35 tons per square inch with an elongation of not less than 10% in a length of 8 ins. The davits are to have solid heels and are to be efficiently strengthened in way of the heads and deck supports.

The following table, from Lloyd's, contains a list of equivalent sizes of solid and hollow posts.

TABLE OF EQUIVALENT SIZES

Diameter at Deck of Solid Wrought Iron Davit or of Main Posts of Anchor Cranes Inches	Diameter and Thickness of Approved Weldless Drawn Steel Hollow Bolt or Anchor Davit Inches	
	Diameter	Thickness
3	4	× 1/4
1/4	4 1/2	× 1/4
1/2	4 3/4	× 1/4
3/4	5 1/4	× 1/4
4	5 1/2	× 1/4
1/4	5 3/4	× 1/4
1/2	6	× 1/4
3/4	6 1/2	× 1/4
5	6 1/2	× 1/4
1/4	7	× 1/4
1/2	7 1/4	× 1/4
3/4	7 3/4	× 1/4
6	7 3/4	× 1/4
1/4	8 1/4	× 1/4
1/2	8 1/2	× 1/4
3/4	9	× 1/4
7	9	× 1/2
1/4	9 1/2	× 1/2
1/2	9 3/4	× 1/2
3/4	10 1/4	× 1/2
8	10 1/4	× 1/4
1/4	10 3/4	× 1/4
1/2	11	× 1/4

For fittings see Shackles, Blocks, Bolts, etc.

**LIFE SAVING EQUIPMENT AND ACCESSORIES**

The following are abstracts from the U. S. Steamboat-Inspection requirements for the year 1916:

**"Ocean Steamers.**—Under this designation shall be included all steamers whose routes extend 20 nautical miles or more offshore.

**"Coastwise Steamers.**—Under this designation shall be included all steamers whose routes throughout their entire length are restricted to less than 20 nautical miles offshore. Steamers navigating the waters of the Atlantic or Pacific Ocean or the Gulf of Mexico whose routes are restricted to one nautical mile or less offshore shall be included in the class of lake, bay and sound steamers.

**"Lifeboats and Life Rafts Required.**—All steamers other than steamers carrying passengers, except as otherwise hereinafter provided for, shall be equipped with lifeboats of sufficient capacity to accommodate at one time all persons on board. One-half of such equipment may be in approved life rafts or approved collapsible lifeboats.

"All vessels of less than 50 gross tons navigating under the provisions of Title LII, Revised Statutes of the United States, not carrying passengers shall be equipped with lifeboats or life rafts of sufficient capacity to accommodate at one time all persons on board.

"Steamers that are used exclusively as fireboats and belonging to a regularly organized fire department shall be required to carry only such boats or rafts as in the judgment of the local inspector may be necessary to carry the crew.

"Ocean steamers carrying passengers shall be equipped with lifeboats of sufficient capacity to accommodate at one time all persons on board including passengers and crew. One-half of such lifeboat equipment may be in approved life rafts or approved collapsible lifeboats.

"Coastwise steamers carrying passengers shall be equipped with lifeboats of sufficient capacity to accommodate at one time all persons on board, including passengers and crew; Provided, however, That such steamers navigating during the interval from the 15th day of May to the 15th day of September in any one year, both dates inclusive, will be required to be equipped with lifeboats of only such capacity as will be sufficient to accommodate at one time at least 60% of all persons on board, including passengers and crew. Two-thirds of such required lifeboat equipment throughout the year may be in approved collapsible lifeboats.

**"Working Boat.**—Steamers of 50 gross tons and upward carrying passengers shall have one working boat with life lines attached, properly supplied with oars and painter, and kept in good condition at all times and ready for immediate use, in addition to the lifeboats required.

**"Motor Driven Lifeboats on Steamers.**—All ocean steam vessels of over 2,500 gross tons carrying passengers and whose course carries them 200 miles or more offshore shall be required to be equipped with not less than one motor-propelled lifeboat as part of their lifeboat equipment; Provided, however, That any vessel under the jurisdiction of this service may be allowed to carry one motor-propelled lifeboat as a part of the lifeboat equipment on such steamer, except that on steamers carrying more than 6 lifeboats under davits 2 of such lifeboats may be equipped with motors.

"Gasoline may be used for such motors when it is carried only in seamless steel, welded steel, or copper tanks securely and firmly fitted in such lifeboats and located where the greatest safety will be secured.

"All fittings, pipes and connections shall be of the highest standard and best workmanship and in accordance with the best modern practice. Storage of gasoline other than in the lifeboats using it shall not be allowed under any circumstances.

"In computing the cubical capacity of motor-driven lifeboats, the space required for the engine and fuel shall be excluded.

"Seine Fishing and Wrecking Vessels may substitute a wooden surfboat or wooden seine boat for a lifeboat.

**"Lifeboats and Rafts Required on Inspected Motor Vessels.**—All vessels propelled by machinery other than steam, subject to the inspection laws of the United States, shall be required to have the same lifeboat and life raft equipment as steamers of the same class and local inspectors shall so indicate in the certificate of inspection. This paragraph shall not apply to such vessels under 50 tons, when navigating in daylight only, and when equipped with air tanks under deck of sufficient capacity to sustain afloat the vessel when full of water with her full complement of passengers on board, or when properly subdivided by iron or steel watertight bulkheads of sufficient strength and so arranged and located that the vessel will remain afloat with her complement of passengers with any two compartments open to the sea; Provided, however, That no such vessel shall be navigated upon the waters of the ocean without having on board lifeboat capacity of at least 100 cu. ft.

**"Lifeboats and Other Equipment Required on Sailing Vessels.—**Local inspectors inspecting sailing vessel carrying passengers on the ocean or on the high seas shall require such vessels to be equipped with a life preserver for every person on board, passengers and crew, and with lifeboats in accordance with the requirements of the rule applying to ocean steamers carrying passengers. †

**"Lifeboats and their Equipment Required on Seagoing Barges of 100 Gross Tons or Over.—**The lifeboats required on seagoing barges of 100 gross tons or over shall be at least 14 ft. long and equipped with a properly secured life line the entire length on each side, such life line to be festooned in bights not longer than 3 ft. with a seine float in each bight, at least 2 life preservers, 1 painter of not less than 2¾-inch Manila rope (about .9 inch diameter) properly attached and of suitable length, 4 oars of suitable length for size of boat, not less than 4 rowlocks, 1 boat hook properly secured to staff of suitable length, 1 bucket, and on wooden boats 2 plugs for each drain hole. The row locks and plugs shall be attached to the boat with suitable chain."

**"Life Saving Appliances.\*—**The following table [page 666] fixes the number of davits and lifeboats according to the length of the vessel:

"(A) The minimum number of sets of davits to be provided, to each of which must be attached a boat of the first class.

"(B) The minimum total number of open boats of the first class which must be attached to davits.

"(C) The minimum boat capacity required, including the boats attached to davits and the additional boats.

"In vessels which carry rafts there shall be a number of rope or wooden ladders always available for use in embarking the persons onto the rafts.

"The number and arrangement of the boats and (where they are allowed) of the pontoon rafts on a vessel depend upon the total number of persons which the vessel is intended to carry; Provided, That shall not be required on any voyage a total capacity in boats and (where they are allowed) pontoon rafts, greater than that necessary to accommodate all the persons on board.

"At no moment of its voyage shall any passenger steam vessel of the United States on ocean routes more than 20 nautical miles offshore have on board a total number of persons greater than that for whom accommodation is provided in the lifeboats and pontoon life rafts on board.

\* Abstract from Seamen's Bill which went into effect in the United States in 1915.



## SHIP EQUIPMENT

Registered Length of the Ship (Feet)	(A) Minimum Number of Sets of Davits	(B) Minimum Number of Open Boats of the First Class	(C) Minimum Capacity of Lifeboats
			Cubic feet
100 and less than 120.....	2	2	980
120 and less than 140.....	2	2	1,220
140 and less than 160.....	2	2	1,550
160 and less than 175.....	3	3	1,880
175 and less than 190.....	3	3	2,390
190 and less than 205.....	4	4	2,470
205 and less than 220.....	4	4	3,330
220 and less than 230.....	5	4	3,900
230 and less than 245.....	5	4	4,560
245 and less than 255.....	6	5	5,100
255 and less than 270.....	6	5	5,640
270 and less than 285.....	7	5	6,190
285 and less than 300.....	7	5	6,930
300 and less than 315.....	8	6	7,550
315 and less than 330.....	8	6	8,290
330 and less than 350.....	9	7	9,000
350 and less than 370.....	9	7	9,630
370 and less than 390.....	10	7	10,650
390 and less than 410.....	10	7	11,700
410 and less than 435.....	12	9	13,060
435 and less than 460.....	12	9	14,430
460 and less than 490.....	14	10	15,920
490 and less than 520.....	14	10	17,310
520 and less than 550.....	16	12	18,720
550 and less than 580.....	16	12	20,350
580 and less than 610.....	18	13	21,900
610 and less than 640.....	18	13	23,700
640 and less than 670.....	20	14	25,350
670 and less than 700.....	20	14	27,050
700 and less than 730.....	22	15	28,560
730 and less than 760.....	22	15	30,180
760 and less than 790.....	24	17	32,100
790 and less than 820.....	24	17	34,350
820 and less than 855.....	26	18	36,450
855 and less than 890.....	26	18	38,750
890 and less than 925.....	28	19	41,000
925 and less than 960.....	28	19	43,880
960 and less than 995.....	30	20	46,350
995 and less than 1,030.....	30	20	48,750

"If the lifeboats attached to davits do not provide sufficient accommodation for all persons on board, additional lifeboats of one of the standard types shall be provided. This addition shall bring the total capacity of the boats on the vessel at least up to the greater of the two following amounts.

"(a) The minimum capacity required by these regulations,

"(b) A capacity sufficient to accommodate 75% of the persons on board.

"The remainder of the accommodation required shall be provided under regulations of the Board of Supervising Inspectors, approved by the Secretary of Commerce, either in boats of class one or class two, or in pontoon rafts of an approved type.

"At no moment of its voyage shall any passenger steam vessel of the United States on ocean routes less than 20 nautical miles offshore have on board a total number of persons greater than that for whom accommodation is provided in the lifeboats and pontoon rafts on board. The accommodation provided in lifeboats shall in every case be sufficient to accommodate at least 75% of the persons on board. The number and type of such lifeboats and life rafts shall be determined by regulations of the Board of Supervising Inspectors, approved by the Secretary of Commerce; Provided, That during the interval from May 15th to September 15th inclusive, any passenger steam vessel of the United States, on ocean routes less than 20 nautical miles offshore, shall be required to carry accommodation for not less than 70% of the total number of persons on board in lifeboats and pontoon life rafts, of which accommodation not less than 50% shall be in lifeboats and 50% may be in collapsible boats or rafts, under regulations of the Board of Supervising Inspectors, approved by the Secretary of Commerce.

"At no moment of its voyage may any ocean cargo steam vessel of the United States have on board a total number of persons greater than that for whom accommodation is provided in the lifeboats on board. The number and types of such boats shall be determined by regulations of the Board of Supervising Inspectors.

"At no moment of its voyage may any passenger steam vessel of the United States on the Great Lakes, on routes more than three miles offshore, except over waters whose depth is not sufficient to submerge all the decks of the vessel, have on board a total number of persons, including passengers and crew, greater than that for whom accommodation is provided in the lifeboats and pontoon life rafts on board. The accommodation provided in lifeboats

shall in every case be sufficient to accommodate at least 75% of the persons on board. The number and types of such lifeboats and life rafts shall be determined by regulations of the Board of Supervising Inspectors, Provided, That during the interval from May 15th to September 15th inclusive, any such steamer shall be required to carry accommodation for not less than 50% of persons on board in lifeboats and pontoon life rafts, of which accommodation not less than two-fifths shall be in lifeboats and three-fifths may be in collapsible boats or rafts under regulations of the Board of Supervising Inspectors, Provided, further, That all passenger steam vessels of the United States, the keels of which are laid after July 1, 1915, for service on ocean routes or for service from September 15th to May 15th on the Great Lakes, on routes more than 3 miles offshore, shall be built to carry, and shall carry enough lifeboats and life rafts to accommodate all persons on board including passengers and crew, And provided further, That not more than 25% of such equipment may be in pontoon life rafts or collapsible lifeboats.

"The Secretary of Commerce is authorized in specific cases to exempt existing vessels from the requirements of this section that the davits shall be of such strength and shall be fitted with a gear of sufficient power to insure that the boats can be lowered with their full complement of persons and equipment, the vessel being assumed to have a list of 15°, where their strict application would not be practicable or reasonable.

**"Life Jackets and Life Buoys.**—A life jacket of an approved type or other appliance of equal buoyancy and capable of being fitted on the body, shall be carried for every person on board, and in addition a sufficient number of life jackets, or other equivalent appliances suitable for children.

"First. A life jacket shall justify the following conditions:

- (a) It shall be of approved material and construction.
- (b) It shall be capable of supporting in fresh water for 24 hours 15 lb. avoirdupois of iron.

"Life jackets the buoyancy of which depends on air compartments are prohibited.

"Second. A life buoy shall satisfy the following conditions:

- (a) It shall be of solid cork or any other equivalent material.
- (b) It shall be capable of supporting in fresh water for 24 hours at least 31 lb. avoirdupois of iron.

"Life buoys filled with rushes, cork shavings or granulated

cork or any other loose granulated material, or whose buoyancy depends upon air compartments which require to be inflated are prohibited.

"Third. The minimum number of lifebuoys with which vessels are to be provided is fixed as follows:

	Total Number of Buoys	Number Luminous
Vessels under 100 ft. in length.....	2	..
Vessels 100 ft. and under 200 ft.....	4	2
Vessels 200 ft. and under 300 ft.....	6	2
Vessels 300 ft. and under 400 ft.....	12	4
Vessels 400 ft. and under 600 ft.....	18	9

"Fourth. All the buoys shall be fitted with beackets securely seized. At least one buoy on each side shall be fitted with a life line of at least 15 fathoms in length. The lights shall be efficient self-igniting lights which cannot be extinguished in water, and they shall be kept near the buoys to which they belong, with the necessary means of attachment.

"Fifth. All the life buoys and life jackets shall be so placed as to be readily accessible to the persons on board, their position shall be plainly indicated so as to be known to the persons concerned.

"Sect. 18. This Act shall take effect as to all vessels of the United States, eight months after its passage, and as to foreign vessels 12 months after its passage, except that such parts hereof as are in conflict with articles of any treaty with any foreign nation shall take effect as regards the vessels of such foreign nation on the expiration of the period fixed in the notice of abrogation of the said articles as provided in section 16 of this Act."

**Capacities of Lifeboats.**—Measure the length and breadth outside the planking or plating and the depth inside at the minimum depth. The product of these dimensions multiplied by .6 resulting in the nearest whole number shall be deemed the capacity in cubic feet. To determine the number of persons a boat is to carry, divide the result by 10 for ocean steamers as also for lake, bay, and sound steamers. The carrying capacity (U. S. Steamboat-Inspection Rules) of a boat 22 ft. long, 6 ft. beam and 2 ft. 6 ins. deep, as defined above, shall be determined for ocean, lake, bay and sound steamers thus:

$$\frac{22 \times 6 \times 2\frac{1}{2} \times .6}{10} = \frac{198}{10} = 20 \text{ persons}$$

## CAPACITIES OF LIFEBOATS

Length Feet	Beam	Depth	Capacity Cubic Feet	Ocean, Bay, Sound and Lake Persons	Rivers Persons
12	4 ft. 0 in.	1 ft. 9 in.	50	5	6
14	4 ft. 6 in.	2 ft. 0 in.	76	7	9
14	5 ft. 0 in.	2 ft. 2 in.	91	9	11
16	5 ft. 0 in.	2 ft. 1 in.	100	10	12
16	5 ft. 6 in.	2 ft. 4 in.	120	12	15
18	5 ft. 6 in.	2 ft. 4½ in.	140	14	17
20	6 ft. 0 in.	2 ft. 6 in.	180	18	22
22	6 ft. 0 in.	2 ft. 7 in.	204	20	25
22	6 ft. 6 in.	2 ft. 9 in.	236	23	29
24	7 ft. 0 in.	3 ft. 0 in.	302	30	37
24	7 ft. 9 in.	3 ft. 4 in.	371	37	46
26	7 ft. 0 in.	3 ft. 0 in.	327	32	40
26	7 ft. 9 in.	3 ft. 4 in.	401	40	50
28	8 ft. 4 in.	3 ft. 7 in.	501	50	62
30	9 ft. 0 in.	4 ft. 0 in.	648	64	81

**Lundin Lifeboats.**—These are built of galvanized sheet iron, curved at the ends, having a decked hull with the sides extending some 15 ins. above the deck. To add to the stability and strength, the fenders are of Balsa wood which is about 40% lighter than cork. The U. S. Steamboat-Inspection Rules state: "Lundin decked lifeboats shall be rated and accepted as lifeboats under davits, and may be placed in nests of two and under a single pair of davits. They shall be fully equipped as lifeboats and shall be measured in accordance with the formula

$$\text{Cubic capacity} = L \times B \times D \times .9$$

Where  $L$  = length over all in feet

$B$  = width over all in feet

$D$  = depth from top of keel to top of gunwale in feet

The carrying capacity of a Lundin lifeboat for installing on ocean, bay, lake and sound steamers is obtained by dividing the cubic capacity by 10; that is, allowing 10 cu. ft. to a person. Thus in a Lundin boat 28 ft. long, 9 ft. 6 ins. beam, and 2 ft. 6 ins. deep, the cubic capacity =  $28 \times 9.5 \times 2.5 \times .9 = 598.5$  cu. ft., and the number that can be carried =  $\frac{598.5}{10} = 60$ .

## LUNDIN DECKED LIFEBOATS

Length Feet	Breadth Feet	Weight, Pounds Without Persons	Capacity Persons
24	8	3,400	40
26	8.7	4,000	50
28	9.3	4,600	60
30	10	5,500	75

**Engelhardt Collapsible Lifeboats.**—These consist of a buoyant bottom of cork with canvas sides that could be punctured without sinking the boat. When collapsed, the gunwales are flush with the flooring, making a broad life raft. In extreme cases they can be thrown overboard and opened afterwards. When folded they are about 18 ins. high so that several when placed on top of each other will not occupy much more space than one of the ordinary lifeboats. A test was made on a 20-ft. Engelhardt boat with the bottom plugs removed, and even in this condition it could carry about 6,000 lb.

## DIMENSIONS AND CAPACITIES OF ENGELHARDT COLLAPSIBLE LIFEBOATS

Length of Boat	Width		Depth				Number of Persons Carried
			Extended		Collapsed		
	Feet	Inches	Feet	Inches	Feet	Inches	
14	5	6	2	8	1	6	14
16	6	0	2	8	1	6	18
18	6	6	2	8	1	6	21
20	7	0	2	8	1	6	26
22	7	6	2	8	1	6	30
24	8	0	2	8	1	6	35
26	8	6	2	8	1	6	41
28	9	0	2	8	1	6	47

“Engelhardt collapsible lifeboats may be carried as lifeboats or life rafts, but not more than 50% of the actual lifeboat capacity required exclusive of life raft capacity may be substituted by Engelhardt lifeboats. When an Engelhardt lifeboat is allowed as

a lifeboat it shall be carried under the davits with the sides of the boat fully extended, and only one such boat shall be allowed to be carried under one set of davits, except that one nest of two Engelhardt lifeboats shall be allowed to be carried under one set of davits on each side of steam vessels of 2,000 tons and including 5,000 gross tons, and one nest of three shall be allowed to be carried under one set of davits on each side of steam vessels of over 5,000 gross tons and when so nested the sides may be collapsed. Whether carried as lifeboats or as life rafts, they shall be fully equipped as lifeboats." (Abstract from U. S. Steamboat-Inspection Rules.)

To find the cubic capacity, measure in feet and fractions of a foot the length and breadth outside the canvas extension, and the depth inside of the place of the minimum depth taken from the inside of the bottom planking to the top of the gunwale when extended. The product of these dimensions multiplied by .7 is the capacity in cubic feet.

**Life Rafts.**—All metal life raft cylinders of more than 15 ft. in length or of more than 16 ins. in diameter shall be constructed of metal not less than No. 18 B. w. g. Catamaran metallic cylinder life rafts of approved construction shall allow for each person carried  $4\frac{1}{2}$  cu. ft. of air space for steamers navigating ocean and coastwise waters.

#### METALLIC CYLINDER LIFE RAFTS.

Length Over All	Width Outside of Guards	Diameter of Cylinders	Number of persons Carried and Allowed	
			Ocean	River
8 ft. 4 ins.	5 ft. $2\frac{1}{2}$ ins.	1 ft. 4 ins.	5	7
14 ft. 4 ins.	5 ft. $10\frac{1}{2}$ ins.	1 ft. 4 ins.	8	13
12 ft. 4 ins.	7 ft. $7\frac{1}{2}$ ins.	1 ft. 10 ins.	14	21
15 ft. 4 ins.	7 ft. $7\frac{1}{2}$ ins.	1 ft. 10 ins.	17	26

**Life Preservers.**—Every vessel inspected under the provisions of Title LII, Revised Statutes of the United States, shall be provided with one good life preserver, having the approval of the Board of Supervising Inspectors, for each and every person carried. All such life preservers shall be not less than 52 ins. in length when measured flat, and every cork life preserver shall contain an aggregate weight of at least  $5\frac{1}{2}$  lb. of good cork, and every life preserver

shall be capable of sustaining for a period of 24 hours an attached weight so arranged that whether the said weight be submerged or not there shall be a direct downward gravitation pull upon the life preserver of at least 20 lb.

**Ring Buoys.**—The number of ring buoys with which steamers must be provided (U. S. Steamboat-Inspection Rules) is as follows: Vessels under 400 ft. in length 12, of which 6 must be luminous; vessels of 400 ft. and less than 600 ft. 18, of which 9 must be luminous; vessels of 600 ft. and less than 800 ft. 24, of which 12 must be luminous.

Ring buoys shall be of cork or any other equivalent material and shall be capable of sustaining in fresh water a weight of 31 lb. for a period of 24 hours. They shall be fitted with a line festooned in bights around the outer edge. One of the buoys on each side of the vessel shall have a life line attached of at least 15 fathoms.

Luminous buoys are those having attached an efficient self-igniting light which cannot be extinguished in water.

#### BOATS CARRIED BY WAR VESSELS

**Launches**, heavy boats for carrying men and supplies, often driven by either steam or gasoline engines.

**Cutters**, smaller but similar to launches.

**Whale boats**, different model and lighter than cutters. Have a pointed bow and stern.

**Dinghies**, small light boats with square sterns.

**Barge**, the personal boat of an admiral, only carried on flagships.

**Gig**, usually a small whale boat.

**Galleys**, long, narrow boats with a square stern.

#### BOAT DAVITS

Boat davits must be of sufficient strength for a boat to be lowered with its full complement, the vessel having an assumed list of 15 degs. The davits must be fitted with a gear of sufficient power to insure that the boat can be turned out against the maximum list under which the lowering of the boats is possible on the vessel. (U. S. Steamboat-Inspection Rules.) For strength calculations see Strength of Materials, Blocks, etc.

**Rotating Davits.**—These (see Fig. 112) are of wrought iron and have their upper ends curved while the lower part is straight and turns in a fitting on the deck or on the side of the vessel. To launch a boat the covers and lashings are removed and the boat raised



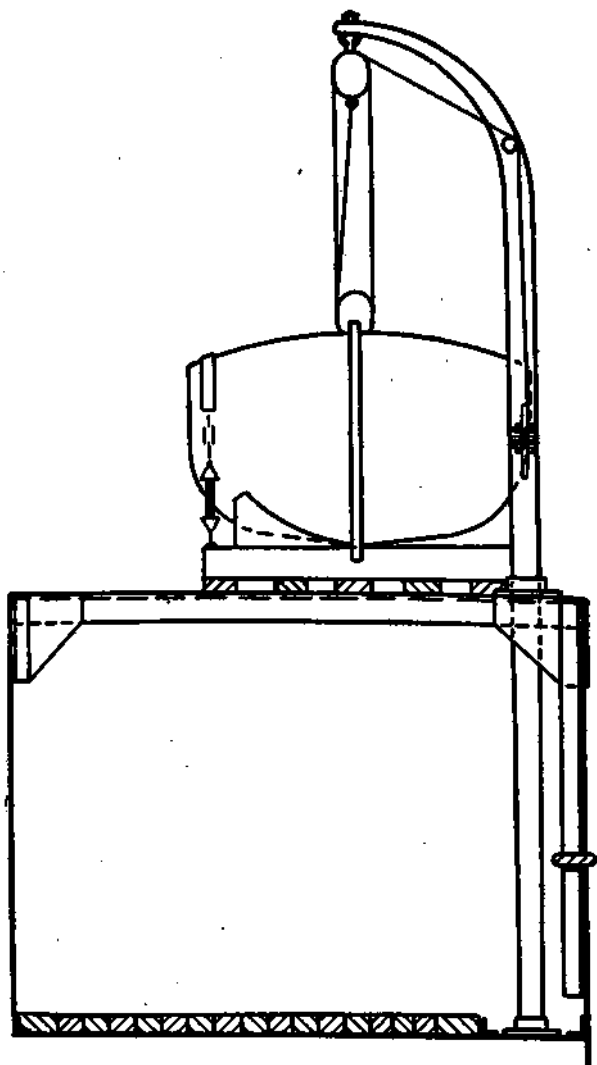

Figure 112.—Rotating Davit.

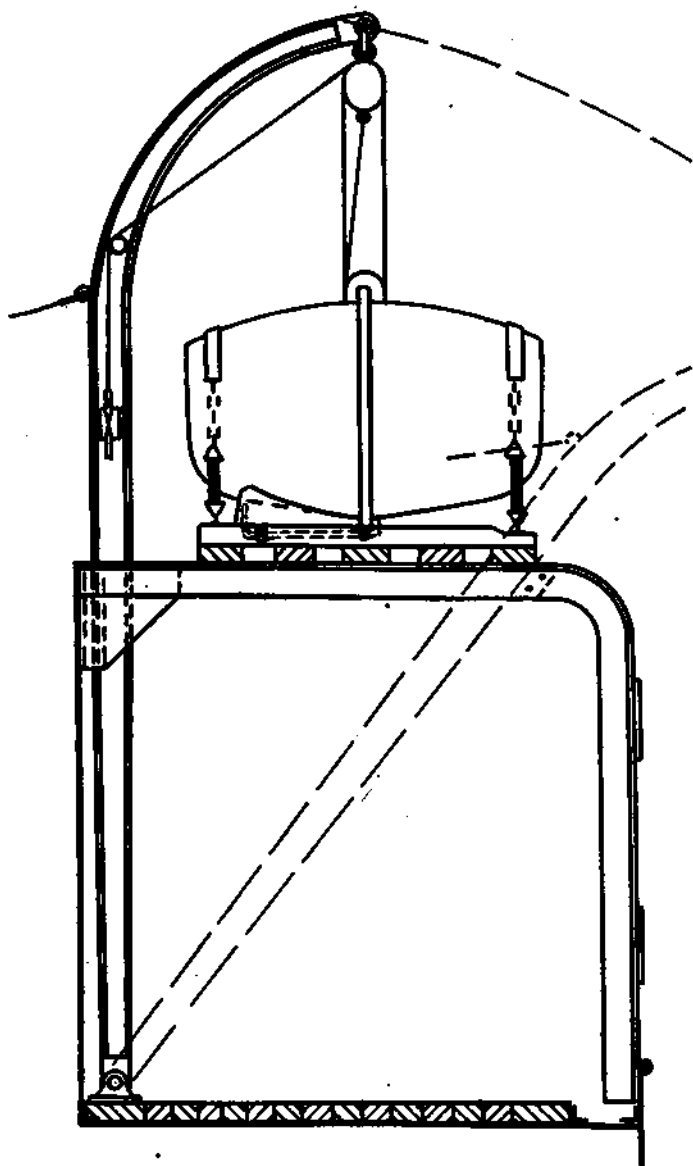

Figure 113.—Pivoted Davit.  
675

by tackles to clear the cradle in which it has been resting. The davits are then swung out, one at a time, bringing the boat clear of the side. The lowering tackles for large boats have triple sheave blocks, and those for small, double sheave. The hauling part or fall passes from the upper block over a small sheave or lug on the side of the davit and is made fast on a cleat on the davit. The lower blocks are provided with eyes which engage with hooks, one at each end of the boat. It is important that both tackles be released when the boat is in the water, and this is often accomplished by slip hooks operated by rods by a man standing in the boat amidships. In the following table are given sizes of solid circular davits.

SIZES OF SOLID CIRCULAR DAVITS

Size of boat	20 ft. × 6 ft. × 2 ft. 6 ins.	24 ft. × 6 ft. 9 ins. × 2 ft. 9 ins.	28 ft. × 7 ft. 9 ins. × 3 ft. 6 ins.	30 ft. × 8 ft. × 3 ft. 6 ins.
Weight loaded, pounds.	3,360	5,040	8,176	9,832
Radius of davit	4 ft.	4 ft. 6 ins.	5 ft.	5 ft. 6 ins.
Height of davit	9 ft.	9 ft.	9 ft.	9 ft.
Diameter of davit by Lloyd's formula	3.7 ins.	4.4 ins.	5.3 ins.	5.6 ins.
Diameter of davit taken as $\frac{1}{100}$ of the boat's length	4. ins.	4.8 ins.	5.6 ins.	6. ins.

**Pivoted or Mallory Davits.**—Here (see Fig. 113) the boats are carried on skid beams. The davits are usually of an I section with the lower part pivoted. To launch a boat, the davits are pulled outboard, being controlled by a tackle until they come against a stop in the guide frames, when the boat is clear of the side of the vessel and may then be lowered.

**Welln Quadrant Davits.**—These (see Fig. 114) are of an I section curved at the top, while at the lower end is a gear section that runs in a rack on the base of the frame. When a boat is stowed permanently the davits are in nearly a vertical position. To lower a boat the fastenings are first removed, then by turning screws by means of hand wheels or handles at the davit the boat is raised and the davits move outboard, thus swinging the boat clear of the vessel. The time required to launch the heaviest boat is about one minute.

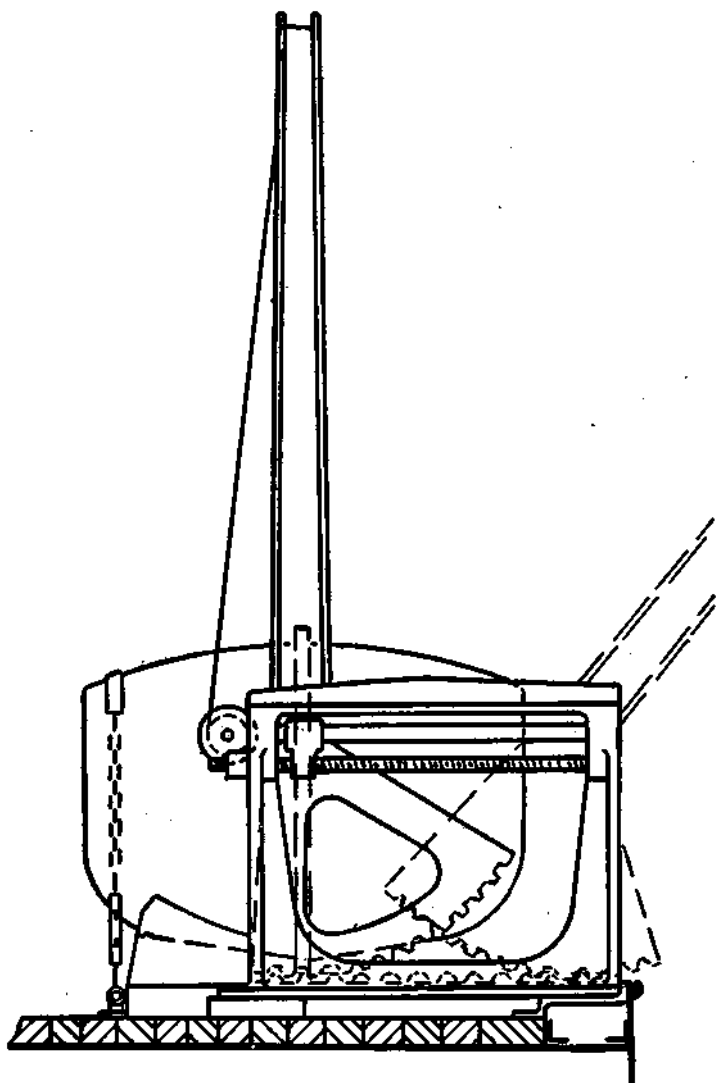

Figure 114.—Welin Quadrant Davit.

The two important features in the Welin davit are: (1) the athwartship traveling motion of the arm, and (2) the compensating arrangement of the falls thus giving a flattened trajectory of the boat and a greater reduction of the power necessary for manipulating it. Compared with a davit pivoted on a stationary pin, the power necessary for starting it outboard is approximately 15%, and for bringing it back 75%, of the force required to manipulate a gear of that type, all conditions being equal.

Marten-Freeman davits have a cast steel frame forming a track. A cast steel tandem roller carriage runs on the track which carries a cast steel boom at the fulcrum, the boom being fastened at its foot to the base of the frame by a movable link. The carriage, and with it the boom, travels inboard or outboard by a Tobin bronze screw operated by a crank, the screw engaging a floating nut in the carriage. The compensating action of the link tends to counterbalance the weight of the boat as the boom moves outboard and to keep the davit in equilibrium at all points.

**Angle of Heel of a Vessel when Lowering a Boat or a Weight.**

Let  $w$  = weight of boat in tons

$h$  = distance between stowed and outboard position for launching

$W$  = displacement of vessel in tons

$GM$  = metacentric height

$\theta$  = angle of heel

The center of gravity of the ship will move a distance  $GG_1$  which is equal to  $\frac{w \times h}{W}$ , but  $GG_1 = GM \times \tan \theta$ , hence  $GM$

$$\tan \theta = \frac{w \times h}{W} \quad \text{or} \quad \tan \theta = \frac{w \times h}{W \times GM}$$

Since  $\theta$  is generally small,  $\tan \theta = \theta$

Then  $\theta = \frac{w \times h}{W \times GM}$ . This gives  $\theta$  in circular measure and to transform it into degrees multiply by 57.

*Example.* Suppose a boat weighing 18 tons is to be launched from a boom 50 ft. from its stowed position. The vessel has a displacement of 7,200 tons, and a  $GM$  of 2 ft. Find the angle of heel of the vessel.

$$\text{Using the formula } \theta = \frac{w \times h}{W \times GM} = \frac{18 \times 50}{7,200 \times 2} = \frac{1}{16}$$

$$\text{or } \theta \text{ in degrees} = 57 \times \frac{1}{16} = \frac{57}{16} = 3\frac{1}{2}^\circ$$

To Find the Distance a Lifeboat Will Be from the Side of a Vessel when the Vessel is Heeled. (See Fig. 115.)

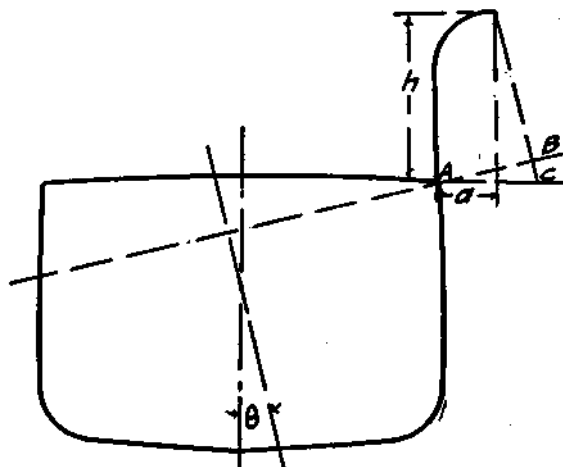

Figure 115.

Let  $AB$  = the horizontal distance the center of the lifeboat will be from the side of the vessel when the vessel is heeled to an angle  $\theta$

$a$  = the projection of the overhang or reach of the davit on the line  $AC$

$h$  = height of the davit above the deck.

Then  $AB = AC \times \cos \theta$

$AC = a$  (the overhang of the davit)  $+ h \sin \theta$

Hence  $AB = (a + h \sin \theta) \times \cos \theta$

## RIGS OF VESSELS

### *Sailing Vessels*

**Sloop.**—One mast with fore and aft sails.

**Yawl.**—Two masts, main mast stepped farther forward than in a sloop, with a smaller mast or jigger aft of the rudder post. All fore and aft sails.

**Ketch.**—Two masts, similar to a yawl rig, only the jigger is forward of the rudder post.

**Schooner.**—Two or more masts, all with fore and aft sails. This rig has proved very satisfactory for engaging in the coastwise trade.

**Brig.**—Two masts, both square rigged, the main sail being the lowest square sail on the main mast.

**Brigantine.**—Two masts, differs from a brig in that the main sail is a fore and aft sail.

**Hermaphrodite Brig.**—Same as a brigantine.

**Bark.**—Three masts, foremast and main mast square rigged, with the mizzen mast fore and aft or schooner rigged.

**Barkentine.**—Three masts; foremast square rigged, main and mizzen mast fore and aft.

**Ship.**—Generally understood to have three masts, viz., fore, main, and mizzen, all with square sails. Large vessels for engaging in the overseas trade have four masts, three of which are square rigged, and the aft or jigger mast schooner rigged.

#### *Steam and Motor Vessels*

Those engaging in the coastwise and ocean trades have two or more masts, each with two or four booms for handling the cargo. When with four booms, two are forward and two are aft of the mast. On many vessels derrick posts with booms are installed, the posts being of steel plates and angles, often serving as ventilators to the quarters below. The average cargo boom can handle about 5 tons. Masts may be of wood or steel, booms usually of wood. Between the masts are strung wires for the wireless telegraph equipment. The masts seldom have sails. As to the rake of the masts and stacks, generally the rake of each is slightly increased, starting with about  $\frac{1}{4}$  in. per ft. for the foremast,  $\frac{3}{8}$  in. per ft. for the stacks and  $\frac{1}{2}$  in. for the main mast. Many cargo steamers have no rake to their masts and stack, which are perpendicular to the water line.

#### *Warships*

Battleships, armored cruisers, and sometimes light cruisers have military masts for observation purposes, with wireless and signal equipment. Smaller vessels, as torpedo boat destroyers, have two pole masts with wireless equipment.

See sections on Rope; Blocks; Tackles; and Ship Machinery.

#### WIRELESS EQUIPMENT

“Every steamer of the United States or of any foreign country navigating the ocean or the Great Lakes and licensed to carry or carrying 50 or more persons, including passengers or crew or both,

must be equipped with an efficient apparatus for radio communication in good working order, capable of transmitting and receiving messages over a distance of at least 100 miles, day or night. An auxiliary power supply independent of the vessel's main electric power plant, must be provided which will enable the sending set for at least four hours to send messages over a distance of at least 100 miles day or night, and efficient communication between the operator in the radio room and the bridge shall be maintained at all times."

"The radio equipment must be in charge of two or more persons skilled in the use of such apparatus, one or the other of whom shall be on duty at all times while the vessel is being navigated. Such equipment, operators, the regulation of their watches, and the transmission and receipt of messages, except as may be regulated by law or international agreement shall be under the control of the master, in the case of a vessel of the United States."

"The choice of radio apparatus and devices to be used by the coastal stations and stations on shipboard shall be unrestricted. The installation of such stations shall as far as possible keep pace with scientific and technical progress."

"Every station on shipboard shall be equipped in such manner as to be able to use wave lengths of 600 meters and of 300 meters. The first, viz., 600 meters, shall be the normal wave length."

"Vessels of small tonnage which are unable to use a wave length of 600 meters for transmission, may be authorized to employ exclusively the wave length of 300, but they must be able to receive a wave length of 600 meters." (Abstract from Radio Communication Laws of the United States, 1916.)

### STORM OIL

"Ocean and coastwise steam vessels of over 200 gross tons, navigating the waters of the Atlantic and Pacific coasts and the waters of any ocean or gulf shall be equipped with oil tanks having suitable pipes attached for distributing oil overboard whenever conditions make same necessary.

"Steamers of over 200 and not over 1,000 gross tons shall be provided with two oil tanks of at least 15 gallons capacity each.

"Steamers of over 1,000 and not over 3,000 gross tons shall be provided with two oil tanks of at least 20 gallons capacity each.

"Steamers of over 3,000 and not over 5,000 gross tons shall be provided with two oil tanks of at least 25 gallons capacity each.



"Steamers of over 5,000 gross tons shall be provided with two oil tanks of at least 50 gallons each.

"One of these tanks shall be placed in the forward and the other in the after part of the vessel, and the pipes from the oil tanks shall be led overboard on both sides of the vessel. Tanks shall be kept filled with animal or storm oil and ready for use at all times." (Abstract from U. S. Steamboat-Inspection Rules, 1916.)

#### LINE-CARRYING GUNS, ROCKETS AND EQUIPMENT

All ocean steam pleasure vessels and ocean steam vessels carrying passengers, except vessels of 150 gross tons and under, shall be provided with at least three line-carrying projectiles and the means of propelling them, such as may have received the formal approval of the Board of Supervising Inspectors (U. S. Steamboat-Inspection Rules).

The projectiles required to be furnished with each gun shall weigh not less than 18 lbs., smoothly turned and finished with a windage of not more than one sixty-fourth of an inch. Service projectile lines shall be similar in size to that used by the U. S. Coast Guard, of not less than 1,700 ft. in length, and capable of withstanding a breaking strain of 500 lbs., and the projectile end shall be so protected that the line will not burn when fired from the gun.

The Lyle and Hunt type of guns is approved, and when tested one round at least shall carry the regular service projectile, with service line attached, in a still atmosphere a distance of at least 1,400 ft. without breaking or fouling. The other two rounds shall be fired with the same charge of powder and the projectile shall have the same weight as the service projectile, but no line need be attached.

When approved rockets are used instead of guns, there shall be, in every case, at least three of said rockets, and all steamers that are required under the law to carry line-carrying projectiles and the means of propelling them shall be supplied auxiliary thereto with at least 800 ft. of 3-inch manila line for vessels of over 150 and not over 500 gross tons and 1,500 ft. of said line for steamers above 500 gross tons; and, except where approved rockets are provided, with three approved service projectile lines and three projectiles. Such auxiliary line and all other equipment shall be kept always ready for use in connection with the gun and rocket, which lines and other equipment shall not be used for any other purpose.

## SECTION X

### SHIP OPERATING

LOADING AND STOWING OF CARGOES, OPERATING NOTES  
PERTAINING TO MACHINERY (SEE INDEX), MAIN-  
TENANCE, SHIP CHARTERING, MARINE INSUR-  
ANCE, SHIPPING AND EXPORT TERMS

#### LOADING AND STOWING OF CARGOES

At present (1917) the legal responsibility for the safety of a ship rests with the captain. Much legislation has been passed in regards to the building and running of merchant vessels, but neither the new laws nor the old ones, with one exception, make any mention of **safe stability**. The single exception is the British Board of Trade, which stipulates that the stability of any passenger steamer should be sufficient to render her safe. Sometimes the Board of Trade insists upon additional stability being given to a vessel by some means or other before granting the passenger certificate. No definition has ever been advanced as to what the Board considers sufficient stability.

Knowing the cargo capacity of a vessel in cubic feet and the stowage weight per cubic foot of the cargo to be carried, the tons of cargo can be calculated. But in making this calculation no account is taken of the draft or freeboard, although it is evident that a vessel with a cargo of iron ore will sink much deeper than with one of cotton, as the weight per cubic foot of the former is more than of the latter. On the sides of all vessels classed by Lloyd's, British Corporation, and Bureau Veritas, there are markings which indicate the minimum freeboard a vessel can have at certain times of the year. See section on Freeboard.

**Loading.**—Even with a freeboard assigned to a vessel, yet the cargo she carries and the way it is loaded play a most important part with regard to her stability. While perhaps, when loading a general cargo which arrives alongside a vessel at all sorts of times,

it is difficult to stow everything as might be the best from a stability standpoint alone, yet care and judgment must be exercised. The curves of stability (see page 189), if supplied by the shipbuilder, should be consulted, particularly if the captain is not familiar with his ship; and if exceptionally heavy weights are to be carried, approximate calculations should be made as to the trim.

If a vessel is narrow and deep the heavy weights should be placed low and the light above, thus insuring a comparatively low center of gravity, as a narrow and deep steamer has a low metacentric height. If, however, one is broad and shallow, thus having a comparatively high metacentric height, the heavy weights should be placed higher than in a narrow and deep vessel, thus tending to raise the center of gravity. Furthermore the weights should be winged out both longitudinally and transversely, and not all concentrated in one place. By winging out the weights a vessel, if she has been designed with sufficient stability, can be made steady in a seaway and at the same time have ample stability. A high metacentric height (see page 202) makes a vessel uncomfortable in rough weather, for she returns to the upright position with a sudden and unpleasant jerk. War vessels are given a low metacentric height so as to have a steady platform from which to fire their guns.

While the above applies in a general way to cargoes of all kinds, yet below are given data on the stowage of oil, grain, coal, and timber cargoes. When loaded with a cargo of all one material, and when the vessel is at her load water line, an unfavorable position of the center of gravity cannot be changed by moving the cargo, as by winging out the heavy weights, the only recourse being to discharge, or leave behind, part of the cargo.

**Oil Cargoes.**—Oiltightness, structural strength, and stability are of the greatest importance in vessels carrying oil in bulk. When a liquid cargo is carried in a closed tank that is kept full, it may be treated as a homogeneous cargo of the same weight. However, if the tank is only partly filled, the center of gravity of the liquid moves from side to side as the vessel rolls, and acts like a suspended or movable weight, which is a most dangerous condition.

When a vessel is fully loaded a height of from 15 to 21 ins. for the transverse metacenter above the center of gravity is recommended as a fair allowance for steamers, while from 30 to 36 ins. for sailing vessels. In loading, adjacent compartments should be filled simultaneously. This also applies when discharging, for if

either of the above precautions were not taken a vessel might be given a serious list with a possibility of her capsizing.

No vessel should proceed to sea with an oil or water ballast tank partially filled, for free oil or water is most dangerous, not only affecting the stability but also the structural strength. Every captain who is obliged to go to sea with only part of a cargo should be given a plan or other data as to the tanks that should be filled with water so as to give the necessary stability and to prevent any part of his vessel from becoming unduly strained. For a vessel may be considered as a beam supported at various points by waves, with the tanks representing the loads coming in many cases between the points of support. The ideal condition of loading is that of a uniformly loaded beam, instead of one heavily loaded at certain points and practically not loaded at all at others.

Refined oil in many instances is shipped in barrels, drums, or in small cans in cases; thus the loading would be the same as for any cargo of one material and can be treated as a solid and not with a free open surface as oil in bulk. When shipped in barrels and cases, no special structural features such as expansion trunks or cofferdams are required to be built in the vessel as when carrying oil in bulk.

The following data are from the Board of Underwriters of New York, on the loading of petroleum or its products. Vessels so loading from ports of the United States will be required to conform to the rules adopted by the Board of Underwriters of New York, to enable the surveyor to issue the proper certificate.

**"In General.**—Vessels with cabin or fore-castle entirely under deck, will not be permitted to load crude oil, naphtha, gasoline, benzine or spirits of petroleum, under inspection.

**"Ballast** must be of stone or shingle. No sand ballast will be permitted. The ballast must be leveled fore and aft and well covered with boards to make an even floor.

**"All vessels** which are to load petroleum must be sufficiently stiff, before taking in any oil, to be able to change their berths in all kinds of weather when tugs can safely tow them.

**"All vessels** loading barrels or cases, especially those taking crude oil, benzine, gasoline, naphtha or spirits of petroleum, must be ventilated through all the hatches, unless already fitted with suitable permanent ventilators fore and aft, to be approved by the surveyors.

**"Stowage of Oil in Barrels.**—All barrels must be stowed bung

up, and care must be taken that the chimes are kept free from the sides of the vessel in the ends.

"No barrel is to be stowed in a place where there is not sufficient room without bearing its weight on the bilge.

"All barrels must be stowed in straight tiers fore and aft. In no case will it be permitted to stow with the sheer of the vessel (rounded off) on the sides.

"The middle of the barrel must be stowed over the four heads of the barrels in the under tier. This will bring the head of each barrel to the bung-hole of the under barrel.

"In places where a barrel cannot be stowed, wood or suitable dunnage should be fitted carefully in order to secure the barrels in the tier.

"No hanging beds will be permitted under any circumstances.

"The barrels must be stowed bilge and cantline, and every barrel properly bedded on the floor and well coined.

"In the ground tier each barrel must rest on two soft wood beds of about one and one-half ( $1\frac{1}{2}$ ) inches in thickness, placed by the quarter hoops, leaving the bilge of the barrel to be free from pressure of about one inch.

"No barrel to be stowed athwartships without special permission of the surveyor, and in no case will it be permitted when the barrel is subject to any pressure.

"Single deck vessels with hold beams, not more than eight feet apart from center to center, taking over six heights of barrels must lay a temporary between-deck with two and a half ( $2\frac{1}{2}$ ) inch planks, with the ends interlocked, not less than nine inches in width directly under the bilge of the barrels fore and aft, from side to side.

"If the beams are closer than eight feet, then two or two and a half inch plank laid on the beams may be used, from side to side.

"Where the beams are farther apart than eight feet, heavier material in proportion must be used, all to be regulated by the surveyor.

"A stanchion well secured at both ends must be under each between-deck beam.

"Stowage of Oil in Cases.—In loading ships with full cargoes of petroleum in cases, it will be required to fill the forward and after ends of the between-decks, full or nearly full, according to the trim of the ship, and not to leave spaces there in order to raise the tiers higher by stowing cases on the flat, especially where the

upper tier beam fills or comes near to the deck above. Should the ship prove to be tender, then the top tier, or a part of it, should be left out. It is imperative that the cases be kept as low as possible, so as not to destroy the stability of the ship, especially those that have nearly perpendicular sides and deep holds.

“The ballast should not be trimmed in the run of the ship, abaft the two after stanchions, higher than one step for cases above the ground tier, and from thence forward. If the ballast does not cover the floor forward, do not use wooden dunnage forward of the ballast, but stow the cases over one tier of boards, as it only requires sufficient protection to prevent any vice remaining on the cargo platform from staining the cases, which would injure their commercial value at the port of destination. Any excess of ballast should be stowed in the cantlines between the cases and the bilges as far forward as practicable. The sides of the cases are to be protected by boards set up against the sides of the cases.

“The space under the cargo platform between the frames should be carefully filled with ballast, whereby greater stability of the ship would be secured when loaded. The first tier must be properly cross-boarded before the second tier is laid.

“No case should be allowed to rest its weight by its sides, but must rest easy in its position. All cases must be stowed with tops up.

“All places of broken stowage must be filled with wood or other proper dunnage cut the length of the case. The dunnage must be clean and dry.

“The amidship part of the tiers must be kept up to prevent sagging, and the ends of the cases must not lap over and rest on the next tier.

“In stowing cases on a laid between-deck, laths should be laid under them to protect them from stains.

“After the cases are stowed as high as the turn of the bilge, laths must be nailed on the sides, both above and below the beams, or the between-decks, to prevent the cases from being stained or chafed.

“Vessels with between-deck beams, if over fifteen feet depth of lower hold, will be required to lay a between-deck with two and a half (2½) inch planks, not less than nine inches in width, with the ends interlocked from side to side to prevent shifting.

“The draft of water will be given by the surveyor.

“When one or more holds and 'tween-decks are completely filled

with oil and gasoline, naphtha and/or benzine, 8,000 cases of gasoline, naphtha and/or benzine will be allowed as the maximum amount to be carried under deck of any one general cargo steamer, it being understood that when 8,000 cases have been loaded in a hold, no gasoline, naphtha and/or benzine can be carried in any other inclosed space, whether that space be a poop, bridge, fore peak or otherwise.

"Any amount consistent with proper stowage and the stability of the steamer can be carried on the open deck." See also U. S. Steamboat-Inspection Rules.

**Grain Cargoes.**—The structural features of a steamer carrying grain in bulk are practically similar to those of a steamer for general cargo in the sense that no close riveting (as for oiltightness for tankers) nor special requirements are called for by Lloyd's or the American Bureau of Shipping.

Grain cargoes have a tendency to settle down during a voyage, leaving empty spaces directly under the deck. These spaces have been estimated at 5 to 8% of the depth of the hold. After the grain has settled, its upper surface as the vessel rolls tends to become parallel with the slope of the wave, with the result that if the rolling is heavy the grain will shift, giving the vessel a list. On the friction of the particles of grain on each other depends the angle at which the sliding will take place, which varies with different grain, as wheat, corn, etc., each have a different angle of repose.

An investigation made by Prof. Jenkins showed that in a vessel rolling at sea, the angle at which the cargo begins to shift is less than the still water angle of repose. In the case of grain with an angle of repose of 25°, it was found that shifting began at 16½°. Prof. Jenkins showed further that the smaller the angle at which sliding begins, the greater is the stability, but at the same time pointed out that the effect of a shift of cargo is more serious in a vessel of small stability than in one with large.

Another point in carrying grain in bulk is that it must be kept absolutely dry, for when water comes in contact with it, it swells and has been known to burst the decks of steamers.

The Board of Underwriters of New York have issued rules, which are given below, for loading grain, and these rules have received the concurrence of the Board of Trade, London.

"1. The freeboard shall be measured from top of deck at side of the vessel to the water's edge at the center of the load water line; vessels having freeboards assigned by the rules of the Board of

Trade (Marine Dept.), London, shall not be loaded deeper than permitted by those rules.

"2. Shifting boards except as provided for in Rule 11, must extend from the upper deck to the floor when grain is carried in bulk, and must be grain tight, with grain tight fillings between the beams, and are to extend to the top of all amidship feeders. When grain is carried in bags the shifting boards must extend from deck to deck in the between-decks, and not less than four feet downward from the beams in the lower hold.

"3. Shifting boards referred to in all rules shall be of two (2) inch yellow pine, or of three (3) inch spruce or equivalent.

"4. All hatch feeders and end bulkheads must be boarded on the inside.

"5. The grain must be well trimmed up between the beams and in the wings, and the space between them completely filled.

"6. No coal shall be carried on deck of steamers sailing between the 1st of October and the 1st of April beyond such a supply as will be consumed prior to vessel's reaching the ocean.

"7. Care must be taken that when grain in bags or other cargo is stowed over bulk grain, the bulk grain must be covered with two thicknesses of boards placed fore and aft and athwartships, with space between the lower boards of not more than four (4) ft., and between the upper boards of not more than nine (9) ins. Care must be taken that all the bags are properly stowed, in good order, and well filled and that the tiers are laid close together.

"8. Grain in poop, peaks and/or bridge deck must have such grain in bags and have proper dunnage and shifting boards.

"9. Steamers having water ballast tanks must have them covered with a grain tight platform made of 2½ or 3 inch sound and dry planks, but this platform may be dispensed with where the tops of the tanks are of heavy plates and precautions are taken against overflow from the bilges.

"10. Steamships without ballast tanks, having a cargo platform in good order, will not be required to fit a grain floor over it, otherwise such grain floor will be required.

"11. Steamers loading small quantities of grain in lower holds, not more than one-third (⅓) of the capacity of a compartment, will not be required to have shifting boards. The grain must have the proper separations as provided for in Rule 7, and be secured with cotton or other suitable cargo.

"12. Single deck steamers with a continuous hold forward will



be required to have a closed bulkhead to divide the same. This rule will also apply to the after hold.

"13. Shifting boards must be properly secured to stanchions, or shored every eight feet of length and every five feet of depth of hold including hatchways. Shores to be three by eight ( $3 \times 8$ ) ins. or four by six ( $4 \times 6$ ) ins.

"14. No bulk grain or seeds in bulk (except oats and/or cotton seed, as provided in Rules 21, 22 and 23) to be carried in between-decks, nor where a ship has more than two decks, between the two upper decks, unless in feeders, properly constructed to fill the orlop and lower hold. Bulk grain may be carried on orlop or third deck below provided said orlop has wing openings and amidship feeders to feed same.

"15. Steamers with two or more decks not having sufficient and properly constructed wing and amidship feeders, will be required to leave sufficient space above the bulk in lower hold not less than 5 feet under deck beams to properly secure it with bags or other cargo, the bulk to be covered with boards as in Rule 7. If an orlop deck has sufficient openings to the lower hold the orlop and lower hold may be considered as one hold and loaded accordingly.

"16. Steamers having one deck and beams may carry bulk to such a height as will permit the stowage over it of not less than four (4) tiers of bags or other suitable cargo. All bags or other cargo to be stowed on two tiers of boards as provided for in Rule 7.

"17. Steamers with laid between-decks must have hatchway feeders, and if the distance in the lower holds, between the forward bulkhead in said holds and the nearest end of the hatchway feeders exceeds sixteen (16) feet (unless in the opinion of the surveyor the distance should be less) then vessel must have a wing feeder on each side provided in the between-decks to feed this space. If there are no openings in the between-decks for wing feeders, four (4) heights of bags must be put on top of the bulk grain from the bulkhead to within sixteen (16) feet of the feeders. The same rule applies when the distance between the after end of the hatchway feeders and the after bulkhead in lower holds exceeds sixteen (16) feet.

"18. Bags stowed or laid between decks must be dunnaged.

"19. Steamers of the type known as Turret with single deck or single deck and beams, may load full cargoes of grain in bulk but must have shifting boards as required in Rules 2, 3 and 13, and if required by surveyors trimming bulkheads forward and aft extend-

ing from deck to floor, or if coming under hatches to top of coaming as directed by the surveyor, and substantially fitted under their supervision. The loose grain in the end compartments to be secured by not less than four tiers of bags on boards properly laid as provided for in Rule 7.

"20. Steamers that are partly single deck and partly double deck known as switchback and as part awning deck steamers may load all bulk grain in the lower holds of their double deck compartments providing proper midship feeders and wing feeders are fitted, but the space in the between-decks around the feeders must be filled with bagged grain or general cargo, but if the vessel is too deep to carry any grain or other cargo in the between-decks the feeders are to be shored or properly secured to the satisfaction of the surveyor.

"If there are no openings in between-decks for wing feeders and the bulkheads are more than sixteen (16) feet away from the nearest end of the midship feeders four (4) heights of bags must be put on top of the bulk grain from the bulkheads to within sixteen (16) feet of the feeders, unless in the opinion of the surveyor the distance should be less.

"Bunker hatches may be used as feeders when feasible. The quantity of bulk grain in the feeders must be at least two and one-half per cent. ( $2\frac{1}{2}\%$ ) of the carrying capacity of the hold.

"21. Full Cargo of Oats and/or Cotton Seed. Steamers with double bottoms for water ballast may carry a full cargo of oats and/or cotton seed (except as provided for in Rule 8), but if with two or more decks must have tight wing and hatch feeders to feed the lower hold or orlop as provided for in Rule 17.

"22. Part Cargo of Oats and/or Cotton Seed. When the quantity of oats and/or cotton seed carried in bulk between the two upper decks exceeds 60% of the capacity of said deck, the excess over 50% may be stowed in bulk in compartments fitted with wing shifting boards extending from bulkheads at each end of hold to within four (4) feet of the hatches, one of such compartments shall be the largest between-deck compartment; or, where a steamer has four or more compartments in between-decks oats and/or cotton seed may be loaded in bulk in all of these compartments if they are provided with wing feeders of increased size to reach from the forward and after bulkhead to within four feet of hatches. The hatch feeders or feeders for lower hold must be capped box feeders, five or six feet in depth. All holds are to be so fitted.

"23. In single deck steamers oats and/or cotton seed may be loaded over heavy grain with proper separations in two holds, but the grain in all other holds must be properly secured with bagged grain or other cargo easily handled. This rule applies also to steamers where some holds are double and some single deck.

"24. Modern two-deck steamers with large trimming hatches may have properly constructed feeders, not to exceed twelve by sixteen feet.

"25. Stokehold bulkheads and donkey boiler recesses are required to be sheathed with wood and made grain tight, with an air space between the iron and the wood, when exposed to heat from fire room or donkey boiler. When already properly sheathed, surveyor may pass the vessel, but not unless nine inches of space will be required where the sheathing is to be erected or renewed. This rule applies where the fires are liable to cause damage by excessive heat from the stokehold or donkey boiler.

"26. Single deck steamers with high hatch coamings loading full or part cargoes of grain in bulk.

"a. The hatch coamings may be used as feeders and must be of sufficient size to admit of not less than two and one-half per cent. of the total grain in the hold being stowed within the coamings; otherwise the bulk grain must be secured by four heights of bags.

"b. When hatch coamings are utilized for feeders and such coamings extend into the hold a foot or more below the main deck such coamings, in the part below the deck, are required to have two (2) two inch openings in the coamings, between the beams, to allow the grain to feed into the wings and ends of the hold.

"c. The hatch coamings must be properly supported by heavy iron cross beams and fitted with fore and aft shifting boards.

"d. The hatch coamings must be so placed that they are capable of feeding the center and both ends of the holds.

"27. In the event of unusual construction of vessels which may necessitate deviation from the foregoing rules, the surveyor must obtain the approval of the Loading Committee of the Board."

For single deck ships, according to the Board of Trade (British), there shall be either provision for feeding the hold, or there shall not be more than three-quarters of the hold occupied by grain in bulk, the remaining one-quarter being occupied by grain or other suitable cargo in bags, bales, or barrels, supported on platforms laid on the grain in bulk. For ships with two decks, grain in bulk in the 'tween-decks is for the most part prohibited, but certain grains are

allowed provided there are separate feeders for the holds and 'tween-decks, or else sufficiently large feeders to the 'tween-decks, and the hatches and other openings there made available for feeding the holds. In ships with two decks, longitudinal grain-tight shifting boards must be fitted where grain is carried either in bags or bulk, these shifting boards extending from beam to deck and from beam to keelson, and in the case of bulk grain must also be fitted between the beams and carried up to the very top of the space.

**Coal Cargoes.**—Coal is stowed to the shell plating, to the deck between the beams, and to the bulkhead plating between the stiffeners. Although coal is a movable material and will shift on excessive rolling of a vessel, yet it has a larger angle of repose than grain, and can thus be considered a safer material to carry. In any case the bunkers (reference is here meant to those not carrying coal for the boilers) should be entirely filled, leaving no space between the top of the coal and the under side of the deck, so that the coal will not shift when the steamer is rolling.

Attention should be called to the effect of using bunker coal on the stability. In preparing the design of a steamer care must be taken that she has ample stability both with bunkers full and empty. In the case of some vessels, as the transatlantic liner *New York*, where the bunkers are carried to the upper deck, she gains in stability as the coal is burned and as she continues on her voyage, until near the end, for the center of gravity of the coal is above her center of gravity when leaving port with the bunkers full, and as the voyage progresses the coal is used; consequently its center of gravity is constantly being lowered until it is below the center of gravity of the ship. When about 70% of the coal is burned out in the *New York*, the height of the transverse metacenter above the center of gravity is a maximum, part of this height being due to the rise of the metacenter.

In some vessels the stability decreases as the coal is burned, and water ballast must be added to secure the necessary stability.

The Board of Underwriters of New York issue the following rules in regards carrying coal on deck for use as bunker coal from ports north of Hatteras to ports south of that latitude: "Steamers of the Three Deck rule and Spar Deck Vessels are permitted where the stability and spare buoyancy are guaranteed, to carry during the winter months, October 1st to April 1st, eight to ten per cent. of their net register tonnage of coal on deck for consumption during the voyage.

**Well Deck Steamers.**—If the coal is carried on the raised quarter deck the amount is not to exceed seven per cent. of the net registered tonnage, but if stowed over the bunkers on the bridge deck the amount not to exceed five per cent. of the net registered tonnage.

“Bulwarks to be sealed up leaving a clear water course to the scuppers and other openings. Steering gear to be free of any obstructions.

“Sufficient coal to be put in bags to secure the ends and cover the loose coal, the same not to be higher than the rail.

“Where suitable bins are provided of a moderate size the coal in bags may be omitted.

“Grain laden vessels are not permitted to carry coal on deck beyond sufficient to carry them to open sea. Vessels other than those described are to be submitted to the Loading Committee.”

**Lumber Cargoes.**—For carrying lumber in the coastwise trade schooners are largely employed, but for long routes as from the Pacific to Atlantic ports via the Panama Canal steamers are used. In schooners the lumber is carried both in the hold and on the deck, while in steamers usually in the holds with perhaps a small deck load. When the lumber is mixed, satisfactory conditions as to stability can be obtained by the proper distribution of the light and heavy lumber, and winging out the weights as previously mentioned.

Steamers engaging in the lumber trade should be broad in proportion to their draft thus giving a fairly high position of the meta-center and sufficient margin of stability without resorting to ballast, particularly when carrying a heavy deck load. Such a deck load, if well fastened in place, gives valuable surplus buoyancy. On the Pacific Coast the deck load is secured by chains fastened to the sheer strake and extending over the load from side to side with turn-buckles to take up the slack.

The Board of Trade (British) imposes a fine not exceeding £5 for every 100 cu. ft. of wood carried as deck cargo which arrives in a ship, British or foreign, in any port of the United Kingdom between October 31 and April 16, provided no unforeseen circumstances, as defined in the Merchant Shipping Act of 1906, intervene. By “deck cargo” in the above sentence is meant any deals, battens, or other wood goods of any description to a height exceeding 3 ft. above the deck.

For Carrying Horses and Cattle shelter deckers are particularly

suitable. The U. S. Department of Agriculture publishes a special circular on the subject. For weights and costs see page 330.

For Loading Calcium Carbide, which must be done under the supervision of a surveyor, see Regulations issued by the Board of Underwriters of New York.

**Regulations for Carrying Dangerous Articles** (Sec. 4472, U. S. Steamboat-Inspection Rules, 1915).—"No loose hay, loose cotton or loose hemp, camphene, nitroglycerin, naphtha, benzine, benzole, coal oil, crude or refined petroleum or other like explosive burning fluids or like dangerous articles, shall be carried as freight or used as stores on any steamer carrying passengers; nor shall baled cotton or hemp be carried on such steamers unless the bales are compactly pressed and thoroughly covered and secured in such manner as shall be prescribed by the regulations established by the board of supervising inspectors with the approval of the Secretary of Commerce, nor shall oil of vitriol, nitric or other chemical acids be carried on such steamers except on the decks or guards thereof or in such other safe part of the vessel as shall be prescribed by the inspectors.

"Refined petroleum, which will not ignite at a temperature less than 110° F., may be carried on board such steamers upon routes where there is no other practical mode of transporting it, and under such regulations as shall be prescribed by the board of supervising inspectors; and oil or spirits of turpentine may be carried on such steamers when put up in good metallic vessels or casks or barrels well and securely bound with iron and stowed in a secure part of the vessel; and friction matches may be carried on such steamers when securely packed in strong, tight chests or boxes, the covers of which shall be well secured by locks, screws or other reliable fastenings, and stowed in a safe part of the vessel at a secure distance from any fire or heat. All such other provisions shall be made on every steamer carrying passengers or freight, to guard against and extinguish fire, as shall be prescribed by the board of supervising inspectors.

"Nothing in the foregoing or following sections of this Act shall prohibit the transportation by steam vessels of gasoline or any of the products of petroleum when carried by motor vehicles (automobiles) using the same as a source of motor power; Provided, however, that all fire, if any, in such vehicles or automobiles be extinguished immediately after entering said vessel, and that the same be not relighted until immediately before said vehicle shall

leave the vessel; Provided further, that any owner, master, agent, or other person having charge of passenger steam vessels shall have the right to refuse to transport automobile vehicles the tanks of which contain gasoline, naphtha or other dangerous burning fluids.

"Provided, however, that nothing in the provisions of this Title shall prohibit the transportation by vessels not carrying passengers for hire, of gasoline or any of the products of petroleum for use as a source of motive power for the motor boats or launches of such vessels. Provided, further, that nothing in the foregoing or following sections of this Act shall prohibit the use by steam vessels carrying passengers for hire, of lifeboats equipped with gasoline motors, and tanks containing gasoline for the operation of said motor-driven lifeboats; Provided, however, that no gasoline shall be carried other than in the tanks of the lifeboats; Provided further, that the use of such lifeboats equipped with gasoline motors shall be under such regulations as shall be prescribed by the board of supervising inspectors.

"Nothing in the foregoing or following sections of this Act shall prohibit the transportation and use by vessels carrying passengers or freight for hire of gasoline or any of the products of petroleum for the operation of engines to supply an auxiliary lighting and wireless system independent of the vessel's main power plant; Provided further, that the transportation or use of such gasoline or any of the products of petroleum shall be under such regulations as shall be prescribed by the board of supervising inspectors with the approval of the Secretary of Commerce."

**Machinery Operating.**—See Index.

## MAINTENANCE

### *Hull*

In General, on the maintenance of a vessel largely depends not only her class with the classification societies, but also the rate given to her by the marine insurance underwriters.

Lloyd's Rules state: "Vessels intended for classification in the Register Book are to be built under the Society's special survey, and vessels so built will be entitled to the mark  $\frac{1}{2}$  in the Register Book. To entitle steel vessels to retain the characters assigned to them, they are required to be subjected to periodical special surveys designated No. 1, No. 2 and No. 3. These surveys become due in the cases of vessels classed 100A or 90A at 4, 8 and 12 years

respectively from date of build, and subsequently at the expiration of like periods from the date recorded in the Register Book of the previous special survey No. 3. Vessels class A for special purposes are required to be subjected to special surveys No. 1, No. 2 and No. 3, at 3, 6 and 9 years respectively from date of build, and at the expiration of like periods from the date recorded in the Register Book of the previous special survey No. 3."

The American Bureau of Shipping Rules state: "Vessels of the highest class (A1 for 20 years) must be surveyed five years from date of launching and every four years thereafter. Those of the second class (A1 for 16 years) and third class (A1 for 12 years) built under special survey and all others at the expiration of four years from date of launching, and every three years thereafter."

Attention should also be called to the navigation laws of the United States pertaining to American ships, as per the following rules: "The local inspectors shall once in every year, at least, carefully inspect the hull of each steam vessel within their respective districts, and shall satisfy themselves that every such vessel so submitted to their inspection is of a structure suitable for the service in which she is to be employed, has suitable accommodations for passengers and crew, and is in a condition to warrant the belief that she may be used in navigation as a steamer, with safety to life, and that all the requirements of law in regard to fires, boats, pumps, hose, life preservers, anchors and other things are faithfully complied with; and if they deem it expedient they may direct the vessel to be put in motion, and may adopt any other suitable means to test her sufficiency and that of her equipment. The local inspectors shall once in every year, at least, carefully inspect the hull of each sail vessel of over 700 tons carrying passengers for hire and all other vessels and barges of over 100 tons burden carrying passengers for hire within their respective districts. Vessels while laid up and dismantled and out of commission may, by regulations established by the Board of Supervising Inspectors be exempted from any or all inspection as outlined above and in sections 4418, 4426 and 4427.

"The local inspectors of steamboats shall at least once in every year inspect the hull and equipment of every seagoing barge of 100 gross tons or over, and shall satisfy themselves that such barge is of a structure suitable for the service in which she is to be employed, has suitable accommodations for the crew, and is in a condition to warrant the belief that she may be used in navigation



with safety to life. They shall then issue a certificate of inspection in the manner and for the purposes prescribed in sections 4421 and 4423 of the Revised Statutes of the U. S. Every such barge shall be equipped with the following appliances of kinds approved by the Board of Supervising Inspectors. At least one lifeboat, at least one anchor with suitable chain or cable and at least one life preserver for each person on board."

**Details.**—When the outside plating has butt straps instead of lap butts the bilge strake butts may show signs of working, with the result the plates are slightly drawn apart, and in the opening thus formed corrosion begins. To prevent corrosion, the seam should be filled with metal packing or cement, or if the plates are badly corroded an additional butt strap should be riveted on the outside.

Due to the straining of a vessel in a seaway, the wood deck may begin to leak, in which case the plank seam or seams in way of the leak should be caulked from butt to butt. An easy way to tell if a deck leaks is to watch it drying after it has been well flushed with water.

Particular attention should be paid to the bilges, for here water, parts of the cargo, and rubbish are found. This combination of refuse corrodes the margin plate and the shell plating, as also the frames. To prevent this waste material from getting into the bilges, steel plates may be riveted to the reverse frames or wood ceiling fastened thereto, in which are hatches for giving access to the bilges.

The fore and aft peak tanks should be kept dry as far as possible, and be ventilated. If the tanks are used for trimming, then all crevices should be filled with cement or painted with a bituminous compound.

The proximity of certain metals (brass or copper) to iron or steel may set up galvanic action when in salt water. Hence with bronze propellers or with brass stern bearings, unless zinc strips are fastened to the stern frame severe pitting of the sternposts may result.

To prevent galvanic action between the shell plating and sea valves, cast zinc rings are fastened in the apertures of supply and discharge pipes below the water line. The composition fittings which pierce the hull below the water line might be coated with an enamel paint that is impervious to sea water, so that when the valves are closed there will be no action between them and the shell plating.

The corrosion throughout the double bottom is comparatively slight except under the boilers. Here the heat from them and the moist stagnant air create a condition that is favorable to rapid corrosion. Thus the tank top plating is increased in thickness under the boilers by the rules (Lloyd's, British Corporation, etc.), and furthermore the compartments should be well ventilated if possible. In laying out the boiler room, the boilers should be a sufficient height above the tank top for easy access.

The floors and longitudinals may be covered with a bituminous compound or special paint, some shipyards galvanizing the boiler room floors.

In making a hull survey, the condition of the coal bunker bulkheads should be noted, particularly around the boilers, for coal when loaded wet into a hot bunker gives off acids that attack and eat away steel plates and angles.

The lifeboats should be swung out at regular periods or at least their blocks and tackles should be gone over, as well as the rigging.

When a vessel is docked her sea valves should be opened up and stern bearings examined to see if they have been worn down. If the bearings have been worn down, then new strips of lignum vitæ should be put in them. The rudder bushings should also be examined, and the coupling bolts on the palm.

To protect the nuts on the bolts securing the propeller blades to the hub, the nuts are often covered with cement.

When in dry dock the plugs in the shell plates on the bottom should be unscrewed so that water can be drained from the inner bottom, or if a vessel has no such plugs then a few rivets should be drilled out.

Painting, see page 279.

**Docking.**—The number of times a vessel is docked in a year depends on the water in which she runs; in the tropics perhaps once every six months; elsewhere it may be once a year.

Prior to docking a vessel a docking plan should be given to the dock superintendent if he is not familiar with the underwater form of the vessel. The plan consists of a longitudinal section with the transverse bulkheads and engine and boiler spaces indicated as well as the sea connections. At various points cross sections are taken showing the form of the vessel, from which can be determined the blocking required. Before a vessel enters a graving dock, care must be taken that the dock is large enough for

the vessel to float in, and that there are no projections at the entrance to foul or damage her.

▶ The longitudinal spacing of the keel blocks is generally 3 to 4 ft. apart, but the distance depends on the weight of the vessel per foot, some requiring additional shoring at the bilges. In one with a considerable part of the keel not in a straight line, the blocks must be close together at the ends and additional ones placed to take the overhang. Side blocks should come under all parts where the weights are concentrated, but they must not interfere with the sea connections. Sometimes in graving docks side shores are necessary, that is, shores from the sides of the vessel to the walls of the dock. In floating docks such shores are not possible and instead the side blocks are placed nearly to the turn of the bilge of the vessel.

### *Machinery*

No matter how careful a company may be in watching the consumption of coal, oil, and other supplies, all the money so saved can easily be wiped out if the many little repair jobs are not promptly looked after, if possible at sea, or reported when the vessel arrives at port so that they can be attended to then.

The above applies to both the hull and the machinery but particularly to the machinery. Some steamship companies insist that everything that is broken or missing must be reported to the shore superintendent, with the result that the repair bills for the annual overhaul are kept at a minimum and the vessels are in good condition all the time. All minor repairs should be attended to at once, as, for instance, if a boiler seam begins to leak, promptly caulk it, or if a pipe flange starts leaking, at the first opportunity tighten up the bolts or put in a new gasket.

In making out requisitions or specifications for repairs state exactly what is to be done. Instead of calling for a general overhauling, say, of a pump, itemize, as, for example, if the valve stems need renewing, or the water cylinder should be rebushed.

Lloyd's Rules state in part: "The machinery and boilers of all steamships and the donkey boilers of sailing vessels are to be surveyed annually if practicable, and in addition are to be submitted to a special survey upon the occasions of the vessels undergoing the special periodical Surveys 1, 2 and 3 prescribed in the Rules, unless the machinery and boilers have been specially surveyed within a period of 12 months. The tail shaft is to be exam-

ined annually and drawn at intervals of not more than two years. On the application of owners, the Committee will be prepared to give consideration to the circumstances of any special case."

The U. S. Steamboat-Inspection Rules state "that if the tail shaft has a complete brass bushing the shaft can go for 3 years without being withdrawn for examination."

Quoting from the American Bureau of Shipping: "When periodical surveys are made, all the principal working parts of the machinery are to be carefully examined. Propeller shafts and bushes are to be drawn for examination at least once in every two years, and the adjustment and condition of all cranks and crank pins, journals, couplings, etc., should be carefully examined. The periodical surveys of machinery should as far as possible be made to conform with the periodical surveys of the hulls. In no case, however, will the time between the surveys of machinery exceed that prescribed for the hulls."

By taking indicator cards of the engine, these will give information if the valves are correctly set. The cylinder covers should be removed every three or four months and the inside of the cylinders examined, as also the piston rings. A little vaseline or graphite in the cylinders tends to make a good wearing surface. The thrust collars should be looked at as also the main engine bearings and the oiling system.

If any of the steady bearings have been running hot, perhaps the shafting is out of line, which should be checked up when the vessel is in port. Hot bearings in most cases are due to the cap being set up too tight, or insufficient lubrication. If a bearing is running hot, give it plenty of oil, and if it still continues to run hot, slack off the nuts. As a last resort use the water service, and then just enough water to keep down the heat.

The water ends of air, feed, and bilge pumps should be examined frequently to see that the valves have not become excessively worn or the springs broken.

The life and efficiency of the boilers depend on the care taken of them. The water should be kept at a constant height above the crown sheet, and furthermore the fires should be cleaned at regular periods (see Overhauling Boilers). Only in case of necessity should the engine be suddenly reversed or the throttle closed quickly, for by so doing there is caused a sudden back pressure in the boiler and piping. To prevent galvanic action, zinc plates are placed in baskets inside the boiler, or compounds used in the feed water.

**ENGINE**  
Time Account per S. S.

When a voyage is in progress, one of these to be filled out, and on the completion of the voyage, to be signed by the Master and sent to the home office. Under the head of remarks, state the cause of long passages, of detention in any port, and any other matter it is as well that Charterer should know.

COAL ACCOUNT						
					Tons	Quality
<i>Coals remaining in bunkers on arrival at</i>						
<i>received at</i> .....						
" " " .....						
" " " .....						
" " " .....						
" " " .....						
" " " .....						
<b>TOTAL</b> .....						
Consumption		days steaming at		tons per day		
Average speed		per hour throughout		knots		
				tons		
Date	Distance Run per Day in Miles	Revolutions of Engine	Daily Consumption	Time and Cause of Stoppages	Remarks	
SUMMARY						
Coal received .....				Total	tons	
Consumed by main boilers .....				Tons	"	
" " donkey .....				"	"	
" " galley and ship .....				"	"	
Own use .....				"	"	
Remaining on board .....				"	tons	

In several sections are notes pertaining to the care of condensers, pumps, etc. (See Index.) Most companies require their engineers to keep a record of the coal consumed, revolutions of the engines, etc., as per form on page 703.

### CHARTERING

There are three ways of chartering a vessel: (1) individual trip charters; (2) contracts for the movement of some specified quantity of cargo in a stated period or number of trips; and (3) time charters.

(1) In trip charters it is generally agreed that the owners shall receive freight based upon some agreed rate on the cargo carried, for instance, so much per case of oil, or so much per ton of ore; or instead of such a rate some definite lump sum for a voyage.

Among other conditions that are settled in negotiations are the number of days to be allowed merchants for loading and discharging the cargo, these days being technically known as lay days, and it is also generally agreed that if the merchants delay the steamer beyond the number of lay days allowed they shall pay the owners a penalty, which is referred to as a demurrage, at some agreed rate for every day delayed.

In trip charters the loading port may be definitely named or the merchant may be given the option of loading at any one of several ports mentioned, orders for which port are to be given prior to the steamer's readiness to leave her last port of discharge; or it may be arranged that she is to proceed to some port of call for orders as to her loading port.

The discharging port may also be definitely agreed on, or the merchant may be given the right of ordering the steamer to any one of the various ports named for discharge, and it is sometimes agreed that the merchant may order the steamer to a second and possibly a third port of discharge by paying some agreed extra rate.

It is also arranged in negotiation just when the steamer is to be ready for loading; that is to say, two dates are mentioned between which the vessel must report. The first date is known as the date before which lay days cannot commence, so that if the steamer tenders any time before a certain date she cannot demand the cargo. The second date is known as the cancelling date. A clause is inserted in the charter reading: "Lay days are not to commence before \_\_\_\_\_ unless with the charterer's permission and should

steamer not be ready at loading port before ——— the charterers are to have the option of cancelling the charter."

(2) **Contracts for the Movement** of some specified quantity of cargo in a stated period or number of trips. This may be negotiated with owners who have a sufficient number of steamers to put out one at regular intervals for carrying a specified cargo, or a contract may be made with speculating contractors who hope to charter steamers from time to time as necessary and work out a profit, or a contract may be made for some definite steamer to make an agreed number of consecutive voyages.

(3) **Time Charter.**—In delivering the steamer the owners furnish her with a complete crew and thoroughly equipped and ready for business, but pay no expenses incidental with the loading and discharging of the cargo or going into or proceeding from ports, nor for the motive power for the vessel at sea, that is, the coal burned, but they must keep the steamer in good condition and furnish the necessary provisions, etc., for the maintenance of the crew, and the necessary stores for the proper upkeep of the steamer.

Besides the port of delivery being agreed on when the charter is negotiated, it is also stipulated what the period of charter shall be, where the vessel is to be redelivered by the charterers to the owners, and within what limits the charterers may employ the vessel, also the dates between which the vessel must be ready for delivery, and the rate of hire.

Thus the owners furnish the vessel and pay the crew's wages, provisions, and stores, and maintain the vessel in a thoroughly efficient condition, while the charterers pay practically all other expenses as for coal, various port charges as government dues, lighthouse dues, wharfage, stevedoring, loading and discharging the cargo, watchmen for the cargo, towages, pilotages, and also in some cases the marine insurance and the war risk.

[Above paragraph contains data from L. L. Richards of Bowling & Co., New York.]

**Charter Forms.**—A form of time charter used by the U. S. Navy Department is given below and illustrates in a general way time charter forms. It is, however, customary to insert a clause giving particulars of the steamer, as her gross and net tonnage, tons dead-weight including bunkers, cubic feet capacity in grain or bale measurement, bunker capacity, speed and coal consumption.

In the United Kingdom there are two forms, viz. Baltic and White Sea Conference Uniform Time Charter (1912), for European

Trade, and the Chamber of Shipping Time Charter (1902). The former is known by the code name *Balttime*, and contains a paragraph stating in part "that the steamer shall be redelivered at ice free port in charterer's option in the United Kingdom or on the Continent between Havre and Hamburg both included." On account of the war in Europe since 1915 this has been modified.

In the Chamber of Shipping Time Charter (1902), known as *Timon*, the redelivery port can be anywhere mutually agreed upon and there is a paragraph stating that "the charterers can require after a certain time (previously agreed upon) the owners to dry dock the vessel and paint her bottom." Printed forms of *Balttime* and *Timon* may be purchased, but because of the European War many special clauses are added.

#### CONDITIONS OF TIME CHARTER\*

1. Under this opening, tenders are also solicited for one to three vessels on time charter, for a period of from three to six months, at charterer's option; the following conditions to govern in the case of each vessel:

2. The vessel to be used for the transportation of/ or, at charterer's option.

3. Payment to be made at a flat rate per calendar day for the time actually under charter, payable at the end of each month or as soon thereafter as may be practicable.

4. Owners shall pay all charges and expenses incident to the operation and maintenance of the vessel, except the item of coal, in the case of which the charterers shall accept and pay for all coal in the steamer's bunkers at the commencement of the hire, and the owners shall, at the expiration of the charter, pay for all coal left in the bunkers, each at the current market price at the respective ports where the hire begins and ends. All coal used by the vessels for bunker purposes will be furnished by the charterer.

5. The only cost in connection with this charter to be borne by the charterer will be the per diem rate asked by the owners of the vessel, plus the cost of the coal consumed, necessary pilotage fees and, in the case of passage of the vessel through the Panama Canal, the usual canal tolls; all other expenses and charges to be defrayed by the owners. Expense of loading and discharging cargo to be borne by the charterer.

6. The charterer shall pay for the use and hire of the vessel commencing at seven A. M. on the first legal working day following the day of delivery at loading port (unless otherwise mutually arranged), the vessel then being ready to receive cargo and tight, staunch, strong and in every way fitted for the service, with a clean and clear hold, notice whereof to be given to the charterer before five P. M. on a working day. Hire to continue from the time specified for commencement of charter until the vessel's redelivery to the owners at a port to be agreed upon at the time of execution of contract. Owners to take all steps necessary for the proper care of vessels while under charter, with the understanding that the charterers are to repair proven damages caused through the charterer's

\* A form that has been used by the U. S. Navy Dept.



negligence or fault beyond ordinary wear and tear, but not to pay for time occupied by such repairs.

7. All steam winches and steamer's tackle to be at charterer's disposal at all times during loading and unloading, by day and night, and sufficient steam to be furnished to effectively run all winches at once. Steamer to work day and night, if required by charterers. Steamer to find sufficient competent men, at ship's expense, to tend winches or similar work, both day and night, if required. No overtime of any nature to be paid by the charterer. In the event of short steam or disabled winches or boilers, the owners to pay for such shore facilities as might be required to effectively load or discharge cargo.

8. The whole reach of the vessel's holds, decks and usual places of loading shall be at the charterer's disposal.

9. The owner shall be responsible that the vessel prosecutes its voyages with the utmost despatch and shall render all assistance with the ship's crew and boats; that the captain (although appointed by the owners) shall be under the orders and direction of the charterer and that if the charterer shall have reason to be dissatisfied with the conduct of the captain or any of the officers or crew the owners shall, on receiving particulars of the complaint, investigate the same and if charterer insists, make changes in the appointment.

10. The Master shall be furnished from time to time with all requisite instructions and sailing directions; shall keep a correct log of the voyage or voyages, which are to be patent to the charterer or its agents, and copy furnished if requested. When, on account of any accident to steamer or for any other reason the steamer shall be off hire, the Master shall furnish written advices to charterer whenever steamer is off hire, stating the cause of same, and when service is resumed, make special report to charterer, giving particulars of such time off hire and also advices of quantity of bunkers consumed during said period.

11. That any loss of time from deficiency of men or stores, or from any defect or breakdown of machinery, steering apparatus, etc., or damage from fire, collision, stranding or damage which prevents the working of or continuance on the voyage of the vessel for twelve hours or more shall be for account of owners and in such case the payment of hire shall cease from the commencement of the loss of time till she again resumes actual service for charterer, tight, staunch, and strong, and in every way fitted at the place of accident, or should the vessel put back from any of the above-mentioned causes or put into any other port than that to which she is bound, the hire shall be suspended from time of her putting back or putting in until she be again in the same position and the voyage resumed therefrom, and the pilotage fees at such port shall be borne by steamer's owners. Also, if any loss of time is incurred through fault of ship, after cargo and coals are on board, or cargo discharged and ship ready for sea as far as charterer is concerned and hour of sailing has been fixed by charterer and notice given to Captain, if he is on board, if not, to the officer in charge at the time, such lost time is to be for steamer's account; but should the vessel be driven into port or anchorage through stress of weather, or from any accident to the cargo, such detention or loss of time shall be at the charterer's risk and expense. If upon the voyage the steamer's speed be reduced by breakdown of machinery or other casualty, the time lost and the cost of the extra coal, if any, consumed in consequence thereof, shall be borne by the owners.

12. Charterer reserves the right to cancel this charter should steamer meet with any casualty causing her to be withdrawn from charterer's service temporarily or permanently. It is to be mutually agreed that this charter shall be sub-

ject to all the terms and provisions of and all the exemptions from liability contained in the Act of Congress of the United States approved on the 13th day of February, 1893, and entitled "An Act relating to navigation of vessels, etc."

13. Master to accomplish all bills of lading for cargoes delivered on board vessel, his signature being accepted as binding on the owners.

### *Notes on Chartering\**

1. The first point for owners is to stipulate for (a) delivery of the vessel being accepted where she lies, after completion of discharge, or dry docking and repairs, so that the vessel may be placed on hire forthwith without loss of time or expense incidental to a ballast shift, and (b) for redelivery at a safe (named) port, which will best suit the owners having regard to the subsequent employment in view.

The preamble clause of some time charter parties is so phrased and constructed as to constitute a warranty as regards (a) deadweight and measurement capacity, (b) speed, and (c) consumption. To obviate disputes, the general procedure is to state "the total deadweight about — tons on Lloyd's summer freeboard, inclusive of bunkers, stores, fresh water and equipment, and having about — cu. ft. grain, and — cu. ft. bale space (exclusive of permanent bunkers which contain about — tons) all as per builder's plan and capable of steaming about — knots per hour under favorable weather conditions on a consumption of about — tons of best Welsh coal per day of 24 hours."

Generally speaking the lower forepeak is reserved for the ship's stores, and part of the poop space may be encroached upon for storerooms or for crew or other purposes, and it is advisable to make that clear as the full measurement of these spaces are as a rule included in the builder's plan.

Hire is based on the total deadweight capacity of the vessel.

2. **Delivery; Commencement of Hire.**—Hire generally commences from the hour and date of the vessel being placed at the time charterer's disposal at such safe and suitable dock, wharf, or place immediately available, and written notice given within office hours. But some time charterers stipulate for hire not to commence for 24 hours (Sundays and holidays excepted) after written notice has been given, and even make full use of the vessel for loading purposes from the hour she is presented. Such a stipulation, being unfair and one-sided, should be eliminated, or in a case where that cannot

\* From *Shipping Illustrated*, New York.

be accomplished the words "unless used" should be inserted so that owners will be paid from the actual time at which loading commenced or use was made of the vessel before the expiration of the 24 hours.

3. **Redelivery Clause.**—Similarly the redelivery of the vessel should only be accepted between office hours and not during the night nor on Sunday or legal holiday, and that should be stipulated for in all time charter parties. It is the practice, where no provision is made, for the time charterer to redeliver the vessel at whatever time the discharge of cargo is completed or, in the case of a vessel in ballast, at the hour of her arrival at redelivery port. Owners are entitled to get redelivery of their vessel in the same good order (ordinary wear and tear excepted), with all holds swept clean, as she was when delivered.

4. In the preamble clause in certain time charters, "Vessel being in every way fitted for service," should be altered to read as "presently" fitted for ordinary cargo service, so that the liabilities and obligations of the owners and time charterer may be clearly defined and questions obviated.

5. **Trading Limits and Insurance Warranties.**—When, for a period of time, a time charter is entered into for employment of the vessel in lawful trades between good and safe ports or places, and the time charterer desires the widest limits, it is the rule to affix Owners' Insurance Warranties and Trade Restrictions, within which limits the vessel may be traded. But sometimes it arises during the currency of the charter that the time charterer may wish to employ the vessel outside these limits, in which case a mutual arrangement may be entered into.

Where an insurance warranty is absolute, as in the case of "No White Sea," for example, it is necessary for owners first to ascertain that such warranty will be cancelled for an additional premium, and to consider the extra risks to their vessel thereby involved, and to arrange a fixed additional payment of hire plus the extra premium to be paid by the time charterer.

6. **Speed and Consumption.**—A steamer's speed is dependent upon weather conditions and the steam-producing quality of the coal supplied by the time charterers. Allowance must be made for adverse weather conditions as a steamer cannot cover the ground and make the distance when the elements are battling against her.

Section 4286 of the United States laws governing Steamboat Inspection Service states: "The charterer of any vessel, in case

he shall man, victual and navigate such vessel at his own expense, or by his own procurement, shall be deemed the owner of such vessel within the meaning of the provisions of this title relating to the limitation of the liability of the owners of vessels; and such vessel, when so chartered, shall be liable in the same manner as if navigated by the owner thereof."

In grain freights the quotations are per quarter. The "net" freight is per ton of 20 cwt. on the quantity of heavy grain carried, or on the guaranteed deadweight of the steamer. The net register basis provides for the payment on the net register tonnage of the vessel.

Berth terms means that the steamer is to be loaded as fast as she can take in as customary at port of loading, and to be discharged as fast as she can deliver at port of discharge.

In grain freights, either on "berth terms" or on the C.f.o. basis, the quotations, unless otherwise stipulated, are for heavy grain of 480 lb. per qr., and if for oats 320 lb. per qr. From the Gulf ports tonnage is mostly fixed for grain on what is called the net form of open charter, which implies that all expenses at loading and discharging of the cargo are paid by charterers, so that the owners pay the working expenses of the boat, and what commission may be agreed upon.

Cotton rates are either quoted in so many cents per 100 lb. or in fractions of an English penny per lb. or on the net register basis.

"F.t." refers to ore charters, and means "full terms," that is, with despatch-money both ends.

Prompt means that the steamer is within a week or so of the loading port.

Spot signifies that the vessel is at the port of loading.

Gulf ports means the Gulf of Mexico, Port Arthur or Galveston to Tampa inclusive.

Dreading means option of shipping general cargo, charterers paying all extra expenses over and above a cargo of grain at loading port, and freight to be equivalent to what it would be with a full cargo of grain. This clause is sometimes stipulated to apply also to port of discharge, such as Dreading at both ends.

Form D is an American charter for cotton, etc. (freight paid on d.w., and steamer receiving lump sum for each day's loading).

Form O means that the freight is paid on the net register, and in consideration of owners paying charterers so much per net register

ton, mostly 2s. per ton, they pay stevedoring, compressing and port charges at loading port or ports.

**Anglo form** is a Chamber of Shipping charter on net register basis, which is generally considered to afford more protection in its conditions to owners, Form O being full of clauses more favorable to charterers.

**C.f.o.** means Cork (or Channel) for orders. For instance, C.f.o. 3s. 3d. means that if the boat is ordered to proceed to Cork for orders to discharge at a port in the United Kingdom or Continent, she gets 3s. 3d. if ordered from there to a U. K. port and 10% additional if to a Continental port; but if ordered direct from a loading port to the U. K. there is 3d. reduction, and if to the Continent, no reduction (3s. 3d.).

**Northern range** refers to the Atlantic ports, as follows: Portland, Boston, New York, Philadelphia, Baltimore, Newport News, Norfolk.

Boat loads, 8,000 bushels grain in canal boat.

D.l.o.—Dispatch loading only.

D.p.—Direct port.

D.w.—Deadweight.

E.C. Ireland—East Coast Ireland.

F.a.s.—Free alongside ship.

F.f.b.—Free of freight brokerage.

F.o.w.—First open water.

L.H.A.R.—London, Hull, Antwerp or Rotterdam.

No red B/Ch.—No reduction Bristol Channel.

O/C.—Open Charter.

O.T.—On track or railway.

"Pixpinus" (timber charters) is the official form agreed upon by owners and merchants for wood cargoes.

P.t.—Private terms.

Sun./ext.—Sundays excepted in lay days.

U.K.f.o.—United Kingdom for orders.

U.K.H.A.D.—United Kingdom, Havre, Antwerp or Dunkirk.

W.B.—West Britain.

W.C. England.—West Coast England.

### MARINE INSURANCE

A contract of marine insurance is a contract of indemnity whereby the insurer undertakes to indemnify the insured, in the manner and to the extent agreed, against marine losses, that is, the losses

incident to marine adventure. Unless specially mentioned in the policy, goods are not insured until they are on board the vessel which is to carry them. The following section contains abstracts from Sea Insurance by W. Gow.

**Insurable Value.**—Where no special contract is made between the insured and the underwriter the insurable value of certain matters of insurance is fixed by law as follows:

(1) **Ship.**—Her value at the commencement of the risk including outfit, provisions, stores, advances of wages, and any other outlays expended to make the ship fit for voyage or the period of navigation covered, plus the cost of insurance upon the whole.

The insurable value in the case of a steamship includes the machinery, boilers, coal, and engine stores if owned by the insured, and in the case of a ship engaged in a special trade, the ordinary fittings for that trade. Note that the policy on hull and machinery does not cover coal and stores.

(2) **Freight.**—Whether paid in advance or otherwise, the insurable value in the gross amount of the freight at the risk of the insured, plus the charges of insurance.

(3) **Goods or Merchandise.**—The insurable value is the prime cost plus expenses of and incidental to shipping and cost of insurance.

#### *Terms*

The term **ship** includes the hull, materials, and outfit, stores, and provisions for the officers and crew, and in the case of vessels engaged in a special trade, the ordinary fittings requisite for the trade, and also, in the case of a steamship, the machinery, boilers, coal, and engine stores if owned by the insured.

**Freight** includes the profit derivable by a shipowner from the employment of his ship to carry his own goods, as well as freight payable by a third party, but does not include passage money.

**Goods** includes goods in the nature of merchandise, and does not include personal effects or provisions and stores for use on board. In the absence of any usage to the contrary, deck cargo and living animals must be insured specifically and not under the general heading goods.

**Policies.**—The intending insured (principal or broker) offers the risk by showing to the underwriter a brief description of the venture, called in Great Britain a "slip" and in America an "application." The underwriter signifies his acceptance of the whole or

of a part of the value exposed to perils of the sea by signing the slip, and putting down the amount for which he accepts liability. From this slip is worked up the complete contract or policy.

The following five paragraphs must be specified in a marine policy:

1. The name of the insured or of some person effecting the insurance on his behalf.

2. The risk covered, that is, both the subject matter insured and the perils insured against.

3. The voyage covered or, in case of time insurance, the period of time during which the protection of the policy is to last, or if it is intended to cover not only a voyage but also a period of time, or a period of time succeeded by a voyage, then both must be distinctly specified.

4. The sum or sums insured.

5. The name or names of the underwriters.

Unless the policy otherwise provides, the insurer on ship or cargo is not liable for

Any loss proximately covered by delay, although the delay may be caused by a peril insured against;

Ordinary wear and tear;

Ordinary leakage and breakage;

Inherent vice or nature of the subject matter insured, i. e., as fruit rotting, meat becoming putrid, or flour heating not from external damage but solely from internal combustion.

The term "thieves" does not cover clandestine theft or a theft committed by one of the ship's company, whether crew or passengers.

Where goods are insured until they are safely landed, they must be landed in the customary manner, and within a reasonable time after arrival at the port of discharge, and if they are not so landed the risk ceases.

"Perils of the sea" refers only to fortuitous accidents or casualties of the sea. The damage caused by springing a leak is not a charge on the underwriters unless it be directly traceable to some fortuitous occurrence.

Where the leak arises from the unseaworthy state of the ship when she sailed, or from wear and tear or natural decay, and is only in consequence of that ordinary amount of straining to which she would unavoidably be exposed in the general and average course of the voyage insured, the underwriter is not liable.

A clause is often inserted in a policy admitting the seaworthiness

of the vessel for the purpose of the insurance. Where this is attached to a policy, it is a concession on the part of the underwriter that any leak arising must be from a peril of the sea.

The term "All other perils" includes only perils similar in kind to those insured against.

All risks of war are eliminated from the marine coverage, but this may be had separately with or without marine coverage. A marine coverage may be secured to protect any insurable hazard, but it is decidedly in order for the insurer to realize what risks he retains and what risks are covered by his contract.

There are different kinds of policies as:

**Voyage Policy**, in which the subject matter is insured at and from, or merely from one place to another place or places.

**Time Policy**, where the subject matter is insured for a period of time definitely specified.

**Valued Policy**, one which specifies the agreed value of the subject matter insured.

**Unvalued Policy**, one which is open to the insured to insure for a definite sum his interest in the subject matter of the policy without stating any value attributed by him to the subject matter.

**Floating Policy** describes the insurance in general terms and leaves the ship or ships and other particulars to be defined by subsequent declaration.

#### *Clauses and Terms Occurring in Policies*

**General Average (G. A.)**.—Suppose a vessel springs a leak, and to save her from sinking the captain throws overboard a portion of her cargo. The last shipment loaded is generally the first to come out.

If the shipment is fully insured the underwriters will pay the amount assessed against the goods, but whether the goods are insured or not the general average will make good to the owner the value of the goods which were jettisoned less the assessment which the owner is called upon to pay. It is safe to figure that all policies of insurance on goods cover and protect the merchant against assessments in general average.

A sacrifice to protect the ship alone or the cargo alone is not covered by general average. It is the opposite of an accidental loss caused by a maritime peril. A loss caused by water to extinguish a fire is general average, but not to the packages which themselves were on fire.



**Particular Average (P. A.)**—A particular average loss is a partial loss of the subject matter insured, caused by a peril insured against, and which is not a general average loss. Particular average, instead of being contributed for the general body of those who are interested in the adventure, falls entirely upon the owner of the property deteriorated by the damage.

**Particular Charges.**—Expenses incurred by or on behalf of the insured for the safety or preservation of the subject matter insured, other than general average and salvage charges, are called particular charges. Particular charges are not included in general average or particular average. They are covered in the policy by permission granted to sue, labor and travel in and about the defense, safeguard and recovery of the goods.

**Free of Particular Average (F. P. A.)**—Warranted free from average unless general, or the ship is stranded, sunk, burned, or in collision.

If the vessel is stranded the insurer has to pay particular average without regard to percentage and whether or not the damage is in any way attributable to the stranding. The damage to the goods may have occurred prior to the stranding or after the stranding, and from an entirely different cause, but providing they were on board at the time of stranding and the insurance was then in force, the damage is recoverable from the underwriters.

The same applies to "burnt, sunk, or in collision," but a vessel which might be on fire is not necessarily interpreted as burnt, nor is a fire confined to cargo covered, and the term "or in collision" is interpreted by the courts as if it read with another vessel, unless otherwise modified in the contract.

**Per cent. Particular Average Clause.**—"Subject to Particular Average if amounting to ——— per cent." The object of this limitation in amount is to prevent an endless amount of small claims which would involve expense of adjustment without due return. It is often modified to divide a single shipment into several units and becomes applicable to each.

**With Average (W. A.)** means that no claim will be made on the underwriters for partial loss caused by sea perils unless the damage amounts to 5% or more of the value of the shipment.

**F. A. A.** is an abbreviation of the clause "Free of all average."

**Foreign General Average (F. G. A.)** is a clause stating that general average and salvage charges are payable as per official

foreign statement if so made up, or per York-Antwerp rules if in accordance with the contract of affreightment.

**River Plate Clause.**—The risk under this policy shall cease upon arrival at any shed (transit or otherwise), store, custom house, or warehouse, or upon the expiration of 10 days subsequent to landing, whichever may first occur.

This clause is being quite generally insisted on by the companies, particularly on policies to Brazil, Buenos Aires, and the River Plate, as, owing to the large number and size of shore losses, the marine insurance companies do not care to assume the risk. To give more complete protection to shipper or to banks advancing money under credits, any marine policy bearing this clause should be accompanied by a fire floating policy covering from piers, in transit, and in custom houses for at least a minimum period.

**Protection and Indemnity Clause (P. and I.)** gives the insured additional protection against loss. It contains several paragraphs among which are the following:

"Loss or damage in respect of any other ship or boat or in respect of any goods, merchandise, freight or other things or interest whatsoever on board such other ship or boat caused proximately or otherwise by the ship insured in so far as the same is not covered by the running down clause hereto attached.

"Loss or damage to any goods, merchandise, freight or other things or interest whatsoever other than as aforesaid whether on board the said steamship or not, which may arise from any cause whatever."

The P. and I. clause adds about one-half of one per cent. to the ordinary rate.

**Collision or Ruling or Running Down Clause (R. D. C.)** is a clause in which the underwriters take a burden of a proportion, usually three-quarters of the damage inflicted on other vessels by collision for which the insured vessel is held to blame. Sometimes this clause is extended to cover the whole of the insured's liabilities arising out of the damage due to property by the collision of the insured vessel with another, and the clause is then known as the **Four-Fourths Running Down Clause.**

**F. C. and S. Clause.**—Free of capture and seizure.

**Inchmaree Clause.**—This covers loss of or damage to hull and machinery through the negligence of master, mariners, engineers, and pilots, or through explosions, bursting of boilers, breakage of shafts, or through any latent defect in the machinery or hull, pro-

vided such loss or damage has not resulted from want of due diligence by the owner or owners of the vessel or by the manager.

**Rates.**—The rate of insurance depends on the age and condition of the vessel, and if classed under Lloyd's, Bureau Veritas, and American Bureau of Shipping Rules. New vessels generally are given low rates, as 1%, while old 5% or over.

### EXPORT AND SHIPPING TERMS

**Bill of Lading (B. L.)** is a receipt for goods delivered to a carrier for transportation. The bills of lading of some steamship companies contain the following clause: "Freight is to be considered earned at time of receipt of shipment and is to be paid whether vessel or goods are lost or not." This clause in a bill of lading has been held to be valid by the courts. In accepting a bill of lading containing this clause the shipper guarantees to pay the freight charges whether the vessel or goods are lost or not, and consequently should add the amount of the freight to the value of the goods when making declaration to the underwriters. In foreign trade, bills of lading are generally made out in triplicate, one for the shipper, one for the consignee, and one retained by the master.

**Manifest.**—A document signed by the master of a vessel containing a list of the goods and merchandise on board, with their destination, for the use of the custom house officials. By U. S. Revised Statutes 2807, it is required to contain the name of the ports of lading and destination, a description of the vessel and her port, owners and master, names of consignees and of passengers, and lists of the passenger's baggage and of the sea stores.

**Bottomry.**—The borrowing of money and pledging the ship as security for repayment.

**Respondents.**—A loan made on the goods shipped.

**Salvage** is the reward granted by law for saving life and property at sea.

**C. F. or C. A. F. (Cost and Freight)** means that the seller furnishes the goods and pays the freight—no other expenses—to the port of destination. All risks while the goods are in transit are for the account of the buyer.

**C. I. F. (Cost, Insurance and Freight).** Here the seller furnishes the goods and pays the freight and insurance to port of destination, all other risks while goods are in transit being for the account of the buyer.

**F. O. B. Steamer (Free on Board).** The seller is to deliver the goods

aboard the steamer at the port of shipment in proper shipping condition; all subsequent risks and expenses are for account of the buyer.

**F. A. S. Steamer** (Free at ~~Side~~) means that the seller is to deliver the goods alongside steamer or lighter in the port of shipment or on receiving pier of the steamship company in proper shipping condition; all subsequent risks and expenses are for account of the buyer.

**F. F. A.** (Free from ~~Alongside~~), the shipper pays lighterage charges in the port of destination from the steamer. All further charges are for the account of the consignee.

**F. O.** (Free over Side). Without charges up to and including the unloading of a vessel.

**Demurrage.**—A charge for delay in loading or unloading a vessel.

**With Exchange**, on a draft, means that the cost of collection is to be added to the amount of the draft and paid by the party on whom it is drawn.

A vessel is said to be **Documented**, when a paper giving full particulars of her and the names of her owners is filed at the Custom House of the city which is her home port.

**Barratry.**—A wrongful act willfully committed by the master or crew to the injury of the owner or to the charterer of the vessel.

**Jettison.**—The throwing overboard of a part of the cargo or any article on board a ship, for the purpose of lightening her in case of necessity.

**Drawback.**—A drawback or refund of duties is when an imported material is used in the manufacture of domestic goods which is exported, the U. S. Government allowing the exporter the import duty paid, less one per cent.

**Lay Days** are the days agreed on by the shipper and master or agent for loading and discharging cargo and beyond which a demurrage will be paid to the vessel. Sundays and legal holidays do not count unless the term "running days" is inserted, in which case all days are included.

**Clearance Papers.**—When ready for sea the custom officials must be provided with a detailed manifest of the ship's cargo. If the port charges have been paid and her cargo is properly accounted for, then the collector of the port will furnish the master with clearance papers, without which the vessel must not leave port.

**Bill of Health** is a certificate stating that the vessel comes from a port where no contagious disease prevails, and that none of the passengers (if carried) or the crew at the time of departure was infected with any disease.

## AUTHORITIES QUOTED

The following list contains books from which abstracts were taken. The writer has endeavored to include all, but should any have been inadvertently omitted, they will be included in future editions of the present handbook.

- Ship Calculations and Construction. G. Nicol.
- Class book on Naval Architecture. W. J. Lovett.
- Text book on Naval Architecture. J. J. Welch.
- Theoretical Naval Architecture. L. L. Attwood.
- Modern Seamanship. A. M. Knight.
- Naval Construction. R. H. M. Robinson.
- Speed and Power of Ships. D. W. Taylor.
- Naval Architecture. C. H. Peabody.
- Design and Construction of Ships. J. H. Biles.
- Practical Shipbuilding. A. C. Holmes.
- Naval Constructor. G. Simpson.
- Steel Ships. T. Walton.
- Douglas Fir Shipbuilding. U. S. Forestry Service.
- Fighting Ships. Jane.
- Lloyd's Rules.
- Am. Bureau of Shipping Rules.
- Naval Reciprocating Engines. J. K. Barton and H. O. Stickney.
- Practical Marine Engineering.
- Design of Marine Engines and Auxiliaries. E. M. Bragg.
- Manual of Marine Engineering. A. E. Seaton.
- Marine Steam Engines. R. Sennett and H. J. Oram.
- Verbal Notes. J. W. M. Sothern.
- Marine Steam Turbines. J. W. M. Sothern.
- Engine Room Practice. J. G. Liversidge.
- Marine Engineering. A. E. Tompkins.
- McAndrew's Floating School. C. A. McAllister.
- Design of Marine Boilers. J. Gray.
- Care of Naval Machinery. H. C. Dinger.
- Marine Boiler Management. C. E. Strohmeier.
- Marine Steam. Babcock & Wilcox Co.
- Oil Fuel. Texas Co.
- Machinery's Handbook.
- Mechanical Engineer's Pocket Book. W. Kent.
- Am. Electrical Engineer's Handbook.
- Am. Civil Engineer's Handbook.
- International Correspondence School Handbooks, Scranton, Pa.
- Pocket Companion. Carnegie Steel Co.
- Cambria Steel Handbook.
- Naval Electrician's Handbook. W. H. G. Bullard.
- Cold Storage, Heating and Ventilating. S. F. Walker.
- Sanitary Refrigeration and Ice Making. J. J. Cosgrove.
- Heating and Ventilating. B. F. Sturtevant Co.
- Mechanical Draft. Am. Blower Co.
- Marine Propellers. S. W. Barnaby.

Screw Propellers. C. W. Dyson.

Naval Ordnance—a handbook used at U. S. Naval Academy.

Animal and Vegetable Fixed Oils and Greases. C. R. A. Wright.

Ship Wiring and Fitting. T. N. Johnson.

Standard Wiring. H. C. Cushing, Jr.

Sea Insurance. W. Gow.

Modern Seamanship. R. M. Knight.

Ship Forms, Resistance and Screw Propulsion. G. S. Baker.

Manual of Seamanship, published by the British Admiralty.

Handbook of the Lukens Iron & Steel Co.

Motor Boats. American Technical Society, Chicago.

Art of Estimating the Cost of Work. W. B. Ferguson.

In the handbook are quotations of articles published in International Marine Engineering, New York; Shipping Illustrated, New York; Marine Review, Cleveland, O.; Pacific Motor Boat, Seattle, Wash.; and Shipbuilder, London. Also from papers from Transactions of American Society of Naval Architects, Society of Naval Engineers and from the International Engineering Congress held in San Francisco in 1915.

Abstracts were made from catalogues issued by the following companies:

Ashton Valve Co., Boston, Mass.

American Steam Gauge Co., New York.

American Engineering Co., Philadelphia, Pa.

C. H. Wheeler Manufacturing Co., Philadelphia, Pa.

Worthington Pump & Engineering Co., New York.

M. T. Davidson Co., New York.

Hyde Windlass Co., Bath, Me.

Dean Bros. Steam Pump Co., Indianapolis, Ind.

Crane Co., Chicago, Ill.

H. G. Roelker (Allan dense air machine), New York.

Schutte & Koerting, Philadelphia, Pa.

General Electric Co., Schenectady, N. Y.

Carlisle & Finch Co., Cincinnati, O.

National Tube Co., Pittsburgh, Pa.

Griscom-Russell Co., New York.

Durable Wire Rope Co., Boston, Mass.

J. A. Roebling Sons Co., Trenton, N. J.

G. C. Moon Co., New York.

Baldt Anchor Co., Chester, Pa.

Power Specialty Co., New York.

J. H. Williams Co., Brooklyn, N. Y.

Ross Schofield Co., New York.

Dake Engine Co., Grand Haven, Mich.

Welin Marine Equipment Co., Brooklyn, N. Y.

Westinghouse Electric Manufacturing Co., Pittsburgh, Pa.

Eckliff Boiler Circulator Co., Detroit, Mich.

New London Ship & Engine Co., Groton, Conn.

Werkspoor-Diesel Engine Co., New York.  
J. L. Mott Co., New York.  
Ashwell & Nesbit, Ltd., Leicester, Eng.  
Am. Radiator Co., New York.  
C. W. Hunt Co., New York.  
Brunswick Refrigerating Co., New Brunswick, N. J.  
Bolinders Co., New York.  
Penberthy Injector Co., Detroit, Mich.  
A. B. Sands Co., New York.  
White Engineering Co., New York.  
Holtzer-Cabot Electric Co., Boston, Mass.  
Edison Storage Battery Co., Orange, N. J.

## INDEX

- Absolute pressure, 449  
Absolute zero, 344  
Admiralty bronze, 156  
Air, cooling by, 595  
  escape of, 583  
  for combustion, 353, 390  
  velocity of, escaping into the atmosphere, 390  
Air change, duct area for, 584  
Air ducts, 582  
Air pipes to inner bottom, 263  
Air pressure, 389, 421  
  measuring, 576  
Air pressure—water pressure, 577  
Air pump, 418, 458  
  types of, 459  
Air pumps, sizes of, 452, 460  
Alloys, copper, zinc, tin, 157  
Aluminum, 155  
American Bureau of Shipping, 235  
Ammeter, 543  
Ammonia, 591, 594, 597, 601  
  piping for, 527, 596  
Ammonia compressors, 597  
Ammunition, 245  
Ampere, 531  
Anchor cranes, 661  
Anchors, lifting speed, 625  
  tables of, 657  
  types of, 657  
Angle valves, 528  
Angles, sizes and weights of, 131, 133, 139  
Anthracite coal, sizes of, 351  
Apothecaries' weight, 1  
Ardois signals, 566  
Areas of plane figures, 33  
Armament, 245  
Armor, 244  
Armor backing, 244  
Armored cruisers, 248  
Asbestos, 163  
Ash ejectors, 384  
Atmospheric pressure, 344, 448  
Authorities, 718  
Auxiliaries, steam plant, 448  
Auxiliary drain, 602  
Avoirdupois weight, 1  
Awning deck vessels, 239  
  freeboard of, 206, 211  
Back pressure, steam engine, 396, 456  
Baltimore charter, 705  
Band edge flats, sizes of, 139  
Barge, 673  
Barges, wood, 282, 284  
Barrels, sizes of, 20, 355  
Bath tubs, 606  
Battens, cargo, 285, 288  
Batteries, electric, 554  
Battery cells, grouping of, 557  
Battle cruisers, 248  
Battleships, 247  
Beam, bending moment of, 76  
  moment of resistance of, 76  
  neutral axis of, 76  
  reaction of, 76  
  shearing stresses in, 77  
  strength calculation for, 76, 78  
Beams, deck, 265  
  deck, round of, 213, 265  
  deck, of wood vessels, 282  
  deflection of, 78, 84  
  I, H and bulb, 136, 138  
  loading of, 78  
Bearing surfaces, steam engine, 414  
Bearing, thrust, 418  
Bearings, line shaft, 418  
Beaumé gravity of oils, 354, 365  
Bell wires, 546  
Bending moments, curve of, 295, 299  
Bending pipes and tubes, 519  
Berths, 287  
Bessemer steel, 111  
Bilge ejector, 603  
Bilge keels, 264



- Bilge pumps, 603, 477  
 Bitt or bollard, sizes of, 98  
 Bitumastic enamel, 280  
 Bituminous coal, sizes of, 352  
 Block coefficient, 172  
 Block sheaves, number of, 654  
 Blocks, steel, 648  
   types of, 645, 647  
   wood, 648  
   working load for, 648  
 Blowers, 391, 580  
 Blow-off valves, 530, 378  
 Board measure, 8  
   in timber, 9  
 Board of Trade, 237  
 Boat davits, 673, 665  
   formula for, 98  
 Boat spikes, 293  
 Boiler, boiling out, 387  
   cleaning tubes of, 387  
   grate area of, 363, 364, 421  
   heating surface, 363, 364, 421  
   leg, 366  
   locomotive, 366  
   operating of, 385  
   overhauling, 386  
   return tube, 366  
   Scotch, heat distribution in, 375  
   shutting off, 386  
   washing out, 387  
 Boiler accessories, 376  
 Boiler circulators, 379  
 Boiler covering, 163  
   weight of, 307  
 Boiler efficiency, 374  
 Boiler feed pumps, 473, 475  
 Boiler feed water connections, 377  
 Boiler feeding, 478  
 Boiler firing, 385  
 Boiler fittings, 376  
 Boiler horse power, 371  
 Boiler horse power for an engine, 371  
 Boiler plates, 72  
 Boiler pressure, 364, 370, 421  
 Boiler rivet steel, 110, 72  
 Boiler room, draining of, 604  
   floor plates of, 125  
   length of, 305, 310  
   painting in, 281  
   ventilators to, 579  
 Boiler saddles, 277  
 Boiler scale, removing of, 388  
 Boiler tubes, tables of, 510, 511, 512  
 Boiler weights, 306, 308, 370  
 Boiler zinc strips, 701  
 Boilers, boiling out, 387  
   cleaning of, 387  
   cleaning tubes of, 387  
   life of, 701  
   oil for, 356  
   prices of, 337  
   types of, 363  
   water evaporated in, 371, 375  
   water tube, 369  
   weights of, 308, 370  
 Bolts, carriage, 132  
   in deck planking, 28  
   eye, tests of, 95  
   shearing and tensile strength of, 93  
   stove, 132  
 Bolts and nuts, 524  
 Boot top, 279  
 Bottom blow valve, 378  
 Bourdon tube, 378  
 Bower anchor, 659  
 Brake horse power, 22  
 Brakes, solenoid, 566  
 Bram, naval, 157  
 Brass pipe, 518  
 Brass sheets and plates, weights of,  
   126, 127  
 Brass tubes, 511, 514  
   working pressure formula, 518  
 Brass wood screws, 291  
 Brasses, 156, 71  
 Breadth, extreme, 166  
   molded, 166  
 Brine circulating system, 593  
 British Corporation, 236  
 British thermal unit, 341, 23  
 Bronzes, 156  
 Bulb angles, sizes and weights of, 139  
 Bulb beams, sizes and weights of, 138  
 Bulkheads, cabin and stateroom, 285  
   caulking of, 272, 321  
   fore and aft, 268, 299, 320  
   heat through, 567  
   painting of, 281  
   transverse, 268, 320  
 Bulwarks, 261  
 Bumpkin, 276  
 Bundling schedule for pipe, 20

- Buoyancy, center of, 172  
 Buoyancy curve, 295, 296  
 Bureau Veritas, 237  
 Bursting pressures of wrought iron tubes, 91  
 Butterfly valves, 529  
 Butt straps, riveting of, 106  
 Butt-welded pipe, 507  
 Butts, shell plating, 260
- Cabin bulkheads, 285  
 Calorie, 341  
 Calorifiers, 610  
 Camber, beam, 213, 265  
   launching ways, 228, 232, 233  
 Capstan, purchase on rope from, 63C  
 Capstans, 630  
 Carbonic anhydride, 564, 601  
   piping for, 596  
 Carbon steel, 112, 114  
 Carburetors, 482  
 Cargo battens, 285  
 Cargo steamers, data on, 310, 311  
 Cargoes, coal, 693  
   contracts for moving, 704  
   grain, 688  
   loading and stowing of, 683  
   lumber, 694  
   oil, 684  
 Carpenter work, 284  
 Carriage bolts, 132  
 Cast iron, 120, 71  
   columns, 85, 87  
 Cast steel, 118, 116, 72  
   wire rope, 639, 641  
 Cattle steamer, cost of fitting up, 331  
 Cattle steamers, fittings for, 330  
 Caulking, deck planking, 285  
 Caulking bulkheads, 272, 321  
 Caulking cotton, 162  
 Cavitation, 425  
 Ceiling, 285, 288  
 Cement, Portland, 162  
 Cement coating, 265, 278, 698, 699  
   *See also* Concrete  
 Center of buoyancy, 172  
   distance from metacenter, 176  
   fore and aft, 173, 178  
   height of, 179  
   from water line, 173
- Center of gravity, 80  
   of a ship, 200  
     effect of moving weights on, 203  
     heights of, 202  
     to find by moving weights, 204  
   of a ship's cross section, 50  
   of a water plane, 51  
 Centigrade thermometer, 25  
 Centimeter, gram, second system, 6  
 Centrifugal pumps, data on, 474, 475  
   priming of, 476  
   speed of, 476  
   types of, 474  
 Chain, steering, 624  
   strength of, 91, 655  
   table of, 656  
 Chain stoppers, 624  
 Chairs, 287  
 Channels, shipbuilding, 129  
 Charcoal iron boiler tubes, 512  
 Charter forms, 704  
 Chartering, ship, 703  
 Check valves, 529, 378, 471  
 Checkered steel plates, 125  
 Chemical analysis of coal, 351  
 Chill or cold test of oil, 356  
 Chromium nickel steel, 114  
 Chromium steel, 114  
 Chromium vanadium steel, 114  
 Circle, properties of, 32  
 Circles, tables of, 25, 29  
 Circuit breaker, 543  
 Circular measure, 3  
 Circular mil, 533  
 Circular ring, measures of, 36, 37  
 Circulating pumps, speed of, 462  
   sizes of, 452  
 Circulators, hoiler, 379  
 Classification societies, 234  
 Clinker plating, 259  
 Closets, 607  
 Coal, heat values of, 351  
   required to evaporate one lb. of water, 349  
   sizes, of anthracite, 351  
     of bituminous or soft, 352  
   value of, from its chemical analysis, 351  
 Coal cargoes, 693

- Coal consumption, 363, 421  
per i.h.p., 349, 350, 411, 443  
*See also* Trials
- Coal consumption and cylinder cut-off, 405
- Coamings, height of, 267  
side, 266
- Cocks, 528
- Coefficient, block, 172  
of elasticity, 70  
of fineness for freeboard calculations, 210  
of fineness of water plane, 171  
of midship section, 172  
prismatic, 171  
propulsive, 223
- Cofferdams, 320, 321
- Cold storage room, refrigeration for, 598
- Cold storage temperatures, 588
- Collapsing pressures of wrought iron tubes, 91
- Color of oil, 356
- Columns, 84  
cast iron, formulae for, 85, 87  
H and I sections, safe loads for, 86  
steel, formulae for, 84, 85  
wood, formulae for, 85, 87  
• safe loads for, 87, 88  
wrought iron, safe loads for, 88, 89
- Combustible, evaporation per lb. of, 350
- Combustion, air for, 353  
rate of, 350
- Combustion chamber, 363, 364
- Combustion chamber temperature, 393
- Companionways, 286, 287
- Comparison, law of, 226
- Compartment flooded, to find trim, 194
- Compound wound motors, 561
- Compression, 70  
materials in, 71  
system for refrigeration, 591
- Concrete, 73, 162, 278  
*See also* Cement
- Condensers, injection water for, 457  
jet, 450, 456  
keel or outboard, 459  
pressures in, 456  
steam temperatures in, 456  
surface, 450  
data on, 452, 421  
operating, 453
- Condensers, surface, velocity of injection water, 462  
thermodynamics of, 449  
types of, 450  
vacuum in, 455, 456
- Conduits, electric, 541
- Cone, measures of, 36
- Connecting rod, formula for, 413
- Construction, systems of ship, 253
- Controllers, electric, 565, 628
- Cooling coils, pipe for, 596
- Copper, 155, 71
- Copper pipe, 518
- Copper sheets and plates, weights of, 126, 127
- Copper tubes, tables of, 511, 513, 514, 519  
working pressure formula, 518
- Cork, insulating, 163, 587
- Cork paint, 289
- Corrosion, to prevent, 698
- Cosecant, of an angle, 40
- Cosecants, table of, 43
- Cosine of an angle, 40
- Cosines, table of, 43
- Cost of fitting up a cattle steamer, 331
- Cost of operating. *See* Operating cost
- Cost, parts of a motor boat, 337
- Costs, labor, 340  
of electric installations, 337  
of propelling machinery, 339  
of steam engines, 377  
of refrigerating systems, 337
- Cotangent of an angle, 40
- Cotangents, table of, 43
- Cotton, caulking, 162
- Cotton seed, cargo of, 691
- Coulomb, definition of, 531
- Couplings, pipe, 526
- Covering, pipe, 163, 165  
tank top, 263
- Coverings, deck, 264
- Cranes, anchor, 661  
stresses in, 98
- Crank sequences, 396
- Crew's quarters, painting in, 288
- Cross bunker, volume of, 38
- Cross curves of stability, 185
- Cross section, ship's, center of gravity of, 50

- Crucible steel, 111  
 Crude petroleum, 353  
 Cruisers, battle, 248  
   light, 248  
 Cube root, 27, 29  
 Cubes, of numbers, 29  
 Cubic capacity, 170  
 Cubic feet per ton of materials, 16  
 Curve, of bending moments, 295, 299  
   of buoyancy, 295, 296  
   of deadweight, 168  
   of displacement, 169  
   of loads, 295, 296  
   of shearing stresses, 295, 298  
   of tons per inch, 171  
   of weights, 294, 295  
 Curves, of stability, 183  
 Cut-off, steam engine, 395, 405  
 Cut-outs, electric, 546  
 Cutters, 673  
 Cylinder, covering of, 164  
   drains and relief valves, 415  
   measures of, 36  
 Cylinders, bursting formula for, 90  
   steam engine, formula for, 413  
   steam, pressure in, 404, 405  
 Dangerous articles, carrying, 605  
 Davits, anchor, sizes of, 660  
   boat, 673, 665  
   formulas for, 97  
   strength calculation for, 77  
 Deadweight, 169  
 Deadweight curve, 168  
 Decimal equivalents of fractions of  
   inch, 5  
 Decimals of foot, in inches, 10  
 Deck beams, 265  
   round of, 213, 265  
 Deck coverings, 264  
 Deck erections, 210, 277  
 Deck houses, 278  
 Deck planking, 284, 285  
   bolts for, 284  
 Deck plating, 264  
 Deep framing, 255  
 Density of oil, 355, 359  
 Depth, for freeboard, 208  
   of hold, 167  
   Lloyd's, 167  
 Derricks, stresses in, 98  
 Destroyers, torpedo boat, 249  
 Details, structural, 253  
 Diesel engines, 495  
   compression in, 480  
   data on, 316  
   fuel consumption, 495  
   installations of, 506  
   operating of, 499  
   operating cost of, 334, 335, 496  
   operation of, 496  
   types of, 501, 316  
   valves of, 499  
   weights of, 309  
 Differential pulley, 652  
 Dimensions, extreme of a ship, 168, 212,  
   294  
 Dinghies, 673  
 Discharge head, 471  
 Discharge from nosales, water, 612  
 Displacement, of a vessel when out of  
   trim, 192  
   of wood vessels, 282  
 Displacement calculation, 168  
 Displacement curve, 168  
 Displacement sheet, 177, 180, 181  
 Distributing systems, electric, 547  
 Docking, 699  
 Docking keels, 264  
 Doctor, 476  
 Double bottom, 261  
   corrosion in, 699  
   draining of, 604  
 Draft, 388  
   air for, 390  
   closed fireroom, 389  
   Ellis and Eaves' system, 389  
   at fan, 421  
   forced, installations of, 392  
   heat absorbed in creating, 389  
   Howden's system, 389  
   measurement of, 389  
   resistance of funnel to, 393  
   velocity of air, 390  
   *See also* Trials  
 Draft figures, 167  
 Draft of vessel, 167  
 Drainage systems, 601  
 Drains, cylinder, 415  
 Dredges, 327  
 Drum, rope capacity of, 628  
 Dry measure, 3

- Dry steam, 343  
 Duct area for air change, 584  
 Ducts, location of, 584  
     materials used in, 582  
 Duplex pumps, 474
- Eccentric rods, 403  
 Eddy making, 225  
 Effective horse power, 223, 225  
 Efficiency of steam, 342  
 Ejector, bilge, 603  
 Ejectors, ash, 384  
 Elasticity, 70  
     coefficient of, 70  
 Electric batteries, 554  
 Electric capstans, 630  
 Electric circuits, 547  
 Electric conduits, 541  
 Electric distributing systems, 547  
 Electric fittings, removable, 546  
 Electric heaters, 573  
 Electric heating, 573  
 Electric installations, costs of, 337  
     data on, 533  
     laying out, 544  
 Electric lighting, 541, 544, 547, 550,  
     552, 556  
 Electric motor circuit, size of wire,  
     539  
 Electric motor controlling devices, 565,  
     628  
 Electric motors, 547  
     calculation of horse power, 562  
     current required, 564  
     sizes of, 563, 564  
     types of, 561  
 Electric output, determination of, 543,  
     558  
 Electric propulsion, 444  
 Electric steering gear, 616, 564  
 Electric winches, 628, 564  
 Electric windlasses, 625  
 Electric wire gauges, 538  
 Electric wires, carrying capacities of,  
     534, 535  
     measurement of, 533  
     running of, 545  
     sizes of, 537  
 Electric wiring of gasoline engines,  
     551  
 Electric wiring of motor boat, 550
- Electric wiring of steamer, 547  
 Electric wiring, multiple, 557  
     systems, 539  
 Electrical and mechanical units, 23  
 Ellipse, properties of, 33  
 Ellipsoid, volume of, 38  
 Enamel, bitumastic, 280  
 Engelhardt collapsible lifeboats, 671  
 Engine, boiler horse power for, 371  
 Engine foundations, 277  
 Engine revolutions and speed of vessel,  
     224  
 Engine room, draining of, 604  
     length of, 305, 310  
     painting in, 281  
     ventilation, 579  
 Engine room floors, 419, 125  
 Engine room floor plates (i.e. under en-  
     gine), 258, 263  
 Engine weights, 305, 306  
 Engines and boilers, costs of, 339  
 Engines, Diesel, 495  
     hot bulb, 492  
     internal combustion, 478  
 Estimate for building a motor schooner,  
     334  
 Estimated horse power, 411  
 Estimates, preparing, 338  
 Evaporation, factor of, 373  
     per lb. of combustible, 350  
 Evaporators, sizes of, 469  
     steam for, 468  
 Excursion steamers, data on, 313, 314,  
     315  
 Exhaust relief valves, 530  
 Exhaust system, 576  
 Exhausters, 580  
 Exsecant of an angle, 40  
 Export terms, 716  
 Eye bolts, tests of, 95
- Factor, of evaporation, 373  
     of safety, 75, 518, 527  
 Fahrenheit thermometer, 25  
 Fan, horse power to drive, 582  
 Fans, 580  
 Farad, 531  
 Feed tank, 462  
 Feed water check valve, 378  
 Feed water connections for boiler, 377  
 Feed water filter, 464

- Feed water heaters, 465  
   fuel saved by, 467  
 Field rheostat, 543  
 Filler, wood, 288  
 Filter, feed water, 464  
 Filter tank, 462  
 Filtering materials, 463  
 Fire alarms, 614  
 Fire bars, weights of, 307  
 Fire bricks, weights of, 307  
 Fire extinguishing apparatus for oil carriers, 325  
 Fire extinguishing systems, 610  
 Fire main, steam, 612  
   water, 610  
 Fire point of oil, 356  
 Fire, temperature of, 353  
 Fire tube and water tube boilers compared, 370  
 Firing boilers, 335  
 Fittings for cattle steamers, 330  
 Flanges, pipe, 522, 528  
 Flash point of oil, 356  
 Flat sawing, 157  
 Flats, sizes of, 139, 140  
 Floating policy, 713  
 Floor plates, 256, 263  
 Floors, engine and boiler room, 419, 125  
 Flush deck vessel, freeboard of, 205, 210  
 Flush plating, 259  
 Food products, keeping of, 587  
   refrigeration to keep, 599  
   specific and latent heat of, 600  
 Foot pound, equivalent units of, 23  
 Forced draft, 398  
 Forgings, tests of, 113, 116  
 Foundations, boilers and engines, 277  
   capstans, windlasses, etc., 285  
 Fractions of inch, decimal equivalents of, 5  
 Frames, deep, 256  
   joggled, 256  
   reverse, 256  
   of wood vessels, 282  
 Framing, 255, 265  
 Freeboard, 205  
   of awning deck vessel, 206, 211  
   of flush deck vessel, 205, 210  
   of hurricane deck vessel, 220  
   of shelter deck vessel, 216  
 Freeboard calculations, 210, 213, 218  
 Freeboard curves, 209, 211  
 Freeboard markings, 221  
 Fresh water, 11  
 Fresh water heaters, 609  
 Fresh water service, 609  
 Friction of air in pipes, 585  
 Friction constants for ships, 227  
 Frictional resistance of ships, 225  
 Frustum, of prism or cylinder, 36  
   of pyramid or cone, 36  
 Fuel consumption, Diesel engine, 495  
 Fuel oil, data on, 354, 356  
 Fuel saved by feed water heaters, 467  
 Fuels, 349  
   for internal combustion engines, 478  
 Fumigating apparatus, 613  
 Funnel. *See* Stack  
 Furnace, temperature of, 393  
 Furnaces, 364  
 Fuse, 543, 549  
 Fusible plugs, 379  
  
 Galleys, 673  
 Galvanic action, to prevent, 608  
 Galvanising steel plates, 121  
 Gaskets, pipe flange, 526  
 Gasoline, 358  
 Gasoline engines, 479, 317  
   troubles with, 491  
   wiring of, 551  
 Gasoline engine generating sets, 559  
 Gate valves, 529  
 Gauge, vacuum, 454  
 Gauge pressure, 449, 344  
 Gauges, for plates and sheets, 125  
   standard, 123  
   steam, 378  
   for steel and iron plates, 124  
   water, 379  
 Geared turbines, 442, 445, 312  
   operating cost of, 496  
 Gearing, 148  
 Generating sets, 557  
   operating of, 560  
 Generators, location of, 544, 560  
 Geometrical propositions, 31  
 Gig, 673  
 Girders, side and center, 263  
 Globe valves, 527, 528  
 Grain cargoes, 688  
 Grapple anchor, 660

- Grate area, boiler, 363, 364  
 coal consumption, 421, 363
- Great Lakes Register, 237
- Ground detector, 543
- Grouping battery cells, 557
- Gross tonnage, 169
- Gunboats, 249
- Gun metal, 155
- Guy ropes, ships', 645  
 yacht, 643
- Gypsy capstan, 630
- Hair felt, 163
- Half rounds, sizes of, 137
- Hand pumps, 606
- Harbor vessels, 313, 314, 315
- Hardness of woods, 158
- Hard wood sizes, 159
- Hatch covers, 285
- Hatch openings, 267
- Hatchways, 266
- Hawfers, Manila, 636, 640, 631  
 steel, 644, 646, 631
- H beams, sizes and weights of, 138
- Heat absorbed in creating draft, 380
- Heat distribution in Scotch boilers, 375
- Heat, latent, of steam, 342  
 mechanical equivalent of, 341, 23  
 metric unit of, 341  
 specific, of superheated steam, 343  
 through pipe coverings, 165  
 through ship's side or bulkhead, 567  
 total of steam, 342
- Heat unit, 341, 23
- Heat value, coal, from chemical analysis, 351
- Heat values, of coal, 351  
 of oils, 356  
 of woods, 352
- Heaters, feed water, 465  
 fresh water, 609
- Heating, by electricity, 573  
 by steam, 568  
 by thermotanks, 571  
 special systems of, 574
- Heating surface, boiler, 363, 364, 421
- Heel of vessel lowering boat, 678
- Hemp, 634
- Hemp clad wire rope, 636, 637
- Henry, 531
- Hexagons, sizes of, 142
- Hitches, 633
- Hogging, 298
- Hoisting engines, 626
- Hoisting rope, data on, 632, 634  
 tables of, 638, 639
- Hold, depth of, 167
- Hold pillar, 268, 269
- Hole, water that will enter, 195
- Hooks, formula for, 91  
 tests of, 94, 96
- Horse power, estimated, 412  
 equivalent value of, 23  
 for fan, 582  
 for generator, 543, 558  
 for refrigerating machines, 595, 600  
 motors, calculation of, 562  
 to raise load, 628  
 to turn rudder, 623
- Horse power formulae, for internal combustion engines, 480
- Horse powers, definitions of, 22, 371
- Horses, fittings for, 330
- Hot bearings, 701
- Hot bulb engines, data on, 493, 494, 318  
 operation of, 492
- Hot well, 462  
 temperature in, 421
- Hull construction, 234
- Hull maintenance, 696
- Hull painting, 279, 288
- Hull specification headings, 300
- Hull survey, 696
- Hull weights, 303, 310  
 formulae for, 302  
 of oil carriers, 326
- Hurricane deck vessel, 239, 240  
 freeboard of, 220
- Hydrokinetometer, 379
- Hydrometer, 381
- I beams, sizes and weights, 136
- Ignition, electric, 486
- Ignition timing, 489
- Immersion, tons per inch, 170
- Incandescent lamps, 552
- Inch-millimeter table, 5
- Inches in decimals of foot, 10
- Indicated horse power, 22  
 calculation of, 410  
 coal consumption per, 350, 411, 421  
 for propulsion, 222

- Indicated horse power, steam consumption per, 342, 421  
     weight of machinery per, 304  
 Indicator cards, 406, 701  
 Induced draft. *See* Draft  
 Inertia. *See* Moment of  
 Injection water temperature, 421  
 Injectors, 380  
 Inner bottom, 261  
     oil carried in, 321  
 In and out plating, 259  
 Inspirators, 380  
 Installing pumps, 477  
 Insulation of refrigerating rooms, 587  
 Insulating materials, 162  
 Insurable value, 711  
 Insurance, marine, 710  
 Internal combustion engines, 478  
     cooling water for, 484  
     compression in, 480  
     electric ignition, 481, 486, 317, 320  
     fuels for, 478  
     horse power formulae for, 480  
     oils for, 357  
     operation of, 479  
     starting of, 482  
     valves of, 484  
 Interior decoration, 285  
 Interpole motors, 562  
 Iron, 119  
     cast, 120, 71  
     malleable, 121, 71  
     wrought, 120, 116  
 Iron plate gauges, 124  
 Iron rope, 639, 640  
 Iron wood screws, 290  
 Isberwood system, 253  
  
 Jet condensers, 450, 456  
     cooling water for, 457  
 Jiggers, 650  
 Joggled frames, 256  
 Joggled plating, 259  
 Joiner work, 284  
 Joule, 531, 23  
 Jump spark ignition, 551  
  
 Kedge anchor, 659  
 Keel blocks, 700  
 Keel condensers, 459  
  
 Keels, 264  
     bilge, 264  
     docking, 264  
     of wood vessels, 282  
 Keelsons, 263  
 Keg, number of screws in, 292  
 Kerosene oil, 478  
 Keys, 141, 430  
 Kilogrammeter, 23  
 Kilowatt, equivalent units of, 532, 23  
 Kingston valves, 530  
 Knot, 2  
 Knots, rope, 633  
  
 Labor costs, 340  
 Lag screws, number in keg, 292  
     sizes of, 289  
     tests of, 293  
     weight of, 292  
 Lagging, cylinder, 164  
 Lamps, incandescent, 552  
     wired in parallel, 540, 550  
     wired in series, 540  
 Lap, valve, 400  
 Lap joint, riveting of, 106  
 Lap welded boiler tubes, 511  
 Lap welded pipe, 507  
 Laps, shell plating, 260  
 Latent heat, of food products, 600  
     of steam, 342  
 Launches, 673  
 Launching, 227  
 Launching calculations, 228  
 Launching data, 232, 233  
 Launching devices, 231  
 Launching ways, 228, 232, 233  
 Launching weight, 233  
 Law of comparison, 226  
 Lay, 632  
 Lead, 155  
 Lead of valve, 400  
 Leg boiler, 368  
 Length, of boiler and engine rooms, 305, 310  
     for freeboard, 208  
     Lloyd's, 166  
     over all, 166  
     between perpendiculars, 166  
     for tonnage, 169  
 Lifeboat, distance from vessel when heeled, 679



- Lifeboats, 663, 664, 665  
 capacities of, 666, 670, 671  
 motor driven, 664
- Life buoys, 668, 673
- Life jackets, 668
- Life preservers, 672
- Life rafts, 664, 672
- Life-saving equipment, 663
- Light cruisers, 248
- Lighters, wood, 282
- Lighting, electric, 541, 544, 547, 550,  
 552, 556  
 of saloons, 288
- Linear measure, 2
- Line carrying guns, 682
- Line loss, electric, 538
- Liners, 258
- Linking up, steam engines, 403
- Liquid measure, 4
- Lloyd's, 235
- Lloyd's Register of Shipping, 234
- Load, horse power to raise, 628
- Loading cargoes, 683
- Loads, curve of, 295, 296  
 for blocks, 648
- Locomotive boiler, 366
- Log, steam engine, 703
- Logs, weights of, 18
- Logarithms, properties of, 28  
 table of, 29
- Longitudinal bulkhead, 268, 290, 320
- Longitudinal metacenter, 181, 182, 190,  
 192
- Longitudinal system, Iaherwood, 253  
 war vessels, 244
- Longitudinals, 263
- Lowering boat, heel of vessel, 678
- Lubricating oil, 358, 359
- Lubricating system, gasoline engine, 484  
 steam engine, 417
- Luff tackle, 650, 652
- Lumber, shipping weights of, 18  
*See also* Timber and Wood
- Lumber cargoes, 694
- Lumber schooners, 283
- Lumber steamers, 327
- Luminous buoys, 673
- Lundin lifeboats, 670
- Machinery, maintenance of, 700
- Machinery foundations, 277
- Machinery operating. *See* Operating
- Machinery specification headings, 301
- Machinery survey, 700
- Machinery weights, 304, 310
- Magnesia, 162
- Magnetos, 489
- Main drain, 602
- Maintenance, hull, 696  
 machinery, 700
- Make and break ignition, 551
- Malleable iron, 72, 121
- Manganese bronze, 156
- Manganese steel, 112
- Manifold, 530
- Manila, 634
- Manila rope, 636, 634, 631
- Manila rope blocks, 648
- Margin plank, 285
- Margin plate, 261
- Marine insurance, 710
- Marine steam engines, 393
- Mariner's measure, 2
- Marline, 637
- Masts, rake of, 630
- Materials, cu. ft. per ton, 16  
 piping, 527  
 rivet, 104, 110, 117  
 shipbuilding, 111-165  
 specific gravities of, 13  
 strength of, 70-110  
 weights of, 13
- Mean effective pressure, calculation of,  
 410  
 trial, 421
- Measurement of draft, 389
- Measuring screws, 289
- Mechanical and electrical units, 23
- Mechanical equivalent of heat, 341
- Merchant vessels, types of, 238, 309
- Messenger chains, 624
- Metacenter, longitudinal, 181, 182, 190,  
 192  
 transverse, 173, 174, 176  
 calculations for, 175, 177, 179, 181  
 tables of heights, 174, 202
- Metals, non-ferrous, 155
- Metric conversion table, 7
- Metric system, 4
- Metric unit of heat, 341
- Midship section, battleship, 246  
 motor ship, 500

- Midship section, schooner, 283  
   steamers, 241, 242, 254, 257  
 Midship section coefficient, 172  
 Millimeter-inch conversion table, 5  
 Mineral wool, 163  
 Modulus, of rupture, 70  
   section, 53, 129  
 Molded breadth, 186  
 Molded depth, 167  
 Moment of inertia, 50  
   calculations, 297  
   sections, 52  
   structural shapes, 126  
   water plane, 176  
 Moment to alter trim, 190, 192  
 Monitors, 248  
 Mooring lines, 642  
 Motor boat, percentage cost of parts,  
   337  
   speed formula, 224  
 Motor boat propellers, 317, 431, 434  
 Motor boat wiring, 550  
 Motor boats, data on, 317, 318  
 Motor driven lifeboats, 664  
 Motor schooner, estimate on building,  
   334  
 Motor ships, data on, 316  
   repair costs of, 336  
 Muntz metal, 157  
 Mushroom anchor, 660  
  
 Nails, 293  
 Nautical mile, 2  
 Naval brass, 157  
 Net tonnage, 169  
 Neutral axis, beam, 76  
   vessel, 297  
 Nickel steel, 113  
 Nickel steel forgings, tests of, 113, 116  
 Nipples, 526  
 Nominal horse power, 22  
 Non-ferrous metals, 155  
 Non-metallic materials, 162  
 Norake Veritas, 237  
 Nuts, bolts, 524  
   propeller, 430, 699  
  
 Oakum, 162  
 Oats, cargo of, 661  
 Oblique triangles, formulae for, 41  
 Ohm, 581  
 Ohm's law, 532  
 Oil, 353  
   chill or cold test of, 356  
   color of, 356  
   density of, 355, 359  
   fire point, 356  
   flash point, 356  
   fuel, data on, 354, 356  
   kerosene, 478  
   storm, 681  
   storage in barrels, 685  
   storage in cases, 686  
   viscosity of, 356, 359  
 Oil barrels, 21, 355  
 Oil burners, 362  
 Oil burning systems, 360  
 Oil cargoes, 684  
 Oil carried in inner bottom, 321  
 Oil carriers, construction of, 320, 257  
   data on, 326, 295  
   fire extinguishing apparatus for, 325  
   pumping arrangements in, 323, 325  
   stability of, 320, 684  
   ventilation of, 578  
 Oil consumption, 316, 350, 421  
 Oils, Beaumé gravity of, 354, 355  
   for boilers, 356  
   heat values of, 356  
   for internal combustion engines, 357  
   lubricating, 358, 359  
   specific gravities of, 354, 355, 356  
   weights of, 354, 356  
 Open hearth steel, 111, 116  
 Operating boilers, 385  
 Operating cost, Diesel engines, 334, 335,  
   496  
   geared turbines, 496  
   motor ships, 334  
   steam engines, 496  
 Operating Diesel engines, 499  
 Operating electric generating sets, 560  
 Operating motors (gasoline engines),  
   491  
 Operating pumps, 477  
 Operating refrigerating machines, 600  
 Operating, ship, 683  
   steam engine, 419  
 Operating surface condensers, 453  
 Ordering rivets, 104  
 Ordering shapes and plates, 130, 258  
 Overhauling boilers, 386

- Packing, 526  
 Paddle wheel engines, 314, 329, 397  
 Paddle wheel steamers, 314, 329  
 Paddle wheels, 436  
   data on, 314, 437  
   slip, speed, revolutions and pitch of, 436  
 Paint, anti-corrosive, 279  
   anti-fouling, 279  
   copper, 231  
   cork, 289  
   red lead, 279  
 Painting, boiler room, 281  
   crew's quarters, 288  
   engine room, 281  
   hull, 279  
   staterooms, 287  
   wood, 288  
 Panels, electric motor, 565  
 Panting stringers, 268  
 Parabola, area of, 33  
 Paraboloid, volume of, 38  
 Parallel, lamps wired in, 540, 550  
 Parallelogram, area of, 33  
 Passenger steamers, data on, 310, 312  
 Pass-over valves, 415  
 Peak tanks, cement in, 278, 698  
   draining of, 604  
 Perishable products, keeping of, 587  
 Petrol, 358  
 Petroleum and products, 353  
 Phosphor Bronze, 156, 71  
 Pickling steel plates, 121  
 Pillars, 268  
 Pintles, rudder, 275  
 Pipe bending, 519, 527  
 Pipe, brass, 518  
   bursting formula for, 90  
   butt welded, 507  
   butt welded, bundling schedule, 20  
   comparative areas of, 521  
   for cooling coils, 596  
   copper, 518  
   couplings, 526  
   coverings, 163, 165  
   fittings, 528  
   flanges, 522, 528  
   gaskets for, 526  
   lap welded, 507  
   length of thread, 526  
   nipples, 526  
   Pipe, square feet in, 571  
   steel, 507  
   strength of wrought iron, 507  
   threads, 525  
   trade customs, 507  
   wrought iron, tables of, 508, 509  
   test for, 507  
 Pipes, friction of air in, 585  
   loss of pressure in, 520  
   water flow in, 520  
 Piping, ammonia, 596  
   carbonic anhydride, 596  
 Piping oil burners, 362  
 Piping systems, materials for, 527  
 Piston rod, formula for, 414  
 Piston, steam engine, 414  
 Piston valve, 394, 399  
 Pivoted davits, 676  
 Plank, margin, 285  
 Planking, of wood vessels, 282  
   deck, 284  
 Plating, shell, 258  
 Plenum system, 576  
 Plough steel wire rope, 637, 639  
 Plugs, fusible, 379  
   in shell plating, 261, 699  
 Plumbing, 606  
 Plumbing fixtures, 606  
 Policies, marine insurance, 711  
 Polygon, area of, 33  
 Polyhedron, measures of, 36, 38  
 Portable conductors, 545  
 Portland cement, 162  
 Powering vessels, 222  
 Powers of numbers, 26, 29  
 Pressure, absolute, 449  
   atmospheric, 344, 448  
   gauge, 440, 344  
 Prices, of barges, tug, schooners, etc., 333  
   of boilers, 337  
   of steamers sold in 1915-1916, 331  
   of steam engines, 337  
 Prices, costs and estimates, 331  
 Primary batteries, 554  
 Primer, wood, 258  
 Priming of pumps, 476  
 Prism, measures of, 36  
 Prismatic coefficient, 171  
 Producer gas, 479  
 Propeller nuts, protection of, 699

- Propellers, back of blade, 424  
 blade thickness of, 432  
 bosses of, 430, 432  
 data on, 310, 426, 431, 432, 434  
 developed area, 425  
 diameter, 424  
 disk area, 425  
 disk area ratio, 425, 426, 430  
 driving face, 424  
 edges of, 424  
 finding pitch of, 428  
 formulae for slip, speed, revolutions  
 and pitch, 428  
 helicoidal area of, 429  
 keys for, 430  
 motor boat, 317, 431, 434  
 number of blades, 425, 426  
 nuts for, 430  
 nuts, covering of, 600  
 pitch, 424, 428, 430  
 pitch ratio, 424  
 pressure on, 430  
 projected area, 310, 425, 429  
 right or left-handed, 424  
 shape of blades, 424  
 slip of, 425, 427, 428, 430, 434  
 struts for, 278  
 thrust of, 424, 420  
 turbine ship, 429  
 weights of, 432
- Proportions, extreme, of a vessel, 168,  
 212, 294
- Propulsion, i. h. p. for, 222  
 turbo-electric, 444
- Propulsive coefficient, 223
- Protective deck, 245
- Pulleys, 652
- Pumping arrangements, oil carriers,  
 322, 325
- Pumps, air, 450  
 centrifugal, 474  
 circulating, 462  
 duty of, 472  
 freight steamer, 477  
 hand, 605  
 installing and operating, 477  
 lifts of, 471  
 priming of, 476  
 types of, 470
- Purchase on capstan rope, 630
- Purchases, 650
- Pyramid, measures of, 36
- Quadrant davita, 676
- Quadrant, rudder, 621
- Quarter sawing, 157
- Radians, 3
- Radiators, steam, size required, 569
- Radius of gyration, 50, 52
- Raised quarter deck vessel, 242
- Rate of combustion, 350
- Reaumur thermometer, 25
- Receiver pressure, 421
- Reciprocating pumps, 470  
 sizes of, 473, 474
- Reducing valves, 529
- Refrigeration, 587  
 for cold storage room, 598  
 for products, 599  
 gas to produce, 598  
 ton of, 595
- Refrigerants, 591, 594, 601
- Refrigerating machinery, 591  
 space taken by, 587
- Refrigerating machines, horse power for,  
 595, 600  
 location of, 601  
 operating of, 600  
 rating of, 600
- Refrigerating rooms, insulation of, 587  
 ventilation of, 591
- Refrigerating systems, costs of, 337
- Register ton, 2, 169
- Registro Nazionale Italiano, 237
- Registry, 169
- Relief valves, cylinder, 415
- Repair costs of motor ships, 336
- Resistance of vessels, 225
- Return tube boiler, 366
- Reverse frames, 256
- Reverse gears, 483
- Reversing engines, 416
- Rheostat, 565  
 field, 543
- Rift sawing, 157
- Rigging, ship, 645  
 yacht, 643
- Rigs of vessels, 679
- Ring buoys, 673
- Rivet diameters, Lloyd's rules for, 102  
 reduced to inches, 108

- Rivet materials, 104  
 Rivet steel, boiler, 110, 72  
   hull, 117, 72  
 Riveted joints, 105  
 Riveted plates, bearing value of, 107  
 Riveting in oil carriers, 321  
 Riveting shell plating, 260  
 Rivets, cone head, weight of, 110  
   countersink depth for, 102  
   length for ordering, 104  
   number in 100 lbs., 109  
   proportions of, 102  
   shearing strength of, 105, 107  
   signs for, 103  
   strength of, 104  
   tensile strength of, 104  
   types of, 101  
   working load for, 92  
 Rockets, 682  
 Rope, cast steel wire, 639, 641  
   formulae, 642  
   hemp clad wire, 636, 637  
   hoisting, data on, 632, 634  
   kinds of, 634  
   length for splices, 646  
   manila, weight and strength of, 636  
   trade terms, 632  
   wire, 637  
     flattened strand, 638, 639  
     measuring of, 640  
 Rope capacity, of a drum, 628  
 Rope hitches, 633  
 Rope knots, 633  
 Ropes, strength of, 640  
 Rotating davits, 673  
 Round-cornered squares, sizes of, 140  
 Rounds, sizes of, 137  
 Rudder, chain to, 624  
   pintles, 375  
   power to turn, 623  
   pressure on, 623  
 Rudder areas, 276  
 Rudder quadrant, 621  
 Rudder stock, diameter of, 274  
 Rudders, 274  
 Runner and tackle, 650  
 Rupture, modulus of, 70  
  
 Safety, factors of, 75, 518, 527  
 Safety valve, 376  
 Sagging, 298  
  
 Sailing vessels, 240, 282, 319  
   motor, data on, 318, 320  
 Saloons, lighting of, 288  
 Salting wood vessels, 282  
 Salt water, 8, 12  
 Saturated steam, 343  
   properties of, 345  
 Sawing wood, 157  
 Scale, boiler, removing of, 368  
 Schooners, construction of, 282, 283  
   data on, 319  
   motor, data on, 318, 320  
 Scotch boiler, weight of water in, 307  
 Scotch boilers, data on, 364, 365, 366  
   proportions of, 363  
 Scouts, 249  
 Screws, brass and iron, wood, 290, 291  
   lag, 289, 293  
   measuring of, 299  
 Screw threads, bolt, 524  
   pipe, 525, 526  
 Searchlights, 553  
 Seasoning wood, 158  
 Secant of an angle, 40  
 Secants, table of, 43  
 Section modulus, 53, 129  
 Sections, properties of, 52  
 Sector of circle, area of, 33  
 Segment of circle, area of, 33  
 Separators, steam, 416  
 Series, lamps wired in, 540  
 Series motors, 561  
 Shackles, tests of, 95, 96  
 Shaft, torsion formula for, 89  
 Shaft bearings, 418  
 Shaft horse power, calculation of, 447  
   steam consumption per, 312, 448  
 Shafting, formulae for, 412  
 Shallow draft steamers, 328  
 Shearing strain, 70  
 Shearing strength of bolts, 93  
 Shearing strength of rivets, 105  
 Shearing stresses, curve of, 295, 298  
 Shearing value of rivets, 107  
 Shear poles, stresses in, 98  
 Sheaves, block, number of, 654  
 Sheer, 210  
 Shellac, 268  
 Shell plating, 258  
   plugs in, 261, 699  
   reinforcing at bulkheads, 271

- Shell plating, stresses in, 297, 298  
 Shelter deck vessels, 239, 240  
   freeboard of, 216  
 Shifting boards, 699  
 Shifting of coal, 693  
 Shifting of grain, 688  
 Shipbuilding channels, 129  
 Shipbuilding materials, 111-165  
 Ship calculations, 166-233  
 Ship chartering, 703  
 Ship construction, systems of, 253  
 Ship equipment, 615  
   specification headings, 301  
 Ship fittings, strength of, 91  
 Ship operating, 683  
 Ship's dimensions, 168, 212, 294  
 Ship's rigging, 645  
 Ship's section, stresses in, 299  
 Ship's side, heat through, 567  
 Ships, data on, 309  
   friction constants for, 227  
   frictional resistance of, 225  
   powering of, 222  
   strength of, 294  
   types of, 238  
   war, 243  
   wood, 282  
 Shipping measure, 2  
 Shipping organizations, 234  
 Shipping terms, 716  
 Shipping weight, 1  
 Shipping weights of lumber, 18  
 Shunt motors, 561  
 Shutting off boilers, 386  
 Side girders, 262  
 Side wheel steamers, data on, 313, 314, 315  
 Signal lights, 546  
 Signal wires, 546  
 Signals, Ardois, 566  
 Silicon steel, 113  
 Simpson's first rule, 34  
 Simpson's second rule, 35  
 Sine of an angle, 40  
 Sines, table of, 43  
 Sinks, 607  
 Skylights, 286, 287  
 Slide valve, 394, 399  
 Sluice valves, 602, 606  
 Societies, classification, 234  
 Soft coal, sizes of, 352  
 Soft wood sizes, 160  
 Solenoid brakes, 566  
 Sounding rod, 606  
 Spanish burton, 650  
 Spark coils, 487  
 Spark plugs, 490  
 Specification headings, 300  
 Specific gravities, of materials, 13  
   of oils, 354, 355, 356  
 Specific heat, of food products, 600  
   of steam, 341  
 Spectacle frames, 274  
 Speed, motor boat formula for, 224  
 Speed of vessel, and engine revolutions, 224  
 Speed table, 434  
 Sphere, measures of, 36  
 Spherical sector, measures of, 36, 37  
 Spherical segment, measures of, 36, 37  
 Spherical zone, measures of, 36, 37  
 Spikes, boat, 293  
 Splices, rope, 646  
 Springs, 90  
 Sprinkler systems, 614  
 Square bars, sizes of, 140, 143  
 Square edge flats, sizes of, 140  
 Square measure, 2  
 Square root, 27, 29  
 Squares of numbers, 29  
 Stability curves, 183  
 Stability, notes on, 189, 683, 688, 693, 694  
   of oil carriers, 320, 684  
 Stack, area of, 363  
   rake of, 680  
   resistance to draft, 393  
   temperature, 393, 421  
 Stairs, 287  
 Stanchions, 268  
 Standard gauges, 123  
 Starting valves, 415  
 Stateroom bulkheads, 285  
 Staterooms, painting of, 287  
 Steam, 341  
   coal required to generate, 349  
   consumption per i.h.p., 342, 421  
   consumption per s.h.p., 445, 446, 447, 448  
   consumption and cylinder cut-off, 405  
   dry, 343  
   efficiency of, 342

- Steam, for evaporators, 468  
   kinds of, 343  
   latent heat of, 342  
   saturated, 343  
     properties of, 345  
   specific heat of, 341  
   superheated, 343  
     specific heat of, 343  
   temperature of, 344  
   temperature and vacuum of, in con-  
     denser, 456  
   total heat of, 342  
   volume of, 348  
   wet, 343
- Steam capstans, 630  
 Steam engine generating sets, 559  
 Steam engine log, 703  
 Steam engines, back pressure in, 396,  
   456  
   bearing surfaces, 414  
   calculation of i.h.p., 410  
   coal consumption and cylinder cut-  
     off, 405  
   coal consumption per i.h.p., 411, 421  
   connecting rod formula, 413  
   crank sequences, 396  
   cut-off, 395, 405  
   cut-off and steam consumption, 405  
   cylinder clearances, 396  
   cylinder formula, 413  
   cylinder ratios, 394  
   cylinder, steam pressure in, 404, 405  
   estimated horse power of, 411  
   expansion in, 394, 395, 405  
   fittings and accessories, 414  
   indicator cards, 406  
   lap, 400  
   lead, 400  
   linking up, 403  
   lubricating system, 417  
   mean effective pressure, 410  
   number of expansions by pressure,  
     405  
   number of expansions by volumes,  
     405  
   operating, 419  
   operating cost, 496  
   paddle wheel, 314, 329, 397  
   pistons, 414  
   piston rods, 414  
   pressure in cylinder at cut-off, 404, 405
- Steam engines, prices of, 337  
   setting valves, 404  
   shafting formula, 412  
   size of boiler for, 371  
   thrust collars, 413  
   trial trips, 421  
   types of, 393  
   valve mechanisms, 402  
   valve travel, 401  
   valves, 394, 399, 400  
   water service, 417
- Steam expansion, in engines, 394, 395,  
   405  
   in turbines, 439
- Steam gauges, 378  
 Steam heating, 568  
 Steam lighters, data on, 314, 315  
 Steam pipe covering, 163, 165  
 Steam plant auxiliaries, 448  
 Steam pressure, average, for stroke, 405  
   boiler, 364, 370, 421  
   in cylinder, 404  
   receiver, 421
- Steam radiators, sizes of, 569  
 Steam separators, 416  
 Steam steering engines, 615  
 Steam traps, 463  
 Steam turbines, 437  
 Steam velocity, 440  
 Steam winches, 626  
 Steam windlasses, 624  
 Steam yachts, data on, 314, 315
- Steamers, cargo and passenger, data on,  
   310, 311, 312, 320  
   excursion, data on, 313, 314, 315  
   lumber, 327  
   shallow draft, 328
- Steel, carbon, 112, 114, 116  
   cast, 118, 72, 116  
   chromium, 114  
   chromium nickel, 114  
   chromium vanadium, 114  
   coefficient of expansion, 112  
   elongation of, 112, 116, 72  
   manganese, 112  
   manufacture of, 111  
   nickel, 113, 72  
   properties of, 111, 116, 72  
   rivet, 117, 110, 72  
   silicon, 113  
   structural, 114, 116, 72

- Steel, tungsten, 113**  
   vanadium, 114  
**Steel bars, flat, weights of, 149**  
   weights, circumferences and areas of, 143  
**Steel boiler tubes, 510, 511, 512**  
**Steel columns, 84, 85, 86**  
**Steel forgings, tests of, 113, 116**  
**Steel hawsers, 644, 646, 631**  
**Steel heads, maximum sizes of, 128**  
**Steel pipe, 507**  
**Steel plate gauges, 124**  
**Steel plates, diamond checkered, 125**  
   maximum sizes of, 128  
   ordering, 130  
   pickling and galvanizing, 121  
   tests for, 114, 116  
   weights of, in 100ths of an inch, 122  
   variations in, 115  
**Steel plates and sheets, weights of, 124,**  
   126, 127, 128  
**Steel shapes, ordering, 130**  
**Steel wire nails, 293**  
**Steering chain, size of, 634**  
**Steering gear arrangements, 617, 630**  
**Steering gear, steam and electric, 615**  
**Steering gear transmissions, 620**  
**Steering engines, installations of, 616,**  
   618  
**Stem, 272, 116**  
**Stephenson valve mechanism, 402**  
**Stern frame, 272, 116, 698**  
**Stern tube, 273**  
**Stern wheel engines, 329, 397**  
**Stern wheel vessels, 329**  
**Stokeholds, ventilators to, 579**  
**Stop valve, 377**  
**Stopwaters, 272**  
**Storage batteries, 554**  
**Storm oil, 681**  
**Stove bolts, 132**  
**Stowage of oil, in barrels, 685**  
   in cases, 686  
**Stowage space of materials, 16**  
**Stowing cargoes, 683**  
**Strain, 70**  
**Strapping of wood vessels, 282**  
**Stream anchor, 659**  
**Streams, water, 612**  
**Strength of materials, 70**  
   of rivets, 104, 105, 92, 107  
**Strength of ship fittings, 91**  
   of timber, 74  
   of tubes, pipes and thin cylinders,  
     formula for, 90  
   of wrought iron pipe, 507  
   structural, of vessels, 294  
   ultimate, 71  
**Stress, 70**  
**Stresses, in cranes, derricks and shear**  
   poles, 98  
   in materials, 71, 73  
   in shell plating, 297, 298  
**Stringers, 268**  
**Stroke, steam pressure at end of, 404,**  
   405  
**Structural details, 253**  
**Structural features, merchant vessels,**  
   238  
**Structural shapes, 129**  
**Structural steel—Am. Bureau of Ship-**  
   ping Rules, 114  
   Am. Soc. of Testing Materials, 115  
   Lloyd's requirements, 114  
   strength of, 72, 114, 116  
**Structural strength of vessels, 294**  
**Struts, propeller, 273**  
**Submarine chasers, 252**  
**Submarines, 250, 300**  
**Suction head, 471**  
**Sulphur dioxide system, 613**  
**Superheated steam, 343**  
   specific heat of, 343  
**Superheaters, 381**  
   tests of, 383  
**Surface blow valve, 378**  
**Surface condensers. See Condensers**  
**Surfaces of solids, 36**  
**Survey, hull, 696**  
   machinery, 700  
**Switchboards, 543, 546, 549**  
**Switches, 543, 546, 550**  
**Swivels, 657**  
**Tables, writing and mess, 287**  
**Tackle, 650**  
   power gained with, 652, 654  
**Tangent, of an angle, 40**  
**Tangents, table of, 43**  
**Tank top, ceiling for, 285**  
   covering for, 263  
**Tankers. See Oil carriers**



- Tees, 140, 141  
 Temperature, combustion chamber, 393  
   of fire, 353  
   furnace, 393  
   hot well, 421  
   injection water, 421  
   of steam, 344  
   stack, 393, 421  
   uptake, 393, 421  
 Temperatures, cold storage, 568  
 Tension, 70  
 Tensile strength, of bolts, 93  
   of materials, 71, 112, 113, 116, 119,  
   120, 523  
 Tension in hoisting rope, 634  
 Tests, for carbon steel, 112, 114  
   for cast steel, 118  
   for rivet steel, 117  
   for steel plates, 114, 116  
   for steel shapes, 114  
   of cast iron, 121, 71  
   of eye bolts, 95  
   of hooks, 94, 96  
   of insulating materials, 164, 165  
   of lag screws, 293  
   of shackles, 95, 96  
   of steel forgings, 113  
   of superheaters, 393  
   of turbo-generator sets, 560  
   of turnbuckles, 97  
   of woods for hardness, 158  
   of wrought iron, 120  
 Thermometer scales, table of, 24  
 Thermometers, 25  
 Thermotanks, 571, 577  
 Threads, on bolts, 524  
   on pipe, 525, 526  
 Three-wire system, 540  
 Throttle valve, 414  
 Thrust, propeller, 429  
 Thrust bearing, 418  
 Thrust horse power, 24  
 Thrust shaft, collars on, 413  
 Tiller rope, 640  
 Timber, feet board measure in, 9  
   properties of, 74  
   *See also* Wood; Lumber  
 Time charter, 704  
 Time measure, 2  
 Time policy, 713  
 Timers, 487  
 Timon charter, 706  
 Tin, 155, 72  
 Titan bronze, 156  
 Tobin bronze, 156, 71  
 Ton, cubic feet per, 16  
   of refrigeration, 505  
   register, 199, 2  
   shipping, 2  
 Tonnage, gross, 169  
   length for, 169  
   net, 169  
 Tons, per inch of immersion, 170  
   per inch of immersion curve, 170  
 Torpedo boats, 249  
 Torpedo boat destroyers, 249  
 Torpedo tubes, 246  
 Torpedoes, 246  
 Torsion formula, 89  
 Towing, 223  
 Towing machines, 631  
 Transverse bulkheads, 268, 320  
 Transverse metacenter. *See* Metacenter  
   transverse  
 Transverse system, 253  
 Trapezoid, area of, 33  
 Trapezoidal rule, 33  
 Trapezium, area of, 33  
 Traps, steam, 463  
 Trawlers, 327  
 Trials, 421, 312, 443, 445, 447  
 Triangle, area of, 33  
 Triangles, solution of, 41  
 Trigonometry, 39  
 Trigonometric formulae, 42  
 Trigonometric functions, 40  
 Trim, 190  
   moment to alter, 190, 192  
 Trim calculations, 191  
 Trim lines, 192  
 Trimming tanks, cement in, 278  
 Trip charter, 703  
 Troy weight, 1  
 Trunk vessels, 243  
 Tubes, brass, 511, 514  
   bursting, formula for, 90, 518  
   cleaning boiler, 387  
   copper, 511, 513, 514, 519  
   trade customs, 507  
 Tugs, construction of wood, 282  
   data on, 814, 315  
 Tungsten steel, 113

- Tunnel, draining of, 604  
 Tunnel vessels, 330  
 Turbine auxiliaries, 448  
 Turbine generating sets, 560  
 Turbine ship propellers, 429  
 Turbine ships, data on, 312, 440, 443, 444, 445, 446, 447  
     trials of, 312, 421, 443  
 Turbines, Alquist gearing for, 444  
     calculation of, a.h.p., 447  
     data on, 312, 437  
     efficiency of, 448  
     expansions in, 439  
     geared, 442, 445, 312  
     hydraulic transmitter for, 444  
     steam consumption of, 446, 443, 448  
     types of, 439  
     weight saved with, 446  
 Turbo-electric propulsion, 444  
 Turbo-generators, rating of, 544  
 Turnbuckles, tests of, 97  
 Turning engines, 416  
 Turret vessels, 243  
 Two-wire system, 540  
  
 Ultimate strength, 71  
 Unions, 526  
 Unvalued policy, 713  
 Uptake temperature, 393  
 U. S. Steamboat-Inspection Service, 238  
  
 Vacuum, 421, 454  
     to find, 455  
     *See also* Trials  
 Vacuum gauge, 464  
 Vacuum and steam temperature in condenser, 456  
 Valued policy, 713  
 Valve, check, 529, 378, 471  
     safety, 376  
     sluice, 602, 606  
     stop, 377  
     throttle, 414  
 Valve travel, 401  
 Valves, cylinder relief and drain, 415  
     Diesel engine, 499  
     for pipe, 528  
     internal combustion engine, 484  
     steam engine, 394, 399, 400  
     starting or pass-over, 415  
     surface and bottom blow, 378  
  
 Vanadium steel, 114  
 Vaporizers, 482  
 Varnish, 288  
 Ventilation, 575  
     air required, 575  
     of engine room, 579  
     of oil steamers, 578  
     of refrigerating rooms, 591  
 Ventilating systems, 576  
     laying out, 584  
 Ventilators, 579  
 Versed sine of an angle, 40  
 Vessel heeled, distance lifeboat from, 679  
 Vessels, rigs of, 679  
 Viscosity of oil, 356, 359  
 Volt, 531  
 Voltages, 532  
 Voltmeter, 543  
 Volumes of solids, 36  
 Voyage policy, 713  
  
 War vessels, 243  
     boats for, 673  
 Warping winch, 629  
 Washing out boilers, 387  
 Waste lines, 609  
 Water, data on, 8  
     boiling point of, 12  
     density of, 12  
     flow in pipes, 519  
     quantity through a hole, 195  
     weight of in Scotch boilers, 307  
 Water, evaporated, equivalent units of, 23  
     in boilers, 371, 375  
     per lb. of coal, 349  
 Water gauge, 379  
 Water injection temperature of, 449, 457, 421  
 Water plane, center of gravity of, 51  
     coefficient of fineness, 171  
     moment of inertia of, 176  
 Water pressure—air pressure, 577  
 Water service, steam engine, 417  
 Water streams, 612  
 Water tube boilers, 368  
     space occupied by, 370  
     weights of, 308, 370  
 Water tube and fire tube boilers compared, 370

- Watt, 531  
     equivalent value of, 23  
 Wattmeter, 543  
 Wave forming, 225  
 Weight, of water, 8  
     in Scotch boiler, 307  
 Weight curve of a vessel, 294, 295  
 Weights, of a battleship, 247  
     of boiler covering, 307  
     of boilers, 306, 370  
     of brass sheets and plates, 126, 127  
     of cone head rivets, 110  
     of copper sheets and plates, 126,  
     127  
     of Diesel engines, 309  
     effect of moving, 203  
     of engines, 305, 306  
     of flat steel bars, 149  
     of fire bars, 307  
     of fire bricks, 307  
     of hulls, 303, 310  
         formule for, 302  
     of lag screws, 292  
     of logs, 18  
     of lumber, 18  
     of machinery, 304, 310  
         per i.h.p., 304  
     of materials, 13  
     of miscellaneous units, 19  
     of oil carriers, 326  
     of oils, 356  
     of propellers, 432  
     of square and round steel bars, 143  
     of steel plates and sheets, 124, 126,  
     127  
     of steel plates in 100ths of an inch,  
     122  
     of structural shapes, 129  
     of water tube boilers, 308  
 Well deck vessel, 230  
 Wet steam, 343  
 Wetted surface, 172, 421  
 Whale boats, 673  
 Whips, 650  
 Winches, 636, 639  
 Windlasses, 624  
 Wire rope, 637  
     hemp clad, 636, 637  
     measuring of, 640  
 Wire rope blocks, 648  
 Wire rope flattened strand, 639, 639  
 Wireless equipment, 680  
 Wires, electric, carrying capacities of,  
     534, 535  
     gauges of, 538  
     measurement of, 533  
     running of, 545  
     sizes of, 537  
 Wiring, motor boat, 550  
     steamer, 547  
 Wiring gasoline engines, 551  
 Wiring systems, electric, 539  
 Wood columns, formule for, 85, 87  
     safe loads for filler, 288  
     grain of, 157  
     hard and soft sizes of, 159, 160  
     hardness of, 158  
     heat values of, 352  
     kinds and properties of, 74, 160  
     painting of, 288  
     primer, 288  
     sawing of, 157  
     seasoning of, 158  
     *See also* Timber, Lumber  
 Wood screws, brass, 291  
     iron, 290  
 Wood vessels, 282  
 Working boat, 664  
 Working stress, 73, 74  
 Wrought iron, 120, 116  
 Wrought iron pipe, data on, 507  
     tables of, 508, 509  
 Wrought iron pipe columns, safe loads  
     for, 88, 89  
 Wrought iron tubes, bursting pressures  
     of, 91  
 Yachts, steam, data on, 314, 315  
 Yacht rigging, 643  
 Zees, sizes and weights of, 142  
 Zero, absolute, 344  
 Zinc, 155, 72  
 Zinc strips, boiler, 701  
     condenser, 453  
     hot well, 463  
     sea connection, 698  
     stern frame, 698



THIS BOOK IS DUE ON THE LAST DATE  
STAMPED BELOW

AN INITIAL FINE OF 25 CENTS  
WILL BE ASSESSED FOR FAILURE TO RETURN  
THIS BOOK ON THE DATE DUE. THE PENALTY  
WILL INCREASE TO 50 CENTS ON THE FOURTH  
DAY AND TO \$1.00 ON THE SEVENTH DAY  
OVERDUE.

APR 28 1950

JUN 28 1950

REC'D LD

JUL 14 1950

4 Mar 50 RB

REC'D LD

JUN 5 1950

2 Mar 50 RB

REC'D LD

JUL 2 1950

YB 51729

366677

VM  
151  
H8

THE UNIVERSITY OF CALIFORNIA LIBRARY

