



कबाड़ से जुगाड़

Little Science

PUBLISHED BY:

**EKLAVYA**

E-10, BDA COLONY, SHANKAR NAGAR  
SHIVAJI NAGAR, BHOPAL 462016 (MP) INDIA

TELEPHONE (0755) 2671017, 2551109

FOR ORDERS: [pitara@eklavya.in](mailto:pitara@eklavya.in)

Rupees. 30/-

## **LITTLE SCIENCE**

Written by **Arvind Gupta**

Illustrations by **Avinash Deshpande**

[arvindguptatoys@gmail.com](mailto:arvindguptatoys@gmail.com)

### **What not to do**

Once a parent bought an expensive toy and after removing it from its gleaming box gave it to a child with a warning 'Handle it carefully, don't break it'. The toy had rounded corners so the child could not feel its edges. She couldn't hammer it on the ground as it was made of plastic. It had no smell or taste. Within three minutes flat the child had left the neatly rounded plastic toy in the corner, and was merrily playing with its box. She knew that she would not be scolded for throwing the box on the floor. From her own viewpoint the little girl had made a very intelligent assessment of the toy.

Children are eternal explorers. In their free moments they are always experimenting and improvising. They are always making and inventing things out of odds and bits and trinkets. They learn a great deal from ordinary, organic things found around the house. The main thing about scrap is that children can use it freely without adult admonishment.

Maths is a beautiful subject. It has deep roots in practice and great relevance to real life. But the horrendous way it's taught in schools gives children distaste - a life long hatred for the subject. As sensitive parents and teachers the least that we must not do is to give children distaste for a subject. If we don't know a humane way of teaching something then we must just leave it, trusting it to the children's own natural resilience and abilities. Someday, may be, they'll get excited about it and then they will discover the whole world about that subject.

Today textbooks have become synonymous with knowledge. Educationists seem to be in a hurry to shovel concentrated doses of knowledge down the throats of children, without bothering whether the children can assimilate them. But knowledge is like a sea. It is eternal, endless. What you take out - a barrel, a cup, a spoon, a drop is immaterial. What, however, one must not do is to give children a distaste of going to the sea beach.

This booklet lists a few innovative experiments for learning science. Many of them I learnt from interesting children, people and books. The English title of this book *LITTLE SCIENCE* has been taken from the magazine *SCIENCE AGE* where most of these articles first appeared.

Children understand better if they experience things. They understand science principles better if they see them in some toy or are able to relate them to a real life experience. Otherwise school curriculums will keep emphasising rote learning - mugging and spitting of definitions and formulae. This they will do with the view of covering the

## Geometry by paper folding

Most of these 'Geometric Exercises in paper folding' have been inspired by a book of the same name, written by an Indian mathematician in 1893. His name was T. Sundara Row (anglicised from Rao).

Paper folding is mathematical by its very nature. A sheet of paper starts as a plane. A fold produces a straight line – an intersection of two planes.

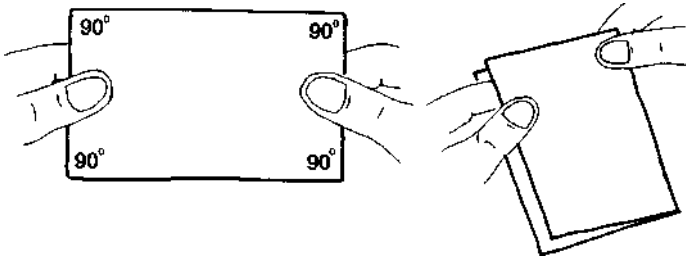

1. We'll start with simple angles. A right angle or 90 degrees is trivial for all paper sheets have right angle corners.

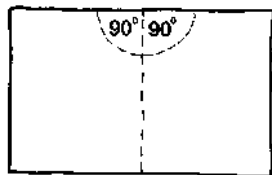

2. It's easy to see that a straight edge is 180 degrees by doubling it upon itself and seeing two exact right angles on either side of the crease.

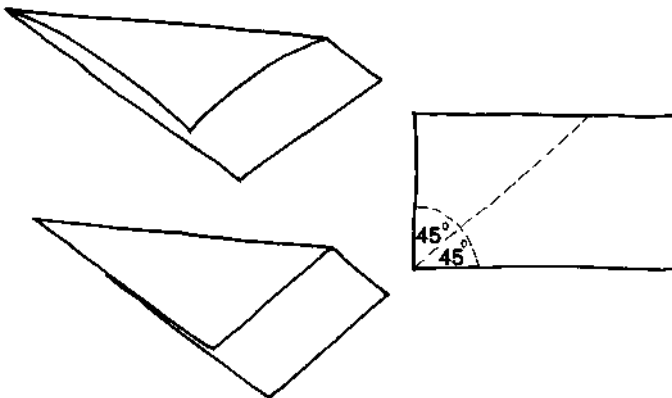

3. A 45 degree angle is got by folding any right angle corner into half.

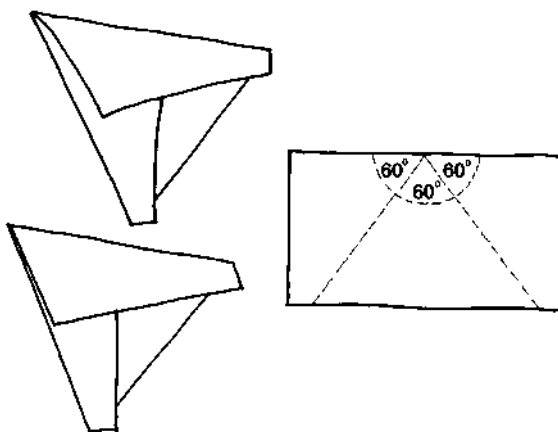

4. How to fold 60 degrees? Divide a straight edge 180 degrees into three equal angles. Simple, isn't it. Take a point midway on the straight edge of the paper. Lift both edges of the paper from this point and fold them to approximately 60 degrees.

Before creasing ensure that the edges are flush with the folds to be creased. With a bit of practice and patience you can fold very accurate 60 degree angles.

## Paper Diamonds

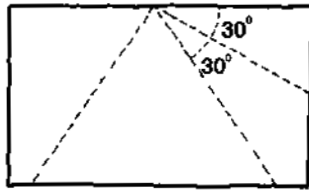
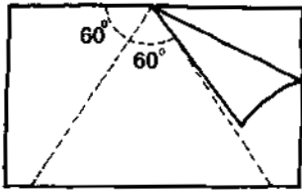

1. How to fold a 30 degree angle? This could be done in two ways. Either you could fold a right angle into three equal parts, or else, fold the 60 degree angle such that its one edge doubles on the other.

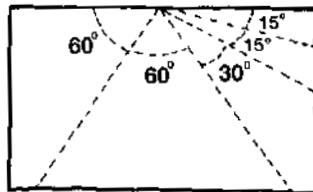
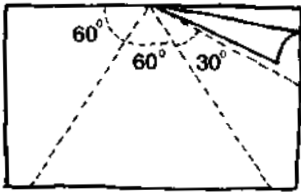

2. A fifteen degree angle can be got by halving the 30 degree angle. This can be simply done by doubling its one edge over the other.

You did not use the protractor, the compass or any other aid from the geometry box for folding the above angles. And whereas a geometry box has to be carted around a piece of paper is available anywhere. By combining the above angles you can get several more. For instance, 105 degrees can be got by adding 90 and 15. Angle of 75 degrees can be got by subtracting 15 from 90.

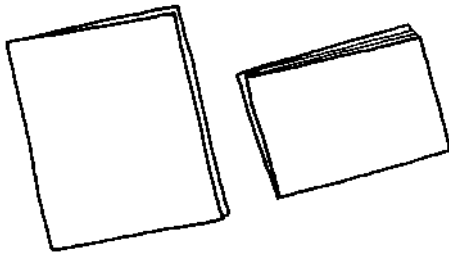

3. How to fold a diamond? Fold a sheet first into two and then into four.

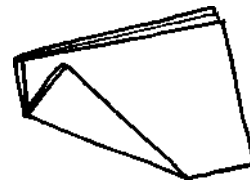

4. Crease a triangle at the four fold corner.

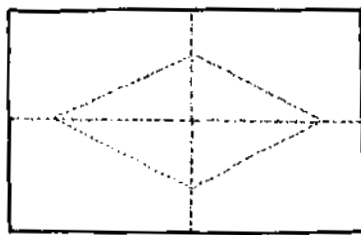
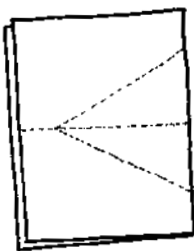

5. On opening the sheet you'll see an elegant rhombus in the middle.

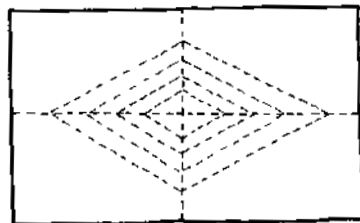
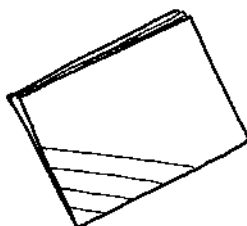

6. If you make several parallel creases in the four fold corner then on opening up you will see a diamond in a diamond in a diamond - a series of nesting diamonds .

## Knotty Pentagon

Folding a strip along its length into 2, 4, 8 equal parts is a relatively trivial matter, since paper folding is essentially a binary operation. But folding a paper into 5 equal parts can prove tricky. Folding a regular polygon with odd number of sides can be quite difficult.

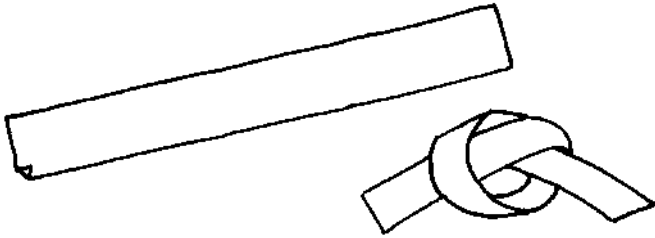

1. How to fold a regular pentagon? We often tie knots in pyjama strings and length of ropes seldom noticing that a tight knot takes the shape of a pentagon. Take a long rectangular strip of paper and tie the two loose ends into an ordinary knot.

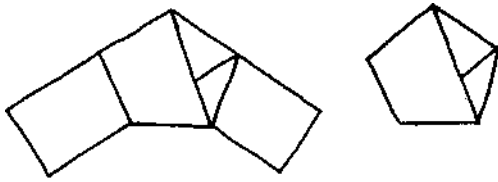

2. Gently pull the ends to tighten the knot and you'll be surprised to see a very neat knotty pentagon.

## Hex Cob

Now try folding a regular hexagon.

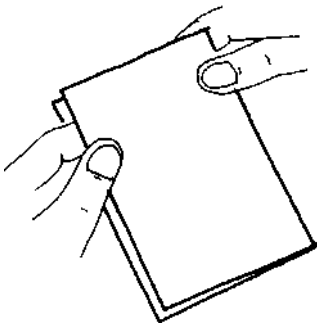

3. First fold a sheet into two.



4. Fold the doubled up straight edge (180 degrees) into three equal parts of 60 degrees each.

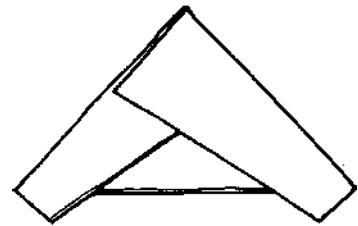

5. Ensure that the double edges are flush with the folds to be created.

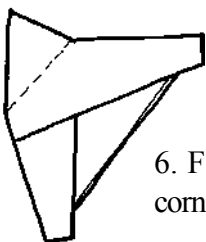

6. Fold the 6 layer corner into a triangle.

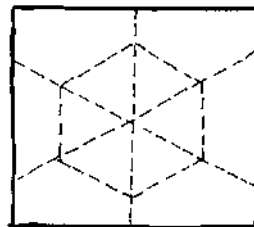

7. On opening you'll see a regular hexagon in the middle.

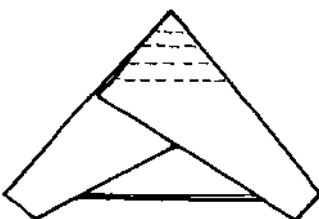

8. On folding several parallel creases and opening up you'll see a set of nesting hexagons.

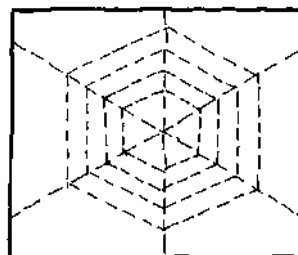

9. The nesting hexagons resemble a cobweb.

## Folding an Octagon

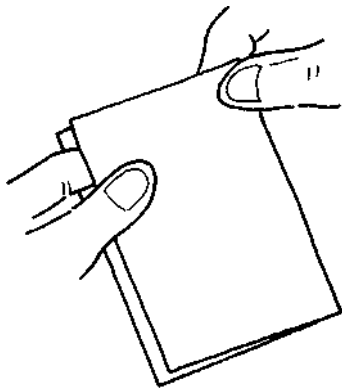

1. Fold a sheet first into two.

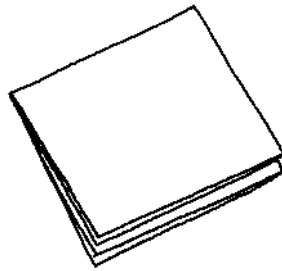

2. Then into four.

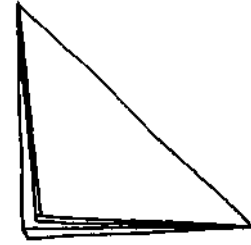

3. Crease the four fold corner again into a triangle to make 8 folds.

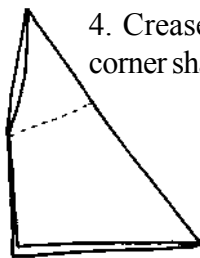

4. Crease the 8 fold corner sharply.

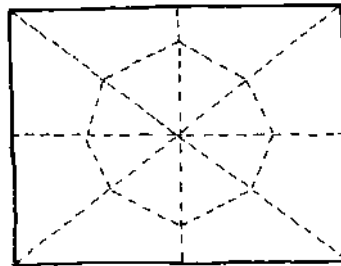

5. On opening you'll find a regular octagon in the centre. You'll also see that the central angle of 360 degrees is divided into eight segments of 45 degrees each. You can also try folding nesting octagons.

## Angles of a Triangle

We often mug up geometric proofs to pass exams. Seldom do we relate them to any concrete activity or model. However, this simple exercise in paper folding will easily show you that the sum of the interior angles of a triangle is 180 degrees.

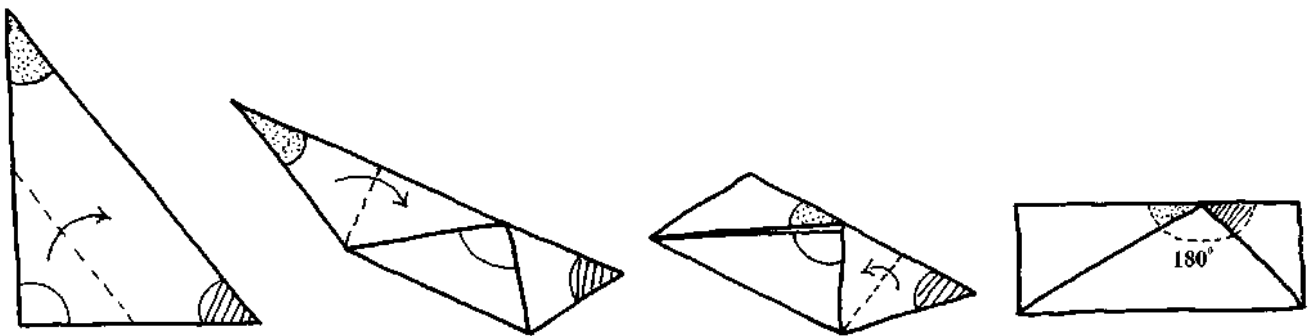

Cut a triangle out of a piece of paper. If you fold over the corners as shown in this sequence then you can easily make the 3 angles fit together to form a 180 degree angle. When the angles are placed together they make a straight line. This means they total 180 degrees. The sector forms a semi-circle.

## Self-locking Parallelogram

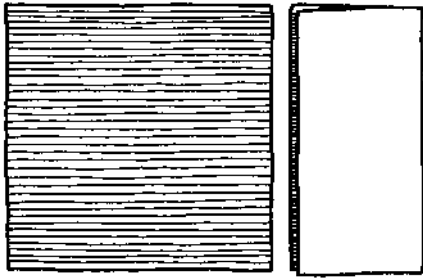

1. Take a square piece of paper and fold a crease in the middle.

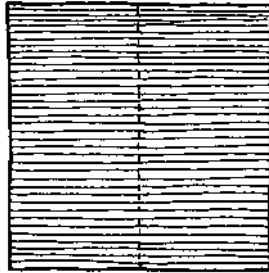

2. Open it.

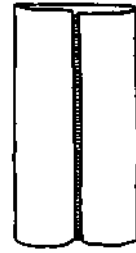

3. Now fold the two edges of the square inwards to touch the middle crease to make a vertical rectangle.

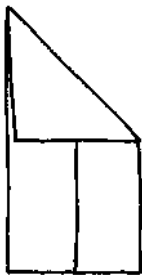

4. Fold the top right angle corner into half. Crease and open up.



5. On opening you'll find a small triangular flap.



6. Fold it inwards.



7. Now insert the right hand corner between the folds of the left vertical rectangle.

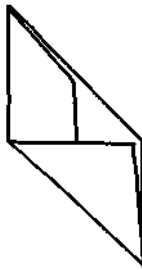

8. Repeat the same process for the lower left corner of the rectangle. First fold it into half.



9. Open the crease.

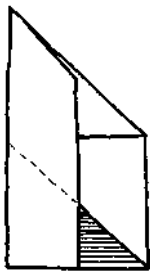

10. Fold the small triangular flap inwards.

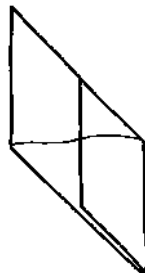

11. Insert the lower left corner between the folds of the right vertical rectangle.

The final folded shape becomes a self-locking parallelogram. Its opposite sides and angles are equal. One surface of this parallelogram is plain and smooth while the other surface has got 4 pockets.

## Self locking Cube

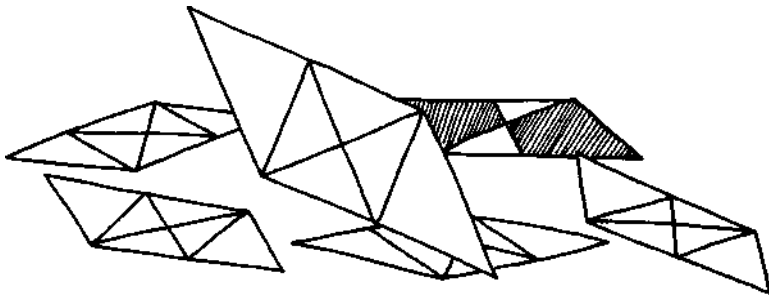

1. Fold six self locking parallelograms of the same size using the procedure described on the previous page. As parallelograms can have left or right orientations, ensure that all the 6 parallelograms have the same orientation.

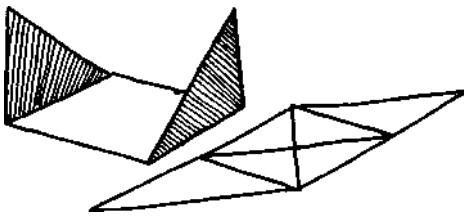

2. Each parallelogram can be viewed as having a square in the middle and two triangular flaps on the ends. Fold the triangular flaps of all the parallelograms towards the plain side, such that the pocket face is an exact square. Now all these 6 folded parallelograms - with square facets and triangular flaps will be assembled into a regular cube. There will totally be 24 pockets and 12 flaps.

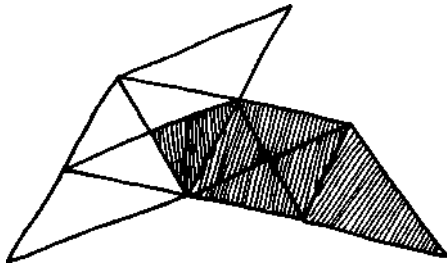

3. Start with two parallelograms. Insert one flap of the first into a pocket of the second.

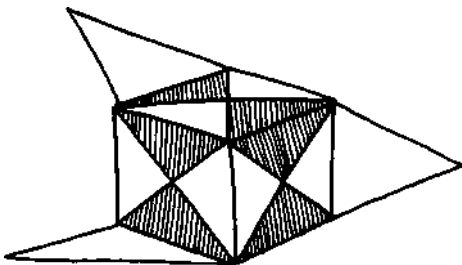

4. Take the third parallelogram and insert both its flaps - one in each of the previous parallelogram pockets. Thus one corner of the cube will be assembled.

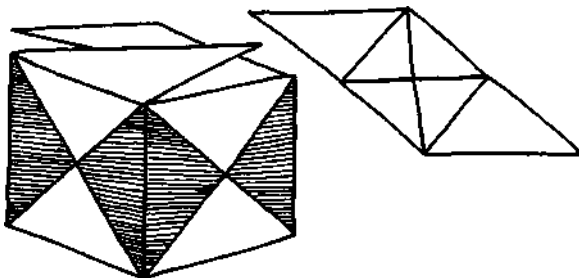

5. Continue assembling taking care that all the flaps will come over the square facets and get inserted in the pockets.

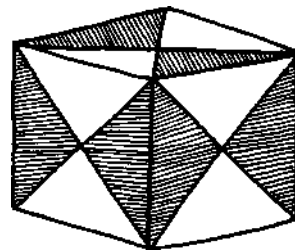

6. No flap will be inside the cube. No glue is required. Coloured cubes can be made using different colours of glazed paper. Small and stiff cubes make beautiful dices.



## Postcard Structures

Everything has a structure. The human body, buildings, bridges, animals all have a skeletal frame which bears the load. Using old postcards we'll explore a few structures.

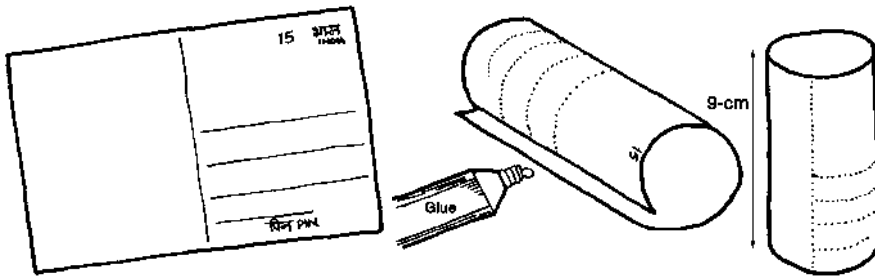

1. All postcards measure 14 cm x 9 cm. Fold and glue a postcard into a 9 cm tall cylinder.

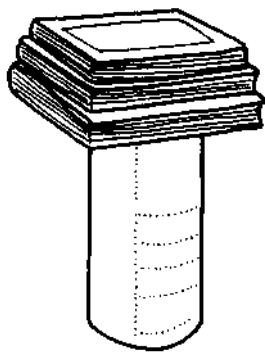

2. It doesn't look very strong. How much load can it support? Make a guess. Now slowly pile books on this column until it collapses. Place the books in the centre so that they don't tip off. The 9 cm tall postcard cylinder is able to support nearly 4 kg of load. Are you surprised?

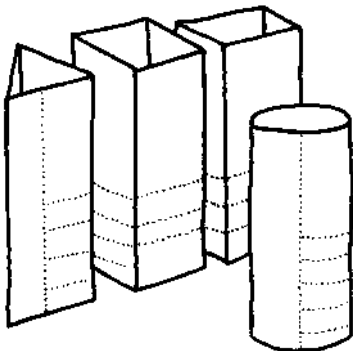

3. Try folding 9 cm tall columns of different cross sections - triangular, rectangular, square, and oval. Which cross section will sustain the most load? Why? Columns of which cross section do you most frequently encounter in daily life?

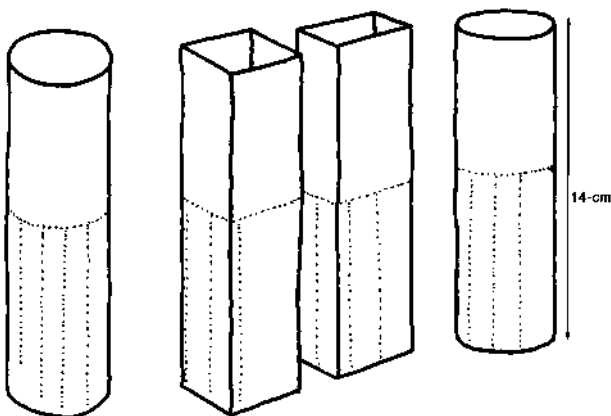

4. Fold postcards in various cross sections to make 14 cm high columns. Which cross section is the most efficient? Make two columns of the same cross sectional area, but one tall and the other short. Which supports more load? For the same cross section of column, how does load bearing depend upon height?

## Postcard Structures (continued)

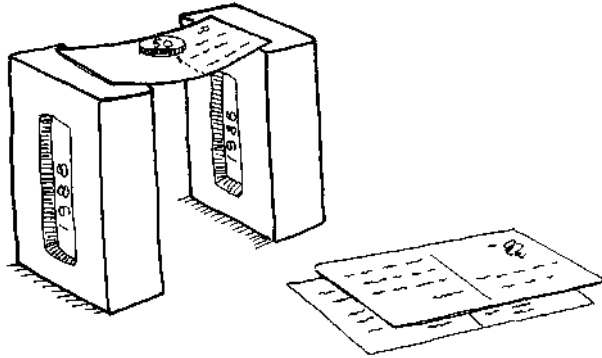

5. Stand two bricks 12 cm apart. Place a postcard on top of the bricks such that 1 cm length of the postcard sits on either brick. Now place 50 paisa coins (5 gm each) in the middle of the postcard. The postcard sags a little bit. With every additional coin the card sags some more. When the load is around 40 gm the postcard caves in and falls down.

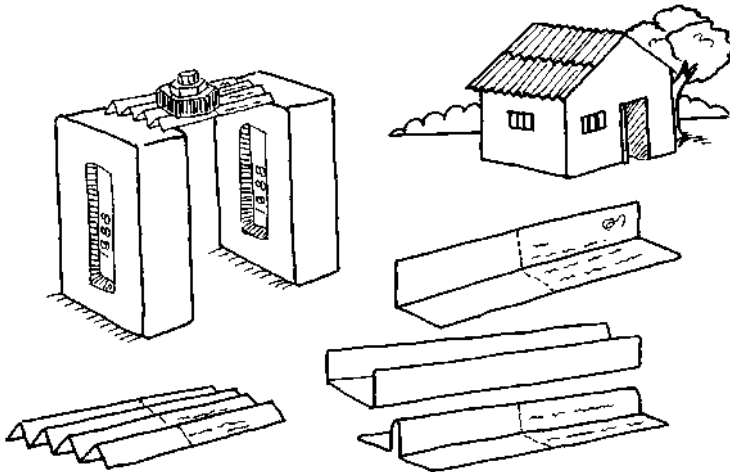

6. Crease the postcard in the middle along the length to make a right angle section. Place it similarly on the bricks and see the load it can support. Can a crease help in strengthening a structure? Test a U shaped channel section and a T beam. Do different sections support different loads? Fold four pleats in a postcard and place this corrugated postcard on the bricks. How much load can it support? Are you surprised that it can now support almost a kilogramme. So, it's not just the material but the shape in which it has been arranged which gives the structure its strength and rigidity. Corrugated tin roof sheets are a familiar example of increased strength.

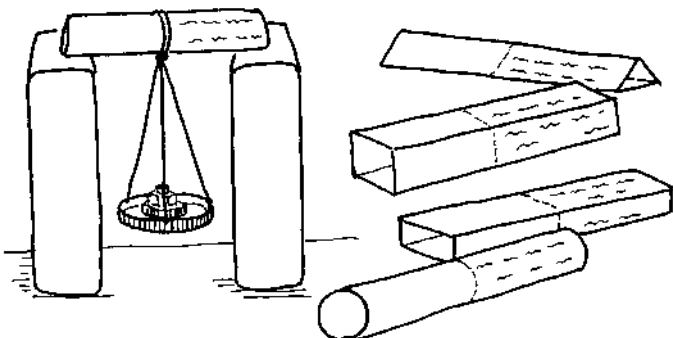

7. Place the 14 cm long postcard columns as beams between the two bricks. Suspend an empty shoe tin pan and place weights on it. Which cross section of beam supports the maximum load?

## Eggshell Tripod

Eggs have such thin shells that they almost appear flimsy. Yet, nature designed the eggshell as a strong vault to protect the live embryo inside. Shell structures are usually very strong and you can test this using three broken egg shells.

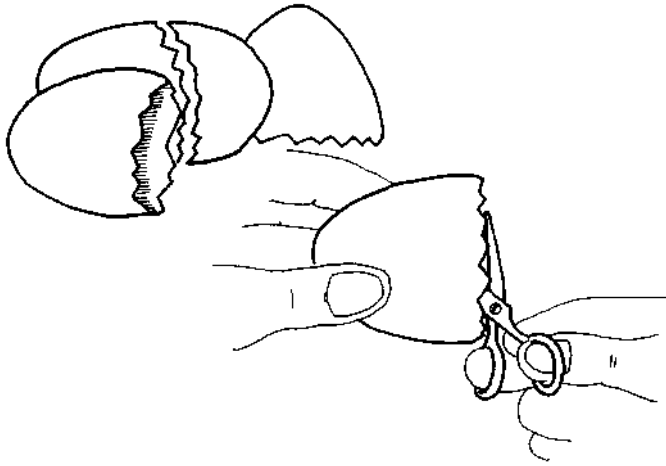

1. Using a scissors nip the egg shells bit by bit to even out the zigzags, and to get a circular rim. Carefully rub the circular rim on a cement floor to even out the remaining zigzags.

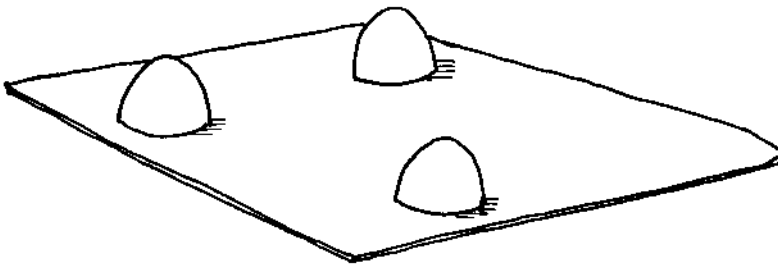

2. Place three such eggshells on a doubled up towel, which will act as a cushion. Now make a guess estimate of the weight which this egg tripod will be able to withstand.

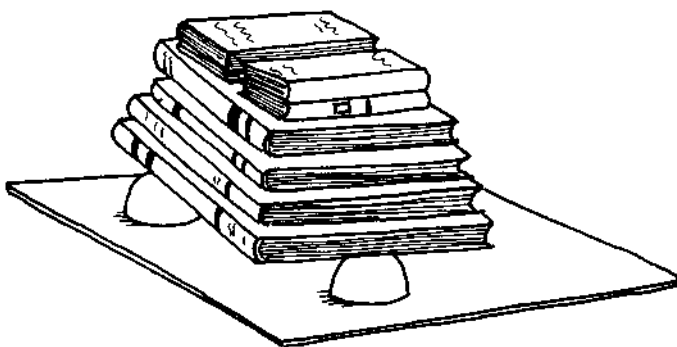

3. Keep placing books on the tripod until the eggshells crush under their load. How close was your guess?

Nature is very economical in its use of material. Human beings have learnt a great deal about structures from nature's optimal designs.

## Geodesic Dome

A geodesic dome looks like a triangulated igloo. And triangles being the most stable polygons, the geodesic dome is one of the strongest structures. A geodesic model can be easily made using cycle valve tube joints of 4, 5 and 6, and three different sizes of broomsticks.



1. You will need cycle valve tube, coconut broom sticks, a thorn or big needle and a craft knife or blade.

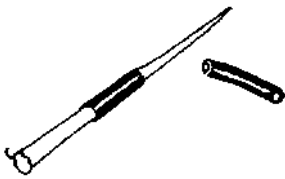

2. Take two bits of cycle valve tube 2 cm long. Weave a Babool thorn or needle through the hole of one valve tube.

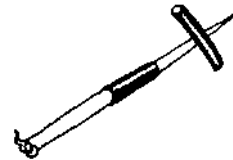

3. Poke the thorn through the middle of the second valve tube.

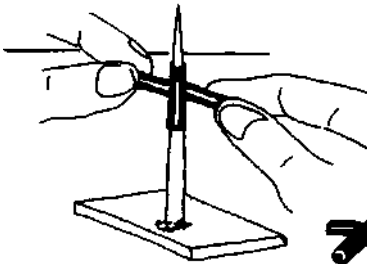

4. Stretch it and slip it over the first valve tube. This is the joint of four. You'll need 15 such joints.

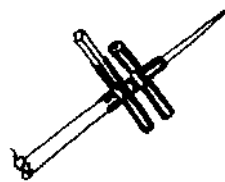

5. To make a joint of six, slip a third valve tube on the first valve tube to make an H shape.

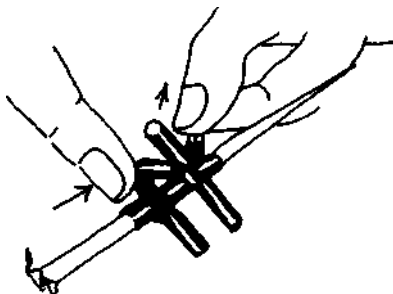

6. Insert a broken matchstick in any of the free legs of the second valve tube. Weave this matchstick through the centre of the third valve tube.

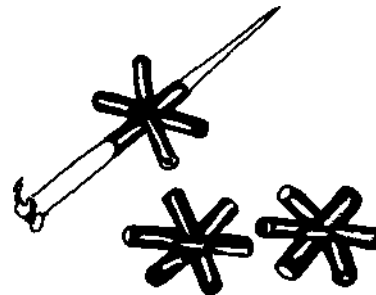

7. Remove the joint - of - six from the thorn. You'll require 25 joints - of - six.

You'll also require 6 joints - of - five. For this make joints - of - six, and use only five legs.

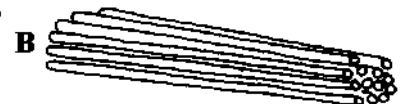
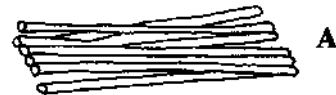

8. You'll need three different sizes of struts. Cut them out of the coconut broomsticks.

Strut A = 6.2 cm, 30 numbers

Strut B = 7.5 cm, 40 numbers

Strut C = 7.23 cm, 50 numbers

### (Geodesic Domes continued)

Using these sizes of struts the approximate diameter of the dome will be 30 cm. The relative proportions of the three struts A : B : C is 35 : 41 : 40 . Using these proportions for strut sizes you can build a smaller or a bigger dome.

A football is a good model for a geodesic. You can see a football is made up of pentagons and hexagons. Divide these pentagons and hexagons into triangles with a sketch pen to simulate a geodesic.

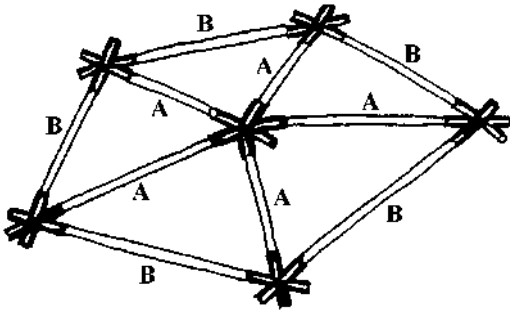

9. Start assembling as shown.

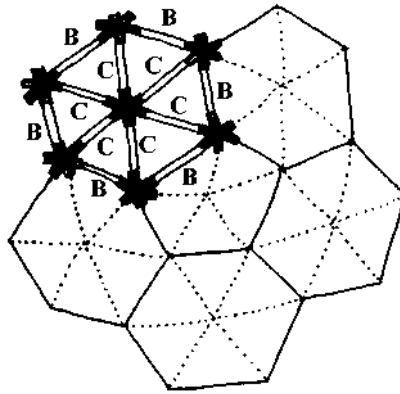

10. Build five hexagons on the five sides of the top pentagon. Complete a circle before beginning the next.

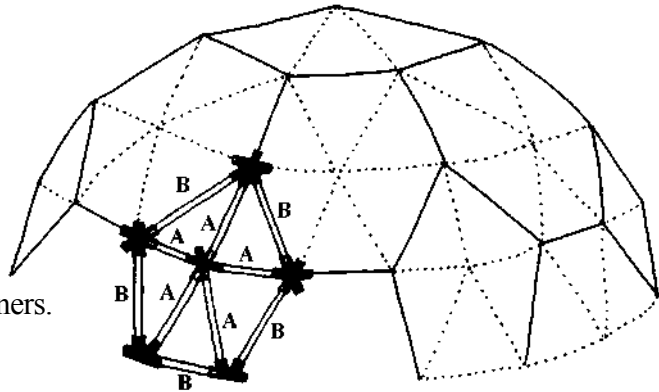

11. Assemble five pentagons into the corners.

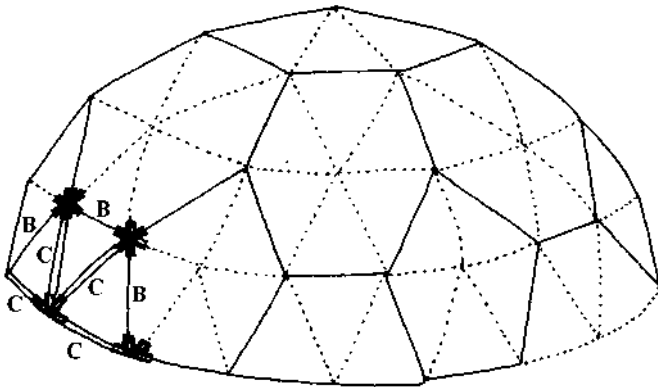

12. Finally assemble the bottom half hexagons.

13. This is the final assembly of the geodesic dome.

The great American designer Buckminster Fuller is credited for designing and popularising the geodesic dome. Since then it has been put to lots of different uses. With the invention of the electron microscope scientists discovered that the structure of the protein virus was a geodesic.

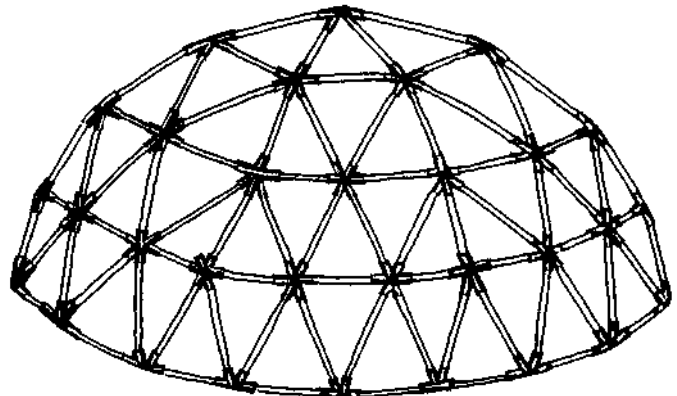

## Pump from the dump

This pump too consists of a piston, cylinder and two valves all salvaged from odds and bits. With each up-down motion of the piston water will leap out in large gushes and delight you no end.

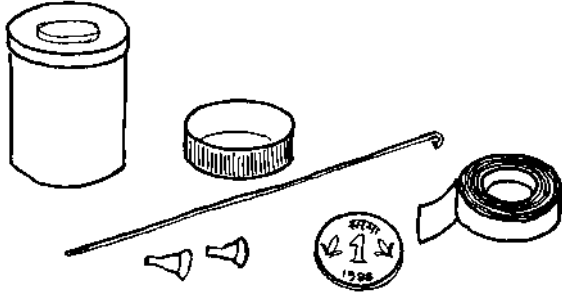

1. You will need a film can, a mineral water bottle cap, bicycle spoke, one rupee coin, cello tape and ordinary hand tools.

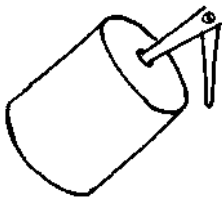

2. Make a hole in the base of the film can by rotating a scissor point. The hole should have a diameter of one centimetre.

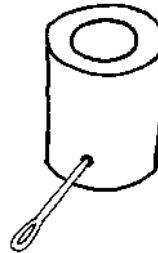

3. Make a hole near the open end of the bottle cap. A ballpen refill must press fit in this hole.

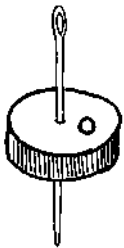

4. The PISTON is made out of a mineral water bottle cap. These caps snugly go into the film can. Make a 5 mm hole for the valve. Make a small hole in the centre to fix the cycle spoke.

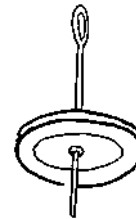

5. Make a hole in the lid of the film can. This hole should be free fit for up-down motion of a bicycle spoke.

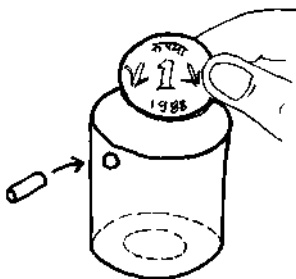

6. Drop a one rupee coin in the film box. The coin will be the SUCTION VALVE. Fix a small refill for the DELIVERY PIPE.

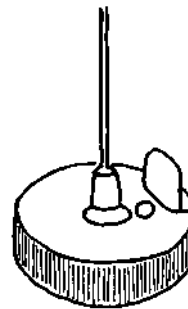

7. Fix a 15 cm cycle spoke with two nuts to the cap. The spoke will be the CONNECTIONG ROD. Stick a piece of cello-tape so that it can open/close the hole. This flap is the DELIVERY VALVE.

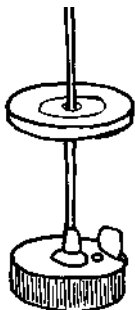

8. This is the final CYLINDER - PISTON assembly of the pump.

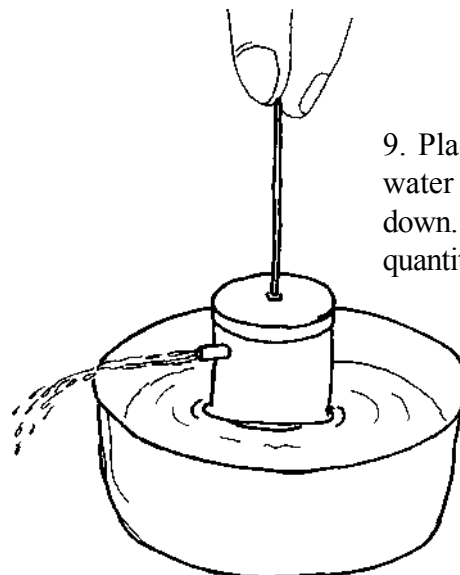

9. Place the pump in a bowl of water and move the spoke up / down. After just a few strokes large quantities of water will gush out.

## Marble Train

When the *phooljhadu* (broomstick) soft portion has worn out and reduced to a stub, it is still of great use for making the track of the marble train.

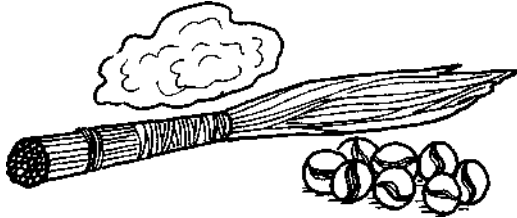

1. You will need an old broom (*phooljhadu*), some clay or plasticine and marbles.

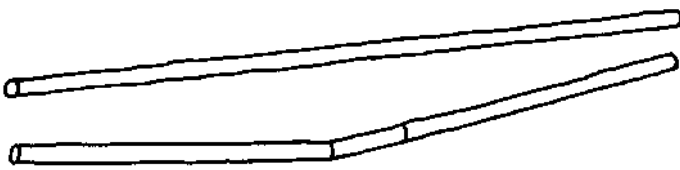

2. Take two round *phooljhadu* sticks about 30 cm long and bend those 2 cm in the middle. Embed the ends into lumps of plasticine or clay. Support the middle portion of the sticks with a bit of clay too. The ends should be 3 cm higher than the middle. The distance between the sticks should be 5 mm or so such that a marble can roll smoothly on the track. Place three marbles at the 'cup' of the track.

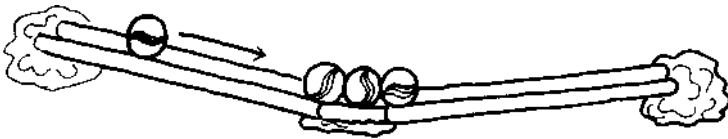

3. Now roll one marble down the left incline. It will hit the three marbles.



4. But on impact only one marble will be ejected up the right incline. Try rolling down two marbles together. On impact only two marbles are ejected up. This beautifully illustrates the principle of conservation of momentum.

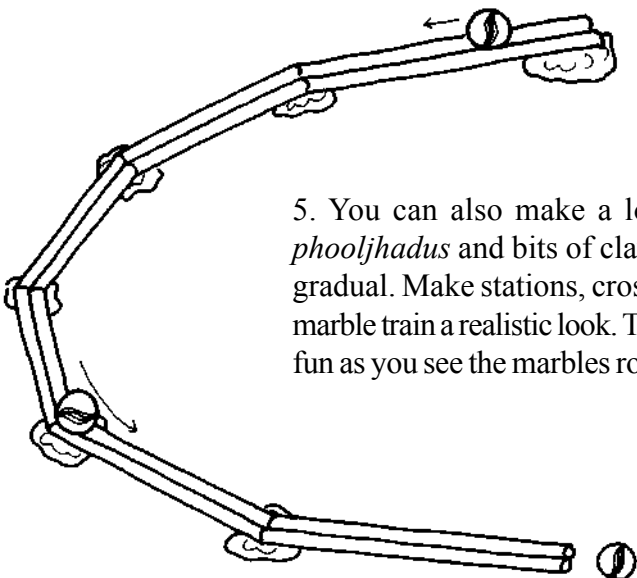

5. You can also make a long and winding marble track using *phooljhadus* and bits of clay. The bends and the incline should be gradual. Make stations, crossings, bridges and tunnels to give your marble train a realistic look. This marble train will provide you hours of fun as you see the marbles roll down the tracks.

## Flexagons

The “flexagon” is an amazing model. Each time that it flexes about its centre a different picture comes into view. It can be used to depict any four stage cycle or sequence. Four flexagon networks printed on thin card sheets are stapled in the middle of the book. The card sheets have the printed network on one side. The reverse side is plain white. Make the flexagons as follows:

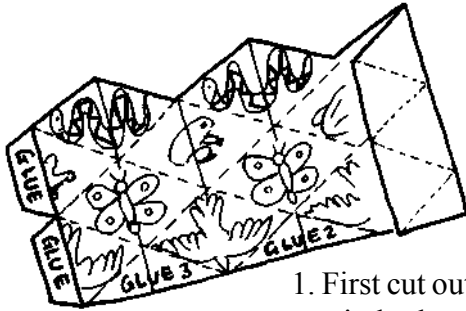

1. First cut out the network precisely along the outline.

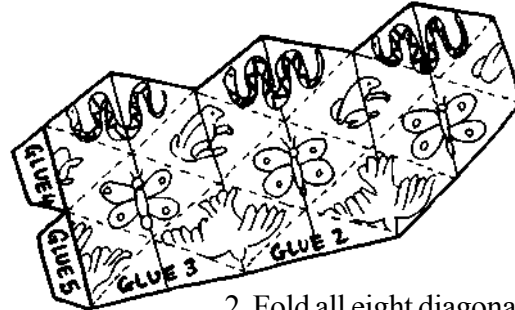

2. Fold all eight diagonal lines (marked with dashes) away from the picture.

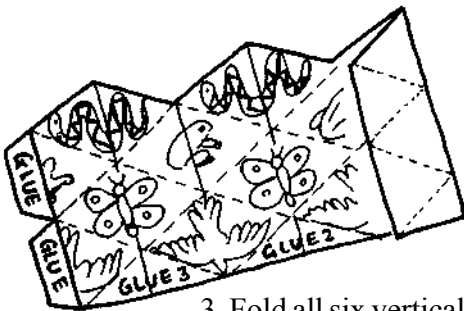

3. Fold all six vertical lines towards the picture. First try to assemble the model without applying glue.

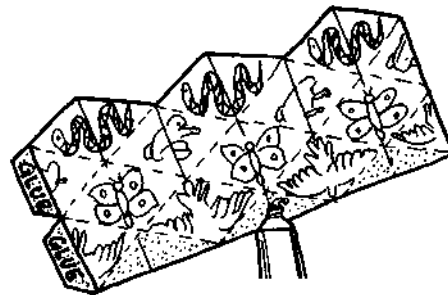

4. When you can see how it fits together glue in order of 1, 2, 3, 4, 5. Glue 1, 2, 3 on the picture side.

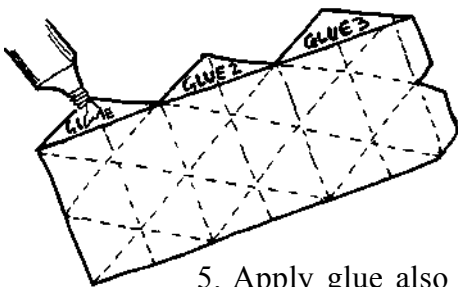

5. Apply glue also to the three triangular hills on the plain side of the sheet. These have not been marked on the network.



6. Stick Glue 1 of picture side to Glue 1 of plain side. Do the same with Glue 2 and Glue 3, to get the chain in.

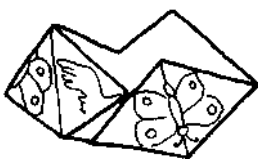

7. Apply glue to flaps 4 and 5. They go inside the pocket to complete the ring. The use of a quick dry impact adhesive like *Fevibond* gives better results.

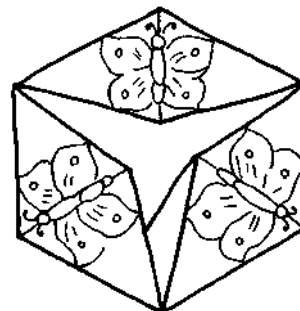

8. This is the finished model. Once dry flex it to glory.



## Flexagons continued

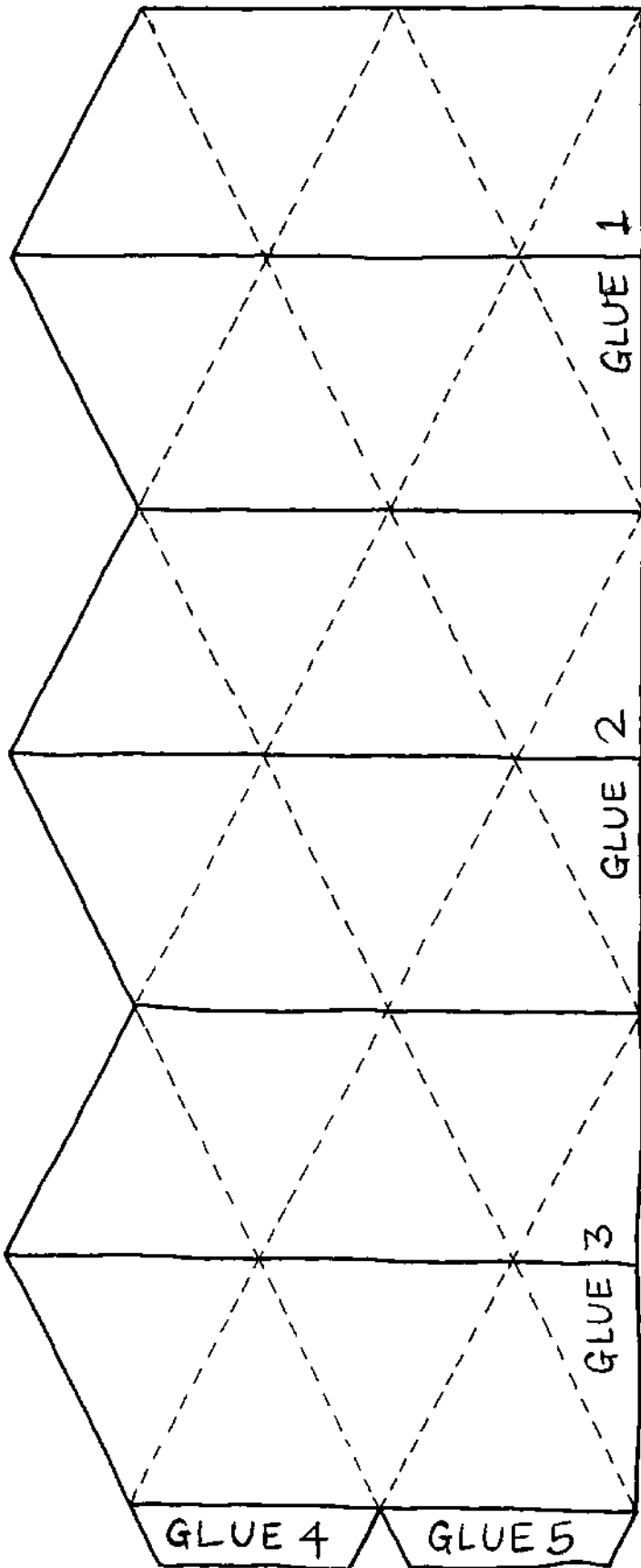

The printed card flexagon networks have the following stages.

**WATER CYCLE:** (a) the sun evaporating water from the oceans leading to (b) cloud formation which results in (c) rainfall which (d) fills all the reservoirs with water.

**EVOLUTION:** (a) 3,000 million years, early sea with algae and simple water plants (b) 600 million years, fishes, molluscs and crustaceans (c) 230 million years, dinosaurs (d) 70 million years, emergence of mammals including human beings.

**BUTTERFLY'S LIFECYCLE:** (a) female laying eggs (b) caterpillar emerging from egg/moulting (c) pupa and (d) a butterfly emerging from the pupa.

**FOOD CHAIN:** (a) butterflies (insects) eaten by (b) frogs who in turn are eaten by (c) snakes, who form the food for (d) eagles (birds).

Actually the flexagon is a very powerful model for depicting any sequence or cycle - and nature is full of them. A plain network is given. Trace it and make several cycles/chains on your own. Sticking the network on an old thin cloth (old sari) and then cutting, folding and pasting, makes a very long lasting flexagon.

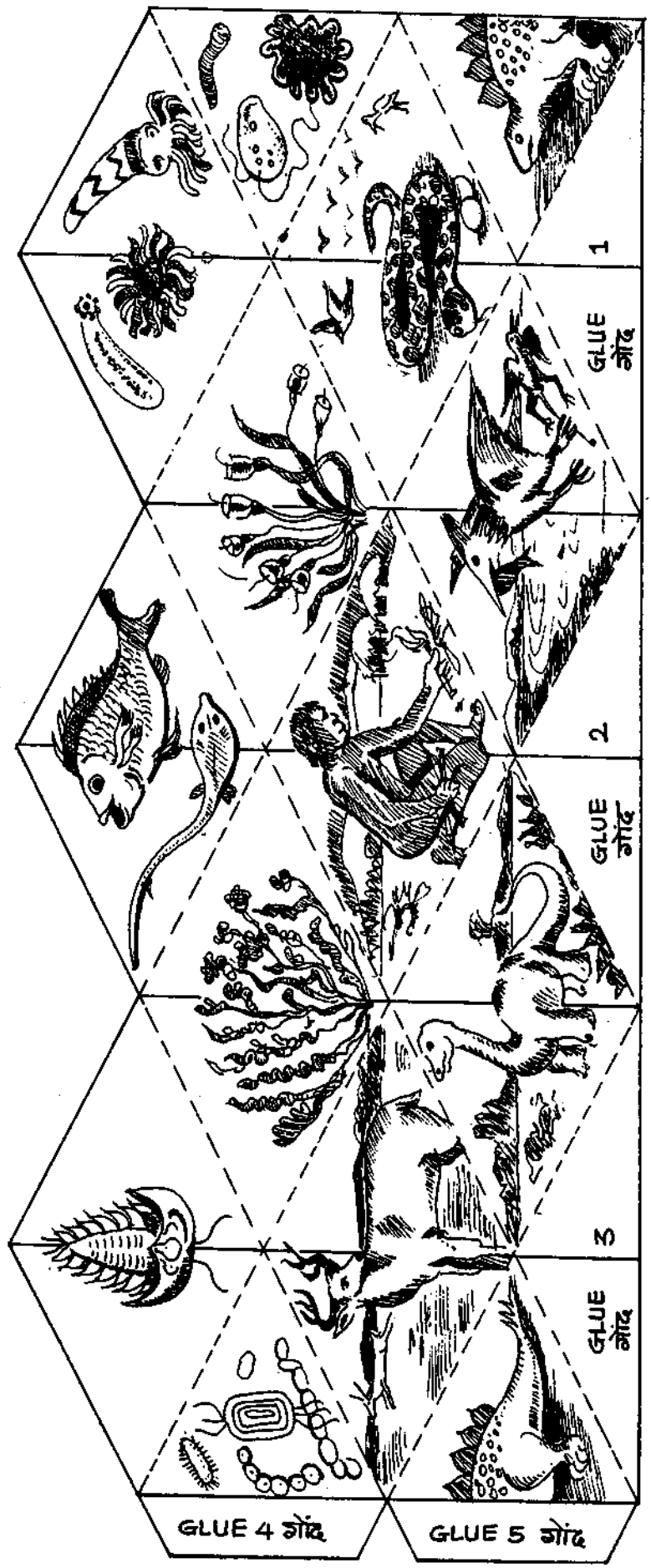

1

GLUE ગોઠ

2

GLUE ગોઠ

3

GLUE ગોઠ

GLUE 4 ગોઠ

GLUE 5 ગોઠ

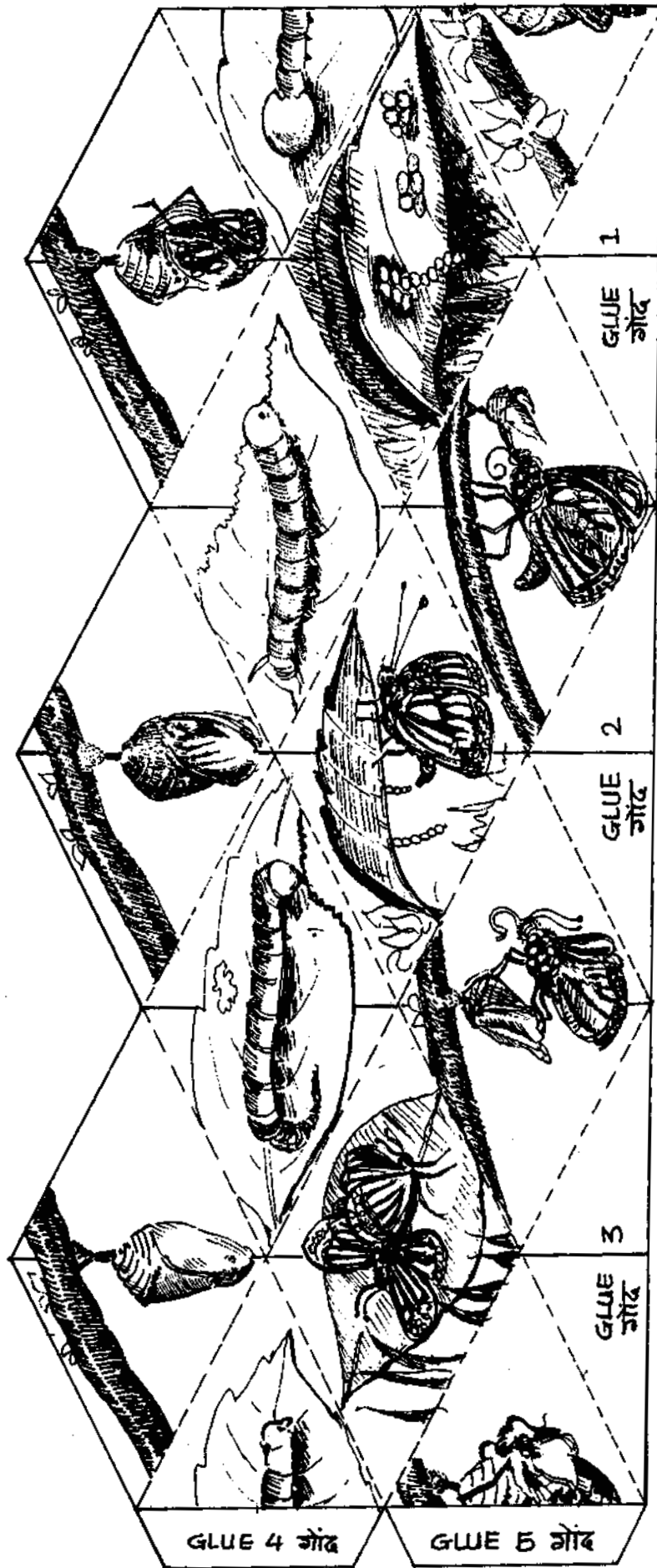

1

GLUE  
गोंद

2

GLUE  
गोंद

3

GLUE  
गोंद

GLUE 4 गोंद

GLUE 5 गोंद

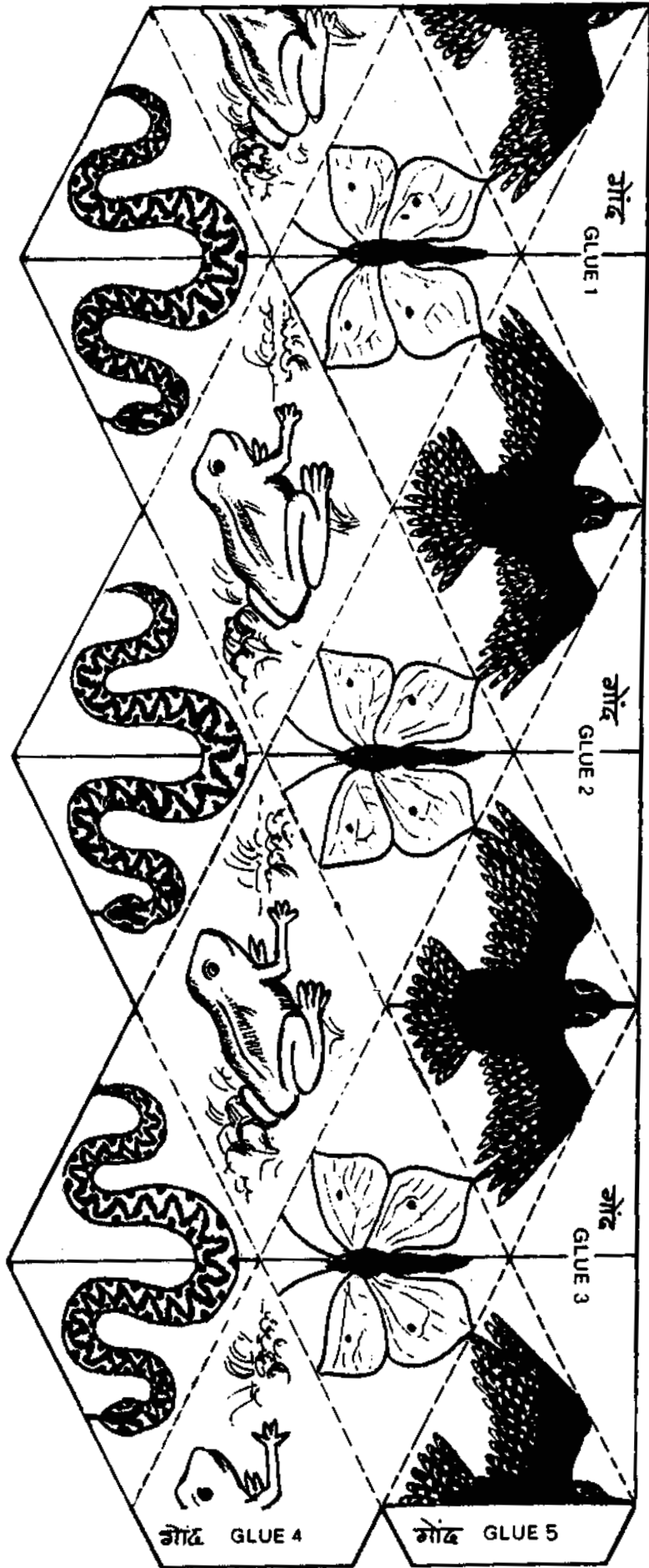

गोंद

GLUE 1

गोंद

GLUE 2

गोंद

GLUE 3

गोंद GLUE 4

गोंद GLUE 5

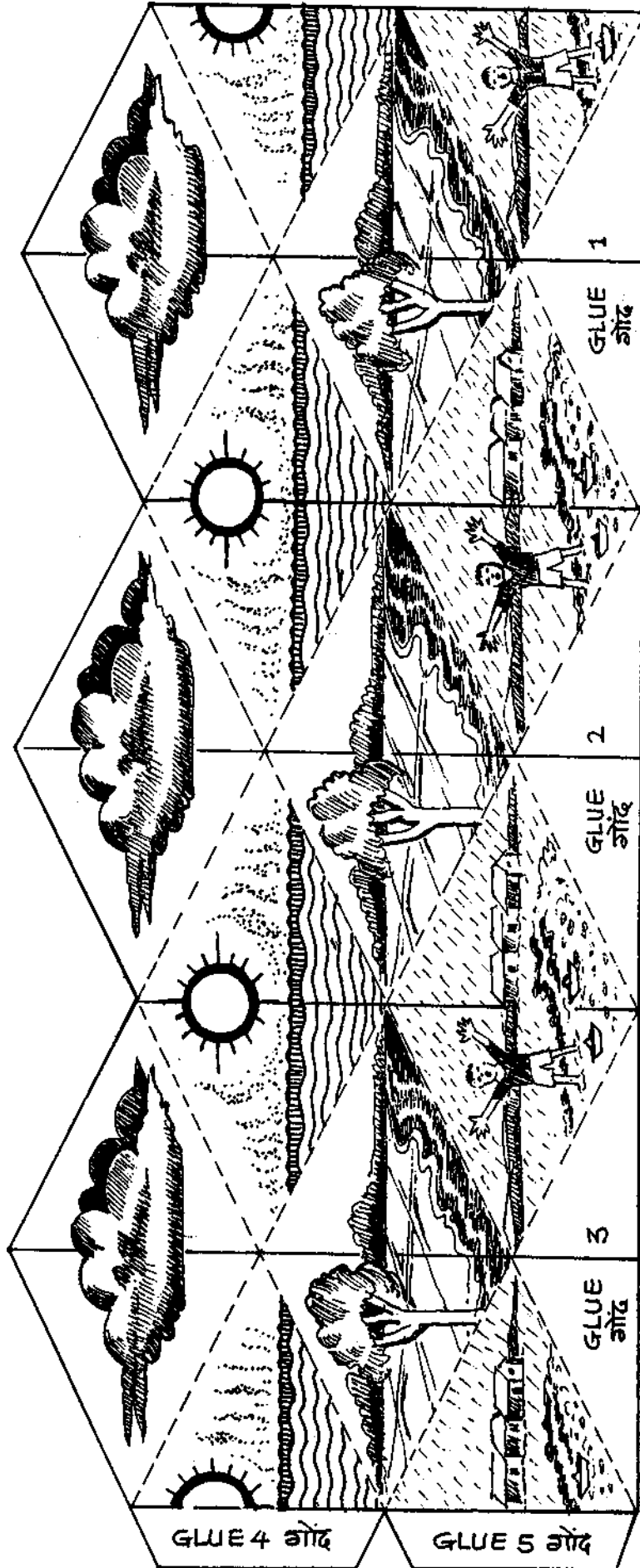

## Plain Paper Flexagon

Having caught the flexagon bug you'll like to make many more. Here is a no-network, no-nonsense way of folding flexagons out of plain paper. No gluing is necessary.



1. Take a rectangular (20 cm x 10 cm) sheet of bond or any stiff paper. The rectangle should be made up of two exact squares.

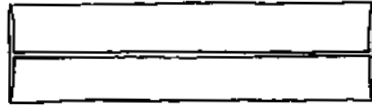

2. Crease the midline along the length, and fold the long edges to this midline.



3. Fold eight equal segments along the width.

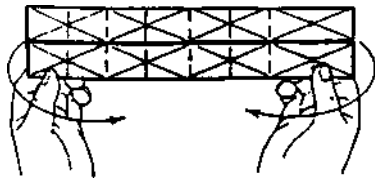

4. With the help of a pencil and scale, first draw the diagonal lines as shown. Then crease them well.

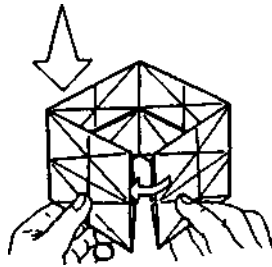

5. Bring the paper's left and right sides together and insert one side inside the other, thereby making a three dimensional prism.

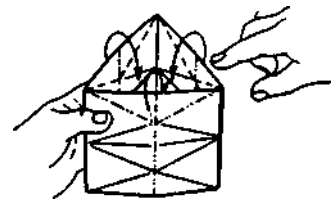

6. Push in the three triangular areas at the top of each other.

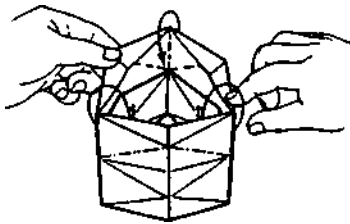

7. Press all the three top points down and through the centre. The next row of triangles will assume a similar shape.

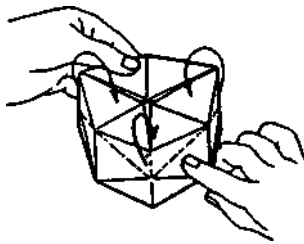

8. Once again, press all the three top points down and through the centre.

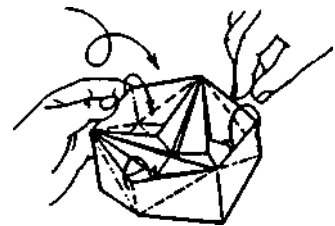

9. Turn the model over and push in the three triangular areas at the top of each other.

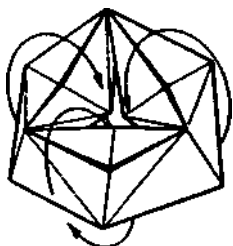

10. This will complete the flexagon. To make it rotate hold it on either side and twist the outer edges in towards the centre, so that the inner surfaces appear.

Every time you rotate the flexagon a different facet is exposed. You can depict a cycle, chain or sequence by drawing a different picture on each of the facets.

## Bow Drill

Normally we see things with our eyes. But we continue to see a thing for a little while longer even after it has been removed from sight. This is called 'persistence of vision'. The principle of the ancient bow-drill, still in use by carpenters can be incorporated into an ingenious folk toy to demonstrate the persistence of vision.

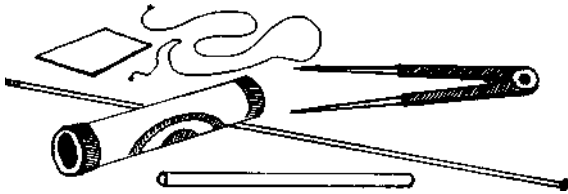

1. You will need an empty cotton reel, thread, divider, ball pen refill or reed, bicycle spoke, card and glue.

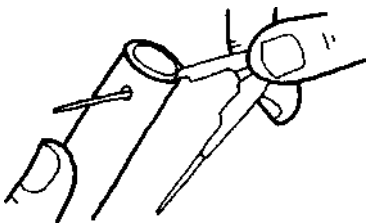

2. Take an empty cotton thread reel. Make a hole about 1 cm from one end with a divider point.

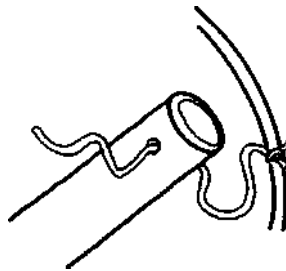

3. Weave a thread through this hole...

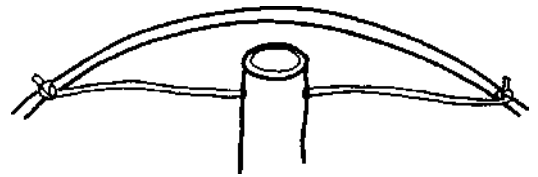

4....and tie its ends to the two ends of a cycle spoke bent into an arc. The bow string should be slightly loose.

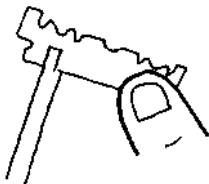

5. An old ball pen refill or reed 10 cm long is split for about 1 cm. on one end.

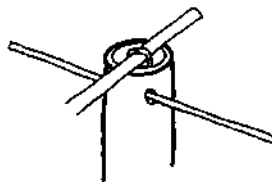

6. Insert the other end of the reed inside the reel and yank out the thread.

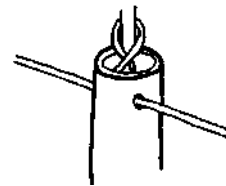

7. Rotate the reed by 180 degrees and insert it inside the reel so that the thread loops once around the reed.

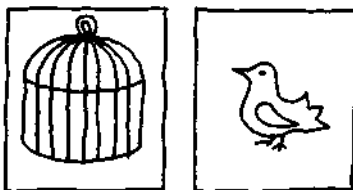

8. Make a bird and a cage on either side of a 3 cm square card sheet.

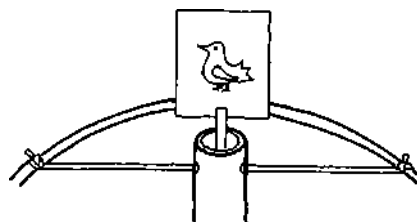

9. Wedge the card in the slit on top of the reed.

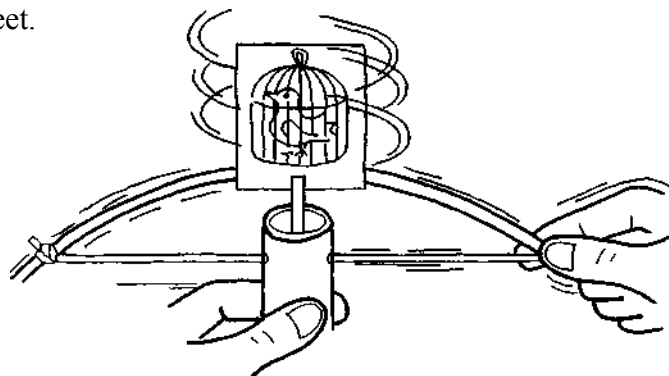

10. On moving the bow to and fro the reed twirls and the bird appears to be encaged.

(Contd. on next page)

The bow drill is a beautiful mechanism. This rudimentary machine converts straight line motion of the bow, into rotary motion of the reed.

If, however, the reel is held in one hand and the reed rotated, it moves the bow to and fro. This familiar mechanism is used in all radio knobs, where rotary motion of the bow is converted into the straight line motion of the pointer.

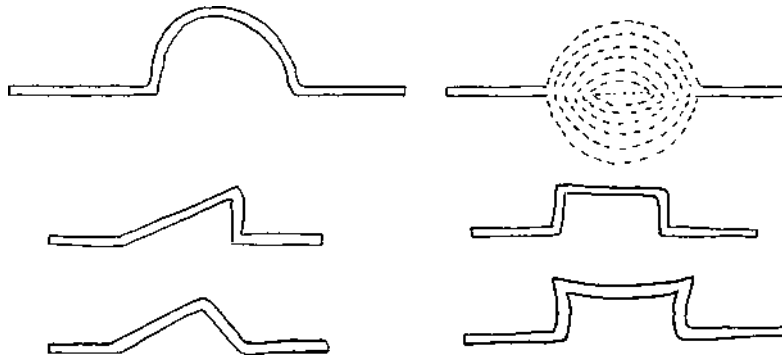

11. This mechanism can also be used for producing rotation of solids. Take pieces of soft wire and bend them in sections as shown. Now twirl them between your fingers to produce a solid of rotation.

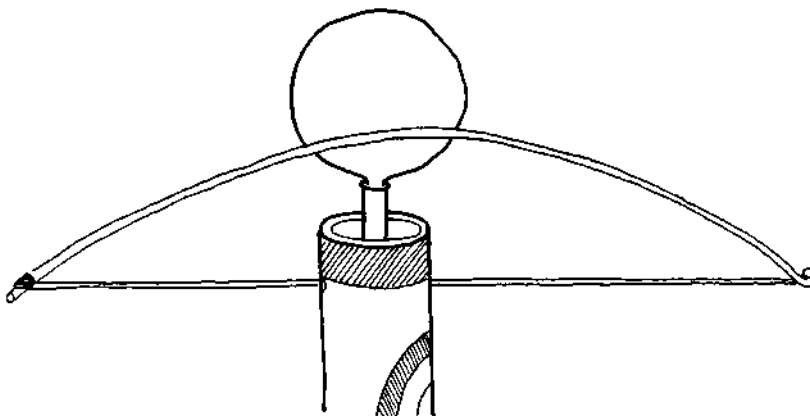

12. If you make a circular hoop of wire and wedge it in the reed of the bow drill, on rotation you will see the spherical profile of a revolving circular hoop..

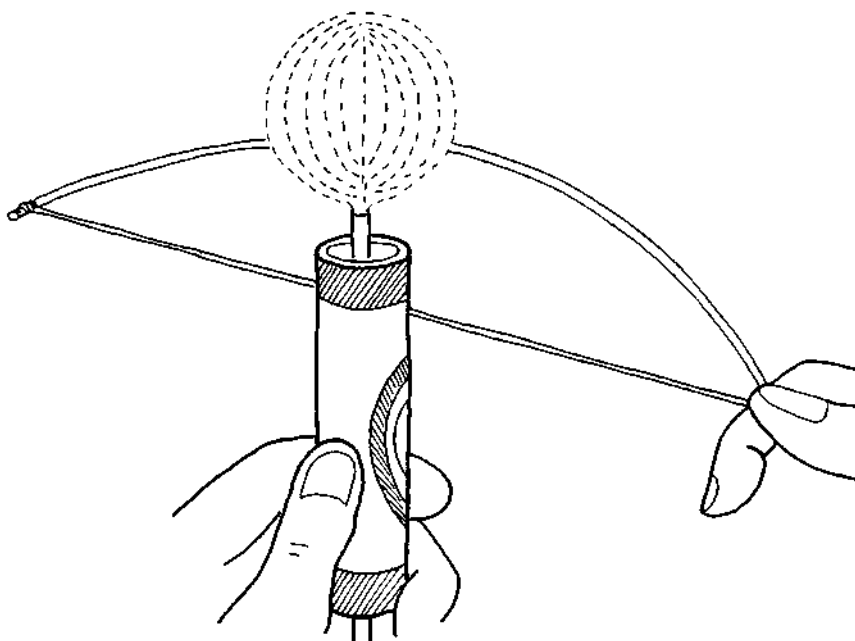

13. If the wire hoop is bent into a rectangular shape then on rotation you will see a cylinder. Make several such interesting rotations of solids.



## Silent Motion Film

If you wave a smouldering matchstick in a dark room you will not see a distinct point of light changing position. On the contrary, as you move your hand you'll see a continuous curve of light. By moving your hand fast enough you can make a glowing figure of eight, circles or ovals. Try making a flip book in which pictures change very gradually from one page to the next. When you let the pages riffle by under your thumb, the pictures blend into one another and there is the illusion of motion. It is very much like looking at a film without sound.

Here is another way of making a short, soundless motion film.

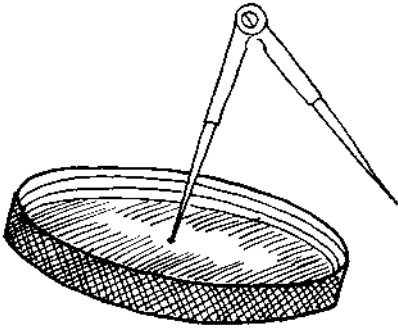

1. Take an old plastic jar lid about 10 cm in diameter and make a hole in its centre with a divider point.

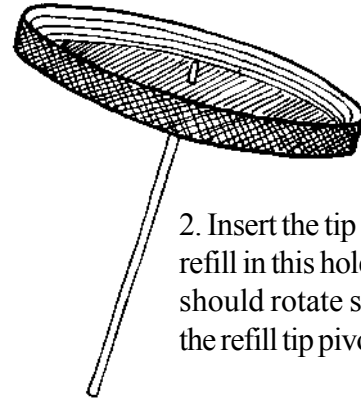

2. Insert the tip of a ball pen refill in this hole. The jar lid should rotate smoothly on the refill tip pivot.

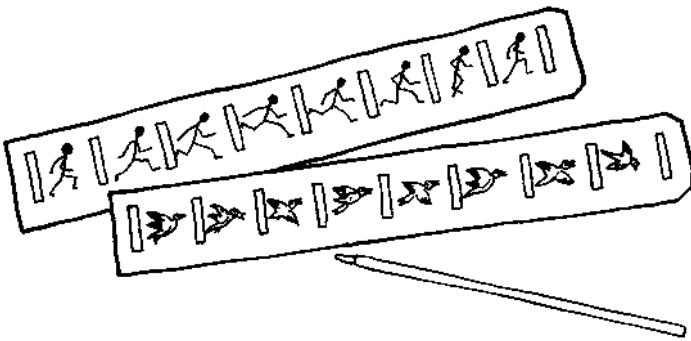

3. Cut a strip of card sheet long enough to go around the circumference of the lid. Draw gradually changing pictures on this strip. Cut slits between the pictures.

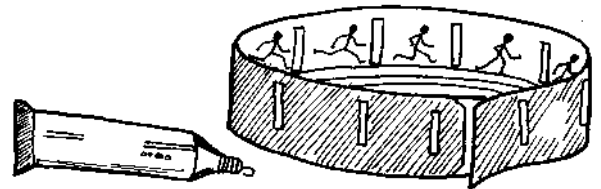

4. Glue the strip on the rim of the lid with the pictures inside.

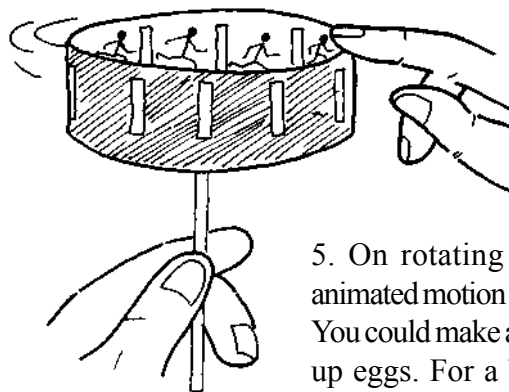

5. On rotating the lid you'll see an animated motion picture of a man running. You could make a bird fly or a joker throw up eggs. For a better view colour the outside of the slit strip black.

## Mirror Puzzles

Nature is replete in symmetry. A butterfly's wings are a good example. One half of the wings can be folded on to the other half to match exactly. The fold then becomes the line of symmetry.

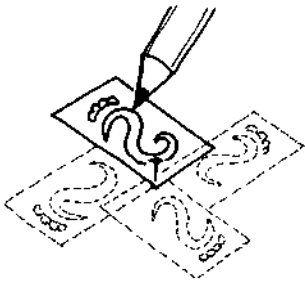

1. Cut a pattern on a postcard. Push a pin in one corner and draw the pattern .



2. Rotate a quarter turn and draw again. Repeat it to get. It shows rotational symmetry.

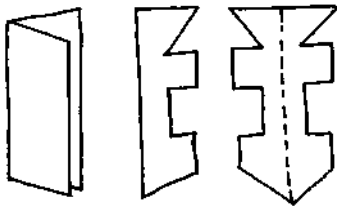

3. Fold a paper in half. Cut shapes in its edges. Open the paper to see pattern .

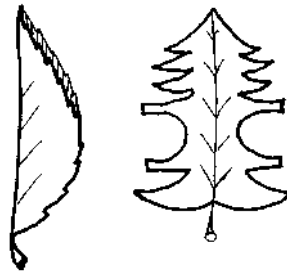

4. Which is the line of symmetry? You can use leaves too for this purpose. Invent lots of new shapes.

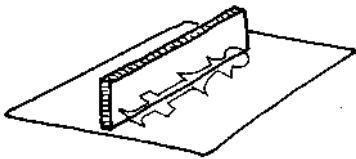

5. Draw a shape and put a mirror beside it so that the shape doubles itself.



6. Search for compound leaves that look as if they have been doubled up in a mirror.

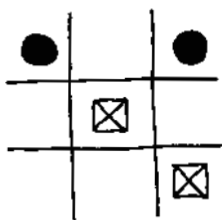

**Master Pattern.**

7. Stand the mirror on this **Master Pattern**. Slide and turn the mirror to see the patterns change.

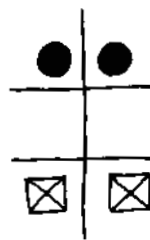

8. Now orient the mirror on the **Master Pattern** in such a way so that you can see the patterns which match with this. Is your mirror on a vertical line facing to the right?

9. Again place the mirror on the **Master Pattern** in different orientations to get the other patterns.

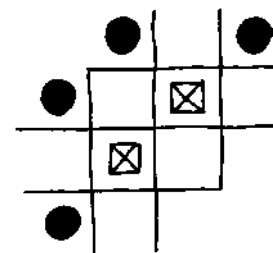
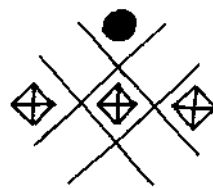
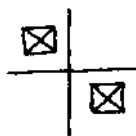
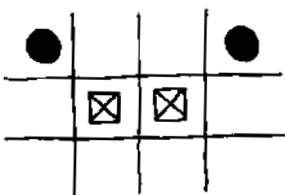

(Contd. on next page)

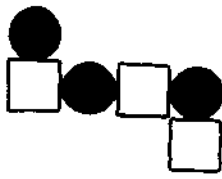

Mirror Masters

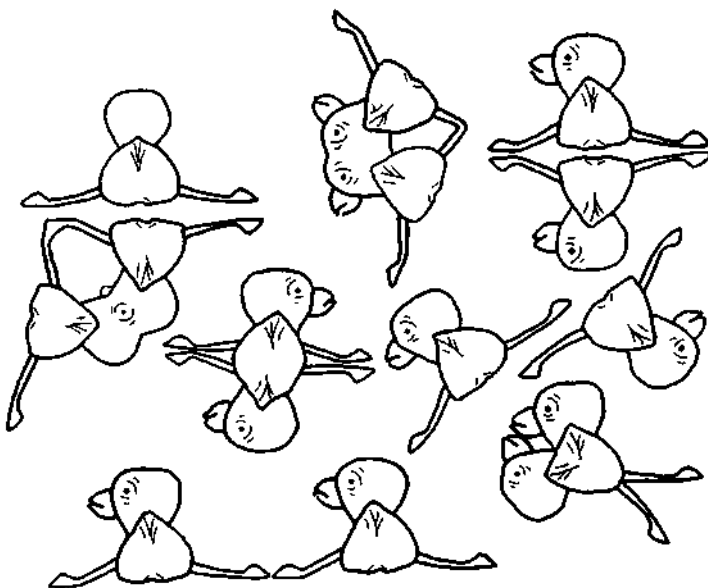
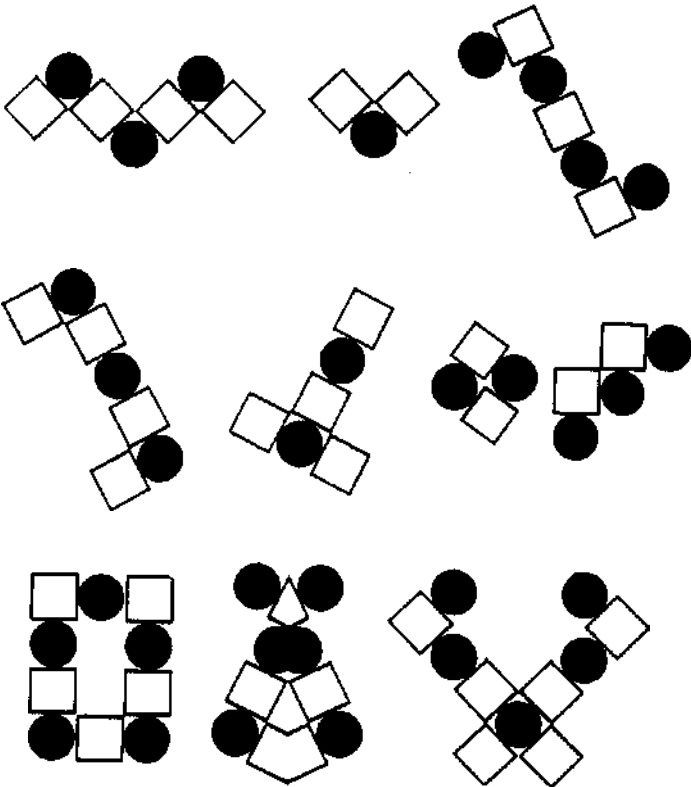

Two Mirror Masters - one composed of squares and dark circles, and the other of a chick are given here. Each time you have to place your mirror on the mirror master only, in various orientations and get all the patterns given below. You'll be able to get most of them. But some of the patterns have been included to trick you. They are not simply hard, but they are impossible. Can you locate the impossibilities? If you have enjoyed these mirror puzzles why not make some of your own.

By now you must have seen that some shapes have more than one line of symmetry. Some have none. How many lines of symmetry are there in a square? Four, isn't it. Place a mirror strip on each of these lines and see how the square remains unchanged. Can you place the mirror to make squares of different sizes? On the other hand any line which passes through the centre of the circle is a line of symmetry, but can you place the mirror to make different sized circles?

Develop an eye for looking at symmetries. You'll find them everywhere - even in alphabets and numerals. Which alphabets have no line of symmetry? Which have one? Two? Write your name in capital letters. Find the alphabets which have at least one line of symmetry.

## Drop and Bulb Microscopes

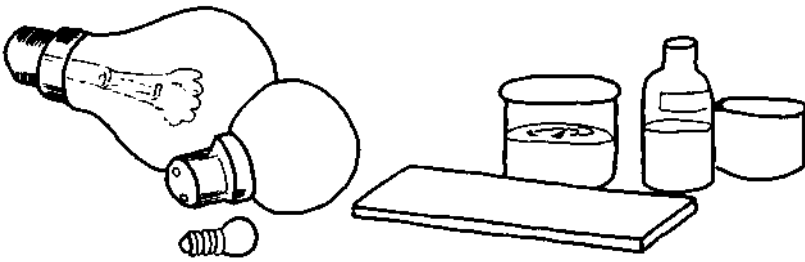

1. You will need glass slides, various sizes of bulbs, water, oil and a bit of glycerine.

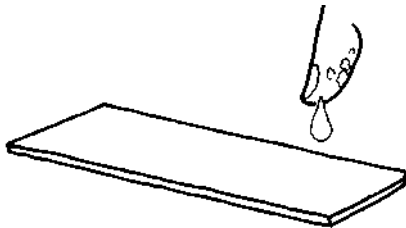

2. Take a broken glass pane or slide and rub it on your hair to apply a thin layer of oil. Gently place a drop of water on the slide.

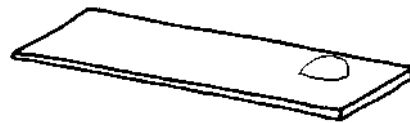

3. The water drop 'sits' on the slide and makes a plano-convex lens.

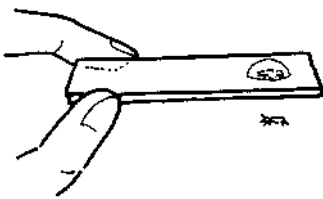

4. Look at some small print or an ant through the drop lens. Do the ant's legs appear any bigger? Now quickly invert the slide, so that the drop instead of 'sitting up' will be 'hanging down'.

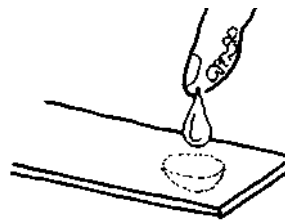

5. Place another drop on the slide right on top of the previous drop to make a double convex lens.

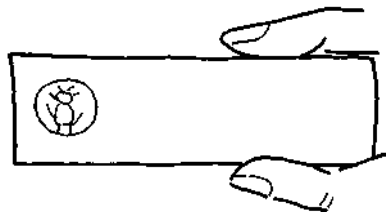
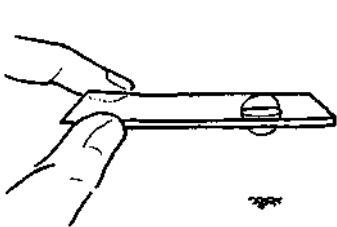

6. Does the 'hanging-sitting' combination make any difference to the magnification? Repeat the experiments using drops of glycerine and coconut oil instead of water. Does it make any difference to the clarity, magnification?



7. Remove the filaments of a 40 Watt, Zero Watt and torch bulbs by carefully hammering at the resin ends. Half fill the bulbs with water. The water surface in combination with the bulb curvature makes a plano-convex lens.

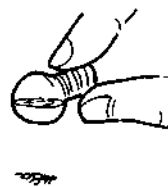
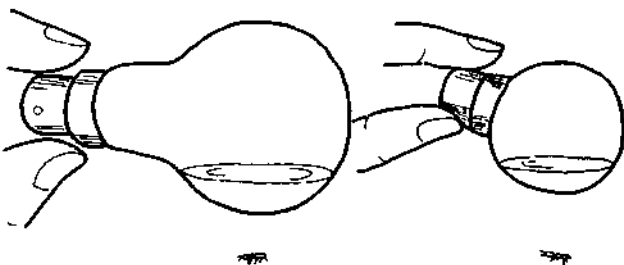

8. Observe the same object through all the three bulbs. Which bulb magnifies the most? You'll see that the torch bulb, with the least radius of curvature magnifies the most. You can now see that magnification is inversely proportional to the radius of curvature.

## Ray Model

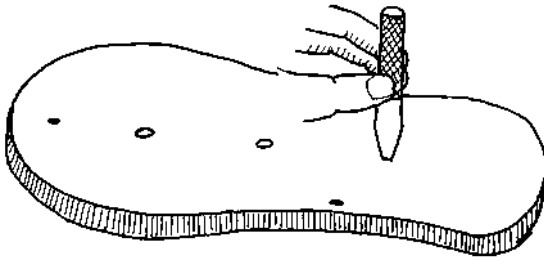

1. Punch out three holes 5 cm apart on an old rubber slipper. Press fit 20 cm long *phooljhadu* sticks or pencils in these holes.

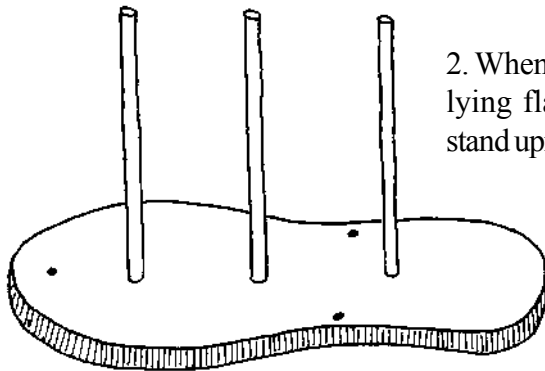

2. When the slipper is lying flat, the sticks stand upright.

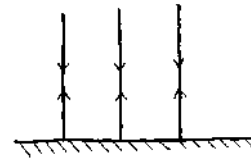

3. Suppose the rubber slipper was a plain mirror strip, then light rays striking it at right angles will again retrace their path as in the ray diagram.

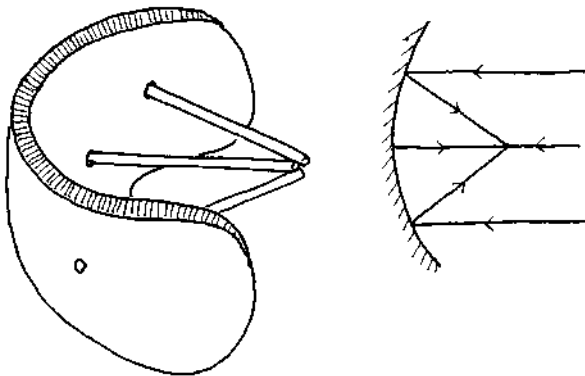

4. What would happen if instead of a plain mirror you had a concave mirror? Just bend the rubber slipper inwards and see. The three sticks now converge at a point called the FOCUS.

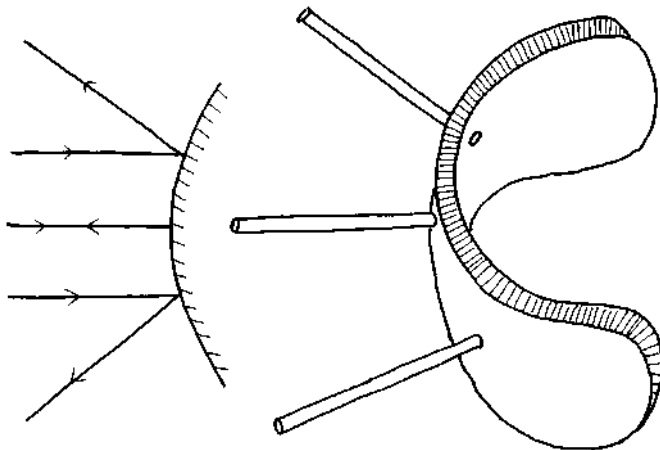

5. What would happen if instead of a plain mirror you had a convex mirror? Just bend the slipper the other way and you'll see the sticks diverging.

As glass cannot be flexed and rays are invisible, this model will be of some help in concretising the concept of ray diagrams through curved mirrors.

## Roulette

Empty ball pen refills are not for throwing for they make beautiful bearings.

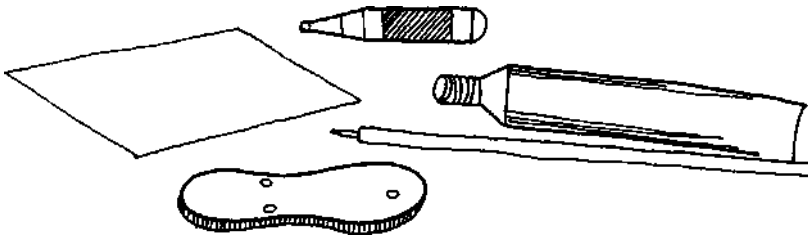

1. You will need cardboard, old ball pen refill, glue, hole punch and rubber from an old rubber slipper.

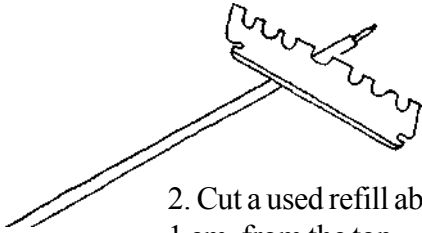

2. Cut a used refill about 1 cm. from the top.

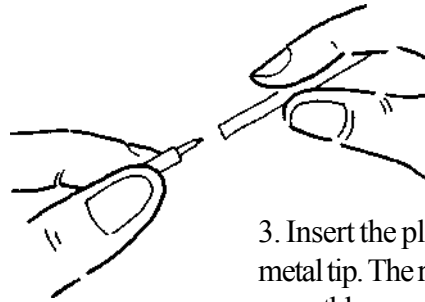

3. Insert the plastic refill on its metal tip. The refill goes in very smoothly.

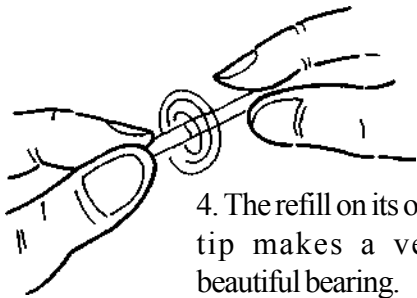

4. The refill on its own tip makes a very beautiful bearing.

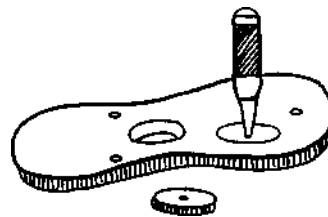

5. Punch a 2 mm hole in a rubber disc cut out of an old slipper.

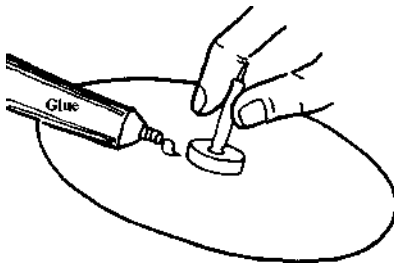

6. Stick this disc at the centre of a 20 cm diameter cardboard. Insert a 1 cm. refill with the brass tip in the disc hole.

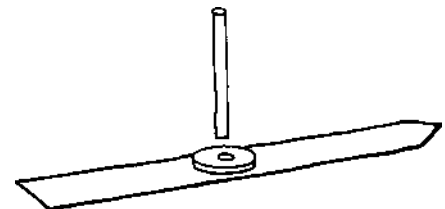

7. Cut a 20 cm long and 1 cm wide pointer out of cardboard. Stick another rubber disc with a hole as in Fig (5) at its centre.

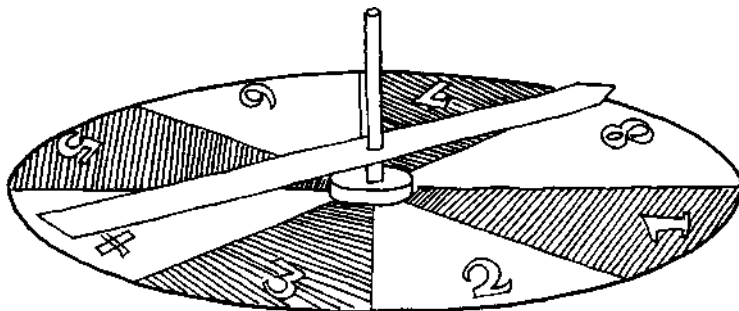

8. Insert a 8 cm long plastic refill in this disc.

Place the refill in the pointer on the refill tip in the middle of the cardboard disc. On twirling the pointer refill, the pointer rotates very smoothly on the disc. Place a circular paper disc divided into 8 equal parts on the cardboard disc. The roulette has now become a dice of eight. By changing the paper disc you can make a dice of any number. You can also make a number of matching games - matching of colours, shapes etc.

## Broomstick Table

This article is inspired by the fascinating work of Mr. P. K. Srinivasan of Chennai. Tables are often learnt by rote. This repetitious drill might help quick recall but it kills the whole joy of learning. With only 18 equal length broomsticks children could discover the whole world of tables.

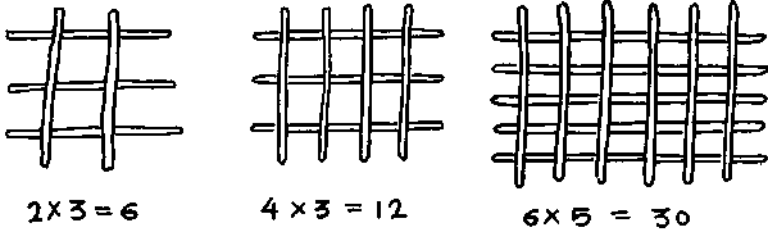

1. Lay one broomstick and place another one across it. At how many points do they meet? Obviously, one.

So,  $1 \times 1 = 1$ . If two vertical broomsticks are placed criss-cross over three horizontal broomsticks then they have six junctions. So,  $2 \times 3 = 6$ .

○	1	2	3	4	5	6	7	8	9
1									
2			6						
3									
4			12						
5									
6					30				
7									
8									
9									

2. Children can make a 0 to 9 matrix on a square ruled copy and make their own table sheet by placing broomsticks criss-cross and counting the number of junctions. So, children who have learnt to count should be encouraged to make their own table sheets.

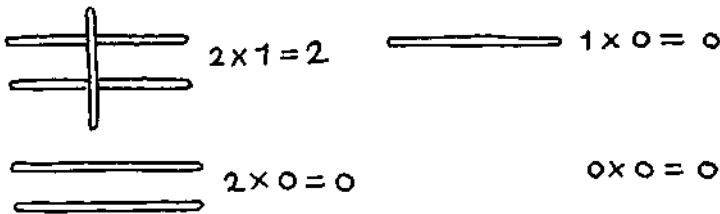

3. This picture shows how the abstract concept of multiplication by zero can be concretised.

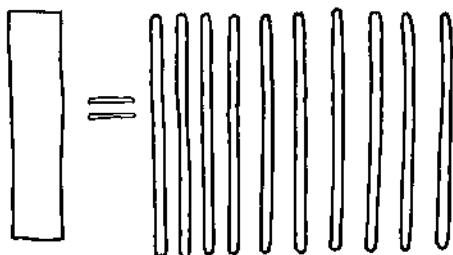

4. Multiplication of two digit numbers would mean counting too many junctions. So, ten broomsticks can be represented by one card strip.

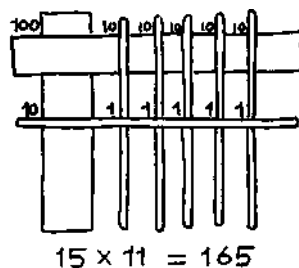
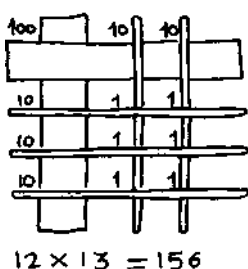

5. Criss-cross of two strips will be  $10 \times 10 = 100$ , while that of a strip and a broomstick will be  $10 \times 1 = 10$ . Add up the sum of all the junctions to get the multiplication value.

## Aeroplane Wing

What makes an aircraft fly? How does the aircraft's wing produce lift? You can find this by making a model of part of an aircraft wing.

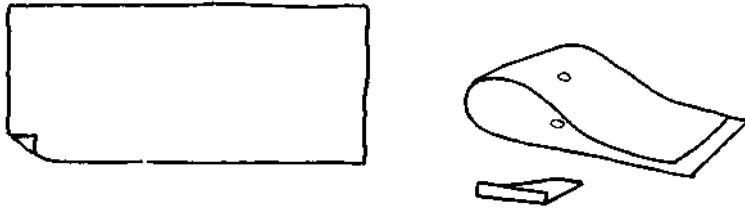

1. Cut a piece of paper 20 cm long and 10 cm wide. Bend it in half as in and stick the edges together. Run a fold along the edge with your finger nails so that it bends, curved at the top and almost flat underneath. The flat end of the wing is the leading edge, and the thin edge is the trailing edge.

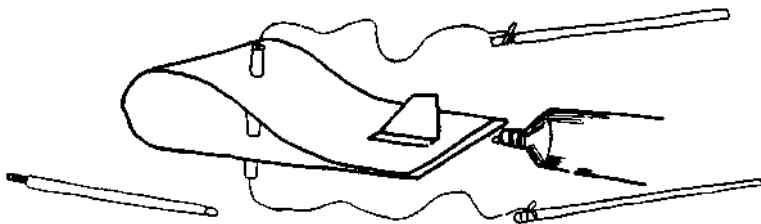

2. Make a hole straight through both parts of the wing about 3 cm from the leading edge. Pass a piece of empty ball pen refill or soda straw through it and fix it with a dab of glue.

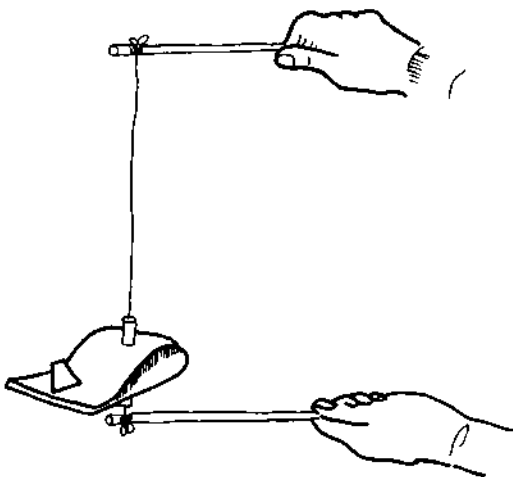

3. Stick a piece of paper on the centre line of the trailing edge. This fin will stand vertically on the trailing edge and will help in stabilising the wing. Pass a thin thread through the refill and fix it on two sticks.

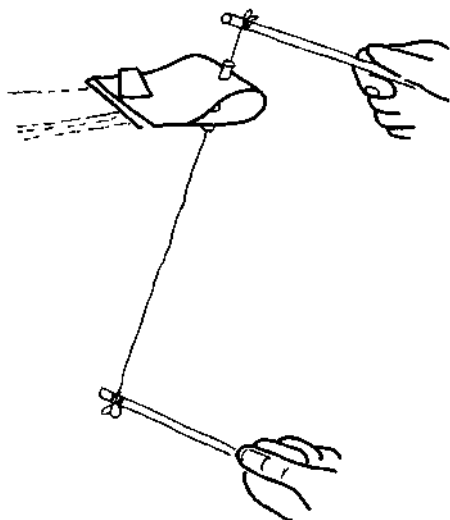

4. As you swing the sticks through the air the wing will rise on the thread. The top curved portion of the wing is longer than the bottom portion, so the air moving over the top has further to go and therefore it moves faster. This produces a lower pressure on top of the wing producing lift. This is how a wing helps an aeroplane to rise in the air.



## Spring Bangle Balance

Plastic spring bangles are sold as village trinkets. They are available in attractive colours and come cheap. These spring bangles can be used as low stiffness springs for a number of simple experiments.

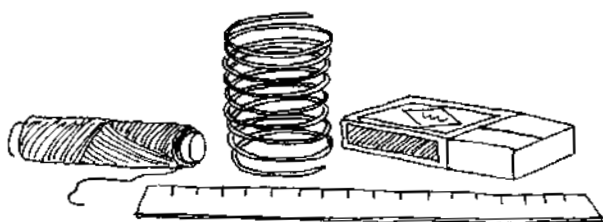

1. You will need a spring plastic bangle (like a Slinky), thread, empty matchbox, coins and a scale.

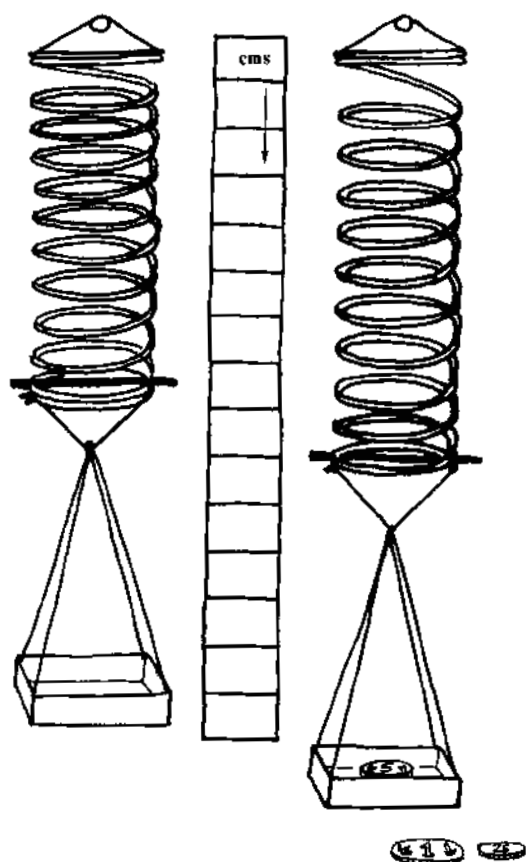

2. Tie a thread loop to hang the bangle by a nail. Hang a matchbox drawer at the bottom for the pan. Fix a broomstick piece on the bottom coil to act as the indicator. Mark the initial position of the indicator with the pan empty. Coins have standard weights. A 2 paisa coin weighs 1 gm, 50 paisa 5 gm and 25 paisa 2.5 gm. Place coins for different weights on the pan and measure the extension in each case.

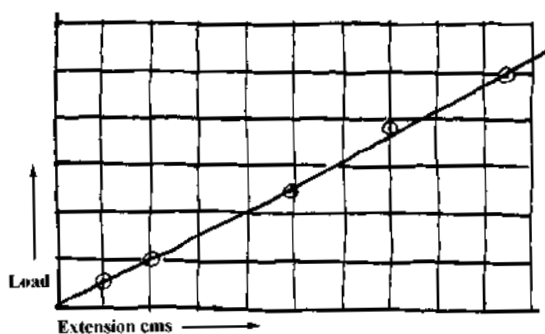

2. When the load is plotted against the extension on a graph paper, almost a straight line is obtained, proving Hooke's law - that within elastic limits, the stress is proportional to the strain.

The calibrated spring bangle can also be used as a very sensitive spring balance as it has a measurable response to even one gram load.

Hold the top thread loop and oscillate the spring bangle with the empty pan. Note the time taken for 10 oscillations. Repeat this with different weights in the pan.

## Press Button Switch

The middle school children in the Hoshangabad Science Teaching Programme do a number of experiments with torch bulbs and batteries. Several alternatives have been tried, modified and rejected. All switches with steel strips tend to rust and have high contact resistance.

Mr. Vivek Paraskar of Eklavya, Ujjain found a very ingenious solution to the switching problem. He used press buttons. They are made of brass, so they never rust.

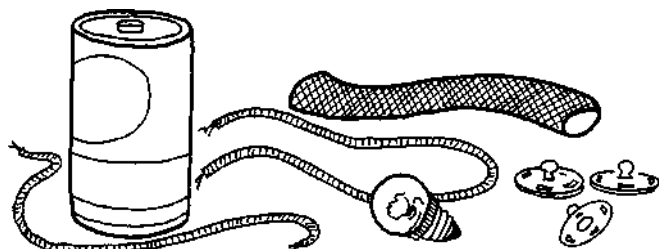

1. You will need brass press buttons, torch bulb, torch battery, wires and an old bicycle tube.

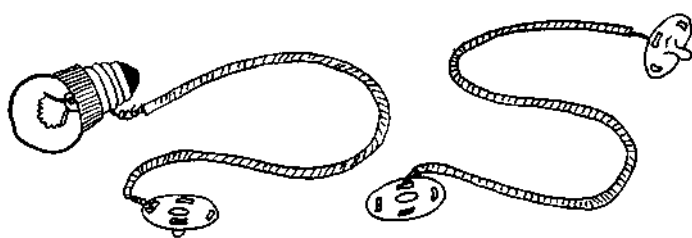

2. Connect one wire to the bulb and button and the other to two halves of the press button.

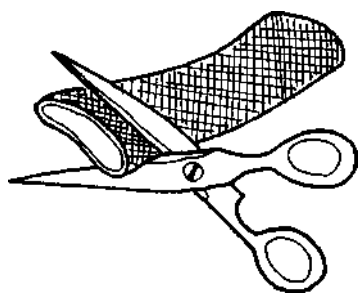

3. Cut a 1 cm wide rubber band out of an old cycle tube.



4. Cut two circular notches at the diametrically opposite ends of this band.

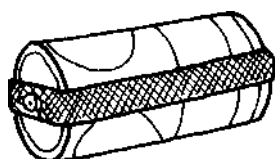

5. Stretch and slip the band on the battery. The positive top of the battery top sits in one notch.

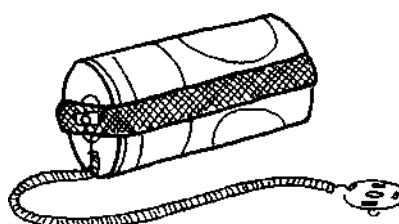

6. A press button half with a pip sits in the other rubber notch at the battery bottom.

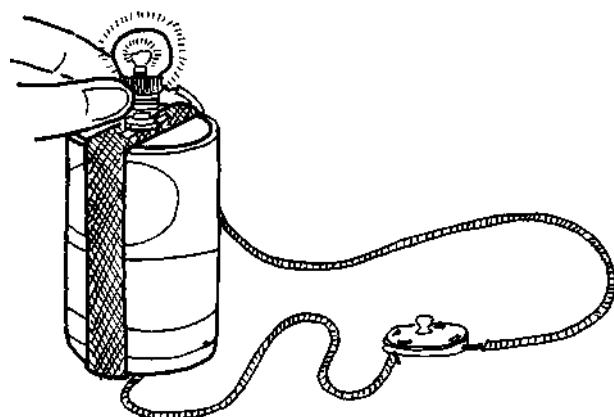

7. Place the bulb on the battery top and snap close the two parts of the press button to close the switch, and light the bulb.

## Chromatography

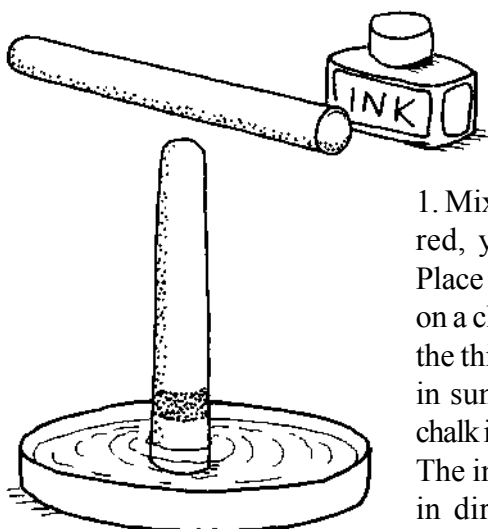

1. Mix a few drops of black, red, yellow and blue ink. Place a few drops of this ink on a chalk about 5 mm from the thick end. Dry the chalk in sunlight. Now stand the chalk in a lid containing water. The ink band should not be in direct contact with the water.

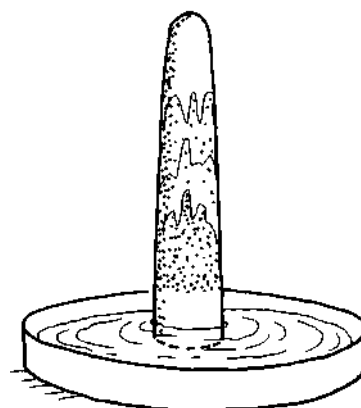

2. After some time the water rises up the chalk and the different colours are separated in distinct bands.

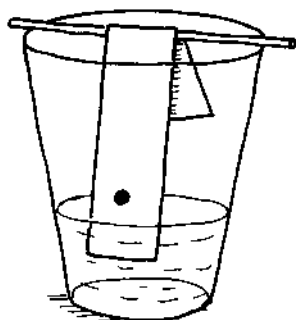

3. Take a strip of blotting paper and place a small drop of the mixture ink on it about 1 cm from the end. Dip the strip in water and fold and rest the other end on a broomstick on a glass. Ensure that the water level in the glass is below the ink dot.

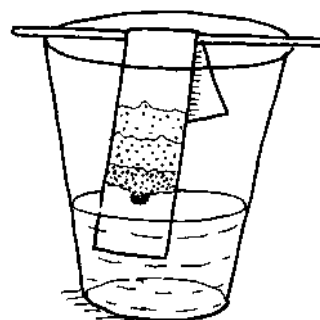

4. After some time as the water rises on the blotting paper, the colours of the ink mixture are dispersed in distinct bands.

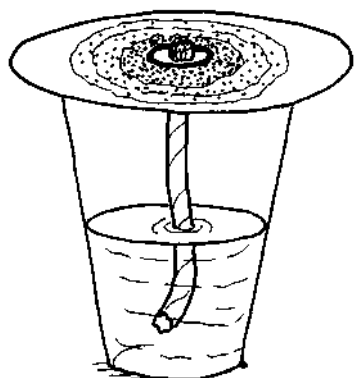

5. Make a 5 mm hole in the centre of a circular blotting paper. Mark a circular mixture ink ring slightly away from the hole. Place a wet cotton wick in the hole and rest the paper on a tumbler with the wick dipping in water. After a while the ink mixture is dispersed in beautiful circular bands. This technique known as chromatography is used for separating mixtures in several industrial processes.

## Trees Nameplates

Every tree has a name though we seldom know it. If there was a name plate on every tree then people could read it and know its name. Putting name plates on trees would be very useful public education. Normally a mild steel plate is taken and painted black. The name of the tree is painted in white and then it is nailed to the tree. The trouble with this traditional technique is that the mild steel soon rusts because it is exposed to the elements. Within a year or two the paint peels off.

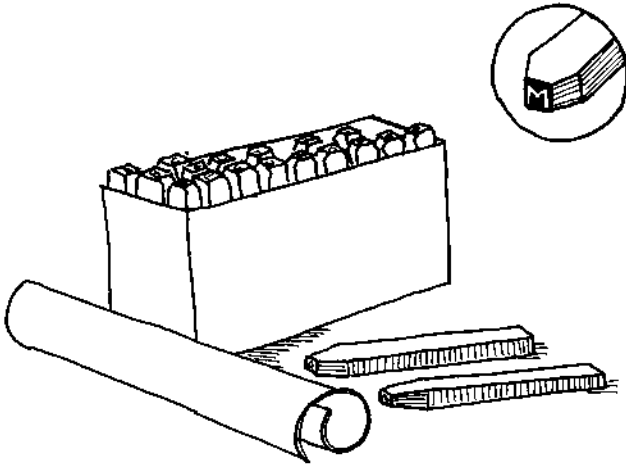

1. A simple way of making tree name plates is by punching thin aluminium sheets with alphabet punches. These hard steel chisel like punches are available in hardware stores. These punches also come in various sizes.

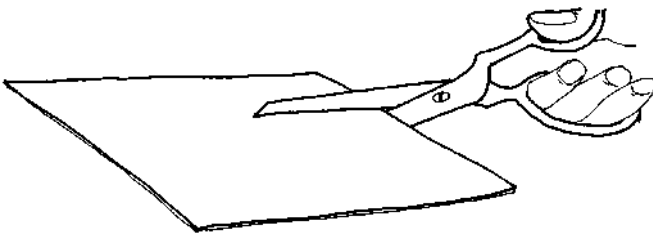

2. Cut a 10 cm x 5 cm piece of aluminium sheet. It is soft enough to be cut with a home scissors. Keep this sheet on a plank of wood and using A, B, C, D alphabet punches emboss the name of the tree.

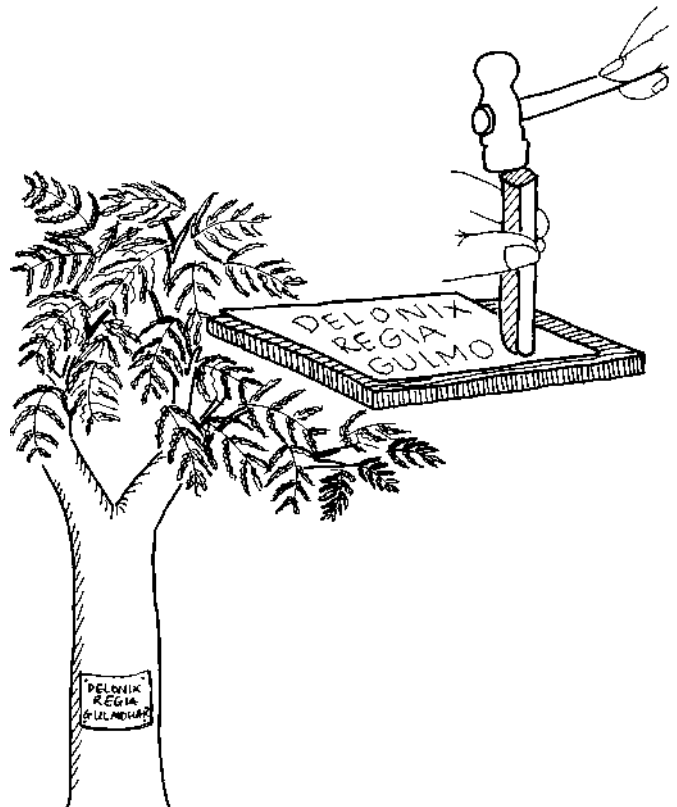

3. These embossed aluminium tree name plates never rust and there is no paint to peel off. They require no recurring maintenance. Schools could easily take up this socially relevant project.

## Tangram

This is a thousand year old Chinese puzzle. Cut any size square into seven pieces as shown in the picture. Now assemble the seven pieces to make shapes of animals, birds, human beings etc. In each case all seven pieces have to be used. Make more shapes on your own.

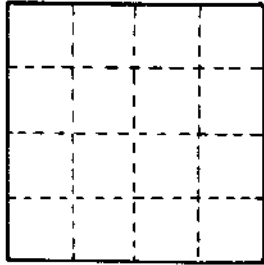

1. Mark 16 small squares in a cardboard square of edge 10-cm.

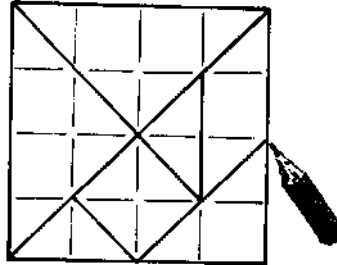

2. Draw the lines as shown.

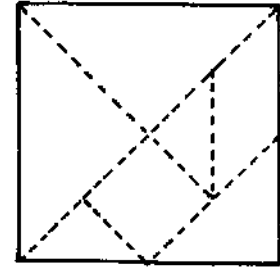

3. Cut along the lines and you have seven pieces of the TANGRAM.

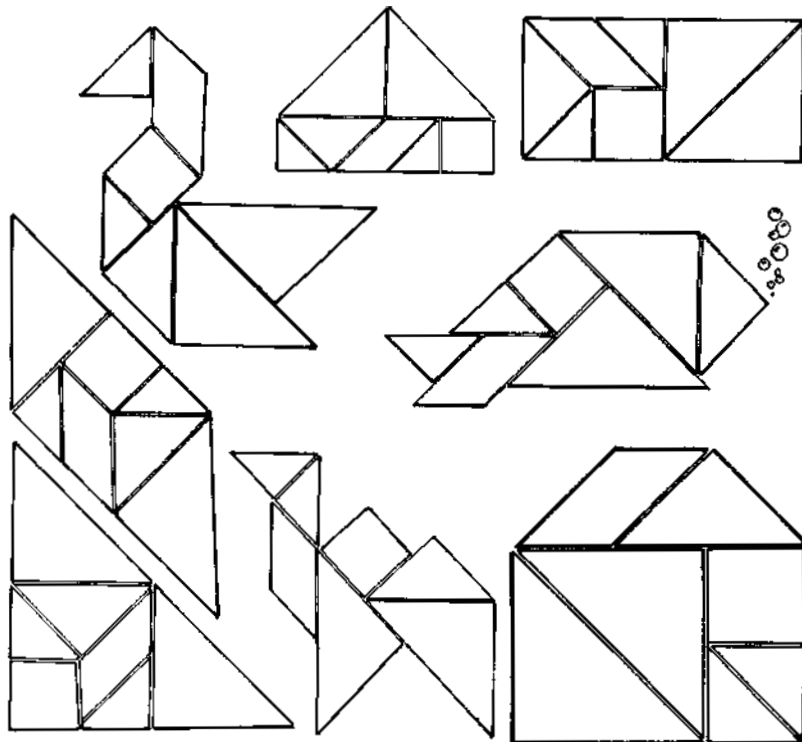

4. Make more shapes. In each case use all the seven pieces of the Tangram

