

Denys Saunders has been involved in the problems of communicating ideas for over 25 years and it is from his wide experience that he writes. He is concerned primarily with Christian communication, but the hope is that this book will meet a need in training colleges and with all teachers and communicators, whether involved in school classes or in adult education in the fields of community development, agriculture, health, youth and other social work.

The author knows well the limits upon supplies of materials, particularly in rural districts and these limits have been accepted as a starting point in showing the best visual media and methods of use in the context of a democratic relationship between teacher and student.

The aim has been to prepare a training manual which will be used and not just a book to be read. Reading about a subject will not teach you to communicate through visuals any more than reading about swimming will teach you to swim! Learning is in the doing, and consequently each chapter includes suggestions for practical activities.

Mr G. Rushbridger, who was Director of the Oversea Visual Aids Centre in London for about fifteen years, is convinced of the need for this book. He says: 'I am sure that Mr Saunders' book will be invaluable because he writes against a background of many years of collaboration with teachers and others in Asia and Africa, and of putting into practice with marked success the principles and ideas he advocates so convincingly.'

UNITED SOCIETY FOR CHRISTIAN LITERACY  
100, NEWINGTON GREEN, LONDON SE16 5PU

01 50

# VISUAL COMMUNICATION HANDBOOK

TEACHING AND LEARNING  
USING SIMPLE VISUAL MATERIALS

*Denys J. Saunders*

UNITED SOCIETY FOR CHRISTIAN LITERATURE  
LUTTERWORTH PRESS  
GUILDFORD AND LONDON

*First published 1974*

*Second impression 1976*

ISBN 0 7188 2083 5

COPYRIGHT © 1974 DENYS J. SAUNDERS

*Printed in Great Britain  
by Ebenezer Baylis and Son Ltd.  
The Trinity Press, Worcester, and London*

## CONTENTS

	Page
<i>Foreword</i>	4
<i>Introduction</i>	5
<b>Chapter</b>	
1. COMMUNICATION	7
2. THE VALUE OF VISUALS	15
3. SELECTING PICTURES	18
4. PAPER PICTURES	24
5. SEQUENCE PICTURES	33
6. DRAWING MATERIALS AND BASIC SKILLS	42
7. CHALKBOARDS	53
8. POSTERS AND CHARTS	61
9. DISPLAY BOARDS	70
10. FLANNELGRAPH AND OTHER ADHESIVE AIDS	74
11. DEMONSTRATIONS	82
12. TOURS AND VISITS	84
13. OBJECTS AND SPECIMENS	86
14. MODELS	89
15. DRAMA	92
16. PUPPETS	95
17. PROJECTED STILL PICTURES	100
18. PROJECTION SCREENS	110
19. MOVIE FILMS	115
20. THE MULTIPLE-MEDIA APPROACH	121
21. EVALUATION	125

## FOREWORD

IN RECENT years innumerable conferences and seminars have been held in many parts of the world at local, national and international level on the uses of audio-visual media in formal and informal education. Much, too, has been written on the same theme in books and educational journals. Some may question therefore whether there is a need for yet another book on the same subject.

Many who are involved in using audio-visual methods and materials in developing countries have frequently told me that they have to work to a very limited budget for educational materials. One consequence is that there are seldom the funds for the purchase of commercially produced aids and that even if there were, many aids would not be appropriate to the cultural and educational needs of the people. Nor can schools or training centres afford to employ technicians to operate or service equipment, as is the case in high-income countries.

Under these circumstances, teachers and extension workers from many parts of the developing world express needs which are remarkably similar in spite of widely dissimilar cultural and geographical backgrounds. They want a simple and practical guide to the making and use of audio-visual resources. By 'practical' they mean suggestions and ideas on materials and equipment which are usually obtainable locally and at reasonable cost. Secondly, they want a clear and convincing explanation of the special contribution that audio-visual resource materials can make as part of the whole educational process.

In both respects I am sure that Mr. Saunders' book will be invaluable because he writes against a background of many years of collaboration with teachers and others in Asia and Africa, and of putting into practice with marked success the principles and ideas he advocates so convincingly.

G. H. RUSBRIDGER

*formerly Director, Oversea Visual  
Aids Centre, London.*

## INTRODUCTION

THIS BOOK has grown out of 10 years' experience in rural India and a further 13 years working with, and learning from, people in many countries who are interested in the communication of ideas. Some of the basic material appeared in *Visual Aids for Village Workers* published by the Christian Association for Radio and Audio Visual Service in India in 1960, but everything has now been completely rewritten in the light of further experience and the needs of other parts of the world.

The aim has been to prepare a training manual which will be *used* and not just a book to be *read*. Reading about the subject will not teach you to communicate through visuals any more than reading about swimming will teach you to swim! Learning is in the doing and consequently each chapter concludes with *Projects for Practice*.

The book is written by one who is concerned primarily with Christian communication, but the hope is that it will meet a need in training colleges and with all teachers and communicators, whether involved in school classes or in adult education in the fields of community development, agriculture, health, youth and other social work.

The limits of many rural situations have been accepted as a starting point, but the principles, media and methods will be found appropriate for both rural and urban situations.

The aim has been to deal with visual *media* and utilization *methods* in the context of a democratic *relationship* between teacher and student.

Several more aspects of visual communication might have been included, but the subject is so vast that even the addition of a further five or six chapters would not have covered everything.

Friends in many parts of the world will no doubt recognize in these pages suggestions which they have made or ideas which they have offered and many thanks are due to the hundreds of people who have shared their experience with me over the years.

Selly Oak Colleges,  
Birmingham. 1973.

DENYS J. SAUNDERS

## Chapter 1

### COMMUNICATION

Have you ever found it difficult to get other people to understand what you mean or to do what you want them to do? The health educator wonders why people do not follow his good advice on hygiene and nutrition. The agricultural demonstrator finds it difficult to get farmers to accept new methods. Teachers have discipline problems in class, and preachers are disturbed by the fact that their congregations appear to show little interest in their sermons. Exhortations about war and peace, race relations, family planning, smoking, alcoholism, honesty and a hundred other issues seem to fall on deaf ears. Evidence all around us and our own personal experiences suggest that successful communication is not easy.

Educators, government officials, social workers and many others have to find ways of solving this problem. It is vital that we learn how to communicate well.

But, what is communication? Ask twenty people and you will get twenty different answers!

Without attempting a definition, let us look at different aspects of the subject. Seven questions will show the areas to be explored. Who? Says what? With what purpose? To whom? In what situation? By what means? With what effect?

#### WHO?

In your role as communicator (teacher, preacher, extension worker, artist, etc.) you must know what you are talking about. Your audience must believe in you and they must accept you as a person. You need to be a sympathetic listener.



#### SAYS WHAT?

Define the contents of your message—the skills, the information or the attitudes that are to be communicated. The content may be dictated by the school syllabus, by the Church lectionary or by the immediate needs of the community.



### WITH WHAT PURPOSE?

Be clear about the response you want the audience to make. What do you expect them to do? In most learning situations your purpose will be one or some of the following: Teaching skills, presenting facts, organizing knowledge, stimulating imagination or changing attitudes.

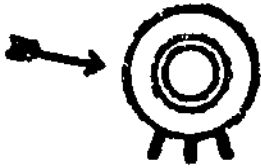

### TO WHOM?

A person's background affects how he learns, so you need to know something of your audience's previous experience, learning abilities, interests, attitudes and values. Do not assume that you know all these things. Even in your own village or town be ready to listen and learn.

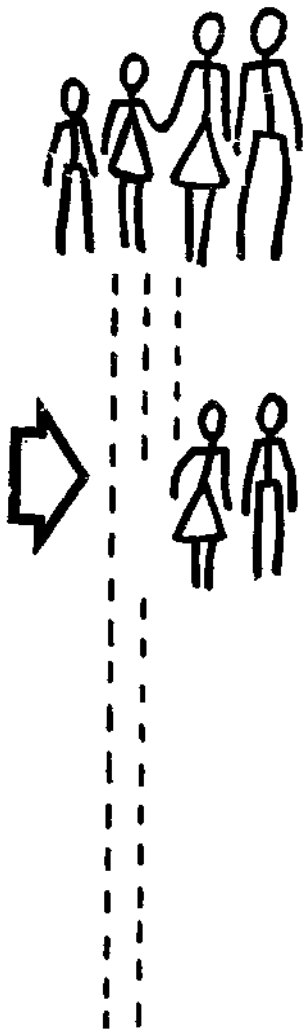

There are three factors which may be barriers to learners understanding your message.

(a) *Physical*. Can the learner see and hear properly? It is your responsibility to be clear in speech and visual presentation.

(b) *Intellectual*. Can the learner *understand* what he sees and hears? A lot depends on his natural ability, home background and schooling. The experience of a town dweller who has had 10-12 years of education is very different from that of a village man. A farmer may not be able to read, but he is not ignorant or immature. Like many people, his attention may be distracted easily and afterwards he may find it difficult to bring his mind back to the subject, but his experience of life often makes up for a slow rate of learning. What you say and show, and the speed of your presentation, must always be appropriate to the audience.

(c) *Emotional*. Is the learner ready, willing and eager to receive the message? A person's attitude is influenced by his cultural background, his ways of thought and his beliefs. People who believe that a film is just for entertainment will be less responsive to its use in education. Some villagers are emotionally involved with their cattle or land, and show an immediate opposition to any suggested change affecting them. In



general, people willingly give their attention to subjects which interest them and are eager to learn, and often ready to make changes in their lives when offered a suggestion meeting a need which they have recognized.

#### IN WHAT SITUATION?

The physical situation affects many aspects of learning. What sort of building are you using or are you in the open air? Is there room to move around? Is it day-time or night-time? Hot or cold?

Numbers and relationships matter, too. Reading a poster may be an *individual* activity. A social worker visiting a home will be aware of *family relationships*. Mutual interests bring people together in *groups and clubs*. When hundreds of people gather to hear a speech or to see a film or drama it is useful to know how a *crowd* behaves.

Have you a *captive audience* in church or school or can individuals decide whether they stay or go, as at a voluntary club, open-air meeting or exhibition?

#### BY WHAT MEANS?

In many countries, for centuries, the main means of communicating ideas has been the spoken word, with song and drama added on special occasions. The subjects under discussion and the words used have been related to a common cultural experience, so usually they have been understood satisfactorily.

Frequently a villager would illustrate his point by reference to an object of some sort and there would sometimes be an opportunity for the listener to inspect the object or even to try out its use.

People in some parts of the world have relied more on the *written* word and their means of communication have developed differently.

The situation today, however, is changing rapidly almost everywhere and in most countries there is becoming available a wide range of communication tools.

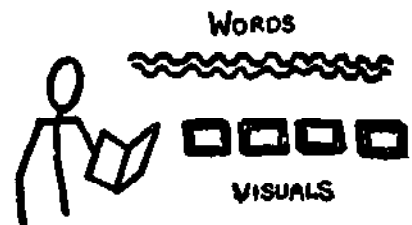
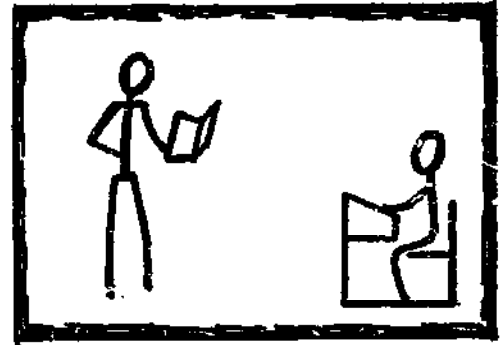

### THE SPOKEN WORD

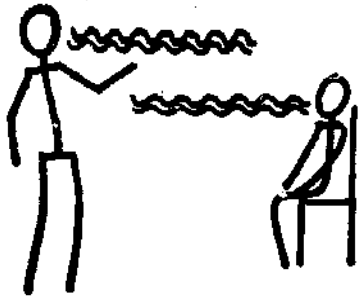

### TOOLS FOR THE JOB

(a) *Audio—Something Heard.* Music, drums and sound effects can all be heard, but the most commonly used tool for the job is the spoken word. When speaking to their own people, some teachers are very good with words alone and they increase their effectiveness with appropriate dramatic gestures. For many individuals, information heard directly from the lips of another person is very important, particularly if that person is well respected. The spoken word by itself, however, has several limitations. Many people hear the words but have little understanding of the ideas behind them. If words are to be understood properly they have to be rooted in personal experience.

If speaker and listener have their words related to totally different experiences there can be little understanding between them. It is not easy to convey new ideas and unfamiliar information with words which listeners relate only to their familiar experience, or with words which your listeners *think* they understand.

Whenever translation is involved the chances of misunderstanding are greatly increased.

Words alone are often misunderstood and easily forgotten.

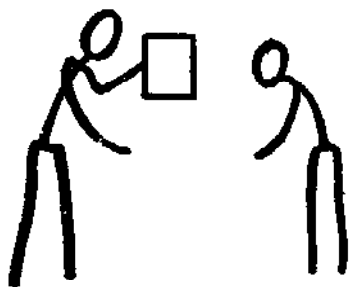
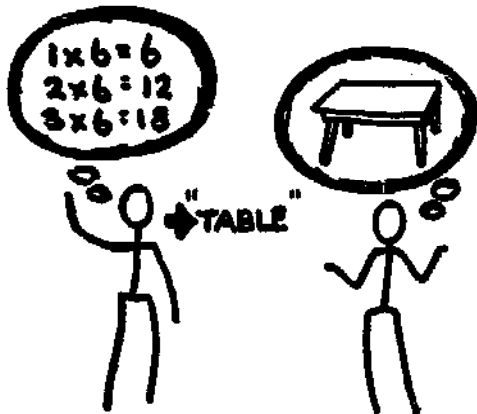

(b) *Visuals—Something Seen* (apart from written words). With many subjects, visuals arouse interest, provide a clear mental picture, speed understanding, help memory and provide a shared experience. By looking at something together with the person with whom you are trying to communicate you have something in common—the thing you both see. As you share this experience, the words you use are understood because both speaker and listener relate them to a common visual.

When the visual shows something the viewer has seen in real life he can understand and remember the point easily.

(c) *Multi-Sensory Materials.* People receive experiences through all five senses—sight, hearing, smell, taste and

touch. If you can appeal to more than one sense at a time your message is more likely to be understood and accepted. Different media appeal to different people. For effective communication you need to involve your audience in different experiences—using several senses if possible. However you plan your teaching, do not concentrate on *memory work*, but on *seeing, hearing, touching, doing and making* . . . See: *The Selection of Tools and Methods* page 12 and *The Multiple-Media Approach* pages 121-124.

#### METHODS FOR THE JOB

(a) *Formal*. The authoritarian approach has been traditional in many countries and is still the most common method used. For certain purposes this may be appropriate with some subjects. The teacher claims to know the facts and the answers, and uses textbooks and a few other materials to tell the learners what he knows. Because of the large numbers to be dealt with at a time, the *I'm-telling-you* or *I'm-showing-you* method may sometimes be necessary.

The difficulty, particularly with adults, is that this method does not take into account the different levels of individual knowledge and experience in the group. In many countries, however, some teachers are seeing the limitations of the formal approach and are exploring new ways. Government Education Departments are concerned with curriculum development. Informal adult education techniques used in community development, in agricultural extension and in commercial and industrial training have a great deal to offer to all who are interested in the communication of ideas.

(b) *Informal*. When your aim is to encourage thought, develop attitudes and lead to action, the less formal methods which involve discovery, participation and learning through doing, will usually be more successful. In many cases, it is not a question of telling a person something he needs to know, but of confronting him with his own situation and other and better situations so that he may *discover* the truth. Together, you can clarify the issues and agree on what must be done. For an adult, as well as for a young person, learning needs to be through activity; through each individual's own decisions and participation; at his own pace and with material that seems relevant to his daily life and uses his own experience.

Start from the learner's present experience, lead him through a variety of experiences to a new and wider experience. For many purposes, this use of experience is more effective than the method which starts from the words of a textbook, goes through the rote-learning of notes to the absorption of words (often with little understanding).

Of course, experience in itself is not necessarily meaningful. Instruction and guidance help to make it so. There is little doubt, however, that when the aim is to gain insight, understanding and skill and not just the conveying of facts and information, the less formal methods involving the learner's experience are more useful.

#### THE SELECTION OF TOOLS AND METHODS

Judge visual tools by their relevance and effectiveness, not by the amount of money you spend on them. Each means of communication has its own characteristics and you need to select the most appropriate. You cannot teach all subjects nor achieve all educational purposes with one means or method. In general, the real thing is a more effective teaching medium than a visual representation. Your selection of tools and methods depends on:

(a) *The Message*. As an example, take the Christian religion, containing three main types of message:

(i) *History*. Christianity is rooted in history, in facts to be learned about persons, events and places. Pictures help present these facts. A story with movement and action is easier to tell with a moving medium than with one single illustration. Use a good flannelgraph or a picture sequence.

(ii) *Beliefs*. These are often expressed through abstract terms. You need spoken and written words, but, to ensure understanding, some sort of two-way conversation is essential. Always aim to relate the words used to some experience. An ordinary flat picture may not help a person understand a truth from one of St. Paul's letters, but chalkboard diagrams and symbols might be useful.

(iii) *Life*. A way of life must be a living experience and learning by doing should be the method.

Whatever the subject, the contents of the message and the characteristics of each medium will affect the choice of teaching materials.

(b) *The Purpose*. See: *With What Purpose?* page 8

(c) *The People*. See: *To Whom?* page 8

(d) *The Occasion*. See: *In What Situation?* page 9

(e) *Available Resources*. Select tools which are suitable for widespread use. As far as possible, choose inexpensive materials which can be made or obtained easily. Encourage others to see that good visual teaching is possible with their existing resources and that they do not have to demand an elaborate mobile film unit or closed-circuit television! Use what the country itself requires and will continue to be able to support.

(f) *Available Skills*. When considering tools and methods for your own use, make sure you choose ones you can employ skilfully. Visual materials used badly are a hindrance rather than a help. When planning for others, give them every

opportunity to widen their experience of different tools, methods and ideas. Encourage them to develop their skills of presentation. A good general rule is to start where people are now and plan first to use and extend the means of communication familiar to them.

Select tools and methods which make the subject to be communicated most clear to the audience and which do it most interestingly and most economically of time, space and money.

#### WITH WHAT EFFECT?

(a) *Short-term Effect.* As you are presenting your message, remember to note the effect on individuals in your audience. Their reactions, expressions, actions and words tell you whether they are interested or bored, clear or confused. Look for and encourage some sort of immediate response. Try to get the help of an observer who can record the audience's spontaneous reactions and afterwards obtain their honest opinions. He can also give his own objective evaluation of the programme's effect.

Whether through your own or through an observer's inquiries, you need to discover to what extent your message has been distorted. You must discover the reasons and be ready to change your approach, language and teaching materials and methods.

(b) *Long-term Effect.* The success of your communication is judged by what people do when they are free to act as they choose. When you are presenting your message the audience may show enthusiasm and be ready to discuss the subject. They may learn and understand certain facts, but unless they believe these to be important for their own lives they may take no action. The long-term value of your teaching is to be found in people's *actions*.

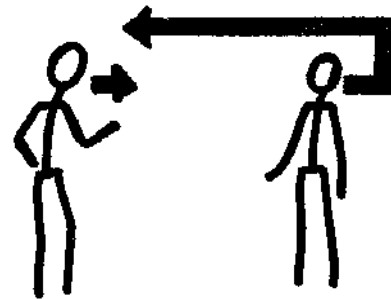

#### PROJECTS FOR PRACTICE

1. Consider three possible audiences you are likely to be concerned with and list the physical, intellectual and emotional barriers you are likely to encounter.
2. Discuss with fellow workers the effect of different situations on the presentation of new ideas.

3. Plan a project or exercise to illustrate the problems and limitations of word-only communication.
4. If you are unfamiliar with informal, discovery and activity methods of learning, see if you can get further information from a library or from other teachers.
5. Consider the whole of this chapter and your own experience and then write a one-sentence definition of communication.
6. Describe in detail one or two situations where you have failed to communicate your message to a particular class or audience. Invite your colleagues to suggest the reasons for the failure. Ask them to give similar illustrations from their own experience.

## Chapter 2

### THE VALUE OF VISUALS

#### SYMBOLS, VISUALS AND EXPERIENCE

A spoken word is a *symbol* standing for an object or conveying an idea. Speakers and listeners who share the same language and background can usually understand each other's words because their common culture provides the common meaning. Words describing tangible objects are more easily understood than those dealing with abstract ideas. Without the bond of a common culture, both kinds of words are often misunderstood. Words must be related to some real experience.

*Visuals* are not a universal language, but relevant pictures used effectively are generally understood well and remembered easily because they are closely related to the way people see things in everyday life. At work and at home many people are dealing not with abstract ideas but with real things which they can see and handle. Their memories of these things are usually made up of mind *pictures*. They understand things they see more easily than abstract ideas presented just in words.

*Direct experience*, involving learning through doing, leads to a deeper understanding of the subject and the issues involved. Experience is the broad base of the triangle—the solid foundation for much of the learning process. As teaching aids, visuals may often be far more effective than words alone, but wherever possible, they need to be related to experience and action.

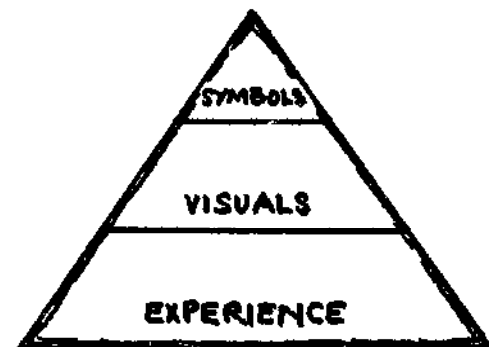
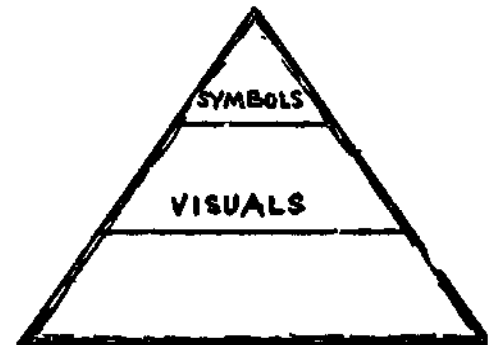
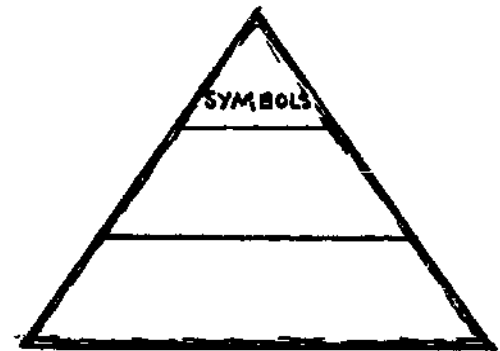

You remember 10% of what you hear.  
You remember 50% of what you hear and see.  
You remember 90% of what you hear, see and *do*.

If I hear, I forget.  
If I see, I remember.  
If I do, I know.

Without forgetting the importance of experience and activity, let us consider the value of relevant visuals as a means of communication.

#### *Visuals Arouse Interest*

No one learns very much if he does not pay attention and show an interest in the subject. There are many ways of gaining attention and holding interest, but one of the best ways is to use something visual.

#### *Visuals can Give an Accurate Impression*

Visuals define facts and information easily and precisely. They can identify, describe in concrete terms and give meaning to words. Accurate factual pictures must normally be produced by skilled artists and photographers or be prepared carefully by the teacher beforehand. The rough sketches you do on the chalkboard will be valuable in *other* ways.

#### *Visuals Save Teaching Time*

Visuals speed up the learning process. With many subjects, a relevant picture will present information very much more quickly than long, wordy descriptions.

Remember, however, that the use of visuals may not save the teacher's *preparation* time unless he retains the visual materials to use again.

#### *Visuals Help Memory*

Because they make the learning process more real, visuals help people to remember better. Most adults have vivid memories of things seen in their youth, but often cannot remember wordy exhortations heard only a day or two previously.

#### *Visuals can Stimulate the Imagination*

One type of visual may inspire the viewer to use his imagination, whereas another, with a wealth of minute detail, may leave no room for further thought. Pictures should often be the starting point for thought, discussion and understanding, not only a quick way of acquiring facts. A stimulating picture may provide different levels of learning experience at the same time.

#### *Visuals Provide a Shared Experience*

Visuals provide a common starting point and a common path to follow. They help to get people thinking on similar lines about the same subject. By studying a situation or picture with the one to whom you are trying to communicate you can enter into an experience to which you can both relate your conversation.

Visuals (and other sense aids) can be very effective, but this does not mean that you need a lot of expensive equipment. If convinced of the value of the visual approach to teaching, you can *begin with what you have*. You will get plenty of ideas from later chapters.

#### PROJECTS FOR PRACTICE

1. In this chapter, six statements have been made about visuals, as such. Have visuals any other characteristic qualities? Make a list.



2. Without showing the picture to your group, describe in words only a picture of an unfamiliar animal or object. Afterwards, show the picture to everyone and discuss the different ideas each person has imagined.
3. Organize one or two experiments to test the memories of your group with information
  - (a) they hear.
  - (b) they hear and *see*.Find out how much is remembered after one day and one month.

## Chapter 3

### SELECTING PICTURES

By dealing with pictures as pictures and by understanding the principles involved in their selection and use, you can gain the necessary experience for most of the wide range of visual materials available. Many of the points dealt with in this chapter will help you in your study of posters, charts, slides and so on.

Your pictures should be appropriate to your purpose, your viewers and your subject. This may sound like a counsel of perfection, but each aspect is worth studying.

#### (1) CONSIDER YOUR PURPOSE

Pictures may serve any one of the five main educational purposes, viz. teaching skills, presenting facts, organizing knowledge, stimulating imagination or changing attitudes.

#### CATEGORIES OF PICTURES

You can classify pictures in many ways, but, for the present, let us divide them into two or three main categories. Of course, these categories often overlap and different people respond to them in different ways, but they will serve as a rough guide.

#### (a) *Descriptive Pictures*—appealing to the mind.

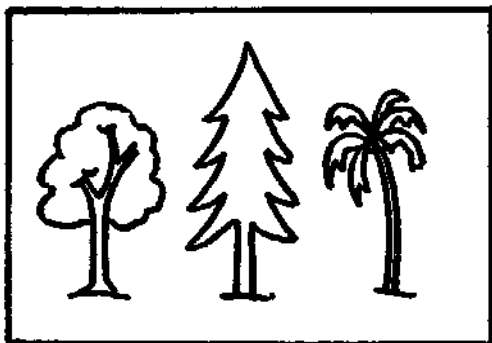

*Facts and Information.* These tell us of the shape, form, arrangement and colour of various things. They can help to give meaning to unfamiliar words which you may need to use when introducing a new subject. They provide visual information enabling the viewer to relate a new word or idea to his existing experience. The question to ask with this type of picture is *What do you SEE?*

*Study.* These pictures may also be very informative, but they usually focus on one main action which shows some characteristic quality or idea. They often include people doing something, in their environment. They encourage thought and inquiry, and their full meaning and implication are apparent only after close study. The question with this type is *What do you UNDERSTAND?*



(b) *Emotive Pictures*—appealing to the emotions. The main function of these pictures is to create an atmosphere or an emotional impression. They may show grandeur, beauty or pathos. A beautiful scene of mountains and trees or a photograph of an atomic explosion encourage an emotional response. The question here is, *What do you FEEL?*

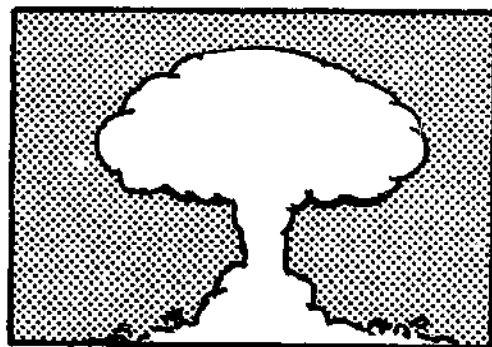

*Photographs or Art Work.* Descriptive or emotive pictures can be produced by photographers and by artists. Although photographs depict reality, they are not necessarily more useful than art work. Advertising illustrations and news photographs sometimes emphasize dramatic aspects rather than the truth. Art work often selects and simplifies and may represent what we *notice* in real life better than any photographs.

*Styles of Art Work.* Let us recognize two main styles of art work :

(a) *Realistic.* For people in many countries, the accurate representation of the human figure, with appropriate hair style, shape of nose and type of dress is most important.

(b) *Impressionistic.* This style, which is becoming more popular in different parts of the world, is less concerned with realistic accuracy and minute details.

*Quality of Art Work.* Whatever your purpose, aim for good technical quality. The picture you use should be bold and clear, have harmonious colours and a satisfying arrangement of figures.

## (2) CONSIDER YOUR VIEWERS

When communicating ideas you have to consider the background, education and experience of the person at the receiving end. For convenience, we will look at this under three headings.

*Physical Aspect*—Can the viewer see properly?

How many people will be in your audience and how far away will they be? The picture you use must be large and clear so that all can see properly. How much detail do you want people to observe? To a certain extent, you can judge the effect of a picture if you sit where the viewer will sit.

*Intellectual Aspect*—Can the viewer understand what he sees?

An individual's ability to understand a picture depends on his age, experience and intelligence. Your experience may be very much wider than that of your audience, so try to discover to what extent they understand pictures. Before making too many assumptions about the suitability of a picture for a particular group of people, conduct a few simple experiments.

Understanding a picture is a skill which has to be learned and many rural people find it difficult to relate black and white still pictures to the three-dimensional situations they know in real life. When *you* look at a photograph you have learned to understand perspective, overlap, highlights and shadows. An illiterate man sees things differently.

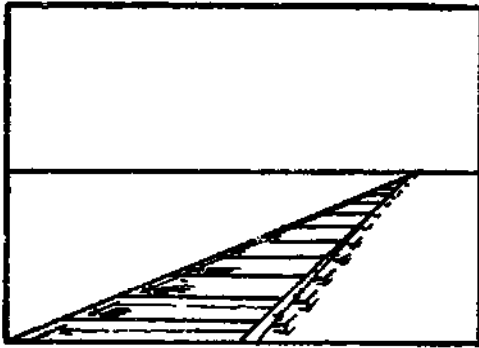

In his experience, railway lines are parallel. In a picture, the convergence of the lines suggests to him that the next train will be wrecked!

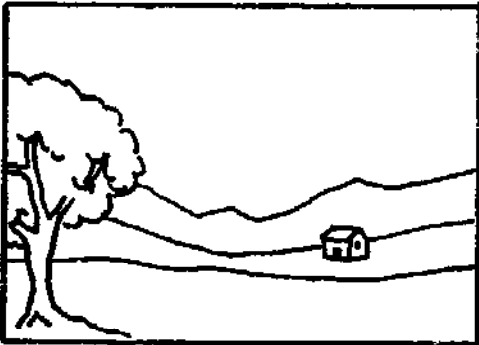

In real life, the house in the distance belongs to his cousin. In a picture, it looks like a small model house or a box!



He knows that the group of men standing together on the other side of the road are all separate and real people. In a picture, some heads, legs and arms do not seem to be attached to bodies!

His dog has four legs.

In the picture, these animals seem to have only two or three legs!

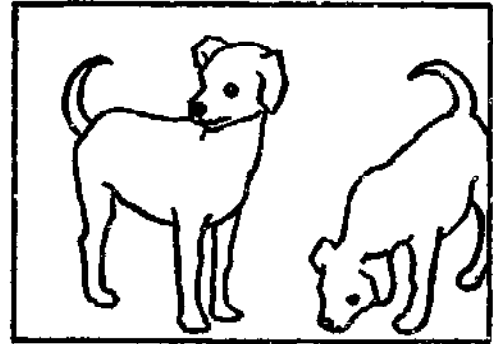

The man he sees standing in the sun is healthy and strong. In the picture, the patches of light on his forehead and cheeks look like leprosy!



Unsophisticated people can, however, quickly learn to interpret pictures if the subjects are well-known to them. Familiar objects in a picture help them to understand the picture as a whole, but unfamiliar objects tend to confuse them.

Illiterates can understand pictures more easily if certain factors are taken into account when they are produced or selected.

A photograph of a single subject with the background detail eliminated stands out clearly. The details of the people and objects in the foreground can be seen clearly and make identification and understanding easier. See: *Posters and Charts* (illustration) page 67.



Pictures are records of certain experiences, and if the viewer has not had a similar experience, he cannot understand the picture well. A great deal depends on the sort of illustrations people see on posters and in books and magazines published and used in their own countries.

Pictures for urban people may show urban situations almost anywhere in the world because London is very like Lagos and Birmingham is like Bombay. Urban audiences are more used to seeing modern commercial art in magazine advertisements and on big posters. They are more ready to accept the modern styles of contemporary artists.

*Emotional/Psychological Aspect*—Is the viewer ready to receive the message?

The viewer's response to a picture is affected by his attitude to the idea or the message. An illustration of an agricultural method which would be profitable for him to adopt may meet with objections in a man's mind if the picture appears foreign. Custom or religion may forbid the eating of certain foods and a health picture plainly advocating such a thing would inevitably meet with prejudiced opposition.

When thinking of the viewers, remember the objections, blocks and prejudices people may have to the message of your picture.

These general comments may be a useful guide, but your own investigations with your viewers will help still further.

### (3) CONSIDER YOUR THEME OR SUBJECT

Your choice of picture material should be dictated by your subject and purpose. Do not change your purpose because you have recently acquired some good pictures on another subject! Your aim should be to illustrate a lesson, not just to show a picture!

See if your picture will measure up to these standards:

(a) Will the picture help you to achieve your purpose?

To encourage vaccination, a picture of the action to be taken will be more effective than one showing a victim suffering from smallpox. If your main aim in telling the story of the Prodigal Son is to speak of the forgiving love of God, you will be better served by a picture of the father embracing the son on his return home than by one showing the son's activities in the far country!

People will remember the picture more than your words, so your main teaching must be seen there.

(b) Does the picture focus attention on *one* main idea?

Some pictures of the Crucifixion include everything mentioned in all the gospel accounts and this can be very confusing if you wish to put emphasis on Christ on the cross. Some people get confused by the many details of a complicated picture and fail to see the importance of the main subject.

(c) Does the picture have human interest?

A stand-up-straight-and-look-at-the-camera sort of picture has very little teaching value. The viewer should be able to learn something of the story through the human *action* shown.

(d) Does the picture stimulate the imagination?

Viewing a picture should not be just a passive experience. Interest should be created, and questions and ideas should be aroused in the minds of the audience.

Every picture may not measure up to these standards completely, but it is worth remembering all of them so that you can gradually build up a useful

collection. You can discard second-rate pictures as your collection grows and as your standards of selection rise.

Remember—a well-chosen picture enables a good teacher to do his work better.

#### PROJECTS FOR PRACTICE

1. Show a selection of pictures one at a time to a small group of farmers/their wives/their school children. Encourage each person to tell you what he sees in each picture. Compare the results obtained from different groups.
2. Take several pictures, cut out the main figure and mount on plain card, thus eliminating all confusing background. Test these pictures with similar groups and compare the results.
3. Invite several friends and colleagues to a picture study group and note each person's contribution to the discussion.

## Chapter 4

### PAPER PICTURES

#### DEFINITION

We are dealing here with non-projected pictures reproduced on paper or similar opaque material. The pictures may be photographs or art work. They are sometimes called *flat pictures* and this word refers to their *two-dimensional* quality, in contrast to solid three-dimensional materials such as objects, specimens and models.

Here we deal with pictures prepared mainly by professionals, showing factual information about people, places and processes. The sketches you yourself draw on the chalkboard will supplement the more accurate visual impressions given by the printed flat picture.

In a number of books on visual materials the subject of paper or flat pictures is not dealt with to any great extent. Some people take them for granted. Others use them in different forms and refer to *charts*, *posters* and *wall sheets*. If pictures are dealt with when appearing as part of a poster or a chart, questions concerning the illustration become confused because of the addition of word captions and other symbols.

Pictures having more than just a brief caption will be considered separately. See: *Posters and Charts* page 61.

#### ADVANTAGES

Flat pictures are available for a wide variety of subjects and are relatively cheap and easy to acquire. They can be used for many different purposes, with different audiences, in a wide variety of profitable ways.

With well-chosen flat pictures you can create interest, introduce a new topic, stimulate imagination and revise a subject previously studied. Pictures can widen experience and give meaning to words and ideas. Your understanding of words must be based on experience and, if distance, size or time make personal acquaintance with the subject impossible, pictures can often provide a useful related experience. E.g. the words *Qib Minar* will mean little to most people unfamiliar with India, but a picture of this historic tower in Delhi provides a visual experience to which the word can be related.

#### DISADVANTAGES

Although the viewer will not immediately see every detail in a picture, the



content has usually to be presented all at once. For some people, it may be useful to start with the whole situation in this way. For others, this can be confusing and the lack of change or movement in the picture can be a handicap.

The picture shows only one split second of time even if the story, process or activity illustrated extends over a period of hours or days.

Some ideas are too big for a single picture. Can any single picture adequately express the meaning of peace or justice? The idea of good health can be expressed visually in a number of ways, but no single picture can show every aspect of the subject.

A picture of Christ gives one artist's impression only. A photograph of an historical character gives just one photographer's impression. Viewers may easily get fixed and limited ideas about the people concerned which later they will need to change or enlarge. A picture of Jesus in Palestine painted with great care for detail and authenticity may fix the idea in the past and may thus limit the understanding of the Christ of today.

Because flat pictures are so common, familiarity can lead to neglect and some teachers miss valuable opportunities of using them. Others think that they are too simple and fail to exploit their possibilities or to learn how to use them effectively.

#### START COLLECTING PICTURES NOW

A person who collects and saves every available picture will not have to complain that he has no visual materials. Illustrated magazines, calendars, and brochures provide a good selection of small pictures and educational suppliers, government departments, information services and commercial agencies publish large ones.

Magazines and pictures may be scarce in some rural areas, but travellers go to the towns and are often ready to help. Explore all possible sources and you will be surprised what you can collect!

#### PROTECTING PICTURES

A picture worth using is a picture worth protecting. One that is faded and tattered is worse than useless, but a well-mounted picture may be used for years.

*Mounting.* Mount small pictures (up to about 20 cm × 30 cm) on cardboard, often obtainable from cardboard boxes and packets. Leave a broad margin all round to protect the edges of the picture itself. Further protection can be given by applying a coat of varnish or by covering with polythene.

Large pictures need protection at the edges.

One method is to strengthen the edges by pasting strips of brown paper on the back of the picture.

Another way of protecting just the edges is to take a one-inch strip of cloth and hem it all round the picture with a sewing machine. Sew through the cloth and through the edge of the picture. Long stitches are less likely to tear the paper. The hem at the front will be turned in and neat, but the cloth edge at the back may be left rough.

If you have to carry large pictures to villages or use them in the open air, mount them on cloth. Unbleached calico or any similar cheap cloth will do. Cut the cloth to size, allowing an extra inch all round, and then lay it flat on a table. On another nearby table lay the picture on its face and apply paste to the back, evenly and quickly. If a commercial paste is not available, use local materials such as cassava starch or flour paste mixed with a small quantity of insecticide powder. Holding the corners, turn the picture over and lay it down carefully on the cloth. Spread a clean newspaper on top and smooth down evenly in all directions, working from the centre to the edges. After allowing the picture to dry slowly in the shade, carefully turn in the cloth and make a neat hem with a sewing machine.

*Storing and Filing.* Organize a method for storing your flat pictures. This may not be easy in a village school, but if your pictures are hung permanently round the walls they will soon get spoiled and will not serve for decoration or for teaching.

Divide the pictures into small (up to 20 cm × 30 cm) and large ones and store them flat in separate boxes or on shelves.

When you have collected a large number of pictures start arranging a simple filing system. There is no point in having a lot of well-chosen pictures if you cannot find the one you want at the right time. Covers or folders made from brown paper or thin cardboard will serve the purpose. Divide up the pictures according to the main sections of the teaching you expect to give. When any folder gets too full you can always sub-divide. In order to keep track of useful pictures found in books, write the details of the picture on a piece of paper or card and slip it into the appropriate file or folder.

#### GETTING READY TO USE PICTURES

Before using pictures with a class or group you need to spend time in preparation. A quick glance may give you a general idea of the contents of the picture, but you will not get the full meaning out of any good picture unless you are prepared to study it for several minutes.

When preparing to use a picture note the following:

(a) What are the facts? Look at the contents of the picture—the people, the buildings, the scenery and so on. Study the faces of the characters. The face usually tells you something about a person's nature. Look carefully for two or

three minutes and absorb all these facts. Close your eyes and look at the picture in your imagination. Try and see all the facts and details of the original picture.

(b) How are the facts arranged? Look again at the picture and see how things are grouped. What part of the picture will attract the viewer's eye first? This usually depends on the age, knowledge and experience of the viewer as well as on the composition of the picture.

(c) What do the facts as arranged mean? This question is particularly important with *study* pictures. What are the things that make the picture meaningful? What is the artist or photographer trying to say? Become a picture detective, looking for clues supporting your story or theme.

If possible, join with others. Because of their different experience, others may see important things in the picture which escape your own attention. Group study of a picture can be very stimulating. It is not just a question of what you see, but what you *learn* from what you see.

When you have studied and learned from the picture you can begin to pass on your experience to others.

#### USING LARGE PICTURES

##### GENERAL PRINCIPLES

Recall your teaching purpose. Are you trying to demonstrate a skill, present facts, organize knowledge, stimulate imagination or change attitudes?

The questions you considered in your preparation will again be your guide. (See the previous section.)

If they are given no direction beforehand, many audiences are content to take only a quick glance at a picture. *Guided* study of a picture is usually necessary. Remember how long it took *you* to notice and appreciate all the relevant points in the picture. The difficulty sometimes is how to tell people what to look for without telling them what to see!

When telling a story or presenting a subject, choose carefully the best moment to show the picture. You know the main point in the picture to which you wish to draw the viewer's attention, so wait till you reach that point in your subject or story and then show the picture. If you show it earlier, the viewer will be paying attention to the picture before you are ready for it. If you wait until after telling the story in words, your listeners will have built up different mind pictures of the subject and this may lead to some confusion when you finally show the picture.

As far as possible, keep the attention of ears and eyes *together*.

##### METHODS

(a) *Talks and Explanations*. This is put first, not because it is the most important but because so many people use this method!

With a picture that tells a story or introduces a theme:

Direct attention to the main character. Let interest in him lead to further study of the picture.

Introduce the other characters as they become necessary for the story.

Introduce backgrounds in the same way when they throw light on the theme.

Find hints in the picture of what came before the incident illustrated and what may follow. Use such hints to keep up interest and curiosity. If the picture is connected with the end of the story it may be shown first and an account of previous happenings drawn out by a process of deduction from the picture.

Last of all, return to the main character and permit him to make the final and main impression.

One difficulty with this method is that if you tell people what a picture is about they give it only half their attention. As far as possible, plan for *activity*. Allow the picture itself to communicate to the viewers and get them to tell you what they understand from it.

#### (b) *Questions and Discussion*

**Questions from the Viewers.** Encourage your group to ask questions. If you show people a stimulating picture they will usually ask good questions. The picture will suggest ideas which interest the group and they then raise questions to which they are ready to have the answers. Questions give you a chance to comment on points you may have overlooked or to correct wrong impressions.

**Questions by the Teacher.** Train viewers by using questions linking with their experience and by helping them to exercise their imaginations. After a brief introduction hinting at the subject illustrated, ask who, what, where and when? Then lead on to more thought-provoking how and why questions. Do not ask vague and ill-defined questions leading to wild guesses and irrelevant and unreasonable answers.

The question method can be used to help people re-tell a story from the picture. What are the characters thinking? . . . saying? What do you think has just happened? . . . will happen next? What would you do if you were there? Pictures often help inexperienced speakers express themselves on a subject. As they look at the picture it enables them to turn their thoughts into words.

**Questions leading to Discussion.** Follow the method used in your own preparation. Discuss together the facts; how they are arranged and what they mean.

When studying as a group, each member brings new insights to the interpretation of the picture. In group exploration of a picture the leader's job is to

encourage members of the group to listen to each other. Members should not try to dominate with their own ideas and interpretations.

Pictures that help to start discussions are found in all sorts of unlikely places. News pictures can stimulate a useful conversation on community development and wider subjects. A good teacher does not need a biblical illustration to start a religious discussion. A secular picture will often do just as well.

(c) *Parallels and Contrasts*—leading to greater understanding and discussion.

An exchange of views often evolves from a situation offering alternatives or several possibilities. Compare a picture with group members' individual experiences.

Compare two or three styles of pictures on the same subject or pictures taken from two or three different angles. One illustration of a steel mill cannot explain the whole process nor can one single picture of a person reveal the full depth of his character.

A painting of Jesus should not be regarded as an authoritative photograph of him as he was 2,000 years ago, but as *one* artist's idea expressed as a picture. At all costs avoid giving limited, narrow and fixed ideas about great people and concepts.



When using a traditional Bible picture try to find a modern illustration which parallels the Bible story or compare the picture with individual experiences. Why not act the story as it might take place today? See: *Learning through Role Play* page 93. Biblical truths are not just ancient history, but must be seen as related to life.

With some subjects it is better to have a variety (perhaps three types) of pictures on a few main issues than to try to illustrate every part of the syllabus. This, at least, ensures good discussion and understanding of the main issues.

It will take time to deal with any good picture adequately, so do not attempt to use more than a limited number in each session.

There can be no hard and fast rules about methods to be used with large pictures. Pictures and situations must be judged on their merits. The main principles, however, should not be ignored. Keep the attention of ears and eyes together and concentrate on the significant elements in the picture.

#### USING SMALL PICTURES

Never be tempted to pass a small picture round the class or group if you intend to go on talking. If you pass small pictures round some people will be looking at one thing while you are talking about something else. Remember always—ears and eyes should be concentrated together in order to get the maximum effect. If the picture is not big enough for all to see at one time, arrange some other occasion for individual study.

In some teaching situations you can divide into small groups for different activities and provide an opportunity for using a variety of small pictures. One or two groups may look at small pictures on the subject and work out answers to the questions written below each one. Others may study a few pages or paragraphs on the same theme. After some minutes of group work all can come together again to share what they have discovered.

Another method is to give groups different selections of pictures on the same general subject. Ask each group to agree on captions for each picture. The careful study of the pictures leads to a discovery of a great deal of information. Group members then have to *agree* on the most appropriate captions and this leads to much useful conversation about important issues.

You can show small pictures on a conveniently placed display board. See: *Display Boards* page 70.

Small line drawings may be enlarged and then the big picture used with the whole group. See: *Drawing Materials and Basic Skills* page 50.

Pictures decorating the home can have teaching value, too. Visitors often ask about the pictures and this provides a further opportunity for instruction.

#### SHOWING PICTURES

If you have chosen good pictures and have thought carefully about how you will use them, make sure that people can see them satisfactorily.

*Cleanliness.* The pictures you use should be as clean and neat as possible. If you have protected them well you will be able to show them well.

**Height.** Make sure that those sitting at the back can see easily without having to dodge intervening heads. A teaching picture should always be shown at eye level or just above. (In school, this means the child's eye level and not the teacher's!)

**Light.** Make sure that the available light is directed towards the picture and not towards the viewers. In daytime there should be no windows just behind the picture because this will make it difficult for people to see. At night, a small shield of cardboard or tin placed between the viewers and the lamp will direct the light to the picture only.

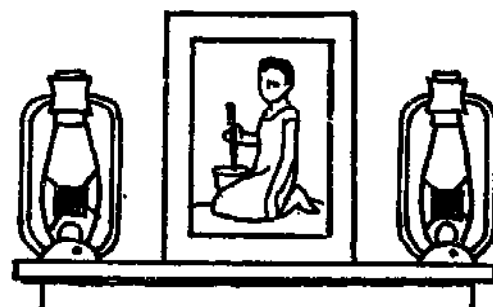

**Holding.** A picture that is held loosely in the hand is never very easy to see. A 20 cm × 30 cm picture on cardboard can be propped against the wall or put inside a suitable frame.

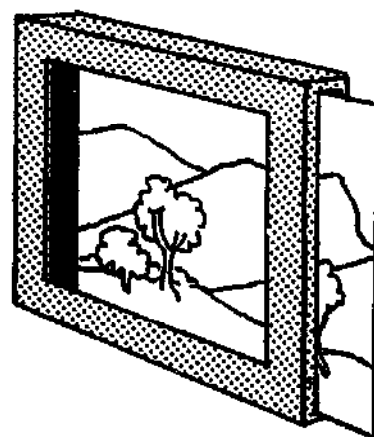

Standard-sized pictures, sometimes available in book form, can be shown in a simple open-sided plywood or cardboard box.

If you do not have a softboard panel on which to pin large pictures you will find that you can stick them to the chalkboard with ordinary plasticine.

A more lasting method is a strip of tin-plate or galvanized iron. A pair of magnets will hold a picture quite firmly.

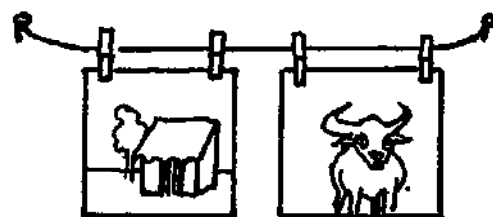

If you wish to show a number of pictures you can use spring clothes pegs threaded on to a length of thin wire or cord.

For those who have to travel, you can clip your picture to a portable board. See : *Chalkboards* page 55.

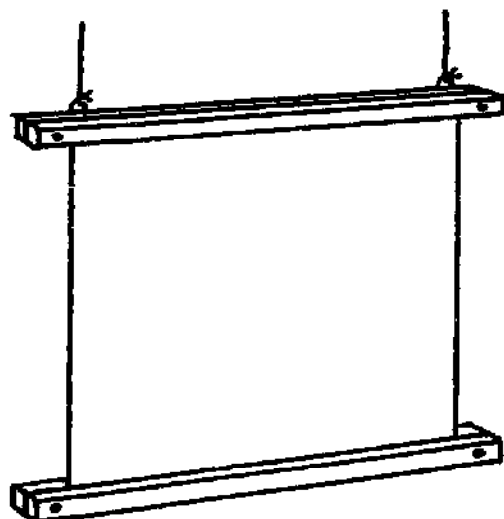

An alternative method for village workers is to clamp the picture between pairs of sticks or battens at top and bottom. The pairs of sticks grip the picture when they are bound tightly at each end with string or held by bolts and wing-nuts. The top pair of sticks may have string attached for hanging the picture to a tree or wall.

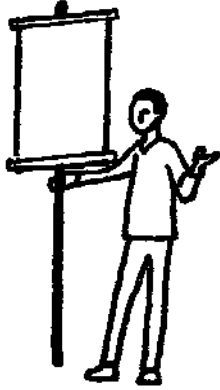

Two pairs of sticks attached by bolts and wing-nuts to an eight-foot pole will show a large flat picture so that even a big crowd in the open air can see adequately. For transport, the cross bars can be folded or taken off the long pole.

#### **PROJECTS FOR PRACTICE**

1. Collect as many pictures as possible from magazines and other sources and start a simple filing system.
2. Mount on card a selection of your best pictures.
3. Try out one of the methods of using large pictures.
4. Experiment with one method of using small pictures in groups.
5. Find two or three large pictures and think out how they could be used for a meditation or as subjects for prayer.
6. With the subject of flat pictures there are many more projects you can work on. Think up a few for yourself and then evaluate your efforts.



## Chapter 5

### SEQUENCE PICTURES

#### DEFINITION

Several types of visual material consist of a series of pictures, diagrams or titles on a related subject. They reveal the story or theme step by step.

Sequence pictures may be:

Small cards you hold in your hand---



Large flipcharts with a wooden support---



Joined together on a roll---

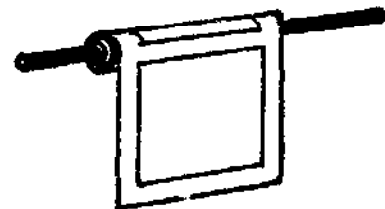

Linked together in a zig-zag---

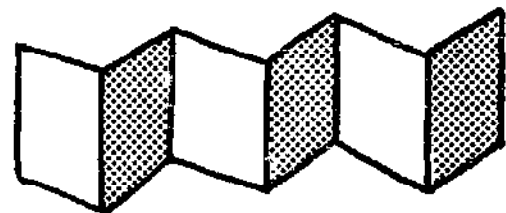

In every case, the pictures are arranged in a definite order or sequence so that a story may be told or a theme developed as they are shown one by one.

(Filmstrips and slides also come under the category of Sequence Pictures, but, at present, our concern is with non-projected materials.)

#### ADVANTAGES

Sequence pictures reveal their information in a pre-arranged order rather than all at once and unregulated. This is very valuable when you need to outline a process or present an idea step by step. The cards or charts summarize visually the important points you want the audience to remember.

Movement attracts the eye and changing cards or turning over charts holds the attention better than retaining one single picture. The knowledge that more pictures are to come can stimulate thought and encourage viewers to anticipate the next step.

Non-projected sequence pictures can be carried easily, used in areas with no electricity and many types can be made quickly and inexpensively from local materials. They are easy to show and many inexperienced users of visual materials handle sequence pictures very much better than flannelgraph.

#### DISADVANTAGES

Sequence pictures do not have the characteristic of a well-designed flannelgraph where you can slowly build up a complete picture. With the separate sequence pictures, the viewers have to re-focus their eyes and minds on each successive picture. This is less of a problem when the differences between each picture have been planned in steps to suit the visual experience of the viewers.

#### PICTURE CARDS—DESIGNED AS A SERIES

These cards are suitable for use with small groups where the presentation may be informal and lead into discussion.

The simplest cards consist of a series of line drawings, but there are also coloured picture cards called kamishibai which have been popular in Japan for many years and have been used in other countries, too.

Large picture books on various subjects are available and, if the illustrations and text are on alternate pages, the pictures may be cut out and mounted on cards.

Some large posters are designed with six or eight sections which can be cut up, mounted on cards and used in sequence to present the subject in logical steps.

#### CARDS OR LARGE PICTURES—A GATHERED COLLECTION

With pictures drawn from a variety of sources cut to the same size and shape you can make up a series on a particular subject.

Of course, the most effective pictures are those in which the settings and dress resemble those in the area in which they are used. Some picture cards, books and posters from other countries may be adapted, but, if you cannot *buy* suitable pictures, why not *make* them?

## PRODUCING YOUR OWN SEQUENCE PICTURES

*Subject.* Consider your subject or theme and decide on one aim. Select the main ideas you want to impress on your audience and the different aspects of each you want them to remember. Then think of a picture for each one. E.g. Show the steps needed to produce a good crop—clearing the land, tilling, fertilizing, planting, weeding, growth and harvesting. Similarly, you may explain the stages of child development, the qualities needed by a good teacher and many other subjects.

*Number of Pictures.* You cannot put across many new ideas at once, so if you are dealing with a new topic have a small number of pictures.

If your subject can be presented through a picture *story* you can plan for a longer sequence.

For your teaching purpose, the important thing is not the number of *pictures* you show, but the number of *ideas* your audience can absorb.

*Type of Illustration.* Drawings of stickmen and simplified figures may be used in a variety of cultural settings, but realistic line drawings closely related to the local situation give better results. See: *Drawing Materials and Basic Skills* page 42. Large close-up photographs are effective, especially if you trim off unnecessary background detail.

Of course, the pictures must be large enough for your entire audience to see. Each viewer must be able to understand the illustrations quickly and easily.

To convey the full meaning, you will sometimes need words to supplement the illustrations, but with many audiences, the most effective sequence pictures are those needing few or no written words.

Choose your words carefully. See: *Designing Single-Glance Posters* page 65.

*Layout.* Each individual card should have the qualities of a good poster with simplicity, brevity, etc.

*Sequence.* Whatever picture style you use, try to link one picture with the next; not only with spoken words, but in the pictures themselves. As the pictures introduce new ideas one at a time, try to have some visual continuity link. E.g. with the good crop series mentioned above, have one or two trees and hills as familiar landmarks in each picture. If you are following the story of a particular character, make sure that he is shown with the same colour clothes in each picture.

The size you choose to make the cards or flipcharts will be dictated by the number of viewers you expect. The quality of the materials you use and the amount of time spent on preparing the pictures will depend on the number of times you expect to use them.

*Copying.* Even if you do not claim to be an artist, you can produce excellent results. See: *Drawing Materials and Basic Skills* page 52. Suitable filmstrips, slide sets and book illustrations can be your raw material. As you copy each picture you can make slight alterations where necessary in order to relate the illustration to the experience of the audience. E.g. the design of a plough can be changed so that it is similar to the type used locally. Unfamiliar objects and cluttered backgrounds, which are unnecessary for your teaching purpose, may be omitted. You can change the sequence or even leave out one or two pictures. Pictures altered with your subject and audience in mind will be more useful than expensive materials commercially produced for another country or situation.

#### SHOWING SEQUENCE PICTURES

The points about cleanliness, height, light and holding apply whether you are showing a single picture or a sequence. See: *Selecting Pictures* page 18.

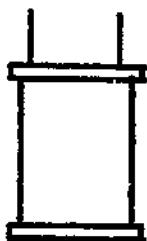

#### *Wooden Holders for Large Pictures*

(a) A pair of sticks or battens can be used to clamp together at the top a set of large pictures. The bottom pair of sticks is attached only to the *last* picture in the sequence. This helps to prevent the pictures being blown about when using them outdoors.

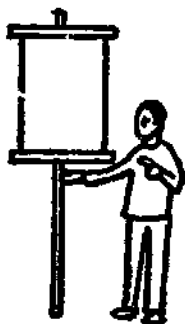

(b) When pictures need to be held high so that many people may see, support them on an eight-foot pole.

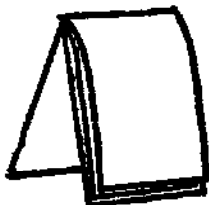

(c) An easily erected stand for showing large sequence pictures can be made so that they are fastened between two hinged wooden covers. The size of the stand you make will depend on the anticipated size of your audience.

Cut two rectangular pieces of wood or hardboard to act as covers. Join these two pieces by hinges on one of

their narrow sides to two wooden strips about 3.5 cm  $\times$  1 cm.

Drill three holes and insert three bolts and nuts to hold the wooden strips together. The pictures fit between the wooden strips.

By folding back the two covers they now serve as a portable stand. A cord at the base will keep the stand in position. As an extra, one surface may be painted and used as a chalkboard and another may be covered with cloth for use as a flannelboard.

### *Frames for Small Pictures*

(a) For a sequence of small pictures mounted on card, construct a simple plywood frame with an opening at the side for changing the pictures. By attaching a cord or strap to the frame, you can hang it round your neck, thus leaving the hands free for gestures.

(b) A picture scroll box is particularly useful with children. Take a series of pictures which can be trimmed to the same size and form a long scroll by pasting them in sequence. Before pasting, the pictures need to be lined up against a straight edge in order to produce a neatly rolled scroll. Add an extra few inches of paper to the first and last pictures in order to attach the scroll to two round dowel rods.

A simple container may be made from a stout cardboard box. In one side of the box, starting 10 cm above the bottom, cut a window 2.5 cm narrower and 2.5 cm shorter than the pictures. In the two sides of the box adjoining the window side, cut holes at the top edge 3.5 cm from the corner. Cut another set of holes near the bottom edge 3.5 cm from the corner. Insert a round dowel rod in the bottom holes. Tape the picture scroll to the rod and roll the scroll until the first picture appears in the window. Attach the top of the scroll to the other rod and insert into the top holes. Turn the top dowel rod to roll the pictures from bottom to top.

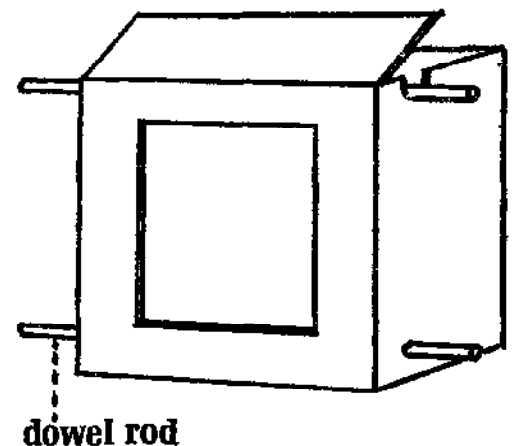
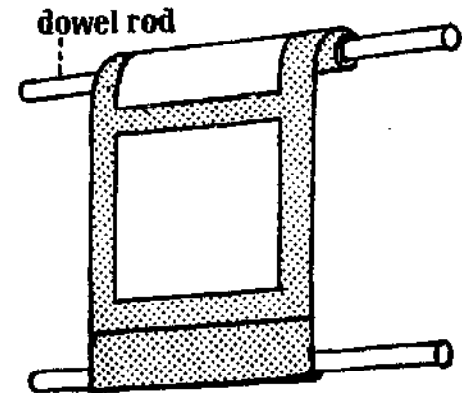
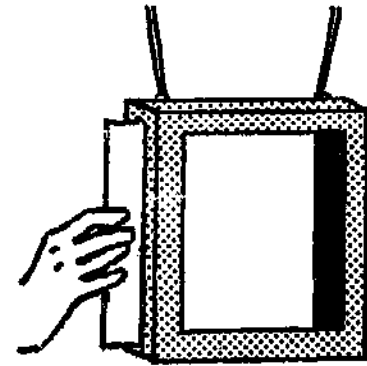
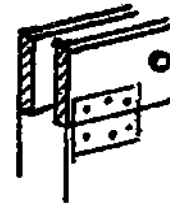

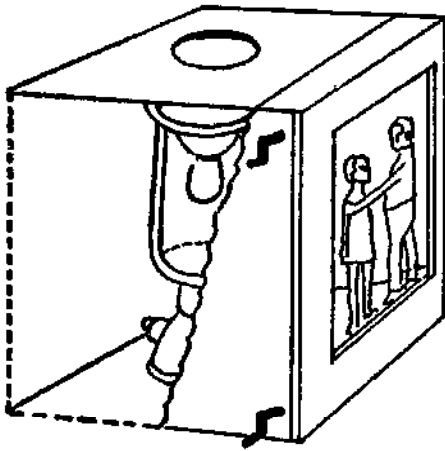

For a more durable box which can be used with an oil lamp at night, construct a wooden frame with two side pieces so that they project at right angles. Dowel rods are set into holes in the frame and turned by handles (made from bent nails) which are inserted through the sides. If a plywood top is added, and the scroll box placed with its back to a wall, an ordinary lamp shining through the pictures will illuminate them quite well. A pressure lamp shows a brighter picture, but do not forget to make a hole in the top to allow the heat to escape!

### *Zig-zag Pictures*

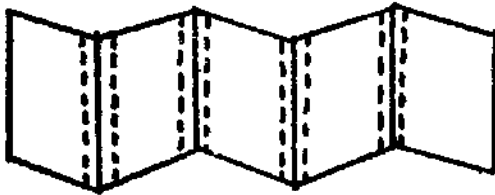

Mount pictures on pieces of cardboard which are of a uniform size. Join the cards with strips of cloth pasted on to form hinges. Fold the cards like a zig-zag. When introducing the sequence, fold back and show one picture at a time. Afterwards, display the pictures for review by standing the zig-zag cards on a table.

In addition to using printed pictures, you can take a roll of cheap white paper and draw or enlarge your own sequence of pictures.

### GETTING READY TO USE SEQUENCE PICTURES

The same general principles apply to all the different varieties of sequence pictures. In your preparation you need to study the sequence four times.

(a) *Aim, Theme and Purpose.* Look through all the pictures quickly, decide on your aim, express it in one sentence and write it down. All you say and show should be related to the aim and theme so that you leave one definite impression in people's minds. (With a prepared sequence of pictures the aim should already be clear. With a collection of pictures gathered into a sequence from various sources more care is needed.)

(b) *Key Points.* Look at each picture separately and decide on the key point which will claim the viewer's attention as soon as each picture is shown. The key points will act as pegs for the theme and need to be uppermost in your mind when speaking.

(c) *Other Significant Details.* Apart from the very simplest of line drawings, most pictures will contain other significant details which will help you to explain the subject. Study each picture carefully once again.

(d) *Sequence.* To ensure a smooth presentation you need to know the order of the pictures, so look through the whole sequence once again! Unless you know

the picture which follows the one on view you cannot make an immediate verbal link as soon as you show the next picture.

#### USING SEQUENCE PICTURES

As with all visual material, your method of use will depend a great deal on your educational purpose.

In most cases you will no doubt wish to involve the audience in some sort of activity, but there may be occasions when you have to give a lecture-type presentation of your subject through pictures and words. The following points will guide you :

#### *Speaking with Sequence Pictures*

(a) *Introduction.* The introduction to the subject should be given *before* the first picture is shown so that the minds of the audience are prepared for what they are about to see.

(b) *First Words.* As soon as the first picture is displayed, make a direct link with the key point which people will be looking at. Aim to make the main contents of each new picture clear in the first sentence spoken with it. People learn more when ears and eyes are focused together on the same idea.

(c) *Last Words.* Just as the first words spoken with a picture are very important, so the final sentence or two should be given careful thought. As you change the pictures, each one in a series is not completely erased from the viewer's mind, but influences the way in which successive pictures are seen. The speaker's job, therefore, is to conduct a campaign in the minds of the audience and he can do this best if he is always anticipating the next picture. Prepare the minds of the people for what will follow when the next picture is shown.

(d) *Story.* If your sequence pictures tell a story let the commentary follow the same technique. Do not take each picture separately and preach a sermon on it! Concrete nouns and action verbs must keep the story moving. *Here is Jesus; There are the wise men;* and other expressions of that sort hold up the action of the story. With a little practice, it is just as easy to point out the characters with action verbs by saying *As Jesus was teaching the crowds the people listened very carefully . . .* and *The wise men looked at the star and prepared for their long journey . . .* Make sure you avoid the *In-this-picture-on-the-left-we-see* method!

(e) *Message.* The message of the programme should, as far as possible, be linked with the pictures and not given in a 10 to 15-minute wordy sermon at the end.

*Straight Presentation.* With all types of sequence pictures it is important to draw attention to the message and not to the medium or technique being used. Keep

the pictures stacked or folded neatly and do not wave them about. When changing from one picture to the next, do it as unobtrusively as possible.

#### *Double Presentation*

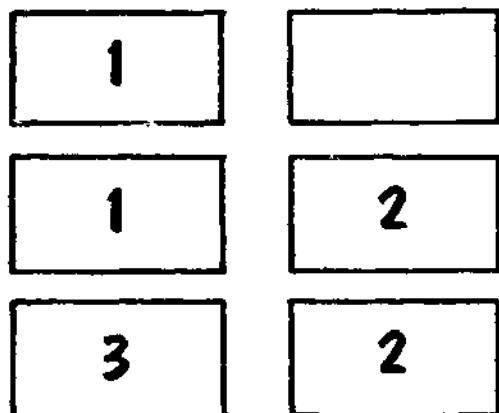

Arrange the pictures in two stacks side by side and present the sequence by showing them one by one from alternate stacks.

After the first picture, the audience always sees two pictures at a time, and this can help considerably with continuity and development of the main theme.

This technique can also be used to illustrate contrasts side by side, e.g. The Wide Way and the Narrow Way; Good and Bad; The Old and the New.

The top line in the illustration shows the situation when the first picture is being shown; the second line shows the situation when the second picture is being introduced, but the first picture is still on view and so on . . .

*An Interrupted Showing.* If the first section of your picture sequence sets the scene, asks a question or poses a problem, you can interrupt the presentation of the pictures to discuss the situation with your audience. This helps them get actively involved in the subject and ready to learn from subsequent pictures and ideas.

*A Key Picture to Introduce the Subject.* Show one significant picture to create interest and discuss the subject with your group. Then start from the beginning and present the whole sequence.

*Relate to One General Picture.* Some people find it easier to deal with the whole situation at once rather than with cause and effect step-by-step logic. If this is the case, start with one general picture showing the central theme or idea. Then introduce sequence pictures and look at the separate parts in relation to the whole. When using the sequence pictures have the general picture to one side and refer to it whenever necessary.

*A Second Showing.* After using a straight presentation method for a first showing, it is sometimes a good plan to show the sequence a second time. On the second showing use questions and discussion to relate the ideas and teaching directly to the experience of the audience.

You can sometimes repeat just three or four pictures and then get the group



to recall the rest of the subject. This method helps people of all ages put into words the ideas they have received in pictures.

Pictures of a familiar story help children with oral composition, too.

*Repeat Key Pictures.* With a long sequence it may be more effective to have a brief summary and application with just a limited number of key pictures.

Your audience will not necessarily learn best by listening to *you* explain the picture! Wherever possible, get them to tell you what the pictures mean. With children, you can arrange for them to prepare as a group and then one or more may be responsible for the presentation.

*Pass the Pictures Round the Group.* If you are using relatively small cards, first show all the pictures to the whole group. Then give all the cards to a member of the audience sitting at the end of the front row. Ask him to look at the top card and pass it to his neighbour. He then looks at the second card and passes it on. As the cards are passed from one to another you may encourage members of the group to discuss the contents with their neighbours, but do *not* continue to talk *yourself*. When all have seen the cards individually in sequence, it is easy to start a question and answer period and relate the teaching to the experience of the audience.

One big advantage of sequence pictures used in a small group is that you can encourage discussion. Of course, you need to be thoroughly prepared for this kind of presentation and be ready to turn to other related visual materials. E.g. make a further reference to the general theme picture; show specimens and perhaps put all the pictures up on display afterwards.

#### PROJECTS FOR PRACTICE

1. Find a filmstrip to copy and adapt to non-projected sequence pictures.
2. Make one type of wooden holder for displaying sequence pictures.
3. Organize a small group to speak with sequence pictures. When the group has pooled ideas on points (a)–(d) under *Getting Ready to Use Sequence Pictures* page 38, take it in turns to present the pictures to the rest of the group. Afterwards, let the group evaluate each attempt.
4. Try out one of the methods of using sequence pictures.

## Chapter 6

### DRAWING MATERIALS AND BASIC SKILLS

The aid you make yourself, with your teaching and your audience in mind, will often be far more effective than costly material designed for another situation. Consider the relatively cheap materials available locally and, by using very simple methods, acquire some basic skills in lettering and drawing.

#### PAPER

Obtain thin card, drawing paper or sugar paper if possible, but remember that old newspapers, kitchen paper, brown wrapping paper, old sugar or cement bags can be satisfactory substitutes.

#### PENS AND STENCILS

Choose the lettering aid to suit your circumstances.

*Lettering Aids You Can Buy.* Writing instruments designed for a wide variety of purposes are available these days. Some are cheap and made on the use-and-throw-away principle, but others are meant to last. Here are a few of the many possibilities:

*Steel nibs* with round or broad tips—these are available in a variety of sizes.

*Felt tip pens*—those with water-based ink tend to fade, especially outdoors. When the water evaporates there is often *colour* left in the pen. With some types, this can be used by topping-up with more water.

Pens with spirit-based ink are waterproof, but need to be kept tightly closed when not in use to avoid evaporation. A few can be refilled like a fountain pen and some of the disposable types can be renewed by inserting a tablespoonful of carbon tetrachloride.

*Stencils*—the Econosign system uses transparent stencils and a brush charged with semi-dry water-colour. There are other stencil systems with pens and most of them use ordinary Indian ink.

*Lettering Aids You Can Make.* If you cannot buy exactly what you want, use what you have. Pens, stencils and brushes made from local materials may not produce such neat results, but they can still do a very useful job.

*Make a broad-nib pen :*

—from a twig sharpened like a chisel.

—with a piece of matchbox wood fitted into a slit in a twig or in the reverse end of an ordinary pen holder.

—from a short length of bamboo.

—take an old felt hat and cut a strip 6 cm long. (The width of the strip will depend on the size of lettering needed.) Bind the strip across the blunt end of a pencil or similar stick.

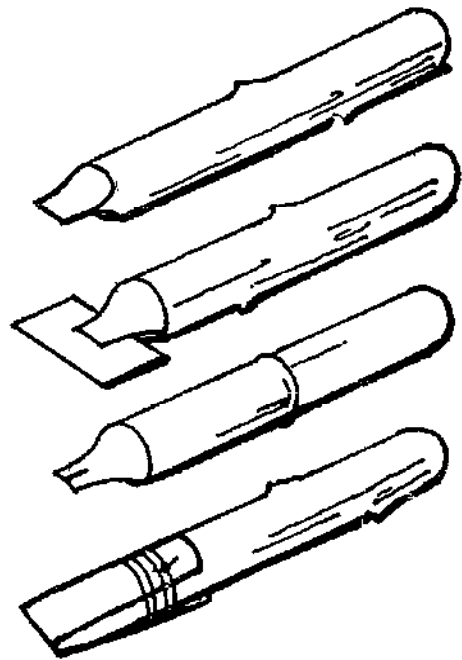

*Cut-out letters* from newspaper headlines, advertisements, catalogues, calendars and other printed matter. By keeping the different sizes separate you can select what you need and paste them up easily.

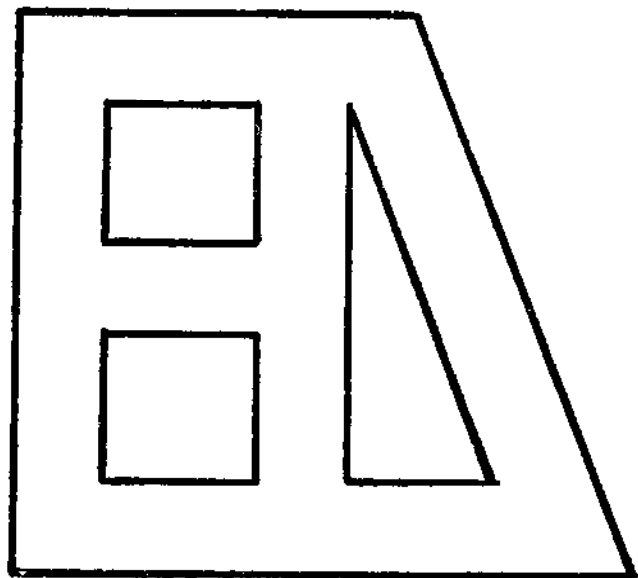

*Make a Unistencil*

This is a very useful tool when you need large lettering (10 cm to 20 cm high) for headings and captions. Cut an outline from cardboard or old X-ray film. Keep the same general proportions whatever size stencil you are making.

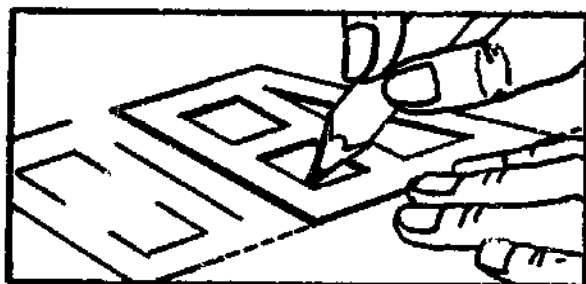

Draw a baseline on which the Unistencil can be aligned.

Trace in pencil the basic form for each letter you wish to draw.

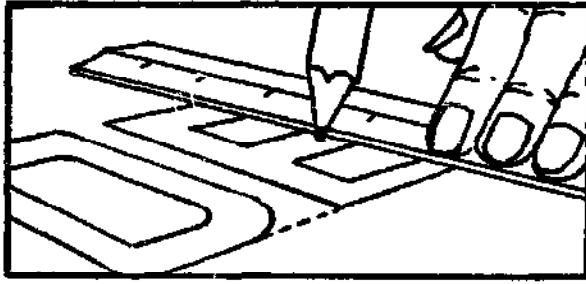

Draw in the necessary lines or curves to complete the letters.  
Finish off the lettering with pen or brush.

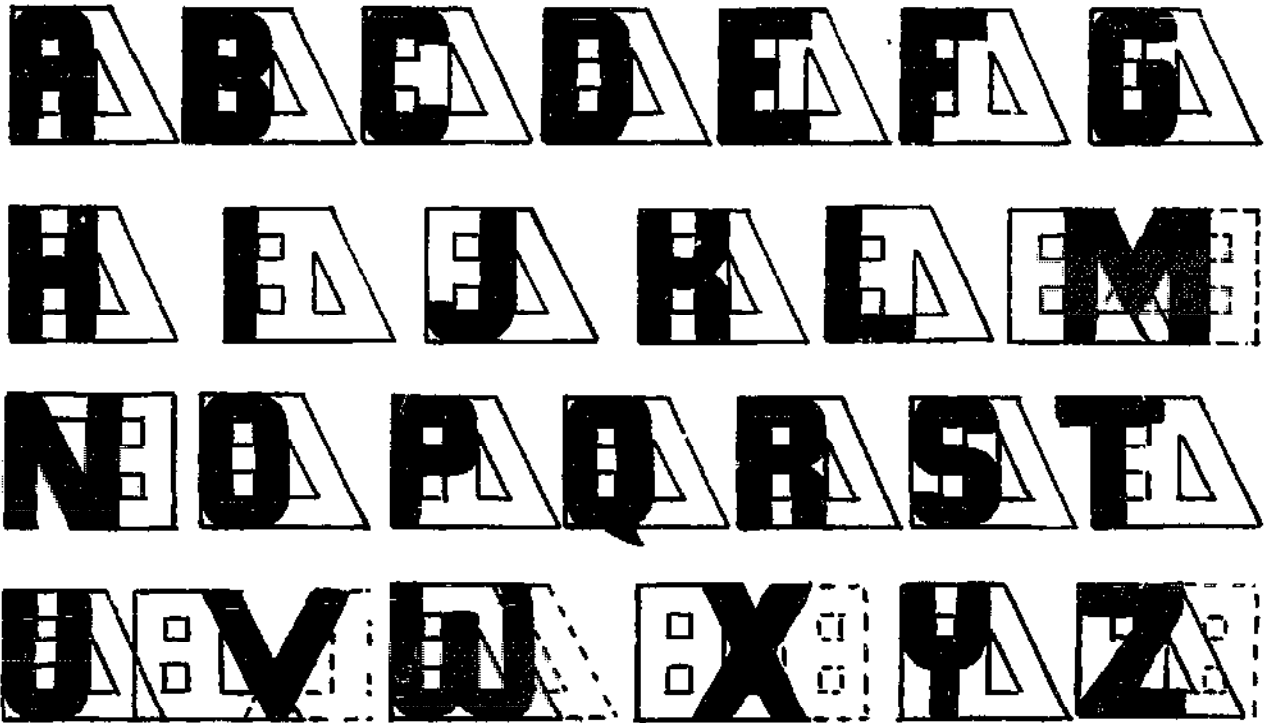

#### COLOURS, CHALKS, CHARCOAL AND CRAYONS

For posters, charts and so on, Indian ink is better than fountain pen ink and special poster colours better than coloured powders obtained locally. Lack of the *ideal* material for the job, however, need not prevent your doing an effective piece of work with what you have. Wax crayons, coloured chalks, charcoal and paints from local dyes have their limitations but when you are aware of them you can use these materials appropriately. Use your imagination and ingenuity with the materials you can obtain.

#### LETTERING METHODS

With practice, you can acquire a reasonable free-hand style and produce useful visual materials quickly and cheaply. Aim for lettering that is legible, clear and neat. Your purpose is to communicate meaning and not to create a lasting work of art! By following a few simple rules and spending some time practising you will quickly acquire confidence and ability.

Use a simple lettering style such as is taught in school :

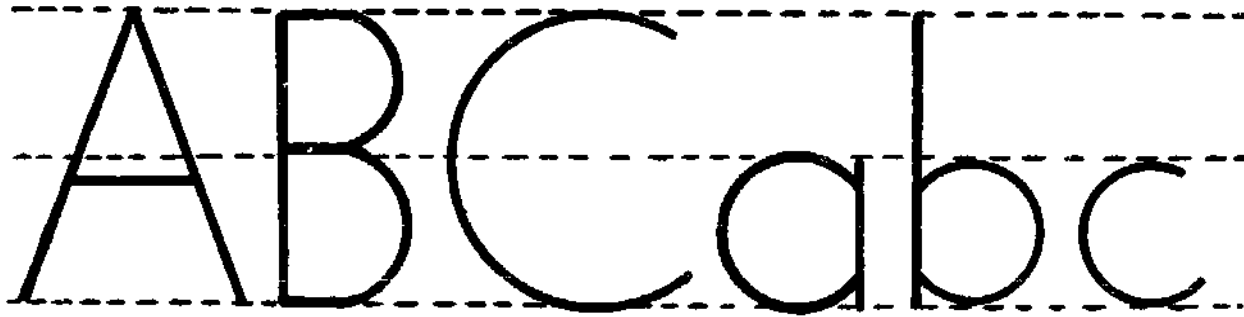

Capital letters

Lower case letters

Stencils have their place when you need a better quality finish for a special occasion or for something that will be used many times over a period of years.

*Style.* Lower case letters are usually easier to read than capitals, especially if you must include many words. Use capital letters for main titles and short captions. Plain, straightforward letters without flourishes and fancy variations are easiest to read. Remember—you want to make your meaning clear, easily and quickly.

*Size.* Letters one inch high are about the minimum for class use. For legibility, the larger the letter the thicker it should be. You cannot have hard and fast rules, however, because a lot depends on colour, contrast and lighting conditions. The important thing is to test for legibility from the back row.

*Colour.* Limit the number of colours and make sure that your lettering stands out well from the background. Black on yellow is the combination with most contrast. See: page 66.

*Guide Lines.* Lightly pencilled guide lines improve free-hand lettering and they can easily be erased afterwards. This is particularly important with large lettering.

Horizontal lines for neatness

# VERTICAL LINES HELP WITH UPRIGHTS

... especially with big lettering.

*Spacing Words and Letters.* Make sure the words will fit the space available.

Roughly pencil in your caption

By observing good quality lettering on commercial posters and advertisements you can acquire the art of good spacing better than by trying to follow many complex rules. Remember that the spacing between letters should *look* equal. The amount of space between any two letters depends on the shape of the two letters facing each other. Straight-sided letters like HIM and N must be put further apart than curved or open letters like OCFL and T.



## DRAWING SIMPLE PICTURES

If you say you are not artistic and claim that you cannot draw, this section is for you! By adopting a limited aim and by following a few simple rules you may not become a great artist, but you will soon learn to communicate by drawing simple pictures.

- (a) *Observe.* Learn to *see* people and things and then train your hand to draw what you see.
- (b) *Simplify.*
  - (i) Draw recognizable sketches. Do not worry about trying to make completely accurate pictures. Use a simple visual shorthand that will be understood by the viewer.
  - (ii) Emphasize distinctive characteristics. Avoid a lot of detail and concentrate on the lines showing the main idea.

(iii) Use the minimum number of lines. This is particularly important when using a chalkboard in front of a class because the drawing must be completed quickly. The class soon loses interest if your back is turned for more than a few seconds.

(c) *Practise.*

#### CHALKBOARD ILLUSTRATIONS

Legibility and speed are essential, so concentrate on lines which express your meaning and omit all unnecessary details and fancy extras. All teachers need to be able to draw stick men and simple outlines with confidence. Whether you are engaged in teaching agriculture, health, religion or classroom subjects, stick men are important because your first concern is with *people*.



With shoulders and hips this stick man can turn sideways.



With fewer lines this stick man is quicker to draw.

Fingers, toes and facial features are unnecessary. Drawings of simple stick men are easily understood and most people quickly learn to recognize them.

An oval head is better than a circle because the angle of the head may be suggested more easily.



Head up—  
Cheerful



Head down—  
Sad

Study the way people stand, walk, run, sit, jump and kneel and use the same basic lines for your stick men.



Walking



Running



Jumping



Diving or falling



Sitting on a chair



Praying

Add one or two extra lines to give more meaning. For example:

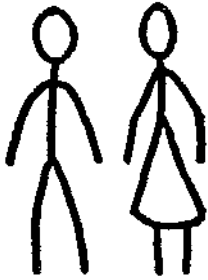

A man and his wife

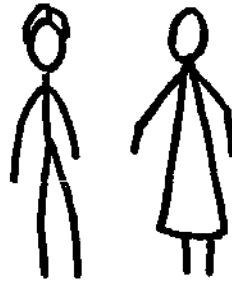

An Indian and his wife

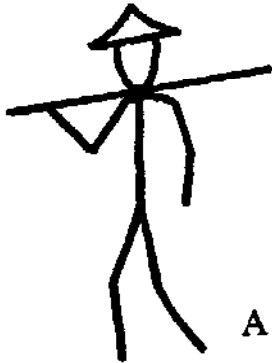

A Chinese worker



A teacher



A clergyman

Use the same method for animals and objects. Concentrate on a few lines which will express the main idea.



Donkey (head and ears)



Camel (hump)





Tree (deciduous)



Tree (coniferous)



Tree (palm)



House



Tent



Fish

Stick men and outline figures should relate to the viewers' experience. Sometimes, however, you will wish to widen their experience and this may mean explaining a sketch or object first. If possible, introduce the actual object to be discussed or show a picture of the subject before making the stick drawing on the board. The simple drawings will then stimulate the imagination so that the viewer completes the picture in his mind.

#### ILLUSTRATIONS FOR CHARTS AND POSTERS

When drawing for charts or posters you can give the stick men fingers and toes and facial expressions. You have more time for drawing because you are not in front of a class.



Eyes



Eyebrows



Mouths

Variations of these basic features may be put together in dozens of different combinations. Here are a few typical expressions.

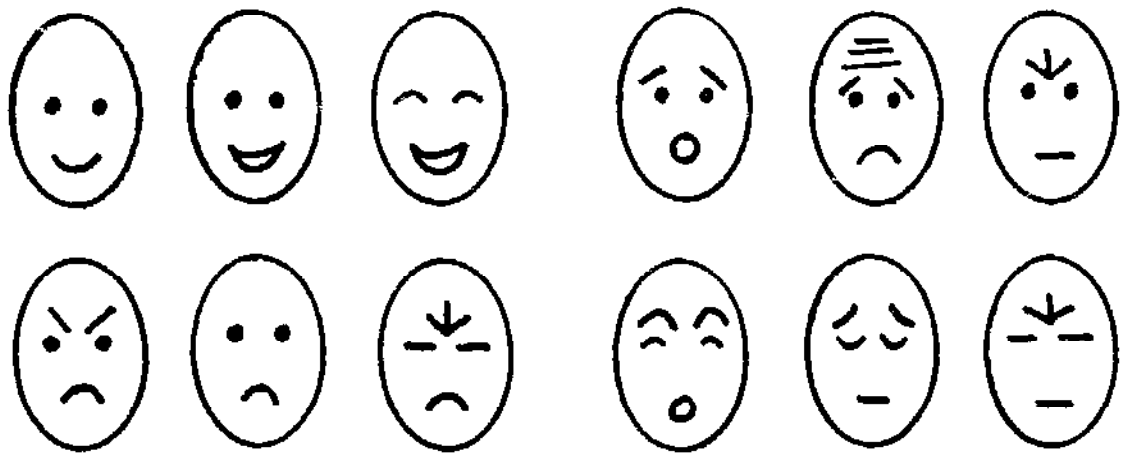

The additional details will help to get your ideas across, particularly if the poster or chart has to stand alone on display.

Remember that you are not trying to draw completely accurate and artistic pictures. Aim to draw clear, recognizable sketches and outlines.

#### COPYING AND ENLARGING PICTURES

Charts and posters are usually more effective if they include an appropriate picture. Magazine pictures will sometimes be adequate, but most illustrations in books and papers are too small for showing to a group. You do not have to be an artist to use any of the following methods, but you will need to practise a little. It is possible to enlarge from a photograph, but much easier if your original is a line drawing.

#### *Rubber Band Method*

Join together three rubber bands to form a chain. Loop one end of the bands over a drawing pin on the left-hand side of your board or working surface. Fix the picture to be enlarged so that the knot between the first two bands is above

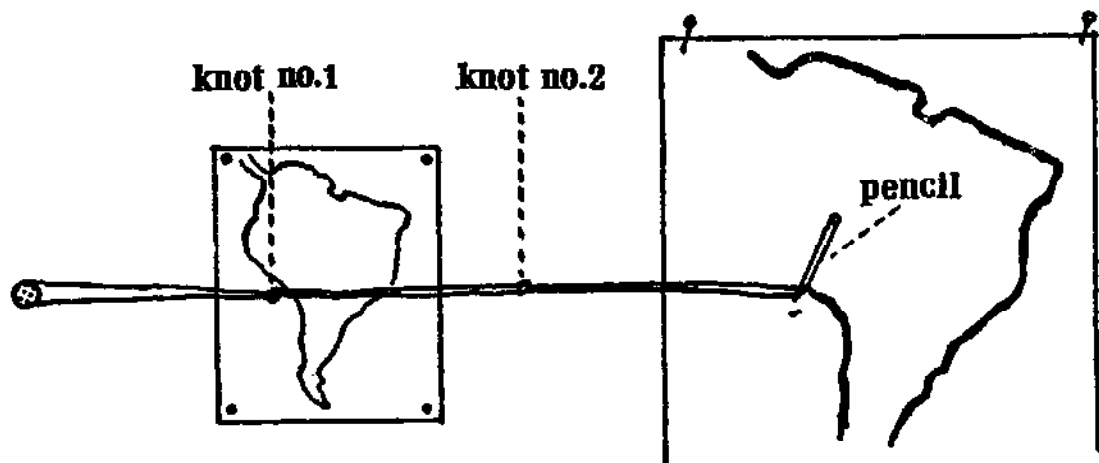

its left-hand edge when the bands are pulled taut. Into the loop at the other end of the bands, insert the point of your pencil. Keep the pencil upright and have one finger on the rubber band to prevent it slipping off. Position yourself so that you can look down on the first knot. By pulling on the pencil, you can make the first knot follow the lines of your picture. You make the knot trace the lines and, at the same time, by keeping the pencil on the paper, it produces an enlarged copy. Do not worry about faults and imperfections. You will improve with practice, and corrections and improvements can always be made when you go over the outline with a broad-nibbed pen.

### *Pantograph*

This simple device can be adjusted to make enlargements up to eight times the size of the original. By means of a screw (A) you fix the pantograph to the table or the drawing board. With the pointer (B) you trace the lines of the original picture and a pencil (C) draws the enlarged picture on another sheet of paper.

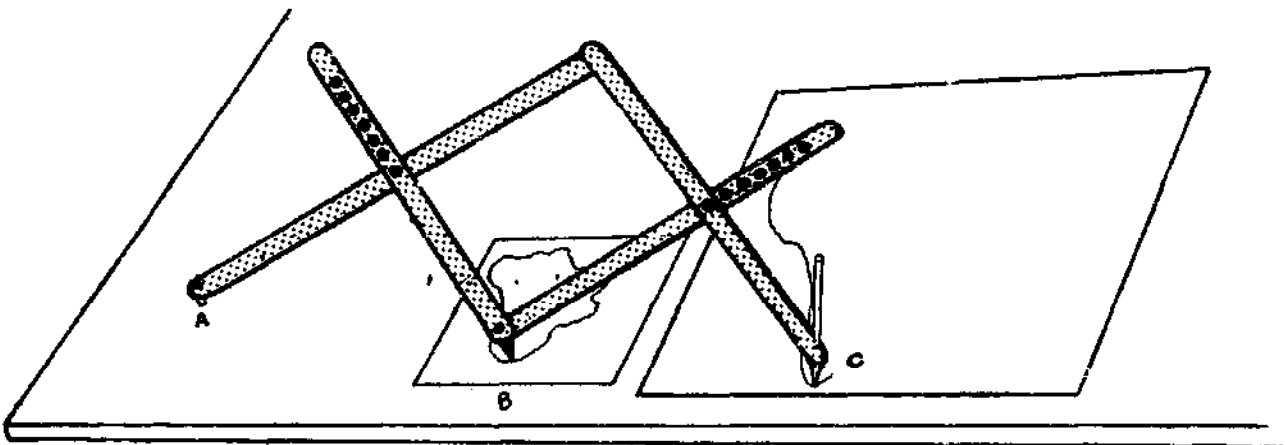

The enlarged drawing may look rather unsteady, but the general outlines and proportions will be fairly accurate. By going over the drawing again with ink or crayon you can correct any slight errors.

Start by enlarging to twice the size of the original and then experiment with other proportions when you have acquired some skill through practice.

### *Episcope*

An episcope will project opaque pictures. Light is concentrated on the picture and the reflected image focused on to a piece of paper. With a *small* episcope you can deal with a picture (or section of a picture) measuring about 10 cm × 10 cm and enlarge up to 15 times without difficulty, in blackout conditions.

For quick results you can draw immediately with a felt pen, but, to get the best quality, first do the outline in pencil and finish off with a pen when you have the paper on a table or drawing board.

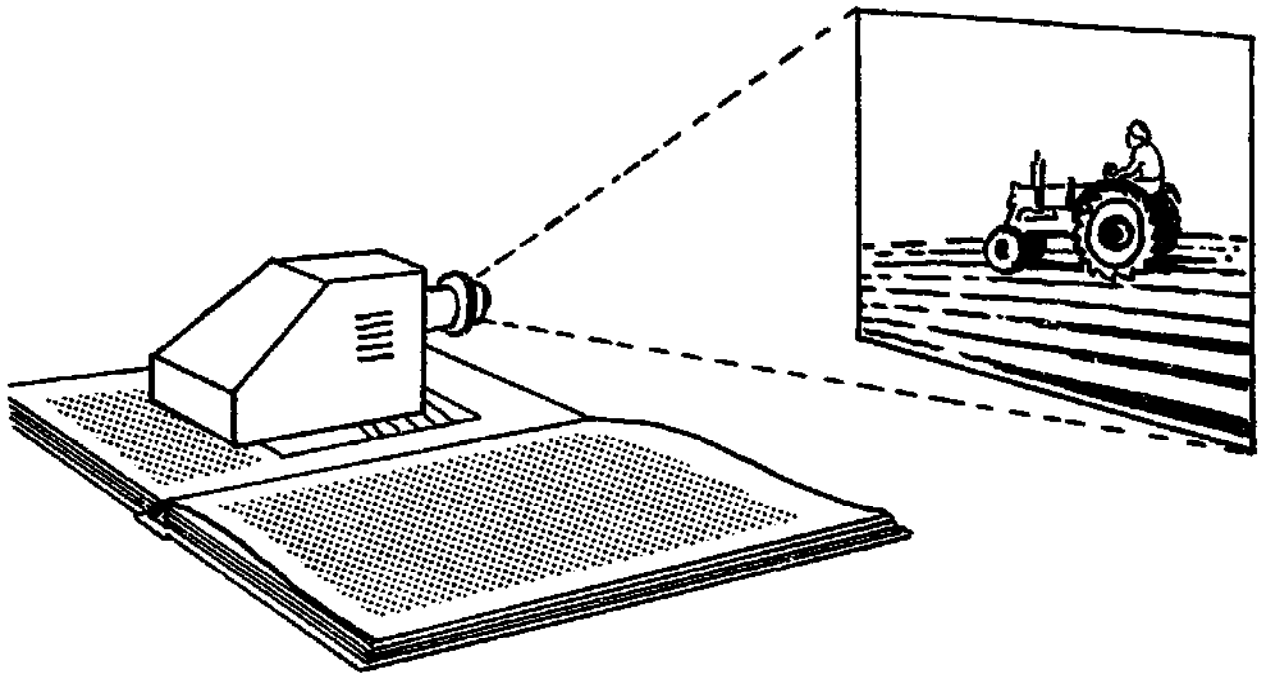

### *Filmstrip or Slide Projector*

If you have slides or a few frames in a filmstrip that are suitable for enlarging and copying on to a poster or chart they can easily be reproduced in the same way. A filmstrip/slide projector is a more powerful piece of apparatus than an episcopes so you do not need to use it in conditions of complete blackout.

**Whether you** draw your picture with the filmstrip projector, episcopes, pantograph or the rubber band method **will decide** how much detail you actually need. If necessary, you can simplify the background and change the dress styles of the figures. You can alter and adapt with your subject and audience in mind.

Time, expense and effort should be appropriate for the purpose to be served. For a special event or for a chart you expect to use many times, work with the best materials you can get and pay attention to detail. Pictures needed for one occasion only should be produced quickly. The overall impression will usually be more important than minute detail.

### PROJECTS FOR PRACTICE

1. Inquire at local shops concerning available drawing materials.
2. Visit the nearest printer and discover the price of large sheets or rolls of paper.
3. Make one sort of lettering aid and experiment with different materials.
4. Check on the lettering styles taught in local schools.
5. Work out stick men drawings to suggest a policeman, a doctor, a postman . . .
6. Make your stick men dig, throw, lift a load . . .
7. Enlarge a small picture twice the size of the original, four times and eight times and compare the results.

## Chapter 7

### CHALKBOARDS

#### DEFINITION

A chalkboard is any dark-coloured, flat, smooth surface on which you can write and draw with chalk. It is one of the oldest and simplest of visual aids. It is often called a *blackboard*, but nowadays it is often painted green!

#### ADVANTAGES

The writing surface and chalk are cheap to get and maintain.

The chalkboard can be readily available anywhere.

Many types are transportable and the teacher can turn to the board at any time.

With a little practice it is simple to use.

Simple outlines and sketches which are easy to draw on a chalkboard encourage people to use their imagination and this leads to *active* seeing on the part of the audience.

You can also encourage active *doing* as members of the group help to build up a picture, map or diagram.

The chalkboard may be used in a wide variety of ways to suit your subject and audience.

It is a natural supplement to all other aids.

The value of a chalkboard is not in the board itself but in the use you make of it. These uses are limited only by your imagination.

#### DISADVANTAGES

You need imagination, initiative, preparation and practice to make the best use of a chalkboard, but it is possible to overcome all these disadvantages.

#### TYPES OF CHALKBOARD

##### *Wall Chalkboard*

You cannot adjust the angle or position of a wall chalkboard but this type is often the cheapest to make.

A chalkboard with a *mud* or *clay* surface can be made with materials found in the village. With string or a straight piece of wood mark a rectangle on the wall at a suitable height. (For a primary school the board should be 70 cm and for a

high school or adults, 100 cm from the floor.) You may frame the rectangle with a narrow border of hard clay and afterwards paint it to match the walls. Take a hard stone and, within the rectangle, make many small holes or dents in the mud and plaster wall so that you have a rough surface to which your clay mixture will stick firmly. Collect 'worm cast' mud from beneath nearby trees or any good quality natural clay, make it into a powder and pass it through a fine sieve to remove lumps, small stones and pieces of grass. Mix the fine powder with water and knead into a soft paste-like dough. Add kapok or any other cotton-wool kind of material to make a sticky binding substance. This should prevent excessive cracking of the surface of the clay after it has dried. Splash water two or three times over the dented wall and then apply the soft clay evenly to the rectangle. Splash on a small quantity of water and rub across the surface with a trowel, ruler or something with a straight flat surface. Make the clay surface as smooth as possible by frequently dipping the trowel in water and by sprinkling water on the surface with the fingers.

Leave the board to dry for three or four days and then apply blackboard paint.

A *cement*-surfaced board will cost more but will last longer if well made. By grinding up carbons from old torch batteries and mixing with water and cement you can make a good chalkboard surface.

Be careful not to get the cement board too smooth or the chalk will skid. If it is too rough you will use up a large amount of chalk.

When making a wall chalkboard the general principle is, the bigger the better.

It is possible to buy chalkboards manufactured from glass, slate or synthetic materials. They may be slightly easier and more convenient to use but they will be far more expensive.

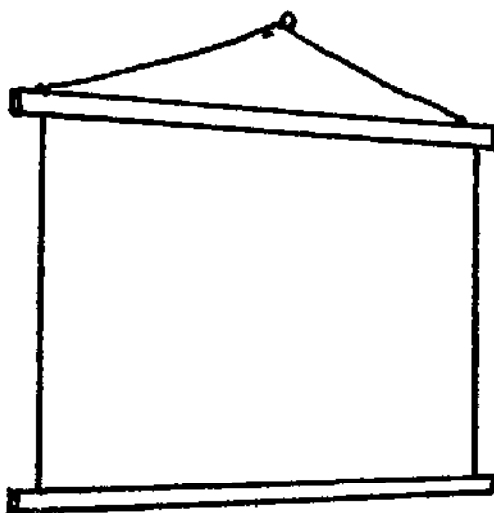

#### *Roll-up*

A roll-up chalkboard which is light, compact and easy to carry can be made from a variety of materials. Your choice will no doubt be decided by what is available. The size will depend on the number of people in your group.

Oil-cloth or rexine, first roughened with medium grade sandpaper, can be painted with blackboard paint.

Heavy plastic or rubber sheets are sometimes obtainable in dark colours. Care should be taken not to use material with a shiny surface.

Canvas or heavy cloth make a satisfactory base. First, apply a thin coat of carpenter's glue on one side and when it is dry add blackboard paint.

If commercially produced blackboard paint is not available experiment with undercoat paints. Some people use successfully a mixture of charcoal powder and gum or lampblack, shellac and kerosene. Whatever paint you use, apply two coats and allow the paint to dry thoroughly each time.

Tack the top and bottom of your chalkboard material to wooden rods, take a length of strong string or cord and tie to each end of one rod. Roll up the material with the painted side inwards.

When using the roll-up chalkboard place it against a smooth surface such as a wall or an upturned table.

#### *One-piece or Folding Board*

A rigid chalkboard is more durable and easier to use, but a small (50 cm × 75 cm) hinged board can be carried without difficulty.

Plywood, hardboard, masonite or fibre-board are all suitable. Thick cardboard can be used but it is not so durable.

Hinge two pieces together by pasting on front and back 10 cm strips of heavy cloth or canvas. If you expect to travel by cycle, a board with three sections 25 cm wide will fit conveniently on to the cycle carrier.

Sandpaper the board to make it smooth. Apply a coat of varnish and, when this is dry, give two coats of blackboard paint.

When using the chalkboard, set it on a table or stool and lean it against a wall. The height of your board will depend on your own convenience and whether the group or class is seated on chairs and benches or mats on the floor.

A heavy classroom chalkboard measuring about 90 cm × 120 cm is normally supported on an easel so that the height can be adjusted.

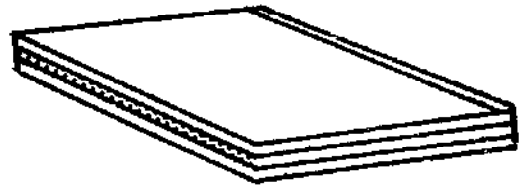

A folding chalkboard ready to carry

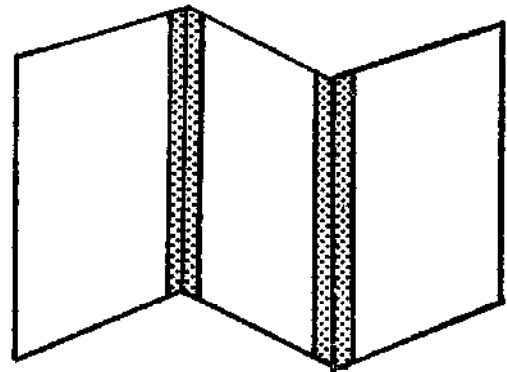

10 cm cloth hinges

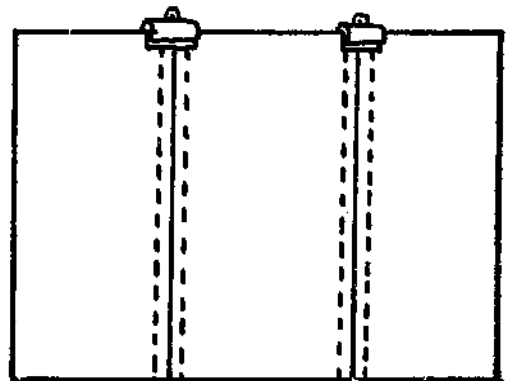

Bulldog spring clips to keep the board rigid

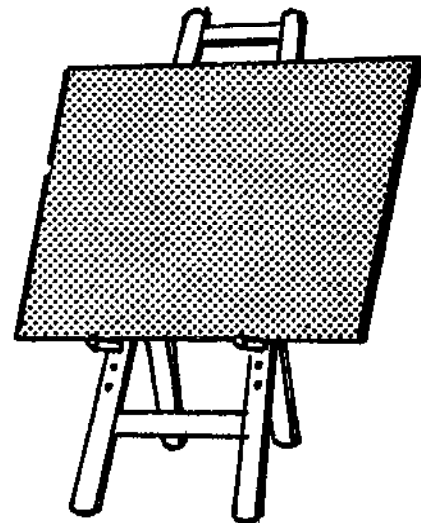

#### CHALKBOARD MAINTENANCE

Before using any new chalkboard take a chalk eraser or duster filled with chalk dust and pat over the entire board in order to fill the many small holes. After removing as much dust as possible from the surface of the board you may start writing on the board with chalk. By applying dust in this way you prevent the many small holes in the surface getting filled with hard chalk the first time you write normally on the board. Marks made by writing with chalk are often very difficult to remove if the board has not been given the dust treatment.

If your chalkboard is used a great deal wash it occasionally with clean water.

When the surface turns grey and washing will not improve it apply a fresh coat of blackboard paint.

#### CHALKS AND CHALK ERASERS

Get the best chalk available. Gritty chalk makes disturbing squeaks as you draw and often scratches the surface of the board.

By soaking in a solution of sugar and water you may treat ordinary chalk so that it will not scatter so much dust.

In the same way, by soaking white chalks in coloured inks you can make your own coloured chalks.

Use coloured chalks for emphasis and contrast. Do not overdo the colours. You cannot emphasize more than a small proportion of your words or pictures. Remember that some colours cannot be seen so easily. Check from the back row.

Felt pad chalk erasers are commercially available but with a little ingenuity and available materials, many teachers make their own. Try a thick pad of plastic foam or make a roll of old rags and sew into a pad using a cover of strong cloth.

When erasing, use an up and down motion. In this way the chalk dust will fall directly to the floor.

Avoid erasing with your fingers!

#### USING THE CHALKBOARD

##### *Words*

Printed letters with capitals and lower case are usually more readable than script. Make the letters big and clear so that they can be read easily from the back row.

When writing several words move in the direction of your writing; this will help to keep the lines horizontal. If you still cannot write straight use guide lines. To draw a straight line rub a piece of string with chalk and stretch it against the board. Ask someone sitting nearby to hold one end while you hold the other. When the string is level and taut pluck it so that it snaps back leaving



a line of chalk dust. By keeping the string in the chalk box it will remain permanently covered with chalk dust and ready for use.

Words can be emphasized by underlining or (circling)

### *Maps and Diagrams*

When you expect to use a particular map or diagram frequently there is a lot of value in having the outline always available. If you have a large wall chalkboard, a map of Palestine (for Christian teaching), a human skeleton (for biology lessons) or a village plan (for community development projects) can be permanently painted on a three- to four-foot section at one end.

Alternatively, the map or diagram can be painted on a roll-up chalkboard and hung up when needed.

Some simple outlines can be constructed out of plywood or hardboard. The teacher holds the *template*, as it is called, against the chalkboard and draws a chalk line round the edge.

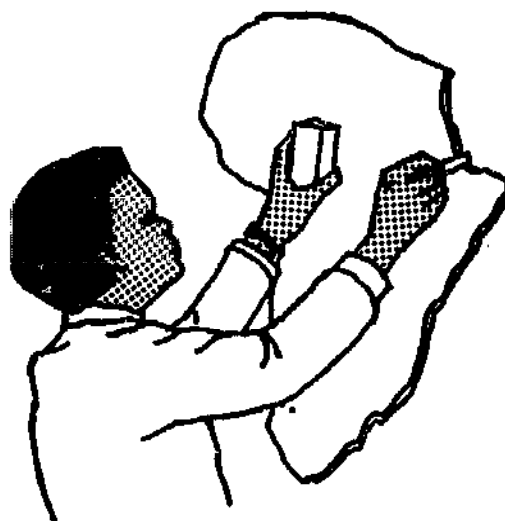

Another way of outlining maps is first to draw the map on a large sheet of strong paper (old brown paper will do) and then make a series of perforations along the lines drawn. After finishing the perforated outline hold the paper against the chalkboard and pat the lines gently with a dust-filled chalkboard eraser. On taking the paper from the board you find a line of dots left behind and you join these up to make an outline map. The paper with the perforated outline may be stored for future use.

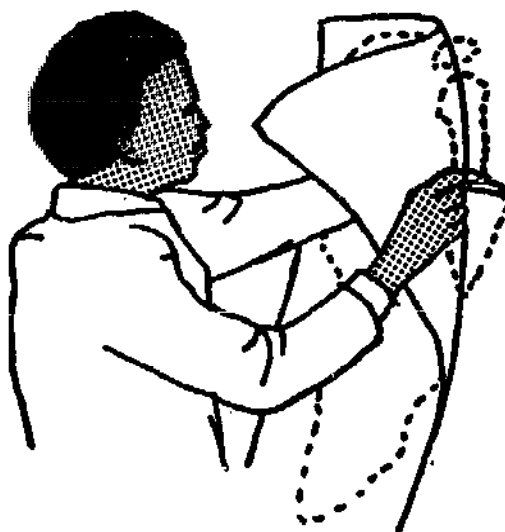

### *Pictures and Symbols*

Poorly drawn pictorial attempts have only a limited value so consider the following principles:

For showing accurate information and facts rely on the real thing or on pictures produced beforehand (bought commercially or copied or drawn carefully by the teacher).

For quickly drawn visual shorthand, recognizable sketches and chalk and talk use the chalkboard.

See: *Drawing Materials and Basic Skills* page 42.

### *Methods*

Introduce your subject by writing a short statement or question on the board. The main points of your talk or the group's discussion can be summarized below.

Some teachers divide the chalkboard into two sections:

Temporary work—incidental explanations, working diagrams and sketches.	Summary of teaching, gradually built up throughout the lesson period.
--	---

With adhesive tape, stick a paper picture to the centre of the board and use the surrounding space for explanation in words and diagrams. By combining the use of paper picture and chalkboard you get the best from both.

Avoid writing or drawing a great deal on the board beforehand. A *progressive* story or presentation is more interesting when developed on the spot. If the drawing is too complicated to be done freehand in front of the group, draw it beforehand, rub out carefully so that the lines are visible only to you and then draw over the lines as you gradually present your subject. Movement and development are characteristics of good chalkboard use.

As you write or draw involve the viewers, pause for explanations and questions. The audience must be brought into the picture. Ask questions like, 'Where shall we draw a well?', 'Is this man walking or running?'

Members of the group can help complete pictures, diagrams and sentences. Whenever possible, aim to get this kind of active involvement.

Illustrate your theme or story by a chalk talk through which you gradually build up the idea with a combination of pictures, symbols and words. The first simple mark on the board gains attention, the gradual development of the picture sustains the interest. The finished drawing gives a good illustration of the spoken message.

Many people are familiar with strip cartoons and telling a story in a series of pictures is a useful chalkboard method. Having planned and practised beforehand, divide the board into the number of rectangles required and then tell the story step by step as you move from one square to another.

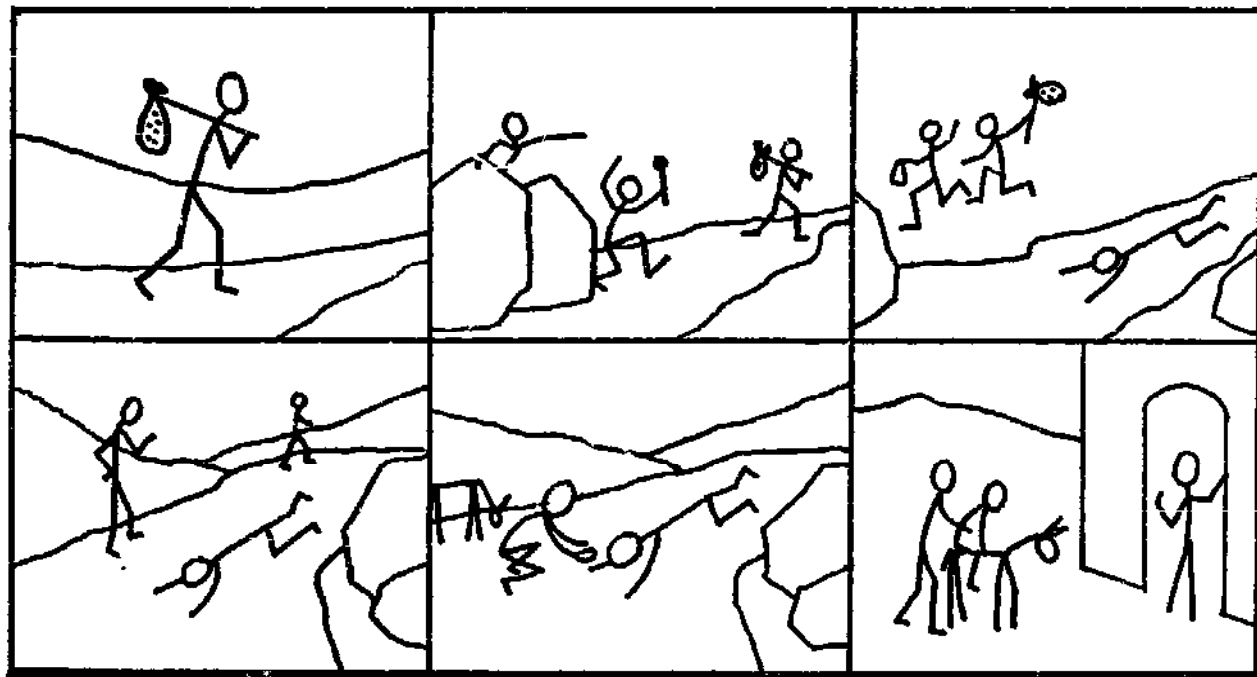

Chalk and talk go together. Write or draw a little at a time and talk as you draw. Simultaneously your words help to explain the pictures and the pictures help to illustrate your words. When you are using this method and facing the board for brief periods remember to speak loudly and clearly.

### *Practical Points*

- Plan and practise beforehand—on paper and on the board.
- Make sure there is light on the board and not in the eyes of the viewers.
- Check for glare and reflections from the viewers' seated position.
- Start with a clean board.
- Erase unwanted drawings and words as you go along. By using up and down strokes with the eraser the chalk dust falls straight to the floor.
- Make your work large and bold—check for visibility from the back of the room.
- Make your drawings simple and clear—so that they may be copied easily.
- Be quick, neat and confident—but not careless.
- Stand to one side and do not hide the board.
- Work together with your group.

### **PROJECTS FOR PRACTICE**

1. **Make a chalkboard suitable for your work and show another teacher how he can do the same.**
2. **Experiment with other writing materials and surfaces, e.g. charcoal on old newspapers; crayons or felt pens on cheap paper; a sharp stick or stone to draw on the sand or earth at your feet!**
3. **Discover if you can write on the chalkboard legibly, quickly and straight.**
4. **Plan your next talk using the divided board method.**
5. **Discuss a lesson with other teachers and ask, 'How can the chalkboard help?'**
6. **Practise drawing more stick men.**
7. **Try giving a chalk talk with drawing and talk carefully linked together.**

## Chapter 8

### POSTERS AND CHARTS

#### DEFINITIONS

The words *posters* and *charts* mean different things to different people, so let us define our terms.

#### Posters

- (a) **Single-Glance.** These can be read and understood quickly without any spoken word.
- (b) **Stop-and-Study.** With these you need time to look at the variety of pictures and captions, but they do not need verbal explanation.



**GO WELL-  
GO SHELL!**

#### Charts

- (a) **Wallcharts.** These are sometimes similar to stop-and-study posters, but they may include more information with symbols and diagrams.



**CHILD CARE**

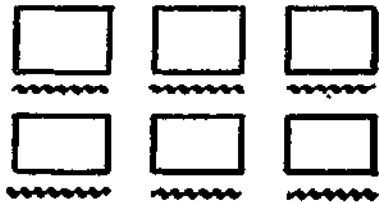

- (b) **Teaching Charts.** These are accompanied by a teacher's verbal explanation as he uses them to help in formal education.



**GROW YOUR OWN  
VEGETABLES**

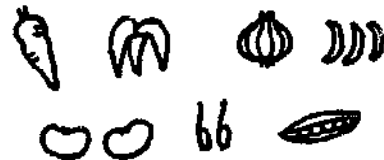

#### OBTAINING AND SELECTING POSTERS

Explore every available source—government departments, commercial firms, travel agents and voluntary organizations. Free posters that you acquire may not be exactly what you need, but you may be able to adapt them for your

purpose. When selecting posters consider the needs of your audience and judge by certain standards.

A good poster will :

Attract attention.

Convey one message.

Encourage action.

#### SINGLE-GLANCE POSTERS

A single-glance poster cannot convey much information, develop a theme or prove anything. It may :

Introduce a new idea—about an event or a product.

Remind—about facts previously learned.

In general, a single-glance poster does not aim at the intellect. It usually appeals to the feelings.

#### *Displaying Single-Glance Posters*

Choose a site which can be seen easily by the people you want to reach. A poster just above eye level can be seen by others even when there are crowds of people about. Avoid walls or boards covered with many other posters. A poster surrounded by clear space or mounted separately will attract more attention. Ensure adequate lighting. Outdoors, a site near a street light is useful.

Any poster displayed outdoors should be well protected. One that is torn or damaged does not help the cause it is trying to promote. Some protection from wind and rain can be arranged by having the poster on a veranda or on the leese, under the eaves of a house. Posters coated with a thin starch solution and then varnished stand up to the elements quite well.

For maximum effectiveness, a poster should be part of a campaign—it should not be used alone. Employ other aids at the same time or in the same area. If people see a poster several times the message will be impressed on their minds. Up to a point, the greater the number of posters used in an area the greater the impact. After a time, however, a poster becomes part of the familiar scenery and will probably be ignored. Change posters every two or three weeks and leave the board empty for a day or two before putting up a new poster. This will make sure that people notice the new one.

#### STOP-AND-STUDY POSTERS

The principles of attracting attention, conveying *one* message and encouraging action apply with stop-and-study posters, too. One main difference is that these take longer to read than the one-glance variety. Stop-and-study posters contain more words and pictures and will sometimes include a series of pictures set out like a cartoon story. A large striking caption or picture may make a person stop.

Then he will go closer to study the smaller illustrations and read the captions. By this simple action of going closer he is already making some response.

### *Displaying Stop-and-Study Posters*

Where do people normally have time to study detailed posters? Good sites are found by bus stops, on station platforms, *inside* buses or trains, near village meeting places and in clinics and other waiting-rooms. Friendly shopkeepers are often willing to display posters. Some people use posters for home decoration. This often leads visitors to ask questions and start discussing the subject.

Do not display this type of poster by the roadside where people pass quickly on cycles or in buses and cars.

### WALLCHARTS—TO BE STUDIED

A wallchart or wallsheet is sometimes very similar to a stop-and-study poster but usually contains more detail. A poster has to be selected or designed with the interests of the general public in mind. A wallchart is used as an aid to informal study and to supplement formal teaching, so its choice and design will usually be dictated by the syllabus or the course of study. Wallcharts are often used to summarize or follow up a series of lessons.

A chart can be as simple or as complex as the subject and the training situation demand. The main purpose of a chart is to present facts in a visual form. It can give a broad view of a subject and is helpful in making generalizations. Some charts—especially graphs and diagrams—present reality through symbols, so uneducated people may not find them easy to understand.

Make or use a wallchart if you expect to show it again in the same way. Alternatively, use the illustrations and captions separately on a display board so that you can arrange them differently when needed for another occasion. See: *Display Boards* page 70.

### *Displaying Wallcharts*

Studying a wallchart is something people do not *have* to do. The eye must be attracted and the attention held by good design and effective display techniques. Put up the wallchart where people have time to stop and read and, if possible, arrange some extra lighting.

### TEACHING CHARTS

A teaching chart is one designed to be used by a teacher with a class or group. The chart can save much time spent in chalkboard preparation, especially if you teach the same subject to different classes.

For some purposes one chart may be enough. If you need to show the different stages of a process or the step-by-step development of a subject, arrange a series

of charts clipped together to form a flipchart. See: *Sequence Pictures* page 33.

Think of the teaching situation the chart is intended to serve, e.g. class teaching, group study or reference purposes. All illustrations and lettering need to be big enough to be seen by all in the class or group.

A teaching chart used as an introduction to a subject needs to be simple and provocative.

### *Using Teaching Charts*

Before using a teaching chart remove all unrelated material nearby so that attention can be concentrated on the chart to be shown. Use a chart to introduce a subject or to open a discussion by posing stimulating questions and problems. Review work done by using charts previously studied. Summarize the key points as you proceed. Whether you use a chart to introduce or to summarize, make it an integral part of the lesson or session.

### PLANNING YOUR OWN POSTERS AND CHARTS

	<i>Posters</i>	<i>Charts</i>
Why make?		Could another aid be equally well used? If other aids will also be used to help convey the message, what particular role will this poster or chart play?
What do you want to say?	Be quite clear about the one main idea you want to present.  For a poster which has to stand on its own the idea must be important for the viewer.	
Whom do you want to reach?	The general public? A particular section of society?  Consider their interests and experience.	Consider the age and experience of the class or group.
Where will it be displayed?	Where people pass quickly (perhaps at a distance) or where they will have time to stop and read?	Design on a large scale for class-room use or for close-up informal study?



When will it be used?

At the beginning  
or end of the  
lesson or session?  
On its own or by  
a teacher?

How many times or for what period of time will it be used? Your answer decides the material you use. Temporary posters or charts may be made from cheap materials and it is unnecessary to spend too long on their preparation.

#### DESIGNING SINGLE-GLANCE POSTERS

(In general, these principles apply to all types of posters and charts. You will not find them difficult to apply.)

##### *Brevity*

A poster must be brief so that:

- (a) it can be read in a few seconds;
- (b) the letters can be large and bold and can be read from a distance.

You need a simple presentation of a single idea to be read at a glance.

There are no hard and fast rules as to the exact number of words a poster should contain. Usually there should be no more than eight words, but four or five are better.

Informative captions are better than those arousing only general interest. Let them point to the heart of the matter. Captions can have any one or a combination of four forms:

Command—*Eat more fruit for health.*

Question—*Do you read The Times?*

Suggestion—*Your crops may suffer.*

Positive Statement—*Malaria kills. Paludrine saves lives.*

##### *Simplicity*

A good poster is compact, has a minimum of individual units and a bold illustration containing only essential details. It is better to have one bold illustration than a group of smaller ones competing with each other for attention. Not everyone possesses the talent to make a poster technically perfect, but you need not be particularly gifted to make it simple.

##### *Originality*

Try to express the poster idea in a clever and original way. This applies to the words, the illustration and the link between the two. Write down the first

slogan that comes to mind and make a rough sketch of your first idea. Do not be content with your first effort. Keep on thinking until you find a way of getting the point across to the viewer that no one has ever thought of before.

### *Illustration*

Effective posters may be designed with words only and a clever caption will often be remembered. The viewer's attention, however, is usually caught by the illustration and a well-chosen visual often helps him to recall the poster's message.

On your poster, the picture must convey the same idea as the words. Remember your viewer's experience with pictures and choose a style which will be readily understood. Viewers will respond well to a picture relating to the local situation, particularly if it shows how they would like their homes and families to be.

See: *Illustrations for Posters and Charts* page 61.

### *Layout*

Proportions, contrast and impact are aspects of layout and design which can best be learned by experiment.

Draw various parts of the poster separately and cut them out. Experiment with various layouts by moving the pieces around.

You can also learn a great deal by observing and evaluating other people's designs.

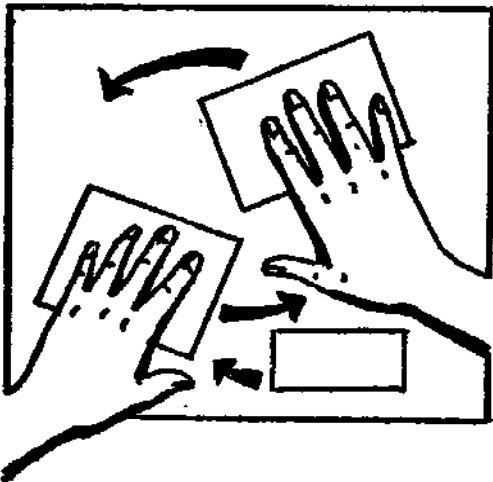

### *Colour*

Used properly, colour helps to attract attention and it is often the best method of emphasizing a particular point. Do not include colour just for decoration. Choose colours carefully because, in some countries, they may be associated with political parties or with certain cultural ideas.

In practice, two colours are usually enough. Too many colours add confusion and cost. Remember that white is an important additional colour and can be used as part of the design. For the maximum effect, use contrasting colours—dark colours on light backgrounds or light colours on dark backgrounds. Black on yellow is reckoned to be the most striking combination.

## MAKING YOUR OWN POSTERS

### *Materials and Lettering*

See: *Drawing Materials and Basic Skills* page 42.

### *Illustrations*

In addition to the copying and enlarging methods described in *Drawing Materials and Basic Skills*, you can cut out large pictures from magazines. Large close-up photographs of various kinds are particularly effective if unnecessary detail is removed by trimming.



### *Pre-test Your Posters*

The methods mentioned above assume that you will be making only one or two posters. If you expect to have your posters printed in quantity you can waste a lot of time and money unless you are critical of your own designs and ready to test them out with potential audiences before you go to print. Stories can be told from various countries about posters which had to be withdrawn because they were misunderstood, sometimes in most unfortunate ways.

1. First of all, view your poster design from a distance of about 30 feet. Can you see the message easily? Remember that the ordinary viewer will not be so familiar with the idea and will therefore not find it so easy.
2. Put up a poster in a prominent public place and watch how long people stop and look at it. (In this case, the poster stands on its own and this is a test of whether it can really *attract attention*.)
3. Ask your friends and colleagues to look at the poster from a distance and give you their impressions. They will look at the poster because you ask them to but their comments *on the message it conveys* are often helpful.
4. Work out other pre-testing methods with selected people in order to see if the poster really does *encourage some response and action*.

The pre-testing must be done as objectively as possible. Do not try to defend your design against all criticism. Aim to discover your poster's weak points so that you can improve them.

## DESIGNING CHARTS

Many of the points outlined above apply with charts also. Here are a few extras:

Have *one* idea—a concrete rather than an abstract idea. It is better to have two or three charts with one idea each than a chart with two or three ideas mixed up.

Simplify your one idea—get the facts,  
eliminate unimportant facts,  
arrange the facts in a logical order.

Guide the eye to salient points. Logical, clear and orderly layout is essential. It should be immediately apparent where the sequence begins and ends. As far as possible make the chart direct, clear and easy to follow. The value of a chart is not in proportion to the amount crowded on to it. Empty space is not necessarily wasted space.

*Lettering*

Have a striking title to make people stop. Include smaller lettering for people TO READ.

*Illustrations*

Illustrations make a chart more attractive and memorable.

A newspaper cutting may be an illustration, particularly if you have underlined important sentences.

Draw attention to the pictures with backgrounds of coloured paper shapes, arrows, circles, etc.

Eliminate all excess words and use signs and symbols such as faces and figures to convey key ideas.

Pictorial statistics make a greater appeal than numbers.

Comparison of quantities should be indicated by the number of symbols rather than by their size.

**Example of misleading system. Comparison by size of symbol**

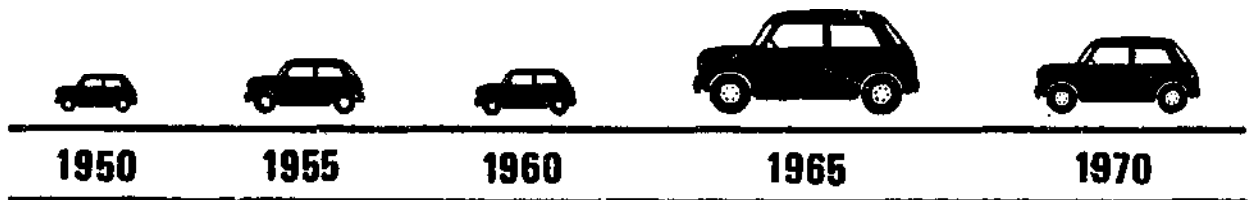

**Example of clear system. Comparison by number of symbols**

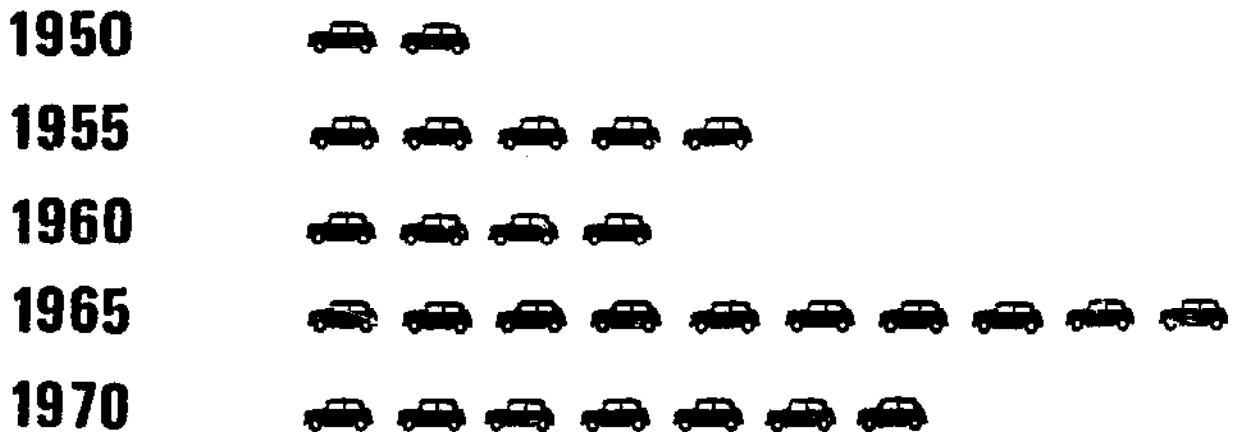

### *Study Guide*

Prepare a brief guide sheet or a short list of questions which will lead to activity by the group.

### *Summary*

- (a) In teaching a skill, be simple and isolate the important stages.
- (b) In giving factual information, emphasize the characteristic or distinguishing features.
- (c) In organizing knowledge, arrange items to produce a pattern. Isolate key items and emphasize their relationship.
- (d) To exercise judgement it is necessary to stimulate discussion. Use provocative material and underline comparisons and contrasts.
- (e) In changing attitudes it is necessary 'to overcome the victim's resistance and lure him within range of its message . . . to break into his train of thought . . . to remain in his thought long enough for him to take the necessary action about it'.

(Of course, members of your class or group may make their own charts. See: *Display Boards* page 70.)

### PROJECTS FOR PRACTICE

1. Study some of the popular commercial advertisements in newspapers and on roadside poster sites. Select those slogans and layouts which impress you most. Why do they?
2. Design and make a single-glance poster advertising a forthcoming event in your locality.
3. Organize test experiments with one or two commercially produced posters. Then use the same methods and standards to pre-test your own design.

## Chapter 9

### DISPLAY BOARDS

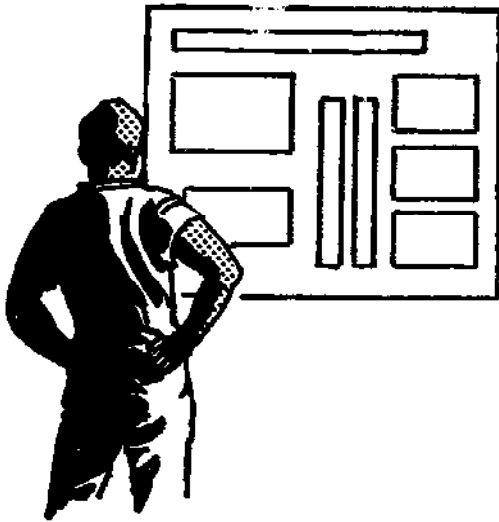

Seen from a distance, a display board may look like a wallchart, but on a closer look you discover that the display is made up of a variety of small pictures, captions and other items. The whole thing is very flexible in design and use. Sections of the display can be moved or changed whenever necessary. Whether you call it a display board, bulletin board or news-board it can help the learning process a great deal when used with imagination and care.

#### MAKING THE DISPLAY BOARD

Use soft wood, soft building board or even flattened out cardboard boxes. You can improve the effect by covering the board with cheap cloth of any plain dark colour and by giving it a painted frame. The size of the board will depend on where you intend using it and the kind of displays you expect to prepare. The general principle is—the bigger, the better.

#### WHO SHOULD BE RESPONSIBLE FOR THE DISPLAY?

There are two main alternatives and they serve different purposes.

- (a) You, as teacher or leader, may collect the materials and plan the layout.

You may:

Introduce a new subject by displaying related questions and pictures to arouse interest.

Link with your regular teaching and show visual materials which are too small to use in the large group.

Review and summarize a series of lessons or talks.

Emphasize special events in the life of the institution concerned.

Remind people of certain obligations.

Keep people interested in the progress of your programme.

(b) A group or class may be responsible for the display.

They will:

Learn through discovery; through doing.

Widen their view of the subject as they collect and relate various pictures and pieces of information.

Clarify their thoughts as they decide on appropriate headings and captions. You will need to explain the subject and its limits and plan the work so that all are involved. With this kind of activity, collecting and co-ordinating information is more important than over-elaborate drawings and designs. Make sure that the group understands the main theme and the general concepts involved.

#### WHERE TO PUT THE DISPLAY BOARD

This will depend on your purpose. For many purposes, you will need to put it where people often gather informally, e.g. a community centre, a church hall, a clinic waiting-room, a school hostel or a village shop.

In a classroom, you may prefer to have it near the chalkboard so that work may be integrated.

Make sure that the board is well lit.

See: *Displaying Stop-and-Study Posters* and *Displaying Wallcharts* page 63.

#### MATERIALS FOR YOUR DISPLAY BOARD

Collect pictures from magazines, brochures and catalogues. See: *Selecting Pictures* page 18.

Trace and enlarge pictures in textbooks. See: *Copying and Enlarging Pictures* page 50.

Gather newspaper cuttings, leaflets, coloured paper shapes, paper for headlines and captions. See: *Designing Charts* page 67.

#### Layout

The advice given in relation to the design of your own posters and charts will help a great deal with display boards. See: pages 64-68.

The main steps to follow include:

Decide on the theme.

Collect and select the most appropriate materials.

Decide on headlines. } Choose your words

Write captions. } carefully.

Plan the design. Consider various alternatives.

Arrange the board.

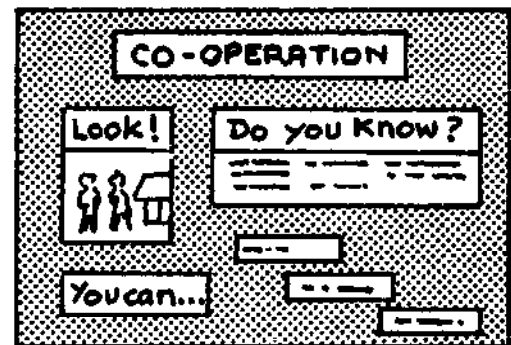

A suggested layout

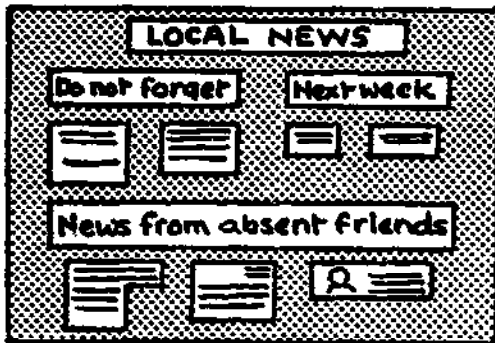

### *Regular Features*

One section of your display board may be reserved for announcements, photographs and newspaper cuttings of local events, reminders and notices.

For this section of your display board the headings and captions may remain on the board for several weeks while the related photographs and notices are changed more frequently.

A bold arrow cut from coloured card can be pinned on, pointing to any very important item.

Coloured tape or string can be used to link questions with answers.

### DISPLAY METHODS

There are several good ways of fixing your display board material.

*Drawing pins.* Instead of damaging the corners of pictures, drawing pins can be inserted at the edges.

*Ordinary pins.* Some teachers claim that these are less conspicuous.

*Stapler.* The open end of a stapler provides a quick method, but it is not so easy to get the staples out.

*Plastic bags.* Small pictures may be protected by putting them in plastic bags which are then pinned to the board.

### MORE IDEAS FOR TEACHERS AND LEADERS

- (a) Display three or four pictures with one or two questions under each. This will encourage people to look carefully at the pictures in order to discover the answers.
- (b) Make a picture dictionary. Display pictures of things which come into your teaching, e.g. manger, scroll, synagogue, etc.
- (c) What is wrong? Display pictures or statements asking people to spot the mistake.
- (d) After starting a display you may leave a section for the group to finish. Pose a problem with pictures and captions and leave a space for people to fill in the answer, e.g. war, poverty, crime, superstition, etc.



#### **MORE IDEAS FOR GROUP AND CLASS ACTIVITY**

- (a) Exhibit all practical work.
- (b) Organize a wall newspaper. Divide into sections for various subjects with an editor for each section, e.g. news of the world; the country; the local group.

Whoever is responsible for the board, it is a good plan to leave it completely blank for a day or two after any display has been on view for a week. This will ensure that people notice when new material is put on the board. When pictures are taken down they should be filed carefully for future use. They will be needed again.

#### **PROJECTS FOR PRACTICE**

1. Collect materials and make a display board for your institution—or your home. (In a family where parents and children engage in various activities a display board can be very useful!)
2. Make a small display on a subject related to your work.
3. Consider one or two ways of getting a group to learn through making a display.

## Chapter 10

### FLANNELGRAPH AND OTHER ADHESIVE AIDS

#### DEFINITION

Flannelgraph and other adhesive aids allow you to illustrate a story or an idea as you add (or take away) cut-outs one by one. They use different materials but the principle is the same.

*Flannelgraph* is based on the adhesion of rough surfaces. Material having a rough or hairy surface, when placed against a similar surface, will remain in position because the fibres interlock.

*Magnetic board* relies on the adhesion of magnets to ferrous (iron) surfaces.

*Plastigraph* is based on the adhesion of smooth surfaces. When two very smooth surfaces (e.g. shiny, pliable plastic) are brought together so that all air is excluded, atmospheric pressure keeps them in position.

#### ADVANTAGES

*Simplicity and Concentration.* Starting with a plain background you can introduce one picture at a time. Clarity is more important than detailed realism. Flannelgraph provides a visual framework which can then be clothed by the individual imagination.

*Development.* You can build up your subject bit by bit in visual form, sometimes employing elements of drama and suspense.

*Movement and Change.* As with a movie film, characters come and go, the scene may change and pictures may be moved about on the scene. (There is also the advantage of a still picture where you can hold a scene as long as necessary for questions and discussion.)

*Speed.* Having prepared your pictures beforehand, you can put them on the board with very little delay.

*Audience Participation.* With almost all media you can arrange for the audience to take some part in the telling or retelling of the story, but flannelgraph and other related aids are particularly suitable for this purpose.

*Repetition.* If you store your pictures carefully you can use them repeatedly.

*Local Production.* The sources of available materials are virtually endless. With local resources you can produce simple outlines and pictures to suit your own needs.

All flannelgraph materials should be prepared in such a way as to use these characteristics to the full.

#### DISADVANTAGES

With all adhesive aids some skill with the hands is needed, but some people do not seem to be able to manage easily. Clumsy handling draws attention to the medium and away from the message.

*Flannelgraph.* The main enemy is wind. You may have problems if your flannelboard is close to an open window.

*Magnetic Board.* The board may be heavy and the magnets (which may easily get lost) can be expensive if you are unable to get any from old telephones, loudspeakers or electric motors.

*Plastigraph.* The flexible plastic is not always easy to manipulate and dust on the plastic surfaces prevents adhesion. In addition, light is reflected from the smooth plastic surface making the outlines and shapes difficult to see.

#### THE BOARD

The flipchart stand illustrated under *Showing Sequence Pictures* page 36, may be made with flannel, metal or plastigraph surfaces.

The one-piece or folding board illustrated under *Chalkboards* page 55, may be treated in the same way.

*Flannelboard.* You can make one from almost any kind of flat board. Some teachers have even made serviceable boards from flattened out cardboard boxes tied to a frame of corn stalks! With regard to the cloth covering, there is little point in specifying any particular type like flannelette, winceyette, swansdown or milk filter cloth. An old blanket may be adequate, but your best plan is to see what kinds of rough, hairy cloth are available locally and test them for effectiveness. Pictures adhere more easily if the 'flannel' is glued down or held very taut by tacks. It is important to avoid ripples in the cloth. Some flannelgraph users who travel a great deal take with them just a piece of flannel and then tape or pin the material to any board or convenient flat surface found in the village. If the flannel is lightly brushed before use adhesion is improved.

The better the flannelboard, the cheaper the running costs, because you can often use blotting paper or duplicating paper for the cut-outs instead of more expensive backing materials.

*Magnetic Board.* The base may be the same as for a flannelboard, but it will need to be covered with a sheet of tin-plate or galvanized iron. A beaten out kerosene or petrol tin will do. Metal window screening works fairly well and will be less heavy. Paint the metal surface with a dark colour if light-coloured pictures and outlines are to be used. If chalkboard paint is used your magnet board can serve a double purpose.

#### THE PICTURES

Remember:

Your viewers' experience of pictures.

Your theme or subject.

Select your pictures carefully.

} See: *Selecting Pictures* page 18.

*Commercially Produced Pictures.* Before purchasing any material check to see if it has the flannelgraph advantages—concentration of attention, development of idea, movement and so on.

*Make Your Own Picture Story.* What points need to be visualized? Is it possible to build up suspense? See: *Producing Your Own Sequence Pictures* page 35. The picture story which you make yourself can be much more convincing than commercially produced material. You need a creative imagination and a variety of visuals.

*Finding Pictures and Making Symbols.* If you have started making a collection of pictures from illustrated catalogues, magazines and wallcharts you will find a ready source of suitable material. An alternative is to make your own simple outlines and symbols. See: *Copying and Enlarging Pictures* page 50.

#### MOUNTING

(a) *Flannelgraph.* Some materials adhere to the flannelboard better than others but your choice will depend mainly on what is available locally and whether you need the pictures for repeated use. For durable results glue the whole picture to flannel or other rough cloth and, when dry, cut round the outline with scissors. It may be quicker and cheaper to use small strips of cloth or sandpaper, but the edges of the pictures will bend and tear more easily. Where the cut-outs are subject to rough handling it may be better to have them on card. Your choice of materials will depend on their availability and the durability needed.

Some people do not mount their pictures at all, but lightly roughen the backs with sandpaper. Stiff blotting paper and duplicating paper may be treated in this way, but they are less successful in situations where there is likely to be wind.

- (b) *Magnetic Board.* Small magnets are glued direct or taped to each picture. The magnet adheres to the metal board and holds the picture in place.

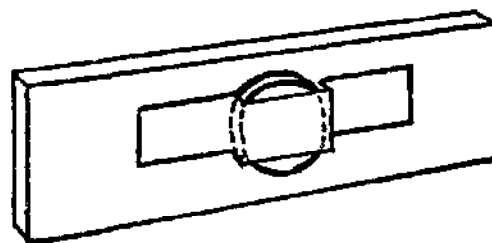

*Storage.* Flannelgraph pictures must be kept flat and the edges must not get bent or curled. Take care to store the pictures in large envelopes, stiff paper folders or plastic bags.

#### BACKGROUNDS

*Flannelgraph.* A plain, dark-coloured background has many advantages. It does not show the dirt and provides excellent contrast with light-coloured pictures.

Some stories are helped by having backgrounds which suggest indoor or outdoor scenes. Avoid elaborate highly-coloured backgrounds because these compete with the story pictures for the attention of the audience.

You can draw your own scenery backgrounds with wax crayons, but remember that too much detail may be a hindrance, so keep it as simple as possible.

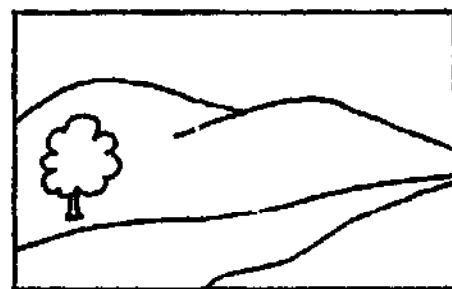

*Magnetic Board.* A thin cloth or paper on which you have a map outline or other special layout may be used over the magnetic board. The material has to be thin enough to allow magnetic attraction through the fabric.

Home-made backgrounds are easy to make using an episcopo or slide projector. See: *Copying and Enlarging Pictures* page 50.

#### USING FLANNELGRAPH

- (a) Practise several times beforehand. Decide just when a picture should be placed on the board to illustrate your point. Plan where each cut-out is to go to avoid confusion with others which have to be added later. Put on the pictures and tell the story to yourself. Stand back and look at the general arrangement from the point of view of the audience. It is easy to get pictures crooked when standing close to the board.
- (b) Be careful about perspective. Larger pictures should be nearer the bottom of the board and the smaller ones further up in order to give the impression of being further away. This may be less important for some rural audiences.

- (c) Make sure the board is not cluttered with too many pictures. Do not try to do too much in one talk. Every extra piece of material to be handled adds to the teacher's pre-occupation while teaching. Keep it simple.
- (d) Make sure the board is secure and can be seen by all.
- (e) Have your pictures (and different backgrounds) ready on a nearby table before you start. Some people keep pictures between different pages of a magazine or book and others prefer to have them piled up in the order required.
- (f) When telling the story, do not stop your narrative to put up the pictures. At the moment a character is mentioned in the story, move the picture on the board to fit in with the words.
- (g) Cut out all unnecessary descriptive talk. Do not describe anything people can see for themselves.
- (h) Refer to things people cannot see, e.g. the character of a person, conversations, thoughts and the significance of actions.
- (i) Avoid using the verb *to be*. Do not say 'Here is', 'Here are', 'This is', 'That is' and so on. Keep the story moving with *action* verbs. 'As the shepherd takes the sheep home in the evening, one of the flock sees some good pasture and turns aside.'
- (j) Movement and change are important when using flannelgraph.
- (k) Always draw attention to the pictures and not to yourself. Stand on one side and let the audience see the pictures.
- (l) Do not tell the story with flannelgraph and then moralize with words afterwards. The message should be given as far as possible as the story is being told with the pictures. Put the main thoughts of your lesson into the mouth of a flannelgraph character. This can be emphasized and repeated as the subject is taken up by other characters.

#### IDEAS FOR TEACHERS AND LEADERS

##### *Introducing Flannelgraph*

Flannelgraph may be a mystery to some people and they cannot give their attention to the subject matter until their curiosity has been satisfied as to how it works. When using this medium for the first time let people examine it for themselves before you start.

With some rural audiences it is a good plan first to give an actual demonstration with the real articles (food, utensils, tools, etc.). Next, show the flannelgraph picture alongside the real object and, finally, use the flannelgraph picture on its own.

##### *Language*

School teachers use flannelgraph with all ages. With very young children,

tell stories with picture cut-outs. To teach reading with older children, use complete words or arrange word-building by syllables. With language work you can put a picture on the board and ask one of the children to tell a story about it. By asking a few questions you can usually get the first child started. When the child finishes his story, he chooses another picture, puts it on the board and then calls on another child for a story.

Another method is for the teacher to tell a story first without flannelgraph and later get the children to retell the story with the aid of the flannelgraph pictures. This method is suitable when using simple outlines but would be confusing with very detailed pictures because children would already have pictured the story in their imaginations.

When telling stories from other countries you can sometimes use local pictures afterwards in order to help the class see the full significance.

Make a flannelgraph crossword puzzle. Prepare a stock of letters written on blotting paper and keep them near the flannelboard on which the crossword outline has been drawn. When you read out clues, members of the class come forward and build up the words on the outline. If you cannot buy a book of prepared crossword puzzles, no doubt you could make your own.

### *Arithmetic*

To teach addition and subtraction, use pictures of familiar objects, large-sized numbers cut from calendars and arithmetical symbols. Children pick numbers from the pile in order to fill in the answers.

At a later stage, you can use cut-outs to teach fractions, segments and geometric forms. Children can participate by arranging the pictures to fit.

### *Geography*

For geography teaching, diagrams or maps can be built up in stages. Start with a blank map of the world or a continent and gradually fill in the countries.

On an outline map of one country add symbols for crops, minerals, industries and names of places.

### *Participation*

When working with children it is often a good plan to get them to help *make* the flannelgraph pictures.

The flannelgraph outline of a talk is a method you can use with a wide variety of subjects and audiences. Have one heading for your theme and then add pictures or sub-headings below as you develop your talk.

Audience participation leads to better learning and it is a method suitable for young people and adults.

Show six or seven pictures on the board and ask the group to spot the odd one out.

Put up a layout or a scene and ask the group to spot the mistake.

This leads to the careful study of the pictures, more discrimination and a useful discussion.

Distribute to the group slips of blotting paper with such captions as 'Water boils at 100° C', 'My parents care for me', 'Man cannot exist without oxygen', 'The sun will rise tomorrow morning' and so on. Place on the board the headings 'Fact' and 'Faith' and invite members of the group to bring forward their slips of paper and put them under one of the two headings. Comments, explanations and discussion can follow each one. Finally, two or three blank slips of paper can be given out so that extra items can be written and put on the board.

Using the same technique, put three headings on the board, 'Essential', 'Helpful' and 'Unnecessary'. Desirable and undesirable aspects of the subject in hand are written on the slips of paper. Suitable subjects are: The elements of worship, the characteristics of Christian service, the qualities of a good teacher/good mother/good farmer, etc., etc. After each person places his slip on the board you ask him why he has chosen to put it under that particular heading. Then ask if the rest of the group agrees that this is the best place for it and, if not, why not. If a move to another heading is suggested, you again ask, 'Why?' In fact, your main work is to stimulate discussion with *Why* and *How* questions. You should not dominate with your own ideas, but should guide the group to appropriate corporate decisions.

With this type of presentation, individuals in the group have to think about the subject before they place their slip on the board. Group thinking follows, the subject is related to the experience of those present, misunderstandings are cleared up and the whole question discussed until finally there is general agreement on the subject. It may take a considerable time to deal with only a few slips, but the result will be that the members of the group will have made the subject their own. They will not just have listened to someone else's thinking on the subject, but will have done the thinking themselves. This leads to conviction and action much more effectively than the ordinary *I-am-telling-you* sort of teaching.

The same technique can be used with a wide variety of subjects and with other headings, such as: 'Right', 'Wrong', 'Don't Know'; 'Encourage', 'Tolerate', 'Forbid', etc.

Complicated posters and charts can be cut up to make simple and effective flannelgraphs, using the pictures and the words of the poster.

The application of flannelgraph in learning is limited only by your imagination, but do not overdo it. Do not become a flannelgraph fanatic, using this medium on every occasion. Use flannelgraph when it is the *most* suitable for your teaching purpose.



### THE POCKET BOARD

This variation is a board covered with cloth, paper, light cardboard or stiff clear plastic, which is folded to form a series of pockets shallow enough to show the tops of the pictures or cards, yet deep enough to hold them firmly. The folds may be fixed in place by staples, tacks or by sewing. The individual cards should be fairly stiff and heavy, in order to last under constant handling.

In use, the pocket board can be hung on a wall, placed on a stand or simply propped against a pile of books on a desk. Since the pieces are firmly held in place, a solid support is not as necessary as with other flannelgraph aids.

Its versatility is shown by the teacher's ability to construct, add, subtract and change the individual units in making word and number combinations. It is excellent for class participation and for individual and group learning.

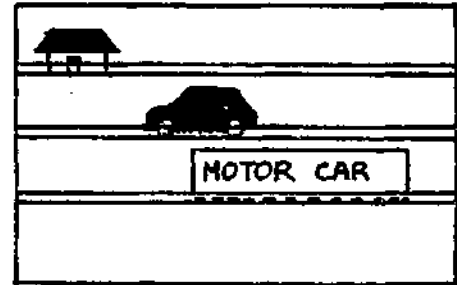

### PROJECTS FOR PRACTICE

1. If you haven't a flannelboard or magnetic board, make one, using local materials.
2. Discover some commercially produced flannelgraph and study it carefully to see if it has been designed to use the advantages of the medium.
3. With three or four other teachers, each make a flannelgraph picture set for different subjects. Having used them with various groups share and evaluate your experiences.
4. Use one or two of the *Ideas for Teachers and Leaders* and then rewrite the description of the method on the basis of your experience.

## Chapter 11

### DEMONSTRATIONS

When you teach by demonstration, you show a person how to do something or you show the value of an idea.

#### ADVANTAGES

A demonstration is so obvious; it is there before your eyes. It can be applied to local needs and problems. Example is better than precept. Showing how is better than telling how.

#### TYPES

*The Method Demonstration.* This is one of the oldest forms of teaching, used by parents with children to teach the skills of hunting, cultivating, building, cooking and so on. You show how to do a job step-by-step, e.g. baking bread, building a latrine, teaching a class, etc.

*The Result Demonstration.* This shows, after a period of time, the value of an improved practice, e.g. the use of fertilizer, the use of various teaching methods, anti-malarial measures, etc. The Result Demonstration helps to convince people about a new idea and *comparison* is the essential ingredient.

#### METHOD DEMONSTRATION—STEPS TO FOLLOW

- (a) Make sure that the demonstration will meet an immediate local need.
- (b) Decide exactly what you want to accomplish.
- (c) Gather all the information you can about the subject matter.
- (d) Talk over the subject with a few leaders. Apart from getting their cooperation, this enables you to discover their previous experience of the subject and to use this opportunity for extra teaching.
- (e) Gather all the necessary materials.
- (f) Plan your demonstration step-by-step, including the introduction and summary.
- (g) Rehearse.
- (h) When people have gathered to watch the demonstration, explain what you are going to do and why it is important for them to learn the new method.
- (i) Go through the demonstration and explain it step-by-step. Pause to answer questions from the audience and be ready to repeat any difficult steps.

- (j) Encourage members of the audience to try for themselves and help them to correct their mistakes.
- (k) Summarize. Avoid exhortation. There is no need to tell people to take up the new practice. Your demonstration should have done this more effectively than any further words from you!
- (l) Do all you can to help people adopt the new practice. Give out leaflets and written instructions. Show them where they can get supplies. Indicate how they can get further advice and help.

A Method Demonstration paves the way for a Result Demonstration.

#### RESULT DEMONSTRATION

A Result Demonstration compares an improved and an old practice so that people may see and judge the results themselves.

Use the same approach as with the Method Demonstration—preparing, planning, obtaining the co-operation of local leaders and answering questions and explaining where necessary.

In most cases the Result Demonstration makes the point without human persuasion.

#### SUBJECTS WHICH MAY BE DEMONSTRATED

- How to conduct a discussion group.
- How to lead a service of worship.
- How to make a smokeless stove.

#### PROJECTS FOR PRACTICE

1. Make a list of possible demonstrations that you could arrange in connection with your work.
2. Arrange a Method Demonstration with one of the drawing and enlarging skills outlined earlier. See: *Drawing Materials and Basic Skills* page 42.
3. Organize a Result Demonstration to show the difference between teaching a subject:
  - (a) with words only and teaching with visual materials.
  - (b) by an authoritarian, didactic, I'm-telling-you method and by a democratic, discovery, experiential approach.
4. Evaluate your experiences.

## Chapter 12

### TOURS AND VISITS

Tours and visits appeal to the desire to *go and see*.

#### ADVANTAGES

Being on the spot, seeing the places and the activities and meeting the people involved provides a living experience through which a great deal can be learned. This is the real thing, not something second-hand re-created in the classroom! Class theory is linked with practice in life. In spite of the expense in time and money, this may be one of the most economical and efficient teaching methods.

#### ARRANGEMENTS

*Before.* Decide what you want to accomplish. Do you want to help people recognize a problem? to create interest? to generate discussion? to provoke action?

Make a preliminary visit to establish contacts and to get an idea of how the tour should be conducted.

Involve your group in some of the preparations, e.g. travel, food arrangements, check-lists, etc. This helps to create interest.

Prepare a detailed timed programme.

Provide background information with photographs, slides, sand table. See: *Subjects for Sand Tables* page 91, or chalkboard. Do not tell people what they will learn. At this stage, provide only factual information to help them understand the overall situation. With your group, list the items to be discovered and the questions to be answered.

If you have a very big group your practical difficulties multiply. It is better to arrange two visits than to have too many people at once.

*During.* Follow a planned route to enable your group to see the most important aspects of the subject. Arrange for them to meet the people involved in the work.

Through the use of a questionnaire or check-list prepared beforehand, help your group to look, see and understand. Ask them factual questions. Help them discover things for themselves. Do not try to persuade or influence them. Encourage the taking of notes and the use of cameras or tape recorders.

Your tour may also include a demonstration. See: *Demonstrations* page 82.

*After.* Let your group have time to absorb the experience of the tour. If they have questions, answer them, but do not go on to lengthy explanations and *your own* conclusions. Get the group to give a factual report of things seen and heard and collate this on the chalkboard. Having recalled the facts, ask the group to offer their comments and conclusions. Encourage them to search for the general principles behind the facts observed.

Perhaps another session round the sand table would be useful.

Arrange to *do* something else. What about making a model or a chart to illustrate what has been learned? What more needs to be studied? What more needs to be done?

#### IDEAS FOR TOURS AND VISITS

In most parts of the world you can organize simple tours and visits for a wide variety of subjects, e.g. history, geography, social studies, agriculture, religious education, etc. Let these ideas start you thinking about local possibilities:

Nature walk in the countryside	Irrigation project
Historical monument	Power station
Synagogue, temple or shrine	Museum
Sewage disposal works	Factory
Council meeting	Farm
Housing project	

#### PROJECTS FOR PRACTICE

1. Ask colleagues about their experiences of educational visits—those which they went on at school and those which they have organized since. List the places, purposes and their comments on the value of these visits.
2. Plan and carry through a short visit. Work out a check-list to discover what your group gains from it. (The value of any learning experience is to be judged not only by the number of facts memorized. It is important to find out if people have understood the underlying nature of the problem, the fundamental principles involved in the process, and so on.)  
How has their understanding of the subject developed?  
How have their attitudes changed?

## Chapter 13

### OBJECTS AND SPECIMENS

#### DEFINITIONS

*Objects.* The real things, e.g. seeds, tools, instruments, types of food, household articles, ornaments and other art work, small animals, rocks, stones, etc.

*Specimens.* The real things, treated to preserve them, e.g. plants, flowers, insects, etc.

#### ADVANTAGES

*Objects.* There is great educational value in showing the real thing. If you cannot go *out* and see the object in use on the spot, bring it *in* to the class and study it there.

In most cases it will be easy for all to recognize. An object may appeal to several senses—you can see, touch, smell and perhaps even taste it! Everyone can get an accurate impression of the object and can appreciate its detail and finer points.

Even familiar objects taken from everyday life attract attention and hold interest. Less familiar objects are often even better.

*Specimens.* In addition, specimens of plants and flowers may be preserved for use at any time when they might normally be unavailable.

#### COLLECTING AND PREPARING TO USE

Find, or ask the group to collect and bring, particular objects. Preserve specimens in glass jars, mounted on cards or in boxes. Label everything with its name and add brief notes concerning important details.

#### USING OBJECTS AND SPECIMENS

When you are giving an explanation or answering general questions make sure all can see at one time.

Pass the object round if you want to encourage closer inspection, comments, response by way of discussion, questions, etc. Do not continue talking as the object is being inspected in this way because only a few people will be able to see the object and hear your explanations at the same time.

In your teaching, link the three-dimensional solid object with a two-

dimensional flannelgraph cut-out or a close-up picture of it. When you use the picture later the group will be able to recall the real object.

Help your group to see the object in context by showing a picture of it in use in its natural surroundings.

#### **OBJECT LESSONS**

Certain objects may be used to teach spiritual truths. You study the physical qualities of the object and then draw spiritual parallels like an allegory or parable.

This was a method often used by Jesus. As He taught a group of people by the wayside He would take His illustrations from things He and His audience could see at that moment. On one occasion He glanced up and noticed the birds of the air and the beautiful flowers of the field. These provided Him with an object lesson which people would never forget. On numerous occasions Jesus either took a visible object (a coin); indicated something which could be seen nearby (birds and flowers) or spoke of familiar things which His hearers could easily see in their imaginations (salt, eye of a needle).

Following His example, we too can use objects and illustrations drawn from the everyday life of the people.

E.g. (1) A lighted candle. Through the ages many Christians have suffered persecution and have become martyrs. The flame that destroys the candle produces light that blesses the world.

(2) There are several points which may be brought out with an ordinary lead pencil:

- (a) It must make a mark.
- (b) The mark is made by the inside.
- (c) The inside must be sharpened.

#### **PREPARING OBJECT LESSONS**

The object must be big enough to be seen.

The parallels that you draw must be genuine and not strained.

Do not overdo it. Two or three good points are better than six or seven exaggerated ones.

Avoid using mechanical gadgets which attract attention to themselves rather than clarify the truth being presented.

#### **USING OBJECT LESSONS**

Let everyone see clearly.

Draw out the significant points. Keep the object in view as you talk and refer to it for each point made.

The link with your message must be perfectly clear. When people remember

the object you have used they must also be able to bring to mind immediately the main message.

In addition, some people use a chalkboard or flannelgraph to emphasize in words the main points of the talk.

#### PROJECTS FOR PRACTICE

1. Ask friends what object lessons they have seen used. (You may discover that some older people can remember object lessons that they saw in their youth!)
2. Study the Bible and make a list of the object lessons used there.
3. Select an everyday object and work out a message.



## Chapter 14

### MODELS

#### DEFINITION

A model is a copy of an actual object, usually on a smaller scale. Like the actual object, a model has breadth, length and depth and can be looked at from all sides. The term *model* does not always mean a true-to-scale miniature, but the more accurate models are the better teaching aids.

#### ADVANTAGES

Models hold a great fascination for young and old alike. If they are of familiar things people can recognize them easily. Even less familiar subjects can be easily and readily understood because they are three-dimensional. There is, of course, the additional appeal to the sense of touch. Models can draw attention to essentials and omit unnecessary details. A model of an object, building or farm layout can inspire people to work on the real thing as they see a picture of the final result.

#### DISADVANTAGES

Many models are fragile, especially when made with mud, and some cannot be carried from place to place. Storage is sometimes a problem. In most cases they can be used only with small groups. There is some danger that people will get a wrong idea of the size of the actual thing if they are shown only small models.

If these limitations are recognized, models can still be put to very good use in much of our teaching.

#### PREPARATION

There are two main ways of preparing models for use in teaching and learning. Both ways are good, but they serve different purposes.

- (a) You, as teacher, may make the model and then present the finished article to the class or group.
- (b) The class may make the model with you. First, tell the story or outline the subject with related pictures. Together, discuss the possibilities and list the things needed. The amount of detail included will depend on the age of the group. Remember that a child's imagination will clothe a simple model with reality if you tell how it is used. Do not impose your own ready-made answers, but give full scope to the ideas and initiative of the group. Many

subjects in the school curriculum may be correlated in a model-making project. Those actually assisting in the planning and construction will not easily forget the lessons associated with the models.

#### SINGLE MODELS

Make recommended designs for houses, latrines, storage bins and other items to be used locally.

Learn about other countries by making models of houses, buildings, utensils, vehicles, etc.

*Materials.* Wood, cardboard, matchboxes, expanded polystyrene, tin, bamboo, papier mâché from flour paste mixed with absorbent paper, clay, mud, plasticine, banana bark, corn stalks, etc. Do not worry if you cannot get a particular item. Make use of available materials.

*Tools.* Scissors, penknife, razor blade, ruler and a few household utensils.

#### A DIORAMA OR A SCENE-IN-A-BOX

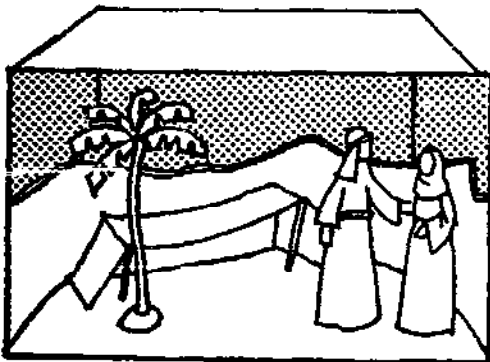

Arrange small cut-out pictures and models in a box which has one side open through which the scene is viewed. A curved background with pictures of distant hills, trees, and houses helps to give a realistic effect.

#### A COMPOSITE SCENE

This gives a visual understanding of large-scale ideas although it cannot be seen as a whole by a group at one time.

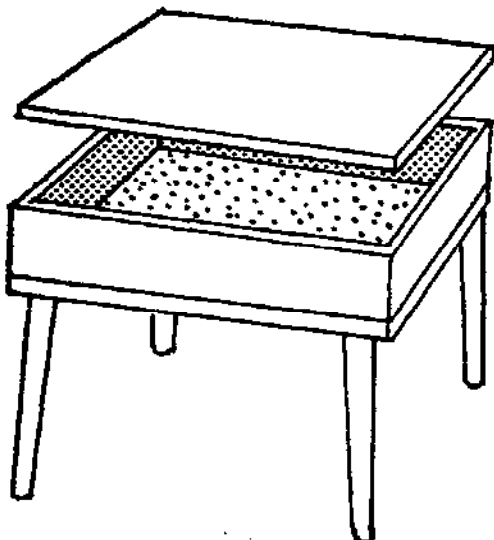

*Large-Scale Relief Map.* This may be marked out on the ground to show your own area or another country. If possible, use a large scale such as five miles to one foot or 25 kms to one metre.

*Sand Table.* This is most suitable for small relief maps and models.

To the sides of a wooden table nail a surround 15 cms high. Half fill the tray with clean sand. By adding a cover over the top, the table may be used for other purposes as well.

Where you have the space available outdoors it may be better to arrange a small area of ground with a low brick or stone surround. In addition to the materials mentioned above, blue paper will serve for rivers, white sand for roads and paths, and blocks of wood, pebbles, twigs, etc., can be used for scenery. People and animals may be modelled in clay or cut-outs made from cardboard.

#### **SUBJECTS FOR SAND TABLES**

For geography—your own or another country, showing boundaries, rivers, lakes, main towns, etc.

For religious education—a map of Palestine illustrating various journeys and stories.

For community development—a village layout showing the location of various projects such as the school, the community centre, etc.

For agricultural work—a farm layout illustrating crop rotation, irrigation, erosion, contour ploughing, etc.

In preparation for a tour or visit—a bird's eye view of the ground to be covered.

There is no point in adding long lists and detailed descriptions of models for different subjects. For this type of work so much depends on your imagination and ingenuity with local materials. No doubt the ideas offered above will be enough to start you off!

#### **USING MODELS**

Most models, including the individual items on a large-scale relief map, are relatively small, so make sure that everyone can see clearly.

Because of the difference in scale, help people to relate the models to the real-life objects they represent.

See: *Using Objects and Specimens* page 86.

#### **PROJECTS FOR PRACTICE**

1. Search the nearest library, school cupboards or colleagues' bookshelves to see if you can find a book or pamphlet giving ideas for model-making.
2. Try out one or two of the suggestions given above.

## Chapter 15

### DRAMA

Drama is not just another entertainment or novelty, but can be a very enriching educational experience for those involved, both for performers and for the audience. This section is not intended to be a complete guide to the subject, but a book on visual communication cannot ignore drama.

#### THE VARIETY OF DRAMA TRADITION

Many who read English may have studied Western drama in school. This has often meant the learning of a carefully prepared script, following it in detail and performing the play on a stage. There are other drama traditions and this is true all over the world, including European countries. In many countries, drama of various kinds has, for many centuries, been closely related to religious and spiritual themes. In Africa and Asia this has included burlesque and clowning, but this has not been thought incongruous or out of place. In some cultures, the emphasis has been on symbolism rather than naturalism. In others, the words of the dialogue have been less important than the portrayal of character by pantomime, gesture and costume. In warm climates, the open-air setting has had an influence and drama has not been limited by the disciplines of an indoor stage. Drama takes many forms and all have their place and make their contribution. Teachers going from one culture to another and educated people working amongst illiterates need to explore all local traditions before assuming that *their* way is best!

The variety of drama traditions has led to many styles and types: mime, dance drama, tableau, charade, play, pageant, liturgical drama, shadow play, epic, role play and so on.

These may be classified in many ways, but it may be helpful to identify:

- (a) Formal drama, with written script, rehearsals, etc.
- (b) Impromptu dramatization, where the situation and story are suggested and people make up actions and use their own words.

Some may be performed for an audience and others are produced with only the needs of the participants in mind.

#### COMMUNICATION AND DRAMA

Through drama, ideas are communicated to participants and to spectators.

In educational situations, drama can help young and old in their use of language.

Drama is very valuable in subjects where personal and social relationships are often more important than details of appearance. E.g. In history, civics, literature and religion you can act the parts of the people and understand the subject *from the inside*.

Abstract ideas (e.g. health, democracy, freedom, forgiveness, reconciliation, etc.) can be communicated through drama to people of different ages, education and experience.

Drama is a very suitable teaching method for people who cannot read because they often experience things dramatically. In everyday life where people rely on the spoken rather than the written word, there is often a natural eloquence leading to considerable dramatic ability.

#### DRAMA INVOLVES YOU DEEPLY

Drama is an active method of learning with a high degree of participation. Whether taking part or watching, you enter into the experience of the characters and become emotionally involved with the message. Drama can communicate meaning beyond that which the human intellect can grasp. It communicates through feelings and emotions to the deepest places in a person's life.

#### LEARNING THROUGH ROLE PLAY

A role play is the unrehearsed acting out of real-life situations. In most cases, an individual will take the part of some other character.

The method provides valuable experience in understanding other people's jobs and problems. It is very useful for training workers who need to have an appreciation of human behaviour, leadership, etc, e.g. clergymen, teachers, community development, health, agricultural and youth workers.

A role play seeks to anticipate a situation in which you may be involved or in which people may be involved whose actions and feelings you wish to understand, e.g. an interview for a job; a parent/child quarrel; an employee/employer problem; a family bereavement. By playing the roles you live through the event before it happens. It is like learning from real life, but you do not have to suffer for your mistakes! You learn about yourself and about how it feels to be someone else. Everyone learns by doing and the group learns together by being involved.

The role play method is good for exploring and clarifying problems and also for testing possible solutions.

When starting, it is important to have a relaxed atmosphere and it is useful to have *everyone* involved. This means that there is no audience. No one need feel shy. Make sure that everyone understands the purpose of the role play and

give very clear instructions so that all see clearly what they have to do. All must be reminded that they are playing roles and that the assessment afterwards will be of the roles and not of the people playing them.

The discussion which follows starts by considering the roles played, the things said and the attitudes portrayed. Make certain that the main issues are drawn out and made clear to all. Even if no reference is made to the personal experience of people in the group, individuals have an opportunity to discover relevant truths and respond inwardly. The evaluation of the experience is as valuable as the role play itself and you need to allow plenty of time for discussion.

Outline of the method: Choose the subject and cast; set the scene; the play itself; discover what it means.

#### PROJECTS FOR PRACTICE

1. Inquire from colleagues about their experience of drama, role play, etc.
2. Consider the implications for religious education/youth work/community development/health education, etc. What aspects of the subject can best be tackled through drama?
3. As a method of studying a subject (scripture passage, local problem, historical event, etc.) prepare and act a short play.
4. Organize a role play on a local problem and use it as a discussion starter.

## Chapter 16

### PUPPETS

#### ADVANTAGES

As with drama, the audience makes an immediate and imaginative response to puppets. They identify with them and get emotionally involved with the characters and the story. Some users claim that puppets are one of the best means of instruction and others favour them because people can be stirred to action.

It is interesting that puppets are usually not resented even when dealing with local contentious and sensitive subjects.

From a practical point of view, puppets are easier to organize than real-life actors. Fewer people are involved, the manipulation of the puppets is an easily acquired art, parts may be read (by local people if necessary), there is a minimum of rehearsal, unusual characters (animals, etc.) can be presented easily and there are few production problems.

Puppets and suitable stories for them can be devised for all ages and for a wide variety of subjects. They can be used for religious themes, but this sometimes needs very careful handling. Puppets are particularly effective for caricatures and exaggerated presentations.

#### DISADVANTAGES

Because they are small, puppets cannot be seen so easily as live actors. You need to control the size of your audience and arrange their seating very carefully.

#### TYPES

##### *Marionette or String Puppet*

This puppet has a jointed body and limbs. It can be made of wood, wire, paper, string, cloth stuffed with paper, rag or sawdust. It is suspended by strings which are attached to different places on the body and limbs, and to a control in the puppeteer's hands. Movement of the puppet is produced by moving the

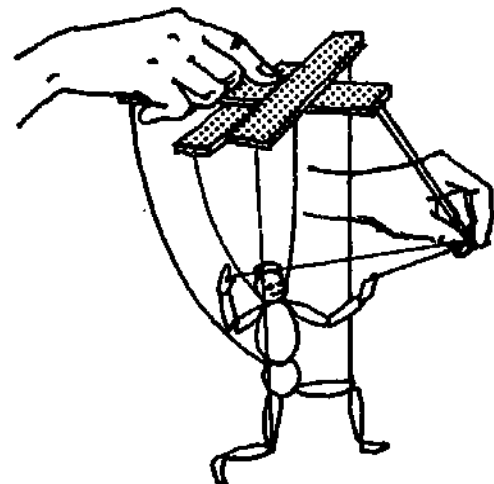
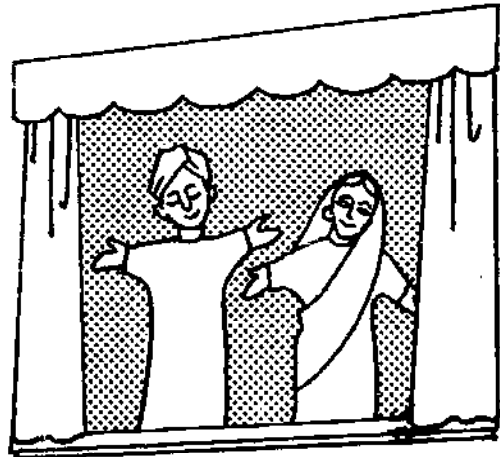

control and by pulling or loosening the strings. This requires considerable practice.

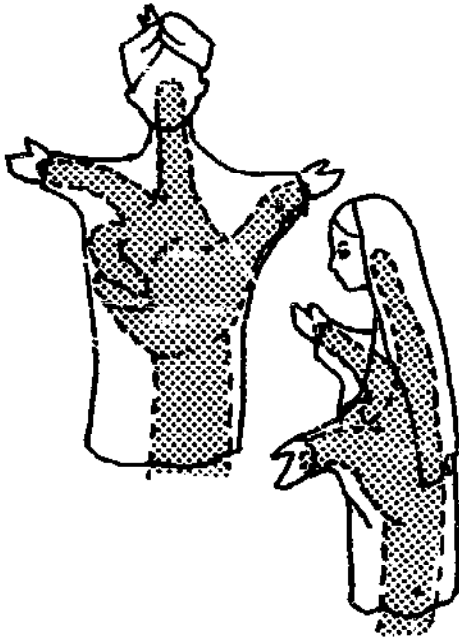

#### *Glove or Hand Puppet*

This is the simplest and the one you are likely to find most useful. It is like a three-fingered glove which fits on the hand. The first finger is inserted inside the head. The middle finger and thumb fit in the hands. The dress covers the hand and forearm. This type of puppet has no legs and its movements differ from marionettes. Because the puppet is on a human hand there is a direct *life* quality and through different movements and actions, the puppet character can express itself. One person can operate two puppets at one time, one on either hand.

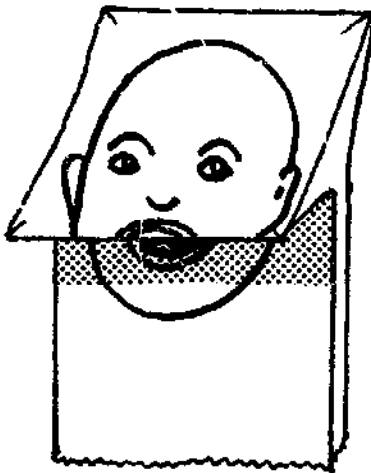

#### *Paper Bag Puppets*

(a) Take a paper bag measuring about 12 cm × 24 cm with a flat bottom and a gusset or pleat on each side. When folded flat, the bottom of the bag will lie against one side of the bag. Draw the top half of a face on the bottom of the bag and a lower lip and chin on the side of the bag. Add a 'cap' made of thin card and wool for a beard and you will have an attractive puppet. These extra materials contribute to the feeling of *character*.

Another way of making the face is to cut out a suitable close-up photograph from the front of a magazine. Cut the picture in two and glue the top half of the face to the bottom of the bag and the lower half to the side of the bag.

Paper bag puppets are simple and quick to make, but limited in movement and action. To convey ideas, this type of puppet relies on its overall visual impression and on speech.

By inserting your hand in the bag, you can grip with your fingers the fold between the bottom and the side of the bag. By opening and closing your grip you will move the puppet's mouth and indicate that it is speaking!

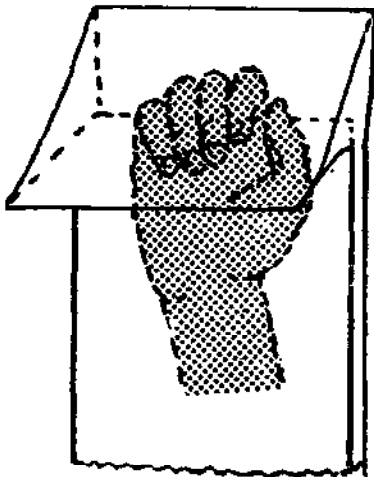



(b) A paper bag without a large gusset may also be used. Draw a line across one side of it about a third of its length from the top. Draw a face between this line and the top. Glue some wool or yarn on the top as hair. Gather the bag at the neck and tie a ribbon round it.

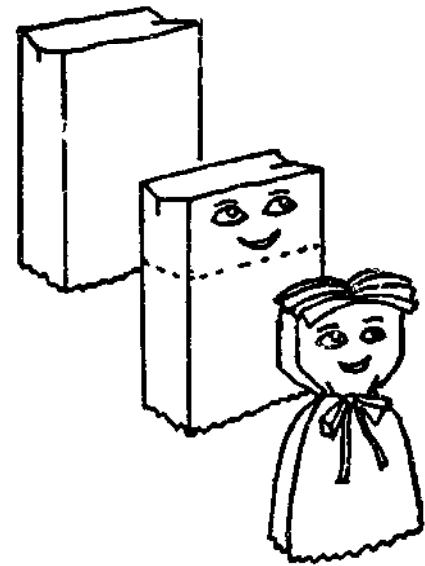

#### MAKING PUPPETS AND STAGE

Apart from the simple paper bag puppet, the glove puppet is the easiest to make and use. Materials for the puppets, costumes and stage can usually be found in the poorest of villages. You can make puppet heads from crumpled paper covered with old cloth, papier mâché, paste and paper strips or plaster and muslin strips over a plasticine or mud foundation mould. Give the puppet a prominent nose, chin and forehead. Much of the character comes from the colour and texture of the hair, which may be made from frayed rope or similar material. Use glass beads for eyes, paint for eyebrows and lips, old cloth from a junk box for the dress and you will soon have a serviceable puppet.

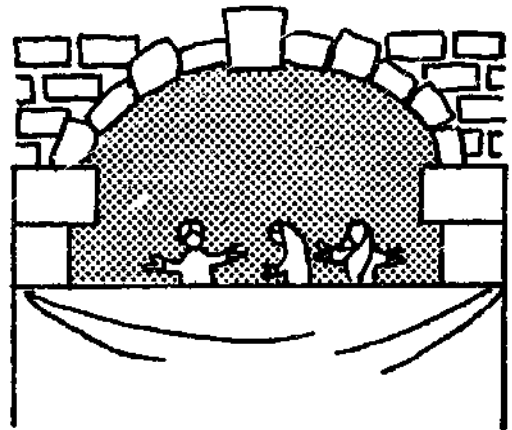

For a stage, you can use all sorts of makeshift arrangements. Hang a blanket, sheet or sari across a convenient doorway or between two pillars.

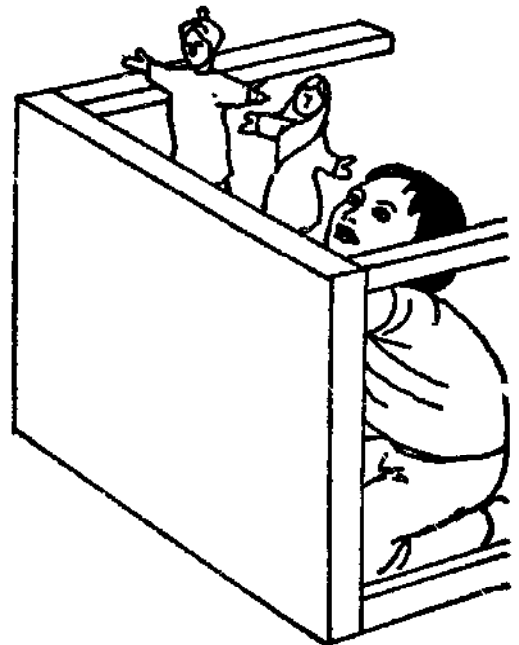

A table placed on its side provides the necessary screen.

A bed or two chairs draped with blankets or sheets may be used in a similar way.

Of course, you can make a permanent stage with a wooden frame and surround. A great deal depends on your purpose and your resources.

Good lighting for your puppet stage is essential, but make sure that the light is directed towards the puppets and not into the eyes of the audience.

#### WRITING A PUPPET PLAY

You may get ideas from plays written by other people, but you will usually need to adapt them a great deal or write your own if they are to be appropriate for your situation.

Decide on the lesson you want to teach. Do not try to include too much. Give the audience *one* idea to take away with them.

Illustrate the lesson by a story.

The story must have dramatic value. Tackle some sort of problem. Include suspense. The lesson must become clear as a direct result of dramatic incident.

Choose characters that are distinctive, with strong characteristics.

Bring in everyday people and familiar situations.

Usually, there are no more than two puppeteers, so only four characters can be on stage at one time.

Have short speeches and no silent pauses.

Action is more important than narrative. The extent of the action will depend on the skill of the puppeteers.

Include wit and humour whenever possible.

Introduce music, songs and dancing.

Every word, gesture and action in the play must contribute something to the whole production.

Remember—the audience wants to be entertained. Do not preach at them!

#### USING PUPPETS

To make a puppet come to life, practise. Work a puppet on each hand. See how much you can make each express by its gestures. Identify yourself with the puppet, changing your voice as far as possible, so that your right-hand puppet speaks in a voice that is different from your left-hand puppet.

Use exaggerated movements and gestures. Make your puppet push, pull, throw and *do* things. If the puppet fits your hand comfortably you will be able to manage a wide range of gesture and movement.

Direct your voice over the screen towards the audience.

#### CONVERSATIONS WITH PUPPETS

During a play, a puppet can turn and talk to a member of the audience. Apart from strengthening the link between audience and puppets, this is a useful way of finding out if people are following the story and getting the message. A puppet may have a conversation with the leader or presenter of the programme who sits on the front row with the audience.

Using one puppet on your hand, you can have a straight conversation or interview without the aid of other characters, a stage or other properties. By identifying with the audience's problems, the puppet can ask their questions