



WIKIPEDIA
The Free Encyclopedia

[Main page](#)
[Contents](#)
[Featured content](#)
[Current events](#)
[Random article](#)

Interaction

[About Wikipedia](#)
[Community portal](#)
[Recent changes](#)
[Contact Wikipedia](#)
[Donate to Wikipedia](#)
[Help](#)

Toolbox

Print/export

Languages

[Česky](#)
[Dansk](#)
[Deutsch](#)
[Español](#)
[Français](#)
[Galego](#)
[Hrvatski](#)
[Italiano](#)
[עברית](#)
[Magyar](#)
[Nederlands](#)
[日本語](#)
[Polski](#)
[Português](#)
[Русский](#)
[Simple English](#)
[Српски / Srpski](#)
[Suomi](#)
[Svenska](#)
[中文](#)

Article [Discussion](#)

Read [Edit](#)

Tesla coil

From Wikipedia, the free encyclopedia

A **Tesla coil** is a type of [resonant transformer](#) circuit invented by [Nikola Tesla](#) around 1891.^[1] It is used to produce high [voltage](#), relatively high [current](#), high [frequency alternating current](#) electricity. Tesla experimented with a number of different configurations and they consist of two, or sometimes three, coupled [resonant electric circuits](#). Tesla used these coils to conduct innovative experiments in electrical [lighting](#), [phosphorescence](#), [x-ray](#) generation, [high frequency alternating current](#) phenomena, [electrotherapy](#), and the [transmission of electrical energy without wires](#).

The early Tesla coil transformer design employs a medium- to high-voltage power source, one or more [high voltage capacitor\(s\)](#), and a [spark gap](#) to excite a multiple-layer [primary](#) inductor with periodic bursts of high frequency current. The multiple-layer Tesla coil transformer secondary is excited by [resonant inductive coupling](#), the primary and secondary circuits both being *tuned* so they [resonate](#) at the same frequency (typically, between 25 [kHz](#) and 2 [MHz](#)). The later and higher-power coil design has a single-layer primary and secondary. These Tesla coils are often used by hobbyists and at venues such as science museums to produce long [sparks](#).

Tesla coil circuits were used commercially in [sparkgap radio transmitters](#) for [wireless telegraphy](#) until the 1920s^{[1][2][3]}, and in [electrotherapy](#) and medical devices such as [violet ray](#) (although Tesla circuits were not the first or the only ones used in spark transmitters). Today their main use is entertainment and educational displays. Tesla coils are built by many high-voltage enthusiasts, research institutions, science museums and independent experimenters. Although electronic circuit controllers have been developed, Tesla's original spark gap design is less expensive and has proven extremely reliable.

Tesla coil



Tesla coil at [Questacon](#) - the National Science and Technology centre in [Canberra, Australia](#).

Uses Application in [fluorescent lighting](#), [electrotherapy](#), [wireless power](#) for [electric power transmission](#), novelty [lighting](#), as well as [music](#).

Inventor [Nikola Tesla](#)

Related items [electrical transformer](#), [electromagnetic field](#).

Contents [hide]

- 1 History
 - 1.1 Tesla's coil
 - 1.2 Disruptive "Tesla" coils
 - 1.3 Later Tesla coil design
- 2 Tesla Coil Theory
- 3 Modern day Tesla coils
- 4 Utilization and production
 - 4.1 Electrical transmission
 - 4.2 Tuning precautions
 - 4.3 Air discharges
 - 4.4 Electrical reception

5 The 'skin effect' and high frequency electrical safety

6 Instances and devices

7 Popularity

7.1 In popular culture

8 Related patents

9 See also

10 Notes

11 Further reading

12 External links

History

[[edit](#)]

Tesla's coil

[[edit](#)]

The "American Electrician"^[4] gives a description of an early tesla coil wherein a glass battery jar, 15 x 20 cm (6 x 8 in) is wound with 60 to 80 turns of AWG No. 18 B & S magnet wire (0.823 mm²). Into this is slipped a primary consisting of eight to ten turns of AWG No. 6 B & S wire (13.3 mm²) and the whole combination immersed in a vessel containing *linseed* or *mineral oil*. (Norrie, pg. 34-35)

Disruptive "Tesla" coils

[[edit](#)]

In the spring of 1891, Tesla gave demonstrations with various machines before the American Institute of Electrical Engineers at Columbia College. Following the initial research of *voltage* and *frequency* by *William Crookes*, Tesla designed and constructed a series of coils that produced high-*voltage*, high-frequency currents. These early coils used a *disruptive discharge* across a spark gap in their operation. The setup can be duplicated by a *Ruhmkorff coil*, two capacitors (then called condensers), and a second, specially constructed, disruptive coil. (Norrie, pg. 228)

In *U.S. Patent 0,454,622* [↗](#), *System of Electric Lighting* (1891 June 23), Tesla described this early disruptive coil. It was devised for the purpose of converting and supplying electrical energy in a form suited for the production of certain novel electrical phenomena, which require currents of higher frequency and potential. It also specified an energy storage capacitor and discharger mechanism on the primary side of a radio-frequency transformer. This is the first-ever disclosure of a practical RF power supply capable of exciting an antenna to emit powerful electromagnetic radiation.

Another early Tesla coil was protected in 1897 by *U.S. Patent 0,593,138* [↗](#), "Electrical Transformer". This transformer developed currents of high potential and was composed of a primary and secondary coil (optionally, one terminal of the secondary could be electrically connected with the primary; similar to modern *ignition coils*). This Tesla coil had the secondary being inside of, and surrounded by, the convolutions of the primary coil. This Tesla coil consisted of a primary and secondary wound in the form of a flat spiral. One coil, the secondary in step-up transformation, of the device consisted of a longer fine-wire. The apparatus was also connected to *ground* when the coil was in use.

The Ruhmkorff coil, being fed from a *main source*, is wired to

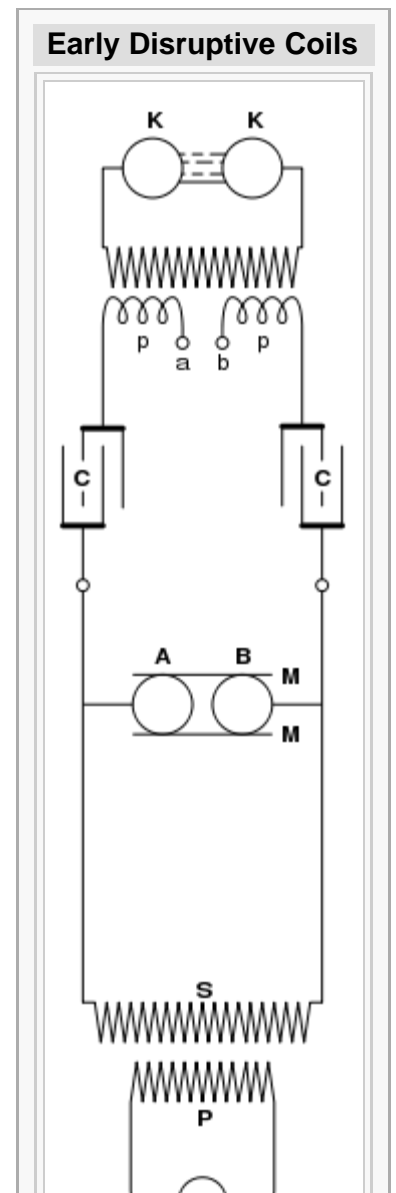

capacitors on both ends in series. A spark gap is placed in parallel to the Ruhmkorff coil before the capacitors. The discharge tips were usually metal balls under one inch (25 mm) in **diameter**, though Tesla used various forms of **dischargers**. The capacitors were of a special design, small with high insulation. These capacitors consisted of plates in oil that were movable. The smaller the plates, the more frequent the discharge of this early coil apparatus. The plates also help nullify the high self inductance of the secondary coil by adding capacitance to it. Mica plates were placed in the spark gap to establish an **air current** jet to go up through the gap. This helped to extinguish the **arc**, making the discharge more abrupt. An air blast was also used for this objective. (Norrie, pg. 230–231)

The capacitors are connected to a double primary (each coil in series with a capacitor). These are part of the second specially constructed disruptive coil. The primaries each have twenty turns of **No. 16** (1.31 mm²) B & S rubber covered wire and are wound separately on **rubber** tubes not less than a 1/8th inch (3.2 mm) thick. The secondary has three hundred turns of No. 30 (0.0509 mm²) B & S silk-covered **magnet wire**, wound on rubber tube or rod, and the ends encased in glass or rubber tubes. The primaries must be large enough to be loose when the secondary coil is placed between the coils. The primaries must cover around two inches (50 mm) of the secondary. A hard rubber division must be placed between these primary coils. The ends of the primaries not connected with the capacitors are led to a spark gap. (Norrie, pg. 35–36)

Later Tesla coil design

Tesla, in [U.S. Patent 0,645,576](#) *System of Transmission of Electrical Energy* and [U.S. Patent 0,649,621](#) *Apparatus for Transmission of Electrical Energy*, described new and useful combinations of transformer coils. The transmitting coil or conductor arranged and excited to cause currents or oscillation to propagate through conduction through the natural medium from one point to another remote point therefrom and a receiver coil or conductor of the transmitted signals.^[5] The production of currents of very high potential could be attained in these coils. He would later attain [U.S. Patent 0,723,188](#) , *Method of Signaling*, and [U.S. Patent 0,725,605](#) , *System of Signaling*, for coils with elevated transmitter capacitance with an Earth electrode.

Some of Tesla's later coils were

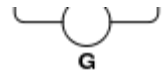

Imitation of a Hertzian Spark Gap

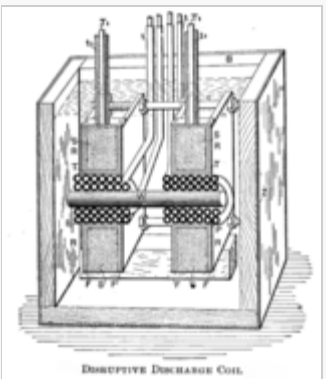

A configuration of his coils; Tesla's Disruptive Discharge Coil Box.

[\[edit\]](#)

Later Coil Design

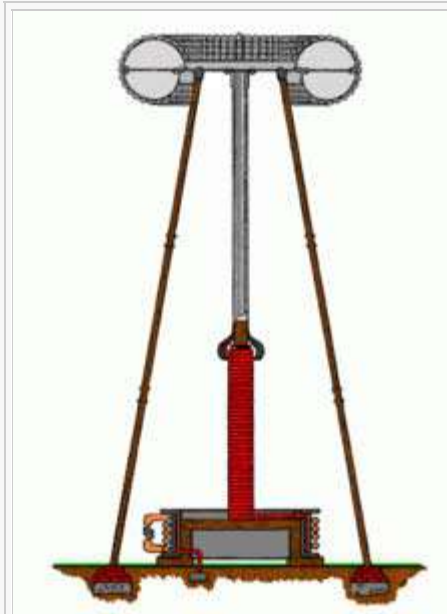

[U.S. Patent 1,119,732](#)

View in elevation

Free terminal and circuit of large surface with supporting structure and generating apparatus



Tesla coil transformer wound in the form of a flat spiral. This is the transmitter form as

considerably larger and operated at much higher power levels. When Tesla patented a later device in [U.S. Patent 1,119,732](#) (Apparatus for Transmitting Electrical Energy), he called the device a high-voltage, air-core, self-regenerative resonant transformer that generates very high voltages at high frequency. However, this phrase is no longer in conventional use.

described in [U.S. Patent 645,576](#) .

Tesla's later systems were usually powered from large high voltage power transformers, used banks of [Leyden jar](#) capacitors immersed in oil (to reduce [corona](#) losses), and used rotating spark gaps to handle the higher power levels. A rotating spark gap combines the ventilator needed to cool a fixed spark gap and the spark gap into a single device. The synchronous version uses a very simple electric motor, that is a permanent magnet encompassing a coil driven by the line voltage. But it needs to be started like the propeller of a biplane. It reduces spark gap losses, because it uses only two gaps, and it allows to extinguish the spark on zero passage.

Tesla also dispensed with using oil to insulate his transformer coils, relying instead on the insulating properties of air. Tesla coils achieve great [gain](#) in voltage by loosely coupling two resonant LC circuits, using an air-core (ironless) transformer. Although modern Tesla coils are usually designed to generate long sparks, Tesla's original systems were designed for [wireless communication](#). Tesla used top terminals (*toploads*) having large radii of curvature to prevent losses from corona and sparks (often called *streamers*). The voltage gain of the circuit with a free, or an elevated, toroid is proportional to the quantity of charge displaced, which is determined by the product of the capacitance of the circuit, the voltage (which Tesla called "*pressure*" in the sense of a [hydraulic analogy](#)), and the frequency of the currents employed.

Tesla Coil Theory

A Tesla coil transformer operates in a significantly different fashion than a conventional (i.e., iron core) transformer. In a conventional transformer, the windings are very tightly coupled, and voltage gain is limited to the ratio of the numbers of turns in the windings.

However, unlike a conventional transformer, which may couple 97%+ of the magnetic fields between windings, a Tesla coil's windings are "loosely" coupled, with the primary and secondary typically sharing only 10–20% of their ^{[[edit](#)]} respective magnetic fields and instead the coil transfers energy (via loose coupling) from one oscillating resonant circuit (the primary) to the other (the secondary) over a number of RF cycles.

As the primary energy transfers to the secondary, the secondary's output voltage increases until all of the available primary energy has been transferred to the secondary (less losses). Even with significant spark gap losses, a well designed Tesla coil can transfer over 85% of the energy initially stored in the primary capacitor to the secondary circuit. Thus the voltage gain of a disruptive Tesla coil can be significantly greater than a conventional transformer, since it is instead proportional to the [square root](#) of the ratio of secondary and primary inductances.

In addition, because of the large gap between the primary and secondary that loose coupling makes possible, the insulation between the two is far less likely to break down, and this permits coils to run extremely high voltages without damage.

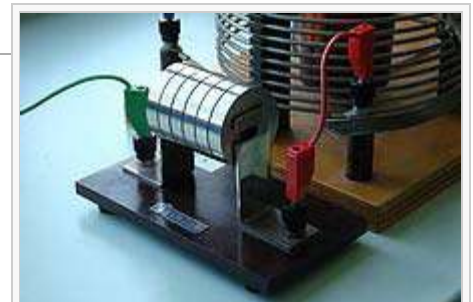

Multiple spark gap 8 kV for a Tesla coil



The parts of the spark gap

Modern day Tesla coils

[\[edit\]](#)

Modern high voltage enthusiasts usually build Tesla coils that are similar to some of Tesla's "later" air core designs. These typically consist of a primary **tank circuit**, which is a series LC (**inductance-capacitance**) circuit composed of a high voltage **capacitor**, **spark gap**, and **primary coil**; and the secondary LC circuit, a series resonant circuit consisting of the **secondary coil** and the toroid. In Tesla's original plans, the secondary LC circuit is composed of a loaded secondary coil which is then placed in series with a large helical coil. The helical coil was then connected to the toroid. Most modern coils use only a single secondary coil. The toroid actually forms one terminal of a **capacitor**, the other terminal being the Earth (or "**ground**"). The primary LC circuit is "tuned" so that it will **resonate** at the same frequency as the secondary LC circuit. The **primary** and **secondary** coils are magnetically coupled, creating a dual-tuned resonant air-core transformer. Earlier oil insulated Tesla coils needed large and long insulations at their connections to prevent discharge in air. Later version Tesla coils spread their electric fields over large distances to prevent high electrical stresses in the first place, thereby allowing operation in free air.

Tesla's original design for his largest coil used a top terminal consisting of a metallic frame in the shape of a **toroid**, covered with smooth half circular metal plates (constituting a very large conducting surface). On his **largest system**, Tesla employed on this type of shaped element within a **dome**. The top terminal has relatively small capacitance, charged to as high a voltage as practicable.^[6] The outer surface of the elevated **conductor** is where the electrical charge chiefly accumulates. It has a large **radius** of curvature, or is composed of separate elements which, irrespective of their own radii of curvature, are arranged close to each other so that the outside ideal surface enveloping them has a large radius.^[7] This design allowed the terminal to support very high voltages without generating corona or sparks. Tesla, during his patent application process, described a variety of resonator terminals at the top of this later coil.^[8] Most Modern Tesla coils use simple toroids, typically fabricated from spun metal or flexible aluminum ducting, to control the high **electrical field** near the top of the secondary and to direct spark outward, and away, from the primary and secondary windings.

Some of Tesla's work involved a more tightly coupled, air core, high frequency transformer, the output of which then fed another resonator, sometimes called an "extra coil", or simply an "upper secondary". The principle is that energy accumulates in the resonating, upper coil, and the role of transformer secondary is played by the separate, "lower" secondary; the roles are not shared by a single secondary. Modern three-coil **Magnifying transmitter** systems often either placed the upper secondary some distance from the transformer, or wound it on a considerably smaller diameter coil form. Direct magnetic coupling to the upper secondary was not desirable, since the third coil was designed to be driven directly by injecting RF current directly into the bottom end of the winding.

This particular Tesla circuit consists of a coil in close inductive relation with a primary, and one end of which is connected to a ground-plate, while its other end is led through a separate self-induction coil (whose connection should always be made at, or near, the geometrical center of that coil's circular aspect, in order to secure a **symmetrical** distribution of the current), and of a metallic cylinder carrying the current to the terminal. The primary coil may be excited by any desired source of high frequency current. The important requirement is that the primary and secondary sides must be tuned to the same resonant frequency to allow efficient transfer of energy between the primary and secondary resonant circuits. The conductor of the shaft to the terminal (topload) is in the form of a cylinder with



Electric discharge showing the lightning-like plasma filaments from a Tesla coil.

smooth surface of a radius much larger than that of the spherical metal plates, and widens out at the bottom into a hood (which is slotted to avoid loss by [eddy currents](#) and for safety). The secondary coil is wound on a drum of insulating material, with its turns close together. When the effect of the small radius of curvature of the wire itself is overcome, the lower secondary coil behaves as a conductor of large radius of curvature, corresponding to that of the drum (this effect is applicable elsewhere). The lower end of the upper secondary coil, if desired, may be extended up to the terminal [U.S. Patent 1,119,732](#) and should be somewhat below the uppermost turn of the primary coil. This lessens the tendency of the charge to break out from the wire connecting both and to pass along the support.

Modern day [transistor](#) or [vacuum tube](#)

Tesla coils do not use a spark gap.

Instead, the transistor(s) or vacuum tube(s) provide the switching or amplifying function necessary to generate RF power for the primary circuit. Transistor Tesla coils use the lowest primary operating voltage, typically between 155 to 800 volts, and drive the primary winding using either a half-bridge or full-bridge arrangement of [bipolar transistors](#), [MOSFETs](#) or [IGBTs](#) to switch the primary current. Vacuum tube coils typically operate with plate voltages between 1500 and 6000 volts, while most spark gap coils operate with primary voltages of 6,000 to 25,000 volts. The primary winding of a traditional transistor Tesla coil is wound

around only the bottom portion of the secondary (sometimes called the [resonator](#)). This helps to illustrate operation of the secondary as a pumped resonator. The primary *induces* alternating voltage into the bottommost portion of the secondary, providing regular "pushes" (similar to provided properly timed pushes to a playground swing). Additional energy is transferred from the primary to the secondary inductance and topload capacitance during each "push", and secondary output voltage builds (called *ring-up*). An electronic [feedback](#) circuit is usually used to adaptively synchronize the primary [oscillator](#) to the growing resonance in the secondary, and this is the only tuning consideration beyond the initial choice of a reasonable topload.

In a [dual resonant solid-state Tesla coil](#) (DRSSTC), the electronic switching of the solid-state Tesla coil (SSTC) is combined with the resonant primary circuit of a spark-gap Tesla coil. The resonant primary circuit is formed by connecting a capacitor in series with the primary winding of the coil, so that the combination forms a series [tank circuit](#) with a resonant frequency near that of the secondary circuit. Because of the additional resonant circuit, one manual and one adaptive tuning adjustment are necessary. Also, an [interrupter](#) is usually used to reduce the [duty cycle](#) of the switching bridge, in order to improve peak power capabilities; similarly, IGBTs are more popular in this application than [bipolar transistors](#) or MOSFETs, due to their superior power handling characteristics. Performance of a DRSSTC can be comparable to a medium power spark gap Tesla coil, and efficiency (as measured by spark length versus input power) can be significantly greater than a spark gap Tesla coil operating at the same input power.

Although even the relatively low primary circuit voltage of transistor Tesla coils can be quite dangerous, all known fatalities (one hobbyist, one bystander, and one child)^{[[citation needed](#)]} have, thus far, been killed from spark gap driven coils.^{[[citation needed](#)]}



Demonstration of the [Nevada Lightning Laboratory](#) 1:12 
scale prototype twin Tesla Coil at [Maker Faire 2008](#).

Utilization and production

[\[edit\]](#)

Electrical transmission [\[edit\]](#)

A large Tesla coil of more modern design often operates at very high peak power levels, up to many megawatts (millions of [watts](#)^[9]). It should therefore be adjusted and operated carefully, not only for efficiency and economy, but also for safety. If, due to improper tuning, the maximum voltage point occurs below the terminal, along the secondary coil, a discharge ([spark](#)) may break out and damage or destroy the coil wire, supports, or nearby objects.

Tesla experimented with these, and many other, circuit configurations (see right). The Tesla coil primary winding, spark gap and tank capacitor are connected in series. In each circuit, the AC supply transformer charges the tank capacitor until its voltage is sufficient to break down the spark gap. The gap suddenly fires, allowing the charged tank capacitor to discharge into the primary winding. Once the gap fires, the electrical behavior of either circuit is identical. Experiments have shown that neither circuit offers any marked performance advantage over the other.

However, in the typical circuit (above), the spark gap's short circuiting action prevents high frequency oscillations from 'backing up' into the supply transformer. In the alternate circuit, high amplitude high frequency oscillations that appear across the capacitor also are applied to the supply transformer's winding. This can induce corona discharges between turns that weaken and eventually destroy the transformer's insulation. Experienced Tesla coil builders almost exclusively use the top circuit, often augmenting it with low pass filters (resistor and capacitor (RC) networks) between the supply transformer and spark gap to help protect the supply transformer. This is especially important when using transformers with fragile high voltage windings, such as [Neon-sign](#) transformers (NSTs). Regardless of which configuration is used, the HV transformer must be of a type that self-limits its secondary current by means of internal [leakage inductance](#). A normal (low leakage inductance) high voltage transformer must use an external limiter (sometimes called a ballast) to limit current. NSTs are designed to have high leakage inductance to limit their short circuit current to a safe level.

Tuning precautions [\[edit\]](#)

The primary coil's resonant frequency should be tuned to that of the secondary, using low-power oscillations, then increasing the power until the apparatus has been brought under control. While tuning, a small projection (called a "breakout bump") is often added to the top terminal in order to stimulate [corona](#) and spark discharges (sometimes called streamers) into the surrounding air. Tuning

Transmission

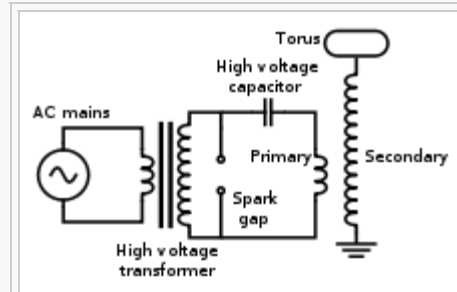

Typical Tesla Coil Schematic [\[edit\]](#)

This example circuit is designed to be driven by alternating currents. Here the spark gap shorts the high frequency across the first transformer. An inductance, not shown, protects the transformer. This design is favoured when a relatively fragile Neon Sign Transformer (NST) is used.

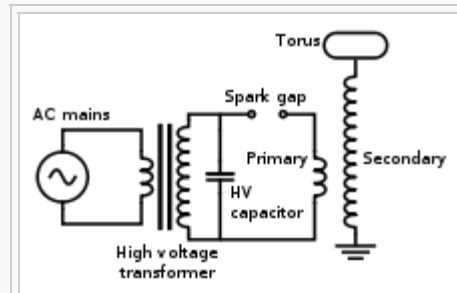

Alternate Tesla Coil Configuration [\[edit\]](#)

This circuit also driven by alternating currents. However, here the AC supply transformer must be capable of withstanding high voltages at high frequencies.

can then be adjusted so as to achieve the longest streamers at a given power level, corresponding to a frequency match between the primary and secondary coil. Capacitive 'loading' by the streamers tends to lower the resonant frequency of a Tesla coil operating under full power. For a variety of technical reasons, toroids provide one of the most effective shapes for the top terminals of Tesla coils.

Air discharges

[[edit](#)]

While generating discharges, electrical energy from the secondary and toroid is transferred to the surrounding air as electrical charge, heat, light, and sound. The electric currents that flow through these discharges are actually due to the rapid shifting of quantities of charge from one place (the top terminal) to other places (nearby regions of air). The process is similar to charging or discharging a [capacitor](#). The current that arises from shifting charges within a capacitor is called a [displacement current](#). Tesla coil discharges are formed as a result of displacement currents as pulses of electrical charge are rapidly transferred between the high voltage toroid and nearby regions within the air (called [space charge](#) regions). Although the space charge regions around the toroid are invisible, they play a profound role in the appearance and location of Tesla coil discharges.

When the spark gap fires, the charged capacitor discharges into the primary winding, causing the primary circuit to oscillate. The oscillating primary current creates a magnetic field that couples to the secondary winding, transferring energy into the secondary side of the transformer and causing it to oscillate with the toroid capacitance. The energy transfer occurs over a number of cycles, and most of the energy that was originally in the primary side is transferred into the secondary side. The greater the magnetic coupling between windings, the shorter the time required to complete the energy transfer. As energy builds within the oscillating secondary circuit, the amplitude of the toroid's RF voltage rapidly increases, and the air surrounding the toroid begins to undergo [dielectric breakdown](#), forming a [corona discharge](#).

As the secondary coil's energy (and output voltage) continue to increase, larger pulses of displacement current further ionize and heat the air at the point of initial breakdown. This forms a very conductive "root" of hotter [plasma](#), called a [leader](#), that projects outward from the toroid. The plasma within the leader is considerably hotter than a corona discharge, and is considerably more conductive. In fact, it has properties that are similar to an [electric arc](#). The leader tapers and branches into thousands of thinner, cooler, hairlike discharges (called streamers). The streamers look like a bluish 'haze' at the ends of the more luminous leaders, and it is the streamers that actually transfer charge between the leaders and toroid to nearby space charge regions. The displacement currents from countless streamers all feed into the leader, helping to keep it hot and electrically conductive.

In a spark gap Tesla coil the primary-to-secondary energy transfer process happens repetitively at typical pulsing rates of 50–500 times per second, and previously formed leader channels don't get a chance to fully cool down between pulses. So, on successive pulses, newer discharges can build upon the hot pathways left by their predecessors. This causes incremental growth of the leader from one pulse to the next, lengthening the entire discharge on each successive pulse. Repetitive pulsing causes the discharges to grow until the average energy that's available from the Tesla coil during



A small, later-type "*Tesla coil*" in operation. The output is giving 17-inch sparks. The diameter of the secondary is three inches. The power source is a 10000 V, 60 Hz [current limited](#) supply.



each pulse balances the average energy being lost in the discharges (mostly as heat). At this point, [dynamic equilibrium](#) is reached, and the discharges have reached their maximum length for the Tesla coil's output power level. The unique combination of a rising high voltage [Radio Frequency](#) envelope and repetitive pulsing seem to be ideally suited to creating long, branching discharges that are considerably longer than would be otherwise expected by output voltage considerations alone. High voltage discharges create filamentary multi-branched discharges which are purplish blue in colour. High energy discharges create thicker discharges with fewer branches, are pale and luminous, almost white, and are much longer than low energy discharges, because of increased ionisation. There will be a strong smell of ozone and nitrogen oxides in the area. The important factors for maximum discharge length appear to be voltage, energy, and still air of low to moderate humidity. However, even more than 100 years later after the first use of Tesla coils, there are many aspects of Tesla coil discharges and the energy transfer process that are still not completely understood.^[*citation needed*]

Electrical reception

[\[edit\]](#)

A variant of the Tesla coil transmitter was developed by Tesla for receiving the electrical field energy it produces. This receiver was also adapted for exploiting the ubiquitous vertical voltage gradient in the Earth's atmosphere. Tesla built and used various devices for detecting radio frequency energy. His early experiments were operating on the basis of Hertzian waves or ordinary radio waves, electromagnetic waves that propagate in space without a guiding surface being involved.^[10] During his work at Colorado Springs, Tesla believed that he had established an electrical resonance in the entire Earth using the Tesla coil transmitter at his laboratory operating at about 150,000 hertz (cycles per second) and about 300 horsepower (224,000 watts).^[11] He also used helical resonators with elevated terminals for his reception work.

Tesla stated that one of the requirements of the world wireless system was the construction of resonant receivers.^[12] The helical resonator of a Tesla Coil and its elevated terminal can be used in receive mode.^{[13][14][15][16][17][18]} Tesla himself demonstrated wireless transmission of electrical energy from his transmitter to his receiver. These concepts and methods are part of his [wireless transmission system](#) (US1119732 — Apparatus for Transmitting Electrical Energy — 1902 January 18). Tesla made a proposal that there needed to be many more than thirty transmission-reception stations worldwide.^[19] In one form of receiving circuit the two input terminals are connected each to a mechanical pulse-width modulation device adapted to reverse polarity at predetermined intervals of time and charge a [capacitor](#).^[20] This form of Tesla system receiver has means for commutating the current impulses in the charging circuit so as to render them suitable for charging the storage device, a device for closing the receiving-circuit, and means for causing the receiver to be operated by the energy accumulated.^[21]

A Tesla coil used as a receiver is referred to as a *Tesla receiving transformer*.^{[22][23][24][25]} The Tesla coil receiver acts as a step-down transformer with high current output.^[26] The parameters of a Tesla coil transmitter are identically applicable to it being a [receiver](#) (e.g., an [antenna](#) circuit), due to [reciprocity](#). Impedance, generally though, is not applied in an obvious way; for [electrical impedance](#), the impedance at the [load](#) (e.g., where the power is consumed) is most critical and, for a Tesla coil receiver, this is at the point of utilization (such as at an induction motor) rather than at the receiving node. [Complex](#) impedance of an antenna is related to the [electrical length](#) of the antenna at the wavelength in use. Commonly, impedance is adjusted at the load with a tuner or a matching networks composed of [inductors](#) and [capacitors](#).

A Tesla coil can receive electromagnetic impulses^[27] from [16][31]
[28][29][30]



Tesla coil in one experiment of many conducted in Colorado Springs. This is a grounded tuned coil in resonance with a nearby transmitter; Light is glowing near the bottom.

atmospheric electricity and radiant energy, besides normal wireless transmissions. Radiant energy throws off with great velocity minute particles which are strongly electrified and other rays falling on the insulated-conductor connected to a condenser (i.e., a capacitor) can cause the condenser to indefinitely charge electrically.^[32] The helical resonator can be "shock excited" due to radiant energy disturbances not only at the fundamental wave at one-quarter wave-length but also is excited at its harmonics. Hertzian methods can be used to excite the Tesla coil receiver with limitations that result in great disadvantages for utilization, though.^[33] The methods of ground conduction and the various induction methods can also be used to excite the Tesla coil receiver, but are again at a disadvantages for utilization.^[34] The charging-circuit can be adapted to be energized by the action of various other disturbances and effects at a distance. Arbitrary and intermittent oscillations that are propagated via conduction to the receiving resonator will charge the receiver's capacitor and utilize the potential energy to greater effect.^[35] Various radiations can be used to charge and discharge conductors, with the radiations considered electromagnetic vibrations of various wavelengths and ionizing potential.^[32] The Tesla receiver utilizes the effects or disturbances to charge a storage device with energy from an external source (natural or man-made) and controls the charging of said device by the actions of the effects or disturbances (during succeeding intervals of time determined by means of such effects and disturbances corresponding in succession and duration of the effects and disturbances).^[36] The stored energy can also be used to operate the receiving device. The accumulated energy can, for example, operate a transformer by discharging through a primary circuit at predetermined times which, from the secondary currents, operate the receiving device.^[36]

While Tesla coils can be used for these purposes, much of the public and media attention is directed away from transmission-reception applications of the Tesla coil since electrical spark discharges are fascinating to many people. Regardless of this fact, Tesla did suggest that this variation of the Tesla coil could utilize the phantom loop effect to form a circuit to induct energy from the Earth's magnetic field and other radiant energy sources (including, but not limited to, electrostatics^[37]). With regard to Tesla's statements on the harnessing of natural phenomena to obtain electric power, he stated:

Ere many generations pass, our machinery will be driven by a power obtainable at any point of the universe. — "Experiments with Alternate Currents of High Potential and High Frequency" (February 1892)

Tesla stated that the output power from these devices, attained from Hertzian methods of charging, was low,^[38] but alternative charging means are available. Tesla receivers, operated correctly, act as a step-down transformer with high current output.^[39] There are, to date, no commercial power

generation entities or businesses that have utilized this technology to full effect. The power levels achieved by Tesla coil receivers have, thus far, been a fraction of the output power of the transmitters.^[*citation needed*]

The 'skin effect' and high frequency electrical safety

[[edit](#)]

The dangers of contact with high frequency electrical current are sometimes perceived as being less than at lower frequencies, because the subject usually doesn't feel pain or a 'shock'. This is often erroneously attributed to [skin effect](#), a phenomenon that tends to inhibit [alternating current](#) from flowing inside conducting media. It was thought that in the body, Tesla currents travelled close to the skin surface, making them safer than lower frequency electric currents. In fact, in the early 1900s a major use of Tesla coils was to apply high frequency current directly to the body in [electrotherapy](#).

Although skin effect limits Tesla currents to the outer fraction of an inch in metal conductors, the '[skin depth](#)' of human flesh at typical Tesla coil frequencies is still of the order of 60 inches (150 cm) or more.^{[40][41][42][43][44]} This means that high frequency currents will still preferentially flow through deeper, better conducting, portions of an experimenter's body such as the [circulatory](#) and [nervous systems](#). The reason for the lack of pain is that a [human](#) being's nervous system does not sense

the flow of potentially dangerous electrical currents above 15–20 kHz; essentially, in order for nerves to be activated, a significant number of ions must cross their membrane before the current (and hence voltage) reverses. Since the body no longer provides a warning 'shock', novices may touch the output streamers of small Tesla coils without feeling painful shocks. However, there is anecdotal evidence among Tesla coil experimenters that temporary tissue damage may still occur and be observed as muscle pain, joint pain, or tingling for hours or even days afterwards. This is believed to be caused by the damaging effects of internal current flow, and is especially common with [continuous wave](#) (CW), [solid state](#) or [vacuum tube](#) type Tesla coils. It is, however, of note that certain transformers can be used to provide alternating current with a frequency high enough so that the skin depth becomes small enough for the voltage to be safe. As this number is inversely proportional to the root of the frequency, this is fairly high; the number is in the megahertz.

Large Tesla coils and magnifiers can deliver dangerous levels of high frequency current, and they can also develop significantly higher voltages (often 250,000–500,000 volts, or more). Because of the higher voltages, large systems can deliver higher energy, potentially lethal, repetitive high voltage capacitor discharges from their top terminals. Doubling the output voltage quadruples the electrostatic energy stored in a given top terminal capacitance. If an unwary experimenter accidentally places himself in path of the high voltage capacitor discharge to ground, the low current [electric shock](#) can cause involuntary spasms of major muscle groups and may induce life-threatening [ventricular fibrillation](#) and [cardiac arrest](#). Even lower power vacuum tube or solid state Tesla coils can deliver RF currents that are capable of causing temporary internal tissue, nerve, or joint damage through [Joule heating](#). In addition, an RF [arc](#) can carbonize flesh, causing a painful and dangerous bone-deep [RF burn](#) that may take months to heal. Because of these risks, knowledgeable experimenters avoid contact with streamers from all but the smallest systems. Professionals usually use other means of

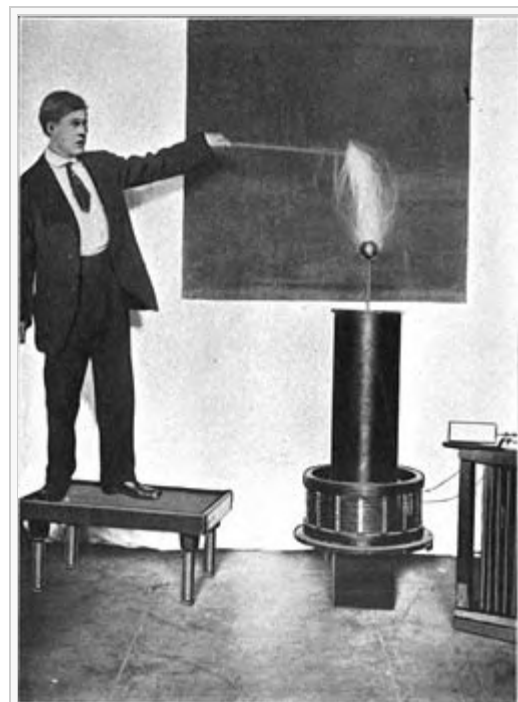

Student conducting Tesla coil streamers through his body, 1909



protection such as a [Faraday cage](#) or a [chain mail](#) suit to prevent dangerous currents from entering their body.

The most serious dangers associated with Tesla coil operation are associated with the primary circuit. It is the primary circuit that is capable of delivering a sufficient current at a significant voltage to stop the heart of a careless experimenter. Because these components are not the source of the trademark visual or auditory coil effects, they may easily be overlooked as the chief source of hazard. Should a high frequency arc strike the exposed primary coil while, at the same time, another arc has also been allowed to strike to a person, the ionized gas of the two arcs forms a circuit that may conduct lethal, low-frequency current from the primary into the person. This is believed to have been the cause of death of a professional Tesla coil demonstrator, [Henry Leroy Transtrom](#), in 1951.

Further, great care should be taken when working on the primary section of a coil even when it has been disconnected from its power source for some time. The tank capacitors can remain charged for days with enough energy to deliver a fatal shock. Proper designs should always include 'bleeder resistors' to bleed off stored charge from the capacitors. In addition, a safety shorting operation should be performed on each capacitor before any internal work is performed.^[45]

Instances and devices

[[edit](#)]

Tesla's Colorado Springs laboratory possessed one of the largest Tesla coils ever built, known as the "[Magnifying Transmitter](#)". The Magnifying Transmitter is somewhat different from classic 2-coil Tesla coils. A Magnifier uses a 2-coil 'driver' to excite the base of a third coil ('resonator') that is located some distance from the driver. The operating principles of both systems are similar. The world's largest currently existing 2-coil Tesla coil is a 130,000 watt unit, part of a 38 foot tall sculpture. It is owned by [Alan Gibbs](#) and currently resides in a private sculpture park at Kakanui Point near [Auckland, New Zealand](#).^[48]

The Tesla coil is an early predecessor (along with the [induction coil](#)) of a more modern device called a [flyback transformer](#), which provides the voltage needed to power the [cathode ray tube](#) used in some televisions and computer monitors. The disruptive discharge coil remains in common use as the [ignition coil](#)^[49]^[50] or [spark coil](#) in the

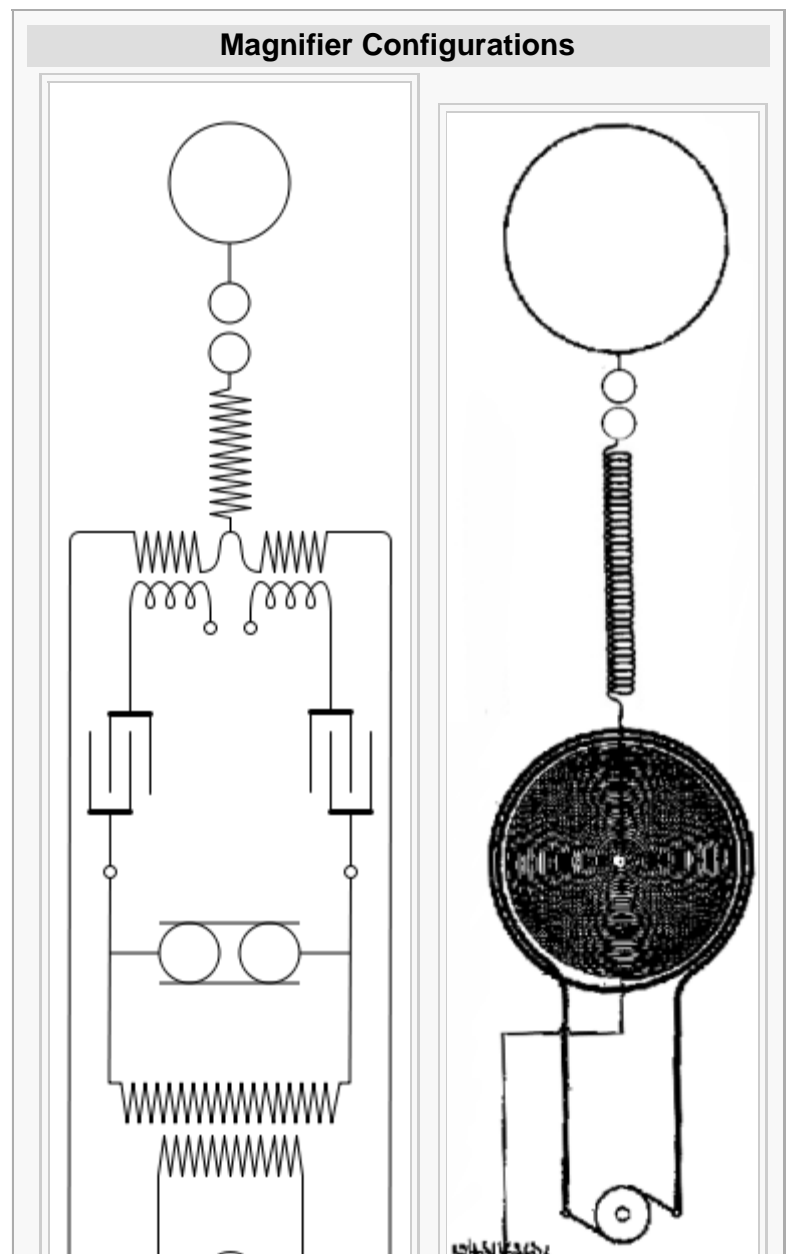

ignition system of an [internal combustion engine](#). These two devices do not use resonance to accumulate energy, however, which is the distinguishing feature of a Tesla coil. They do use inductive "kick", the forced, abrupt decay of the magnetic field, such that a voltage is

provided by the coil at its primary terminals that is much greater than the voltage that was applied to establish the magnetic field, and it is this higher voltage that is then multiplied by the transformer turns ratio. Thus, they do store energy, and a Tesla resonator stores energy. A modern, low power variant of the Tesla coil is also used to power [plasma globe](#) sculptures and similar devices.

Scientists working with a glass vacuum line (e.g. chemists working with volatile substances in the gas phase, inside a system of glass tubes, taps and bulbs) test for the presence of tiny pin-holes in the apparatus (especially a newly blown piece of glassware) using a Tesla coil. When the system is evacuated and the discharging end of the coil moved over the glass, the discharge travels through any pin-hole immediately below it and thus illuminates the hole, indicating points that need to be annealed or re-blown before they can be used in an experiment.

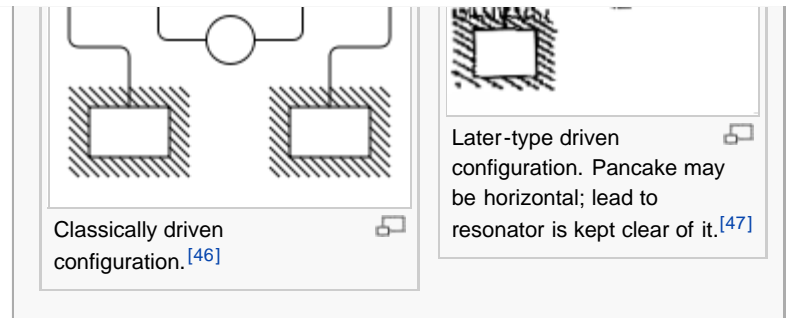

Popularity

[\[edit\]](#)

Tesla coils are very popular devices among certain [electrical engineers](#) and [electronics](#) enthusiasts. Builders of Tesla coils as a hobby are called "coilers". A very large tesla coil, designed and built by Syd Klinge, is shown every year at the [Coachella Valley Music and Arts Festival](#), in Coachella, Indio, California, USA. There are "coiling" conventions where people attend with their home-made Tesla coils and other electrical devices of interest. There are rather significant [safety](#) issues^[45] regarding coil assembly and operation by hobbyists (including professional engineers), which may be discovered by study of the literature far more reliably than by only attempting one's own analysis.

Low power Tesla coils are also sometimes used as a high voltage source for [Kirlian photography](#).^[51]

Tesla coils can also be used to create music by modulating the system's effective "break rate" (i.e., the rate and duration of high power RF bursts) via [MIDI](#) data and a control unit. The actual MIDI data is interpreted by a microcontroller which converts the MIDI data into a [PWM](#) output which can be sent to the Tesla coil via a fiber optic interface.^{[52][53]} The [YouTube](#) video [Super Mario Brothers theme in stereo and harmony on two coils](#)  shows a performance on matching solid state coils operating at 41 kHz. The coils were built and operated by designer hobbyists Jeff Larson and Steve Ward. The device has been named the [Zeusaphone](#), after [Zeus](#), Greek god of lightning, and as a play on words referencing the [Sousaphone](#).

In popular culture

[\[edit\]](#)

Tesla coils are popular devices in films and computer games, have played a role in novels and have even appeared on stage in opera:

- The [Jim Jarmusch](#) film *Coffee and Cigarettes* (2003) featured a segment starring [Jack](#) and [Meg White](#) from the band [The White Stripes](#) entitled "Jack shows Meg his Tesla coil". In the segment, the pair are having a coffee. Jack explains the work of Nikola Tesla to Meg and demonstrates the coil he has by his side.
- A Tesla coil was used to produce all of the [V'Ger](#) lightning effects for "*Star Trek: The Motion Picture*" (1979). Production was carried out at an airfield by teams of crew members working around the clock in order to make the very-cramped schedule; so much so that other members of the production crew (including [Special Visual Effects](#) director/supervisor [Douglas Trumbull](#)) were

called in to staff it.

- In the opera *Tesla - Lightning in His Hand*, a huge Tesla coil appears on stage, enclosed in a [Faraday cage](#). As the character of Tesla walks towards the coil, the voltage that comes off the top of the coil with a huge cracking sound forms a corona that looks like a bolt of lightning and appears to illuminate the globe in Tesla's hand. The installation of the coil took two people seven days, and was managed by a retired head physicist of Australia's telecommunications company Telstra.
- The performance group [ArcAttack](#), the first group to utilize musical Tesla Coils as an instrument in their act^[54], originate from the USA and have been touring locally and internationally since March 2006. They have also appeared on NBC's America's Got Talent. ^[55]
- The musical group, [Man or Astro-man?](#) uses a spark gap Tesla coil as a lighting effect during their performances.^{[56][57]}

Related patents

[[edit](#)]

Tesla's patents

See also: [List of Tesla patents](#)

- "*Electrical Transformer Or Induction Device*". U.S. Patent No. 433,702, August 5, 1890^[58]
- "*Means for Generating Electric Currents*", U.S. Patent No. 514,168, February 6, 1894
- "*Electrical Transformer*", Patent No. 593,138, November 2, 1897
- "*Method Of Utilizing Radiant Energy*", Patent No. 685,958 November 5, 1901
- "*Method of Signaling*", U.S. Patent No. 723,188, March 17, 1903
- "*System of Signaling*", U.S. Patent No. 725,605, April 14, 1903
- "*Apparatus for Transmitting Electrical Energy*", January 18, 1902, U.S. Patent 1,119,732, December 1, 1914 (available at [U.S. Patent 1,119,732](#) and tfcbooks' [Apparatus for Transmitting Electrical Energy](#))

Others' patents

- J. S. Stone, [U.S. Patent 714,832](#) , "*Apparatus for amplifying electromagnetic signal-waves*". (Filed January 23, 1901; Issued December 2, 1902)
- A. Nickle, [U.S. Patent 2,125,804](#) , "*Antenna*". (Filed May 25, 1934; Issued August 2, 1938)
- William W. Brown, [U.S. Patent 2,059,186](#) , "*Antenna structure*". (Filed May 25, 1934; Issued October 27, 1936).
- Robert B. Dome, [U.S. Patent 2,101,674](#) , "*Antenna*". (Filed May 25, 1934; Issued December 7, 1937)
- Armstrong, E. H., [U.S. Patent 1,113,149](#) , "*Wireless receiving system*". 1914.
- Armstrong, E. H., [U.S. Patent 1,342,885](#) , "*Method of receiving high frequency oscillation*". 1922.
- Armstrong, E. H., [U.S. Patent 1,424,065](#) , "*Signalling system*". 1922.
- Gerhard Freiherr Du Prel, [U.S. Patent 1,675,882](#) , "*High frequency circuit*". (Filed August 11, 1925; Issued July 3, 1928)
- Leydorf, G. F., [U.S. Patent 3,278,937](#) , "*Antenna near field coupling system*". 1966.
- Van Voorhies, [U.S. Patent 6,218,998](#) , "*Toroidal helical antenna*"
- Gene Koonce, [U.S. Patent 6,933,819](#) , "*Multifrequency electro-magnetic field generator*". (Filed October 29, 2004; Issued August 23, 2005)^[59]

See also

[[edit](#)]

- [833A](#)
- [Bifilar coil](#)
- [List of Tesla patents](#)
-

Tesla turbine

- [Wireless energy transfer](#)
- [Nikola Tesla](#)

Notes

[[edit](#)]

- ↑ ^{***a b***} Uth, Robert (December 12, 2000). "Tesla coil" ↗. *Tesla: Master of Lightning*. PBS.org. Retrieved 2008-05-20.
- ↑ Tilbury, Mitch (2007). *The Ultimate Tesla Coil Design and Construction Guide* ↗. New York: McGraw-Hill Professional. pp. 1. ISBN 0071497374.
- ↑ Ramsey, Rolla (1937). *Experimental Radio, 4th Ed.* ↗. New York: Ramsey Publishing. pp. 175.
- ↑ This is an early electronics magazine.
- ↑ Peterson, Gary, "*Comparing the Hertz-wave and Tesla wireless systems*" ↗. Feed Line No. 9 Article
- ↑ N. Tesla, US patent No. 1,119,732. "I employ a terminal of *relatively* small capacity, which I charge to as high a pressure as practicable." (emphasis added) Tesla's lightning rod, [U.S. Patent 1,266,175](#) ↗, goes more into this subject. The reader is also referred to the [U.S. Patent 645,576](#) ↗, [U.S. Patent 649,621](#) ↗, [U.S. Patent 787,412](#) ↗, and [U.S. Patent 1,119,732](#) ↗.
- ↑ Patent 1119732, lines 53 to 69; In order to attain the highest possible frequency and to develop the greatest energy in the circuit, Tesla elevated the conductor with a large radius of curvature or was composed of separate elements which in conglomeration had a large radius.
- ↑ In "*Selected Patent Wrappers from the National Archives*", by John Ratzlaff (1981; ISBN 0-9603536-2-3), there was a variety of terminals described by Tesla. Besides the [torus](#) shaped terminal, he applied for hemi-[spherical](#) and [oblate](#) termininals. A total of 5 different terminals were applied for, but four were rejected. The terminals could be used to produce, preferably according to Tesla, [longitudinal waves](#) and, secondarily, "Hertzian" [transverse waves](#).
- ↑ This is equivalent to hundreds of thousands of [horsepower](#)
- ↑ [Definition of "Hertzian"](#) ↗
- ↑ John J. O'Neill, *Prodigal Genius: The Life of Nikola Tesla*. Page 192.
- ↑ Marc J. Seifer, *Wizard: The Life and Times of Nikola Tesla*. Page 228.
- ↑ Tesla, Nikola, "*The True Wireless*". *Electrical Experimenter*, May 1919. ([Available at pbs.org](#) ↗)
- ↑ [U.S. Patent 645,576](#) ↗
- ↑ [U.S. Patent 725,605](#) ↗
- ↑ ^{***a b***} [U.S. Patent 685,957](#) ↗, Apparatus for the utilization of radiant energy, N. Tesla
- ↑ [U.S. Patent 685,958](#) ↗, Method of utilizing of radiant energy, N. Tesla
- ↑ "*Apparatus for Transmitting Electrical Energy*", Jan. 18, 1902, U.S. Patent 1,119,732, December 1, 1914 (available at [U.S. Patent 1,119,732](#) ↗ and 21st Century Books' [Apparatus for Transmitting Electrical Energy](#) ↗)
- ↑ Marc J. Seifer, *Wizard: The Life and Times of Nikola Tesla*. Page 472. (*cf.* "Each tower could act as a sender or a receiver. In a letter to Katherine Johnson, Tesla explains the need for well over thirty such towers".)
- ↑ U.S. Patent 0685956
- ↑ U.S. Patent 0685955 Apparatus for Utilizing Effects Transmitted From A Distance To A Receiving Device Through Natural Media
- ↑ G. L. Peterson, [Rediscovering the Zenneck Surface Wave](#) ↗.
- ↑ '[Energy-sucking](#)' [Radio Antennas](#) ↗, N. Tesla's Power Receiver.
- ↑ William Beaty, "*Tesla invented radio*" ↗". 1992.
- ↑ [Nikola Tesla's Contributions to Radio Developments](#) ↗. www.tesla-symp06.org.
- ↑ A. H. Taylor, "[Resonance in Aërial Systems](#)" ↗". American Physical Society. Physical review. New York, N.Y.: Published for the American Physical Society by the American Institute of Physics. (*cf.* *The Tesla coil in the receiver acts as a step-down transformer, and hence the current is greater than in the aerial itself.*)
- ↑ This would include being able to be "shock excited" by all [electrical phenomena](#) of [transverse waves](#) (those with vibrations perpendicular to the direction of the propagation) and [longitudinal waves](#) (those with vibrations parallel to the direction of the propagation). Further information can be found in [U.S.](#)



design and construction of induction coils. New York: McGraw.

- Haller, G. F., & Cunningham, E. T. (1910). *The Tesla high frequency coil, its construction and uses*. New York: D. Van Nostrand Co.
- Iannini, R. E. (2003). *Electronic gadgets for the evil genius: 21 build-it-yourself projects*. TAB electronics. New York: McGraw-Hill. Pages 137 – 202.
- Corum, Kenneth L. and James F. "*Tesla Coils and the Failure of Lumped-Element Circuit Theory*"
- Nicholson, Paul, "*Tesla Secondary Simulation Project*" (Current state of the art in rigorously describing Tesla coil secondary behavior through theoretical analysis, simulation and testing of results in practice)
- Bill Beaty "*Nikola Tesla Coil Information*".
- Vujovic, Ljubo, "*Tesla Coil*". Tesla Memorial Society of New York.
- Hickman, Bert, "*Tesla Coil Information Center*".
- Cooper, John. F., "*Magnifying Transmitter early-type circuit diagram*"; *Later-type circuit diagram*". Tesla-Coil.com

Electrical World

- "*The Development of High Frequency Currents for Practical Application*"., The Electrical World, Vol 32, No. 8.
- "*Boundless Space: A Bus Bar*". The Electrical World, Vol 32, No. 19.

Other publications

- A. L. Cullen, J. Dobson, "*The Corona Breakdown of Aerials in Air at Low Pressures*". Proceedings of the Royal Society of London. Series A, Mathematical and Physical Sciences, Vol. 271, No. 1347 (February 12, 1963), pp. 551–564
- Bieniosek, F. M., "*Triple Resonance Pulse Transformer Circuit*". Review of Scientific Instruments, 61 (6).
- Corum, J. F., and K. L. Corum, "*RF Coils, Helical Resonators and Voltage Magnification by Coherent Spatial Modes*". IEEE, 2001.
- de Queiroz, Antonio Carlos M., "*Synthesis of Multiple Resonance Networks*". Universidade Federal do Rio de Janeiro, Brazil. EE/COPE.
- Haller, George Francis, and Elmer Tiling Cunningham, "*The Tesla high frequency coil, its construction and uses*". New York, D. Van Nostrand company, 1910.
- Hartley, R. V. L., "*Oscillations with Non-linear Reactances*". Bell Systems Technical Journal, Sun Publishing. 1992.
- Norrie, H. S., "*Induction Coils: How to make, use, and repair them*". Norman H. Schneider, 1907, New York. 4th edition.
- Reed, J. L., "Greater voltage gain for Tesla transformer accelerators", Review of Scientific Instruments, 59, p. 2300, (1988).
- Curtis, Thomas Stanley, *High Frequency Apparatus: Its Construction and Practical Application*. Everyday Mechanics Co., 1916.

External links

[[edit](#)]

- [Tesla coil](#) at the [Open Directory Project](#)

Categories: [Transformers \(electrical\)](#) | [Electromagnetic coils](#) | [Power supplies](#) | [Nikola Tesla](#) | [Electrical breakdown](#)

This page was last modified on 26 August 2010 at 15:36.

Text is available under the [Creative Commons Attribution-ShareAlike License](#); additional terms may apply. See [Terms of Use](#) for details.

Wikipedia® is a registered trademark of the [Wikimedia Foundation, Inc.](#), a non-profit organization.

[Contact us](#)

[Privacy policy](#) [About Wikipedia](#) [Disclaimers](#)

