

**AT** MICROFICHE  
REFERENCE  
LIBRARY

A project of Volunteers in Asia

Tropical Oysters

Published by:

IDRC  
Box 8500  
Ottawa  
CANADA K1G 3H9

Available from:

same as above

Reproduced by permission.

Reproduction of this microfiche document in any form is subject to the same restrictions as those of the original document.

IDRC-TS17e

# tropical oysters:

**culture  
and  
methods**

**d.b. quayle**



The International Development Research Centre is a public corporation created by the Parliament of Canada in 1970 to support research designed to adapt science and technology to the needs of developing countries. The Centre's activity is concentrated in five sectors: agriculture, food and nutrition sciences; health sciences; information sciences; social sciences; and communications. IDRC is financed solely by the Government of Canada; its policies, however, are set by an international Board of Governors. The Centre's headquarters are in Ottawa, Canada. Regional offices are located in Africa, Asia, Latin America, and the Middle East.

©1980 International Development Research Centre  
Postal Address: Box 8500, Ottawa, Canada K1G 3H9  
Head Office: 60 Queen Street, Ottawa

Quayle, D.B.

IDRC-TS17e

Tropical oysters : culture and methods. Ottawa, Ont., IDRC, 1980.  
80 p. : ill.

/IDRC publication/, /manual/, /oyster culture/, /tropical zone/--  
/morphology/, /biology/, /oceanography/, /fishing equipment/,  
/harvesting/, glossary.

UDC: 639.41(02)

ISBN: 0-88936-181-9

Microfiche edition available

Layout and graphics: Moura Quayle

# contents

<u>FOREWORD</u>	3
<u>INTRODUCTION</u>	4
<u>BIOLOGY</u>	5
Taxonomy	5
Structures & functions	7
Breeding	9
Larvae & spat	11
Setting behaviour	17
Growth	20
Oyster feeding	22
Condition factor	23
Fouling	25
Predators, pests, disease & parasites	27
<u>CULTURE</u>	31
Spatfall prediction	31
Spat collectors -- collection	32
Site selection	35
Culture	37
Harvesting	44
Storage	44
Shucking	45
Equipment	46
<u>BIOLOGICAL METHODS</u>	50
Plankton	50
Oceanography	55
Microscopical technique	61
Microscope measurements	65
<u>GENERAL</u>	67
Land tenure	67
Statistics	68
Pollution	69
Mangroves	72
Study priorities	73
<u>GLOSSARY</u>	75
<u>REFERENCES</u>	79

For review and suggestions appreciation is expressed to W.H.L. Allsopp,  
F.R. Bernard, N. Bourne, F.B. Davy and R. MacIntyre.

# foreword

Bivalve shellfish such as oysters, mussels, and clams are very widely distributed throughout the world and have long enjoyed a high consumer preference and market value in temperate climates. The change of techniques from bottom cultivation to off-bottom or suspended cultures has contributed to considerably increased production in many countries. However, in general, production from tropical countries has been traditionally very limited even though bivalves flourish and reproduce abundantly in warmer climates. In such tropical countries native oysters are often harvested for subsistence and rural fisheries. They are not a luxury item.

Only comparatively recently have there been serious attempts at oyster cultivation, but where favourable conditions exist rapid growth has been observed and marketable oysters are obtained in nine months. Because the potential for increased oyster production is great, and oysters are a source of much-needed protein for many rural people, IDRC responded favourably to requests for project support in this area first in Sierra Leone and then in Malaysia. Currently, funds are provided for support of similar studies in seven countries. An interesting and expanding network of investigations has thus been formed to develop the worldwide potential of tropical waters to produce oysters for domestic consumption.

Because of his distinguished international experience with the oyster industry, Dr. Quayle has been retained by IDRC since 1973 as a consultant to this series of projects. In response to much interest in the prospects of bivalve culture IDRC has issued a selected bibliography on tropical oysterculture (IDRC-052e), prepared an instructional slide series on oysterculture methods, and subsequently produced, with Dr. Quayle's guidance, a documentary film entitled "Oyster Farming in the Tropics." Requests for the bibliography and film should be addressed to Communications Division, IDRC, P.O. Box 8500, Ottawa, Canada K1G 3H9. The slide series is available through W.H.L. Allsopp, IDRC, 5990 Iona Drive, University of British Columbia, Vancouver, B.C. V6T 1L4.

It is hoped that this comprehensive manual will be useful for both researchers and field personnel involved in producing tropical oysters. The detailed instructions, glossary, and references should prove to be a practical supplement to the film for those who seek to produce oysters and other bivalves for food in the tropics.

W.H.L. Allsopp  
Associate Director (Fisheries)  
Agriculture, Food and Nutrition Sciences Division  
IDRC



# introduction

There is an increasing interest in oyster culture in the tropics because of the realization of the existence of a potential renewable resource that is able to produce protein and provide needed artisanal occupation.

However, since this form of aquaculture is fairly new to most tropical countries, there are few trained culturists. It is possible to provide overseas training for a selected few with academic backgrounds. The purpose of this manual is to provide others with a guide to the basics of oyster culture and various associated techniques. Some of it may seem quite technical but this is difficult to avoid. It is expected that with additional reading and assistance from supervisors the manual may explain the reasons for various cultural and biological tasks as well as provide a reference.

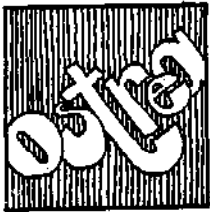

## taxonomy

1

Crassostrea - external view

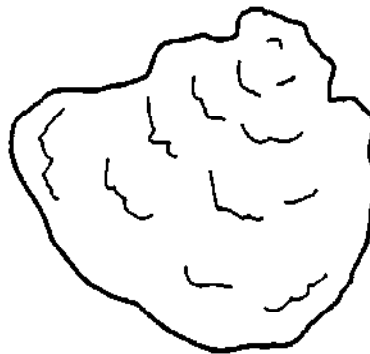
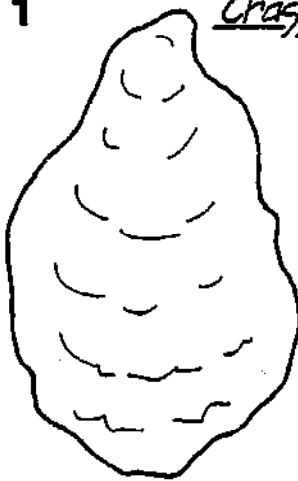

Ostrea - external view

The oysters of the world are grouped into one family called the Ostreidae. Within this family are three main groups or genera called Ostrea, Crassostrea and Pycnodonta. (1) In each of these genera are a number of species and about 100 species throughout the world are known. Many of these have been described on the basis of shell

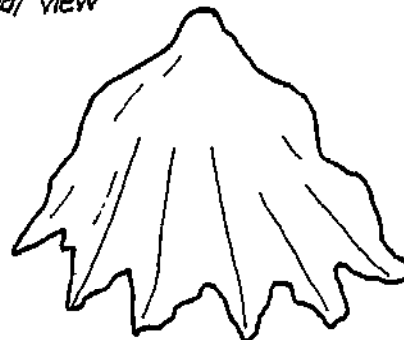

Pycnodonta - external view

characteristics only. However, this feature in oysters is extremely variable, so there may be, in fact, not as many individual species as originally considered. The main characteristics of the three genera are given in Table 1. The genus Ostrea which is wide-spread through most parts of the world is generally considered to be adapted to clear waters with little sediment and high salinity. The genus Crassostrea is well able to exist in estuaries where the silt load is high and salinity variable and generally low. Pycnodonta mainly occur in tropical open seas with high salinity, but they are not abundant.

**table 1**

<u>Ostrea</u>	<u>Crassostrea</u>	<u>Pycnodonta</u>
Left valve shallow	Left valve cupped	Left valve shallow
Circular in outline	Elongate	Shape variable
Adductor muscle scar central	Adductor muscle scar near shell edge	
Adductor muscle scar colourless	Adductor muscle scar often colourless	
No promyal chamber	Promyal chamber present	Promyal chamber present
Eggs large - incubated	Eggs small - not incubated	
Gut does not pass through heart	Gut does not pass through heart	Gut passes through heart

The oysters most widely cultivated are Ostrea edulis and Crassostrea angulata in Europe; Crassostrea virginica on the east coast of North America; Crassostrea gigas in Japan, Korea and the west coast of United States and Canada. Recently, the latter species has been introduced into France, England, Morocco, Australia and New Zealand. In Australia, the main cultivated species is C. commercialis and in New Zealand C. glomerata and C. lutaria, and in the Philippines C. iredalei. Common species in the Indian Ocean and southeast Asia are C. cucullata, a small hard-shelled oyster, and C. echinata. In the Caribbean area C. rhizophorae is cultured and probably C. brasiliiana along the east coast of Southern South America. On the west coast of South America O. chilensis is an important species. In South Africa C. margaritacea is the dominant oyster and along the central west coast of Africa, C. gasar is utilized.

While it is important to know the species of oyster being studied it is not absolutely essential. Often information obtained on a species in one area may not be applicable elsewhere. The literature may provide leads and indications but the basic biological information such as breeding periods and growth rates must be confirmed and the variations established for each locality. The literature on oyster identification is scattered and not yet finalized. Aid in identification may be obtained from nearby universities or from major museums such as the British or the United States National Museums.





# structures & functions

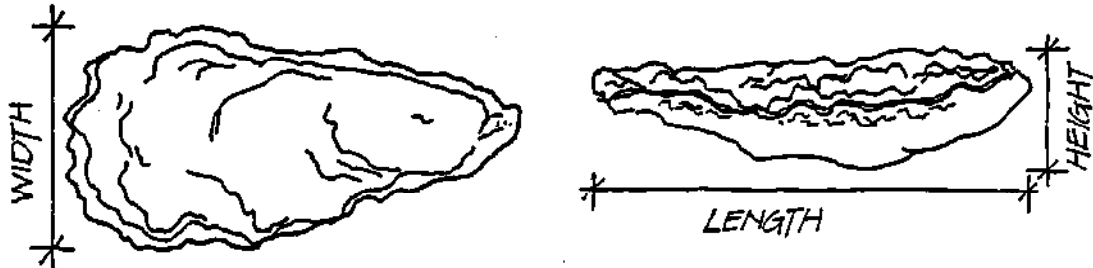

## 2 DIMENSIONAL TERMS APPLIED TO OYSTERS

It is useful for an oyster worker to be familiar with the main anatomical features of an oyster. The shell consists of two valves, a larger, lower and usually cupped left valve and an upper, smaller, fairly flat right valve. The two valves are hinged at the anterior, which is usually pointed and termed the umbral end. (2) The hinge, which is internal, springs the valves apart. It is opposed doing so by a single adductor muscle which is attached to each valve in the general area of the centre, although this position varies with the species.

The shell itself is composed of three layers. The inner is a thin hard, usually shiny layer called nacre or mother-of-pearl. The outer layer is a thin, horny almost membranous layer which soon wears away. Between these two layers is a chalky one which forms the main part of the shell. If oysters are grown on a firm hard surface such as gravel or on trays the shell is usually quite fluted; when grown on muddy ground it is smooth. If grown in waters of high salinity the shell is quite hard; in low salinity it tends to be soft.

If the upper right valve is removed, the body of the oyster lies with the mouth at the umbral or hinge end and the posterior at the rounded end. Thus the long axis is actually the height, but common usage indicates this as the length. With the left valve down and hinge to the left, the top side is dorsal and the bottom is ventral. The mantle covers the whole body on both sides. In the ventral area it takes the form of two thin skirts, thickened at the edge and usually darker than the main mantle area. The mantle is, the part of the body that secretes shell.

When both free portions of the mantle are removed (3) at the anterior end, four leaf-like appendages are seen surrounding the mouth. These are labial palps, considered to select and reject food particles. Along the whole ventral part of the body are four, long, finely ridged beige-coloured appendages which are the gills. Rapidly beating fine hairs or cilia on the gill surface create an incoming water current through the ventral shell gape. They function as both respiratory and food collecting devices. Water passes through the basket-like structure of the gills where food particles and other material are strained out and the blood aerated. The filtered water is then passed out dorsally, through both the promyal chamber if there is one, and from an area just behind the adductor muscle. Various tracts of cilia on the gills carry the filtered particles to the palp and mouth.

The digestive system consists of a mouth, a short oesophagus or throat which leads into a pouch-like stomach. At the base of the stomach is a groove which in a feeding oyster contains a yellowish gelatinous rod called the crystalline style. This is an integral part of the digestive system and is a source of enzymes. When the oyster is

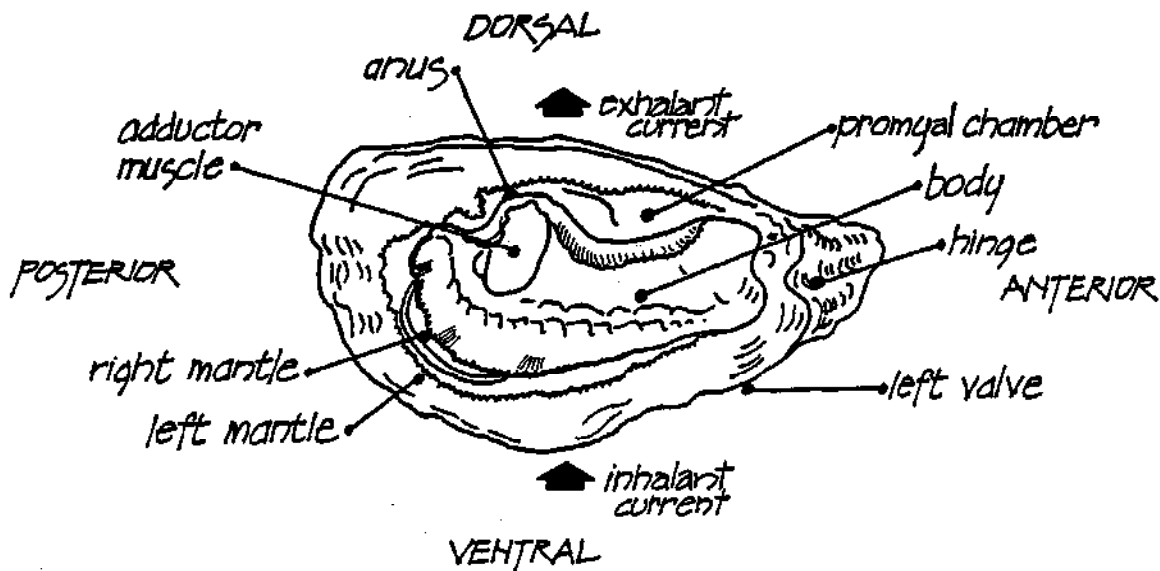

### 3 Crassostrea WITH RIGHT VALVE REMOVED.

removed from the water the style disintegrates but is reformed when the oyster is again allowed to feed. The crystalline style is often taken to be a parasitic worm by laymen. From the stomach leads a fairly long thin intestine ending in the anus which lies above the adductor muscle.

On either side of the stomach and with ducts leading into it is a series of branched tubes called the digestive diverticula, sometimes referred to as the liver. This is deeply pigmented and when the oyster is actively feeding, it is dark green or black, otherwise a light brown. In a thin oyster, without a glycogen or spawn layer, the digestive gland may be seen through the body wall.

Removal of the tissues anterior to the adductor muscle exposes the heart. This consists of one ventricle and two auricles which connect with thin-walled blood vessels. The blood is colorless.

The oyster has a simplified nerve system and consists of three distinct groups of nerve cells rather than a single brain.

The reproductive organs of an animal are termed gonads and in the female, gonads producing eggs or ova are called ovaries. The male gonad producing sperms are called testes. The ovaries and testes occur in separate oysters and consist of a series of branching tubules on each side of the body. During the breeding season when the gonads are ripe and the tubules filled with eggs or sperms, the gonad covers most of the body. At this time individual tubules may seem almost like veins on the surface of the body. However, after complete spawning the oyster is thin and watery, tasteless and contains little meat so it is unsuitable for market. This vacant space once occupied by the gonad gradually becomes filled with a starch-like substance called glycogen which is the basis for the subsequent formation of eggs and sperms. In temperate climates the division between the glycogen and the gonadal periods is more distinct than in the tropics owing to the large difference between summer and winter temperatures.

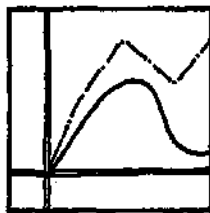

## breeding

A knowledge of the breeding time and habits of the oyster is important because of its relation to the collection of the young - called seed. The two main types of oysters, Ostrea and Crassostrea, have different breeding habits. In Ostrea the eggs, when released from the gonad, are retained in the mantle cavity within the shell while the sperms are discharged externally. Eggs are fertilized by sperm from outside and about half the larval life takes place inside the shell before being released into the open water. In Crassostrea, at spawning, both eggs and sperms are discharged directly outside into the open water where fertilization and all subsequent development takes place.

After fertilization and within 24 hours, the embryo, or larva, (4) as it is now called,

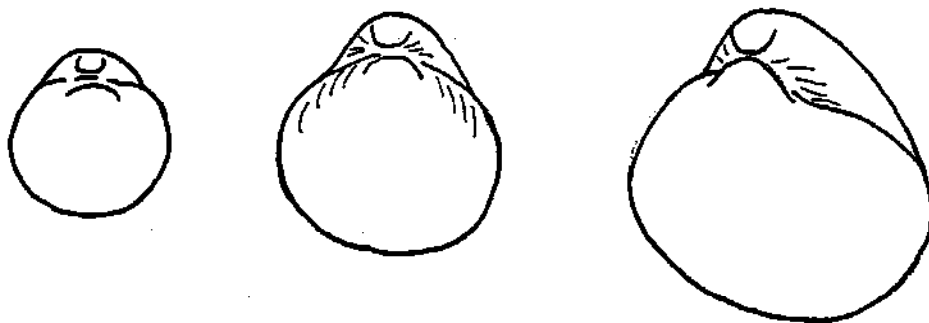

EARLY UMBO

MID UMBO

ADVANCED UMBO

### 4 GROWTH STAGES IN OYSTER LARVAE.

develops two tiny shells and the ability to swim by the beating of minute hairs called cilia. Soon after, some of the basic organ systems develop and by the end of the larval period, the embryonic oyster has 2 adductor muscles, a digestive system, several gill filaments, a foot with which it can crawl, a black eye spot and a swimming and food collecting organ called the velum.

When the larva reaches a certain length, the young oyster is ready to become attached. This size of about 1/3 millimeter takes 2 to 3 weeks in temperate waters. In some species in tropical waters it is nearly half a millimeter after about a week or 10 days. If when swimming it strikes a clean hard object such as an oyster shell or mangrove root, it begins to crawl about on its foot. When it finds a suitable spot, often a small crevice, it deposits from a gland in the foot a small puddle of cement into which it crawls with the left or cupped valve down. The cement quickly hardens and the oyster is then attached for life. This process is called spatting or setting and the young oyster is now a spat or a seed oyster (5).

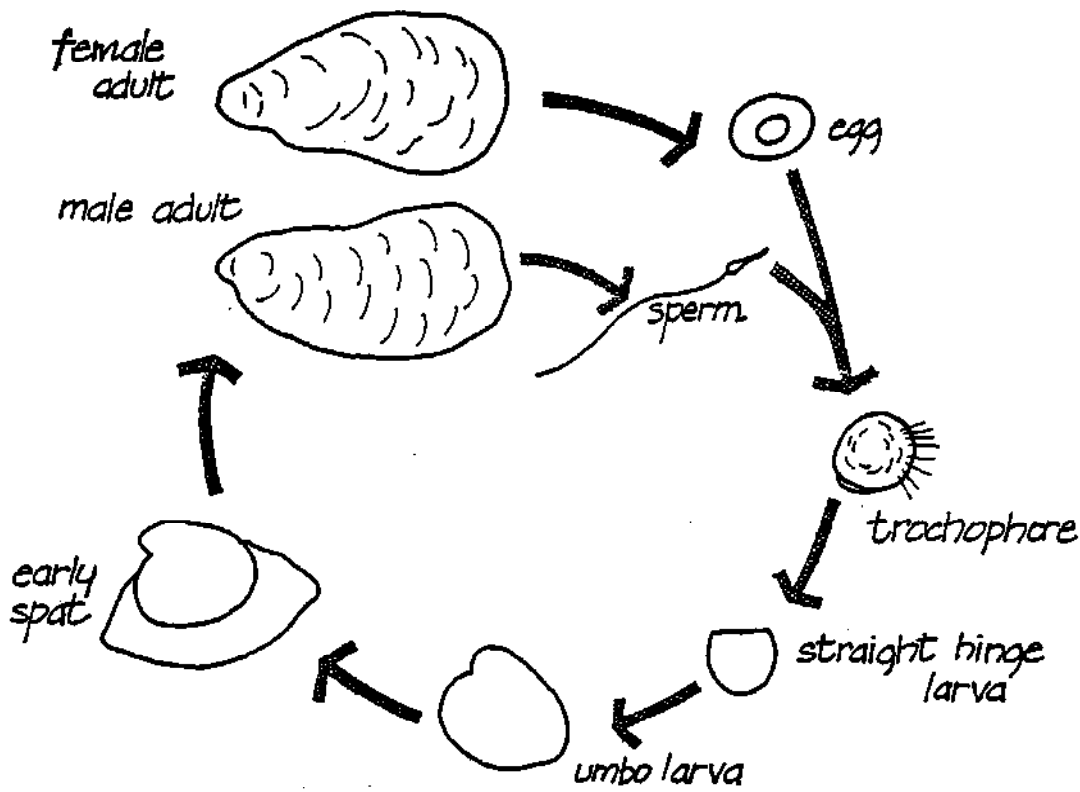

### 5 LIFE CYCLE OF AN OYSTER (NOT TO SCALE)

In *Ostrea* type oysters there is an alternation of sexuality, usually within the one spawning season. The oyster may spawn first as a male after which the gonads are changed to the female phase, and at the next spawning eggs are released. In the *Crassostrea* type the oyster spawn either as a male or a female in any one season but the sex may change before the breeding season the following year. The entire contents of the gonad may be discharged at one time or small amounts may be released over a long period. In temperate climates spawning is usually confined to a brief period of one or two months in mid summer. In the tropics spawning may be extended over most of the year with peaks, usually before and after the rainy season. To ensure fertilization both eggs and sperms must be released at the same time. Rapid changes in temperature or salinity are considered important factors in the initiation of spawning. However, the presence of sexual products of the oyster in the water in which other oysters are feeding is often enough to stimulate spawning if the gonads are sufficiently ripe and the temperature and salinity is satisfactory. This cross stimulation aids in the necessary mass spawning.

There are several ways to determine the breeding season of oysters. The first is to put out in the breeding area or an area where oysters occur naturally, collectors (called cultch) of old oyster shell or plates of fibro-cement, small enough in size so they may be placed under a stereoscopic microscope. These are put out and taken in at regular intervals. One series may be exposed for only a week at a time, while

others may be out for monthly periods or longer. The weekly panels will provide the spatting for that week while the others which give the cumulative amounts, important as commercial cultch, are usually exposed for longer periods. These collectors may be put out in several promising locations and at different tidal levels, i.e. half tide, low tide, one, two or three metres below the surface from rafts. Number of spat per unit area are counted with a stereoscopic microscope.

The second method consists of taking plankton samples at weekly intervals to determine the occurrence of oyster larvae. Sampling methods are described in another section.

The third method is to take monthly samples of about 50 oysters to determine the condition of the gonad. This may be done either by gross examination, smears or microscopic sections. The latter is, of course, the best method but the others will indicate large changes in the condition of the gonad. As stated before, a spawned oyster is thin and watery while a ripe oyster is plump and creamy with the gonad tubules prominent on the body surface.

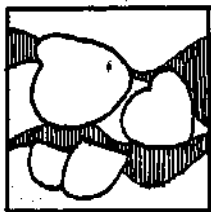

## larvae & spat

Ability to identify the larva of a molluscan species being cultured may not be absolutely necessary in all cases but in some it may. However, if a culture is to develop to its optimum potential, some larval information is imperative, otherwise certain positive avenues of development may be blocked. For instance, it may be possible to conduct a satisfactory culture without spatfall prediction, whereas with it, a more successful one may be possible. This occurs in cases where fouling of collectors may be a factor in setting success and the correct timing of exposure of the cultch from spatfall predictions as a result of larval knowledge may mean the difference between good or poor sets.

### IDENTIFICATION METHODS

There are several ways to identify molluscan larvae. The best and most positive is to culture the larvae in the laboratory. This requires ability to cause adults to spawn when required but this is not always simple. Stripping or mechanical removal and mixing of sperm and ova from males and females may be possible but unless the ova are spawned naturally, fertilization may often be difficult if not impossible with some species. Further, the culture facility must be temperature controlled and with a sterile water supply. Another difficulty is culturing live food for larvae and feeding them correct amounts. Thus, unless there are fairly sophisticated laboratory facilities, culturing molluscan larvae should not be considered.

There is an alternative, a partial culture method, particularly useful in tropical countries where air and water temperatures may not be too different. Here a number of advanced stage larvae of a particular species may be isolated from live plankton samples and placed in a container with normal sea water which has been filtered (50 microns or less) to remove the larger planktonic organisms. There is usually sufficient larval food in the filtered water to allow larval growth to the point of metamorphosis and spatting and likely where identification may be possible. Experiments with water changes every other day or so, with some aeration and stirring, should be made.

The third method possible with a minimum of equipment is matching advanced stage larvae with the larval shell (prodissoconch) on the smallest spat that can be collected. The shape of the prodissoconch, its size, and abundance of its larvae and

spat relative to other molluscan species are useful for comparisons. Reference to the literature (Loosanoff and Davis, Chanley and Andrews, and Rees) may also assist in placing the larva in the right molluscan family (Rees is particularly useful for this). A knowledge of local molluscan species and their relative abundance may also provide leads. It should be noted that the identifications in Rees are based largely on this method. Equipment needed for this, and indeed most molluscan larval study, is a stage stereoscopic microscope with both incident and reflected light and a magnification up to about X70 with X10 wide field eye pieces, a micrometer such as the Filar eyepiece type and a stage micrometer for calibration. Also necessary are plain watch glasses of 100 mm diameter as well as 2 1/2 inch syracuse-type watch glasses. Fine pipets, dropping pipets and fine dissecting needles are the only instruments required. Plankton is sampled with nets, No. 20 or 25 silk or nylon with a mouth diameter of 30 cm. and a suitable bucket.

#### PLANKTON SAMPLING

In most areas, a sample from a 5 minute surface tow with a 30 cm. net will supply a sufficient number of larvae, depending on the season. If the sample is to be examined alive, the jar containing the sample may be tapped lightly on the table top - this will cause the swimming larva to fall to the bottom. These are then taken up with a dropping pipet and placed in a watch glass. When this is 1/3 filled, the contents are centrifuged into the centre of the watch glass by holding it by the edges and gently swirling the plankton with a rotating motion. The molluscan larvae and other heavier particles will lie on the bottom centre of the glass while the lighter organisms float above. Slightly tilting the glass will cause the latter to flow to the side where they may be removed with a pipet. This procedure may be repeated several times after adding clean sea water to the glass until all that remains are larvae and other heavy particles in the centre. They may then be viewed in the microscope and worked over without interference from unrelated floating or swimming organisms of no other interest.

To preserve the plankton sample add only sufficient buffered formalin to give about a 2% solution. To a 300 ml. plankton jar, add no more than 6 ml. of concentrated formalin. After a day or so the molluscan larva should be separated and placed in 70% neutral alcohol or other non-corrosive media as suggested in UNESCO Publication No. 4.

The identification of molluscan larvae is not easy. Differences between species, even from different families may be slight and subtle. Continuous long term study is required. Photographs, if possible, are useful but have to be clear for effective definition. Personal drawings and sketches of the larvae are most practical, outlining them as accurately as possible, and accentuating or even exaggerating special characteristics. Shape is most important but how the larva is tilted in the watch glass may make it significantly different. The only true shape is evident when a single valve lies with the inside rim downwards. To achieve this treat a sample of larvae with a solution of 1% potassium hydroxide or with ordinary kitchen bleach (Chlorox, Perflex) and shake the sample well. The chemical clears the larvae so only the shells are observable while shaking separates the valves. Those with the inside down will provide true outlines while those with the inside up will provide a view of the provinculum and hinge teeth.

Colour may occasionally be significant. In some species, the actual shell is coloured. In others the general colour, particularly of the digestive gland, may be influenced by the particular diet. Most molluscs with a single or unequally sized adductor muscles (mussels, oysters) have black eye spots in the advanced stage. Some, like the anomids, have pigment spots and may have the beginning of the byssal notch in the larval shell. The provinculum and hinge teeth are important taxonomic features (6) as demonstrated by Rees and more recent publications describing lamellibranch larvae feature illustrations of these structures.

## 6 FEATURES OF BIVALVE LARVAE

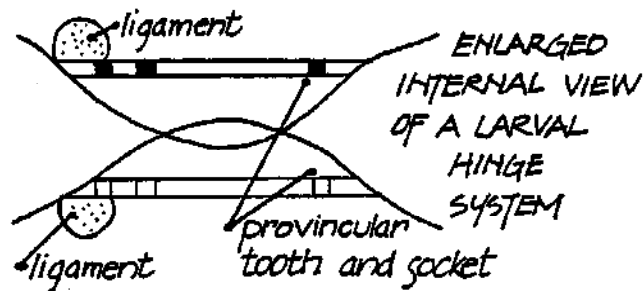
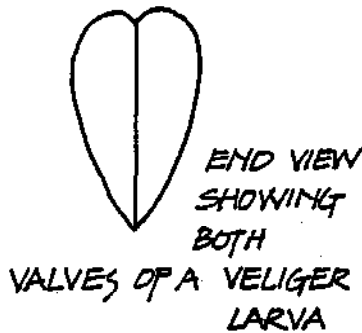
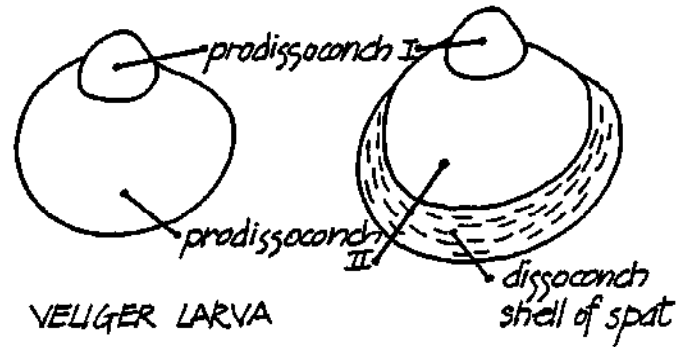

### LARVAL GROWTH STAGES

The larval shell, initially called a veliger, is the D-shaped or straight hinged larva, which is now most commonly termed the Prodissoconch I, and is marked off by a fairly distinct line from the succeeding Prodissoconch II.

The relative dimensions of the larvae, size (length or height) at setting and length of Prod I also provide useful information. Once the advanced stage larvae are identified, it is possible to work backwards to the smaller, younger stages. The youngest stage of the shelled larva, initially called a veliger, is D-shaped with a straight hinge. This shell is also termed Prodissoconch I and is distinctly different from the further growth of the larval shell called Prodissoconch II. Prodissoconch II, which forms the larger part of the larval shell and of the larval period, has fine growth lines whereas Prod I does not. This larval stage is also called the veliconcha. After settlement the adult, mainly calcareous, shell or dissoconch is then laid down. The length of Prod I is quite constant for each species and forms a distinguishing characteristic. Another distinguishing feature of bivalve larvae is the hinge area which is usually thickened to form a base for teeth and the hinge ligament. The Solenacea (razor clams) is the only group with an external ligament - all others are internal. The Lucinacea and the Erycinacea, usually with quite large larvae and often larviparous, are the only groups without hinge teeth. Fortunately oyster larvae, particularly the advanced stages, are quite distinct from most other bivalve larvae. However, identification of early stages does present difficulties and certainty only comes from experience. In temperate waters, when larvae are about half grown (4) the umbones are quite prominent and the length at this time is about 150 microns. When full grown, larvae are approximately 300 microns in length; the umbones are well developed and a black eye spot is present. Larvae of tropical Crassostrea tend to be larger, up to 450 microns in length.

Identification features are based upon:

- 1) Height to length ratio
- 2) Entire shape
- 3) Shape of anterior and posterior ends - rounded or pointed
- 4) Position of the umbones, whether central or displaced anteriorly or posteriorly and proportional lengths
- 5) Colour. This pertains to some larvae only, others are quite colourless or with variable colours. In general live larvae of the genus Crassostrea tend to be brownish while those of the genus Ostrea tend to be black.
- 6) Length of Prod I
- 7) Teeth and ligament

In (7) are shown various typical larval shapes which may be used for comparison with the larvae being studied. By the process of elimination, the number of possibilities may be narrowed.

7 TYPICAL SHAPES OF VARIOUS SPECIES OF BIVALVE LARVAE



Ostrea



Crassostrea



Hiatella



Mya



Tellina



Ensis



Cardium



Mygella



Spigula



Anomia



Mytilus

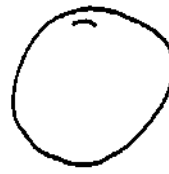

Pecten



## LENGTH OF LARVAL LIFE

This may be determined by laboratory culture but these conditions may not relate to those in the sea so care must be used in the application of such data. Similarly, any period determined in the sea for any one year may not be applicable for all years because of variations in temperature and food supply. Both of these determine growth rate of larvae. A series of determinations must be made over a number of years. In some instances spawnings may be distinct where the time intervals between successive spawnings is considerable such as about a week. In such a case the larval period is simply determined as the interval between the appearance of straight hinged larvae and first spatting. (8)

8 LARVAL PERIOD OF THE PACIFIC OYSTER AT VARIOUS TEMPERATURES  
DATA FROM PENDRELL SOUND.

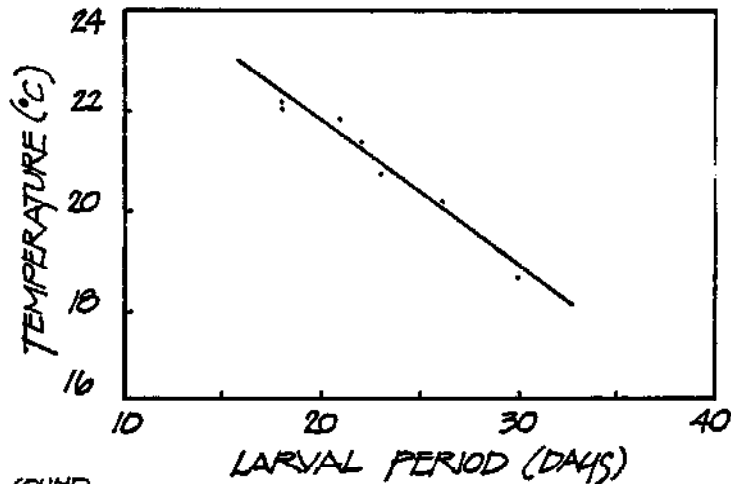

Daily samples of larvae (approximately 100 larvae per sample) should be accordingly measured and the mean length plotted to give a growth curve. (9) At the same time daily settlement records should be maintained.

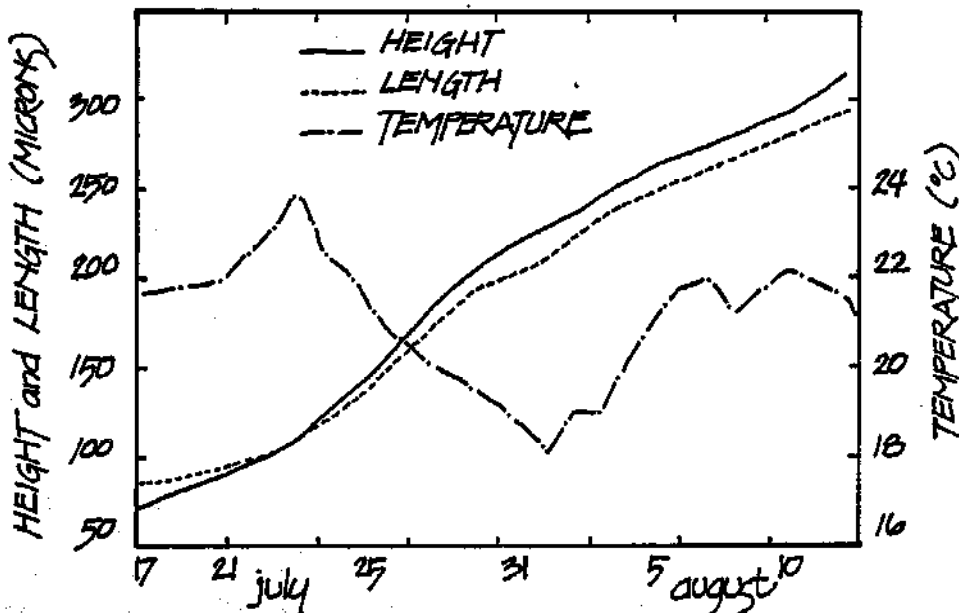

9 GROWTH RATE OF LARVAE OF PACIFIC OYSTER IN PENDRELL SOUND

If the larval broods are not distinct it will be necessary to obtain length measurements of daily samples to develop frequency polygons. Plotting these on a time basis (10) will indicate the movement of the modes with time, and time between the appearance of a group of straight hinge larvae with its mode and disappearance of that mode, coupled with a similar settlement peak, will indicate the approximate length of larval life.

### 10 LENGTH-FREQUENCY GRAPHS TO DETERMINE LENGTH OF LARVAL PERIOD

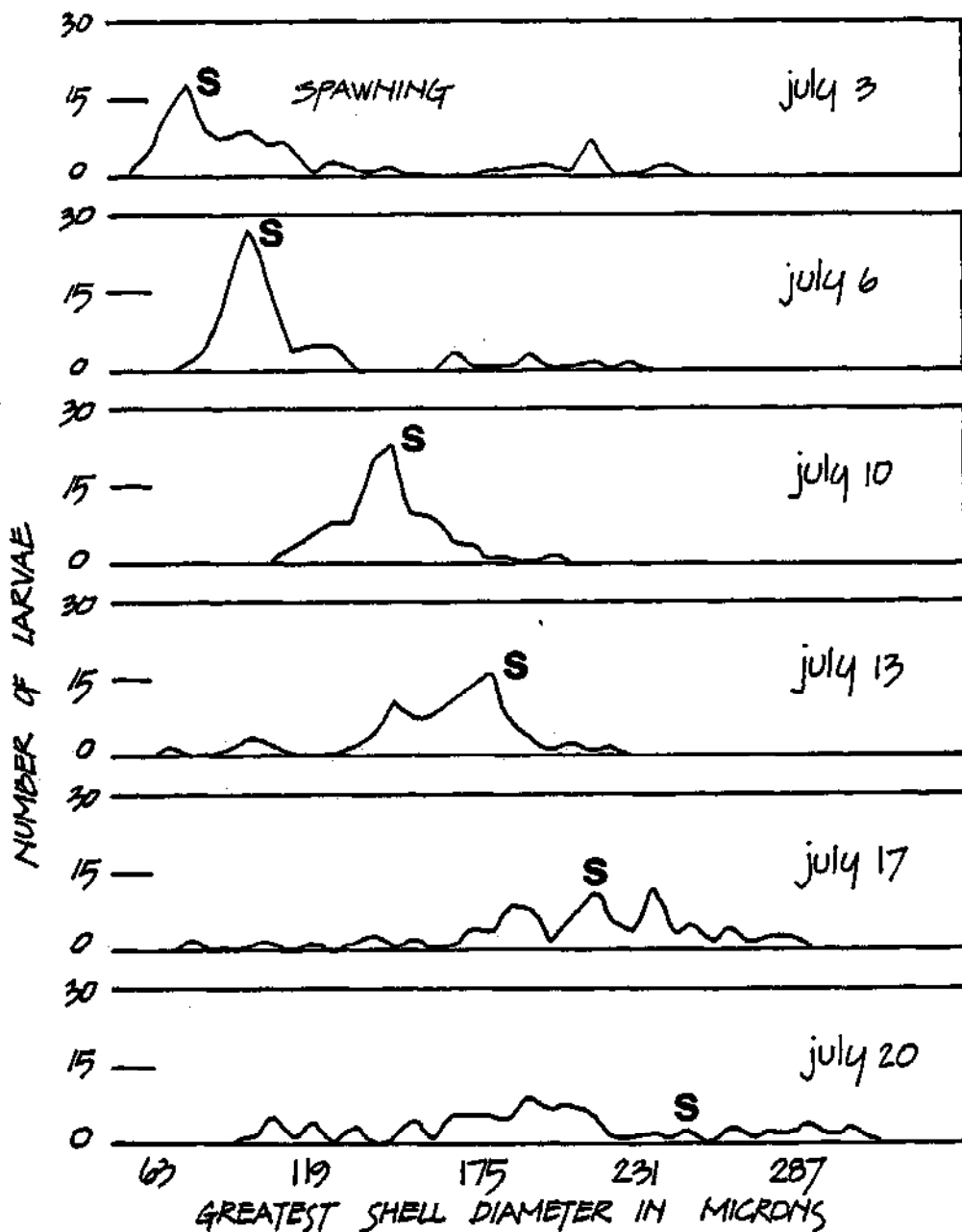



# setting behaviour

Some knowledge of setting behaviour of oyster larvae is necessary so cultch may be placed in the most advantageous location. These sites are chosen relative to depth and orientation of the setting surfaces, whether vertical or horizontal. Other factors that may have an influence are temperature, salinity, light, tidal cycle, angle of surface, colour and texture of surface as well as cleanliness (dirt, silt, fouling organisms). Temperature and salinity are generally considered to have little effect on setting behaviour, since if they are satisfactory for growth and survival they should be satisfactory for setting.

## LIGHT

The variables here are time of day or night, turbidity of water and weather conditions, whether cloudy or sunny. The effect of light may be studied in the field by exposing test cultch for successive brief intervals throughout the day and night during various types of weather conditions. Turbidity may be determined by Secchi disc readings. Exposure intervals of about 3 hours usually allow for adequate settlement. Where there is a significant tidal range it can be timed to coincide with slack water periods and equally spaced intervals between. In this case the effect of the tidal cycle may be demonstrated. This study should be carried out during both neap and spring tidal series where these exist and each series of exposures should last for 72 hours. At least 50 pieces of cultch (slides or plates) divided into 5 groups of 10 should be exposed every 3 hours for the 3 day period. If necessary, studies may develop later depending on the results of the initial investigation. The effect of light may also be studied in the laboratory but this requires sophisticated equipment and laboratory findings are often difficult to apply in the field.

## DEPTH

This is an important factor and must be examined relative to fixed points on the shore above and below low water. Sites suitable for settlement above low water will vary depending partly on the amount of silt. Often the intertidal situation is more a question of survival rather than the result of larval behaviour. (1) Below low water, variations in temperature and salinity occur in spite of continuous submergence, particularly during periods when the water column is stratified. A constant depth situation relative to the surface of the water can be provided from a floating platform where variations in temperature, salinity, light and current speed may also occur. There may be settlement variations as shown in 12 and this type of information will indicate the best depth at which collectors may be placed. In the initial experimental stage a long string up to 8 metres in length with individual collectors placed at intervals of 3 to the metre along it, may be suspended from the raft. Several such strings should be exposed simultaneously to obtain a measure of variability between collectors at similar depths at a single station, and in case one or more may be lost.

The angle of surface is of some importance and in some instances and in some species setting is greatest on upper horizontal cultch surfaces while in others, it is on the lower horizontal surface. It may also vary from year to year so experiments or observations must be repeated annually for some time to establish a definite pattern. Experiments to determine the most suitable angle should place collectors at various angles around a central axis with the following designation:

11 VERTICAL DISTRIBUTION OF SPATFALL ON FIXED CULTCH

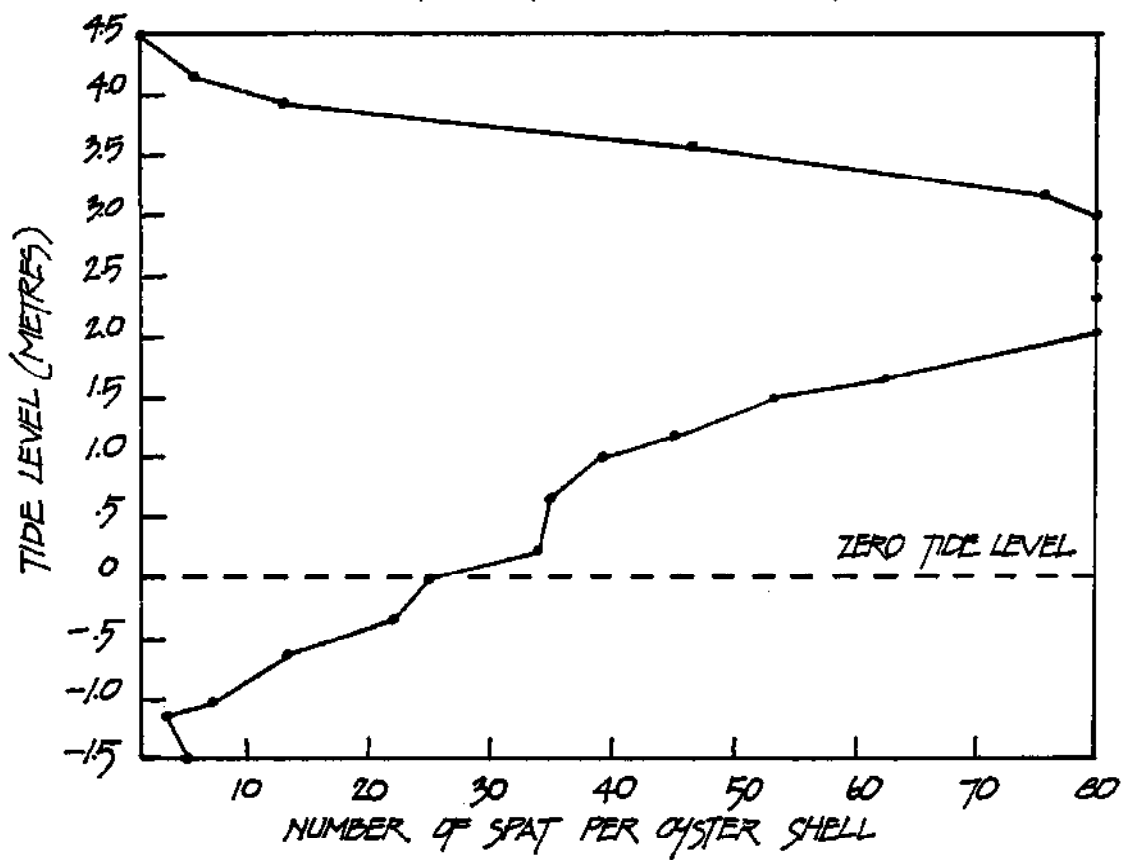

12 VERTICAL DISTRIBUTION OF SPATFALL ON FLOATING CULTCH (PENHRELL SOUND) AS RELATED TO VERTICAL TEMPERATURE CHANGE.

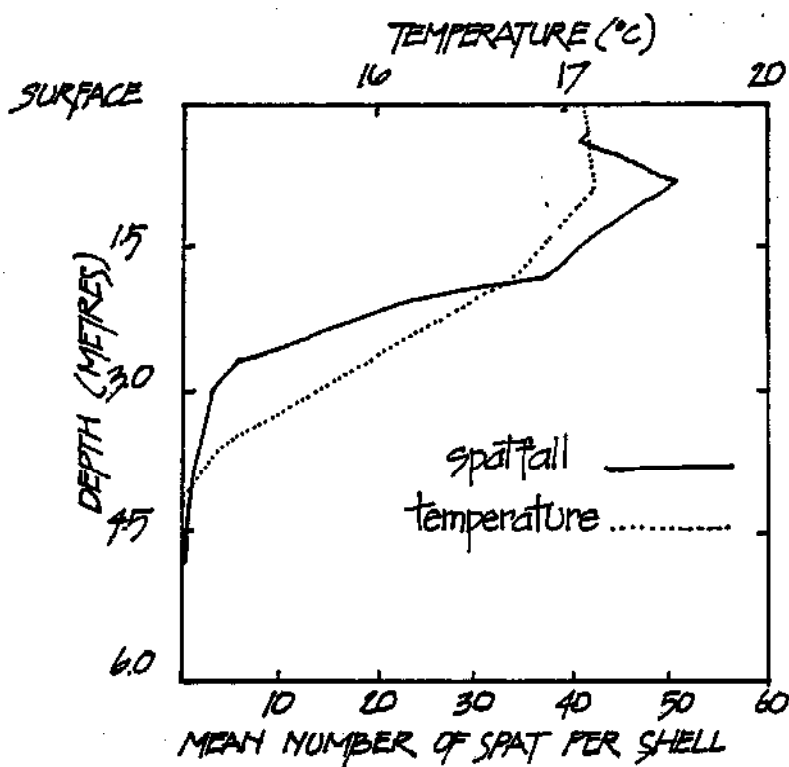

- 0° - under horizontal
- 45° - under surface of a 45° surface
- 90° - vertical
- 135° - upper surface of a 45° surface
- 180° - upper horizontal

The results of such a study are shown in 13.

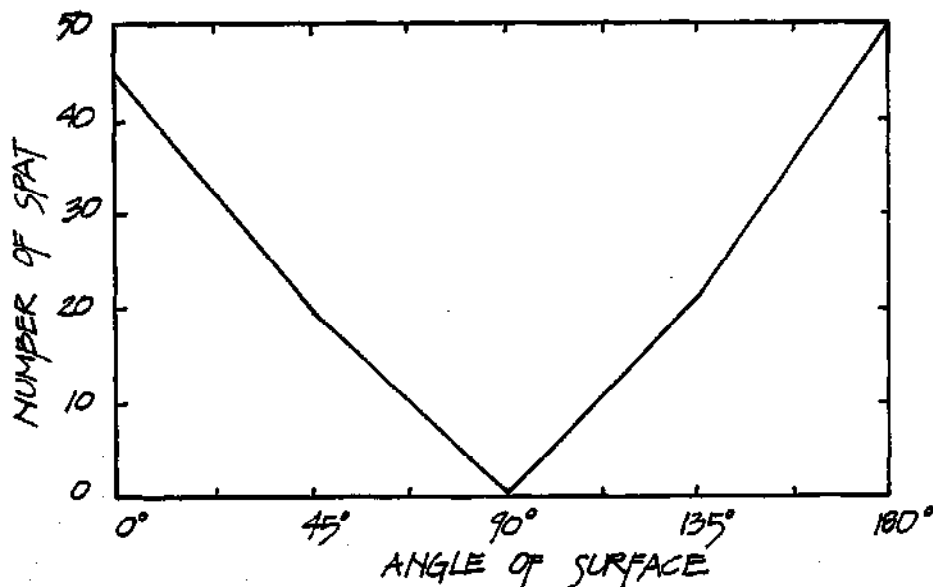

### 13 RELATIONSHIP BETWEEN ANGLE OF SETTING SURFACE AND SPATFALL. (PEHDRELL SOUND)

While many experiments were carried out with glass plates partly to alleviate the light factor, for practical purposes this is not necessary and ordinary collecting surfaces such as asbestos cement plates would be satisfactory. In general, most investigators have found better settlement on under horizontal surfaces. The general consensus of many studies is that colour of the collector has little or no effect on oyster settlement.

#### CLEANLINESS

Muddy or silted surfaces inhibit settlement as does a degree of fouling. It is thought by some that a thin film of fouling, mainly bacteria, is necessary for settlement. However, settlement does occur on clean uncontaminated cultch. Experiments with some species of oysters indicate cultch with some spat already attached collects better than cultch without spat. Also cultch that previously had a set that had been cleaned off will also collect better than unused cultch. However, unless larval abundance is extremely low, clean and new cultch is better.

#### ROUGHNESS OF THE SURFACE

Oysters tend to set on most surfaces except those that are oily, greasy, or soft. In other words, the surface should be clean and hard. Settlement will occur on surfaces as smooth as glass which has often been used in settlement experiments. Ground or roughened glass has been shown to collect better than unground glass. Most but not all plastics will collect and both sheet polyethylene and polyvinyl chloride have been used. Lime and cement coatings which provide a relatively rough surface have been used extensively and successfully on collectors such as roof tiles, and wooden panels.

If it is planned to use local materials, comparative tests should be carried out against such standard materials as old oyster shell, asbestos-cement plates, or cement coated materials. It is essential to consider both efficiency of spat collection and cost of the cultch when establishing a system of culture.



## growth

One of the more difficult oyster measurements is that of growth. Measurement of a single specimen may be done readily enough but the problem arises when attempting to determine average growth since there is considerable variability between specimens and where each oyster is grown in relation to the others. Therefore the number of animals used in a growth study should be fairly large - possibly 200 and the growth conditions for each one should be as alike as possible, such as is provided by a tray.

### MEASUREMENTS

Oysters are generally measured by length or by volume. The latter is actually the better measure for it combines length, width, thickness, and variation in shape in a single figure. Individual volumes may be taken and the methods are described on page 23. Oyster growers generally measure volume by the number of oysters required to fill a given space, such as a standard box or basket or by a specific measure such as a bushel (2219.36 cubic inches (0.036 cubic meters) (8 imperial gallons). The biologically correct dimensions of an oyster are shown in 2. However, most oyster growers recognize "height" in the figure as "length" because it is the greatest measurement. Reference should always be made to what the grower or potential grower understands in commonly used terms. Linear measurements may be taken with a caliper or with a measuring board. The typical caliper is the vernier as shown in Figure 14. It is a simple matter to place the oyster in the jaws in the correct orientation for the measurement desired. Instructions for reading a vernier come with the instrument. A measuring board with a sliding arm (15) is one of the more useful measuring devices and is relatively simple to make. Another device, handy in the field when alone with no one to record, is the graphical method. This consists of a board with an end stop. A piece of graph paper is butted against the stop and if the paper is not water-proof it may be covered or encased in transparent plastic. The oyster is placed against the end stop and the length or width or height is punched into the graph paper with a needle. The lengths, etc. may then be read off directly on return to the laboratory.

There are two main methods of determining growth. The first is to compare successive length-frequencies of a sufficiently large random sample of a group of oysters. Care should be taken to see the sample is representative and taken from a small area. Preferably the sample is returned to the sampling point or the same group of oysters may be measured repeatedly. Length frequencies may be graphed and means calculated. If there is growth, the modes of the length frequency curve will move along the abscissa of the graph. The other method is to mark or tag the oysters so they may be recognized and remeasured time after time. This is a positive direct method and individual variations may be noted. (16)

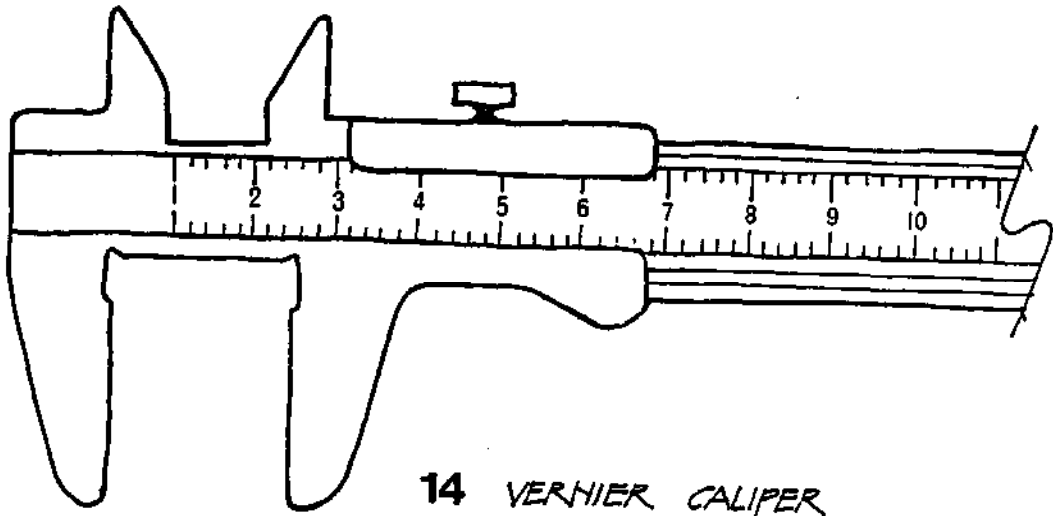

**14** *VERNIER CALIPER*

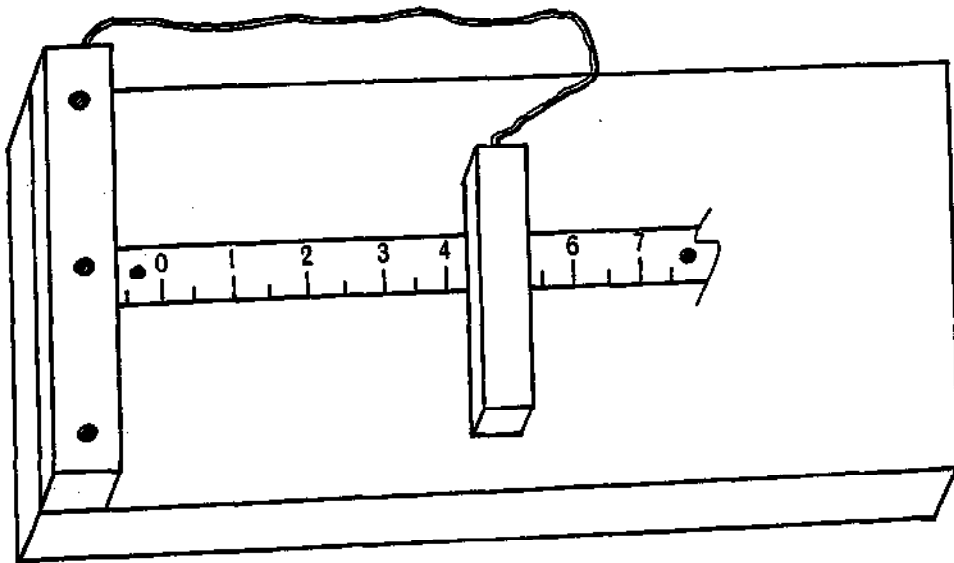

**15** *MEASURING BOARD*

Oysters may be tagged by glueing to the shell a numbered tag which now comes in many forms due to extensive fish tagging programs and there are many proprietary glues. Another method is to drill a small hole through the solid part of the umbo of the left valve and attach a tag with flexible stainless wire or monofilament nylon. Numbers may also be etched in the shell with an electric drill. In this case the etchings should be coloured and covered with a plastic spray.

As an additional precaution and check, the marked or tagged oysters should be notched on the ventral edge with a triangular file. This leaves a permanent mark on the shell and a notch of 2 or 3 mm. is sufficient, and the animal is not harmed. This serves as a permanent reference point in the growth study.

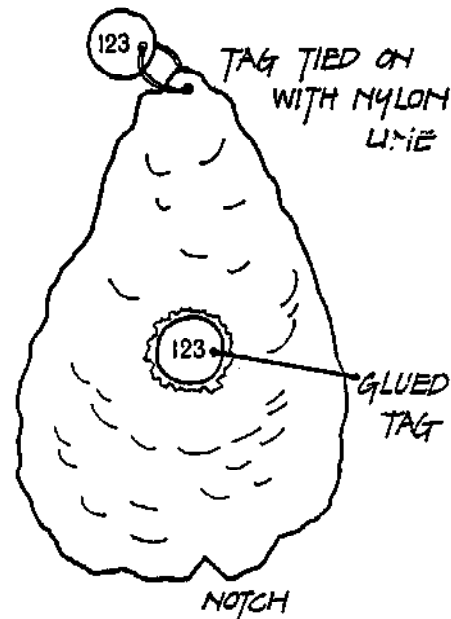

## 16 TAGGING METHODS



# oyster feeding

Though various species of oysters throughout the world have been much studied, relatively little is known about what actually constitutes usable food. Since the oyster is immobile and a filter feeder, it must accept whatever food comes to it in the water in which it is living. However, it can select, to a modest degree, the food it ingests but not all of that is digested. What it does ingest is well known but the nutritional value of the various components for an oyster have not yet been defined.

Whatever the actual food, whether it be microscopic flagellates, diatoms or fine organic particles (detritus) from the disintegration of animals and plants in the sea; there is usually an annual cycle of growth and "fatness". This indicates or reflects an annual cycle in the availability of food. In the temperate waters oysters are normally in best condition during the spring months of April and May and this coincides with the spring bloom of plankton which is associated in part with the increased amount of light and rising temperatures at this time of year. In the tropics, however, where light and temperature are relatively constant throughout the year, other factors are doubtless more critical in influencing condition of oysters and salinity is probably one of these. So far, there are insufficient data from the tropics to generalize on the seasonal condition changes.

It may seem at first glance that the abundance of plankton should be related to oyster growth and fatness, and no doubt this is partly true, but this is difficult and time consuming to ascertain. It is much more direct to let the oyster itself determine whether the amount of food available is sufficient for growth and fattening. The plankton present at one plankton sampling station likely bears little relationship to what is available to an oyster even a short distance away owing to current configurations. An oyster integrates the daily and seasonal variations in food supply and hydrographic factors effectively and the result of this is shown by growth and



condition factor measurements. Thus at the beginning of an oyster study, trays of oysters of approximately equal size, if not age, may be placed in cages or trays at a number of sites over the study area. The trays should be placed at equal tide levels if in the intertidal, or at equal distances below the surface if suspended from rafts or floats. The trays at each station should be replicated with at least 3 at each station to establish a measure of variation so the results from all the stations may be compared statistically. Each tray should contain between 50 and 100 oysters. In this way the productivity of an area in terms of oyster shell and meat production may be studied.



## condition factor

Condition is used to describe the degree of fatness of an oyster or the extent to which the meat fills the shell. It is presumed the oyster grows its shell to accommodate the soft body when at its largest. But the body (meat) size of an oyster may undergo fairly rapid changes. There are seasonal changes associated with the breeding cycle; the development of an increase in size of the reproductive glands (gonads) followed by a considerable reduction in mass after spawning; succeeded by a slow increase in body size due, in temperate waters, to an increase in glycogen. In some tropical waters this may in part be by-passed by redevelopment of the gonad without the significant glycogen phase experienced in temperate waters. However, the glycogen phase has been observed in tropical oysters. Changes may also be associated with seasonal or annual variations in food supply. Sharp salinity changes toward lower values may also contribute to loss of body weight.

Changes in the meat content of an oyster are important to the grower for it greatly affects the meat yield and therefore the financial return. Thus knowledge of the seasonal fatness cycle is most important for market purposes. It may be expected, however, that condition changes in tropical oysters are not as great as those that occur in temperate waters. If oysters are grown for the half-shell trade, condition is not quite as important for the oysters are sold as an individual oyster rather than on the basis of meat quantity. However, a "thin" oyster does not have the rich taste of a "fat" oyster so this may affect future sales.

### MEASUREMENT

Several methods of measuring the condition of oysters are used.

- (a) The relation of meat content to the internal volume of the shells gives an index. For example if 75 gallons (or pounds or kilograms) of meat are obtained from 100 bushels or 100 boxes or cans, then the return is  $75/100 \times 100 = 75\%$ . If more meat is obtained for the same volume then the percentage is higher and the return is better.
- (b) The number of oysters per gallon (or litre) compared with the number of oysters per net bushel (oysters less trash) may also be used for it is based on the following relationship. Total number of bushels (boxes or cans) x number of oysters per bushel (box or can) = total number of gallons x number of oysters per gallon.

or

$$\frac{\text{Total gallons}}{\text{Total bushels}} \times \frac{\text{number per bushel}}{\text{number per gallon}} = \text{fractional return} \times 100 = \text{percentage return.}$$

- (c) Meat production is related to the size of the oyster harvested, for the measure of volume (bushel, box, or can) is actually doing this (number of oysters x size of oysters). It should be kept in mind that the unit of volume, whether it is bushels, cubic feet, litres, box or can should represent the true or net volume which excludes the trash such as debris and empty shells. The number of oysters per gallon is not a measure of condition unless reference is made to the size of the oysters for the gallon could be made up of 100 large oysters in poor condition or 100 small oysters in good condition.
- (d) Another way of measuring condition is by the condition factor. This relates volume of the shell cavity (inside the two valves) to the weight or volume of meat in that cavity. The condition factor is generally obtained from the formula

$$\frac{\text{weight of dry meat} \times 1000.}{\text{volume of shell cavity}}$$

A high value - up to 150 - indicates a high condition while a low value of about 75 indicates a very poor condition. The procedure is to first obtain the volume of the whole oyster and this may be done either by displacement (17) or by weighing in air and then in water and the difference in grams is equal to the volume in millilitres (18). Next the oyster is carefully opened and the meat weighed after a specific draining time (e.g. 5 minutes) and dried to a constant weight in a drying oven held at a temperature of 95° - 98° C. The empty shell is then weighed in air and in water and the difference in grams is again the volume in millilitres. While not as accurate as the previous method, the difference between the whole weight and the shell weight (metric) in air gives a satisfactory approximation of the internal volume.

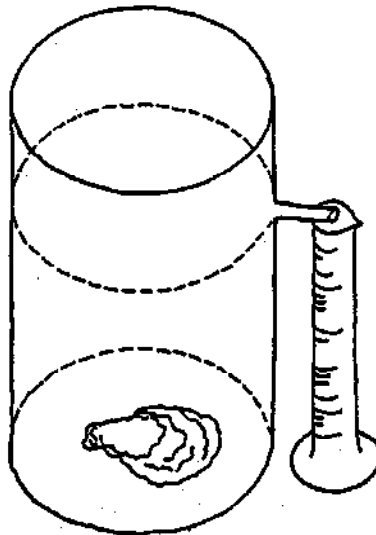

17 APPARATUS FOR MEASURING VOLUME OF OYSTERS BY DISPLACEMENT

- (e) Another method to determine the whole volume of an oyster is to measure the apparent increase in the weight of water after an oyster on a mesh tray is placed in a container of fresh water placed on a weighing scale (19). The difference between whole volume and shell volume is the internal shell (cavity) volume. This value is divided into the dry weight of the meat and multiplied by 1000 to give the condition factor.

Condition factor may be determined on an individual basis with single oysters or with a sample of several with total volumes and weights. In this case larger containers and scales are required. One of the main problems in condition factor studies is the determination of the sample size required for valid results. This is done by measuring condition factors of about 25 individual oysters for an estimate of variation. When this is known, the data may be applied to a statistical formula to calculate the number of oysters required.

18 APPARATUS FOR MEASURING VOLUME OF OYSTERS.  
WEIGHING IN AIR AND IN WATER.

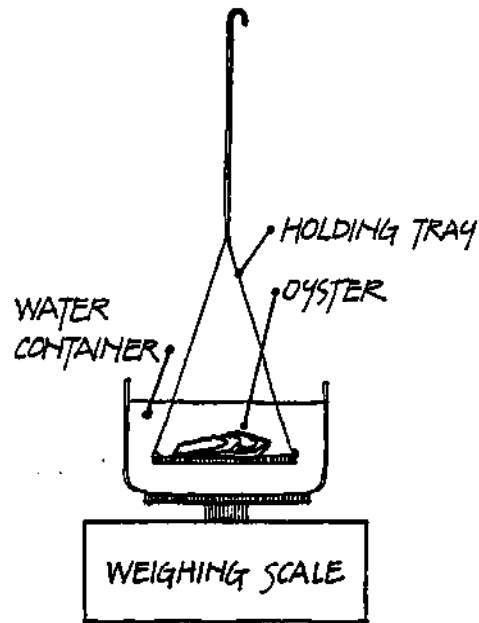
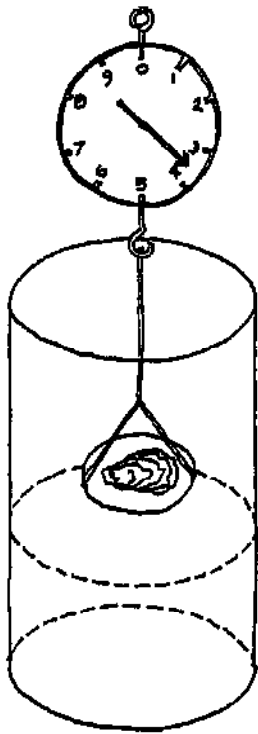

19 DETERMINATION  
OF  
OYSTER SHELL  
VOLUME



## fouling

This includes both animals and plants (algae) which become attached to oyster cultch and growing oysters. Often fouling is more of a nuisance than a serious problem and care must be taken not to over-emphasize its importance. Growing oysters can withstand a considerable degree of fouling before they become harmful enough to require control. A rough rule of thumb for control to become necessary is when the volume of fouling nearly equals or exceeds the volume of mature oysters. Heavy fouling may cause mortality, particularly in seed, reduced growth rate or competition for space on the cultch. The main fouling organisms causing problems are barnacles, mussels, tunicates, tube-dwelling polychaetes and hydroids.

Fouling is generally minimal and is rarely a problem when oysters are grown intertidally, either on the bottom or off it. The main fouling species in this case is the barnacle which generally has a specific zone in the tidal shore and it may be necessary to position the oysters below it if possible. Most fouling problems occur when

the oysters are continuously submerged as in floating culture. There are three main methods of attacking the fouling problem.

1. Know the annual fouling sequence and culture around it.
2. Culture away from the area of fouling.
3. Destroy the fouling organisms.

#### 1. FOULING SEQUENCE

This involves a study of the seasonal fouling sequence. For instance when a species of barnacle has a distinct settlement period every year then the oyster seed should be suspended from the rafts only after this period. The barnacle set of the next year will find the oysters are large enough to cope and the barnacles are then a nuisance rather than a danger.

#### 2. CULTURE AWAY FROM THE AREA OF FOULING

If a barnacle or any other fouling organism is known from study to settle and live at a specific depth, the oysters may be suspended above or below (or both) this depth. In the tropics oysters are most often grown in estuaries where there is often a well-defined salinity gradient with the lower salinities up-river. Oysters (particularly those of the genus *Crassostrea* are able to live and grow in a wide range of salinities (10% to 30%). Most major fouling organisms will live only in waters of high salinity areas so the strategy is to collect seed in the higher salinity breeding area and grow to maturity up the estuary in waters of lower salinity where fouling is minimal or non-existent. This is usually at or about the 15% salinity level.

#### 3. DESTRUCTION OF FOULING ORGANISMS

This may be done only by removal of the oysters from the water and applying some treatment to the fouling organisms. This process is costly in terms of labour and oysters lost in the lifting and lowering. Often simple air drying is sufficient to kill the fouling organisms, particularly soft-bodied ones. The time of exposure can only be found by trials. Normally oysters can close their valves tightly and withstand a greater length of exposure to the air than most other marine animals. Physical removal of fouling organisms by hand is normally too costly. Washing down with a high pressure hose may remove some but not all organisms. Another alternative is to dip the oysters in a solution toxic to the foulers but not the oysters. Freshwater is often adequate, or 10-20 minute dips in a saturated brine solution may be used. Dipping briefly in a 1 - 2% copper sulphate solution, followed by air drying, is also effective. There are a number of other chemicals, but in general the difficulties relating to other organisms such as fish and the costs for equipment and labour make dipping methods a last resort.

Fouling studies are carried out by exposing test materials for varying time periods in different locations and at various depths. Materials depend on the specific purpose of the investigation. Preferably the material to be used as cultch should be used. So often this is shell and the variation in shape and size makes it difficult to make quantitative measurements. A material frequently used is asbestos-cement sheeting cut into 14 cm. x 10 cm. squares - a size permitting examination with a stereoscopic microscope. Wooden panels the same size are also used and this gives the advantage of determining borer attack but the disadvantage of a surface not usually used as oyster cultch in addition to the possibility of complete destruction by the borers.

The exposure designs are many and some are quite complicated. A fairly simple one that answers most questions without the use of too many panels is one where 6 numbered and one unnumbered panels are exposed. Once per month No. 1 panel and the unnumbered panel are removed for examination and replaced with the new panels. At the end of the second month No. 2 panel and the unnumbered one are removed and replaced. The unnumbered panel provides information on monthly settlement of fouling organisms and the numbered panels give the information for cumulative periods up to 6 months

for two separate half-year time spans. For truly quantitative studies replication would be required at each station and at each depth. If the test panels prove acceptable to oysters, information on spatfall periodicity, the effect of fouling on settlement as well as subsequent interaction between the oysters and other organisms can be obtained.



## predators, pests, disease & parasites

### PREDATORS

During the planktonic stage larval oysters are consumed by many organisms. Among these are filter feeding invertebrates such as adult oysters and barnacles. Small fish with filter feeding mechanisms like herring are also important predators.

Adult oysters have several types of predators and among these are fish, crabs, snails and starfish and flatworms. Predator protection means additional expenses in the production cost of oysters and should be avoided if possible. Careful experiments are needed to determine levels of predation. It may be less costly to accept a certain degree of predation than to institute protective devices.

#### Fish

Among fish that eat oysters are eagle rays and bat rays as well as drum fish. There are many types of tropical fishes with flattened crushing teeth adapted for coral feeding, that are able to break the shells of at least the younger oysters. Many of these have not yet been identified. In parts of France and the United States protective fences to keep out predators are used mainly with bottom culture. Pointed stakes driven into the bottom also prevent ray-type fish reaching oysters on the bottom. Suspended culture requires protective netting. Depending on kind and abundance of fish it may be possible to reduce numbers by fishing close to a point where the trouble caused by them is tolerable.

#### Crabs

Crabs of a variety of species, but mainly the cancroids with powerful pincers are the main predators; again particularly on young oysters whose shells they are able to crack open. Evidence of crab predation is shown by the jagged valve edges of the opened shell (20). It may be necessary to protect young oysters by netting devices. Also, as with fish, it may be possible to reduce the population, in this case by trapping. The local fisherman's crab traps are probably the best, but failing this a simple form may be constructed from laths or strips of bamboo as shown in (21). Records should be kept of the number and size of crabs taken in traps by time interval and per trap to determine the effectiveness of the program.

## Snails

Predator snails (gastropod molluscs) are also called drills because they penetrate the shell of the oyster by drilling in it a small circular hole with a rasping apparatus they can protrude from the mouth. It is also used to rasp out the oyster meat. They can quickly drill through the thin shell of young oysters. In a seed bed this may cause considerable mortality in a short time compared with a bed of mature oysters. The egg cases of oyster drills are small capsules usually about 5 mm x 2 mm attached in groups to some solid substrate. (22, 23) Up to 50 eggs may be deposited within a single capsule in which they develop and hatch as young shelled snails that crawl out through an aperture at the top of the case. Fortunately most predatory snails do not have larvae by which they may be widely distributed. Oysters on suspended culture are therefore protected as long as the strings, bags or trays do not touch bottom. However, bottom or rack culture systems are vulnerable to attack. The most effective control method is to destroy egg capsules and collect the adults from within the growing area. This may be done by simple hand picking or by trapping. A snail trap is simply a small wire mesh basket baited with fish or some other flesh. As with crab traps good records should be kept so it may be determined whether the trapping is reducing the population effectively.

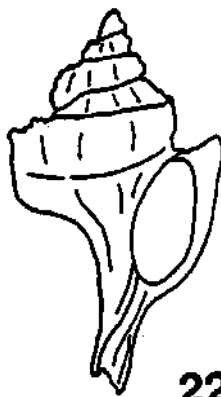

22 GASTROPOD OYSTER DRILL & EGG CASES

20 OYSTER SHELL SHOWING INDICATION OF CRAB DAMAGE.

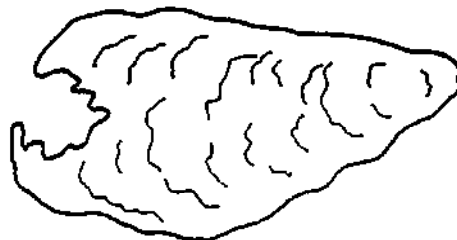

21 SIMPLE CRAB TRAP

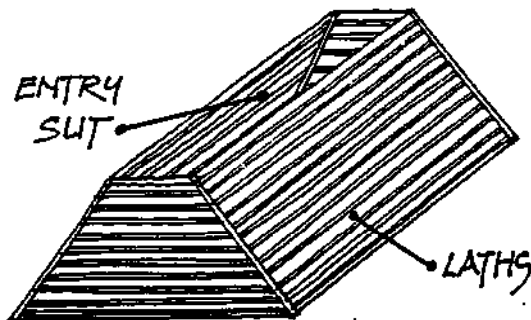

23 GASTROPOD EGG CASE (ENLARGED)

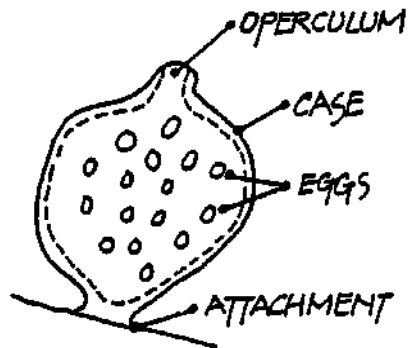

### Starfish

Starfish may be serious predators of oysters which are opened partly by force exerted by the arms of the starfish and partly by its ability to protrude an extrusible stomach through very small openings in molluscs and begin digestion. However, they are readily controlled either by regular picking or destroying them with a teaspoon of quicklime or carbide on the body which then disintegrates by the corrosive action of the chemical. Cutting starfish and leaving them in the oyster bed is of little use because they have considerable powers of regeneration.

### Flatworms

Some flatworms, also called wafers or oyster leaches, are thin flat oval shaped worms that are able to drill and thus kill oyster spat up to about 1 cm. in diameter. These are a danger to spat and may be eradicated from spatting oyster cultch by dipping in fresh water for about an hour.

### PESTS

These are organisms associated with oysters that seldom cause death but create problems either in the form of irritations, competition for food or hinder the oyster from obtaining food. Among these are boring sponges, boring sea worms, boring molluscs, slipper shells, commensal crabs, sea squirts (tunicates), barnacles and other fouling organisms.

### Boring Sponges

These are sponges which are able to penetrate and honeycomb shells of oysters to create a series of galleries that weakens the shell. It is seen on the outside surface of shell as tiny circular holes filled with sponge usually yellow in colour. The sponge may, in time, reach the inner surface of a valve so the oyster must secrete additional amounts of nacre and thus use up energy. As a general rule the boring sponge, very often of the genus *Cliona*, is most often seen in older oysters. Thus the obvious answer, if possible, is to harvest oysters before the sponge becomes a problem, otherwise there is little to be done. Oysters with boring sponge are difficult to open cleanly because the shell breaks from the slightest pressure.

### Boring Sea Worms

These are usually of the genus *Polydora* and some species gain entry at the edge of the shell where a U-shaped burrow is formed. Other species allow the shell to overgrow the mud tube they form. In small numbers they cause no great harm beyond causing the oyster to expend energy in creating additional shell and are unsightly. These worms are usually associated with muddy bottoms and they are nearly always less of a problem with rack or suspended than bottom culture. The worms may be destroyed by exposing the oysters for nearly a day in fresh water.

### Boring Molluscs

There is a group of molluscs, the pholads, which are able to bore into and live in the burrows in shell or limestone. In some tropical areas they create the same problems in oysters as the boring sponge. Here again little can be done to prevent the attack.

### Commensal Crabs

These are pinnotherid or "pea" crabs that gain entry when very small to the shell cavity of oysters and other molluscs through the inhalant current. They grow within the shell and may attain a length of up to 2 cm. They are pale in colour, with soft shells and males are generally much smaller than the females. These are called commensals for the oyster and the crab are considered to be mutually beneficial to each other. However, the advantage here appears to be slightly on the side of the crab for in some cases they may damage the oysters' gills. Nothing may be done to reduce the incidence of the pea crabs which have no effect on the edibility of the oyster. Indeed, pea crabs themselves may be eaten.

## DISEASES

Oyster diseases which have decimated populations of oysters occur in various parts of the world. However, the effects are generally not permanent although recovery may take a number of years. These diseases are mainly due to microbes, fungus and protozoans. Initial evidence of most diseases is the presence of yellow pustules on the surface of the oyster body and which stain the adjacent shell.

Diseases of shellfish are most difficult to diagnose and there are several of long standing where the causes have not yet been positively identified.

Most diseases can be studied adequately only by experts whose assistance should be sought. However, it is possible for the culturist to learn enough about the disease sequence that the culture system may be modified so the effect is minimal. Such factors as seasonal occurrence, tidal level, age or size of oysters affected, salinity or temperature tolerances should be examined. In some cases recovery of an oyster culture has been possible only through the development of resistant strains; in others actual treatments such as dipping in fungicides have been effective.

Blooms of dinoflagellates which cause the so-called "red tide" phenomenon have also been responsible for catastrophic molluscan mortalities. Little can be done to control red tides but there have been instances where oyster culture rafts have been removed from an area where "red tide" is seen to be developing. It is important to keep good records of any occurrence, however short, of red tides that are observed. However, development and disappearance is so rapid they often escape detection.

## PARASITES

Both flatworms and tapeworms occur in oysters in various parts of the world. In some cases mortality may be caused but the parasites are seldom the primary cause. Most often the interference is with growth or reproduction. There appears little to be done to control such parasitic infection. Expert advice might be obtained in extreme cases.

The main crustacean parasite is the copepod Mytilicola (24) which is a reddish elongate form up to 4 or 5 mm in length. It inhabits the small intestine of some bivalve molluscs and is readily observed. If present in sufficient numbers, about 5 or more, there may be debility or even mortality. Where Mytilicola occurs, risk of infestation is high with molluscs living on the bottom but this may be reduced by off-bottom culture.



24

PARASITIC COPEPOD

Mytilicola  
(ENLARGED)



# CULTURE



## spatfall prediction

If oyster spat collectors are placed in the water too soon before a spatfall they may become silted over and fouled. This is particularly important in temperate waters where the breeding season is short and may not always be successful. Therefore the cultching time is critical. This is seldom the case in the tropics where breeding usually occurs regularly over a long period of time. Only a general knowledge of approximate time of the peak period or periods is then necessary. But even here there may be instances, such as silting and fouling problems, where more precise spatfall predictions would be of some advantage. In most cases oyster spawning is associated with temperature fluctuations (temperate waters) or rainfall (tropics) and these in turn depend on weather conditions for which long term predictions are seldom precise enough to be of use.

Most spatfall predictions are therefore based on a study of larval broods from plankton sampling. The presence of early stage oyster larvae indicates a recent spawning has occurred and the numbers show whether this is to be a major or minor spawning. This is known mainly from previous experience. A knowledge of larval growth rates and larval period at the prevailing temperature will enable a prediction of the approximate time, within a day or so, of spatting. Usually, the industry is given a preliminary warning when spawning occurs. The larval brood is followed by plankton sampling and based on the trend in reduction of numbers and prevailing weather conditions, a firm prediction is made of the approximate time and intensity of spatting, early enough to allow the industry time to expose cultch. In temperate waters where the larval period of *Crassostrea* is about 18 to 21 days, the final prediction is given about a week before the spatfall. This amount of time may not be possible in the tropics where the larval period may be shorter.

Spacing of sampling stations will depend on local topography, current configuration and possibly on the distribution of adult wild populations. For instance, in a bay 5 miles long and 1/2 to 3/4 miles wide, ten sampling stations provide information adequate for predictions of a fairly high accuracy. Daily sampling at these stations gives optimum information but this is seldom possible and the eventual frequency, every other day or every third day will depend partly on the length of larval life and partly on previous experience in forecasting. The type of sampling depends on equipment available and

this is discussed in another section. The time of day for sampling will depend on a knowledge of diurnal larval movements and of the tidal situation. If there are large tides (considerable range) one of the slack water times may provide the most uniform conditions and if there is little or no tidal range, then the same time each day may be suitable. The best sampling times may be determined eventually as a result of experiment and experience. In general, lacking more sophisticated sampling devices, a vertical tow may be most suitable. Synoptic sampling (samples taken at all stations simultaneously), would be ideal but this is rarely possible so succeeding samples should be taken as rapidly as possible.

As an example, on July 15, plankton samples from 5 minutes surface tows contained straight-hinged oyster larvae indicating a minor spawning had taken place on or about July 12, so further spawning might be expected. Quantitative samples on July 16 taken at 10 stations over a period of 2 hours near low water slack contained an average number of 125 straight-hinged and early umboned larvae per litre. The samples of 100 litres each were taken at a depth of one metre with a plankton pump at a depth of one metre. On July 19 a similar series of samples contained an average of 87 early umboned larvae per litre. Further samples on July 21, 24 and 27 contained averages of 63, 58 and 35 larvae per litre respectively. The weather was fairly stable and showed no signs of deterioration with water temperatures remaining at about 21°C. The graph showing the relationship between temperature and the length of the larval period indicated that at 21° the larval life should be about 23 days so the industry was notified that settlement could be expected about August 8. Larval numbers, although showing decreasing numbers, were still fairly high with a fairly steady decrease rather than sudden changes, indicating stable conditions for larval development. With about 10 days to settlement and taking into account the rate of decrease in numbers it was reasonable to suggest that the settlement would be of commercial magnitude (1 spat per 4 square centimetres) for past experience in this area had shown that one advanced stage (eyed) larvae per 4 litres would provide a settlement of one spat per 20 square centimetres.

By August 1 the number of larvae, now averaging 225 m. in length, had become reduced to 20 per litre and 5 days later the average was 10 per litre. Test collectors put out on August 1 showed a few spat when examined on August 5 and daily inspections thereafter indicated peak setting occurred between August 9 and 10 with an average settlement of 2 spat per square centimetre. On August 6 the mean number of larvae was 9 eyed larvae per litre. Cultch exposed at or near each of the 10 sampling stations showed a range in setting intensity between one spat per 15 square centimetres to 3 spat per square centimetre. This prediction turned out to be fairly accurate but it was not a difficult one because of excellent and uniform weather conditions, a relatively good spawning and a single larval brood.

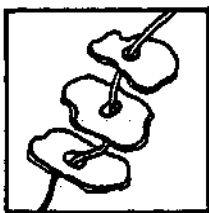

## spat collectors-- collection

In the collection of oyster spat, the substrate provided for attachment of larvae is called cultch. To collect oyster seed, cultch is placed in the water at the appropriate time and place. After settlement, spat are usually allowed to grow for a time before being moved to nursery or growing areas. There are many materials to which oyster larvae will attach but few are suitable as cultch from practical and economic points of view. The basic requirement of an oyster cultch is that it be clean and hard. In nature materials on which oysters are most often found are rock, live oysters, dead mollusc shells, barnacles, brush and mangrove roots. In addition they

may be occasionally found on many other materials such as boat bottoms, docks or any other material that is clean and hard and immersed in the sea when and where oyster larvae are present.

Cultch for organized culture must be readily available in quantity, inexpensive, not too heavy, and capable of being packaged into units that can be easily transported. Also the packaged units should be made up in such a manner that allows a good water flow for larvae to reach all individual pieces of cultch. In established oyster cultures such as in North America, Japan, etc. the commonest cultch is the mollusc shell itself, usually oysters or scallops. These are packed into strings by punching a hole in each valve and stringing them on wire or on cord. (25) Strings are usually 1 - 2 metres in length and there are semi-automatic punching and stringing machines. Shells may also be packaged into bags of chicken wire or old fish netting. More recently tubular plastic mesh (trade names such as "Vexar" or "Netlon") has become available and is now in wide use for packaging shell cultch. (26) In the case of bags the diameter must be small enough to allow good water circulation to the centre and this will depend partly on the size and shape of the shells being used. Small flat shells tend to pack tightly together so the diameter of the bag must be quite small.

In Europe the traditional cultch is roofing tile which is dipped in lime so the oyster seed may be detached by scraping off the lime covering. (27) Wood in various forms is also in fairly wide use in Australia. Here the cultch takes the form of sticks which are dipped in a pitch-tar mixture to provide a hard surface on the wood. In Canada wood veneer made into rings and dipped in cement has been used (27), as have cardboard egg separators dipped in cement. Another material in fairly wide use is fibro-cement (asbestos-cement) either in a plate form or in long strips. Flexible plastic forms, sometimes dipped in cement, are coming into use. A specially manufactured artificial cultch that automatically self-disintegrates in about a year is being developed. (29) Bamboo, if well dried, is a good collector as are coconut shells especially if dipped in a pitch-tar mixture or cement. The key to the cultch problem lies in the use of the cheapest local product available commensurate with its usefulness or adaptability as a collector for the specific type of culture.

#### METHODS OF EXPOSING CULTCH

For the collection of seed there are three basic plans for exposing cultch to make it available to larvae:

1. Loose cultch pieces or packages spread on the bottom.
2. Intertidal racks.
3. Raft suspension.

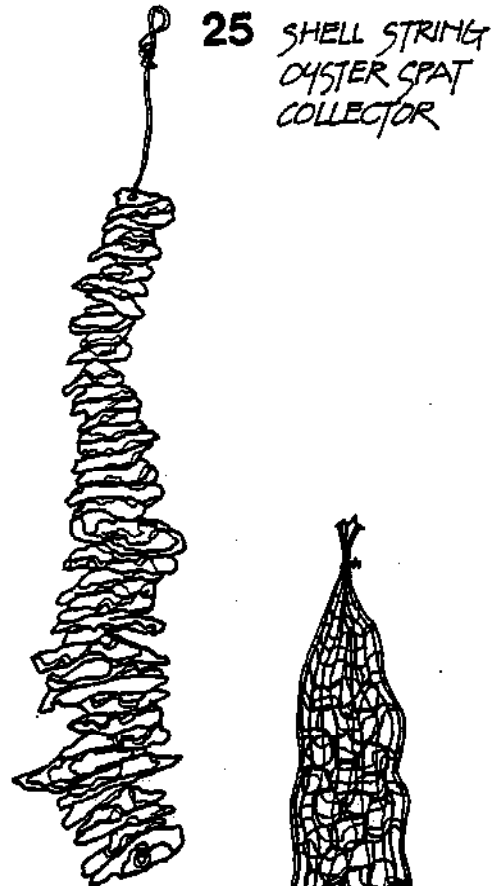

26 MESH BAG OYSTER SHELL SPAT COLLECTOR



### 1. Loose cultch.

Cultch may be spread or placed on bottom in either subtidal or intertidal areas known by experience to produce good sets. The bottom should be firm and relatively free from silt, otherwise the cultch will sink into the bottom and so reduce the setting area. This is a less efficient method than with racks or rafts but it is generally less costly. Only testing and experience will determine how the two factors balance. If there is any danger from silting, the cultch should be exposed only shortly before setting is about to occur or during the peak setting period. This implies either detailed knowledge of breeding seasons or a spatfall forecasting technique. The main deficiency of bottom cultch is the difficulty in recovering it if there is a setting failure; particularly if it is loose cultch. This method also presents a greater danger from predation from gastropod drills or sea stars than the other two methods.

### 2. Intertidal racks.

Intertidal racks require construction in a form to hold packaged cultch and involve some knowledge of vertical setting patterns. Efficiency of intertidal racks for spat collecting is greater than that of the bottom but not as high as raft collection. In the event of a set failure, recovery of cultch is readily accomplished or if there is sufficient protection from wave action the cultch may be left until the occurrence of the next set.

### 3. Raft suspension.

Although raft collection is the most efficient method because of high spatting intensity, growth rate, survival and freedom from predators, it is also the most costly. However, there are no tidal problems to consider when the cultching operation is in progress.

### 27 ROOFING TILE OYSTER SPAT COLLECTOR

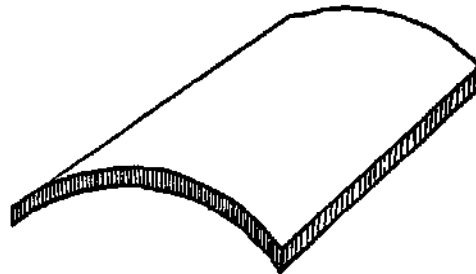

### 28 CEMENTED WOOD VENEER OYSTER SPAT COLLECTOR

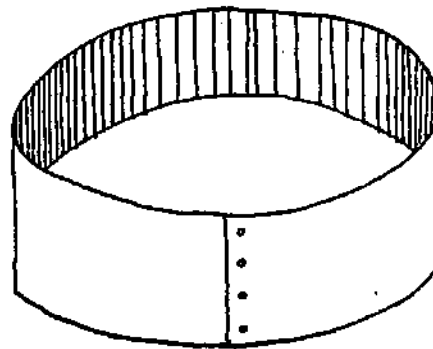

### 29 ARTIFICIAL OYSTER SPAT COLLECTOR

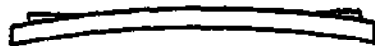

SECTION

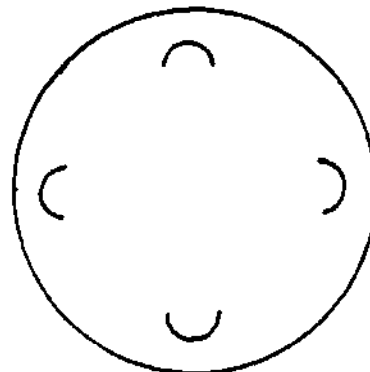

PLAN VIEW



# site selection

Most frequently advice from experienced culturists will be available to decide on the most appropriate system of culture for any given area. This decision will be made on the basis of factors such as those given in Table 3 - relative to the various standard culture systems. The factors applicable to each system are checked off. It is also possible to replace the checks with quantitative evaluations of the various factors in the left hand column. This could be on a scale of 5 and in the case of fouling the scoring might be as follows:

Bottom		Rack			Raft		Stake
Intertidal	Subtidal	Tray	String	Stick	Tray	String	
5	1	4	4	4	1	1	4

Fouling on rafts is always higher than in any other type of culture so a minimum value is given. This may also be true of subtidal bottom culture. Intertidal bottom culture tends to have minimum fouling so a high value is given. Rack culture is liable to slightly more fouling than intertidal bottom culture so an assessment of 3 or 4 according to experience in the area might be given. If this is done for the factors as listed in Table 3, the sum of the numerical assessment gives a quantitative comparison of the several types of culture that may assist in supplementing decisions based on other considerations such as economics or availability of materials.

## ECONOMICS

The economics of an oyster culture system depends mainly on the equipment costs and on the amount of labour required, as well as the scale of the operation.

**table 2** Minimum Equipment Requirements for Various Types of Culture

	Bottom		Rack			Raft		Stake
	Intertidal	Subtidal	Tray	String	Stick	Tray	String	
Minimal	tongs or dredges	trays	wire	wood	wood	raft anchors	raft anchors	wood for stake - nails
	boat	for racks	wood for racks	wood for racks	wood for racks coating	ropes trays boat	rope wire boat	

This list shows raft culture requires most equipment. The least costly is bottom intertidal, followed by stake. Rack culture with sticks is next because in most instances the main cost is wood and this is generally available in the form of mangrove or bamboo.

**table 3** Factors Relating to Various Types of Culture

	BOTTOM		RACK			RAFT		STAKE
	Intertidal	Subtidal	Tray	String	Stick	Tray	String	
Temperature	x	x	x	x	x	x	x	x
Salinity	x	x	x	x	x	x	x	x
Depth		x				x	x	
Substrate	x	x						
Tidal level	x		x	x	x			x
Tidal range	x		x	x	x			x
Wave action	x		x	x	x	x	x	x
Tidal flow	x	x	x	x	x	x	x	x
Turbidity	x	x	x	x	x	x	x	x
Navigable waters	x		x	x	x	x	x	x
Fouling	x	x	x	x	x	x	x	x
Predation	x	x	x	x	x	x	x	x
Pollution	x	x	x	x	x	x	x	x
Growth rate	x	x	x	x	x	x	x	x
Access	x		x	x	x			x

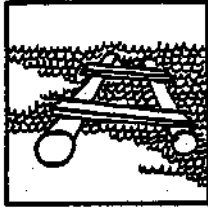

# culture

Oysters occur naturally in the wild. These are harvested but this is essentially a fishing operation. When wild oysters have been gathered and those too small for market are returned to the sea for further growth, a first step towards a culture or farming system has been made. The next move is to purposefully collect young oysters (seed) and under control, grow them to market maturity by one or a combination of several methods of culture.

## BOTTOM CULTURE

Bottom culture, as the name implies, is where the oysters are grown directly on the bottom, either intertidally or sub-tidally. Bottom intertidal culture requires reasonably firm bottom so the oysters will not sink into it too deeply. The next requirement is for the ground to be at the correct tidal level so the oysters are within the lower two-thirds of the tidal range. Protection from wave action is also necessary, otherwise the oysters, particularly seed, may be washed into windrows or even off the bed. Since most potential areas for oyster culture in the tropics are in estuaries with particularly soft muddy bottoms, this type of culture is not generally suitable. Also, predation on the bottom is generally severe in the tropics. In subtidal bottom culture, tidal level and protection from wave action are of no concern. Thus bottom consistency and predation are the two main factors. However, harvesting problems are increased and hand tongs or dredges (30, 31) are necessary. Although there may be exceptions, bottom culture in the tropics has, in general, doubtful potential, particularly in estuaries.

The initial step in bottom culture is planting seed which is most often on a collector suited to the particular type of bottom. If seed collected on heavy oyster shell is planted on soft bottom, considerable mortality is certain to occur due to sinking in the mud and sand. Most frequently certain grounds with a firm bottom are set aside to receive seed. When it attains a size large enough to keep itself free of silt, it may be transplanted to growing or to fattening ground, which may be less firm. In temperate waters time to harvest may be between 3 and 5 years for oysters of the genus Crassostrea. In the tropics it may require only 6 to 12 months to market size.

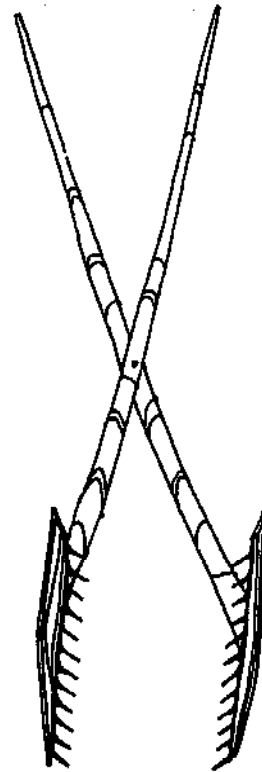

30 PAIR OF  
OYSTER  
TONGS

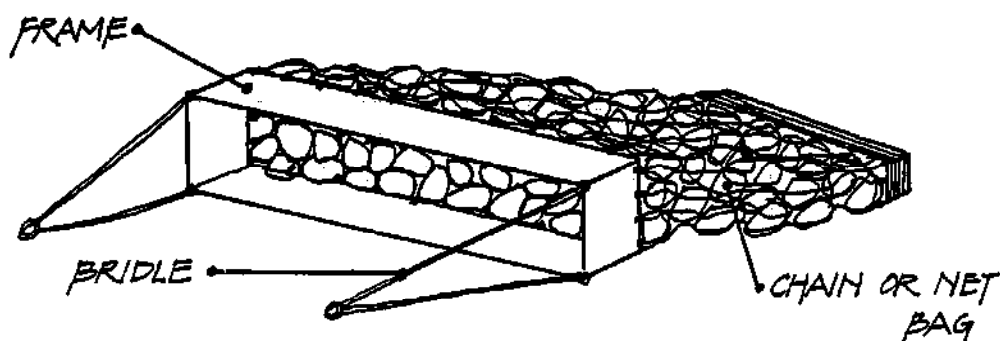

### 31 OYSTER DREDGE

There is a considerable amount of literature on systems of bottom culture such as Cahn (1950), Loosanoff (1965), Quayle (1969), and many others.

#### OFF BOTTOM CULTURE

Off bottom culture is a method whereby the growing oyster is held off the bottom by various means. It is used where bottom conditions are unsuitable because of softness, exposure to wave action, tidal level or other factors. Suspended oysters also generally grow more rapidly than those on the bottom and have better condition. Because the oyster or oyster seed must be packaged in some manner for suspension, and some provision made for suspension, this system is usually more costly than bottom culture. However the advantage of more rapid growth and better condition may compensate for the cost difference.

Off bottom culture lends itself to a variety of methods such as:

1. Raft or suspended culture
  - (a) Tray
  - (b) String
2. Rack
  - (a) Tray
  - (b) Stick
  - (c) String
3. Stake

Within these divisions there are many modifications.

#### 1. Raft or Suspended Culture

In this system oysters are suspended from floating structures such as rafts. (32,33) The oysters may be held in trays or attached to vertical strings. The raft may be of any shape and made from a variety of materials, such as logs of various species of trees such as balsa, bamboo, cedar, etc. or the flotation system may be of oil drums coated with a pitch-tar mixture or cement. Styrofoam by itself or coated with ferrocement or wood, plywood pontoons covered with fibreglass; and manufactured polyethylene floats are used. In the tropics extensive use of bamboo, both for flotation



and for structure is advocated.

### 32 OIL DRUM OR FLOAT-TYPE OYSTER RAFT

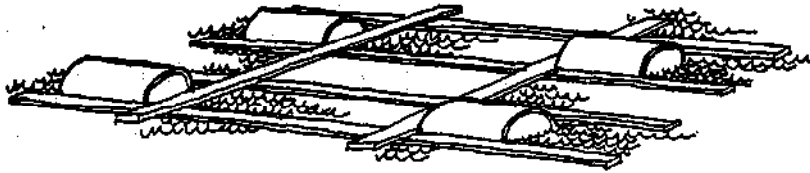

### 33 LOG TYPE OYSTER RAFT

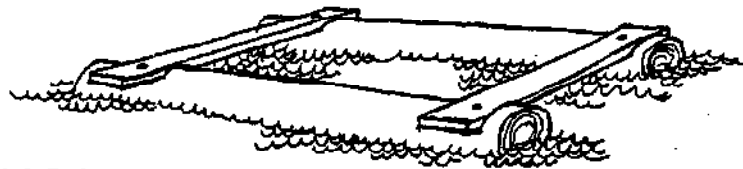

An alternative to the raft for flotation is the long line system (34) whereby a series of small floats are joined by a cable which is anchored at both ends. The trays or strings are suspended from the cable. This system is fairly flexible for it may be used in situations where the amount of wave action would prohibit the use of rafts. The small floats may be of wood, bamboo, oil drums, glass balls or of manufactured plastic floats. Discarded automobile tires filled with styrofoam or polyurethane foam-in-place are also used.

### 34 LONG LINE SYSTEM OF CULTURE

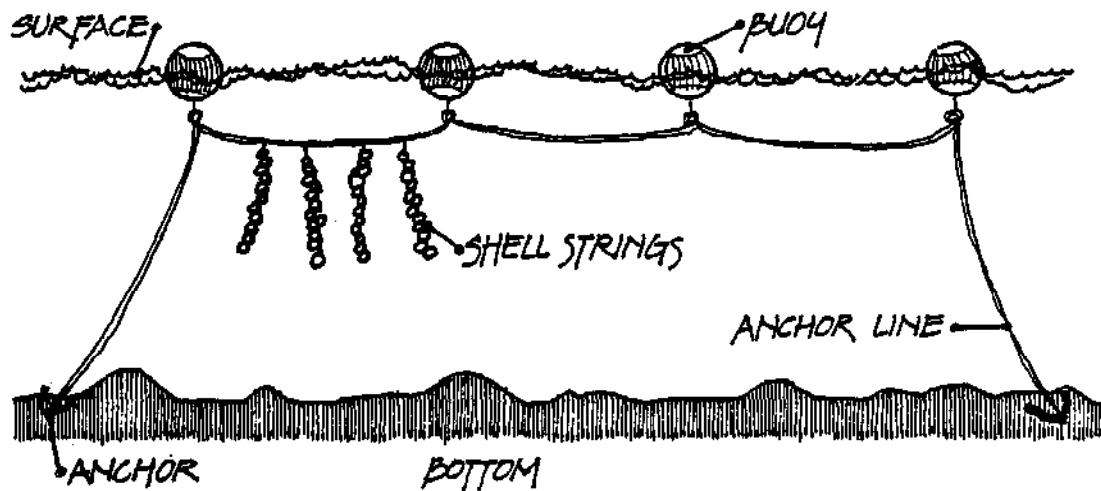

(a) Trays

Trays are used (35) if single well-shaped oysters are required for a particular market such as the half-shell trade. However, this is a costly method of culture partly because of the initial investment in trays and partly because of the necessity to keep the trays cleared of fouling. If this is not done, the flow of water over the oysters is reduced with subsequent reduction in growth. Manufactured trays of polyethylene are available but suitable trays may be made of either wire or plastic mesh alone or in conjunction with a wooden frame. Tray culture has definite limitations, particularly in the tropics where fouling is generally quite extensive. Trays may be stacked closely together or separated from one another to allow more circulation.

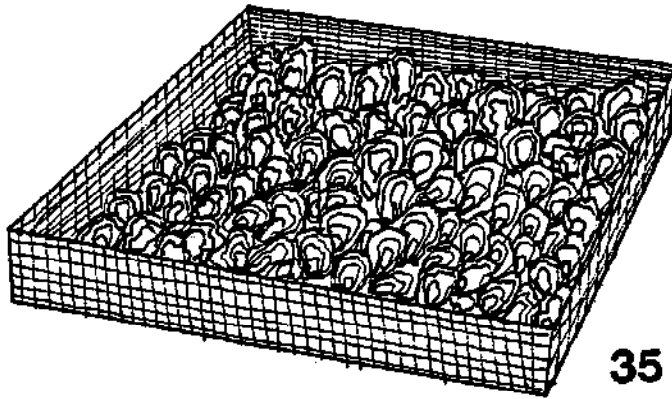

35 OYSTER TRAYS

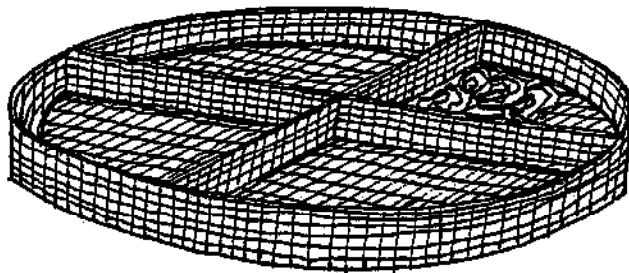

## (b) String Culture

This is the system in wide use in Japan and Korea. Individual pieces of spat collectors (cultch) with spat already attached are strung on galvanized wire. Other materials such as locally woven rope, synthetic cords, monofilament nylon, etc. are used. The individual pieces of cultch are held 8 - 12 inches apart either by separators such as bamboo sections or plastic pipe threaded on the line between collectors. (36) If wire is used a twist in it will keep the collectors apart. (37, 38) These strings may be as long as desired depending partly on the depth of water, the hydrography and the availability and efficiency of lifting machinery. Strings with more than about 10 collectors are difficult to lift by hand. The prepared strings are hung from the float, whether it be a raft or a long line until the oysters attain market size.

### 2. Rack

This is a system where oysters, either in trays, strings or attached to other devices such as sticks, are placed on racks which are embedded in the ground in the fore-shore, either intertidally or just at the sub-tidal level. Racks may be constructed in many ways and some examples are shown in Figure 39a, b, c. Most often they are of wood because of availability and low cost. Racks may also be made of metal. The oysters, held on some form of substrate may be placed vertically or horizontally. The main limitation on the use of racks is depth of water - if too deep too much material is used, thus the maximum depth for racks is 2 to 3 metres.

Apart from the advantage of low cost, the rack permits the oysters to be placed at a level where they may be exposed for brief periods during most tidal cycles, thus controlling fouling to a considerable extent.

In Japan racks are used for seed collection, for wintering seed and for conditioning the spat to air exposure. In Australia racks are used extensively in both seed collection and in culture. The culture system in Cuba is based entirely on the rack system.

Suspension of various oyster substrates such as strings and trays has already been mentioned.

The Australian system of culture on racks is based mainly on a stick form of culture coupled to a lesser extent with trays. A number of flat bars or sticks one to two inches wide and four feet long (wood, cement

36 RAFT CULTURE.  
OYSTER STRINGS  
WITH  
SEPARATORS

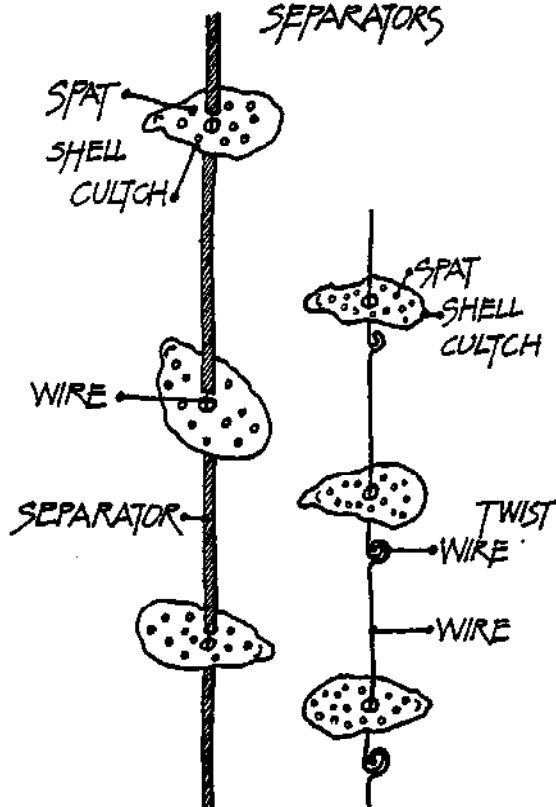

37 RAFT CULTURE.  
STRING WITH  
WIRE TWIST SEPARATORS

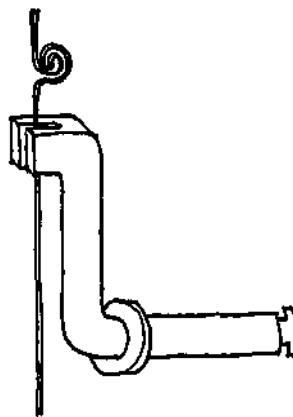

38 WIRE TWISTING TOOL

### 39 RACKS

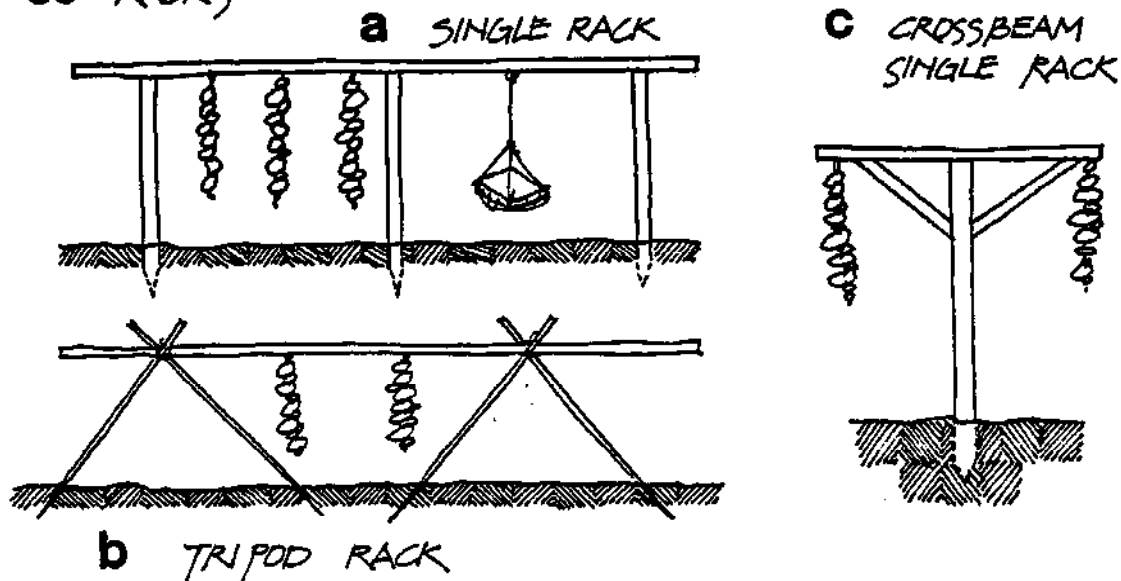

or asbestos cement) are made up into bundles for spat collection and these are placed on racks in the seed areas. Strips of bamboo or mangrove sticks could be used. After collection and some growth of the spat, individual sticks are separated from the bundles and laid horizontally on double racks. (40) Here the oysters are grown to

### 40 PARALLEL RACK - AUSTRALIAN SYSTEM

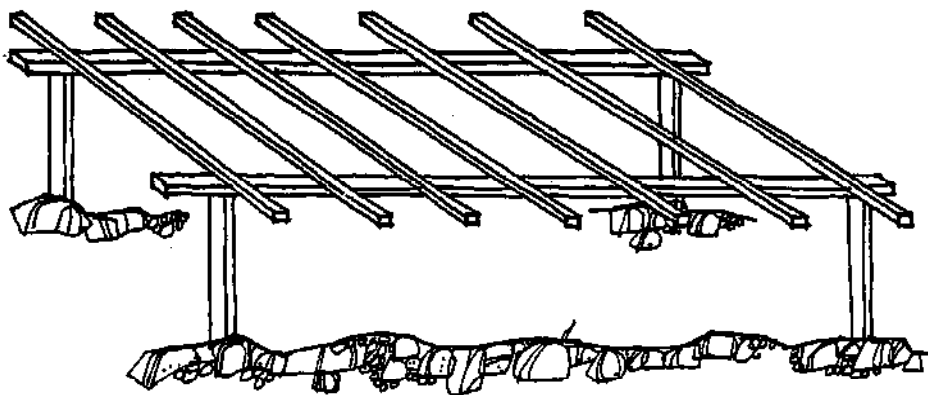

market size when they are removed from the stick. Those not large enough for market are placed on trays for further growth. The advantage of this system of culture is that the oysters may be grown at a selected tidal level. Further, they are off the bottom - out of the silt so growth is good and mortality from silting is minimal, as is fouling.

The main disadvantage is the clustering effect which may lead to somewhat reduced growth and to oysters not particularly well shaped.

The shape factor should be of minimal concern, for the oyster inside the casing and not the casing is the important consideration. This system of culture is less costly than most and simple in operation with materials generally available. The basic principle is advocated for anyone beginning oyster culture where bottom culture is out of the question and where fouling is a major problem. A measure of tidal rise and fall is advantageous but not entirely necessary.

### 3. Stake Culture

Care must be taken to distinguish between stake and stick culture. In stick culture the stick is the substrate. In stake culture the stake is the support. Here a short stake with a nail in the top end is driven into the ground. The nail holds in place a pierced piece of cultch with spat. (41, 42) Oysters on the piece of cultch - most often an oyster shell - grow out to form a cluster as with strings in raft culture.

The system is particularly suitable for shallow lagoons and where the bottom is too soft for bottom culture and the general area not suitable for raft culture. The advantages are low cost, and control of the tidal level at which the oyster may be grown. Fouling can be minimal if the correct tidal level is selected.

### 41 STAKE CULTURE. SEED STAGE

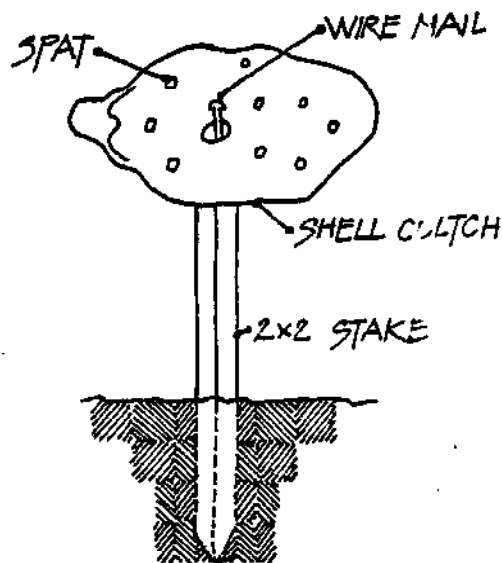

### 42 STAKE CULTURE WITH CLUSTER OF OYSTERS.

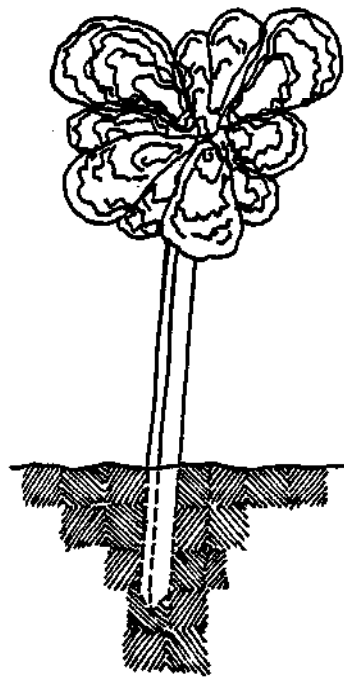

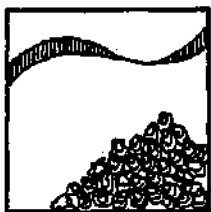

## harvesting

In temperate waters harvesting usually occurs during winter when oysters are in the best edible condition. The relatively short summer is when they are in their breeding condition and though edible, are not at their best. In the tropics where the breeding season is quite long, this rule does not apply. One of the first tasks in any new area where there is a culture project is to determine the seasonal changes in condition of the oysters. Initially this may be done with wild oysters from mangroves. This will determine the time of year when condition and therefore productivity is least. Later when a method has been developed the condition cycle for cultured oysters should be determined. Normally oysters are least useable immediately after spawning providing this is complete. However, in oysters with a long breeding season there may be only partial spawning over an extended period of time.

Bottom culture is the only system that allows any degree of mechanization and the area and production must be relatively great to warrant this. Either hydraulic or drag dredges are used. However, there is wide use of hand picking with intertidal bottom culture and manually operated tongs are used in some areas for subtidal bottom culture. For rack and raft culture manual harvesting is the most economical method unless the strings or trays are long or heavy. In this case a pulley system on an "A" frame or davit on a harvesting vessel is usually adequate to lift strings weighing a few hundred kilograms.

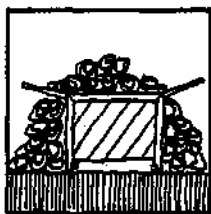

## storage

The two problems relating to oyster storage concern oysters in the shell (shell stock) and shucked oysters (oyster meat). For the latter, the only solution is refrigeration. Adequate and proper refrigeration involves rapid cooling and safe storage temperature. Although oysters may be taken from unpolluted water, they still contain a considerable quantity of bacteria, which in normal numbers cause no harm. With unsuitable warm conditions microorganisms may multiply rapidly in the body of the oysters and so cause spoilage. Oyster meats in gallon (4 litres) containers (diameter 20 cm.) in crushed ice require 4 to 5 hours to reach a storage temperature of 5°C (42°F) from an initial temperature of 17°C (63°F). Similar cooling in a refrigerator of 0°C (32°F) requires between 6 and 7 hours to reach 5°C (42°F), the usual storage temperature. The greater the delay after shucking, washing, and packaging in beginning the cooling process, the greater the opportunity for spoilage and the shorter the "shelf life". This is the term describing the length of time possible for safe retail display and sale as a good safe product. Oysters held at 12°C (53°F) have been found to be unacceptable after 3 to 5 days, while those at 8°C (46°F) were unacceptable after 7 to 8 days and those held at 1°C (35°F) on ice were still satisfactory after 16 days.

Storage of shell stock may be accomplished by a dry or a wet method.

Oysters grown subtidally must be handled with some care after being removed from the water for the sudden exposure to air and heat may cause them to gape open and lose moisture with subsequent death and spoilage.

Dry storage is necessary when facilities for wet storage are not otherwise available through distance from suitable wet storage sites or particularly when nearby sites are unacceptable because of sanitation problems. The main disadvantage of dry storage is that the oysters may be out of water for some time and their survival in good condition depends on air temperature and humidity. A refrigerated cold room with a temperature just above freezing or a covered area with ice give some measure of control and may extend storage period for days or even weeks.

Wet storage involves holding oysters in natural waters on the bottom, either intertidally or just subtidally if the bottom is satisfactory. Trays may also be utilized. Another method is the use of a sink float which is simply using floats as a support for an underwater floor on which the oysters are placed. (43) The floor is most often about half a metre or less under the surface and the oysters may be stored 30 to 40 centimetres deep. Care must be taken to keep the sink float in non-polluted waters. Oysters may be stored for a considerable time in this way, thus permitting the availability of a constant supply.

### 43 SINK FLOAT

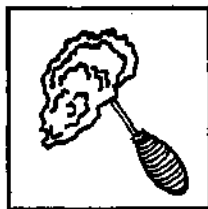
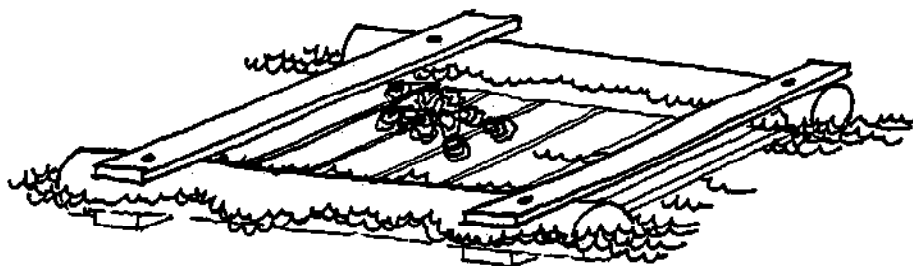

## shucking

Shucking is the name given to the process of opening oysters and removing the meat from the shell. So far, it is still mainly a manual operation. Many unsuccessful attempts have been made to develop a machine. Oysters are usually opened with a special oyster knife adapted to the shape of the oyster. Shucking skill comes with practice and each opener develops his own individual technique. However, there are some basic details that are common to most right-handed shuckers.

The opening process for most large *Crassostrea* type oysters begins by placing the oyster on a firm platform with the cupped or left valve down and with the hinge pointed toward the opener's left. In this position the single adductor muscle which must be cut to allow the shell to open, is located about two-thirds the distance from the hinge toward the bill at the right. The point of the knife (44) is inserted between the valves at this point

with a slight twisting motion. The handle of the knife is elevated slightly for usually the upper flat valve is slightly inside the lower valve. After the knife point has entered between the valves, the blade is forced far enough to allow lateral movements to cut the adductor muscle. The knife is then twisted until the blade is vertical and a prying motion will break the hold of the hinge and the two shells will separate. The oyster meat may then be removed.

In oysters where the shell is quite thin and fragile, a more pointed and narrow knife is jabbed through the upper valve in the bill region just posterior to the adductor muscle which is then cut.

Quite small oysters with hard shells are often opened by inserting the knife, usually a short one, between the shells at the hinge and a prying motion forces the valves far enough apart to allow the adductor muscle to be reached.

Heat is often used to cause the valves of the oyster to separate but this usually involves cooking the meats.

The "heat shock" method is also used for initial separation of the valves in clustered oysters without cooking the meats. This involves dipping the clusters for 2 to 3 minutes at a temperature of 63°C (145°F) to 66°C (150°F), followed by an immediate chill. This system requires careful sanitary control.

#### 44 METHOD OF OPENING AN OYSTER

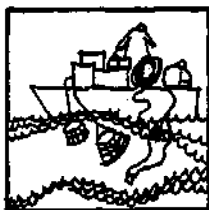
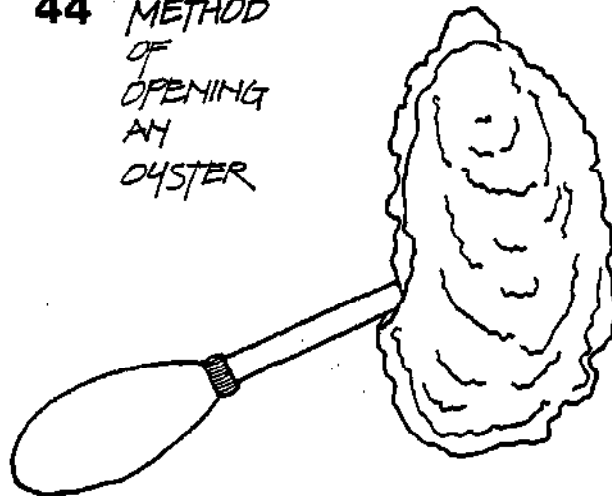

## equipment

### 1. Vessels

The sea transport required for beginning the study of basic biology and alternative culture methods is common to most areas, temperate or tropical. Differences occur



with boats to cope with varying distance, weather and sea conditions and these largely concern the type of vessel. Since this is usually the most costly requirement its suitability will contribute to the success of an oyster culture project.

Factors to be considered in the choice of a vessel are:

1. Initial cost
2. Maintenance
  - a. Simplicity
  - b. Operating manpower
  - c. Refit costs
  - d. Availability and cost of spare parts
  - e. Haul-out facilities and cost
  - f. Fuel consumption and cost
3. Seaworthiness
4. Stability as a work platform
5. Carrying capacity - manpower, material and equipment.

The key to vessel selection is simplicity - minimum size that will perform the task adequately with minimum attention. A boat may easily become a problem if it requires so much attention that it interferes with the oyster operations.

It is difficult to generalize but one of the more useful types of boat for shellfish work is a fibreglass catamaran type hull about 5 metres in length with a 15 horsepower outboard motor. These are shallowdraft, stable with good carrying capacity and quite safe, though uncomfortable at speed in choppy water. Another advantage is that it may be carried about on a trailer. If the distances are great with stormy waters, it may be necessary to use a larger vessel to transport the smaller one but if possible, site selection should make this unnecessary.

A useful piece of equipment is a small planked or plywood scow about 20 feet long, 8 feet wide and 2 feet deep with inclined bow and square stern. (45) This may be towed or powered with an outboard motor.

## 45 *FLAT BOTTOM OYSTER SCOW*

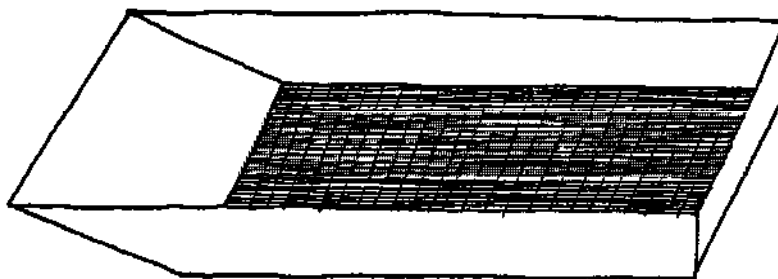

### 2. Culture

Equipment for culture operations will vary somewhat with the type being developed and with what is available locally, but the following list indicates the basic needs.

1. Rope - various sizes
2. Wire - 12-14 gauge - galvanized
3. Nails - assorted
4. Lumber
5. Anchors
6. Floats - barrels, bamboo - manufactured, i.e. glass balls, scotchmen, tires filled with urethane
7. Baskets - wire or rattan
8. Buckets - plastic or galvanized
9. Oyster-shucking knives
10. Rubber gloves

The major oyster industries of the world are the result of many years of development and have reached the stage where further refinements in efficiency are considered to come about only by sophisticated study techniques. Such refinements, however, are not for a beginning industry where the objective is the adaptation of an established system of culture. The knowledge necessary for this may be obtained with relatively simple equipment and complicated apparatus will only divert energy from the main task of establishing the basics in biology and culture. Often funds are available for short time periods. The following lists of scientific equipment may seem meagre but they are quite adequate for the initiation of an oyster culture project.

### 3. Carpenter tools

1. saws - crosscut, rip-Swedish
2. claw-hammer
3. sledge hammer
4. axe
5. shovels
6. machete
7. tin snips
8. wire snips
9. crow bar
10. pliers
11. files
12. carborundum stone

### 4. Optical equipment

1. Stereoscopic stage microscope - magnification to x 70
2. Compound microscope - magnification to x 400
3. Microscope illuminators
4. Filar micrometer
5. Micrometer slide
6. Enlarged plexiglass stage for stereomicroscope

### 5. Glassware

1. Watch glasses
2. Watch glasses - Syracuse
3. Finger bowls
4. Plastic graduate cylinder 50, 100, 500, 1000 ml.
5. Jars - 4 oz., 8 oz., 16 oz.
6. Dropping pipettes
7. Glass slides and coverslips

### 6. Plankton equipment

1. Nets - #20 (76-u mesh), #25 (64-u mesh) mesh nylon
2. Plankton buckets (end of net)
3. Cord
4. Plankton pump
5. Counting cell

7. Oceanographic equipment

1. Hydrometer
2. Thermometers
3. Thermographs - preferably submersible (Ryan type)
4. Current drogue
5. Salinity refractometer

8. Chemicals

1. Formaldehyde
2. Methyl alcohol
3. Davidson's fixative
4. Canada balsam
5. Xylo1
6. Bleach (Perfex, Chlorox)

9. Land transportation

1. Vehicle (pickup truck type)
2. Boat trailer

10. Miscellaneous

1. Balance - electronic - capacity 3000 grams
2. Suspension type scale - capacity 10 Kg.
3. Veeder Root Type Counter



## plankton

# BIOLOGICAL METHODS

Plankton, the floating animal and plant life in the water, is important to the oyster grower for two main reasons. Some of it forms the food of oysters while the larvae of oysters are part of the plankton. To attempt to relate plankton to the food supply for oysters in any specific area is most difficult and should not be attempted by the general biologist. However, the time of occurrence and abundance of oyster larvae in the plankton may provide information on breeding seasons and the time and intensity of spatfalls. Therefore it is important to know how to sample and count oyster larvae in the plankton.

Oyster larvae are seldom abundant enough to be obtained in quantity in a small water sample so several systems of sieving are in use. The basic method uses a plankton net (46) which is simply a cone of fine-meshed cloth (silk or nylon) with a special weave, with a collector attached to the bottom. The basic method of using a plankton net is to tow it behind a boat (47). The boat is moved at a rate enough to keep the net just below the surface.

The length of tow will depend on the abundance of larvae in the particular area but a tow of about 5 minutes is a guide with which to start. After the tow is made, the net is pulled to the boat side rapidly enough so as not to allow any of the contained plankton to spill out. After the net is lifted from the water the level within the net is allowed to drop until it reaches the top of the collector. If this is simply a bottle, the sides of the net are washed down with water and the bottle untied. If the collector has a tap, this is opened and the sample allowed to drain into the sample bottle and then the sides of the net are washed down so any remaining plankton will be retained. The sample bottle is stoppered immediately after preservation with a few drops of preservative such as neutral formalin and a label giving the

date, time, place, depth and duration of the tow is placed inside it. On return to the laboratory, the net should be washed down with fresh water if possible.

This type of sample is mainly qualitative and indicates only a rough idea of abundance. The efficiency of the net in collecting a towed sample may be reduced considerably if there is much plant plankton or silt, which block the pores in the conical silk net causing the water to pour out the net opening rather than being strained.

Therefore, a quantitative sample is required to provide a better measure of relative abundance of various types of organisms, as well as sampling fairly adequately. A flow meter in the net is often used but this is also influenced by the efficiency of the net.

For many situations where oyster larvae are being sampled a vertical haul is employed. Here the net is lowered to a specific depth and the net pulled to the surface at a uniform rate, slow enough to allow adequate filtration but not too rapidly so water is forced out of the net opening. The quantity of water filtered may be fairly accurately measured by knowing the distance through which the net is hauled and the diameter of the net.

Example: A net 14 cm. across the mouth is hauled from a depth of 10 metres. The volume filtered is calculated by determining the area of the net opening (i.e.  $22/7 \times 7^2 = 154$  sq. cm.) and multiplying this by the distance hauled (1000 cm.) giving 154,000 cubic centimetres or 154 litres.

46

### PLANKTON NET

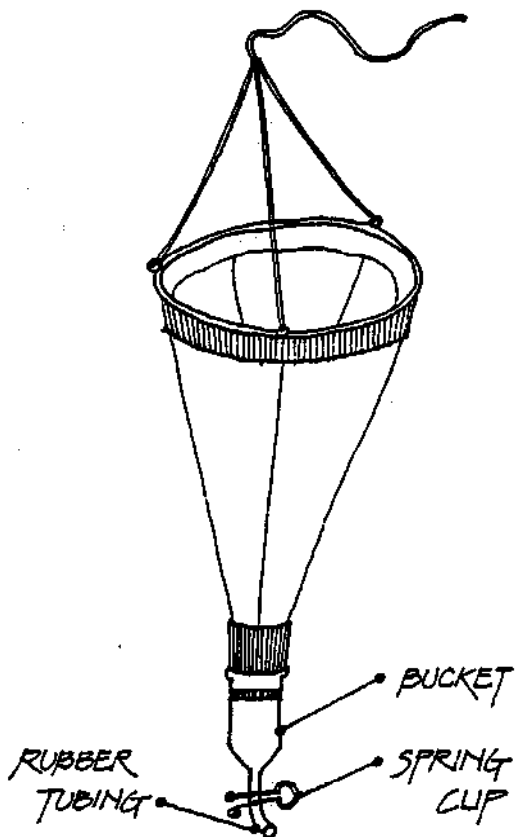

47

### PLANKTON TOW

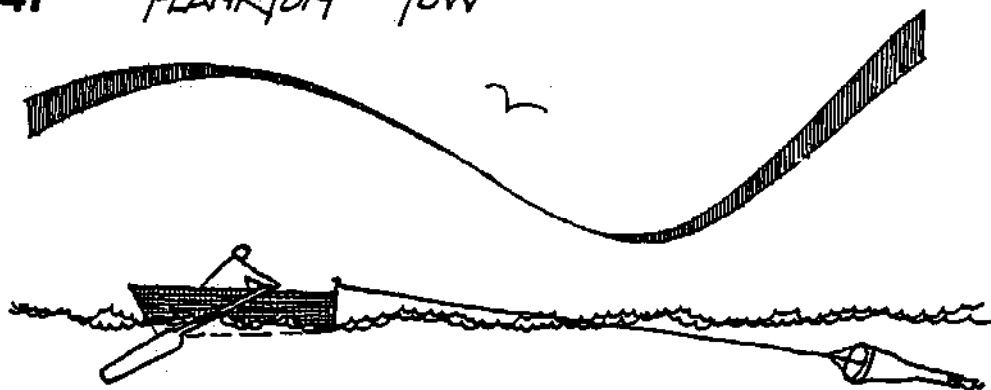

Another method of quantitative plankton sampling is to pump the sample through the plankton net. This may be a pump at the surface with the end of the intake pipe lowered to the depth at which the sample is to be taken. A current method uses small battery powered submersible bilge pumps. These may be powered with a 12 volt battery which may be easily transported in a small boat and the pump with the power line and the hose attached is lowered to the required depth. (48) The volume of water pumped through the net may be measured either into a container; with a water meter; or by a specific time, if the rate of pumping is known, which may be calculated by pumping into a container of known volume, providing the length of hose is always the same.

#### 48 PLANKTON SAMPLING WITH SUBMERSIBLE PUMP

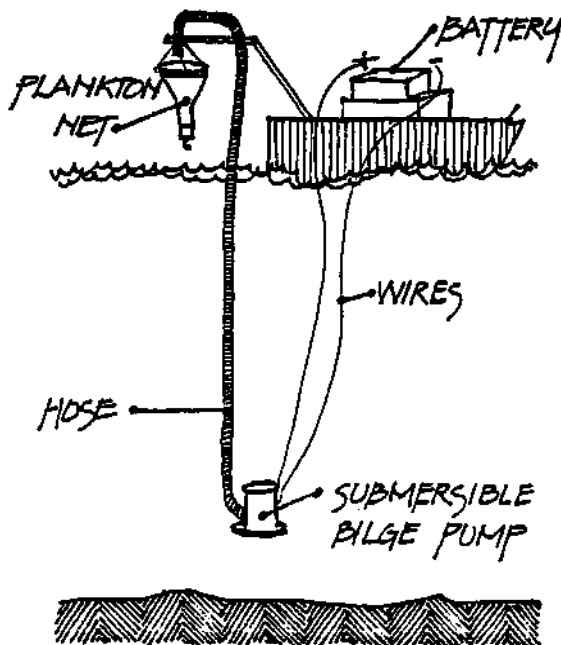

#### COUNTING OYSTER LARVAE

After the sample has been taken it is customary to take a preliminary look before counting, particularly if it is not known whether oyster larvae are present. This is most easily done by collecting the larvae as explained on page 11. These are then examined with a stereoscopic microscope. A compound microscope is not needed unless individual larvae are being examined for some particular feature.

For counting some sort of chamber is required. Any dish with lanes or squares marked on it may be used. Many use a specially designed dish or tray with channels or lanes approximately the width of the microscope field. (49) The tray is moved back and forth under the microscope, following the lanes, thus ensuring that all larvae are counted but none twice. The sample is placed in the tray after first decanting most of the liquid, ensuring that none of the sedimental material is lost, then pouring the remainder into the counting tray as quickly as possible. The container is then rinsed with a small amount of water which is also poured into the counting tray and this procedure is repeated until either the tray has sufficient liquid in it or it is reasonably certain no larvae are clinging to the walls of the jar. Counting may then proceed and the most useful instrument for this is the Veeder type counter with a bank of at least 4 keys. In this way the numbers of various larval stages may be recorded, i.e. straight hinge, early umbo - mid umbo - advanced (eyed) stage.

#### 49 PLANKTON COUNTING CELL

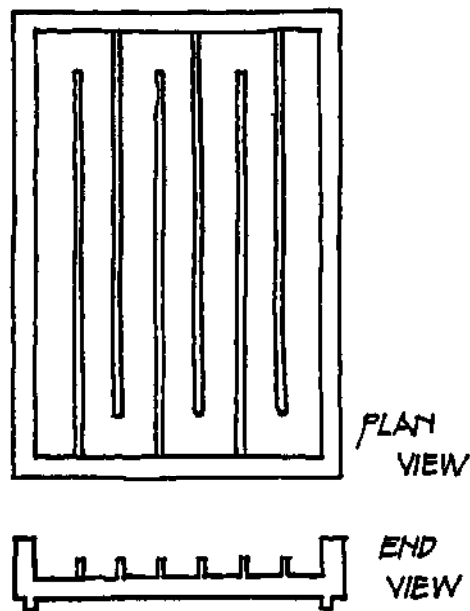

If larvae are very numerous alternate lanes only may be counted or the whole sample may be sub-sampled before placing it in the counting chamber. If the whole sample is counted, the total number of larvae, or any group, is divided by the volume of water filtered through the net. For example, if there are 2464 larvae and the volume is 154 litres, then 2464 divided by 154 gives 16

straight hinged larvae per litre. If subsampling is required the volume of the plankton sample must be measured or made up by adding water to a specific known volume. If, for example, this is 400 ml. and a 25 ml. subsample is taken and 800 larvae are counted in it, then there would be  $400/25 \times 800 = 12,800$  larvae in 154 litres or  $12800/154 = 83.1$  larvae per litre. Subsampling may be done by mixing the made up sample well and rapidly pouring off the subsample or by dipping from it a known volume. The subsampling must be done rapidly after mixing to prevent the larvae from settling to the bottom. There are specially designed plankton splitters and Stempel pipettes for this purpose but the methods described above are generally adequate.

#### OTHER PLANKTON SAMPLERS

There are other methods of sampling plankton for oyster larvae such as the Westley model in which 3 pipes are placed at different levels beneath a fast boat. (50) The water pressure forces the plankton through the pipes and into the mixing chamber and then through a plankton net. In this way a composite running sample from three discrete depths is taken. The purpose is to attempt to overcome variations in both the vertical and horizontal distribution of the larvae. Another system is the Quayle-Terhune sampler in which a pipe of a given length is firmly suspended along-side a vessel. (51) The pipe, closed at the bottom and throughout its length, has 5 mm holes every 5 cm. through which water is pumped, via a meter and into a plankton net. This is another attempt to overcome the uneven distribution of the larvae. In this case the boat must be heavy enough to take the strain of pushing a long vertical pipe through the water but the speed may be as low as required. Also in this case the whole water column along the length of the pipe is being sampled. In addition to the running sample, it is possible to sample from a specific location.

The plankton sampling frequency depends on the objective of the study. If it is concerned with total plankton and seasonal changes, then about once per week is usually

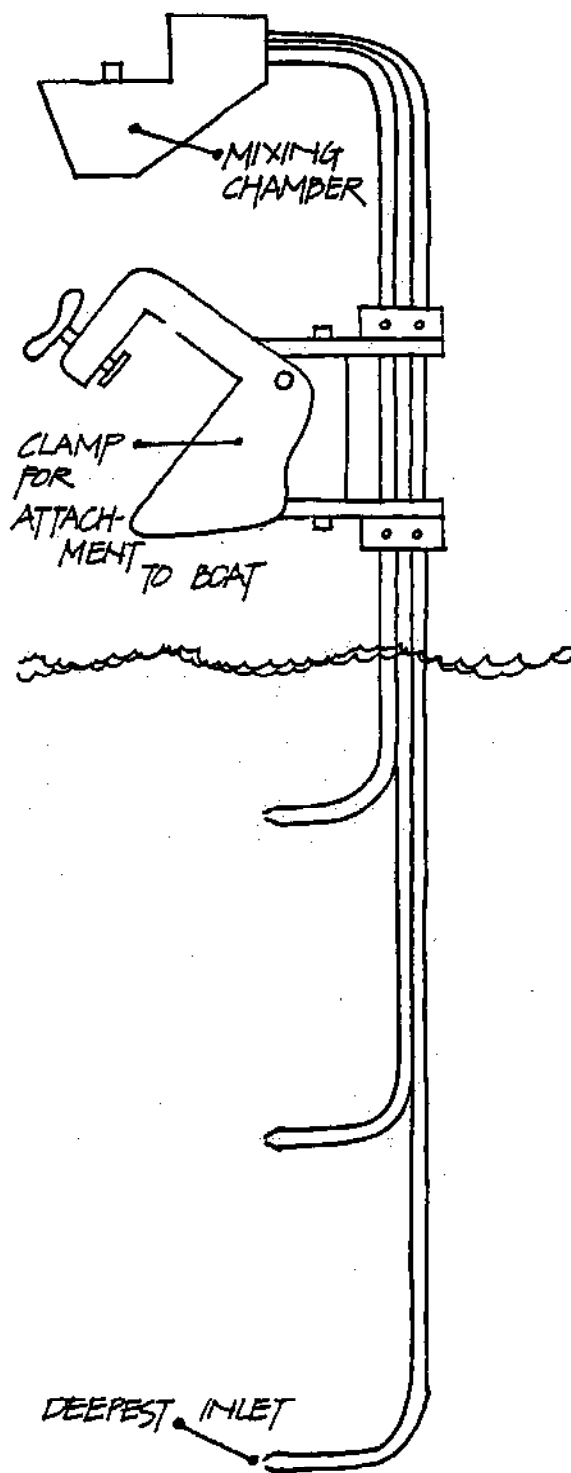

50 WESTLEY PLANKTON SAMPLING DEVICE

adequate. If it is concerned with oyster larvae, then more frequent samples are necessary, and in tropical waters with relatively short larval periods, daily sampling is required.

One other problem with a plankton program is the spatial distribution of samples. This depends to a great extent on the geography of the study area. If the shorelines are straight with few bays or promontories, fewer samples are required than otherwise. Also, if there is little tidal change and small currents, few sampling stations will be necessary. With a moderately indented shoreline a rough guide might be four or five stations per square mile.

Initially it is wise to err on the side of more numerous stations and then experience will indicate if reductions may be made. Another factor is the amount of man-power available.

In addition to the spatial distribution of stations and frequency, there is the question of depth of sampling. The factors affecting this are the actual depth of water and the presence or absence of thermal and salinity stratification, although in many estuaries the waters are so mixed as to be unstratified. Here again preliminary samples taken at the surface, 1, 2, 3, 4, 6, 8, 12, 16, 20 metres depending on depth, will give an indication of the levels needed to provide a reasonable description of the vertical distribution of larvae.

The daily sampling time will depend on what is found in initial trials. Some sampling should be done over several 24 hour cycles partly to discover whether there is vertical migration (diurnal) relative to periods of light and darkness. If there is little or no tide, then samples could be taken at the various depths every 3 hours for 48 or 72 hours. If there is a significant tidal range, then the times of slack water and midway between them may be selected for periods during both a spring and neap tide series.

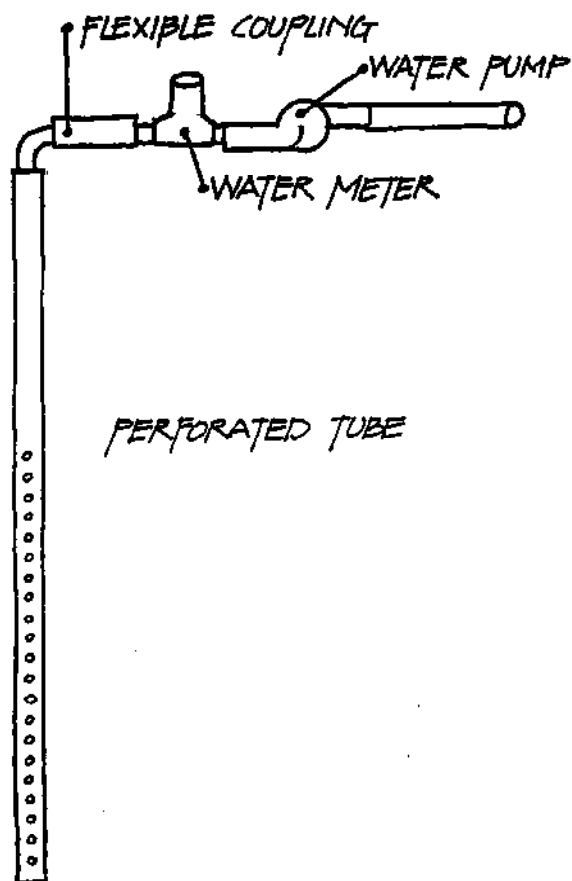

51 QUAYLE - TERHUNE  
PLANKTON SAMPLING  
DEVICE





# oceanography

The oceanographic factors of most concern to the oyster culturist are temperature, salinity and currents. Of lesser importance are hydrogen ion concentration (pH), oxygen content and turbidity. Other chemical constituents such as the nutrient salts (nitrogen compounds, phosphates and silicates) can influence the production of potential oyster food but are difficult to measure or apply to oyster culture activities. In the tropics, seasonal water temperature fluctuations are relatively slight, but since most oyster culture takes place in estuaries salinity changes are considerable. Seasonal and horizontal differences are of importance in deciding cultural practices. Except in special circumstances oxygen is not a limiting factor nor is pH. Currents are of considerable importance since they influence the siting of culture structures such as rafts or racks, the movement of oyster larvae and of food.

Tidal information is usually obtainable from published tide tables.

## TEMPERATURE

Temperature may be measured in a number of ways and for oyster work a high degree of accuracy is not necessary and reading to 0.1 degrees are more than adequate.

### 1. Standard Glass Thermometer

A standard glass thermometer which for oyster work should be protected by a metal container. For a surface temperature the simplest way is to take a bucket of the surface water, immerse the thermometer in it and wait until the movement of the mercury column stabilizes (a minute or so), before taking the reading.

### 2. Reversing Thermometer

For subsurface readings a reversing thermometer (52) which is attached either to reversing frame or to water sampling bottles (53). The frame or bottle is lowered to the desired depth on a wire or stiff rope. A weighted messenger is dropped down the line and this trips a mechanism which allows the thermometer to reverse and break the mercury column at the correct point. The thermometer is then retrieved and the temperature recorded both on the main thermometer and on the standard type auxiliary which is mounted alongside the reversing thermometer. The auxiliary is used to correct the reading for changes in the difference between the temperature at reversal and the surrounding temperature at the time of reading. There are formulae for determining the corrections to be applied. However, for oyster work this degree of accuracy is unnecessary and the reading on the reversing thermometer itself is sufficient.

This system is time-consuming and expensive and should be considered only in exceptional circumstances.

## 52 REVERSING THERMOMETER

### 3. Bathythermograph

This is an instrument which records on a smoked glass slide a profile of the water temperature against depth. It is useful for determining the levels of thermoclines but generally in waters of some depths. This also is an expensive instrument with limited usefulness in oyster work.

### 4. Salinometers

These are electronic instruments which measure both salinity and temperature. One consists of a battery operated box containing the electronics with the necessary dials and knobs. Attached is a cable with a sensing head which is lowered to the required depth. A temperature and salinity measurement may be taken immediately and quickly, thus a whole series may be taken in a short term. However, the serviceability is not of a high level so these instruments are generally not recommended.

### 5. Recording Thermometer

One of the most useful temperature instruments for shellfish study is the recording thermometer. There is a type with an open clock face and one or two tails for placing at the depth at which the temperature is required. These are clock wound and operate for a week on one winding. There is another more compact type that is submersible which permits keeping it hidden from vandalism or theft. The clock work winding operates for up to several months. The continuous record shows all of the temperature fluctuations within the period at that depth and permits an analysis of the temperature (i.e. degree-days) to which the oysters in that particular area are subject.

### 6. Maximum-minimum Thermometer

Another fairly useful instrument is the maximum-minimum thermometer which determines the maximum and minimum temperature for any given period of time. These are inexpensive.

Temperatures may be recorded as daily, weekly or monthly means and are usually



## 53 SIMPLE SAMPLING BOTTLE

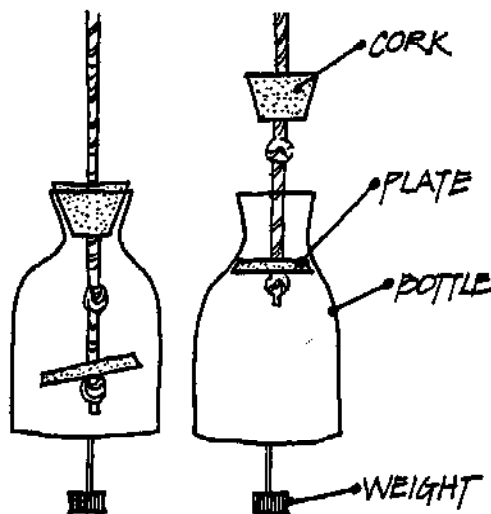

so graphed. Temperature in relation to oyster culture is not as important in the tropics as it is in temperate waters. The wide seasonal fluctuations of temperate waters have profound effects on growth and breeding while the consistent relatively steady temperature levels of the tropics do not have the same effect. Salinity is a much more dominant factor in the tropics particularly in relation to breeding, but also to growth.

## 54 HYDROMETER

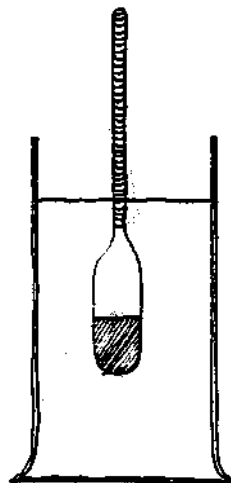

The two scales for measuring temperature are Fahrenheit and Celsius and the instruments obtainable may be calibrated in either system. When ordering, the type should be specified but a Celsius instrument is recommended for scientific work. The Celsius scale has a normal range of 100 degrees - 0°C at freezing and 100°C at boiling. Equivalent points on the Fahrenheit scale are 32°F at freezing and 212°F at boiling.

To convert from one to the other the formulae are:

$$^{\circ}\text{C to } ^{\circ}\text{F} - \frac{9}{5} \times (x^{\circ}\text{C} + 32) = ^{\circ}\text{F}$$

$$^{\circ}\text{F to } ^{\circ}\text{C} - (x^{\circ}\text{F} - 32) \frac{5}{9} = ^{\circ}\text{C}$$

### SALINITY

Salinity measurements are based largely on the determination of the chloride ion concentrations rather than on sodium chloride. Both salinity and chlorinity are expressed in grams per kilograms of sea-water or in other words, in parts per thousand, or "per mille", and the symbol ‰ is used.

Methods of determining chlorinity or salinity are:

#### 1. Titration

The sample is titrated with silver nitrate using potassium chromate as an indicator. This is a fairly simple chemical procedure but has the complication that it is necessary to standardize it against a "Normal Water" which is sea-water whose chlorinity has been adjusted to about 19.4 ‰. Unless there is an operational chemical laboratory available for this work this method is not recommended for most shellfish work.

#### 2. Hydrometers

Salinity may also be determined by measuring its density where a hydrometer or float is used and the density measured by the weight of the hydrometer and the volume of the displaced water. Hydrometers (54) are accurate enough for most shellfish work. However, they are fragile, being made of glass with a fine stem.

#### 3. Refractometers

This is a small sturdy instrument requiring only a very small water sample and

is probably the most suitable of all salinity measuring instruments for field work. (55)

## 55 REFRACTOMETER

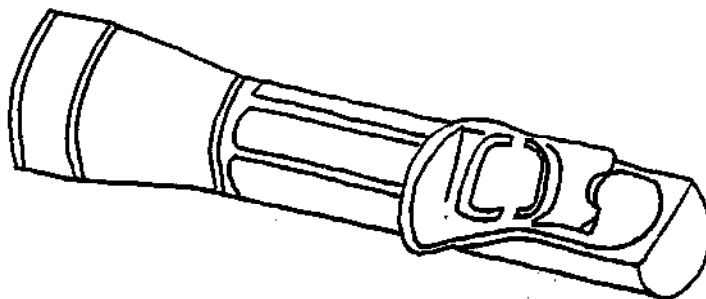

### 4. Salinometers

(See page 56.)

#### OXYGEN

The oxygen content of oyster growing waters is most important. In most natural circumstances there are generally adequate amounts of oxygen in sea water. Extraordinary circumstances include reductions caused by biological oxygen demand from pollutants or from decaying organisms such as plankton blooms.

If oysters live naturally in an area it may be assumed the oxygen supply is satisfactory. Temporary oxygen depletion for a number of days usually has no significant effect on oysters for they can close their valves and live for a time without an external source of oxygen.

If it is necessary to measure the oxygen content there is the Winkler titration method involving the oxidation of manganous hydroxide which when acidified reacts with potassium iodide, freeing iodine which is titrated with sodium thiosulphate. A moderately well equipped chemical laboratory is necessary mainly for the preparation of reagents, although kits are now available. The oxygen content of seawater may vary from zero to 8.5 ml. of oxygen per litre of water. Cold water is capable of holding a higher quantity of dissolved oxygen than warm water.

There are also electronic instruments for measuring the oxygen content of seawater.

#### HYDROGEN ION CONCENTRATION (pH)

As with oxygen if shellfish are living in an area it may be assumed that the pH level is suitable. Changes may be caused by reduced salinity but fairly drastic differences over a period of time are necessary to cause difficulties to oysters. Unless abnormal conditions develop it is unnecessary to be concerned with pH in oyster culture operations. Hydrogen ion concentration is a measure of alkalinity or acidity and is measured on a logarithmic scale so a unit change in pH denotes a tenfold change in the acid ions and alkaline ions. A neutral solution, neither acid nor alkaline has a pH of approximately 7; an acid solution has a pH less than 7 and an alkaline solution a pH greater than 7. Sea water is normally alkaline usually between 7.5 and 8.4.

Hydrogen ion concentration is measured with electrometric instruments or by colorimetric methods. As with most electronic instruments, under rough field conditions or in areas far removed from repair facilities their usefulness is limited. In the main colorimetric technique, a controlled amount of an indicator solution such as cresol red or phenol red is added to the sea water sample and the colour developed is compared to that in a set of standardized tubes. This method is accurate enough for most shellfish work in the field.

#### TURBIDITY

Since most mangrove oyster areas are in estuaries, turbidity (transparency of water) exists in varying degrees and has a direct influence on oyster culture. Turbidity may be caused by the silt load, by the amount of detritus (suspended organic material), by plankton or by a combination of all three. The results of turbidity are shown in the deposition of silt which in sufficient concentration may smother bottom living oysters. It also affects the feeding efficiency of oysters, when in high concentrations much energy is expended separating out food and discharging unwanted particles.

Turbidity may be measured by testing the limits of visibility or by light measurements. For most oyster culture studies, limit of visibility is adequately and simply measured by the Secchi disc. This is a circular plate, usually of metal, 20 cm. in diameter. It may be all white or divided into 4 quadrants, alternately black and white on the upper surface with the lower surface black to prevent reflection of light. The Secchi disc is lowered into the water on a measured line. The depth at which the disc may no longer be seen is noted as well as the depth at which it reappears when lifted. The mean of the two readings is the limit of visibility and is a rough but useful measure of turbidity. The time of day, the amount of cloud and wave action affect readings so these are noted at each reading. Readings may be standardized at mid-day on the shaded side of the boat and preferably with a water glass and observations made at one metre above the water surface.

#### TIDES

Tides are a most important factor in determining the type of oyster culture in a given area. Tides are generated mainly by the gravitational effect of the moon and sun, particularly the former. However, wind and barometric pressure may exert a smaller influence in certain localities. For most areas in the world it is possible to predict fairly accurately the movement of tides and these are published for most of the shipping ports and a typical tide table is shown.

**table 4**

JUNE			
Day	Time	Ht./ft.	Ht./m.
1	0135	14.8	4.5
	0850	5.0	1.5
	1535	12.5	3.8
	2020	9.5	2.9
2	0220	14.5	4.4
	0925	4.2	1.3
	1630	13.3	4.1
	2120	10.0	3.0
3	0250	14.2	4.3
	1005	3.5	1.1
	1720	13.9	4.2
	2225	10.3	3.1

Thus on June 1 at 0135 the height of the tide is 14.8 feet above the chart datum which is the plane below which the tide will seldom fall and is the basis for marking on

charts. Approximately 6 hours later at 0850 the tide has fallen to 5.0 feet above the chart datum. There is then a succeeding high and a succeeding low. (56) Thus in this

## 56 TIDAL CYCLE FROM DATA IN TABLE 4

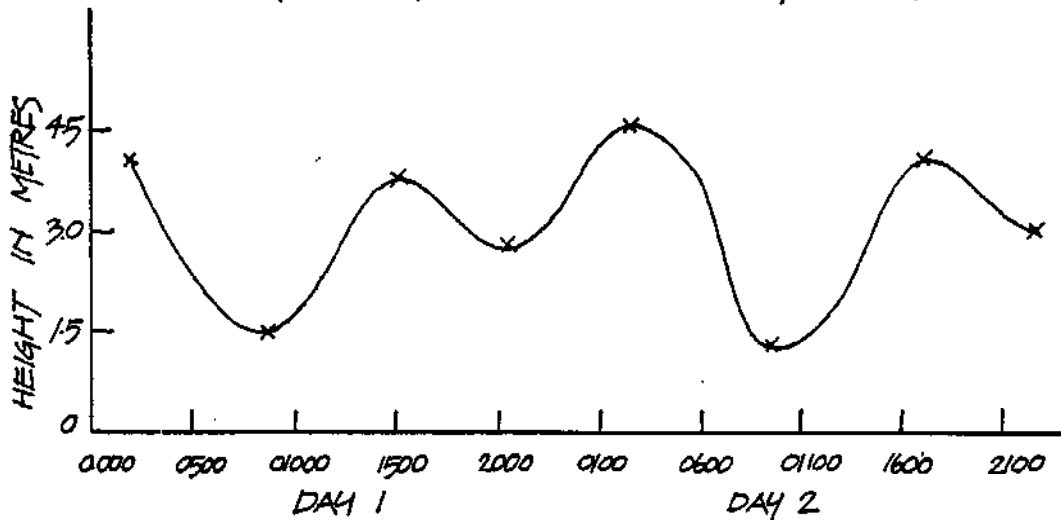

case there are two complete tidal cycles or oscillations per day and this is termed a semi-diurnal tide. If there is only one complete cycle in 24 hours the applied term is diurnal. In some areas there are no tides or a range of only a few inches.

In addition to the complete data for reference ports on which the predictions are based, there is information where the time and height differences between the main reference port and a number of secondary ports. However oyster growing areas may be far from even secondary ports so it may be necessary to establish rough indications of the time and height differences from the nearest reference port. The times may be determined by observing the time of slack water which is the brief period when the tide begins to fall after rising or to rise after falling. The levels or heights may be determined by installing a marked pole and observing the levels at the time of slack water. A satisfactory amount of data may be accumulated in a few months, and it will be sufficiently accurate. In protected embayments or estuaries where most oyster culture is carried on, strong winds may cause differences in height of a foot or more.

### CURRENTS

Currents are water movements developed by differences in tidal levels or are induced by wind. In open waters currents generally have small velocities in the range of one or two kilometers per hour. In constricted areas such as estuaries or island complexes currents may be quite rapid and speeds of 25 kilometers per hour are known. Currents are important to oyster culture relative to the location of beds or the positioning of racks or rafts and to the distribution of oyster food and of larvae. Current speed and direction should be investigated but the fact that these may vary with depth and time must be considered. There are several methods for measuring currents.

There is a wide range of complicated mechanical current meters but for most shellfish work these are not necessary. Drift poles which are simply lengths of wood or poles (bamboo) weighted at one end so they float upright have been used extensively. The

depth may be varied with the length and weight used. For surface currents plastic envelopes or other simple surface floating materials are satisfactory. Also in general use are drogues which are simply 4 plane surfaces set at right angles to a common centre (57) weighted to float at a given depth. Either one or several may be set out at one or at several stations and at different times to cover varying weather and tidal conditions. From direct observation and time rough current patterns may be developed. For more accuracy some means of taking bearings such as sextants or bearing compass with or without range finders would be required.

## 57 CURRENT DROGUE

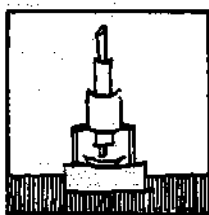
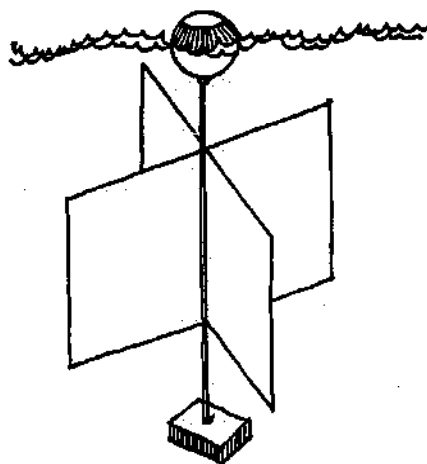

## microscopical technique

Certain phases of oyster culture and biology require the use of a microscope. There are many types of microscopes and some, such as the electron or scanning types, are able to magnify many thousand times. Higher power compound microscopes have limited usefulness in oyster culture projects and as an equipment item have low priority. For most oyster culture operations magnifications of 100x or less are quite adequate and the stage stereomicroscope is most satisfactory. This is a binocular microscope, most of which have combinations of eye-pieces and objectives which give magnifications up to 70x. The oculars should be wide-field and to ease eye strain from prolonged use, the optimum ocular magnification should not be greater than 10x. Stereomicroscopes produce a direct image rather than a reversed one with higher power compound microscopes, and the working distance is fairly long, i.e. the distance between the objective and the object. Thus the surface of fairly large objects such as an oyster shell may be viewed.

Lighting may be transmitted (reflected) or incident (direct). Reflected light is obtained from a light source with a substage mirror (a condenser in the case of compound microscopes) and used mainly for oyster larvae and transparent or semi-transparent objects. Incident or direct light illuminates the upper surface of the object (such as an oyster shell) and the light source is above. Microscope lamps are adapted to particular microscopes and the same lamp may be used for both transmitted and incident light.

To make it possible to use large counting cells and examine other large objects such as cultch pieces, a transparent plastic plate can be mounted on the stage and attached with counter-sunk stainless steel or brass bolts through the slide clip holes provided on all stereomicroscope stages. A plate of perspex 1/4 inch thick and 12" x 8" is a

useful size.

To use a microscope effectively the materials to be observed must be properly prepared. Methods for examination of larvae are described elsewhere (page 11).

Living material, if small enough, may be observed by placing it on a microscope slide with or without a cover glass depending on its size. Well slides, which have a slight depression in them, are most useful. For these materials transmitted light is generally suitable. Varying the light intensity assists in delineating internal structures. Larger solid materials such as pieces of cultch or fouling organisms (barnacles, tunicates) are best observed with incident light. Minute living material may be difficult to observe because of movement as a result of ciliary action. Narcotizing with 10% alcohol or a weak magnesium chloride ( $MgCl_2$ ) will slow down the rate of ciliary action. Both are added gradually.

For fine dissections or probes, dental equipment is useful. A dentist will be glad to save his discarded instruments such as probes and fine needles. Fine scalpels may be purchased but they may also be made by breaking up safety razor blades and mounting the appropriately shaped pieces in a cleft stick or pen holders.

For certain oyster studies, such as the state of the reproductive organs or details of internal parasites, it may be necessary to prepare very thin slices of oyster tissue on microscope slides for examination with a high powered microscope. To cut thin slices, called sections, it is necessary to place the piece of oyster tissue in a block of wax. Wax, however, does not mix with water so it is necessary to replace the water in the tissue with a substance, called a clearing agent, that will mix with wax. The first stage in this process is called fixation. After fixation and subsequent preservation, the material may be sent to a laboratory equipped to do the dehydration, imbedding and section cutting, so it is necessary to know something of fixation and preservation. However, similar type studies may be done locally on small objects such as oyster larvae and spat without cutting sections, and these are termed whole mounts.

#### FIXATION AND PRESERVATION

Fixation is the application of a chemical (fixative) to kill an organism or a part of it, to act on the protein in it so the cellular contents and morphological characteristics retain as closely as possible the form possessed in life. Preservation is the maintenance of the fixed condition for extended periods of time. Chemical solutions for fixation and for preservation may be the same or a different one may be used for the latter.

Fixatives most commonly used for molluscs are Davidson's solution, Formol-alcohol, formaldehyde and alcohol: Davidson is generally used if histological sections are to be made of material such as the gonad for seasonal change studies. Davidson comes in two forms, with with acetic acid for fixation of tissue and the other without acetic acid for preservation.

#### Davidson with acetic acid

Formaldehyde (40%)	20 parts
Glycerin	10 parts
Alcohol (95%)	30 parts
Glacial acetic acid	10 parts
Water (sea water)	30 parts

After fixation for about 24 hours the material may be stored in the same solution but with the deletion of acetic acid.



### Formol-alcohol

A satisfactory general purpose combined fixative and preservative with readily available components is formaldehyde-alcohol.

The formula is:

Formaldehyde (40%)	100 ml.
Alcohol (95%)	900 ml.

Another similar one with somewhat better fixative qualities is F.A.A. whose components are:

Ethyl alcohol (50%)	200 ml.
Glacial acetic acid	5 ml.
Formaldehyde (40%)	13 ml.

The most widely used fixative and preservative is formaldehyde, also known as formal, formol and formalin. The commercial grade of formaldehyde contains about a 40% solution in water. Typical strengths of formaldehyde used for most molluscan work are 1%, 2% and 4% and may be made up as follows; usually with seawater.

	<u>1%</u>	<u>2%</u>	<u>4%</u>
Formaldehyde (40%)	2.5	5	10
Seawater	97.5	95	90

Formaldehyde adequate for most purposes is a 2% solution providing the volume of formaldehyde is about nine times the volume of the specimen or specimens.

Formaldehyde is acidic and will corrode calcareous structures such as molluscan shells unless it is neutralized or buffered. This may be done by adding borax in excess. Calcium carbonate may be used instead of borax. An alternative is to buffer a 5-gallon quantity of formalin (10%) with 80 grams of  $\text{NaH}_2\text{PO}_4$ . Some care must be taken in the use of formaldehyde for the fumes are irritating to the eyes and nasal passages. A few individuals are allergic to this substance.

### Alcohol

For fixation and preservation the type of alcohol generally used is methylated spirits which is less costly than pure ethanol. Isopropyl alcohol is sometimes used, but should be avoided as preservation is poor when diluted. Alcohol is inflammable and consequently a fire hazard. It also has a high rate of evaporation when used in an open dish for specimen examination. For storage, containers must have tight lids to prevent evaporation and drying of specimens. Industrial methylated spirits are usually purchased most cheaply as a 96% solution. Dilutions may be made up as follows:

	<u>Percent required 25</u>	<u>Percent required 60</u>
96% Alcohol	25 ml.	60 ml.
Water	71 ml.	36 ml.
	<hr/>	<hr/>
	96 ml.	96 ml.

Thus the volume of the final dilution in millilitres is the same as the percentage strength of the original alcohol, and this method may be applied to the dilution of any liquid.

For fixing and preserving plankton a useful combination is 0.5 ml. of propylene phenoxetol, 4.5 ml. propylene glycol, 5 ml. of 40% formaldehyde in 90 ml. of seawater. After fixation most molluscs or parts of molluscs remain opaque. It is possible to apply chemicals that will cause them to become transparent (clearing) so internal structures may be observed. To further delineate these structures selective staining is possible.

### Staining

Stains for biological materials are numerous and their application may be quite complex. However, for basic molluscan work, methylene blue is a useful stain. A 2 to 5 percent solution in water is adequate. A 1% solution of neutral red in seawater is used for staining larvae, both alive and fixed.

### Clearing

Clearing agents, generally oil-like, are not miscible with water. Therefore, before an oyster or a piece of tissue may be cleared, the water in it must be removed and this is done by gradually replacing it with alcohol. The usual dehydration schedule, with the time adjusted according to the size of the object is:

1. water
2. 50% alcohol 1 - 12 hours
3. 70% alcohol 1 - 12 hours
4. 90% alcohol 1 - 12 hours
5. 95% alcohol 1 - 12 hours
6. absolute 2 - 12 hours  
(100% alcohol - 2 changes)

The dehydrated object may then be transferred to a clearing agent such as xylene, clove oil or benzene, all of which are miscible with absolute alcohol. The material is kept in xylene until it is cleared; for objects less than 5 mm. about an hour may be required. Since xylene causes brittleness it should not be used for storage but clove oil is satisfactory.

The object may be examined microscopically in this condition in an open dish. However, if a more permanent preparation is required the object may be mounted on a microscope slide in what is called a mounting medium such as Euparal or Canada Balsam, the latter being in general use and readily available. The clearing agents such as xylol and clove oil are miscible with the mounting materials so the object may be transferred directly from xylene to Canada Balsam. If the object is fairly large a glass ring may be first glued to the glass slide. The ring is filled with Canada Balsam and the object inserted in it and then sealed with a cover slip, care taken not to entrap air bubbles in the process. If the object is fairly flat, narrow strips of glass may be glued to the microscope slide and the object placed between them and covered with Balsam followed by a cover slip.

For instance, to make permanent preparations of oyster larvae, after being concentrated and removed from the plankton sample, they are first narcotized with slowly added crystals of magnesium chloride. This should require only a few minutes after which they are fixed in 10% formaldehyde in sea water for an hour. The larvae are then dehydrated by holding them for 10 minutes or so in successive solutions of methylated spirits of 50%, 70%, 90%, 95% and 100% concentration. They may then be mounted directly on a microscope slide, preferably a well type, in Canada Balsam or with clearing in xylol. Preliminary staining with neutral red (in water) or Orange G in 95% alcohol may assist in differentiating various larval structures.

For examination of larvae in various positions, they may be mounted in glycerine jelly. The larvae may be placed in the jelly directly from water and may be oriented with a warm needle as required. Glycerine jelly is made up with 10 g. gelatine, 70 ml. glycerol, 0.25 g. phenol crystals and 60 ml. distilled water to mix. These components are warmed. The jelly sets firm and is re-warmed for application to a slide.

### Narcotics

To study some anatomical features it is often necessary to relax molluscs by means of drugs or narcotics. Common narcotics for marine animals are the magnesium salts, either chloride or sulphate. Gradual addition of crystals or prepared solutions, 7% magnesium chloride or 20% magnesium sulphate in sea water. Menthol crystals which act rather slowly are also useful. Propylene phenoxetol may be added slowly either as single drops (2 or 3 drops per litre) which sink to the bottom and diffuse from there or as

a mixed 1% solution in sea water. Molluscan larvae are narcotized within 24 hours.

Propylene phenoxetol is also used after formaldehyde fixation as a preservative and bactericide. With propylene glycol (0.5 grams of propylene phenoxetol and a 4.5 ml. of propylene glycol in 95 ml. of seawater) a fungicidal preservative that prevents specimens becoming brittle is formed.

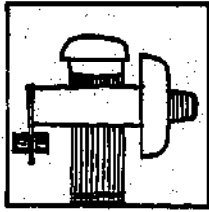

## microscope measurements

There may be occasions when it is required to measure dimensions of oyster larvae which are microscopic in size. There are special but costly instruments which are available but a simple method is with an ocular or a Filar micrometer.

An ocular micrometer is simply a round glass disc on whose surface a scale is etched. The divisions and lengths of the scale may vary. The micrometer is inserted in the microscope by removing one ocular, unscrewing the knurled ring at the base, inserting the ocular micrometer, right side up so the figures may be read correctly and then replacing the knurled ring. The object to be measured is placed along the axis of the scale and the number of divisions on the scale are read off or counted. (58a, b, c)

But these divisions are only relative and must be converted to absolute lengths. This is done by relating the number of divisions in the ocular to an actual distance scale placed on the microscope stage. The distance is on a micrometer slide which is a glass microscope slide with a 2 mm. scale etched upon it. The micrometer eye piece scale is lined up with the scale on the micrometer slide and the number of divisions on the ocular is counted to correspond to a specific distance on the micrometer slide. Thus the 50 ocular divisions equal 9 divisions on the micrometer scale which is in actual distance 0.9 mm. or 900 microns.

Therefore, one ocular division =  $900/50 = 18$  microns. So the oyster larva which measured 25 ocular divisions would measure  $25 \times 18$  microns = 450 microns. It must be remembered, however, that the eye piece must be calibrated for each ocular and each microscope objective used. It is wise to calibrate all oculars and

### 58 MICROMETER

#### a MICROMETER DISC

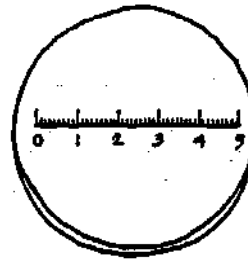

#### b MICROMETER SLIDE

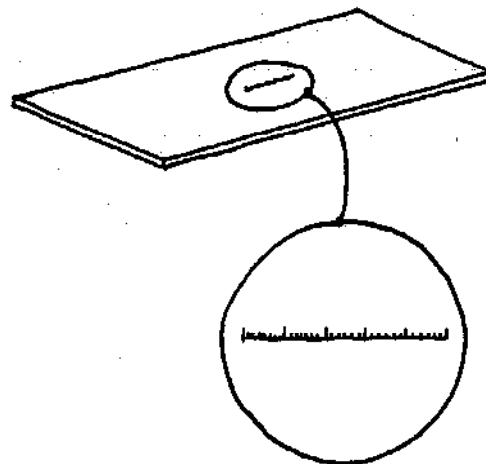

#### c ENLARGED SCALE OF MICROMETER SLIDE

and objectives likely to be used at one time. The other type of micrometer is the Filar type (59) - somewhat more costly than the eyepiece but more accurate and less time-consuming to use. This consists of an eye piece with a built-in scale or grid and a knob calibrated from one to a hundred. The turning of the knob causes a hairline called the cursor to move back and forth across the scale.

The Filar ocular replaces the normal microscope ocular in the microscope. To measure the object, a larva is placed along the scale in the micrometer and with the knurled knob the cursor is moved along to the left of the larva (60). It is noted this lies between 1 and 2 so the reading will be 1 and whatever is read off on the graduated ring on the side. In this case since the cursor is about half way between 1 and 2 it will read 55 and the figure 155 is recorded. The cursor is then moved to the right with the knurled knob until it lies on the other (right) end of the larva. This lies between 7 and about three quarters of the distance toward 8. The reading on the graduated ring is 75 so the number recorded is 775. In other words, the distance between the ends of the larva is the difference between the readings, or  $775 - 155 = 620$  micrometer divisions. Like the micrometer eyepiece, the Filar must also be calibrated against a micrometer slide and in this case it was found that for the objective in use one Filar division was equivalent to 0.72 microns. So the length of the larva was  $620 \times 0.72 \text{ microns} = 447 \text{ microns}$ .

There are other techniques used particularly for objects such as numbers of clam or oyster spat which are too large for microscopic measurements, but too small to pick up easily for manual measurement. One method is to spread the objects fairly evenly and photograph them. When the negative is blown up into a fair-sized print, then the picture of each specimen may be measured with a ruler, each one marked off as it is measured. The magnification of the print must be known and this may be checked by comparing several measurements of the real spat with their photos. For instance, if a real spat measured 3.5 mm. and the photograph measured 17.5 mm. then the magnification is  $17.5/3.5 = 5$  and the length of each one of the photographs must be divided by 5. Another method is to arrange the spat evenly (not touching) on an 8" x 11" glass plate. With a photostatic copy (xerox) the images of the spat will be recorded. Check should be made to determine if there is any magnification - but usually there isn't. They may be measured as in the case of the photograph print.

## 59 FILAR MICROMETER

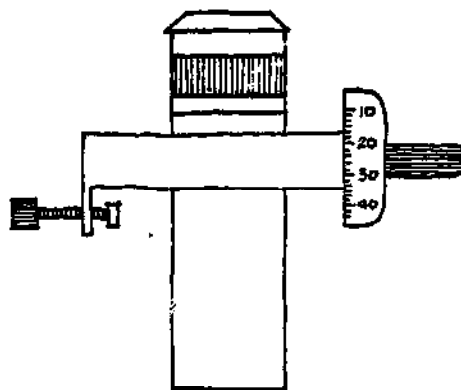

## 60 ENLARGED FILAR MICROMETER SCALE WITH OYSTER LARVA IN PLACE FOR MEASUREMENT

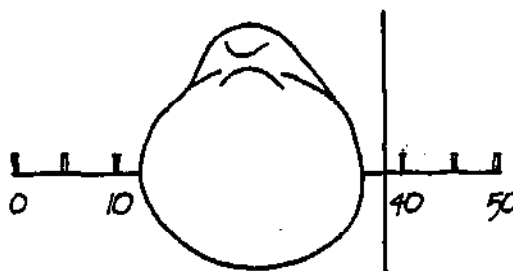



## land tenure

When oysters are cultured, either by collecting or purchasing seed or adults, they become personal property and must be placed in an identifiable location. This means some sort of hold on this area, by purchase or lease from government or a private individual. Only then may there be some measure of legal control or ownership of the oysters.

Generally there are three types of ownership of oyster ground, whether subtidal or intertidal.

### 1. Public oyster ground.

This is government owned oyster ground retained as such for the use of the public, either freely or through a permit or license system for all or only specific areas. Such ground may be held in reserve if it contains breeding stock which can seed adjacent grounds. Other grounds may be used as a public source of seed where re-seeding may take place naturally or cultch introduced under government auspices. In other cases public grounds may be seeded and the oysters allowed to grow to maturity until harvested by the public, i.e. bona fide oystermen. A royalty may be assessed on the quantity of oysters harvested. In countries where this system exists and the public ground is most often the best ground, the optimum potential return is seldom realized.

### 2. Public ground under lease.

This is a fairly successful system of oyster ground utilization. A government department, usually either Lands or Fisheries, leases ground to growers who must make serious use of it. This use is determined either by actual productivity

compared to an estimated potential or by requiring a minimal annual seeding per unit of area. Lease fees and/or land taxes or royalties on production are forms of payment for use of the land.

Important facets of the lease system are:

- a. Security of tenure. This is a necessity otherwise no one is willing to invest. Thus the lease period must be sufficiently long (most often 21 years) and probability of renewal must be high.
  - b. Fees or taxes should be at a level so as to induce the lessee to make diligent use of the land. If oyster ground is worth having, it is worth paying for. One plan is to make the initial fees and taxes minimal for the period of time required to produce the first and second crops.
  - c. It is important that leases be properly surveyed, marked and recorded.
3. Private ownership.

In this situation ownership of the oyster ground (usually intertidal) is in private hands with little or no governmental control. The owner may or may not make optimum or any use of the land and he may rent or sell it if he so wishes. However, since it is private land, it is taxed as upland.

4. Local control.

There are instances where villages and towns have control of the shellfish resources in the immediate area. Use of the resource is confined to local citizens.



## statistics

Even in its most advanced stages shellfish culture requires continuous experimentation, either by the grower himself or by shellfish biologists, to increase efficiency or to test the usefulness of adaptations or changes in methods or equipment. If the differences found are very great there may be little doubt of their reality or significance. When the differences are relatively small, some quantitative measures are required to determine whether they are real and repeatable or were due simply to chance. In its ultimate form bio-statistics has become mathematically complex. However, there are a few simple procedures that serve most purposes. Fortunately also, shellfish experimentation is similar to that in agriculture where plots are used extensively and statisticians have worked out procedures that are directly applicable to molluscan problems. These may be used both in planning the experiment and its statistical analysis. In fact, the statistical methods to be applied in the analysis should be a part of the planning process. For this it may be necessary to seek professional help.

Averages or means of such factors as growth (length, width, thickness, volume) or condition factors (fatness) of oysters are used for comparative purposes. But quantitative statistical differences cannot be ascertained without a measure of the variation within the samples whose averages are being compared. If one group of oysters has a mean length of 50 mm. and another group a mean of 100 mm. it may be reasonably certain the means of the two groups are in fact different and not a result of chance

variations. However, if one group had a mean of 72 and another a mean of 50 only a mathematical test may determine whether they are statistically different and this may best be determined from a knowledge of the extent of variation in each group. This is the reason for replications or repetition of units or plots in field or even in laboratory experiments.

For instance, in connection with a pulp mill pollution study, the condition factor of oysters at varying distances from the pollution source was to be taken as a measure of the effects of the pollutant on the assumption they would decrease with distance. A single measurement from each site would have meant very little, so the experiment was replicated. Instead of one plot (a tray in this instance) a series of six was placed at each of three sites. In this way the variation in condition factor at each of the sites was obtained and valid comparisons between the condition factor at the three sites was possible. The design of the experiment was based on what is known as "randomized blocks" and the statistical analysis termed the "analysis of variance".

In another instance it was desired to compare the mortality of oyster seed grown on the bottom having various depths of silt with those grown on trays where of course there was no silt. Here the experiment was arranged in what is called a 2 x 2 Latin square (4 plots in a square) replicated 4 times. Each treatment (seed on the bottom, seed off the bottom) was repeated twice in each of the four 2 x 2 blocks. Approximately 1500 seed oysters were placed in each of the 16 plots and recounted 8 months later. The statistical analysis was also carried out by the analysis of variance.

These and many other designs may be found in Wishart and Sanders (1955) and Sokal and Rohlf (1960) as well as in many other texts on experimental analysis and statistics.

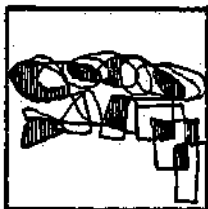

# pollution

Filter feeding molluscs have a high capacity to concentrate chemicals and small particles from waters in which they live. Therefore, they frequently create public health problems. This is often so in the tropics where most areas with potential for oyster culture occur in estuaries and where high populations and industries occur.

The two major types of pollution which may affect oysters and their consumption are industrial and sewage.

## INDUSTRIAL POLLUTION

This type emanates from industrial wastes from pulp mills, chemical or food processing plants. A single source of pollution may not be of significance, but may provide a nucleus around which further industrial development takes place and the resultant combination of pollutant sources may be sufficient to cause difficulty. Industrial effluents, when discharged into a body of water may have characteristics which are able to affect the organisms such as oysters which live there. These are:

1) Toxicity, 2) Oxygen demand, 3) Particulate matter.

### I. Toxicity.

The source of toxicity in industrial effluents is certain of its chemical constituents. There may be a direct immediate toxic action on shellfish, whose tissues may be harmed or whose physiological activities may be impaired. The indirect effects influence the environment, particularly food organisms on which molluscs depend.

## 2. Oxygen Demand.

Certain industrial effluents such as pulp mill wastes contain organic materials which, upon decomposition, require large amounts of oxygen. This oxygen requirement is called biological oxygen demand (B.O.D.) and can denude surrounding waters of this material on which most living organisms depend. If the oxygen concentration is lowered sufficiently, animals in the area may suffocate.

## 3. Particulate Matter.

This may be wood particles from a pulp mill operation or other organic debris from food manufacturing plants. These may form a mat on the bottom to create an oxygen demand or the suspended particles may clog the gills of filter feeding organisms.

The effect of these factors on oysters in the vicinity of industrial plants may be felt in several ways.

1. Mortality.
2. Reduced growth rate.
3. Reduced fatness.
4. Effect on breeding.
5. Heavy metal toxicity.

However, the measurement of these factors, while not particularly difficult in itself, becomes a complex problem when effects of the effluent have to be separated from the wide natural variations that occur normally in non-polluted areas. It would seem the obvious solution is to measure these factors against known levels of pollution in the laboratory. But this requires a sophisticated laboratory, a water supply and a multitude of measuring instruments. It is often difficult to transfer these results from the static laboratory environment to the field situation which is dynamic with temperature, salinity, light, food supply, currents, etc. in continuous change.

Thus field studies provide a more accurate measure with less complexity, if a measure such as condition factor is utilized. This integrates or combines the various physiological activities of the oyster such as heartbeat, ciliary activity, adductor muscle action, mantle movements and activities which control the intake of food. In addition to the actual measurement of condition factor, the design of the experiment is important. To determine the effect of varying effluent concentrations experiments should be arranged at varying distances from the effluent outfall assuming that concentration will vary with distance. The distances will depend on the local topography and current configurations. Usually spacing experiments about a kilometre apart is satisfactory.

A randomized block design with six replicates at each of 3 stations may be selected. This requires at each station 6 trays on a rack at similar tidal levels, or suspended from a float, if the oysters are a subtidal species. Enough oysters to provide at least 150 per tray (1 metre x 1 metre) are required. The 2700 oysters are divided randomly into 16 groups and these in turn are randomly assigned to a specific tray. (See a statistical text for methods of randomization.) Then after the beginning, when the condition factor of all of the trays should be approximately the same, samples of 10 to 15 oysters from each tray are taken and determinations made at monthly intervals for at least a year. This allows for seasonal differences and time for the effluent effects to become effective.

Such a design allows for a standardized statistical analysis (analysis of variance) where the differences, if any, between stations and within a station may be assessed. If a biological statistician is available he should be consulted, both for assistance in designing the experiment and in the analysis of results.

## HEAVY METAL POLLUTION

Filter feeding shellfish are capable of removing from the water, and accumulating in fairly high concentrations, a number of heavy metals such as zinc and copper. While



the animal itself may not be harmed by such toxic metals, its consumption by humans can result in illness if the concentration is high enough. The concentration of heavy metals in shellfish may be readily determined by an adequately equipped laboratory and compared to the standards applicable in the particular country.

#### SEWAGE POLLUTION

Oysters and other shellfish have no known disease of their own which they can transmit to man. However, they have frequently been the agents by which such diseases as typhoid fever and infectious hepatitis have been transmitted. Since the oyster is a filter-feeding organism, it collects and concentrates the most minute particles from the water in which it is living and, among these, are bacteria and viruses.

It has been shown that bacteria, once collected by shellfish, are able to survive for long periods even under refrigeration. Under normal storage conditions they are able to multiply within the bodies of shellfish. The usual cooking methods may destroy some bacteria, but others are resistant to heat and among these are a few harmful (pathogenic) types. Processing methods for fresh shucked oysters do not destroy such bacteria, and indeed, they are often a means by which shellfish may be further contaminated. Contamination of oysters may originate in the waters in which they are grown and in processing and marketing procedures.

#### POLLUTION IN GROWING WATERS

Waters where shellfish are grown may be polluted by direct discharge of main sewers into the area or by drainage from individual, improperly installed or improperly functioning septic tanks. Pollution may also occur indirectly by runoff from land through seepage after rains, or river discharge. Boats discharging sewage may be a significant source of pollution.

Therefore, sanitary control in a shellfish industry is of utmost importance. This is carried out by:

1. Bacterial examination of growing waters. In most countries there are regulations regarding the allowable number of bacteria where shellfish are cultured. Human faecal coliform bacteria are used as the indicator organism and there are standard techniques for these measurements.
2. Sanitary surveys. All the possible sources of contamination in the area in question are noted and related to the current configuration to determine whether growing areas may be contaminated. This is a most important part of shellfish sanitation.
3. Strict regulations governing the operation of storage areas of processing plants.
4. Bacterial examination of the final product at the market level.

#### PURIFICATION OF SHELLFISH

Shellfish purification (sometimes called "depuration") is based on the knowledge that filter-feeding molluscs remove solid particles from the water around them, digest some, and pass out the remainder enmeshed in the mucus of faeces and pseudofaeces. Thus if an oyster is placed in a container of water contaminated with bacteria it will filter out all of the bacteria and eventually reduce the bacterial content of the oyster itself. This is the principle for purification procedures. The simplest way is to transplant the oysters from a contaminated to an uncontaminated area for about 48 hours. The alternative is to provide holding tanks in which the oysters are placed and through which flows pure or purified water. If the source of the water is contaminated, it is possible to purify it with chlorine, ozone or exposing it to ultra violet light.

Purification increases the cost of producing oysters and, if possible, uncontaminated areas should be sought. However, it may be seen that shellfish sanitation control is

an important part of the oyster industry. This control may be exercised only by specially trained personnel with a well-equipped laboratory.

#### PARALYTIC SHELLFISH POISON

This occurs when shellfish feed on certain species of microscopic planktonic dinoflagellates. Filter-feeding molluscs concentrate the poison from the dinoflagellates without harm to themselves. However, warm-blooded animals are poisoned when such shellfish are eaten. The poison is highly toxic and may cause death. Measurement and detection of the poison is done either by a complicated chemical procedure or by a bioassay where a number of laboratory mice are injected with an extract from the presumed toxic shellfish.

Paralytic shellfish poisoning is a continuing problem in temperate waters on both sides of North America but fortunately there have been few paralytic shellfish poison outbreaks in the tropics. So far, only Papua New Guinea and Sabah (Malaysia) have had infrequent outbreaks. Record should be kept of the occurrence of planktonic blooms which discolour the seawater.

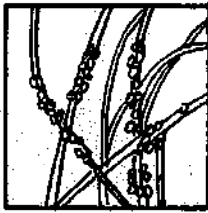

## mangroves

Most estuaries and many open sea shores around the world between 25° North latitude and 25° South latitude are lined with dense forests of mangrove trees. In estuaries particularly, the ground is low-lying and generally swampy, hence the name mangrove swamps.

While there is a wide variety of trees, the main species are the red mangrove (Rhizophora), the black mangrove (Avicenna) and the white mangrove (Laguncularia). Rhizophora is characterized by the numerous arching roots that support the main tree while Avicenna lacks these but instead has pneumatophores arising from subterranean roots. Mangroves occur in a variety of tidal ranges from 1 foot to 10 feet. Typically the red mangrove occurs closest though not always, to the open water and the roots range from the subtidal at the lower levels to about high water at the upper level of the range. Avicenna begins just below the level of high water and carries on to just above it. New red mangroves may grow in about 16 inches of water, mature trees in 10 inches and the black mangrove in about 6 inches. Here it often merges into buttonwoods (Conocarpus) before the true tropical forest begins beyond the swamplands.

Mangroves appear to require salt water but they grow under a wide range of salinity conditions, from high up estuaries where flooding creates fresh water conditions for long periods, to open ocean conditions. They may grow in most types of soil except possibly shifting sands. A marl-mud and peat deposited by the trees themselves are the typical soil conditions.

In the mangrove environment, unlike tropical forests, plant diversity is very low. However, animal diversity is high and an excellent animal habitat is provided. The trees contribute only indirectly to the food supply of the swamp and this mainly through organic debris from leaves and twigs which is the medium of supply of microorganisms such as fungi, bacteria and protozoa. As a result mangrove forests are considered to be the most productive of all estuarine environments although plankton production is generally not of a high order.

Mangroves are of importance as a buffer against erosion from hurricane damage and

tidal currents. They provide a nursery for many species of fish, shrimp and molluscs of economic importance. The mangrove tree itself is a source of fuel, either as wood or charcoal, of pulp for paper manufacture, and of tannins, dyes and various medicinal products. Because of the importance of these properties, mangroves must be carefully preserved and exploited only to an extent that would not provide an imbalance of the existing ecological situation.

This is particularly so in the case of oysters for the stocks that occur on the mangroves usually form the only breeding populations. Stocks that may be developed by a culture would have to be more extensive than anything presently envisaged to compensate for the loss of the available natural stocks. However, since the mangrove roots are natural oyster spat collectors, controlled cutting to obtain seed might be acceptable providing the oyster bearing mangrove area is large enough.



## study priorities

Development of an oyster culture in a new area where no previous information is available requires a considerable period of time. Usually, owing to manpower and financial problems, not all of the necessary information may be gathered simultaneously. Even with adequate resources there is the element of time since the study of one facet is often dependent on the completion of a previous one. Some clear priorities are therefore required. The three phases of immediate importance are growth, breeding, and oceanography.

Growth studies will provide information on the rate, indicating the period of time to reach marketable size, the periods of the year of most rapid growth, the variation in growth over the study area and the differences in growth with tidal level or with depth below the surface. Also of importance is the relationship between shell size and amount of oyster meat. This will require some effort since the number of oysters required to give reliable results is considerable, up to several hundred oysters per station. The number of stations or sites will depend on the size of the study area, on the geographic configuration, on possible salinity gradients and on the degree of tidal rise and fall.

Studies of the breeding cycle are necessary to determine when it occurs, the sites with the best spatfalls and the most desirable depths or levels. Coupled with the breeding study, if possible, the usefulness of local materials as spat collectors could be investigated but this usually comes later. Collection of spat based on breeding information is the foundation on which any oyster industry rests.

Growth and breeding are often related to oceanographic conditions so some knowledge of these is necessary. In the tropics water temperature varies only slightly on a seasonal basis but in some cases even small changes may be significant. In most instances, since estuaries are usually involved, salinity is the major hydrographic variable so seasonal and depth changes must be examined. Current configurations must also be determined.

With basic information on these factors the main study on the main or alternative culture methods may be started. Simultaneously, studies might be carried out on the fatness (condition factor) cycle, the fouling sequence and the occurrence of predators.

It may seem that in the priorities listed above some important studies usually associated with oyster culture have not been mentioned. Among these is the

productivity of the growing waters as related to nutrient salt levels and to various components of the plankton generally regarded as oyster food. However, these and similar studies can be done later when the basic culture system has been developed. Since it is testing the water nearly continuously when immersed, the oyster itself will indicate the quality of the water in which it is being grown by its survival, rate of shell growth and condition factor of the meat.

A useful system of oyster culture is most rapidly developed by simple and direct methods of study.



## **glossary**

- adductor - muscle holding two valves together  
algae - marine plants or seaweeds which reproduce by spores  
amoeba - a primitive unicellular animal  
anisomyarian - mollusc with adductor muscles of unequal size  
anomiid - a mollusc of the family Anomiidae, sometimes called rock oysters, jingles or money shells  
anterior - front or head  
aragonite - a form of crystalline calcium carbonate  
auricle - chamber of the heart into which blood is received from the body
- barnacle - an immobile shelled crustacean adhering to solid surfaces.  
bioassay - a test in which the quantity or strength of material is determined by the reaction to it of a living animal  
B.O.D. - abbreviation for biochemical oxygen demand; the amount of oxygen absorbed by a putrefying waste  
box - pair of empty oyster valves  
branchial - pertaining to the respiratory organ or gill of an aquatic animal  
bushel - 8 dry U.S. gallons or 1.245 cubic feet  
byssus - filaments used by a mollusc to attach itself
- caecum - a blind pouch usually associated with the alimentary canal  
caliper - a jawed device for measuring small objects  
capillary - a tiny, thin-walled blood vessel of small diameter  
cerebral - pertaining to the brain  
chitin - a relatively inert skeletal material found mainly in insects  
cilia - a hairlike process with a rhythmic beat which in molluscs produces a current  
cloaca - a posterior chamber into which open the anal, urinary, and genital ducts  
coliform - refers to the bacteria found in the colon of the digestive tract  
commensal - an animal living in close association with another species without causing it significant harm or where the association may be mutually beneficial  
conchologist - a person who studies molluscan shells  
conchyolin - horny substance found in molluscan shells  
condition factor - a measure of plumpness or fatness of an oyster  
copepod - a class of small Crustacea, some free swimming, some parasitic  
Crustacea - a group of aquatic animals characterized by jointed legs, i.e. crabs, shrimps  
crystalline style - gelatinous rodlike organ of certain molluscs, concerned with digestive processes  
cultch - material used to collect oyster spat  
culture - a controlled method of growing oysters
- demibranch - single plate or leaf of a molluscan gill  
deputation - term used in the United States for purification of shellfish of bacteria  
detritus - term given to fragmented organic material from plant and animal remains  
diatom - a one-celled primitive plant enclosed in a siliceous container  
dinoflagellate - a motile one-celled organism with some animal and some plant characteristics  
dissoconch - post larval or adult shell  
diurnal - daily  
diverticulum - lateral outgrowth of the stomach cavity

dorsal - pertaining to the back or part of an animal away from the ground  
drill - snail preying upon other molluscs which it penetrates with a drilling apparatus

eelgrass - a green bladelike marine plant which reproduces with seeds; a true plant and not a seaweed

effluent - discharge of fluid materials from land to water

enzyme - chemicals produced by living cells which aid, but do not take part in, chemical reactions

estuary - river mouth where the sea and fresh water tend to mix

exhalant - emitting or discharge area

faeces - indigestible residues remaining in the alimentary canal after digestion

fertilization - the union of the egg and sperm

filter feeder - marine organism such as an oyster which obtains food by filtering it from the surrounding water

flagellate - microscopic sized organisms propelled by a whip-like body called a flagellum

flatworm - a group of flat, leaflike worms, many of which are parasitic

fluting - curved platelike outgrowths on the surface of a molluscan shell

follicle - a small, saclike structure

foreshore - land below the high tide mark

fouling - marine animals attached to species being cultured

gallon - a volume measurement equalling four quarts or four and one half litres

gamete - sex cell as egg or sperm

ganglion - an aggregation of nerve cells

gaper - bivalve mollusc dead or in the process of dying, with the valves gaping but with some meat left within

gastric - pertaining to the stomach

gastropod - a class of molluscs usually with a single coiled cell

genus - a classification category. Animals and plants are designated by generic and specific names, i.e., Crassostrea (genus) gigas (species)

gill - a leaflike appendage of an aquatic animal and concerned with breathing

glycogen - an animal starch

gonad - the sex gland which produces either eggs or sperm

gribble - a small wood-boring crustacean

halocline - the area of sharp vertical salinity change

hardening - with oysters the process of acclimation to longer and longer periods out of water

hybrid - the offspring of the union between two different species or races

hyostracum - layers of shell material under the area of adductor muscle attachment

incubate - to hold eggs during development

inhalant - the drawing in of a liquid

intracellular - within the cell

invertebrate - an animal without a backbone

labial - pertaining to the lips

lamella - a leaf or platelike structure

lamellibranch - a grouping of molluscs based on the type of gill; includes clams and oysters

larva - an immature stage between the egg and the adult form

larviparous - carrying the young within the parent's shell

lease - rented foreshore area

length-frequency - where the number of objects with equal lengths are tabulated or graphed

lessee - individual who obtains a foreshore lease

ligament - fibrous springlike material joining two valves

lobe - a rounded or flaplike projection

mantle - a soft fold enclosing the body and which secretes part of the shell  
 mean - average  
 micrometer - an instrument for measuring small lengths or distances accurately  
 microgram - one thousandth of a gram; one gram equals 0.0353 ounce  
 micron - a microscopic length measurement. One thousand microns in one millimeter  
 mouse unit - a measurement unit of paralytic shellfish poison

nacre - iridescent calcareous substance composing the innermost layer of a molluscan shell  
 narcotize - to immobilize a living animal for a short time  
 neap - series of tides with a relatively small tidal range

ocular - viewing eye piece in a microscope  
 oceanography - broadly the study of the oceans  
 oesophagus - junction canal between the mouth and stomach  
 ovary - female reproductive organ producing eggs  
 ovum - egg

palp - a sensory appendage  
 parasite - an organism which lives in or on another organism and derives subsistence from it without rendering it any service in return  
 pedal - pertaining to the foot or feet  
 pericardium - the space or membrane surrounding the heart  
 periostracum - the horny outer layer of a molluscan shell  
 peritoneal - pertaining to the body cavity  
 pest - a predator or parasite  
 pholad - mollusc belonging to a group of clams which are able to burrow into soft rock or shell  
 pinworm - marine wood-boring crustacean (Limnoria) also called the gribble  
 pinnotherid - a commensal crab which lives within the mantle cavity of an oyster or in association with various other marine animals  
 plankton - floating or weakly swimming aquatic animals and plants  
 pleural - pertaining to the pulmonary cavity  
 plica - a foldlike structure  
 pneumatophore - aerial root of the mangrove tree  
 poach - a mild term for theft  
 pore - a small aperture  
 posterior - the rear; further away from the head  
 predator - an animal which kills and consumes other animals for food  
 prodissoconch - a larval shell of a mollusc  
 promyal - in front of the muscle  
 provinculum - straight part of a hinge of a shell and which contains teeth  
 pseudofaeces - false faeces; waste material not taken into the digestive tract

random - by chance rather than by selection  
 ray - a specialized group of flat fishes with wing-like flaps rather than fins for swimming  
 relay - another term for "transplanting" shellfish from one bed to another  
 respiration - the interchange of oxygen and carbon dioxide associated with energy utilization

sac - any baglike or pouchlike structure  
 salinity - in oceanography the salt content of sea water usually measured in parts per thousand (‰)  
 scallop - a species of mollusc shaped like the Shell Oil sign  
 seed - a young oyster  
 set - the accumulated settlement or spatfall of oyster larvae  
 shell stock - general term for unopened oysters in the shell  
 shuck - to open and remove the oyster meat from the shells  
 sink float - a raft, usually of logs with the floors sunk below the surface of the water  
 spat - a newly settled or attached young oyster; a postlarval oyster  
 spatfall - the settlement of oyster larvae  
 spawn - common term for eggs and sperm

sperm - the motile male reproductive cell  
spring - series of tides with a relatively large tidal range  
starfish - a five or ten armed marine animal  
statocyst - an organ for the perception of the position of the body in space  
sterile - with no contaminating organisms  
sulphate - a pulp mill process (alkaline) where sodium hydroxide and sodium sulphite are used for cooking the pulp  
sulphite - a pulp mill process (acidic) where sulphurous acid with a calcium or magnesium base is used for cooking the pulp  
suprabranchial - also epibranchial meaning above the branchium or gill

taxonomy - the science of naming animals and plants  
testes - the male reproductive organ producing sperm  
thermocline - the area of sharp vertical temperature change  
thermograph - an instrument for recording temperature  
transplant - another term for relay; to move oysters from one bed to another  
trochophore - an early larval stage of an oyster just before the shell is formed  
trophic - pertaining to nutrition  
tubule - a small tubular structure  
turbidity - the amount of suspended small particles in a liquid

umbo - (plural umbones) the beaklike projection which represents the oldest part of a bivalve shell

valve - one of several pieces composing the shell of molluscs or barnacles  
veliconcha - a molluscan larva with both types of prodissoconch shell  
veliger - the secondary larval stage of most molluscs characterized by the presence of a velum  
velum - the ciliated locomotor organ of the molluscan veliger larva  
ventral - pertaining to that aspect or side of an animal facing the ground  
ventricle - the main contractile chamber of the heart  
vesicle - a small bladderlike sac or pouch  
viable - capable of living and developing normally  
visceral - pertaining to the organs within the body

year-class - a group of animals spawned close together in time during any one year





## references

- ARAKAWA, K. Y., 1973. Handbook for prevention and extermination of fouling organisms attached to cultured oysters. Hiroshima Fisheries Experimental Station, Hiroshima, Japan. Canadian Translation #522189. An extensive examination of the fouling problem in Japan with details on methods of control of the various species.
- CAHN, R. A., 1950. Oyster Culture in Japan. U.S. Fish and Wildlife Service Fishery Leaflet 383. U.S. Government Printing Office, Washington 25, D.C. A detailed and well illustrated account of the biology and methods of culture of a number of Japanese oyster species. The emphasis is on raft culture.
- CHANLEY, P. E. and J. D. ANDREWS, 1971. Malacologia 11(1): 45-119. Aids for identification of bivalve larvae of Virginia.
- GALTSOFF, P. S., 1964. The American oyster Crassostrea virginica (Gmelin). Fishery Bulletin of the Fish and Wildlife Service. 64. U.S. Government Printing Office, Washington 25, D.C. pp. 480 A detailed and extensive account of the anatomy and physiology of this species.
- HYMAN, L.H., 1967. The Invertebrates, Volume VI - Mollusca I. McGraw-Hill Book Co., Inc., New York & London. 792 p.
- KORRINGA, P., 1976. Development in Aquaculture and Fisheries.
- Volume 1. Farming marine organisms low in the food chain. 264 p.
- Volume 2. Farming the cupped oysters of the genus Crassostrea. 224 p.
- Volume 3. Farming the flat oyster of the genus Ostrea. 238 p.
- Elsevier Scientific Publishing Co., Amsterdam-Oxford-New York. A comprehensive examination of oyster culture methods and economics in a number of countries. Selected farming operations are studied in detail.
- LOOSANOFF, V. L., 1965. The American or eastern oyster. Circular 205. Bureau of Commercial Fisheries, U.S. Fish and Wildlife Service. U.S. Government Printing Office, Washington 25, D.C. A brief account of the culture of Crassostrea virginica on the eastern coast of the United States.
- LOOSANOFF, V. L., H. C. DAVIS and P. E. CHANLEY, 1966. Dimensions and shapes of larvae of some marine bivalve molluscs. Malacologia 4, No. 2:351-935. About 20 larvae of common bivalve species, mainly from the western Atlantic, are described and illustrated. Includes a general discussion of the problems of larval identification.
- MEDCOF, J. C., 1961. Oyster farming in the Maritimes. Bulletin No. 131. Fisheries Research Board of Canada. Queen's Printer, Ottawa. A comprehensive account of oyster culture as practised in the Maritime Provinces of Canada.
- MIYAZAKI, I., 1936. On the development of some marine bivalves, with special reference to the shelled larvae II. Jour. Imp. Fish. Inst. XXXI, pp. 35-41. Identification and good illustrations of a few common Japanese bivalve larvae.

- PANTIN, C. T. A., 1946. Notes on microscopical technique for zoologists. Cambridge University Press. pp. 73. A basic text for the non-specialist.
- QUAYLE, D. B., 1969. Pacific Oyster Culture in British Columbia. Bulletin 169. Fisheries Research Board of Canada. Queen's Printer, Ottawa. 192 p. A comprehensive account of all phases of oyster culture as practised in British Columbia. Includes sections on anatomy, life history, and production culture methods, processing, sanitation, processing and administration.
- QUAYLE, D. B., 1971. Pacific oyster raft culture in British Columbia. Bulletin 178. Fisheries Research Board of Canada. Queen's Printer Ottawa. pp. 34. A brief account of methods of raft culture applicable to British Columbia conditions.
- QUAYLE, D. B., 1975. Tropical oyster culture. A selected bibliography. International Development Research Centre. IDRC-052e. Ottawa. pp. 40 A basic list of publications on tropical oyster culture.
- QUAYLE, D. B. and D. W. SMITH. A guide to oyster farming. Marine Resources Branch. Department of Recreation and Travel Industry. Victoria, B.C. pp. 54. A simplified version of Quayle, Bulletin 169 with up-dated economic information.
- REES, C. B., 1950. The identification and classification of lamellibranch larvae. Hull Bulletins of Marine Ecology. Vol. III, No. 19, pp. 73-104. Methods of larval identification and a classification scheme which aids in placing a larvae within a particular group. While based on North Sea larvae it is useful elsewhere.
- SOKAL, R. and F. J. ROHLF, 1960. Biometry. W. H. Freeman, San Francisco. pp. 776. A comprehensive text on statistical techniques in biology.
- STEEDMAN, H. F. (ed.), 1976. Zooplankton fixation and preservation. Monographs on oceanographic methodology #4. The Unesco Press. Paris. A series of articles regarding treatment and preservation of plankton samples. There is a section on bivalve larvae.
- THOMSON, J. M., 1954. Handbook for oyster farmers. C.S.I.R.O. Australia, Division of Fisheries, Circular No. 3, pp. 21. An outline of the basic biology of the Australian oyster and details of the stick method of oyster culture.
- WALNE, P. R., 1974. Culture of Bivalve Molluscs. Fishing News (Books) Ltd., 23 Rosemount Ave., West Byfleet, Surrey, England. pp. 173. 50 years experience at Conwy.
- WISHART, J. and H. G. SANDERS, 1955. Principles and Practices of Field Experimentation. 2nd ed. Technical Communication 18 of the Commonwealth Bureau of Plant Breeding and Genetics, Cambridge. W. Heffer & Sons, Ltd. Cambridge, pp. 133. Describes specific examples of field experiments in agriculture, many of which are directly applicable to shellfish studies.
- YONGE, C. M., 1960. Oysters. Collins, Lond & Glasgow. pp. 209. A general text on most aspects of the oyster including history, geology, anatomy, life history, and culture in various parts of the world.