

AT MICROFICHE
REFERENCE
LIBRARY
A project of Volunteers in Asia

Food Cycle Technology Source Book 2:
Fruit and Vegetable Processing

ITDG / UNIFEM Project GLO/85/W02

Published by: United Nations Development Fund for Women
304 East 45th Street
New York, NY 10017

Available from: Food Technologies
United Nations Development Fund for Women
304 East 45th Street
New York, NY 10017

Reproduced with permission.

Reproduction of this microfiche document in any form is subject to the same restrictions as those of the original document.

UNIFEM

THE UNITED NATIONS DEVELOPMENT FUND FOR WOMEN

Fruit and Vegetable Processing



2 FOOD CYCLE
TECHNOLOGY
SOURCE BOOK

UNIFEM - All Rights Reserved.
Copyright © 1983
United Nations Development Fund for Women (UNIFEM)
304 East 45th Street
New York
N.Y. 10017, U.S.A.

Design and layout by Verdegrafica & Pubblicità, Piazza Cairoli 6,
00186 Rome, Italy
Drawings by Peter Dobson, U.K.
Printed by Photosistem, s.r.l. in Rome, Italy

FOOD CYCLE TECHNOLOGY SOURCE BOOK NO. 2

Fruit and Vegetable Processing

UNIFEM

THE UNITED NATIONS DEVELOPMENT FUND FOR WOMEN

**PROJECT GLO/85/WO2 - WOMEN AND FOOD CYCLE
TECHNOLOGY (WAFT) AND PROJECT RAF/86/WO3 -
TRANSLATION AND PUBLICATION OF FOOD CYCLE
TECHNOLOGY SOURCE BOOKS**

With the collaboration of the

**INTERMEDIATE TECHNOLOGY DEVELOPMENT GROUP
United Kingdom**

1988

PREFACE

UNIFEM AND THE FOOD CYCLE TECHNOLOGY PROJECT (WAFT)

The United Nations Development Fund for Women (UNIFEM) was established in 1976 and is an autonomous body associated, since 1985, with the United Nations Development Programme. UNIFEM seeks to free women from under-productive tasks and augment the productivity of their work as a means of accelerating the development process. It does this through funding specific women's projects which yield direct benefits and through actions directed to ensure that all development policies, plans, programmes and projects take account of the needs of women producers.

In recognition of women's special roles in the production, processing, storage, preparation and marketing of food, UNIFEM initiated in 1985 a Food Cycle Technology project (project GLO/85/WO2: WAFT) with the aim of promoting the widespread diffusion of tested technologies to increase the productivity of women's labour in this sector. While global in scope, this five-year project is initially being implemented in Africa in view of current concerns over food security in many countries of the region. The eventual aim of the project is to increase indigenous capacities to respond to the technology needs of women producers and to inform and influence the decision makers who can create the correct policy environment for this to happen. This will be achieved by providing appropriate technical assistance relating to the process of technology choice and diffusion.

This source book is one of a series being compiled as part of the preparatory phase of the Food Cycle Technology project. UNIFEM hopes that these source books will increase awareness of the range of technological options and sources of expertise, as well as indicating the complex nature of designing and successfully implementing technology projects and diffusion programmes.

Titles in this series include: Oil Extraction, Fruit and Vegetable Processing, Cereal Processing, Rootcrop Processing, Fish Processing, Packaging, Drying and Storage. Source books will also be available in French and Portuguese.

ACKNOWLEDGEMENTS

This initial series of food cycle technology source books has been prepared at the Intermediate Technology Development Group (ITDG) in the United Kingdom within the context of UNIFEM's Women and Food Cycle Technologies (WAFT) specialization. During the preparation process the project staff have contacted numerous project directors, rural development agencies, technology centers, women's organizations, equipment manufacturers and researchers in all parts of the world.

UNIFEM and ITDG wish to thank the several hundred agencies and individuals who have contributed to the preparation of the source books. Not all can be mentioned by name, but special thanks are owed for their major contributions to the International Labour Organization (ILO), the Food and Agriculture Organization of the United Nations (FAO), the United Nations Children's Fund (UNICEF), the Economic Commission for Africa (ECA), the German Appropriate Technology Exchange (GATE/GTZ) in Eschborn, the Groupe de Recherche et d'Echanges Technologiques (GRET) in Paris, the Royal Tropical Institute (KIT) in Amsterdam, the International Development Research Centre (IDRC) in Ottawa, the Tropical Development Research Institute (TDRI) in London, Appropriate Technologies International (ATI) in Washington, the Institute of Development Studies, Sussex University (IDS), and the Save the Children Fund.

The preparation of the source books has been funded by UNIFEM with a cost sharing contribution from the Government of The Netherlands.

UNIFEM is particularly grateful to the Government of Italy for providing the funds for translation and printing of the source books and to the Italian Association for Women in Development (AIDOS) for implementing this phase of the project.

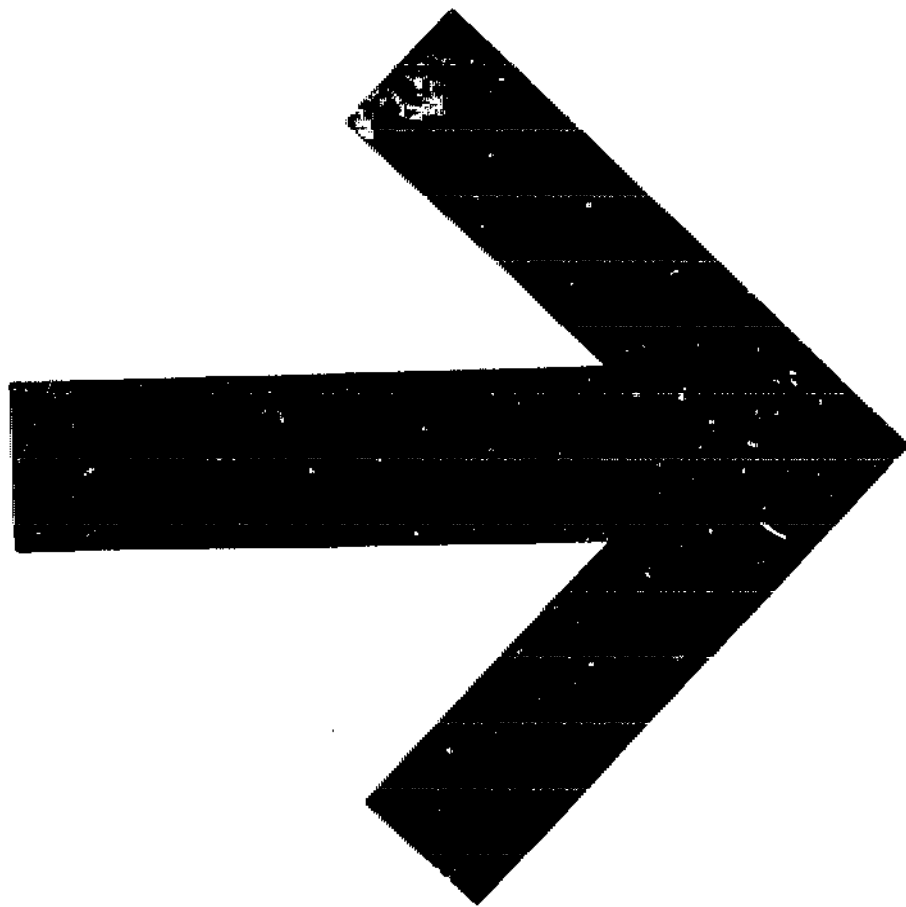

CONTENTS

INTRODUCTION	7
SECTION 1	
FRUIT PROCESSING	9
Fruit Preserves, Drinks, and Pickles Fermented Fruit Products Dried Fruit Products	
SECTION 2	
VEGETABLE PROCESSING	20
Salted/Brined and Pickled Vegetable Products Fermented Vegetable Products Dried Vegetable Products	
SECTION 3	
CASE STUDIES	23
SECTION 4	
CHECKLIST FOR PROJECT DESIGN	35
SECTION 5	
FACTS AND FIGURES ON AVAILABLE TOOLS AND EQUIPMENT FOR PRESERVES, DRINKS, AND PICKLED FRUIT OR VEGETABLE PRODUCTS	36
SECTION 6	
FACTS AND FIGURES ON AVAILABLE TOOLS AND EQUIPMENT FOR FERMENTED AND DRIED FRUITS AND VEGETABLES	52
SECTION 7	
REQUIREMENTS FOR SETTING UP A SMALL FOOD PROCESSING UNIT	57
APPENDIX	
BUILDING REQUIREMENTS	58
FURTHER READING	59
CONTACTS	66

INTRODUCTION

This source book is designed for people who have no technical background or previous knowledge of fruit and vegetable processing. It offers information on existing ways of improving the technology of food processing and increasing the quality and range of foodstuffs produced. It is, however, not meant to provide a manual on the actual processing.

Owing to the large number of different available commodities, the wide range of processing techniques and levels of technology which can be applied, the coverage of this source book is inevitably limited. Where possible, sources of further information have been indicated so that readers with particular interests can acquire the details necessary to implement the chosen processing method.

One important point is worth noting here: there is an essential difference between the processing of fruits and vegetables.

- **Fruits** are nearly all acidic and are thus commonly called 'high acid foods'. This acidity naturally controls the type of micro-organism that can grow in fruit products. In fact the only spoilage micro-organisms likely to be found in such products are yeasts and moulds, which very rarely cause illness if consumed. However, the acidity level decreases for many tropical fruits, such as banana, mango, papaya, when ripe.

- **Vegetables**, on the other hand, are less acidic and are often classified as 'low acid products'. Many dangerous food poisoning organisms can grow in low acid products, when in a moist condition, and expensive equipment such as boilers and pressure cookers is required if vegetables are to be processed through the use of heat. However, they can be safely preserved by making them acid through the process of pickling, or by salting or drying them.

Fruits present opportunities for rural producers but also pose substantial problems.

Fruit trees in fact tend to crop in flushes and the fruits are usually very difficult to store fresh. This leads to gluts in local markets, where people literally give away their fruit because they don't want to carry them home again. This is especially true of mangos, pineapples and bananas, but other fruits behave similarly. At the same time people see the extortionate prices being charged at the local tourist hotels for tinned fruit juices and jams and they ask why they cannot tap that market.

To a certain extent the same can be said of vegetables although their popularity as fresh produce has tended to restrict the demand for processed vegetable products. Furthermore, vegetables, being low-acid in nature, are more difficult to preserve than high-acid fruits, restricting the range of products that can be made.

In considering the processing of fruits and vegetables one should always remember that in general, consumption of fresh food is preferable as preservation usually destroys some of the nutritional value — in other words, preserved foods are not as good as fresh foods. On the relative loss of nutrients per product little can be said. The importance of this depends on the actual nutritional status of the consumers concerned, i.e. what nutrients they lack. In addition, the extent of nutrient loss during processing varies greatly with each individual process. The drying process, for instance, destroys fat-soluble vitamins, while the boiling process breaks down the vitamins released into the water solution. Whether a drink contributes more to the nutritional value of a consumer's diet than a sugar preserve is also related to the quantity eaten i.e. jams are consumed in small quantities, drinks in larger quantities.

There are a number of fruit and vegetable products made traditionally, especially in Asia. Fruit leathers, for example, are widely available in Thailand, while fruit and vegetable chutneys and pickles are widespread

throughout the whole of Asia. These products are largely made on a kitchen scale, although increasingly small and medium-scale industries are also being established.

With the advent of tourism on a large scale and, in addition, the growth of urban middle classes in many Third World countries, a range of new products are finding markets. Such things as jams, jellies, fruit drinks and boiled sweets are developing substantial sales volumes in many countries. These products are conventionally made in large capital-intensive factories, often owned by multi-national corporations which are vertically integrated from growing the fruit right through to marketing it.

It has been shown, however, that many of these products can be made at a much smaller scale on a more decentralised basis. Most of the products described in this source book can be made with very simple equipment at the domestic level and where possible this is mentioned. Outputs will however be very low, a dozen or so packs per day and generally due to quality faults and poor presentation, the goods would be unlikely to be able to compete against other brands. For this reason, while mention is made of this domestic scale of production this source book emphasises equipment and processes appropriate for small/cottage industry production. A word of warning must be sounded here: while these low-cost units are very cheap in comparison to large factories, they can be hugely expensive when compared to the income levels of poorer rural people. In most cases they will require a level of investment and organisation which will necessitate substantial inputs from outside both in terms of credit systems and training in organisation and business principles.

Special emphasis is needed on marketing skills, since it is marketing which is the most serious problem facing these businesses for a number of reasons.

First, markets can appear to be substantial while in fact they are very small. Consumption of pineapple juice (at a tourist hotel) for example, may be equivalent of only a few

dozen pineapples — hardly a dent in a local glut. Secondly, markets can be a long way away from the producers. This can give producers immense problems in terms of negotiating with customers and deliveries and, unless they are experienced negotiators, they can be very badly exploited. A village group will tend to come off worst when dealing with an urban wholesaler. Thirdly, customers will tend to want deliveries regularly throughout the year or if there is a peak (because of tourism) it is quite likely to be at a different time of the year from the time of a glut. This means that the producer group may require substantial amounts of working capital to process the glut and store it before they can sell it. Any business that is not producing and selling throughout the year has to be a very high risk. Fourthly, if production is for an urban market, the quality of the product itself will almost certainly not give it enough selling power. It will need to be packaged and promoted in such a way as to attract purchasers. These skills are again usually not in the experience of village groups and they will need substantial support. If they prove that there is a market, there is always the danger that a big producer will spot the potential and push the small producers aside.

These points are meant as a warning. Small scale fruit and vegetable processing projects have succeeded (see Section 3), but the problems should not be under-estimated.

It cannot be stressed strongly enough that if a fruit or vegetable processing venture is under serious consideration, advice should be obtained from a qualified technical source.

The fruit and vegetable processing Sections 2 and 3 are accompanied by information on equipment given in Sections 5 and 6.

In most countries, regulations exist governing the amount and type of preservatives, the proportion of fruit, etc. to be used in the common types of fruit products offered for sale in the formal market sector. These regulations obviously vary from country to country. Consultants should familiarise themselves with local standards and make sure that every effort has been made to meet them.

Fruit Processing

Fruit Preserves, Drinks, and Pickles

Before looking at preserves, drinks, and pickles in detail it is worth summarizing their basic principles of preservation.

Jam/Jellies

The preservation of jams, jellies, and marmalades depends on a high sugar content (68-72%) combined with the fruit acidity which prevents microbiological growth. Their setting qualities depend on the sugar content, and on the formation of a pectin gel. The strength of this gel depends on the amount of pectin present and the acidity (often referred to as pH). A good jam is in fact a rather complex product requiring a fairly precise balance between sugar level, acidity and pectin content.

Jellies are clear filtered products; marmalades, generally made from citrus fruits, contain shreds of peel; jams contain either whole fruit or fruit pulp.

Confectionery products

Although not particularly common, certain quantities of a high boiled fruit preserves are manufactured. Essentially, these are jam-type basic mixtures that have been further boiled so that they reach a final sugar level of 75-85% and thus set as a solid block. This high sugar level combined with the natural acidity prevents spoilage. Probably the most common example is guava cheese. These products are normally sold as confectionery.

Fruit in syrup

Fruits of various types can be packed in jars under an approximately 50% sugar syrup. After heat treatment the jars are sealed tightly while hot so that an internal vacuum forms as they cool. The preservation of products of this type depends upon adequate heat treatment and hermetically sealed containers (that is to say airtight seals).

Drinks

A wide range of fruit drinks can be produced. All contain pulped fruit or juice which has been extracted from the fruit. They are either drunk without the addition of further ingredients as a pure fruit juice, or diluted with sugar syrup. Fruit drinks can be divided into two groups: those which are drunk immediately after opening and those which are used little by little from bottles which are stored between use. The former group, if properly processed and packaged, should not need to contain any preservatives, but the latter group, if they are to have long shelf life after opening, must contain preservatives. Unopened bottles should have a shelf life of 3-9 months depending on the storage conditions.

Many different names are used to describe fruit based drinks which can be a little confusing.

Broadly, although depending on local regulations:

Juices should be exactly what they say, that is, a pure fruit juice with nothing added;

Fruit nectars would normally be expected to contain at least 30% fruit solids and are drunk immediately after opening;

SECTION 1

Squashes normally contain at least 25% fruit pulp mixed with sugar syrup, are diluted to taste with water and contain preservatives, because they are used in small quantities over a long period of time;

Cordials are simply crystal clear squashes;

Syrups have been filtered so as to be clear but normally have a high sugar content. They are used in small quantities for dilution.

All these products rely for preservation on their natural acidity and the fact that they have been pasteurized, i.e. heated to an adequate temperature (80-90 C) to destroy naturally occurring enzymes and most micro-organisms, before packaging. Some, e.g. squashes and syrups, also contain a high concentration of sugar which helps to preserve them. As mentioned earlier, all products that are opened and partially-used would need to contain preservatives.

Pickles and sauces

Products of this type depend for their long shelf-life upon the presence of acetic acid which is normally introduced in the form of vinegar. Other ingredients, particularly salt,

sugar and spices, have a lesser but important role in preservation, as well as contributing to the flavour of the product.

The Process

A table is given below which presents an outline of various steps taken in processing the above-mentioned products.

There follows a brief description of the principles involved and problems which may occur, with suggested solutions reached by means of improved technologies.

1. Selection of fruit

People often assume that a manufacturing process can be set up to make use of poor quality or reject fruit. This is a false assumption. However, in some cases fruit which has been rejected from the fresh fruit market for purely cosmetic reasons, such as surface blemishes, is completely acceptable. All selected fruits should be of the highest quality and of the required level of maturity, otherwise whole batches may be spoiled by the presence of a small quantity of unsound material.

Product	Select Fruit	Prep. Fruit	Pulp/Extract Juice	Sieve	Strain	Add Other Ingred.	Boli	Past.	Fin	Pack (Seal) (Cool)	Final Product
Juice Clear	X	X	X	X			X	X	X	X	X
Juice Squash	X	X	X	X	X	X		X	X	X	X
Cordial	X	X	X	X	X	X		X	X	X	X
Jam	X	X	X	X	X	X	X		X	X	X
Jam	X	X	(whole fruit)	X	X	X	X		X	X	X
Marmalade	X	X	X	X	X	X	X		X	X	X
Sauce	X	X	X	X	X	X	X		X	X	X
Jelly	X	X	X	X	X	X	X		X	X	X
Pickle	X	X	(whole fruit)			X	X		X	X	X

* Indication of where quality control should be applied. A summary table of quality control is outlined later in this Section.

SECTION 1

2. Washing

It is recommended that incoming fruit be washed in clean chlorinated water before processing, and any that may have been treated with pesticides and other chemicals should receive particular attention. Chlorinated water can be made by adding small quantities (about 1 teaspoon/gallon) of household bleach to tubs of water. The fruits should be thoroughly rinsed in clean water after this treatment.

Water

Large quantities of water are used in the production of many fruit and vegetable products and in many places chlorinated mains water is either unavailable or unreliable. Water quality is a key factor when used in food and well water is often contaminated by fleas or run off from nearby land. While suspect process water can be boiled before use and then allowed to settle this is unreliable and also costly in fuel. Various types of water filters are available, and some examples are included in Section 5 (1). The use of household bleach for water treatment is feasible in the correct dilution. In all cases it is strongly recommended that local expert advice is sought as to the suitability of water available in any location. Mechanical washers are available for handling larger quantities of fruits and vegetables. They can be made locally using rotating drums containing brushes, but should only be used for fruit that does not damage easily.

3. Preparation of fruit

The preliminary preparation of fruit involves processes such as peeling, destoning, and slicing. These should take place under the most hygienic conditions possible; workers should wear clean uniforms, wash their hands well before commencing work, and use easily cleaned surfaces such as metal or plastic covered wooden tables or stone surfaces. Utensils should be kept clean at all stages.

As most fruits are rather acid, it is normally recommended that either stainless steel, or good quality plastic or wood utensils are used. Copper, brass or iron pans are not generally recommended since the action of acid on these metals will affect the product. In some situations the use of clay cooking vessels would be preferable. Where possible workers should protect their hands.

The peeling, cutting, and slicing of fruit is a time-consuming task, especially if cutting large quantities are involved. In order to help control the quality of the final product, these operations should be performed to give pieces of fruit as uniform in size as possible. This will ensure even penetration of heat and even mixing of ingredients. Various simple items of equipment are available to assist in some of the more labour-intensive stages. (Section 5 (2)).

Fruit from these preliminary stages should be kept in covered containers while awaiting further processing.

Since many fruits are highly seasonal, producers are often interested in preserving them in bulk at harvest time, when prices are also at their lowest, for use later. Many fruits can be preserved in this way by packing them in barrels of water containing sulphur dioxide after which they will be stable for several months. This chemical can be applied to the commodities in two ways: sulphuring and sulphiting, as explained in Section 5 (3).

4. Pulping/Juice extraction and sieving

Juice can be extracted from fruit in several ways: (Refer also to Section 5 (4)).

- with a fruit press, fruit mill or hand pulper/sieve (all contact points should ideally be of stainless steel).
- crushing/pulping with a mortar and pestle or blender and then sieving through muslin cloth or plastic sieves.
- by steaming the fruit with a juice steam

SECTION 1

er. If electric power is available, multi-purpose kitchen-scale equipment can be used at this point as well as at later stages of processing. At an industrial level this process is normally carried out in pulper/juicers which brush the pulp from the fruit through a sieve and eject skin and stones from an exit. Smaller models of this equipment can be manufactured and are commercially available.

Citrus fruit juices need to be extracted by squeezing or reaming the fruit and once again comparatively simple equipment is available for this purpose.

Sieving is, at the cottage industry level, usually done by hand.

5. Filtering/straining

Clear products such as syrups and cordials require filtering and a cloth jelly bag is commonly used for this purpose. Details are provided in Section 5 (5).

6. Mixing of non-fruit ingredients

The raw fruit material, whether it is in pulp, juice or sliced form, is now ready to pass on to the next stage which is preparation of a batch of mixed ingredients. In a source book of this size with its broad target audience, it would not be possible or necessary to examine all the various recipes and mixtures that might be used to make the whole range of possible final products. However, one or two points must be stressed with regard to the minor ingredients that are used at this stage. Clearly a range of measuring equipment is needed and a few ideas for using readily available measures are given in Section 5 (6).

Sugar

Refined sugar in granular form appears white and clean, but it often contains a signif-

icant amount of extraneous matter. It is therefore recommended that, wherever possible, the sugar should be dissolved in water and passed through a muslin filter to remove any particles which may give rise to complaints in the final product. Such specks are commonly identified by customers as ants!

Added acids

As has been previously mentioned, the correct acidity level of jams is critical if a good gel formation is to be achieved. The flavour of some fruit products is improved when the acidity is slightly increased, making them more acceptable to the customer. Acidity levels are normally adjusted by the addition of citric acid, either in pure powder form or by adding lime or lemon juice.

Pectins

The amount of added pectin needed to give a good gel also depends on the type of fruit used in the jam. Some fruits (e.g. melon) contain little natural pectin and therefore need added pectin. Pectin powders can be purchased for use where necessary to strengthen the natural fruit pectin. Pectin may also be extracted from the skins and pips of certain fruits, such as citrus and passion fruits by boiling them in water. After straining the extract is added to the product.

Vinegar/Acetic acid

Vinegar or acetic acid solution is essential for the production of pickles and sauces. Distilled vinegar with 10% acetic acid is preferable to normal 4 or 5% malt vinegar which can be used, but often this is not available in developing countries. Pure food grade 80% acetic acid may also be diluted for use in such products. Great care must be taken to ensure that acetic acid is of food grade quality, as commercial grades contain high levels of lead. Extreme care is needed when handling 80% acetic acid.

SECTION 1

In many cases batches are prepared in fairly substantial quantities and held for a few hours before passing on to the boiling/cooking/pasteurizing stage. As previously mentioned, many metals react with acids so ideally large stainless steel, plastic or wood containers should be used for interim storage.

7. Heat treatment

Boiling

Jams, jellies, chutneys, etc. must be boiled to concentrate the sugar to the right level and are then transferred into jars while hot. On a small scale boiling would be carried out in stainless steel, aluminium, enamelled metal or clay pots over a wood fuel, kerosene, gas or electric stove. The choice of stove will influence the convenience and controllability of preparation. Great care must be taken to avoid localised over-heating, causing burning and flavour changes. The product must therefore be stirred vigorously while heating. On a larger scale these types of products are heated in double-walled steam kettles, supplied with steam at about 40 pounds per square inch from a boiler elsewhere in the plant. (Refer Section 5 (7)).

Pasteurisation

Liquid products such as drinks and sauces need to be pasteurised, that is, heated to 80-95 C and held at that temperature for a short period of between 30 seconds - 5 minutes before filling (usually hot) into clean previously sterilised bottles. Pasteurisation is best carried out over direct heat in stainless steel pans. To avoid the use of large stainless pans, which are very expensive the following method can sometimes be used. A large aluminium pan of sugar syrup of the correct strength is kept simmering on a burner. A given amount of the boiling syrup is then mixed with a given amount of fruit juice according to the recipe under use in a

small stainless pan. The temperature will immediately rise to 60-70 °C. The small pan is then briefly heated to the final temperature required for pasteurisation.

Products such as fruit in syrup and some pickles have to be pasteurised in the jar. The filled jars, with the lids loosely closed are stood in a large pan of boiling water with the water level around the shoulder of the jar. The time required for pasteurisation will vary depending on the product and pack size.

In the case of bottled fruits, for example, the jar is first packed with fruit after which it is filled with boiling sugar syrup. The caps are loosely put on and the jars are stood in a large pan of boiling water for about 10 minutes or more depending on the particular fruit and size of the pack. The hot jars are finally removed from the water bath and the lids fully tightened. (Refer Section 5 (8)).

As has been mentioned under jams and jellies steam jacketed pans are used for higher production rates.

8. Packaging

The difficulties in obtaining suitable packaging materials can be one of the greatest constraints. Special pickling jars for fruit and vegetables can be bought in some places, but are expensive.

The majority of products under consideration are packaged in glass containers, although plastic bottles and where appropriate plastic bags are becoming more common. Recently, imported aluminium foil/plastic pouch packaging offers exciting possibilities as it could help to overcome problems encountered with glass jars. This form of packaging is lightweight and cheap, so that freight costs are reduced to a minimum. Availability of suitable glass packaging is a real constraint in many developing countries which do not have their own glass-producing facilities. In such situations it is common practice to use recycled con-

SECTION 1

tainers. However, recycled glass must always be regarded with suspicion. A system of stringent inspection and cleaning must be established (it is not unknown for people to store insecticides in old squash bottles).

A separate source book provides information on methods for packaging foods.

Washing, preparation, and filling of containers

Thorough washing and preparation of bottles is crucial. A good product packed into a dirty container will soon deteriorate. The following steps are therefore recommended.

- Inspecting and rejecting any cracked, chipped or otherwise suspicious bottles, washing either by hand or by small machines and thorough rinsing. (Refer Section 5 (9)).
- Bottles can be steam sterilised until steam comes out of the neck of the bottle. This is especially important if products are to be packaged while hot as this process ensures that any bottles with inherent weaknesses break in contact with steam rather than after filling as well as reducing the level of harmful micro-organisms present. (Refer Section 5 (10)).
- The system used for filling bottles will depend on both the product and the scale of the operation. In the case of jams and chutneys, for example, which contain large lumps of fruit, it is often more convenient to use jugs to fill cleaned jars directly. They should be filled to the correct level (approx 9/10 full) to assist in the formation of a vacuum under the lid as the product cools. In the case of drinks, simple hand-filling systems can easily be manufactured locally. (Refer Section 5 (11)).
- For higher production rates, small hand or semi-automatic piston fillers are available. (Refer Section 5 (1!)).

Sealing

- Traditional methods of sealing such as wax paper held by rubber bands can be used for some products but are not really satisfactory for products with storage and marketing requirements. This method is vulnerable to ants and other insects entering the container. Spillage can also occur in transport. Airtight sealed containers are preferable for these reasons. Although recycled jars can often be found and used, new lids will have to be purchased since recycled ones might not seal adequately.
- Lids fall into two basic groups, those that are screwed on and those that are pushed on. On a small scale screw caps will be applied by hand. Crown caps (as used on beer bottles) or push-on jam jar lids require the use of a small simple hand machine which is available from suppliers or could be locally made. Refer Section 5 (12)).
As a routine quality control check lids from a small proportion of finished packs should be checked to see that a vacuum has formed in the jar.
- Canning of fruit products is perfectly feasible on a small scale if cans are available and small hand can sealing machines can be obtained from specialist suppliers. The canning of fruit products is very similar to the bottling system described earlier and includes hot filling and often a final pasteurisation of the sealed fruit.

Cooling

In most cases products will be filled and sealed hot. It is better to cool the product as rapidly as possible because high temperatures for long periods of time can alter both flavour and colour. However, if bottles are plunged directly into cold water, thermal shock may cause them to break. Simple cooling systems can be built locally to pre-

SECTION 1

vent severe thermal shock if larger outputs are planned. It is important to remember that during the first phase of cooling, sealing between the lid and the container is still taking place as a vacuum is being formed. Water may be sucked into the container at this stage so cooling water must be lightly chlorinated. Refer Section 5 (13)).

Labelling and Presentation

Presentation of the product to the consumer is the final and perhaps most important step in the production chain. A little care can produce increased sales at very little extra cost.

Decisions made as to the size of the jar or package, storage life, labelling, advertising etc. will determine and influence the type of consumer and share of the market you intend to reach. Such decisions should only be made after careful consideration of the

above factors and preferably with professional advice.

Hand labelling is normally used although very small hand-operated label glueing machines are available. Unless high production levels are envisaged, automatic labeling machines are not appropriate. (Refer Section 5 (14)).

9. Quality control

Quality control need not be costly and its importance cannot be overstressed. All firms should introduce some form of quality control, regardless of the size of operation, to ensure consistent quality of the products and reduce losses from rejects. The producer **MUST** demonstrate responsibility to the consumer.

In addition to the summary table of main quality control points, given below, there should be checks on all factors relating to

Stages in process	Quality check
Selection of fruit	Ripeness, no mould or bruising, correct sizes and colours, no insect damage, correct varieties.
Preliminary preparation	All unwanted parts (stones, skins, dirt, insects, etc.) removed.
Straining	Clear juice produced.
Minor ingredients	Correct weights added, no contamination from dirt, insects, etc.
Boiling/Pasteurisation	Correct temperature for correct time. No burning on sides of vessel. Adequate stirring to ensure all juice is properly heated. Refractometer (see Section 5 (15)) to establish sugar content for sugar based preserves.
Filling	Correct weight. Clean lip on container for good sealing.
Packaging	Cleaned, no cracks or other damage, correct size and shape. Vacuum formed under lid.
Final product	Good appearance, no contamination, correct label and fill weight.

SECTION 1

production such as workers' hygiene, plant cleanliness, uniforms, and utensils. An appendix on building equipment is included separately.

Most of these checks take time but require little or no equipment or materials. These check points ensure that the quality of the food is as high as possible and all employees should be aware of the importance of quality and be encouraged to report any defects.

Fermented Fruit Products

It has been known for centuries that the action of certain micro-organisms can be used to make products such as wines and vinegars. Since fermentation is a process involving living micro-organisms, the conditions under which it takes place (temperature, pH, level of oxygen, presence of nutrients) are critical for the process to proceed efficiently. In traditional production

systems fermentation relies on the activities of natural organisms that happen to be present either on the surface of the raw material or in the environment. Final products thus tend to vary considerably. To produce standard products greater attention must be paid to detail, particularly in maintaining hygienic conditions and preventing the possibility of "foreign" organisms entering the production process.

This section deals briefly with the principles involved in the production of wines and vinegars.

Wines are fruit, vegetable, or cereal extracts that have been fermented by yeasts which convert sugars in the fruit into alcohol.

A number of useful guidebooks are available which describe recipes and methods for the production of wines from dried fruits, canned and pulped fruits. (Refer to Further Reading).

Vinegar is the product of a two-stage fermentation. The first step involves the fermentation of sugars to alcohol (a wine)

Basic Ingredients

Yeast. While fruits have an abundance of wild yeast on their skin, which can be used for fermentation it is much preferable to use selected strains. Such yeasts are commercially available and are particularly suitable for the small scale manufacture of wines.

Sulphur dioxide is, in addition to being a preservative, commonly used to sterilize equipment before use. It is available either in the form of Campden tablets or as powder which is usually cheaper, and in developing countries perhaps more readily obtainable. Sulphur dioxide can also be obtained by burning sulphur. (Refer Section 5 (3)).

Refined Sugar is used when fruit does not contain sufficient natural sugars.

Acid. The addition of acid may sometimes be necessary to provide the correct pH level for the yeast to develop rapidly, and to add flavour. Most fruits tend to be sufficiently acid, but in some instances adjustment is necessary.

Water is obviously necessary and, as has been stressed in other parts of this guide, good quality water is essential. If in any doubt the water should be boiled and filtered.

A whole range of **minor ingredients** including yeast nutrients and wine clearing agents are available and sometimes required.

SECTION 1

and then a second micro-organism oxidizes the alcohol to acetic acid, the compound which gives vinegar its characteristically sharp taste.

There are many different types of vinegar (not all fruit-based), the most common being malt, distilled, spirit, wine, cider.

There are also a number of variations such as herb vinegars, fruit-flavoured vinegars, etc., but these are not in common use.

The basic ingredients necessary are outlined below and equipment for the production of fermented fruit products are listed in Section 6.

Dried Fruit Products

Drying is possibly the most appropriate way of preserving many fruits in rural areas. It has the advantage of being a traditional, understood technology and equipment costs can be low. The following ways of producing dried fruit products will be covered:

- Simple drying in the sun or a drier.

- Osmotic drying and crystallizing in which fruit is heated in sugar syrup to extract moisture before drying in air.
- Fruit leathers. The result of drying a puree of fruit or of a mixture of fruits, in a thin layer.
- Deep frying to produce fruit-based chips. Although this is not obviously drying, frying removes moisture from the raw material and for convenience is considered here.

During drying, water is removed from the surface of the product by the combined effects of three basic elements: temperature, humidity, and airflow. Drying is successful only if the relationship between these elements is correct.

The spoilage of fresh products is mainly caused by the growth of micro-organisms which require water to grow. When the moisture content is lowered below a certain level their growth is arrested. Drying only stops micro-organism growth. Decay starts immediately contact with water/humidity is re-established. A correct drying method must be followed, therefore, by correct storage.

	Select Fruit	Prep. Fruit	Prep. Sugar Syrup	Soak Fruit in syrup	Pulp	Sieve	Add Other Ingrid.	Boil	Prelim. Drying	Deep Fry	Dry	Pour Into Thin Sheets	Pack

Chips	X	X							X	X			X
Air Dried													
Fruit	X	X									X		X
Osmotic													
Dried													
Fruit	X	X	X	X							X		X
Fruit													
Leathers	X	X			X	X	X	X				X	X

* Indication of where quality control should be applied. A summary table of quality control is outlined earlier in this Section.

SECTION 1

When looking into the choice of a drying method it is very important to define the purpose of drying the raw material; is it meant for *product preservation*, i.e. to prevent deterioration and therefore loss of value, or for *product refinement*, i.e. as a stage in processing a raw product into another form for final consumption.

In processing fruits and vegetables the latter is the usual aim, and the motivation for an investment in time, labour, and money by the producer in the introduction or improvement of a drying device is directly related to the cash benefits he expects to derive from the product refinement.

In other words, the success or failure of a drying project is frequently found in the development of a market, often for a new product, rather than in the adequate development of drying techniques. Local rural market customers are rarely willing to pay a premium for a better quality product from the improved drying process. Urban markets, large-scale caterers, or middle-class customers must be identified, with consequent implications for quality requirements.

The table above outlines the different options for producing dried fruit products:

Air dried fruit

Drying of fruits has been carried out since the earliest of times by spreading products out in the open air on all kinds of natural surfaces in direct sunlight. However, the quality of the product is often poor since there is minimal control over hygiene and scarcely any control over humidity, temperature, and speed of drying.

Solar driers have been developed to overcome some of these shortcomings and dif-

fer from sun drying in that an often very simple structure is used to enhance the effect of the sun's heat and protect the product.

A distinction is made between **direct** and **indirect solar** drying.

In a direct solar drier the product is exposed to the sun's rays and results in a change in colour and vitamin content. In the production of raisins and dates this is meant to occur. For other fruit products the indirect drying method, shielding the raw material from the direct rays of the sun, is preferred. In such a drier the heat from the sun is collected in a separate connected chamber and the air heated there is passed through to the food in a separate drier cabinet.

'Mechanical' driers use fuel to heat the air, either directly, where the gas from the burned fuel is used to dry the food, or preferably indirectly, where the fuel is used to heat up air which is then used to dry the food. Both types have much better control than sun drying and can be used throughout the day or night, whatever the weather. They are, however, more expensive to buy and operate.

As has been mentioned with other fruit products correct grading and selection of the raw material, its washing and preparation is as important as the actual drying.

As in the case of bottling, the cutting and slicing of fruits into equal sized pieces helps control sulphiting and drying rates and improves the uniformity of the finished product.

Preservative treatment: Sulphur dioxide treatment (i.e. dipping in sodium metabisulphite solution or exposing to burning sulphur) is particularly helpful in slowing down browning during the drying process. At the same time it retards the growth of mould and yeasts. Simple cabinets may be constructed for use with burning sulphur. (Refer Section 5 (3)).

For information on the existing designs and their suitability for drying particular foods, refer to the DRYING SOURCE BOOK.

SECTION 1

Osmotic dried fruit

Fruits can be preserved by heating them in syrup, then rinsing and draining to wash off the surface sugar. The pieces are dried either directly or indirectly, depending on the quality of the product required.

It should be noted that the product obtained by osmotic drying followed by solar drying is different from that obtained by solar drying alone.

Some **advantages** of osmotic drying are:

- A high concentration of sugar on the surface of the food reduces discolouration by enzymic browning. Hence a good colour can be obtained in the dried product without chemical treatment such as sulphiting.
- As water is removed by osmosis, some of the fruit acid is removed along with it producing a blander and sweeter product than ordinary dried fruit.
- As part of the water in the food is removed by osmosis, drying times are shorter.

Some **disadvantages** are

- The slight decrease in acidity mentioned above may be a disadvantage in certain products as moulds are more likely to grow. However, fruit acid can be added to the sugar solution.
- Depending on the quality of the sugar, a thin film of sugar might be left on the surface of the fruit after drying which makes it sticky. A quick rinse in water reduces this, but remember to re-dry the fruit before packing!

The concentration of sugar solution and time of soaking depend on the type of material, initial moisture content, and desired level of sweetness required. The used syrup is valuable and can be reused once it has been strained and boiled down to drive off the water that has been removed from the fruit.

Crystallized fruits

The same principle of treating fruit with hot syrup is applied for crystallized (or candied) fruit. The fruit is placed in hot syrup for 15-30 minutes and then left to cool and soak until the next day. It is then placed in a more concentrated syrup and the process repeated. This should be a slow process to allow the sugar to penetrate as water in the fruit diffuses out. Drying of the fruit after being saturated with sugar can take place in a warm oven or drier.

Fruit leathers

When a puree of a fruit, or a mixture of fruits (treated with sulphur dioxide to control discolouring and microbiological growth) is spread in a thin layer, a product known as "fruit leather" results. It is generally eaten as a snack food and can be sweetened by the addition of sugar to the puree or modified by the inclusion of ingredients such as chopped nuts, grated coconut or ground spices.

Deep fried fruit products

Slices of fruit (i.e. banana) are pre-dried to avoid sticking, then deep fried. Case Study 7 gives a detailed account of this processing method.

Packaging & storage of dried products require special attention.

The final product once it is correctly dried, should be protected from sunlight, moisture, and heat to prevent it from developing off-flavours or spoiling. Pottery, glass, metal, or plastic containers are all suitable as long as they can be properly sealed. The cheapest option is probably polythene bags provided they are heat sealed. Refer Section 6 (3) Storage should be in a cool dry area away from sunlight, insects, and rodents. Most dried fruit should stay wholesome for many weeks.

Details are contained in separate PACKAGING and STORAGE SOURCE BOOKS.

Vegetable Processing

The demand for preservation of vegetables for home consumption does not seem to be as great as for fruits. Preservation of vegetables for the market has a different character to fruits. As is mentioned in Section 1 the low acidity of the majority of vegetables makes some processing methods, such as canning, more difficult and less to be recommended as an activity for persons without the necessary skills, equipment, and experience in its use.

Many of the points discussed in Section 1 regarding marketing, hygiene quality, water etc. are equally applicable to vegetables and will not be repeated. The essential difference however between fruits and vegetables (high versus low acidity) must always be borne in mind. Improvements in the preservation of vegetables can be achieved by looking into better storage methods for fresh crops. Again, it should be stressed that if a vegetable processing venture is being seriously considered, advice should be obtained from a qualified technical source.

The canning of vegetables *cannot* be recommended for small scale production. Equipment costs are high and unless stringent control is maintained there is a real danger of causing food poisoning.

This section is concerned with the processing methods for preservation of vegetables which are safe for small scale operation, and avoid costly investments.

These are:

- Salted/brined and pickled products.
- Fermented vegetable products.
- Dried vegetable products.

Salted/Brined and Pickled Vegetable Products

Dry salted vegetable products

In dry salting the food material is covered with salt and left for some time for the salt to penetrate the tissues.

The action of solid salt is quite complex, but essentially involves drawing out the moisture from the fruit or vegetable by osmotic pressure. The use of solid salt dates back to ancient times. It was found to have many useful properties, especially as a preservative of animal tissue, which give better results than vegetable tissues.

This is due to the different structure and chemistry of vegetables from those of meat or fish.

Salted vegetables must be washed in clean water to remove the salt to a level where the vegetable becomes palatable prior to use.

While salt is very important in the preservation of vegetables it is often used with some other preservative such as vinegar.

The salting method does have disadvantages. Vegetables lose many of their nutrients through salting and should in fact only be salted when there are surplus fresh vegetables available and when other methods of preserving cannot be used.

The use of small amounts of salt with acid fermentation, as described later, can produce foods of better nutritional value.

SECTION 2

Brined vegetable products

This preservation method has much in common with dry salting except that the vegetables are preserved in a solution of salt. The main disadvantage of brining is that the preserved vegetables do not keep for long, after opening, if palatable levels of salt are used. A higher concentration would improve the keeping qualities of the preserve, but would also make it very unpalatable without washing. The exclusion of air is essential to prevent the growth of yeasts on the surface. The quality of the salt is also of great importance. If the salt tastes bitter, its use is not recommended.

Brining vegetables in bulk in barrels is a good way of preserving them where they are grown so that they can be transferred to other centres for later processing.

Vegetable pickles and sauces

A whole range of vegetable pickles can be made using vinegar and sometimes sugar.

Prior to pickling many vegetables are dry salted or brined, the dry method being preferred if a crisp final texture is required. Removal of excess salt by washing may be necessary prior to use in the final product.

Some vegetables require blanching, a short hot water or steam treatment which prevents the action of enzymes and reduces the initial concentration of micro-organisms. (Refer Section 6) (1).

The production processes after these stages are more or less identical to those seen already for fruit pickles.

The Process

The table on page 22 outlines the principles involved in salting and pickling of vegetables including the making of chutneys and sauces.

Fermented Vegetable Products

Fermentation of vegetables will take place when lactic acid bacteria ferment the sugars present in the vegetables. Lactic acid fermentation takes place in the absence of air at very carefully controlled conditions of pH and salt content.

Common fermented vegetables include German Sauerkraut or Korean Kimchi. Cucumbers, eggplant, beets, onions, and olives can also be fermented in this way.

Brining and lactic acid fermentation are useful methods of processing and preserving vegetables because they are low cost, have low energy requirements for both processing and preparing food for consumption, and yield highly acceptable and diversified flavours. Acid fermentations modify the flavour of the original ingredients and often improve nutritive value.

Very simple equipment can be used for the fermentation process. Details are provided in Section 6 (1).

Dried Vegetable Products

Drying is a very common method for the preservation of vegetables and the points made for air drying of fruits apply.

Most vegetables, in contrast to fruits, should be blanched. Steam blanching is often preferred to water blanching because there is a small loss of nutrients by leaching. Refer Section 6. After blanching, sulphiting may be useful prior to drying.

As mentioned in the fruit section, quality improvements to sun drying are to be found in hygiene control and control over the drying speed and temperature, which has a direct influence on the presentation of the final

SECTION 2

product. Indirect drying methods, shielding the raw material from the sun, are the most suitable for vegetables. Choices include drying in the shade, indirect solar driers or artificial/mechanical drying. The market value of the end product will tend to suggest which drying system to choose. As in the case of dried fruit suitable pack-

aging materials must be used to keep the final product dry.

The DRYING AND STORAGE SOURCE BOOK should be used for further reference on details concerning existing designs and their suitability for drying vegetables.

Product	Salt-stock	Sweet Pickle	Sour Pickle	Unfermented Pickle	Sauce
Select Vegetable *	X	X	X	X	X
Prepare Vegetable *	X	X	X	X	X
Add to Brine sol. & Mix	X 6-10% brine	X 5% brine + 1-2% sugar Leave 1-2 wks.	X 5% brine Leave 1-2 wks.		
Salt	X keep for 10 days at 6-10% conc. Then 6 wks. at 16% conc.			X	X
Blanch			X		X
Mix with Vinegar					X
Boil *					X
Fill into Bottle/Jar *					X
Wash	X				
Pack (Seal) (Label) *	X 3% salt 5% vinegar	X 3% salt 5% vinegar + sugar	X 3% salt 5% vinegar	X 3% salt 6% vinegar + sugar	X
Pasteurize *		X May be	X May be		
* Indication of where quality control checks should be applied. A summary table of quality control is outlined in Section.					

Case Studies

An attempt is made here to present examples of fruit and vegetable processing as an income generating activity. It proved rather difficult to find detailed case studies which cover all aspects of a project from its identification through to its impact on participants and their communities. Thus, the experiences described in the following pages only relate to a selected number of processes, namely: production of preserves, drinks and pickles; production of wines and vinegars; and drying.

Preserves, Drinks, and Pickles

1 A women's jam making project - Central America

Summarized from:

Kocken, 1986 (Unpublished).

In 1979 the National Board of Social Welfare (NBSW) organized a group of 19 women whose children were participating in a health programme for the upgrading of the nutritional status of their children, and decided with them what they would like to start as a joint undertaking. They chose to produce jams and jellies as an income generating activity.

In 1981 the group came into contact (via the NBSW) with an ILO consultant who worked for a Regional ILO/WFP project "Strengthening of rural cooperatives benefiting from food aid". Initial assistance was given to book-keeping and cooperative

principles and the women received food aid during the training. The precarious work situation of the women in the tiny unhygienic, and smoky kitchen of the NBSW came under discussion. The ILO consultant offered to help the group to find a source of finance for a new building on condition that they could find a suitable site and were willing to help build the new facility. Plans were made and a request was submitted to the donor for financing a new building with all the necessary equipment. A donation of US \$6000 was forwarded and buying of equipment commenced. Then more technical assistance was offered to the group in the form of a United Nations Volunteer food technologist, together with an architect, who redesigned the project. They adapted it to a level of sophistication with which the women could cope, thus changing the initial plans radically. Furthermore, another UNDP/ILO 'vocational training' project offered to incorporate the group into its building scheme. They sent one of their mobile construction units for construction, together with an instructor, to La Paz. Here the women had gathered a group of male counterparts (sons, friends, and occasionally a husband) who on their behalf built the factory according to the new design. Financial difficulties arose as a result of the rapidly expanding budget, but they were gradually resolved over a two-year period mainly due to the efforts of the group's promoter who found all sorts of sources for more money or materials, including the army and a local cement factory.

In the meantime the women were producing irregularly according to the fruit season. They kept their books in bad order owing to the annual change of treasurer in accor-

SECTION 3

dance with the cooperative's rules. This had an adverse effect on the profits which were further jeopardised by the high costs of packaging. It was the glass jars which at 50 cents each represented the major cost. Initially the jars were not available in the country but were purchased by the ILO consultant from a neighbouring country. Printing of the labels was also expensive.

By 1985 the group, which was now a legal cooperative, could finally inaugurate its new building, which was fully equipped and could accommodate about 20 women working together. However, there were by now only 15 members of the group and they had organized themselves into two groups of 7 and 8 people who would produce on alternate weeks. This badly affected the financial viability of the enterprise and because the women did not fully understand the business side of things, started to accuse their promoter of stealing money. These problems have now been sorted out, but this is a good example of a case where difficulties are experienced because of a lack of understanding of the needs and wishes of the intended recipients of development assistance.

2 The Orange Hill Estate

Summarised from:

Axtell, B.

The Orange Hill Estate; a successful small industry in Saint Vincent.

AT Journal, 1987, Vol. 9, No.2.

The basic economy of the eastern Caribbean islands is agriculture, but often they export their raw materials and then import similar processed products at considerable expense. Aiming to prevent this, the British Government funded several laboratories which would concentrate their research on food processing techniques that could lead to import substitution. In Saint Vincent, for exam-

ple, some twenty-five products were developed, including fruit drinks, jams, chutneys, and sauces. Despite the fact that processing systems were made freely available to any local entrepreneur who expressed interest, few took advantage of the advice and techniques offered to them. The two main problems were marketing and capital investment. It was generally felt that the locally made goods could not compete with the prestigious sophisticatedly packaged imported items. To try and overcome this, some sold their produce to local supermarkets and, in the case of Saint Vincent, exported a small amount to Barbados and even to Canada. At the same time, research into packaging, new products and marketing was continued.

The Orange Hill Plant

In about 1973, a local entrepreneur, the owner of the Orange Hill Estates in Saint Vincent, became interested in the laboratory's work and decided to set up a production unit drawing on its expertise. Initially, the investment was very low, about £150 to £200, and lime juice cordial was produced in an ordinary kitchen at a production rate of only twenty-four bottles a day. This limited production, however, was sufficient to enable test marketing and costings to be carried out. On the strength of these results, the investment was increased to around £500 and a small room was converted to a production centre which was able to produce some 100 bottles a day. Within two years the results were sufficiently encouraging to lay down a proper production unit. By 1986, output was running at up to 2,000 bottles per day, depending on the product, and a canning line for grapefruit juice had been added. The plant was employing about fifteen people (mainly women), with supplies coming mostly from the owner's estate. Much of the equipment in the plant was manufactured in the Estate's workshops.

The new products of the Orange Hill Es-

SECTION 3

tates are well known in local hotels and supermarkets, and have virtually replaced equivalent imported items. There is little doubt that this success is due partly to a government ban which was placed on imported products. This gave the company access to a market with shop-keepers eager to take locally produced goods in order to maintain stocks. Government policy has also helped in other ways. For example, when the supply of old beer bottles for the laboratory was threatened by the demand of a newly established brewery on the neighbouring island, a crisis was averted by legislation banning the export of old beer bottles. However, the home market has become more or less saturated, and although there is interest in Canada and the United States, the orders from these markets are far too large for the small company to fill.

The laboratory in Saint Vincent (now known as Agrolab) has acted as a useful catalyst in other respects. One example of this was an attempt to set up a system of producing orange juice, which at that time was being shipped in cans from Trinidad.

In Saint Vincent there is little or no orchard production of oranges; farmers tend to have a few trees in their back yards. It is generally not really worthwhile for these small producers to bring a few oranges in to the town to sell, so the Agrolab set up a system of going around the villages on a well-publicized schedule to buy the fruit. A folding table, on which were mounted several orange juice squeezing machines, was taken out in a van and several village women were taken on as workers. The fruit was purchased on site, washed and then squeezed with hand presses, the juice being collected in large plastic barrels. After adding a preservative, this raw juice could then be taken back to the plant for processing.

This system provided an on-site market for farmers for small quantities of fruit, saving the time and expense of a trip to the city market, provided a day's work for a few

villagers in weighing and squeezing the fruit, and, to the advantage of the Agrolab, left the fruit waste in the village where it could be better disposed of.

3 Fruit and vegetable processing - Costa Rica

Summarised from:

R. Fernandez, R.D. Cooke, R. Quiros, L. Madrigal, A. Samuels, F. Aguilar and A. Ortiz.

Fruit and vegetable processing and appropriate technology in Costa Rica: a case study.

Tropical Science, 1980, Vol. 22, No. 2.

All Costa Rican fruit and vegetables are in general produced by small farmers. A wide range of produce is made possible by the different climatic zones between the tropical lowlands on both coasts and the temperate Central Valley. The fruit and vegetable marketing system is typical of many developing countries. It is very centralized, deficient in organization, and dominated by intermediaries. Nearly all national production (about 180,000 tonnes in 1976) is handled through the markets of the capital, San Jose, even for redistribution back to the producer areas. Transportation, which is hindered by poor roads, is expensive and in short supply.

The multiple links of intermediaries cause excessive and defective post-harvest handling (grades, standards and packaging techniques are not used) and a scarcity of information about availability, prices and supply of the produce. The perishability of tropical fruit and vegetables aggravates problems and poor handling. This increases losses, reduces quality and depresses the profitability to the farmers of fruit and vegetable production, which is increasingly becoming a secondary activity of marginal interest. In addition, consumers are faced with erratic supplies and prices, and poor quality.

SECTION 3

The extent of cooperative organisation of small farmers in Costa Rica is much greater than in many other Third World countries. Thus, when a local technology centre — the Centro de Investigaciones en Tecnologías de Alimentos (CITA) — was looking for ways to establish agro-industrial projects, it decided to focus its efforts on rural cooperatives.

CITA has so far worked with two rural cooperatives, one (Zarcero) in the temperate Central Valley, the other (El Silencio) near the Pacific Coast in the tropical lowlands. The agreement between CITA and the cooperatives is that CITA is committed to:

- Conducting a market feasibility study of the fruit and vegetables grown in the climatic zone, and suitable products.

This involves evaluation of possible food processing technologies in the CITA pilot plant, taste panel and quality control assessments, and limited market surveys following cost analysis.

- Training two of the cooperative personnel in the appropriate food processing methods, plant hygiene, and management.

- Transferring of the technology to the cooperative. Continuing technical assistance is provided, usually in the form of a CITA scientist spending one to three days per week at the plant during the first two years. A variable amount of CITA equipment is lent to the plant during this two-year period, and much of the initial quality control is done at the CITA laboratory. CITA emphasizes the need for improved agronomic inputs (in collaboration with Ministry of Agriculture representatives) and improved post-harvest handling.

The cooperative undertakes to:

- Adapt or erect (with CITA advice) a suitable building for the food processing facility.
- Provide the raw material, containers, labour (usually cooperative members), and operating costs of the plant.

The success of the various product lines is analysed with regard to profitability and pro-

cessing improvements throughout the two-year period and the cooperative undertakes to buy its own equipment to replace that loaned by CITA at the end of this period.

Zarcero

CITA began the programme with the Zarcero cooperative. This cooperative has a number of advantages compared with many rural cooperatives: regular supplies of electricity and potable water, a paved road (one hour by car) to the capital, and the 350 small farmers constituting the cooperative have educational levels above the country's norm. The average farm size is 3.5 hectares.

The cooperative obtained a bank loan to modify an existing building for small-scale food processing. The equipment comprises: a boiler for blanching and pasteurization operations; steam kettles; stainless steel preparation tables; simple mills and graters; and basic quality-control needs (balance, pH-meter, burettes, refractometer). The cooperative grows a range of temperate fruit and vegetables, the most important of which are clingstone peaches, and cabbages, and chiverres (a popular local gourd). These were sold through the San Jose market until the establishment of this plant.

Experiments at CITA specified the optimum conditions for preparing a range of products in glass jars: whole peaches in syrup, pickles in vinegar or mustard sauce, sauerkraut, and chiverre 'honey'. The latter is a popular local jam, traditionally made on a domestic scale. Initial acceptability trials showed that these products were readily marketable at the projected retail prices. The relatively high cost of glass containers has promoted interest in the use of plastic pouches, and some of these products are now sold in this form.

The establishment of the processing plant has emphasized the value to the cooperative of correct post-harvest handling. Grading systems have been introduced: first grade peaches are sold as fresh fruit; second

SECTION 3

grade are processed as fruit syrup; and third grade, after suitable pre-processing, are used in jam. The peaches are no longer trucked to the market in heaps, which is the traditional system for all fruit and vegetables in Costa Rica. Recently, first grade peaches packed in cardboard cartons over-wrapped with perforated cellophane have been successfully test-marketed in the capital's supermarkets.

The prices paid for the fruit and vegetable raw materials are determined by the selling cooperative, based on existing market prices. This is a pilot-scale operation and the volume of raw material is a small fraction of that produced in the zone (zone refers to the cooperative and surrounding area of approximately 1100 farmers who could sell their produce to the cooperative). The current production of peach and chiverre products is limited by the processing capacity during the harvest period. The production of Sauerkraut and to a lesser extent of pickles is limited by market demand in the Central Valley. Sauerkraut is a new product in Costa Rica which the cooperative has made little attempt to promote.

Existing Sauerkraut production is sold mainly through supermarkets to upper-income and immigrant sectors. Increasing consumption of hamburgers and hot-dogs, and the rapid spread of North American-style snack restaurants, provide a stimulus for increased consumption.

Even at this small scale of production, a net profit of about 10% of the product value is estimated on the basis of raw material, processing and distribution costs. No allowance is made for building (owned by the cooperative) or equipment (loaned by CITA) depreciation, but also no allowance is made for the value to the community of buying the raw material in periods of glut when considerable quantities are wasted. The plant employs five to eight members of the cooperative and one member has recently been appointed full-time salesman.

A feasibility study recommended a Govern-

ment loan of US \$80,000 for a plant size increase to 300 square meters, the purchase of new equipment, and working capital, making possible a five to ten-fold increase in production. Assuming a constant rate of production for 10 years, this would permit a internal rate of return of about 50%, and an increase in work-force to 15-20 people. The cooperative is considering whether to accept the Government loan or raise the money from the members.

El Silencio

Work with this cooperative as a model for the Pacific tropical zone was begun in 1977. It has a number of disadvantages in comparison to Zarcero: poorer educational standards in the local population, a greater distance to the capital (six hours by very rough roads), and no potable water supplies. The cooperative did not have a suitable building for modification and delays were encountered with bank loans to finance the building (designed by CITA). The building, including its own chlorination plant, was completed in May 1980.

The cooperative produces sorghum and rice which, like all cereals, are purchased at fixed prices by the National Production Council. Tropical fruit, primarily papaya, is also produced. Experiments and acceptability trials in the CITA pilot plant have identified three promising products:

- Papaya nectar or syrup used as a drink concentrate. The mixture consists of 70% papaya pulp, 30% sugar, and small quantities of citric acid. This is pasteurized in a steam kettle and bottled.
- Papaya 'bocadillos' or snacks. A high-boiled mixture of 60% papaya pulp, 40% sugar, and traces of citric acid and pectin is concentrated in an open steam kettle and packed in plastic wrappers.
- Papaya jam in glass jars.

Surveys of the fresh papaya market in San Jose revealed that the price is very variable

SECTION 3

and the quality usually poor. Only about one-third of the fruit arrives without visible damage.

Investigations revealed that much of the damage occurs during harvest, which usually involves dislodging the fruit with sticks and allowing them to fall to the ground. Improved handling methods under study include less damaging harvesting methods, the use of wooden boxes to transport the fruit, and ripening the fruit in San Jose instead of on the truck during the journey.

The disadvantage of the project was that it depended on papaya, and therefore could only function for a maximum of 60-70% of the year.

The cooperative was encouraged to diversify its production to include red peppers, cashew nuts, mango and guava as a way of overcoming this problem. However, after several years, it became clear that a series of problems with infrastructural services existed, and by 1983 a consensus was reached to stop the project.

4 Fruit processing - Bolivia (1985)

In 1976, two Belgian volunteers initiated an integrated programme in the Calcha valley in Bolivia which involved organizing a multifunctional cooperative — the Calcha Cooperative — with 10 community associations.

This cooperative aimed at:

- Tackling fruit commercialization and installing two processing units;
- A wine processing unit (capacity: 25,000 bottles/year) with a high quality product, situated at the periphery of the group at Aripalca;
- Solving transportation problems for its members by running a seven-ton truck;
- Solving basic consumer goods supply problems, and running a decentralized store, with an appropriate revolving fund;

- Working in the basic health care sector, and running a local pharmacy;

- Improving agricultural production.

The programme also involved:

- construction of local roads;
- running a mechanical workshop;
- Improving local schools;
- running a training centre.

In 1980, the volunteers left and the task of supporting the cooperative was handed over to two institutions. The training centre, the workshop, the road and dyke construction equipment were handed over to IBTA, a subdivision of the Ministry of Agriculture and Peasant Affairs, under the continuation of the services initially provided to the cooperative by the project. This institute was in charge of providing agriculture extension service to the members of the cooperative. The function of providing the cooperative with managerial assistance and continuing the various management courses that had been organized was handed over the Centro de Investigaciones y Apoyo Campesino (CI-AC) which is a support organisation for peasants' associations.

An evaluation of the cooperative in 1985 found that it had been hit by several factors: bad luck (uncontrollable rate of inflation); poor conception of some of its activities at the start; internal problems; unsuccessful handover of the support services to a government structure; difficult handover of the processing unit's management function.

The wine processing unit is now at a standstill. Its problems included:

- It produced a quality wine but it was hampered by a weak distribution network for a production level which is too small to allow a serious effort at commercialization.
- Peasants had been trained to make the unit function, but the process is too sophisticated to be run without specialized technical back-up; without it, the unit soon had to stop.

Training was insufficient.

SECTION 3

- Furthermore, an incompetent manager/accountant hired by the cooperative was not able to maintain the purchasing power of the revolving fund in a time of hyperinflation (more than 2,400% in 1984).

CIAC propose a rehabilitation plan, financially supported by OXFAM Belgique which involves technical assistance from a similar project in Mizique (Cochabamba district), the reshaping of the revolving fund, and a joint marketing effort with Mizique cooperative.

The jam processing unit has also ceased to run because:

- The commercialization of a high quality product which does not effectively compete with Argentinian and Brazilian imported jams was a limitation. It only worked well as long as the cooperative was able to keep contacts with a miners' consumer cooperative, through a versatile management policy boosted by the volunteer.
- A serious conflict set the President of the cooperative against the members and the only person that had been trained to run the electrical and mechanical equipment: the conflict was solved by the departure of both, thus leaving the unit without an operator.

CIAC is also proposing a rehabilitation plan for this unit. This will involve training of six technicians, an increase in the revolving fund, and joint marketing with other peasant cooperatives.

The 1985 evaluation study concluded that even when operating at full capacity, the jam factory could not solve the marketing problems of fruit growers since it would process as little as 50 kilos of fruit per member. In addition, prices offered by the unit do not always compete favourably. However, it did provide 600 days of work to the peasant owners, and it generated a sense of pride in owning it. Furthermore, it was a good base for management training.

By contrast, the wine factory used much

more fruit and sophisticated technology and external assistance.

In conclusion, the nature and scale of these units, combined with a lack of organisation and attention to marketing and procurement constraints meant that their failure to survive was almost inevitable. The proposed rehabilitation plan should help to overcome some the difficulties experienced in previous years, but will not alter the fact that the technology and scale of operation incorporated in the project are basically inappropriate.

Wines and Vinegars

5 Vinegar processing - Papua New Guinea

Summarised from:

Adams, M.

Kick-start for Village Vinegar in Papua New Guinea

AT Journal, 1987, Vol. 9, No. 2.

Palms of all types have been used for a variety of purposes since earliest times, providing raw material for shelter and for handicrafts as well as food. The production of sugar, alcoholic beverages, and vinegar from palm saps is widespread, although the exploitation of Nipa sap on any scale appears to have been largely confined, until recently, to the Philippines where substantial quantities of fermented Nipa sap are consumed as an alcoholic beverage known locally as tuba.

Successful sap collection requires an important pre-treatment process whereby the stalk is subjected to progressively more violent manipulation over a period of one to two months. Initially, this involves gentle bending and rotation of the stalk, leading finally to severe blows from a suitable implement, or even kicking!

To obtain the sap, the flowering stalk is tapped — that is, the flowering head is cut off with a sharp knife, allowing the sap to

SECTION 3

flow into a collection vessel. As the sap flows the 'wound' tends to dry up; so each day a further thin slice must be cut away from the end of the stalk when the collection vessel is removed for emptying.

Each stalk yields about one litre of sap per day, and tapping continues until all the stalk has been cut away — usually about three months after the initial tapping, depending in the length of the individual stalks.

Vinegar (acetic acid) is produced by a double fermentation process, with much of initial fermentation to alcohol taking place in the collection vessel. In normal practice, the vessels are not cleaned between collections, and are made from materials with a rough surface capable of harbouring the micro-organisms necessary for fermentation. In Papua New Guinea, as in the Philippines, bamboo joints are used as collection vessels, the cut stalk being inserted through a hole cut in the side of the bamboo.

The second stage of the fermentation to vinegar is carried out some 24 hours after the sap collection, using locally-made pots or vats which are half-filled with sap and covered with muslin cloth which allows air to get in but keeps flies and other insects out. The presence of naturally-occurring oxidising bacteria in the pots converts the alcohol to vinegar. At Baimuru in Papua New Guinea, this process has been modified so that the initial batches of fermented sap are inoculated with a culture of acetic acid bacteria to form a layer on the surface of the sap. When the conversion is complete, half of the vinegar is removed from the vat and replaced with fresh (fermented) sap, so allowing continuous vinegar production without the need for further inoculation with bacteria.

A number of other modifications to the traditional Filipino process for producing Nipa vinegar were successfully introduced in Papua New Guinea. These have resulted in more efficient initial fermentation and, by separating the process into two distinct stages, a higher overall yield of vinegar with

good reproducibility is ensured. This work has increased the availability of a product which conforms to the Papua New Guinea legal standard for vinegar.

The vinegar process now established at Baimuru, uses readily available equipment, requires little skilled attention, and is fairly labour-intensive — ideal attributes for a small-scale village industry. The prospects for such an industry in Papua New Guinea seem good now that a product that meets the local legal standards can be produced.

As well as supplying the local market for table vinegar (currently supplied by imports), a further benefit could be the development of local food processing industries, since vinegar is an important ingredient of ketchups, pickles and chutneys.

Drying

6 A solar drier applied to a village

Summarized from:

Carr M. (1984)
Blacksmith, Baker, Roofing-sheet Maker...
IT Pubs., London, U.K.

Clark, C.S. (1981)
Solar Food Drying: A Rural Industry
Renewable Energy Review Journal
Vol. 3, No. 1, pp. 23-26

Clark C.S. and Saha, H. (1982)
Solar Drying of Paddy
Renewable Energy Review Journal
Vol. 4, No. 2, pp. 60-65

Dirks D. (1984)
What is Solar Drying
Generator: Vol. 1, No. 2, pp. 9-10

MCC (1985)
Yearly Report on Employment
Raising Programme

Martens, K. (1981)
A Solar Drier applied to a Village Food
Processing Industry

ADAB NEWS

SECTION 3

Since 1977 the Mennonite Central Committee (MCC), through its job creation programme, has been operating a project on solar food drying as part of its agricultural programme. The main objective of this project has been the adaptation and development of simple techniques for solar drying of fruits and vegetables.

The concept of drying is not new in Bangladesh, since fruits, vegetables, rice, and fish were traditionally sun-dried. Improving the sun-drying method seemed appropriate because it is both simple and safe as a method of preservation. A solar cabinet dryer was adapted for use in Bangladesh and tested on coconut drying.

In 1980, 10 poor women, widows or single wage earners with no other sources of income and physically strong enough to do the work, were selected and each was supplied with coconuts, a solar drier, a grater, and some sulphur, with which to prepare desiccated coconut in her home. Coconut was chosen as having the best potential, because it makes a fine, clean product acceptable to a variety of markets.

Furthermore, the reduction in weight, through husking and drying, is substantial. This is important since coconut is only grown in certain areas of Bangladesh and transport is expensive.

Coconuts are purchased in bulk from local growers. The women clean, grate, and sulphur (to preserve) the coconut. It is then dried in solar driers which the women build themselves at a cost of less than TK200 per unit. Foot-pedal-operated coconut grater machines were introduced and tested in 1984 and loans were provided for each of the producers to purchase a machine.

Packaging is done in bulk in 25 lb (11.25 kg) polythene bags, as well as in 1 lb (0.46 kg) bags and 9 oz (0.25 kg) packages. The bags are heat sealed and packed in metal drums until sale.

The product is distributed out by rickshaw, bus, MCC vehicle, or any other practical means, to the capital, where the product in due course, is sold to food shops in middle-class areas and bazaars, and to street vendors, under the name "Surjosnatho" which in Bengali means 'bathed in sunlight'.

The producers were initially paid on a piece-rate basis, their earnings averaging TK250 to TK300 per month. They dried the coconuts in their own homes on a part-time basis.

Quality problems did arise, apparently originating from outside the drier, and were overcome by a hygiene course for producers and the three management staff on the project. The quality control manager was given full responsibility to implement a programme of quality control designed to bring about a product which accorded with international standards. Close supervision of quality was required, but it became more difficult within the home-based structure as new producers joined. The proposal to change to a factory system, with everyone under one roof, was strongly resisted by the producers, since they felt that they could not leave their homes to walk up to one kilometre before sunrise to commence work.

A compromise was finally reached whereby producers, who numbered 40, began to work in groups of ten to fifteen in bamboo buildings constructed near their homes. Processing continued in this manner until product pricing forced more changes upon them. With a view to reducing costs so as to be able to compete with imported desiccated coconut, the women agreed to double the volume of production by using two driers each while working for the same daily wage.

Unfortunately, although supply did double at lower cost, the demand for coconut did not increase at the same rate, and some producers had to cease production.

SECTION 3

At the moment 23 producers process coconuts, while the majority of the released producers have been kept on to make coir products.

The change to shredding of coir fibres by hand is a difficult and energy-consuming task. The MCC has placed an order with a Dhaka engineering firm to produce a husk-rolling machine and a decortifier/stripping machine which will be tested within the existing project. Little attention seems to have been given as yet to markets for coir products, but the demand for "value-added" coir products such as brooms, mats, and carpets seem to be increasing. This would create more job opportunities, since the production of these items is labour intensive.

Markets for charcoal made from coconut shells have been investigated: local market prices appear to be very low because, as yet, no suitable design of stove is available for burning this type of fuel. If such a stove could be designed and produced, evidence suggests that there would be a good demand for coconut shell charcoal by specialist trade and craft people such as goldsmiths.

The coir product sales have given the project a boost, so that 1984 will be the first year in which the project will break even.

The management is gradually being taken over by the female producers from the MCC project staff and training is being provided to ensure a sustained future.

The major problem which still confronts Surjosnato is the inability to process coconuts during the monsoon season, when cloud cover makes solar-drying all but impossible. Since coconuts are at their most plentiful (and cheapest) and dried coconut at its most expensive during the rainy season, low-cost mechanical tray driers are being tested to see if they can improve the profitability of the enterprise. Initial results look promising.

7 Banana processing in Papua New Guinea

Summarized from:

New K.R.

Community Based Small Scale Food Processing Industries in Papua New Guinea. The Experience with the Situm Banana Chip Enterprise.

Appropriate Technology Development Institute, 1984.

A model community-based food processing enterprise has been established by the Situm Women's Group with the assistance of the Appropriate Technology Development Institute (ATDI) in Lae, Papua New Guinea. Situm is a rural settlement about 20 kilometres from Lae, Morobe Province. The project has been strongly supported by the villagers who have enthusiastically carried out the major groundwork and who now run their own enterprise without any assistance from ATDI.

The Situm project was initiated in February 1981, when the villagers started to build an extension to their tradestore with the intention of developing a women's food-making enterprise. They subsequently contacted ATDI staff members and were shown how to use their surplus bananas to make deep fried chips and to seal them hygienically in plastic bags for sale to the public.

Construction of a low cost kitchen was carried out through the voluntary labour of the village men. The kitchen was designed to suit village conditions and to meet health requirements. The work was of a high standard, reflecting the people's desire for a 'professional-looking' facility.

The women have been very proficient in the production process, achieving a uniform quality. Their product, known as "MR BANANA SIP", is now sold through various stores around Lae.

SECTION 3

The banana chips are made in the following way. First, the bananas are peeled by slitting the skins with a knife and stripping them with the fingers. The sap from the skin sticks to and stains the hands. It was recommended to the villagers that they coat their hands with cooking oil to minimize this problem. The villagers themselves found that rubbing salt on the hands is more effective.

The waste skins are used for pig feed.

Next, the peeled bananas are longitudinally sliced and dropped straight into salted water. Initially a locally made version of an imported slicer, consisting of a wooden board with a stainless steel blade was used. However, this proved to be inefficient and unhygienic. Now an imported moulded plastic unit with stainless steel blade is used. This is quite reasonably priced and stocked by one of the major retail stores.

The bananas are then dried to help prevent the slices from sticking together when they are dropped into the frying oil. Drying can be omitted. However, Situm people once tried frying fresh banana slices and found that they were too difficult to handle. Banana slices are taken out of the salted water and placed on drying racks.

These racks consist of plastic shade cloth stretched over light wooden frames. Earlier, flywire was used but was harder to clean, broke easily, and corroded. The drying racks are placed on shelves in the open shade. This makes it easier to control the drying process than drying in the sun and the product is more uniform throughout. Only a small amount of drying is needed to remove the surface moisture. The women recognize when the slices are sufficiently dried and are careful not to overdry, which results in hard chips and poor colour.

For frying, a high oil temperature is needed to get good crisp chips. During the first year charcoal was used as the fuel for frying the chips. However, lack of good quality charcoal and charcoal cookers made the vil-

lagers look for alternatives.

A smokeless firewood stove made from a clay and sand mixture was constructed by the villagers with assistance from ATDI. This has proved to be satisfactory, allowing the people to use their local firewood in a stove which is easily controllable. The villagers have since built a second stove to allow them to increase production. Each stove has two aluminium washing bowls as frying units. Banana slices are fried until they turn a golden brown and are then drained, cooled, and dusted with salt.

Finally, the chips are packed in polythene bags. These used to be sealed by running the folded top edge over a candle flame which, though functional, did not have a neat appearance. This method was then replaced by a commercial plastic sealer modified to operate from a 12-volt car battery. This worked efficiently but the villagers could not maintain the sealer themselves or conveniently recharge the battery.

The present technique of sealing was brought back by an ATDI staff member from the Household Nutrition Appropriate Technology Conference in Sri Lanka held during 1981. The method consists of folding the top edge of the plastic bag over the teeth of a hacksaw blade (a used hacksaw blade works better) and passing the folded edge through a candle flame. The villagers quickly learned the correct technique to avoid over-melting the plastic and making holes or passing it too quickly through the flame and not sealing it properly. With a little practice this method can be as fast and efficient as machine sealing. A clean burning oil lamp could be substituted as a cheaper alternative to the candle. Packaging in plastic bags is done by hand. The labels are enclosed in the bags. Labelling became necessary to meet a Department of Labour and Industries regulation, thus increasing the packaging cost.

Originally banana chips were sold informally through private orders in and around the

SECTION 3

Situm area. At present an average of 1400-2000 bags per week are sold wholesale to the Lae Health Food store, a well known supermarket, and a school canteen. Consumer acceptance has been good and it seems from the report of the store owners that the potential demand is far higher. Enquiries have been received from retailers in several other provinces, but this demand cannot be met at present. Wide-spread distribution is beyond the present production and organizational capacity of the group.

The management of the enterprise follows a pattern of organization which was largely set up by the villagers themselves, based on their experience in running their own tradestore, piggery, and cash cropping. The village headman is the ultimate decision maker. His wife is the chief organizer on the production side. Their adopted son, who runs the tradestore, looks after the book keeping and logistics. These three received no direct financial benefit — profits from the enterprise go into the community account.

The process of development from a village pilot project to a more commercially oriented enterprise is still evolving. Some of the cost factors are now being assessed and calculated in a conventional business-like manner, whereas other aspects of the costing are still affected by the village perception of customary rights and responsibilities (such as the non-payment of the village headman and his family).

At present it is difficult to say whether the enterprise is viable within the normal commercial meaning of the term. What is clear is that income is greater than expenditure, the women working in the enterprise are paid a satisfactory wage, the village economy is benefitting, and the people are proud of their achievement. The village treasurer is keeping some basic income and expenditure records which show the general state of the enterprise. In the long term, it seems that this enterprise could grow to become a significant local producer of snack food products. Nevertheless, if the enterprise is to retain its true village-based character, this development will be slow, and will depend on the pace at which the villagers themselves gain the necessary expertise.

The Situm group has taken the initiative in teaching what they have learned to interested neighbours, community groups, or schoolchildren and have participated in a number of ATDI workshops. They are proud to show off their achievement and have not considered the problem of creating competition. In any case, there seems to be more room in the market for quality snack food products.

In conclusion, the Situm project appears to be successful and sustainable without further outside support. It is also acting as a valuable model and training ground for the establishment of other village-level snack food enterprises in Papua New Guinea.

Checklist for Project Design

Although the case studies cover a limited number of experiences, they do provide us with an idea of the sorts of factors and issues which need to be taken into consideration when designing a project involving the processing of fruits and vegetables as a commercial venture. These include:

- the social organization and/or culture of the producers;
- the level of confidence of the producers in the feasibility of meeting the objectives and their willingness to risk and invest time and/or money and to take the risk;
- the process of identification of needs, and the level of conception of objectives on the part of the producers at the start of the project;
- extent of local adaptation/development and demonstration of the technology;
- existence of a market for the project;
- the existing production system and division of labour and the possible effects on them of the change introduced;
- technical, financial, administrative, bookkeeping, marketing, management, and (internal) organization capacity of the producers;
- access of producers and continuous availability of credit, technical backstopping, extension, monitoring and other training, and information services;
- availability and accessibility of production and marketing infrastructure;
- year round regular availability of and access to raw materials, fuel and water;
- capacity to produce a standard product from often non-uniform raw material;
- capacity to make integrated use of the available raw material and produce a range of products;
- local availability of necessary tools and equipment and mechanisms/support for national institutes/government to make necessary tools and equipment accessible;
- government policy/interference/administrative flexibility in relation to marketing, export, import aspects;
- macro-economic factors (e.g. exchange rates, inflation).

Facts & Figures on Available Tools and Equipment for Preserves, Drinks and Pickled Fruit or Vegetable Products

1 Water Filters

Charcoal Water Filter

A locally made 20-litre clay pot fitted with a discharge tap at its base and containing graded layers of stones, gravel, sand, and broken charcoal is used to filter water.

Read: *Appropriate Village Technology for Basic Services. A catalogue of devices displayed at the UNICEF/KENYA Govt., Village Technology Unit, East Africa Regional Office, P.O. Box 44145, Nairobi, Kenya.*

Commercial water filters are available in both plastic and stoneware.

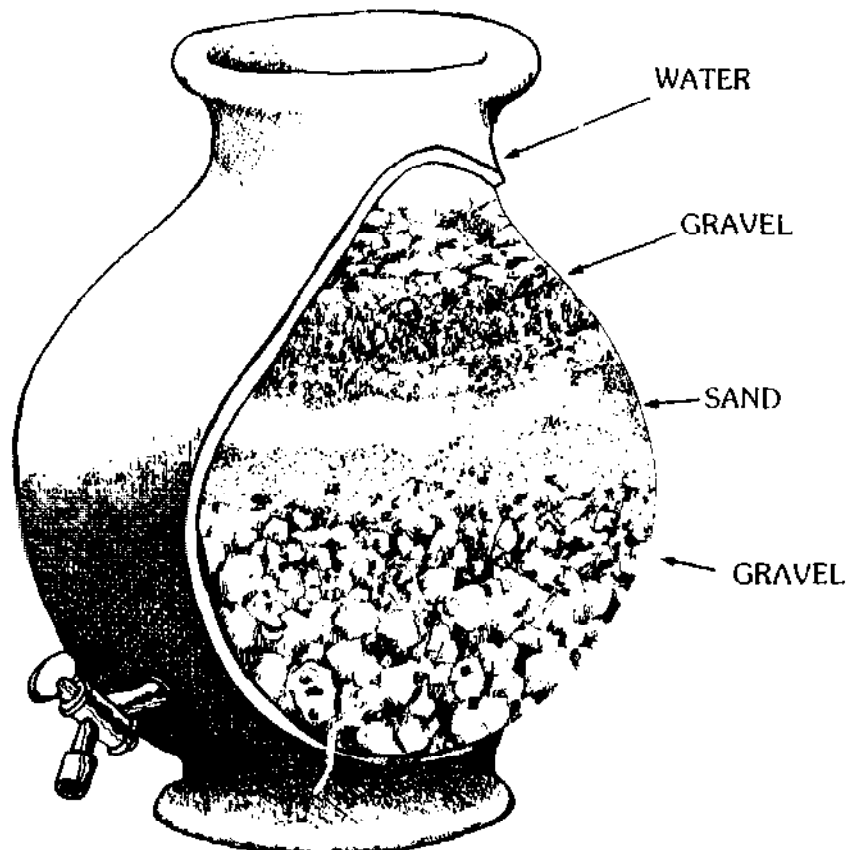

SECTION 5

A low cost water-filter which consists of a mat of fabric on a bed of sand in a large tank is currently undergoing trials. The mat supports bacteria which clean the water and the sand filters out solid impurities.

Write to:

Pendar Environmental
PO Box 22
Hampshire Ind. Est.
Bridgewater
Somerset TA6 3NT
U.K.

Small pressure purifiers for piped water which can be attached to a tap are available from:

Fairey Industrial Ceramics Ltd.
Stone, Staffs ST15 0PU
U.K.

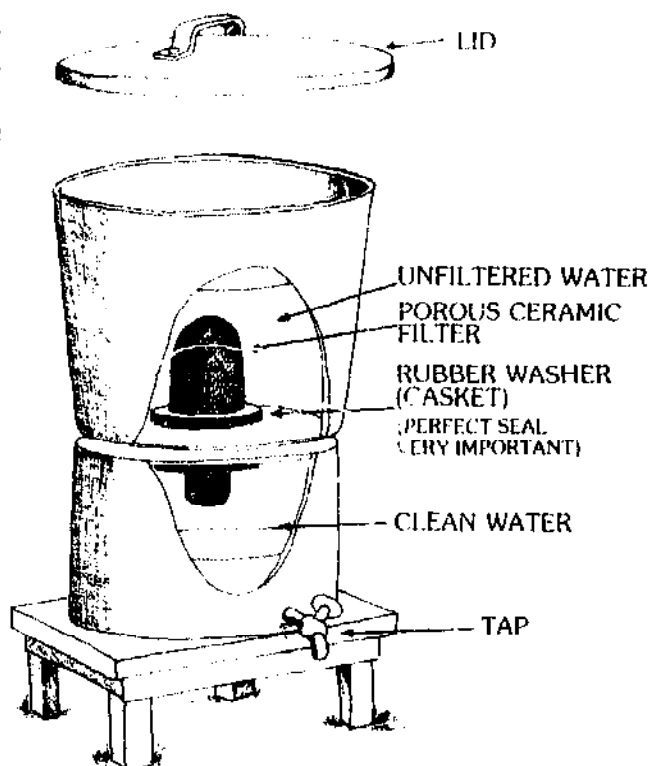

2 Preparation Equipment

Cherry Pitter

Simple peeling, coring, and de-stoning equipment can in many cases be made locally or supplied by:

Lehmann Hardware & Appliances Inc.
P.O. Box 41
4779 Kidron Road
Kidron, Ohio 44636
U.S.A.



SECTION 5

Apple Peeler

Cutting is usually done with a knife. In larger projects or for products which require uniform sized pieces or special shapes, commercial cutting machines are available for slicing, chipping, dicing, grating, ranging in size from hand operated to large continuous machines.

Small scale electric machines are available from:

Lehman Hardware
P.O. 41
4779 Kidrom Rd.
Kidrom, Ohio 44636, USA

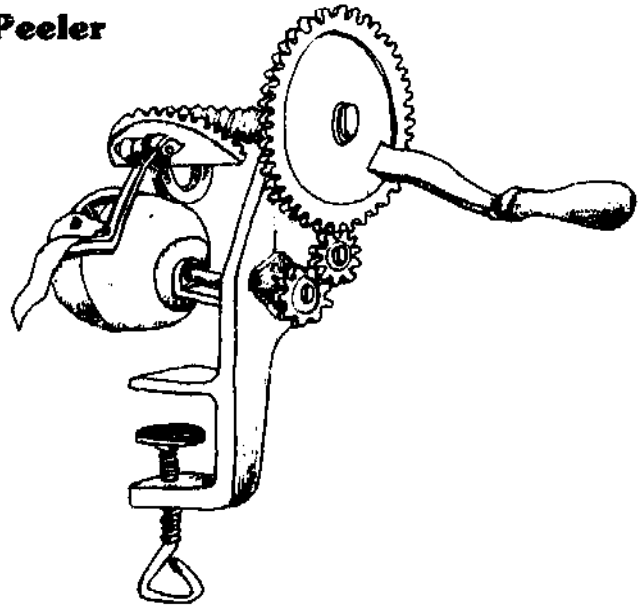

3 Sulphuring and Sulphiting

Sulphur dioxide is a preservative which is used to keep fruit out of season and hence spread production throughout the year. It is also used prior to drying of some fruits (mangos, apricots) to retain colour. However in other fruits sulphur dioxide bleaches colour.

Sulphur dioxide can be produced in two ways for use with both fruit and vegetables as follows:

- Burning sulphur in a sulphur chamber to produce sulphur dioxide gas, which permeates into food tissues.
- Producing sulphur dioxide in solution

by dissolving sodium sulphite or sodium metabisulphite (Campden tablets), in water. This can then be used for blanching water or, when steam blanching is employed, by spraying a sulphite solution on to the food or by soaking it in a cold solution following blanching.

Burning sulphur is more appropriate than a sulphite dip prior to drying as the food is not wetted.

Sulphur dioxide is harmful and precautions are necessary to prevent inhalation. A sulphuring cabinet may be constructed

Sulphuring Cabinet 1

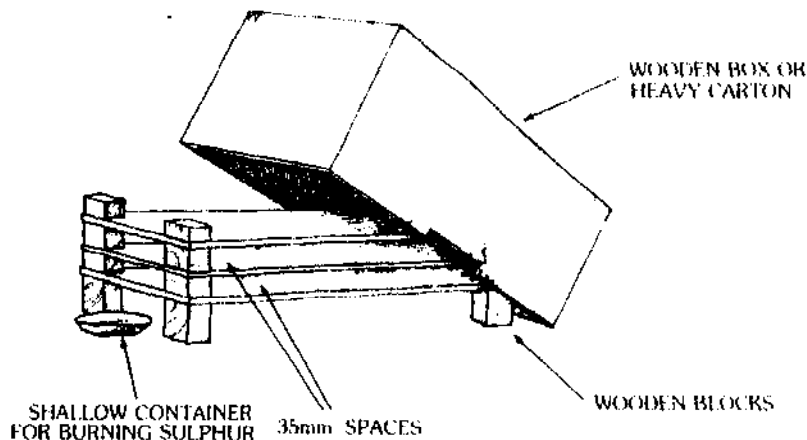

SECTION 5

from polythene sheeting, wood, or glass. The main features are removable trays, a small hole to allow air into the cabinet for sulphur combustion, a small vent hole, and an adequately sealed door.

Two designs are shown. Sulphur dioxide gives food an unpleasant flavour and it is therefore removed before consumption by boiling or heating the food to drive off the gas.

Sulphuring Cabinet 2

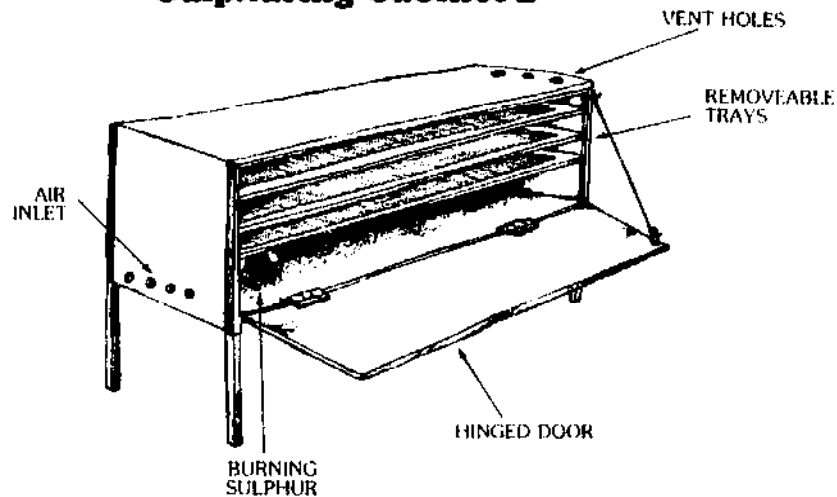

4 Pulpers/Juice extractors

Juice from most fruits can be extracted by each of the methods described below, but ap-

ples, morello cherries, green grapes and citrus fruit are best squeezed without heating.

Juice Extractor

Juice extraction using heat

A juice extractor can be made using a lidded kettle or pan with a rack on the bottom which supports a bowl or dish to catch the juice. Two boiled white cloths (muslin where possible), one of coarse weave and one of fine weave, are fitted over the edge of the pan to hold a piece of strong greaseproof paper put over the fruit on the cloth to catch the condensation from the steam.

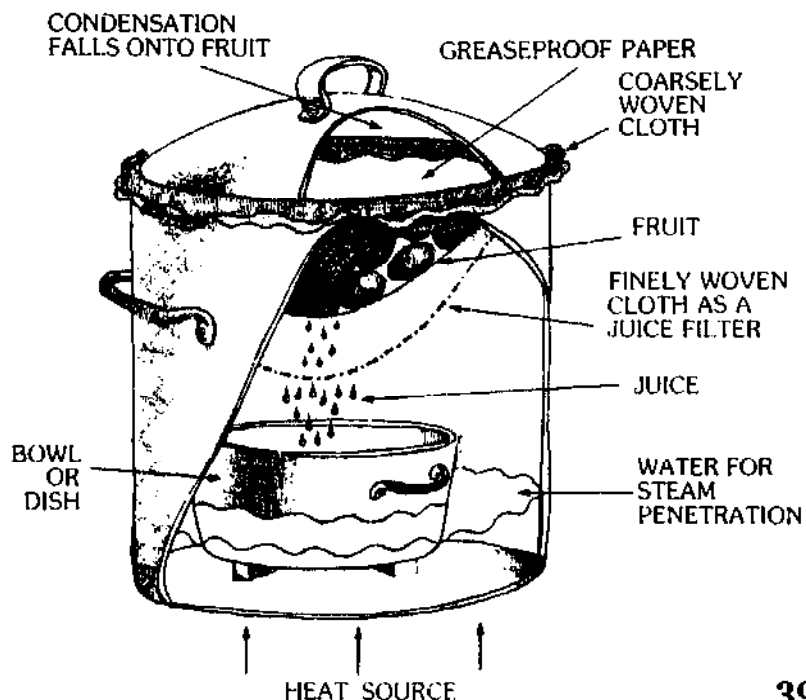

SECTION 5

Juice extraction without heating is done using presses or pulpers. Presses are operated by simple levers or for larger scales of production they may be hydraulically operated. Pulpers are manually or electrically operated. Below are examples of manual presses.

A Simple Fruit Press

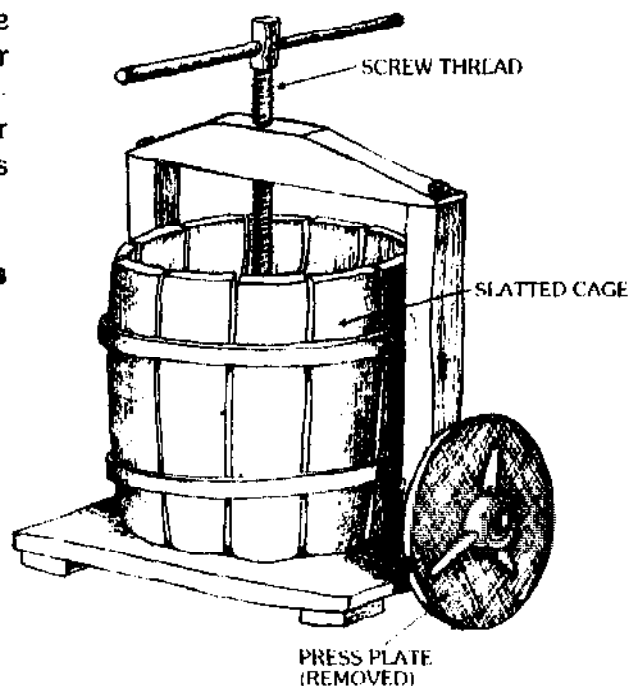

Crusher

Crusher mounted on top of fruit press.

This lever-operated press achieves a 25 litre/hour output when operated by one person. The crusher grinds and crushes in one operation. Output for apples is 150 kg. per hour.

A number of designs of **pulping machines** are available for different applications and scales of production.

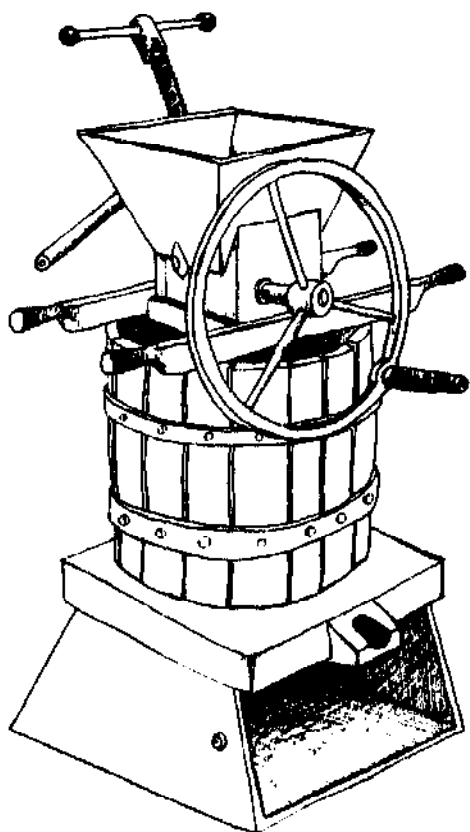

SECTION 5

Victorio Squeezer

Simple hand-operated screw pulpers are suitable for small scale production, for example the Victorio squeezer.

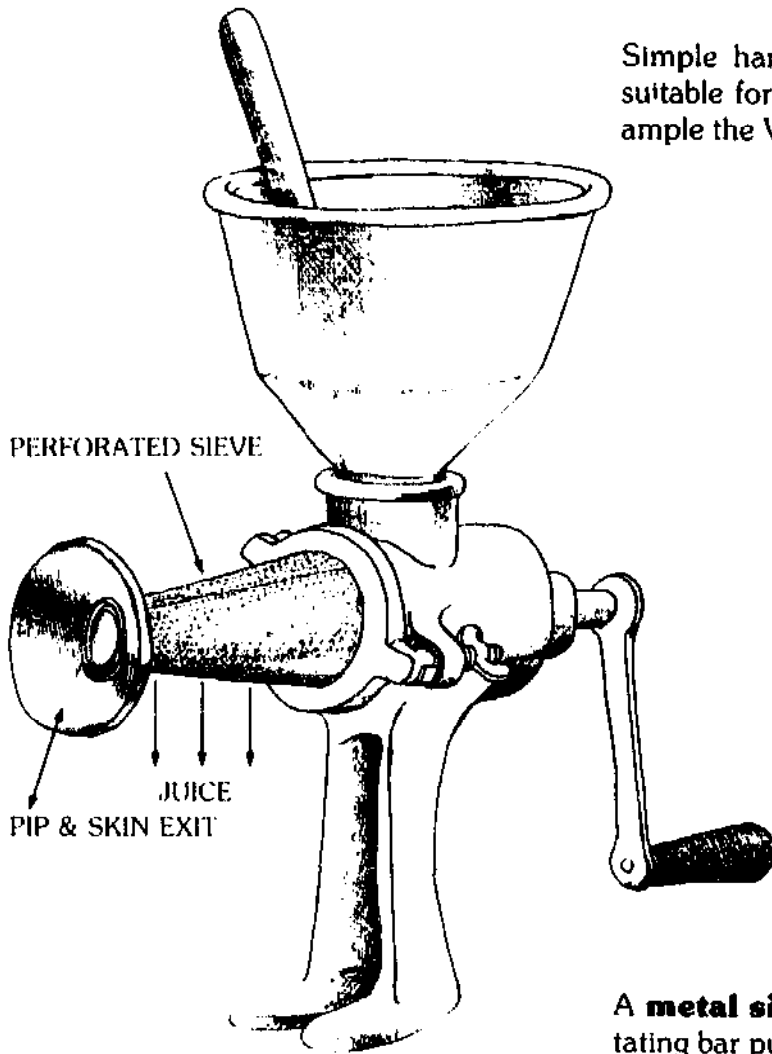

A **metal sieve**, with a hand-operated rotating bar pushes fruit through the sieve.

For larger scale operation and the production of relatively clear juice kitchen food mixers of the Kenwood type have attachments that are suitable for pulping as well as juice extraction.

Write to:

Thorn EMI Domestic, Electrical Appliances
New Lane
Havant, Hampshire PO9 2NK
U.K.

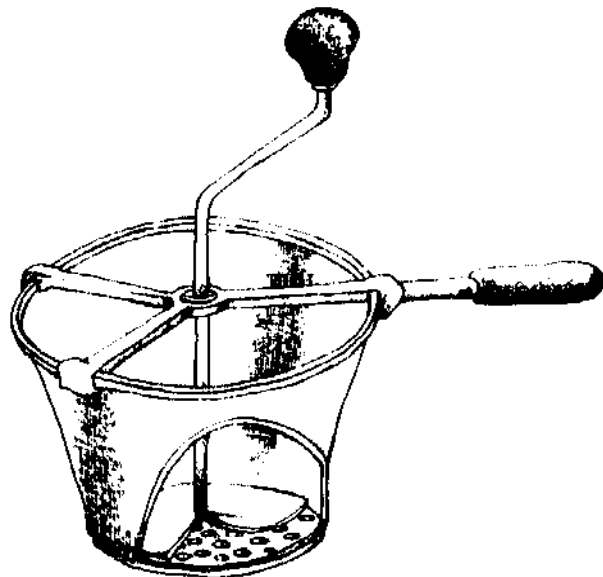

SECTION 5

Another design of a **juicer/pulping machine** consists of an auger/sieve combination mounted on an aluminium frame. The device can also be supplied with a handle for manual operation, or an electric motor.

It is designed primarily for apple and tomato products and produces juice which is free of seeds and skins at up to 405 kilos of tomatoes per hour.

Write to:

Joel Jackson
Food Preservation Systems
New Windsor Service Centre
Box 188, New Windsor
Maryland 21776
U.S.A.

Or:
Gebr. Tigges
2 Sunninghausen
4740 Oelde
W. Germany

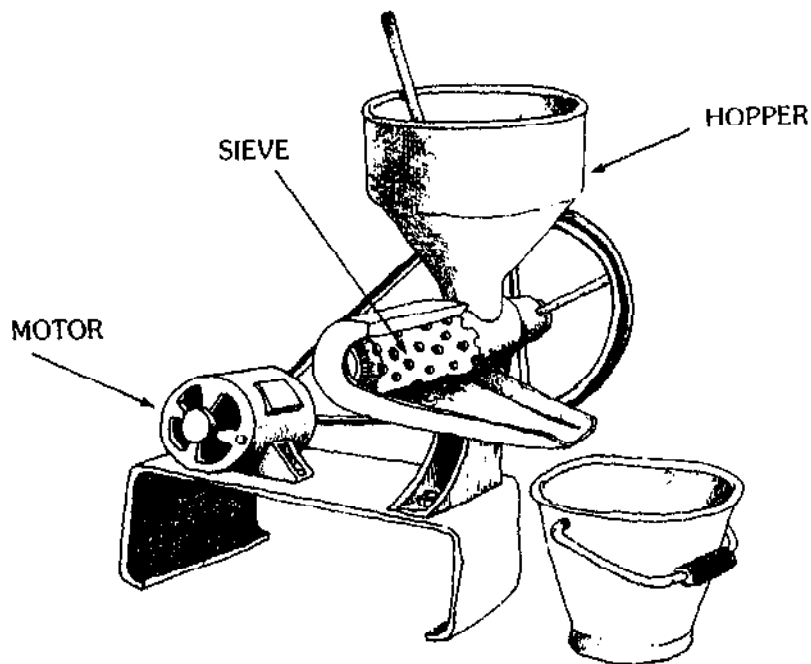

SECTION 5

5 Filtering/Straining

Jelly Bag

A jelly bag is used to filter juices, syrups and jellies and make them into crystal clear products.

Write to:

BRITAM
5 Ferry Lane Industrial Estate
Brentford Middlesex TW8 0AW
U.K.

Care must be taken to ensure that the bag is clean and it should be thoroughly washed and boiled after each use.

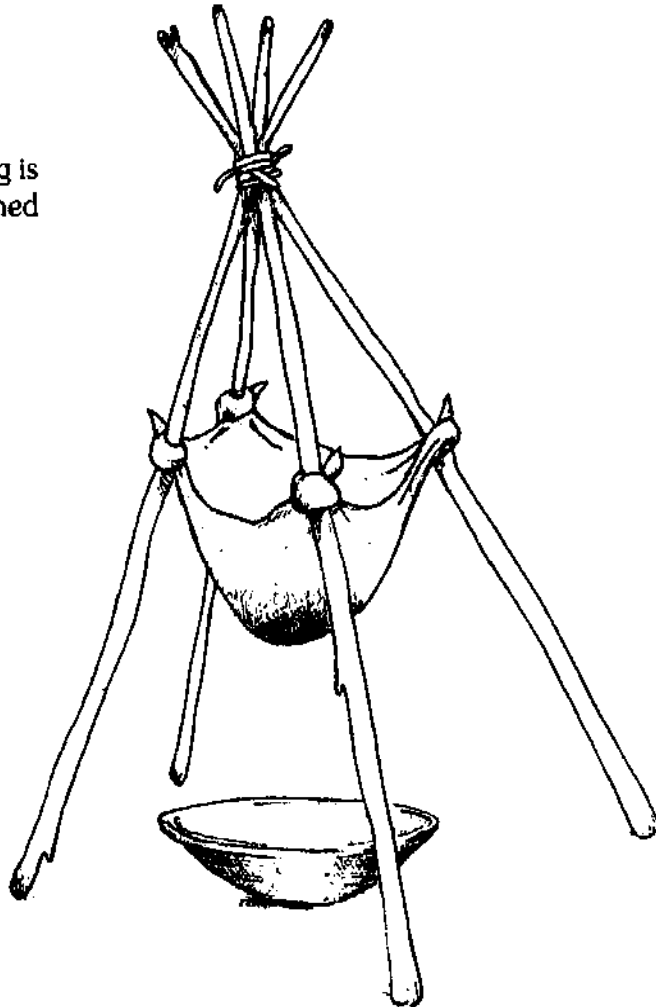

A hand operated mechanical fruit sieve is made by:

GRET
203 Rue Lafayette
Paris 75010
FRANCE

SECTION 5

6 Containers for Preparation of Product Batches

Plastic containers and measuring jugs are widely available and generally inexpensive. Care should be taken to ensure that they are 'food grade' plastic as cheaper materials contain plasticisers which taint the food.

Write to:

WCB Containers Limited
Stamford Works
Bayley Street
Stalybridge
Cheshire. SK15 1QQ
U.K.

Aluminium or enamelled containers are suitable but other metal containers should not be used as they react with acids in fruit juice. Wooden containers are difficult to clean properly and should only be used if other types are not available. More durable containers made from stainless steel are available but are very expensive.

Measuring equipment	Fluid (millilitres)	Sugar (grams)
Cooking spoon	50ml	85g
Table spoon	15ml	25g (level)
Teaspoon	5ml	8g
Cup	120ml	200g

Metric conversion table			
	When you know	You can find	If you multiply by
Weight	ounces	grams	28
	pounds	kilograms	0.45
	grams	ounces	0.035
	kilograms	pounds	2.2
Fluid	ounces	millilitres	30
Volume	pints	litres	0.47
	millilitres	ounces	0.034
	litres	pints	2.1

SECTION 5

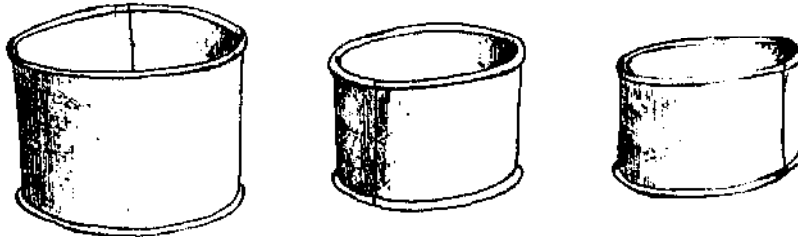

Tins of various sizes can be used as measures

7 Boiling

For small scale boiling of foods using wood-fuel there are a number of stoves available, which consume less fuel, cook faster and cleaner and are more convenient to use.

Write to:

Intermediate Technology Development Group
Fuel for Food Programme
Myson House
Railway Terrace
Rugby CV 21 3HT
U.K.

Boiling pans should be made of aluminium, enamelled metal or stainless steel. For larger quantities it is necessary to buy equipment which does not cause burning or sticking of the product to the bottom of the pan. Stainless steel steam jacketed kettles, that is, a double walled pan are suitable and can be obtained with capacities from 5 to 500 litres.

Write to:

Raylons Metal Works
Kondivitta Lane
Andheri-Kurla Road
Bombay-400 059
INDIA

Similar ones can be obtained in the U.K. but are more expensive.

For information write to:

T. Giusti Ltd 202-228 York Way
London. N7 9AW

Brierley, Collier & Hartley Equipment.
Bridgefield St.
Rochdale, Lancashire. OL11 4BX.
U.K.

Israel Newton Ltd.
Summerley Works
Bradford, Yorks
U.K.

SECTION 5

8 Pasteurisation

Bottled fruit and some liquid fruit products are pasteurised in the container. This is achieved by loosely placing the cap onto the filled bottle or jar and heating it in a container as shown. In this equipment boiling water covers up to the shoulder of the filled bottles in an enclosed chamber. Containers are placed on a rack and heated by the boiling water.

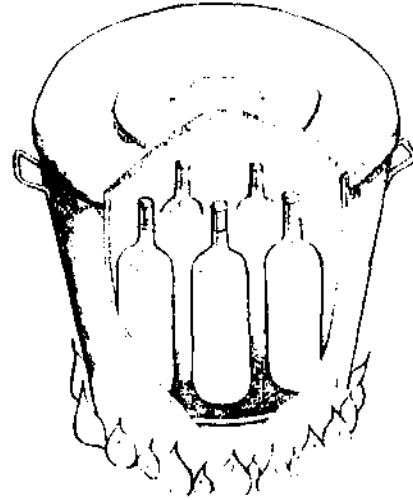

9 Washing of Bottles

If no soap is available ashes can be used as a substitute to clean bottles and containers. Thorough rinsing afterwards is essential. A simple rinsing method involves a series of spigots let into a length of pipe which act as rinse sprays.

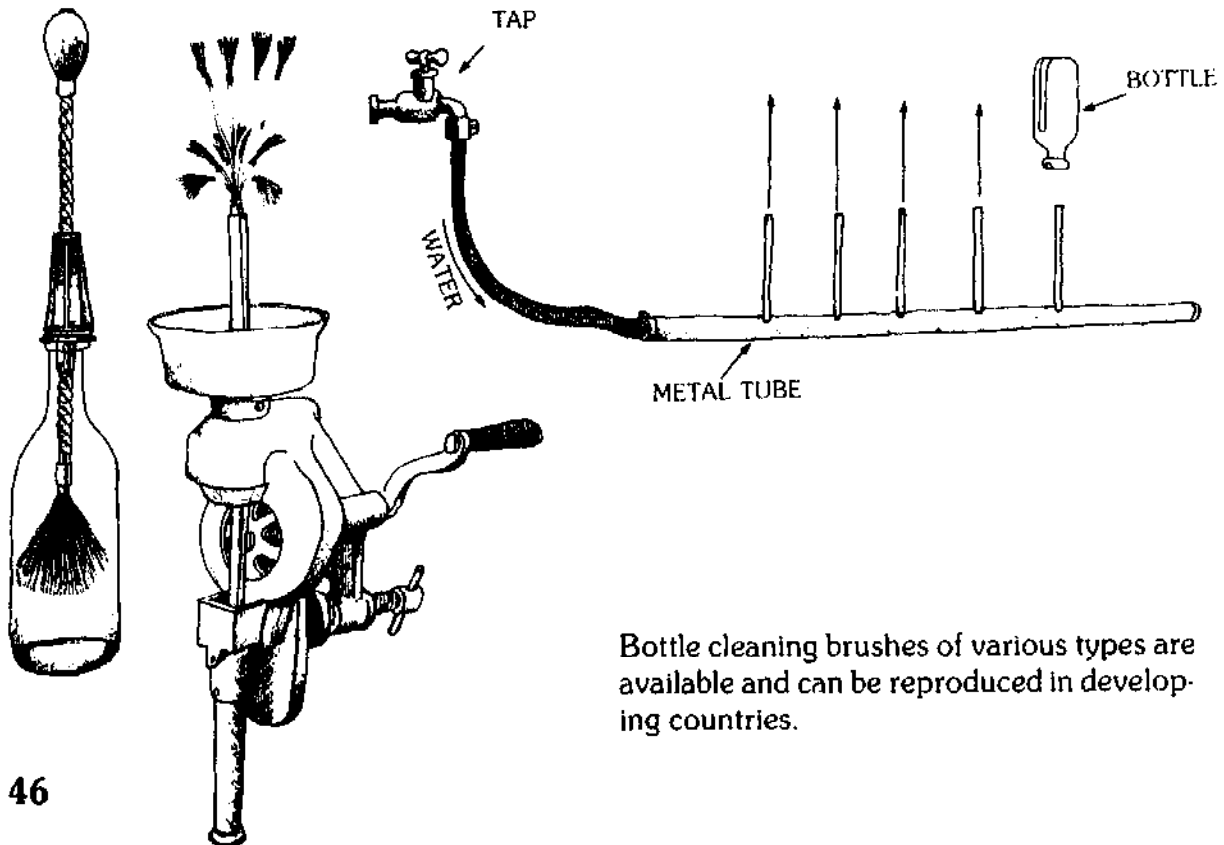

Bottle cleaning brushes of various types are available and can be reproduced in developing countries.

SECTION 5

10 Sterilization of Bottles and Jars

Bottles can be sterilized very simply by holding the open neck over the spout of a kettle of boiling water.

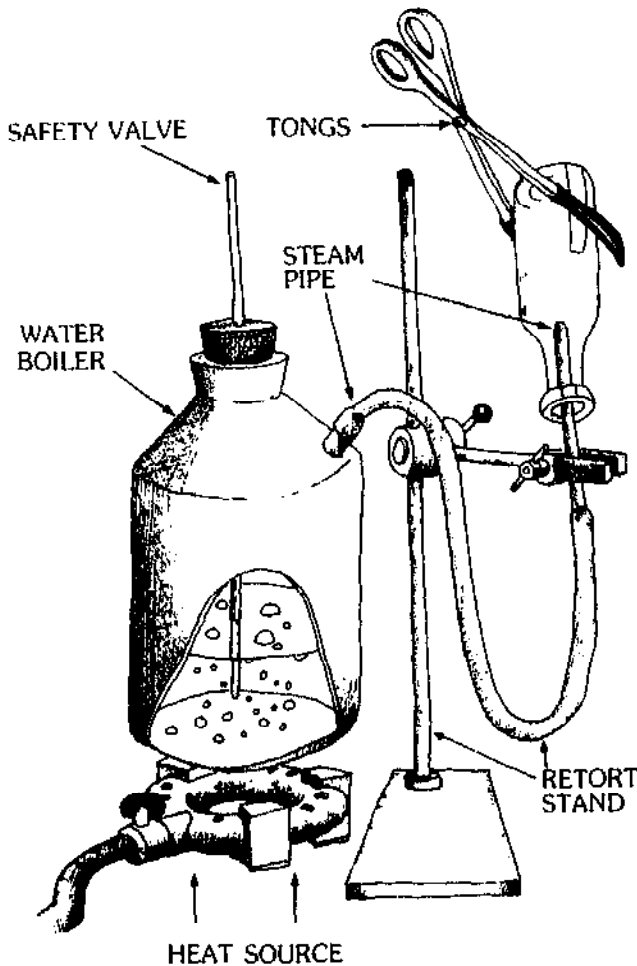
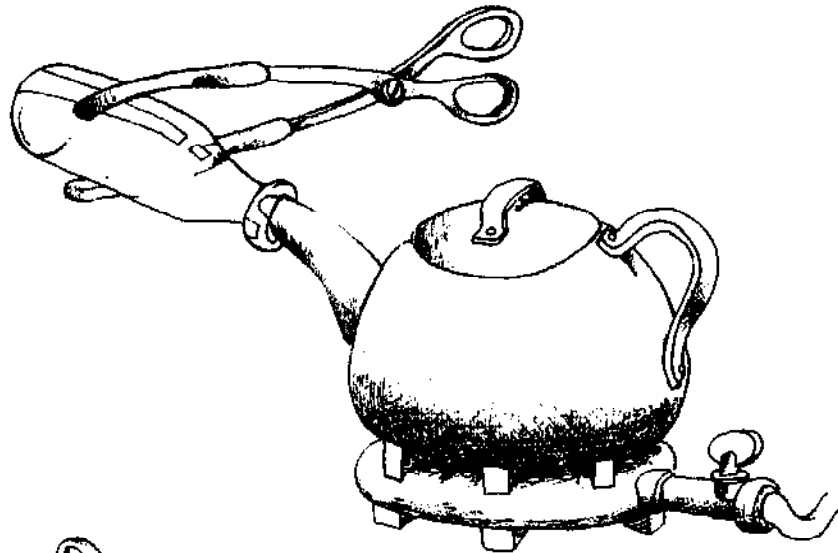

Alternatively bottles can be inverted over a steam pipe, supplied from a water boiler which should be made of brass, tin or copper to prevent rusting. The vertical pipe is essential as a safety valve.

SECTION 5

11 Filling of Hot or Cold Liquids

Suitable vessels (food grade plastic or stainless steel) fitted with outlet taps can be used as a filler for juices. For example, 2 or 5 gallon plastic double walled water coolers with taps are very useful if the product is not too hot. At higher packaging temperatures a stainless steel bucket can be used. A small stirrer to prevent settling of fruit particles in the juice may be required for some products.

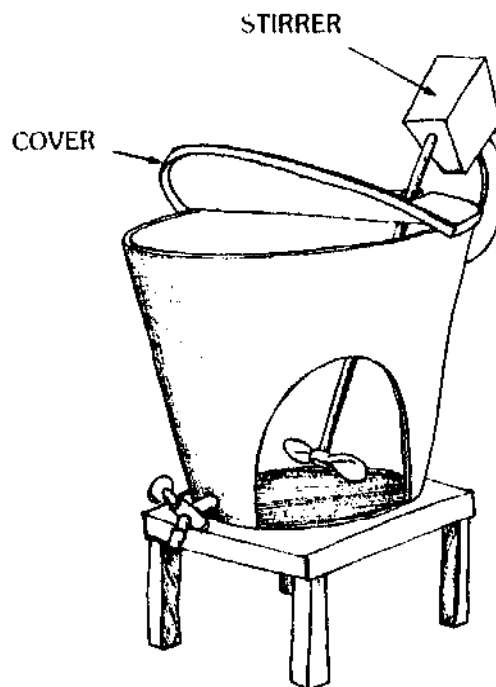

Sauces, because they are thick, require a different type of filler. A very simple, cheap locally produced filler consists of a large plastic funnel, the stem of which is just less than the bottle neck size. A length of plastic rod acts as an on-off valve to control the flow of sauce. In practice 4 such fillers could fill 3000 packs/day.

Hand operated semi-automatic piston fillers are produced by several companies for filling juices and sauces. The capacities vary from approximately 15ml. to 1 litre containers and parts are available in stainless steel if required.

Write to:

AMBESCO
5600 W. Raymond St.
Indianapolis, In. 46241
U.S.A.

SECTION 5

12 Capping

Suitable machines can be produced locally. Drawings of these different capping machines are available at:

Intermediate Technology Development Group
Myson House, Railway Terrace
Rugby
U.K.

Another example is provided by:

GREY.
203 P.ue Lafayette
Paris 75010
France

Hand bottle cappers are also available from:

AMBESCO
5600 W. Raymond St.
Indianapolis
In. 46241
U.S.A.

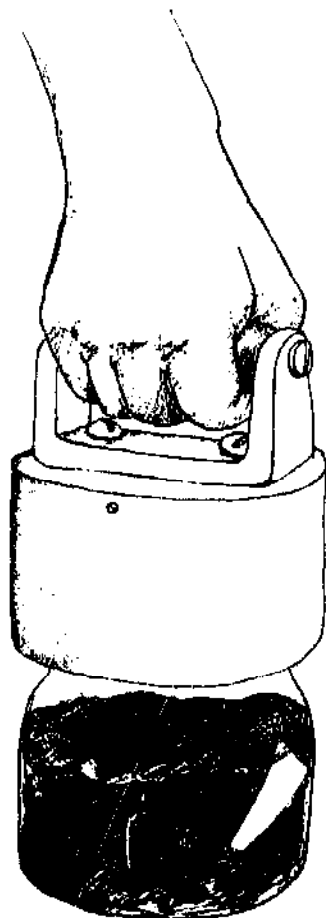
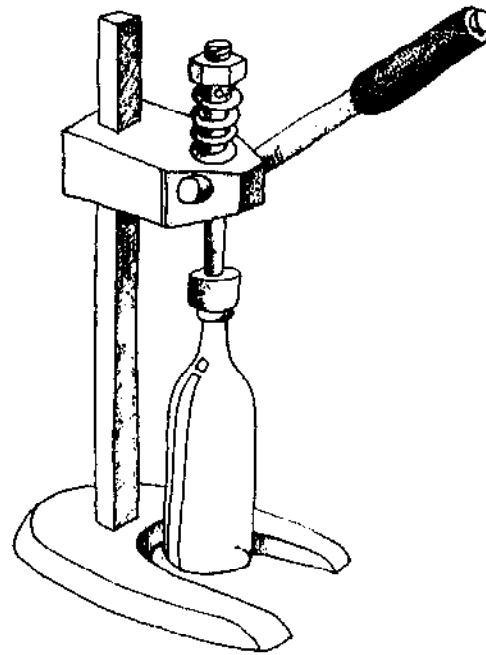

Jam Jar Sealer

The sealer is a more efficient method of sealing jam jars with push-on lids (compared to domestic methods using plastic and rubber bands.)

Ref. Anon (1985), *Tech & Tools at Nairobi in July 1985*. AT Journal 1985, Vol. 12, No. 1, p. 20.

A low cost product is made in Sri Lanka.

Write to:

Industrial Development, Board of Ceylon
615 Galle Road - Kabubedda, Maratuwe - Sri Lanka

U.K. Manufacturer:

Thomas Hunter Ltd.
Omnia Works - Mill Road, Rugby, CV21 3HT - U.K.

A note should be made regarding the kind of plastic to be used in the manufacturing of the lid sealer. It was found that a hard plastic makes the lid sealer suitable for only one specific size of jar, which proves a big disadvantage especially in countries where the bottle or jar necks are not always regular. A more flexible material allows the sealer to be fitted on different sizes of container.

SECTION 5

13 Cooling

The cooler shown below is used for both glass and metal containers. A shallow bath is constructed and hot bottles enter at point A and roll slowly down the sloping bottom to B where they are removed. Cold water enters at B and overflows as hot water at A. A weak solution of bleach is allowed to drip into the end B, thus ensuring that the cooling water is chlorinated.

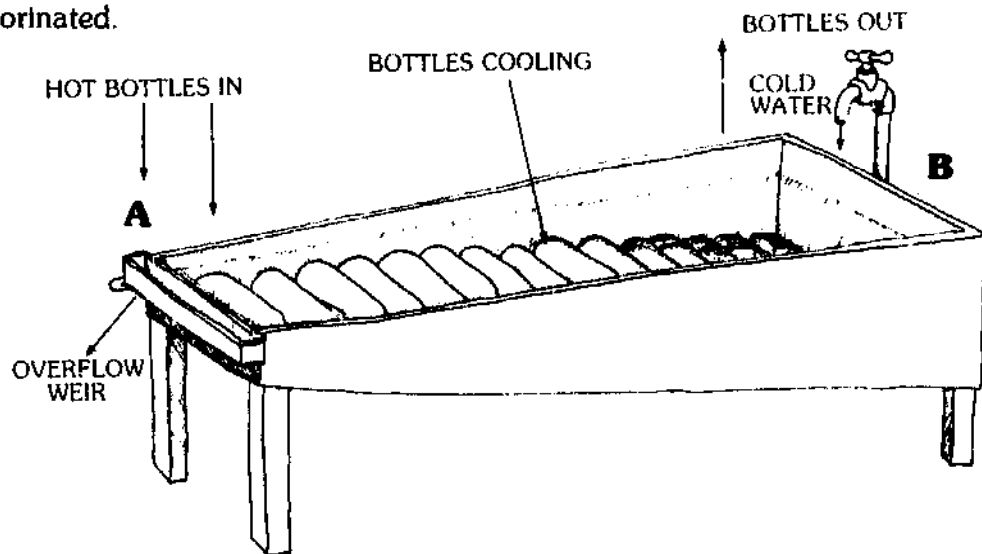

A slightly different method is used for jars of jam. In order to set into a smooth gel the jam jar must be allowed to cool standing in a vertical position. The filled jars are loaded into 'carriages' and then placed in the cooling trough as for the bottles. Alternatively jam jars can be cooled more slowly in air.

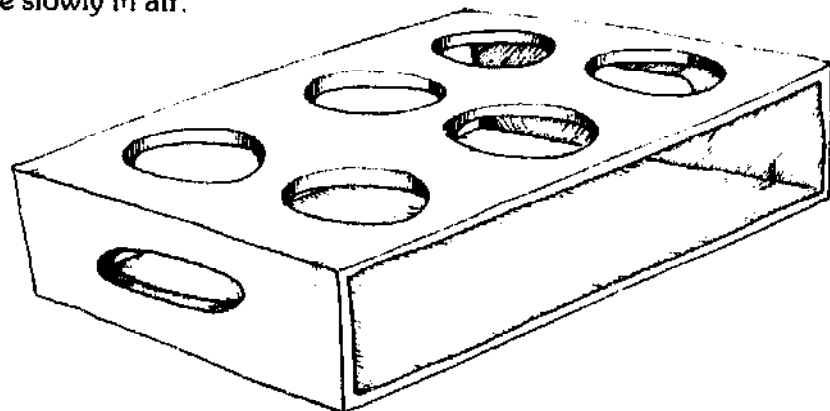

SECTION 5

14 Labelling

Hand operated labelling and glueing machines can be obtained from:

Pot Devia Label and Glueing
200 N Street
Teterboro, New Jersey 07608
U.S.A.

15 Quality Control

A refractometer is a quality control instrument used to obtain readings of the percentage of sugar in a product. For jam it is very important that this should be exact.

Ref. Anon (1985), *Tech & Tools at Nairobi* in July 1985. *AT Journal* 1985, Vol. 12, No. 1, p. 20.

JAM SPECIMEN INSIDE

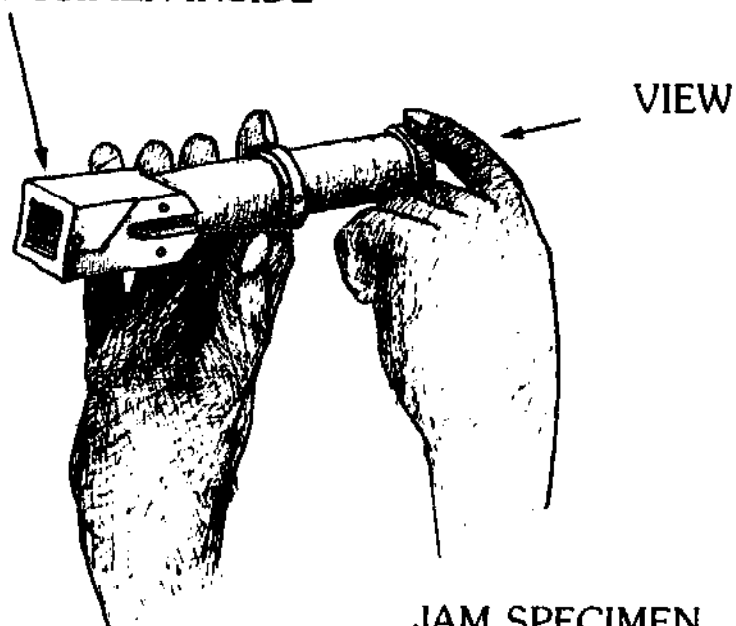

JAM SPECIMEN

OPEN POSITION

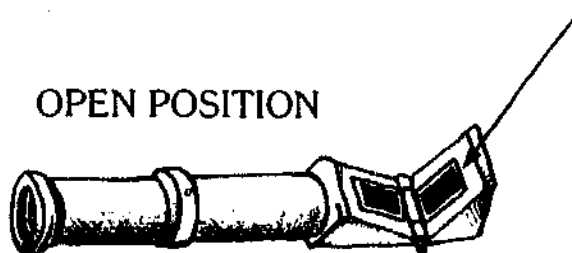

Suppliers:

AMBESCO
5600 W. Raymond St.
Indianapolis, IN. 46241
U.S.A.

Or:

Scientific Supplies
Vine Hill
London
U.K.

Facts and Figures on Available Tools and Equipment for Fermented and Dried Fruits and Vegetables

1 Fermentation Equipment

Airlock

Fermented and Dried Fruits

Fruit crushers

Depending on the scale of production the devices described in Section 5 (4) can be used for crushing fruits.

Containers

While traditionally such things as salt glazed earthenware crocks and oak tubs were often used, nowadays food grade plastic materials are more suitable in terms of hygiene and may be cheaper. (Section 5 (6)).

Bottle-filling equipment.

See Section 5 (11).

Air locks

As sugar ferments to alcohol, carbon dioxide gas is produced as a by-product and this rises to the surface as bubbles. An airlock is simply a one-way valve which allows this gas to escape from the container but at the same time prevents unsterile air, which could cause contamination, from entering the vessel.

Airlocks can be made out of a piece of curved glass or plastic tubing placed in the bung. The tube must be half filled with cold boiled water containing a small quantity of sodium metabisulphite. It is essential to ensure a good seal between the bung and the jar and between the airlock and the bung. The airlock tubing itself should not be too narrow otherwise the water can be pushed out: 3/8 inch is the minimum diameter for the tube. Glass air-locks indicate the activity of fermenting best, but they are fragile and break easily. In the absence of any such lock a plug of cotton wool may be used.

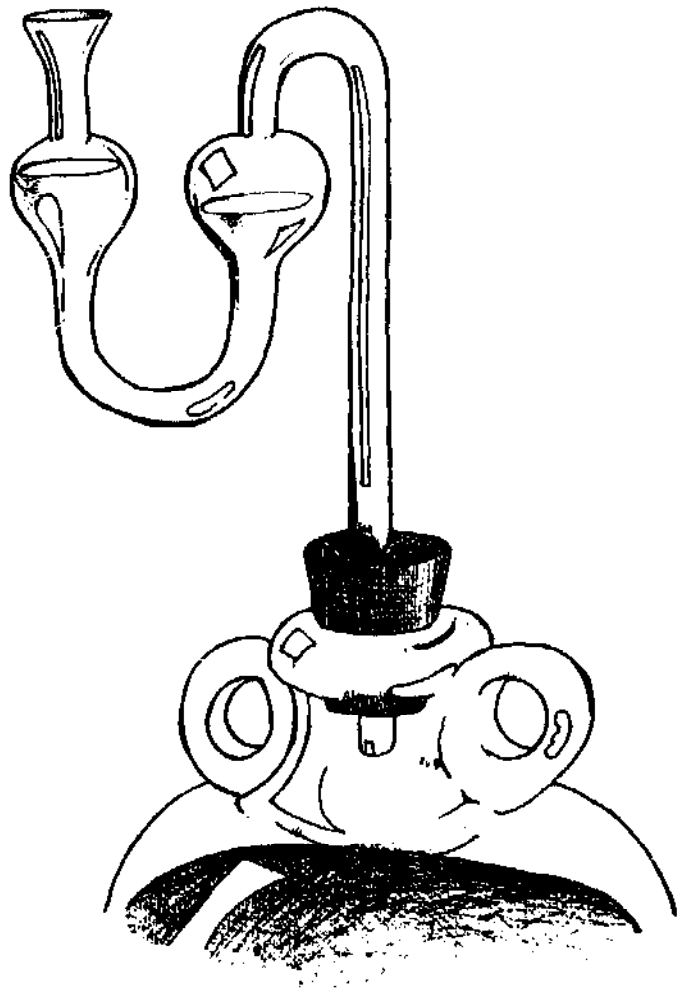

SECTION 6

Hydrometers

These are very useful for accurate control of the process, both for the alcohol content and the sweetness of the final wine. Special wine hydrometers are available and are graduated specifically to measure the alcohol content of wine. Other types of hydrometers are not suitable.

Supplier:

Scientific Suppliers, Vine Hill, London, UK.

Corking equipment

New corks, cylindrically shaped and of the best quality, should always be used if possible. Poor quality corks allow the wine to seep through them and air to enter the bottle, causing the wine to taste flat and even vinegary. Corks soften easily if dipped in hot water or if soaked for a few hours or overnight in a sulphite solution. The sealing of corks in the bottles with wax is still a commonly used method.

Vegetables

Blanching

The vegetables can be placed in a cloth or a basket made from wire, woven mesh or perforated metal. They are then either dipped in boiling water or steamed by suspending above boiling water.

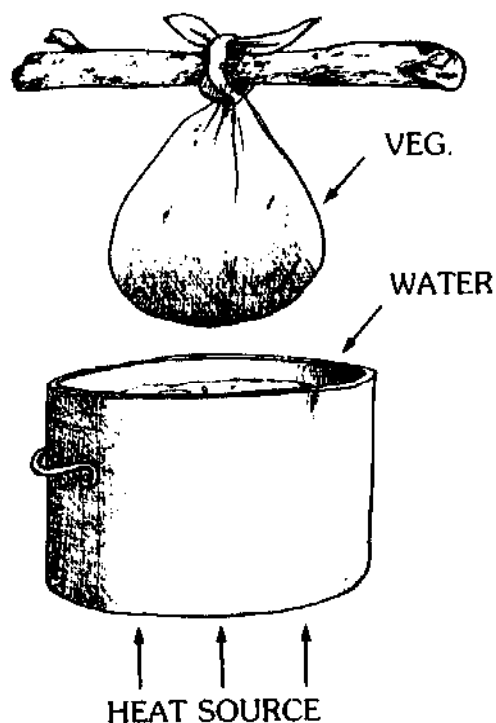
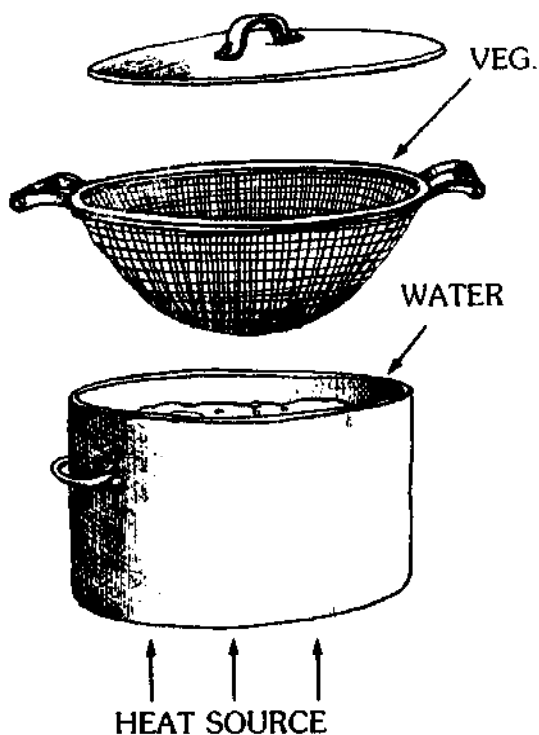

SECTION 6

is used.
vegetables and
from wood,
or plastic. A
to keep the
of the liquid
a glass jar

filled with water. A pressure plate which catches under the neck of the vessel makes the use of a weight unnecessary (b). Alternatively a thick plastic film or 2-3 layers of thin film, laid loosely over the edges of the container and tightly sealed, is filled with 2' of water (c).

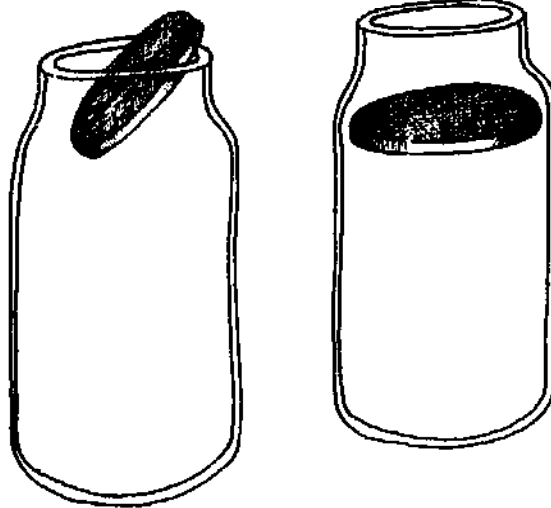
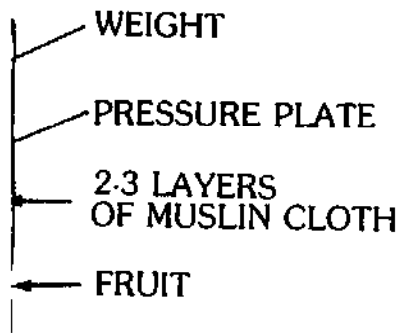

2-3 LAYER
OF PLASTIC
FILM

WATER

FRUIT

SECTION 6

2 Drying Equipment

A separate DRYING SOURCE BOOK provides information on drying mechanisms and the choice of driers for specific crops

Fruits and vegetables are frequently sulphited and sometimes blanched prior to drying. Equipment for these operations is described in Section 5 (3).

Driers

Brace Research Institute Drier

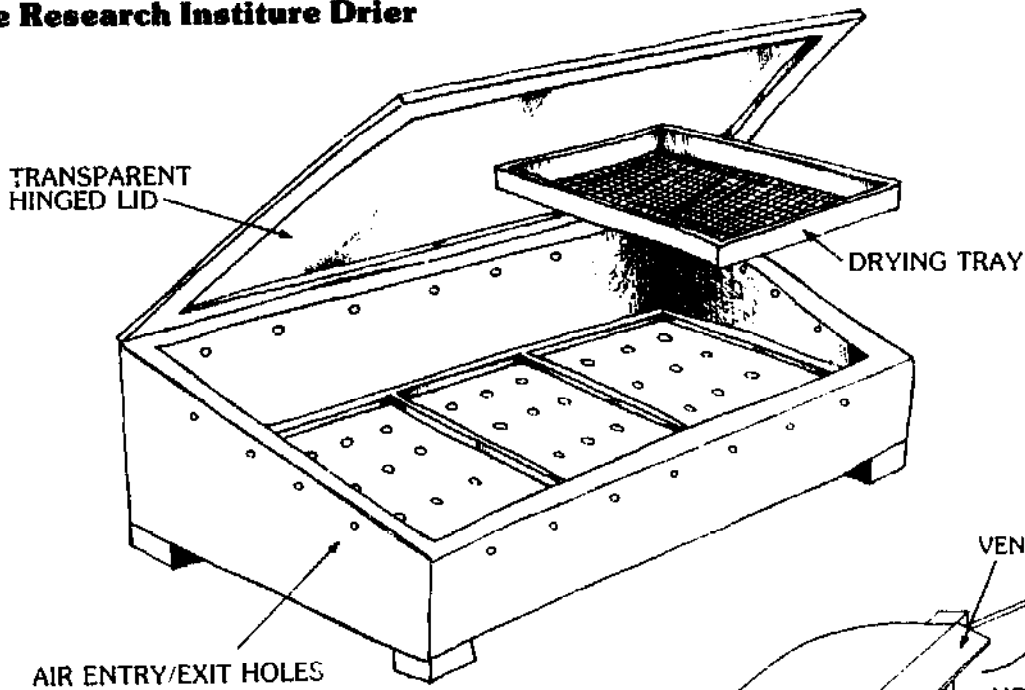

Indirect Drier

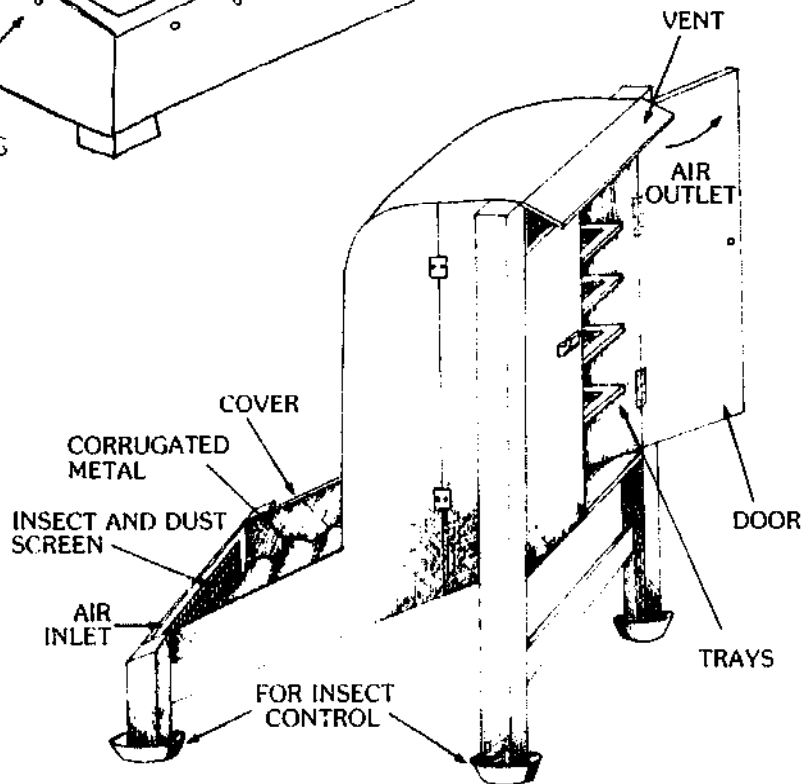

SECTION 6

3 Packaging

The **PACKAGING AND STORAGE SOURCE BOOK** provides information on different alternatives.

Polythene is a cheap and widely available material for bags of dried fruit or vegetables.

Write to:

Johns Bass & Co. Ltd
Castle Street
Knott Mill
Manchester M3 3ND
U.K.

Heat sealers (see also case study 7)

Plastic bags can be sealed by folding the edge of the bag over the teeth of a hacksaw blade (a used hacksaw blade works better), and passing the folded edge through a flame. The result does not look as good as when a heat sealer is used, but practice can improve the appearance of the bag.

A simple machine seals plastic bags by pressing the plastic between heated bars on which a special tape is placed to prevent the plastic melting. For example:

Bar Type Impulse Heat Sealer

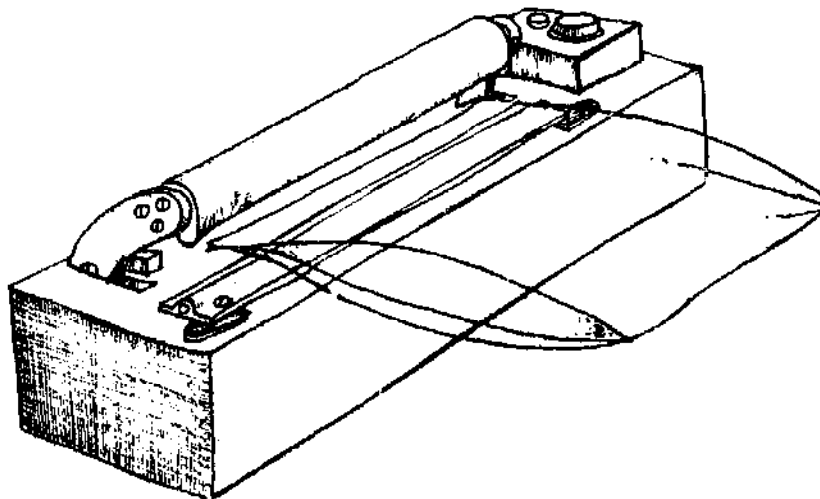

This machine can be locally reproduced. While it is designed to use electricity, alternative sources could be used for heating the bar (a hot iron for example).

Write to:

Thomas Packaging Equipment Company
Senate House, Tyssen Street
London E8 2ND
U.K.

SECTION 7

Requirements for Setting Up a Small Food Processing Unit.

Based on the experiences of a Redd Barna Project at Ranna, Sri Lanka the following are recommended. Rs 24 = US \$1 (1985 prices).

A small factory building is required initially, if the project is to run through a pilot stage, an existing building could be utilized. A working area, storage area, toilet, large sink, and water tank are needed. Electricity would be useful but is not essential. The size should be about 400 feet square (35-40 square metres). If a building is to be purpose built then a hygienic design needs to be considered — for instance the floor should be sloped for drainage, all surfaces should be smooth and easily cleanable, etc. The cost would be approximately Rs. 100,000. (US \$4200, 1985 prices)

The optimum number of workers for a unit of this type is probably about 6, but will depend on level of output anticipated. The level of education amongst the Redd Barna trainees is high (all have passed O level exams and half have A levels), but this standard is not essential. It is important to have people who can do the accounts and calculate costings. One or more people will be responsible for selling/marketing.

Furnishings and Fittings

	RS	\$ US
Large work table	1,500	62
Small table for cooker	350	15
Shelves	1,000	42
Sink, draining board, taps	1,500	62
	4,350	181

Cooking Facilities

	RS	\$ US
2 gas cylinders, 3 ring burner, 2 ring burner	3,550	148

Equipment

	RS	\$ US
Refractometer	2400	100
Juice extractor	1200	50
Thermometer (x 2)	240	10
Analytical balance	700	30
Steam generator	200	08
Stainless steel saucepan	200	08
10 kg weighing scales	500	21
5 kg kitchen scales	450	19
Measuring cylinder	300	12
Omnia Capper	200	08
Stainless steel cutting knives (x3)	240	10
Wooden spoons for stirring		
Cutting boards (x 2)	60	03
Plastic funnels (x 2)	100	04
	6790	283

Some other basic items which would be useful in a food processing unit are:

plastic bowls, strainer, basins, buckets, plates, spoons, jugs, vegetable scrapers, ladle, knife sharpener, tongs — cost = Rs. 1,000/- . \$42.

Equipment for cleaning such as: scrubbing brush, cotton swabs, mop, scourers, brooms, brushes, scraper, hose pipe, rubber gloves, towels, cloths — comes to about Rs. 400/- \$17.

Total capital cost

	RS	\$ US
Building	100,000	4,167
Furniture & fittings	4,350	181
Equipment	11,740	489
	116,090	4,837
Working capital (2 wks material)	30,000	
	146,090	6,087

SECTION 7

Obviously the total investment for this type of project is well beyond the means of many villages or individuals and often credit is not available. On a home production level some of this equipment can be replaced with either locally available or less expensive items. For example, a fire, simple measuring equipment, an enamelled or clay pan and a thermometer would replace gas cylinders and rings, an analytical balance, a stainless steel saucepan and a re-

fractometer respectively. Assuming that the building (preferably insect proof), a table and a clean water supply are already there, and therefore do not present any additional cost, then the total capital investment for home production would be approximately Rs 1200 or \$50. In addition many of the jugs, spoons and bowls could be replaced with calabashes. These prices can all vary quite significantly between countries.

APPENDIX

Building Requirements

Ideally a specially constructed building should be used although many small industries are started at the home kitchen level. Certain basic requirements, however, should be considered.

- a. The premises should be kept as clean and hygienic as possible.
- b. All surfaces should be kept clean and completely washed down after each day's production.
- c. Windows should be open for ventilation but covered with fly proof mesh.
- d. Potable water and if possible electricity should be available.
- e. Animals and smoking should not be allowed in the plant.
- f. The floor of the working area should if possible be constructed of concrete sloped to a drain so that it can be thoroughly washed down.

In many countries Public Health legislation on the production of foods exists. In such cases the relevant authority should be consulted.

FURTHER READING

On Fruit Processing

Adams, M.R. (1980)

Small-scale Production of Vinegar from Bananas

ODNRI Post Harvest Technology Publication,
G 132, 56/62 Grays Inn Road, London, U.K.

Adams, M.R. (1982)

Kick-start for Village Vinegar in Papua New Guinea

AT Journal, Vol. 9, No. 2.

AGROMISA (1984)

Preservation of Foods

Agrodok 3, Agromisa, P.O.Box 41, 6700 AA Wageningen, Netherlands.

Anon (1985)

Tech & Tools at Nairobi in July 1985

AT Journal 1985, Vol. 12, No. 1, p. 20.

Axtell, B. (1983)

The Orange Hill Estate: A Successful Small Industry in Saint Vincent

AT Journal, Vol. 10, No. 2.

Bidault, B. & Gattegno, I (1984)

Le Point sur la Transformation des Fruits Tropicaux

Les dossiers "Le point sur" No. 2. GRET, 203 Rue Lafayette, Paris 75010, France.

Bielig, H.J.(1973)

Fruit Juice Processing

FAO Agricultural Services Bulletin 13

FAO, Rome, Italy.

Binstead, R., Devey, J.D. & Dakin, J.C. (1971)

Pickle and Sauce Making

Food Trade Press Ltd., London, U.K.

Fernandez, R., Cooke, R.D., Quiros, R., Madrigal, L., Samuels, A., Aguilar, F., & Orfiz, A. (1980).

Fruit and Vegetable Processing and Appropriate Technology in Costa Rica: a case study
Tropical Science, Vol. 22, No. 2.

Foss George, P.

Exotic Fruits, a post harvest bibliography.

Postharvest Institute for Perishables, 314 University of Idaho, Moscow, Idaho 83843, U.S.A.

Mabey, D. & R. (1985)

Jams, Pickles and Chutneys

Penguin Publ. Harmondsworth, U.K.

FURTHER READING

Meyer, M.R., & Paltrinieri, G. (1981)

Elaboracion de Frutas y Hortalizas

Editorial Trillas, Av.Rio Churubusco 385, Col. Pedro Maria Anaya, Deleg. Benito Juarez, 03340 Mexico D.F.

Ministry of Agriculture Fisheries and Food (1969)

Home Preservation of Fruit and Vegetables Bulletin 21,

Her Majesty's Stationery Office 49 High Holborn, London, W.C.1., U.K.

Nelson, P.E., & Tressler, D.T.

Fruit and Vegetable Juice Processing

Technology A.V.I. Conn. U.S.A.

Rauch, G.H. (1965)

Jam Manufacture

Leonard Hills Books, London, U.K.

On Wines and Vinegars

Remi, B. (1979)

Home Brew

Sahayogi Prakashan, Nepal.

Turner, B.C.A. (1970)

Home Wine Making and Brewing

Boots Company Ltd., London, U.K.

Woollen, A. (1969)

Food Industries Manual

Leonard Hills Books, London, U.K.

On Drying of Fruits

Anon (1965)

How to Make a Solar Cabinet Drier for Agricultural Produce

Do-it-yourself Leaflet 16. Brace Research Institute, St Anne de Belleue, PQ, Canada HDA 1CO.

Anon (1978)

Proceedings of the Solar Drier Workshop

Manila, Philippines.

FURTHER READING

Anon (1980)

Chilli Drying, Vegetable Seeds Drying

Annual Report, Central Institute for Agricultural Engineering, Bhopal, India.

Axtell, B (1985)

Fruit Leathers

(Unpublished ITDG paper, Myson House, Railway Terrace, Rugby, U.K.).

Bhatia, A.K., & Gupta, S.L. (1976)

Solar Drier for Drying Apricots

Research and Industry, No. 21, 188-191.

Brenndorfer, B., Kennedy, Oswin Bateman, C.O & Trim, D.S., Mrema, G.C. Wereko-Brobby, C (1985)

Solar Driers, Their Role in Post-Harvest Processing

Commonwealth Secretariat Publication, Marlborough House, Pall Mall, London SW1Y 5HX, U.K.

Cheema, L.S., & Riberio, C.M.C. (1970)

Solar Driers of Cashew, Banana and Pineapple

Proceedings of Conference "The Sun: Mankind's Future Source of Energy", pp. 2075-2079, New Delhi, India.

Clark, C.S. (1981)

Solar Food Drying: A Rural Industry

Renewable Energy Review Journal, Vol. 3, No. 1, pp. 23-26.

Clark, C.S. and Saha, H. (1982)

Solar Drying of Paddy

Renewable Energy Review Journal Vol. 4, No. 2, pp. 60-65.

Dirks, D. (1984)

What is Solar Drying

Generator: Vol. 1, No. 2, pp. 9-10.

Harigopal, V. & Tonapi, K.V. (1980)

Technology for Villages - Solar Drier

Indian Food Packer, Vol. 34, No. 2, pp. 48-49.

Howarths, S. (1978)

Solar Drier

Technical Paper 34, Paktribas Agricultural Centre, Dhankuta, Nepal, 3 pp.

ILO

Solar Drying: Practical Methods of Food Preservation

ILO Publication CH-1211, Geneva 22, Switzerland.

FURTHER READING

Khan, E.U. (1974)

The Utilization of Solar Energy

Solar Energy, Vol. 8, No. 1, pp. 17-22.

Lawand, J.A. (1966)

A Solar Cabinet Drier

Solar Energy, Vol. 10, No. 4, pp. 158-164

Martens, R. (1981)

A Solar Drier Applied to a Village Food Processing Industry

ADAB NEWS.

Martosudiriso, S., & Kurisman and Taragon, I. (1979).

Improvement of Solar Drying Technique in Post-Harvest Technology – A Study of Onion Drying in Indonesia

Proceedings in Inter-Regional Symposium on Solar Energy for Development, Paper B-10
Tokyo, Japan.

MCC (1985)

Yearly Report on Employment Raising Programme.

McDowell, I. (1973)

Solar Drying of Crops and Foods in Humid Tropical Climates

Report CFNI-T-7-73 Caribbean Food and Nutrition Institute, Kingston, Jamaica, 42 pp.

New Mexico Solar Energy Association (1978)

How to Build a Solar Crop Drier.

Santa Fe, USA, 10 pp.

Pablo, I.G. (1978)

The Practicality of Solar Drying of Tropical Generation in Rural Areas

Proceedings of UNESCO Solar Drying Workshop, Manila, Philippines, Manila Bureau of Energy Development.

Richards, A.H. (1976)

A Polythene Tent Fish Dryer for Use in Papua New Guinea's Sepik River Salt Fish Industry

Proceedings of Seminar "Sun Drying Methods" Colombo, Sri Lanka. Colombo: National Science Council.

SKAT

Desecador Solar Simple

Swiss Centre for Appropriate Technology, Varnbuelstrasse 14, St Gallen, CH 9000, Switzerland.

Trim, D.S. (1982)

Solar Crop Dryers

TPI/ODA

56/62 Grays Inn Road, London, U.K.

FURTHER READING

Umarov, G.G., & Itramov, A.I. (1978)

Features of the Drying of Fruit and Grapes in Solar Radiation Drying Apparatus
Gelio Tekhnika, Vol. 14, No. 6, pp. 55-57

UNICEF

Village Technology in Eastern Africa.

US Peace Corps

Solar and Energy Conserving Food Technologies: A Training Manual
Information Collection & Exchange, Office of Training and Program Support, 806 Connecticut Avenue, Washington, DC 20526, USA.

Van Arsdel, W.B., Copley, M.J., & Morgan, A. (1973)

Food Dehydration, Vol. I and II, Westport, USA: Ari Publishing Co. Inc., pp. 347 and 529.

On Vegetable Processing

ILO (Forthcoming)

Vegetables

Technology Series, Technical Memorandum No.7 World Employment Programme, ILO, P.O.Box 500, CH-1211, Geneva 22, Switzerland.

US Department of Agriculture

Preservation of Vegetables by Salting or Brining
Farmers Bulletin, No. 1932.

On Food Processing

AGROMISA

Preservation of Foods

Agrodok 3, Agromisa, P.O.Box 41, 6700 AA Wageningen, Netherlands.

FAO

Rural Home Economic

Food Preparation, series 1

Food Preservation, series 2

Labour-Saving Ideas, series 3, FAO, Via delle Terme di Caracalla, 00100 Rome, Italy.

Hertzberg, R. *et al*

Putting Food By

Stephen Green Press, Lexington, Mass., USA.

Ihekoronye, A.I., and Ngoddy, P.O. (1985)

Integrated Food Science and Technology for the Tropics
Macmillan Publishers, London, U.K.

FURTHER READING

Iwuji, D.C.

The Use of Food and Nutrition Teachers' Guide

Report of instructors' training workshop. Women's programme, Federal Ministry of Education, Science and Technology, Bourdillon, Ikoyi, Lagos, Nigeria.

On Management of Small Scale Projects

International Women's Tribune Centre (1984)

Women and Small Business

International Women's Tribune Centre, 777 UN Plaza, New York, NY 10017, U.S.A.

Jackelen, H.R. (1983)

Management for Commercial Analysis of Small Scale Projects

A.T. International, 1724 Massachusetts Avenue N.W., Washington, DC 20036, U.S.A.

The MATCOM Project

Curriculum Guide for Agricultural Co-operative Management Training

c/o CO-OP Branch, International Labour Office, CH 1211 Geneva 22, Switzerland.

On Women and Food Cycle Technologies (general)

Carr, M. (1982)

Has Anything Changed for Women

AT Journal, 1982.

Carr, M. (1984)

Blacksmith, Baker, Roofing-sheet Maker...

IT Publications, London, U.K.

Kocken, E.M. (1986)

A Women's Jam-making Project in Central America.

Unpublished report. UNIFEM/WAFT.

Stephens, A. (1986)

Yes, Technology is Gender Neutral, but... Women in Asia might not agree.

CERES, 108, FAO, Rome, Italy.

Tinker, I. (1984)

New Technologies for Food Chain Activities The Imperative of Equity for Women.

US/AID, Office of Women in Development, Washington D.C., U.S.A.

FURTHER READING

On Appropriate Technology

ITDG/GTZ (1985)

Tools for Agriculture

Intermediate Technology, GTZ/GATE, Intermediate Technology Publications, 9 King Street, London WC2E 8HW, U.K. (A buyer's guide to appropriate equipment.)

Canadian Hunger Foundation (1976)

A Handbook on Appropriate Technology

Canadian Hunger Foundation, 75 Sparks Street, Ottawa, Ontario K1P 5A5, Canada.

Carr, M. (1985)

The AT Reader. Theory and Practice in Appropriate Technology

Intermediate Technology Publications, London, U.K.

Darrow, K., & Pam R. (1981)

Appropriate Technology Source Book

Vol. 1, No. 2.

Volunteers in Asia, P.O.Box 4543, Stanford, California 94305, U.S.A.

Hale, P.R., & B.D., Williams.

LIKLIK BUK. A Rural Development Handbook Catalogue for Papua New Guinea

Liklik Buk Information Centre P.O. Box 1920, Lae, Papua New Guinea.

ILO-SDSR

Makala Ya Mafunzo.

(Catalogue of Items of Appropriate Technology): Skill Development for Self Reliance.

ILO/SDSR, P.O. Box 60598, Nairobi, Kenya.

VITA (1970)

Village Technology Handbook

VITA, College Campus, Schenectady, New York 12308, U.S.A.

CONTACTS

The following can be contacted for further information on fruit and vegetable processing. Some of these institutions have developed their own equipment which has been or is being used in the field.

AFRICA

BTC

Botswana Technology Centre, P.O. Bag 0082, Gaborone, Botswana.

IRT

Institute de Recherche Technologique, Technology Research Institute, BP 14070 Libreville-Akebe, Gabon.

TCC

Technology Consultancy Centre, (Department of Mechanical Engineering), University of Science and Technology, Kumasi, Ghana.

Food Processing Research Centre, Khartoum, Sudan.

UNICEF

Eastern Africa Regional Office, P.O. Box 44145, Nairobi, Kenya

UNICEF

Regional Office for Central and West Africa, B.P.443, Abidjan 04, Ivory Coast

ASIA

AFPRO

Action for Food Production, C52, ND South Extension II, New Delhi -- 16, India

BRAC

Bangladesh Rural Advancement Committee, 66 Mohakhali Commercial Area, Dhaka -- 12, Bangladesh

CFTRI

Central Food Technological Research Institute, Mysore 570-013, India

Bandung Institute of Technology, Development Technology Centre, P.O. Box 276, Bandung, Indonesia

EUROPE

GATE/GTZ

German Appropriate Technology Exchange, Postfach 5180, D-6236 Eschborn 1, West Germany

GRET

Groupe de Recherche et d'Exchanges Technologiques, 203 Rue Lafayette, Paris 75010, France

ITDG

Intermediate Technology Development Group, Myson House, Railway Terrace, Rugby CV21 3HT, UK

CONTACTS

SKAT

Swiss Centre for Appropriate Technology, Varnbuelstrasse 14, St Gallen CH 9000, Switzerland

TDRI

Overseas Development Natural Resources Institute.
Tropical Development and Research Institute, 56-62 Gray's Inn Road, London WC1X 8LU, UK

CENTRAL AMERICA

CEMAT

Centro Mesoamericano de Estudios Sobre Tecnologia Apropriada, Apartado Postal 1160, 18 Calle 22-52 Zona 10, Ciudad de Guatemala, Guatemala

CITA

Centro de Investigaciones en Tecnologias de Alimentos, Universidad de Costa Rica, San Jose, Costa Rica

INCAP

Institute de Nutricion de Centro America, Apartado Postal 1188, Carretera Roosevelt Zona 11, Ciudad de Guatemala, Guatemala

SOUTH PACIFIC

ATDI

Appropriate Technology Development Institute, The Papua New Guinea University of Technology, PO Box 793, Lae, Papua New Guinea

AMERICA

Brace Research Institute, McGill University, Montreal 2 PQ, Canada

IDRC

International Development Research Centre
Box 8500, Ottawa, Canada K1G 3H9

Post Harvest Institute for Perishables Information Centre, 314 University of Idaho Library, Moscow, Idaho 83843, USA

UNICEF

886 United Nations, New York, N.Y. 10017, USA

VITA

Volunteers in Technical Assistance, 1815 North Lynn Street, Suite 200 Arlington, Virginia 22209, USA

For further information, write to:

United Nations Development Fund for Women (UNIFEM)
304 East 45th Street, 11th Floor
United Nations
New York
N.Y. 10017,
U.S.A.

Attention: Food Technologies