

AT MICROFICHE
REFERENCE
LIBRARY

A project of Volunteers in Asia

Small Scale Manufacture of Footwear

Published by:

International Labour Office (ILO)
CH-1211 Geneva 22
SWITZERLAND

Copyright 1982

Available from:

Publications Branch, ILO, same address

Reproduced by permission.

Reproduction of this microfiche document in any form is subject to the same restrictions as those of the original document.

Small-scale manufacture of footwear



Small-scale manufacture of footwear

Prepared under the joint auspices of the International Labour Office
and the United Nations Industrial Development Organisation

Copyright © International Labour Organisation 1982

Publications of the International Labour Office enjoy copyright under Protocol 2 of the Universal Copyright Convention. Nevertheless, short excerpts from them may be reproduced without authorisation, on condition that the source is indicated. For rights of reproduction or translation, application should be made to the Publications Branch (Rights and Permissions), International Labour Office, CH-1211 Geneva 22, Switzerland. The International Labour Office welcomes such applications.

ISBN 92-2-103079-2
ISSN 0252-2004

First published 1982

The designations employed in ILO publications, which are in conformity with United Nations practice, and the presentation of material therein do not imply the expression of any opinion whatsoever on the part of the International Labour Office concerning the legal status of any country or territory or of its authorities, or concerning the delimitation of its frontiers.

The responsibility for opinions expressed in signed articles, studies and other contributions rests solely with their authors, and publication does not constitute an endorsement by the International Labour Office of the opinions expressed in them.

Reference to names of firms and commercial products and processes does not imply their endorsement by the International Labour Office, and any failure to mention a particular firm, commercial product or process in connection with the technologies described in this volume is not a sign of disapproval.

ILO publications can be obtained through major booksellers or ILO local offices in many countries, or direct from ILO Publications, International Labour Office, CH-1211 Geneva 22, Switzerland. A catalogue or list of new publications will be sent free of charge from the above address.

CONTENTS

	<u>Page</u>
Acknowledgements.....	ix
Preface.....	xi
<hr/>	
CHAPTER I. INTRODUCTION.....	1
I. Objectives of the memorandum.....	1
II. The footwear industry.....	3
III. Types of footwear.....	4
IV. Operation reference numbering system and tables of technical data.....	5
V. Scales of production.....	9
VI. Use of the technological information....	9
CHAPTER II. MANUFACTURING TECHNOLOGIES FOR TYPE 1 FOOTWEAR.....	13
I. Operation sequence.....	13
II. Detailed description of processing stages.....	15
II.1 Cutting uppers.....	15
II.2 Upper preparation.....	22
II.3 Upper stitching.....	31
II.4 Stitched upper finishing.....	38
II.5 Bottom component preparation.....	42
II.6 Making.....	45
II.7 Shoe finishing and packing.....	55

III. Tables of technical data..... 58

 III.1 Material handling resources, work
 force and production floor area..... 58

 III.2 Workforce allocation 58

 III.3 Equipment specification..... 58

IV. Floor plans for production areas..... 59

CHAPTER III. MANUFACTURING TECHNOLOGIES
 FOR FOOTWEAR TYPES 2 TO 6..... 73

I. Type 2 footwear: Leather-upper, cement-
 lasted shoes with directly moulded-on
 soles..... 73

 I. 1 Scrim attaching..... 74

 I.2 Heel core attaching..... 74

 I.3 Bottom solutioning..... 74

 I.4 Direct sole moulding-on..... 74

 I.5 Subsequent operations..... 79

 I.6 Tables of technical data for
 type 2 footwear..... 79

II. Type 3 footwear: Leather-upper, tack-
 lasted shoes with machine-sewn leather
 soles..... 83

 II.1 Insole preparation..... 83

 II.2 Sole preparation..... 85

 II.3 Insole tacking..... 87

 II.4 Tack lasting..... 88

 II.5 Bottom pounding..... 90

 II.6 Bottom cementing..... 90

 II.7 Sole laying..... 90

II.9	Sole stitching.....	91
II.10	Sole levelling.....	92
II.11	Seat nailing.....	92
II.12	Heel attaching.....	93
II.13	Re-lasting.....	93
II.14	Heel trimming.....	93
II.15	Edge trimming.....	93
II.16	Bottom finishing.....	94
II.17	Tables of technical data.....	97
III.	Type 4 footwear: Welded synthetic upper, string-lasting shoes with moulded-on soles..	104
III.1	Cutting and welding upper components.....	105
III.2	Welding upper components together....	105
III.3	Lasting string attaching.....	106
III.4	String lasting and moulding-on of soles.....	106
III.5	Sock insertion.....	107
III.6	Tables of technical data.....	107
IV.	Type 5 footwear: Stitched synthetic upper, cement-lasting sandals and casual shoes with built-on unit soles.....	110
IV.1	Sole and insole preparation.....	110
IV.2	Heel preparation.....	112
IV.3	Lasting uppers.....	112
IV.4	Heel attaching.....	112
IV.5	Sole finishing.....	112
IV.6	Tables of technical data.....	113

V.	Type 6 footwear: Single-injection moulded plastic sandals.....	117
V.1	Single-injection moulding technique and equipment.....	117
V.2	Tables of technical data.....	118
CHAPTER IV. FRAMEWORK FOR PROJECT EVALUATION....		121
I.	Factors influencing the choice of technology.....	121
II.	Evaluation methodology.....	124
II.1	Evaluation of cost items.....	124
II.2	Estimation of total annual costs and of gross profits.....	127
II.3	Sources of technical and economic data	127
II.4	Hypothetical examples of the application of the evaluation methodology.....	130
III.	Evaluation of technologies adopted by established footwear factories in developing countries.....	134
III.1	Alternative technologies for type 1 footwear: A Ghanaian case study.....	134
III.2	Comparison of alternative types of footwear at fixed levels of scale: Ethiopian case study.....	143
III.3	Effects of scale on manufacturing technology for type 1 footwear: Ghanaian and Ethiopian case studies...	145
IV.	Concluding remarks on the choice of technology and specialisation.....	151
IV.1	Need for preliminary marketing investigations.....	151
IV.2	Specialisation and organisation of production.....	153

CHAPTER V. FRAMEWORK FOR NATIONAL DECISIONS.....	155
I. Comparison of alternative footwear products.....	156
I.1 Capital and labour requirements for different technologies and types of footwear	156
I.2 Product choice, resource allocation and the satisfaction of basic needs.	158
II. Economic and social appraisal of alternative technologies and products...	159
II.1 Social versus private sector benefit-cost analysis.....	159
II.2 Appraisal of alternative technologies for type 1 footwear.....	163
II.3 Data requirements and sensitivity analysis.....	167
III. Towards a national footwear manufacturing strategy.....	168
III.1 Factors influencing a national footwear strategy.....	168
III.2 Comparative advantage, social considerations and product choice.	171
III.3 Backward linkages and availability of raw materials.....	173
III.4 Employment, technological choice and skill requirements.....	174
III.5 Other factors.....	175

APPENDICES

Appendix I	- Glossary of technical terms	181
Appendix II	- List of equipment suppliers	189
Appendix III	- Selected bibliography	199
Appendix IV	- Selected list of technical institutions	201
Appendix V	- Present worth of an annuity factor	204

Questionnaire

ACKNOWLEDGEMENTS

The publication of this memoranda has been made possible by a grant from the Swedish International Development Authority (SIDA). The International Labour Office and the United Industrial Development Organisation acknowledge this generous support.

PREFACE

In their efforts to industrialise, developing countries have often relied on technologies developed in industrialised countries. These technologies are generally imported in the form of 'turn-key' factories, and few adjustments - if any - are made in order to adapt them to local socio-economic conditions. An alternative approach consists in importing equipment specified in plant designs prepared by local or foreign engineering firms. Whatever the approach, the choice of technology is generally restricted to those technologies developed and marketed in industrialised countries. Only a few countries have established local engineering firms capable of developing plant designs suitable to local socio-economic conditions and of producing appropriate capital goods.

Reliance on technologies imported from industrialised countries would not necessarily be harmful if these technologies were suitable for prevailing local socio-economic conditions. This is, unfortunately, not always the case. A large number of studies show that these technologies are seldom appropriate for countries suffering from high unemployment and underemployment, lack of foreign exchange, capital, and a strong industrial structure (e.g. capital goods industries, adequate physical infrastructure), and an insufficiently large pool of highly skilled labour. In general, they tend to make a heavy use of scarce resources while abundant ones, such as labour, are little utilised.

What may explain such reliance on imported technologies? Although a large number of reasons can be advanced to explain this phenomenon, the following three reasons are probably the most important ones:

Firstly, local technologies used by small-scale enterprises, artisans, and cottage industries have often proved to be less competitive than imported technologies, both in terms of production costs and the quality of output. These production units have not also been able to adapt their production to changing tastes, or to increase the supply of consumer goods and capital goods at a rate commensurate with that of demand for these goods. Secondly, foreign investors (e.g. as in the case of joint ventures) tend to adopt technologies used in their home countries and their local partners (private entrepreneurs or public enterprises) are generally not in a position to propose and/or impose alternative technologies. Thirdly, in the case of export industries, the type and quality of goods in demand in industrialised countries often require the use of technologies developed in these countries.

While the above reasons may explain the current reliance on imported technologies, one should not conclude that developing countries have no other choice than to adopt these technologies. A number of these countries have developed and successfully applied technologies which are both more cost-effective than technologies developed in industrialised countries and more suitable to socio-economic conditions prevailing in developing countries. These locally developed technologies make a larger use of available labour than do imported technologies, require few imports, generate important multiplier effects on the economy (e.g. through the local production of equipment used by these technologies) and do not rely extensively on foreign skills and know-how. They have been developed for a large number of products and processes, especially those of particular interest for developing countries.

Unfortunately, information on these technologies is not generally available in a useful form, if available at all. They are mostly known in the countries where they have been developed and applied, and are rarely transferred to other developing countries. This may be explained by various reasons. Firstly, those who develop these technologies were either not interested in disseminating them, or did not have the necessary means for the publication and dissemination of the technological information. Secondly, most of these technologies are neither patented nor marketed internationally by engineering firms or equipment suppliers. Finally, they are not generally advertised

in trade journals published in industrialised countries. Developing countries are therefore not aware of their existence, or cannot obtain detailed technical information which would enable them to apply these technologies.

Consequently, the International Labour Office and the United Nations Industrial Development Organisation have joined efforts in order to improve the dissemination of information on appropriate technologies among developing countries. One outcome of this joint collaboration was the decision to publish a series of technical memoranda on specific industrial products and processes, and to disseminate these as widely as possible among potential and established private and public enterprises.

The technical memoranda are mostly intended for potential producers who have some difficulties in choosing and applying technologies best suited to their own circumstances. However, they should also be of interest to public planners, project evaluators from industrial development agencies, training institutions and national and international financial institutions. In short, the memoranda should be useful to all those who are in a position to influence the choice of public or private investment and therefore the choice of technologies associated with these investments.

The technological information contained in the memoranda is fairly detailed as it would be difficult for the reader to obtain missing information. Thus, clear and detailed descriptions of processes as well as drawings of equipment which may be manufactured locally are provided, and lists of equipment suppliers - from both developing and developed countries-- are included whenever the local manufacture of equipment may not be easily undertaken. A methodological framework for the evaluation of alternative technologies is provided in order to enable the reader to identify the least-cost or most profitable technology. Some information on the socio-economic impact of alternative technologies is also included for the benefit of public planners and project evaluators.

While an attempt has been made to provide fairly detailed technical information, there would undoubtedly be cases where some information will still be missing.

The reader may contact technology institutions or research centres listed in a separate appendix or other additional books or journals included in the bibliography. The ILO and UNIDO may also be contacted and every effort will be made to provide the missing information.

Technical memoranda are not intended as training manuals. It is assumed that the potential users of the technologies described in the memoranda are trained practitioners and that the memoranda are only supposed to provide them with information on alternative technological choices. Memoranda may, however, be used as complementary training material by training institutions.

This technical memorandum on small-scale footwear manufacturing is the second of a series being currently prepared by the ILO and UNIDO. It follows the publication of a technical memorandum on a closely related subject: the tanning of hides and skins.¹ Some of the information contained in this latter memorandum is complementary to that contained in this one, and may be found useful by footwear manufacturers and public planners.

This technical memorandum provides technical and economic details on alternative footwear manufacture technologies used in scales of production ranging from 8 pairs per day to 1,000 pairs per day (i.e. the range of scales of production varies from the artisanal type production to medium-scale production). Substantially larger scales of production are not covered by this memorandum for the following reasons. Firstly, potential footwear manufacturers who may wish to invest in large-scale, capital-intensive plants costing many million dollars would most probably use the services of a specialised engineering firm in view of the large investment involved. Secondly, information on technologies used in these plants is readily available from engineering firms or equipment suppliers from industrialised countries. Finally, experience shows that in machine-intensive footwear plants producing conventionally constructed shoes, spare machine capacity is

¹International Labour Office and United Nations Development Organisation, Tanning of Hides and Skins, (Geneva, ILO, 1981).

likely to be at a minimum at outputs approximately equal to 1,000 pairs per 8-hour shift. In fact, equipment is often designed to reach output capacity at this scale, and plants producing substantially more than 1,000 pairs per 8-hour shift tend to group their equipment in such a way as to form separate units producing at the above output level. Thus, footwear manufacturers interested in producing a few thousands of pairs per day may still benefit from the information contained in this memorandum.

The effective dissemination of technical memoranda would require the active participation of various government agencies, trade associations, workers' and employers' organisations, training institutions, etc. Seminars may be organised for the benefit of established or potential footwear manufacturers in order to review the proposed technologies, identify those which are particularly suited to prevailing local conditions and identify the type of assistance needed by manufacturers who wish to adopt one of the technologies described in the memorandum.

This memorandum may be directly used by functionally literate footwear manufacturers who are familiar with accounting methods, and are capable therefore of evaluating the proposed technologies on the basis of local factor prices. However, some shoemakers may not be functionally literate, especially artisans who may be interested in the very small scale of production (8 pairs per day). In this case, information on alternative techniques may be disseminated among these artisans by extension officers or training institutions.

Names of equipment suppliers are provided in Appendix II of the memorandum. This does not, however, imply a special endorsement of these suppliers by the ILO. These names are only provided for illustrative purposes, and footwear manufacturers should try to obtain information from as many suppliers as feasible.

A questionnaire is attached at the end of the memorandum for those readers who may wish to send to the ILO or UNIDO their comments and observations on the content and usefulness of this publication. These will be taken into consideration in the future preparation of additional technical memoranda.

This memorandum was prepared by N.S. McBain and A. Kuyvenhoven (consultants) in collaboration with M. Allal, staff member of the Technology and Employment Branch of the ILO.

A. S. Bhalla,
Chief,
Technology and Employment Branch.

CHAPTER I

INTRODUCTION

I. Objectives of the memorandum

The footwear industry constitutes an important sector of the economy of developing countries for the following reasons. Firstly, footwear may be considered as a basic needs item, following closely, in importance, other items such as food, shelter and clothing. Secondly, the manufacture of footwear uses relatively labour-intensive processes, and thus contributes substantially to employment generation. Thirdly, this sector can, in some cases, generate important backward linkages whenever leather is locally produced. Forward linkages are also generated in the marketing of footwear. Finally, developing countries enjoy a comparative advantage in the manufacture and export of footwear to industrialised countries: thus, this sector could be the source of much needed foreign exchange.

Given the importance of the footwear industry for developing countries, it is essential that socio-economic benefits derived from its expansion be maximised. In other words, the choice of footwear type and quality and that of technology and scale of production should be such as to contribute to the overall development strategy of a country. However, recent developments in the footwear industry of developing countries tend to indicate that many of the choices which are made - in terms of technology, scale of production and

footwear type and quality - are not always in line with the adopted development objectives. Many developing countries have allowed the establishment of large-scale, capital-intensive footwear plants, often owned and operated by foreign investors. These plants have, in some cases, been responsible for the closing down of local small-scale factories although the latter produced good quality footwear at moderate prices.¹ Furthermore, few countries offer effective assistance to small-scale footwear producers with a view to improving their competitiveness and profitability. Thus, developing countries have often allowed the establishment of what may be called a "technological dualism" in the footwear industry whereby large-scale, capital-intensive footwear plants compete against ill-equipped artisans and small-scale producers.

The above considerations should not lead one to conclude that large-scale modern footwear plants should not be established under any circumstances. These plants may, in many cases, be justified (e.g. for the production of inexpensive plastic sandals or the production of footwear for the export market). It is only suggested that public planners and project evaluators should carefully consider future large investments in this sector with a view to determining whether they are justified or whether small-scale production should be promoted instead.

In order to be able to better plan the expansion of the footwear industry, public planners and project evaluators need detailed technical and economic information on alternative footwear projects (e.g. scales of production, alternative manufacturing technologies, foreign exchange savings, employment effects). This information is also of great importance to potential shoe manufacturers who wish to invest limited funds in profitable projects. Unfortunately, the existing information is more relevant to industrialised countries' conditions than to those prevailing in developing countries. Thus, the technologies, footwear types and quality, and scales of production analysed or advertised in trade journals tend to reflect the market conditions of industrialised countries as well as their economic structures (e.g. relatively low unemployment rates when

¹This may be explained by the prestige associated with footwear produced under internationally known brands.

compared to those prevailing in developing countries (e.g. relatively abundant capital and foreign exchange, highly skilled labour). Consequently, the purpose of this technical memorandum is to partially bridge the information gap by providing information on technologies suitable for developing countries' conditions and circumstances, and by evaluating these technologies in the light of these countries' economic structure.

It is hoped that this memorandum will be of assistance to decision makers - entrepreneurs, public planners, project evaluators - concerned with footwear manufacture. It has been prepared in an awareness that it is often difficult in developing countries to obtain information on alternative footwear production methods. The primary concerns of the memorandum are to describe ranges of alternative ways of making footwear and to show how the most suitable combination of alternatives for a particular set of circumstances can be identified.

II. The footwear industry

In recent years, there has been a tendency for the footwear sector in the developing world to become increasingly successful in exporting to industrially developed countries. Domestic markets in developing countries for locally produced footwear have also grown, partly at the expense of developed country exports. These new trends have resulted in the establishment of relatively large-scale, capital-intensive plants. Local enterprises with less access to technical information have thus tended to adopt manufacturing methods similar to those in 'turn-key' factories, at the expense of technologies more suitable to local conditions, especially at low scales of production.

Scale of output is only one of the factors affecting technical choice in the industry. As shown in Chapters II and III, choice of footwear type, quality and durability is also a crucial factor. Low income consumers concerned with satisfying basic health needs or obtaining the foot protection necessary for many activities may, for example, be less concerned with the variety of styles available than with retail price. Generally, the narrower the product variety required from a manufacturing enterprise at a given level of output, the greater the level of mechanisation that can be economically justified.

Technical choice of manufacturing methods can also be affected by the level of specialisation in shoe parts. In addition to this scope for enterprises to supply a number of customers with components, a group of producers may share the use of common facilities for some manufacturing stages. Other considerations that can affect technical choices are the availability and cost of imported and locally produced manufacturing equipment and the cost of borrowing capital. Finally, the relationships between the levels of wages, manual skills and the working paces of operatives, and the degree of utilisation of capital equipment are extremely important considerations.

These factors are analysed in detail in chapters IV and V.

III. Types of footwear

Chapters II and III contain descriptions of alternative manufacturing methods and equipment that can be used for the production of the following types of footwear:

- Type 1 : Leather-Upper, Cement-Lasted Shoes with Cemented-on Soles,
- Type 2 : Leather-Upper, Cement-Lasted Shoes with Moulded-on Soles,
- Type 3 : Leather Upper, Tack-Lasted Shoes with Stitched-on Leather Soles,
- Type 4 : Welded-Synthetic Upper, String-Lasted Shoes with Moulded-on Soles,
- Type 5 : Stitched Synthetic-Upper, Cement-Lasted Sandals and Casuals with Cemented-on Built Unit Soles,
- Type 6 : One-Shot Injection Moulded Plastic Sandals.

Type 1, which is the subject of Chapter II, is, for our purposes, considered to be the standard method of construction. More space is devoted to Type 1 footwear than to the other five types because some of them can be made by processes used for Type 1. The chart of

production stages in Figure I.1 illustrates how constructional features of the six types of shoe and sandal can be combined in a variety of ways.

The six constructional methods considered in this memorandum are only a small proportion of the possible combinations of methods shown on the chart. For example, shoes having stitched leather uppers and cemented-on prefinished soles could be lasted using tacks, cement or string, but only the combination involving cement lasting is dealt with. However, all the techniques required to construct the tack and string-lasted alternatives are dealt with in the context of other types. In all, forty-six different construction methods are possible using the alternatives shown in Figure I.1. Although these forty-six methods cover far from all the possible forms of footwear construction, it is likely that they account for about ninety per cent of the total output volume of non-rubber footwear. Rubber footwear are outside the scope of this memorandum.

Simplified cross-sections of shoes made on the basis of the adopted six types of construction are shown in Figure I.2. Readers who are unfamiliar with footwear manufacture may find it useful to consult the glossary of terms at the end of this memorandum.

IV. Operation Reference Numbering System and Tables of Technical Data

The manufacturing sequence is listed at the start of the sections dealing with each of the footwear types covered in Chapters II and III. Each of the sub-process stages is given a unique operation reference number. Consequently, if a process is common to two or more footwear types, cross-references are made to avoid repeating the description of manufacturing techniques.

The operation reference numbering system is also used in the tabulations of technical data which follow the discussions of manufacturing methods that may be used at each stage. The tabulations cover a range of scales of output but do not include the details of each alternative technique mentioned in the text.

The combinations of techniques described in Chapters II and III have not been chosen on the basis of specific sets of productivity levels, wage rates or the cost of

Figure I.1

Combinations of construction methods

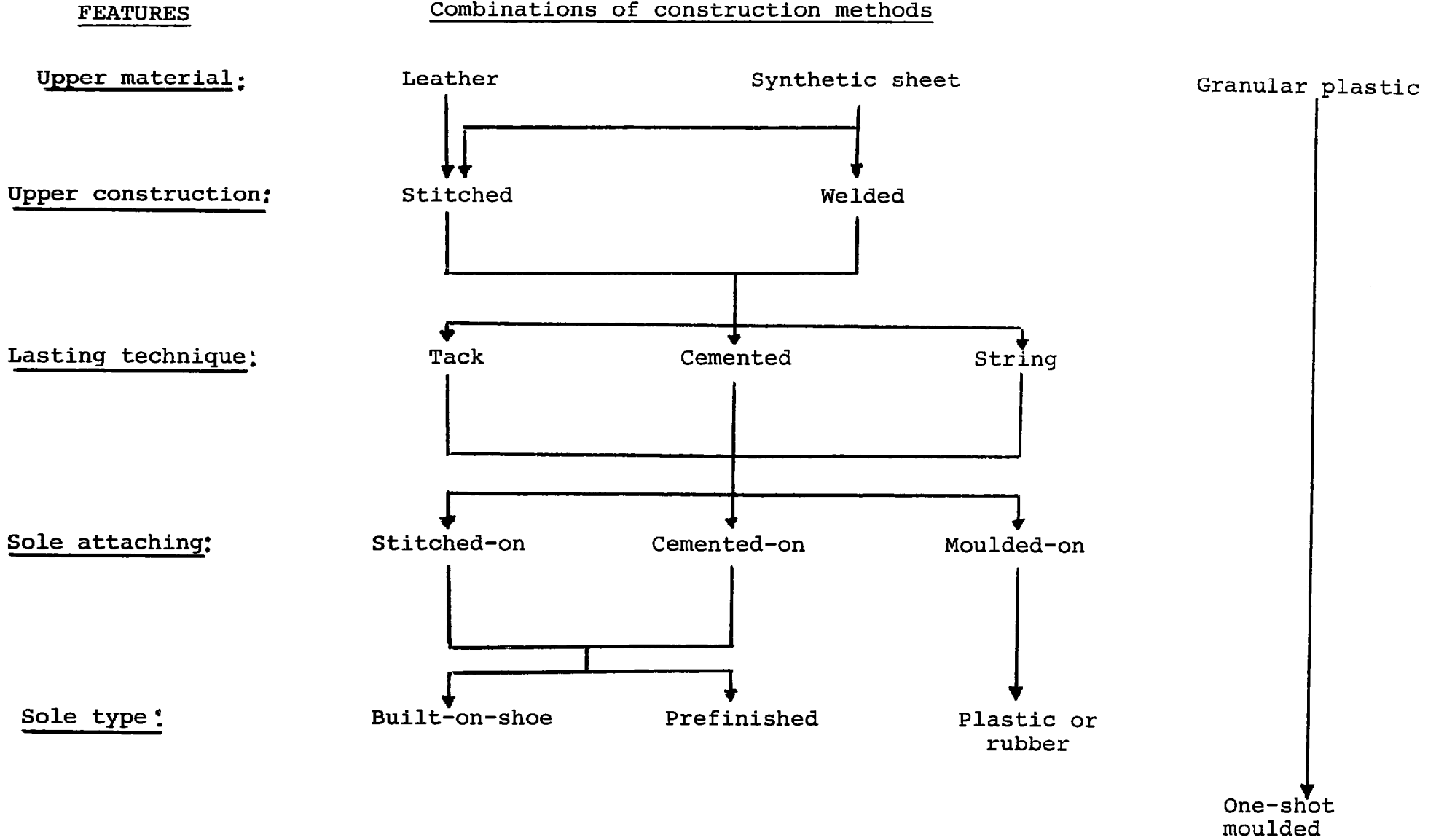
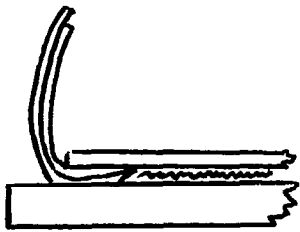
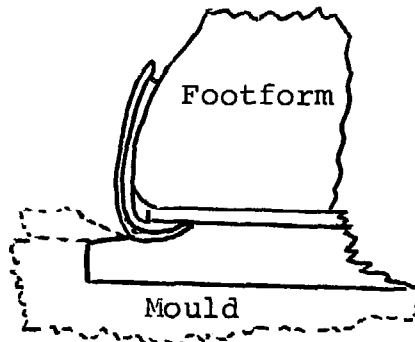

Figure 1.2

Simplified cross-sections of footwear types
1 to 6



Types 1 and 5. Cement-lasted cemented-on sole



Type 2. Cement-lasted, moulded on sole

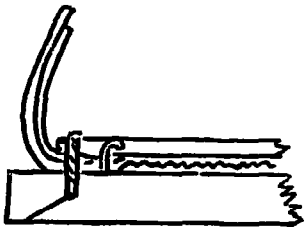

Type 3. Tack-lasted, machine-sewn sole

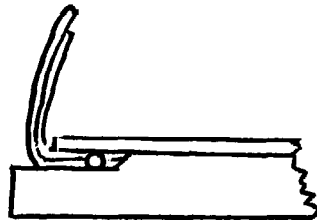

Type 4. String-lasted, moulded-on sole

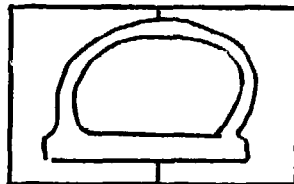

Type 6. One-shot moulded sandal (in mould)

various inputs. They have been selected on the basis of extensive analyses of footwear projects located in both developing¹ and developed countries. Alternative production techniques were evaluated for each manufacturing sub-process, taking into account the range of wage levels, interest rates, labour productivities, equipment capacity utilisations etc. most prevalent in the majority of developing countries. Thus, techniques which could never be justified under the above range of values are not considered in chapters II and III. The alternative to this approach would have been to describe all alternative combinations of techniques used in the production of the six types of footwear, and to let the reader evaluate each alternative on the basis of local factor prices. This latter approach is not however feasible since it would have been necessary to describe thousands of alternative projects.² Thus, the adopted approach consists in describing only those combinations of techniques which are relevant to developing countries' conditions. There may, however, be cases whereby particular circumstances could justify the adoption of combinations of techniques not covered in chapters II and III. The reader should therefore analyse additional combinations whenever he may feel that these could be more cost-effective than the alternative combinations described in the above chapters. The information needed to analyse other combinations of techniques is provided in the text of these chapters.

Equipment costs are quoted in U.S. Dollars at mid-1979 exchange rates. A list of equipment suppliers for each operation reference number is provided in Appendix II. The tabulations in Chapters II and III include descriptions of the production operation and of the selected equipment and method, the required quantity of each item and the source of the equipment (for example, locally made) and its approximate cost. It is assumed that an electricity supply is available for all scales of production. Equipment requiring compressed air systems is excluded at the small scales.

¹Some of the investigated footwear projects were located in Ghana, Ethiopia, Jamaica and El Salvador. Chapter IV provides detailed economic data for the Ethiopian and Ghanaian projects.

²The manufacture of a typical footwear requires as much as 31 operations. If two or three techniques may be used for each operation, the total number of combinations of techniques used in the production of footwear may be calculated at tens of thousands.

For Type 1 footwear, some additional data is provided at the end of Chapter II. The materials handling methods, associated workforce and estimated equipment costs that could be found appropriate in an enterprise manufacturing Type 1 footwear are detailed. The total production floor areas, including space for work in progress and aisles, together with block plans of factories suitable for producing 8 to 1,000 pairs of Type 1 footwear per day are provided. This information should also be relevant for the other types of footwear.

Summaries of the materials required for each type of construction are given in Table I.1. Since the amount of materials per unit of output is generally unaffected by the level of mechanisation of the manufacturing process or scale of production, this factor does not need to be taken into consideration when evaluating alternative production techniques used in the production of a given type of footwear.

V. Scales of production

The levels of output that are considered were selected to span a range from a very small scale to the largest manufacturing scale likely to be set up without considerable external assistance. Technical data is provided for four scales of production and for each of the six types of footwear. These scales of production expressed in terms of pairs produced per single shift day, are 8, 40, 200 and 1,000. They are referred to as Scales 1, 2, 3 and 4 respectively. These scales were selected because they are part of a geometric progression weighted towards the smaller volume end of the range.

An additional table shows for each footwear type the number of workers directly required for production at each manufacturing stage and for each scale of output.

VI. Use of the technological information

While it is not intended for Chapters II and III to act as an instruction manual in footwear manufacture, it is hoped that the discussion of alternatives will serve several purposes.

First, readers from enterprises at present specialising in a limited range of techniques and types of footwear construction may identify possibilities for innovations in their products on the basis of information

Table I.1

Specifications of materials used in the construction of footwear Types 1 to 6

Footwear type	Upper components			
	Uppers	Linings	Stiffeners	Puffs
1	Leather	Leather/synth.sheet	Leather/board	Solvent act.
2.	Leather	Leather/synth.sheet	Leather/board	Solvent act.
3	Leather	Leather/synth.sheet	Leather/board	Leather/ solvent act.
4	Synthetic	Synthetic sheet	Board/thermo- plastic	Solvent act./ thermoplastic
5	Synthetic	Synthetic sheet	None	None
6		One shot moulded		
	Bottom components			
	Insoles	Bottom filler	Shanks	Soles/Heels
1	Board	Felt	Steel/wood	Prefinished units
2	Board	Felt/heel core	Steel/wood	PVC moulded-on
3	Leather or board	Felt/scrap leather	Steel/wood	Leather, built on shoe
4	Board/synth. sheet	None	Steel	PVC moulded-on
5	Board	Felt	Steel/wood	Resin sheets, units, built
6		One shot moulded		

contained in this memorandum. Second, the attention of the reader is drawn to situations in which machinery is likely to reduce manufacturing times but not substitute for manual skills, or contribute to product quality conformance. Reducing operation times may not be a major objective in very small enterprises with spare manufacturing capacity. Equipment that only speeds up output may therefore be unnecessary.

The third aim is to alert potential users to the wide range of manufacturing equipment and tools that are available. The choice of equipment that is described includes: machines specially designed to perform particular operations in footwear manufacture, general purpose tools and equipment which are not designed specifically for the industry but are suitable for some of the operations, and equipment that is not generally available commercially but that small enterprises could find useful and which could be produced in industrially developing countries.

Fourth, for each sub-process stage the description of the manufacturing methods and the tabulated technical data are presented as separate elements. As explained earlier, many of the technical elements dealt with in connection with each type of footwear can be combined to construct a range of other footwear types. The elements described can also be used whenever an enterprise only engages in a single stage or a few manufacturing stages. Thus, for example, the techniques suitable for insole preparation in a large enterprise undertaking all the manufacturing stages could be identical to the techniques appropriate in a very small enterprise which only prepares insoles in large numbers. This matter is further elaborated in Chapter V.

CHAPTER II

MANUFACTURING TECHNOLOGY

FOR TYPE 1 FOOTWEAR

The objectives of this chapter are to describe methods of constructing walking shoes of conventional design and to examine the range of manufacturing techniques available at each processing stage. Such shoes have cement-lasted leather uppers and cemented on sole units that do not require finishing once assembled. This manufacturing technique is now widely used by shoe manufacturers.

These shoes are referred to throughout the text as Type 1. A reason for their popularity is that lasting tacks and the accompanying heavy insoles are unnecessary, which results in light and flexible footwear. Also, unit soles avoid the need for skilled and lengthy finishing operations often required when soles and heels are 'built' on the lasted shoe.

I. OPERATION SEQUENCE

Stages in the manufacture of a Type 1 man's shoe are shown in Figure II.1. In summary, manufacture first involves cutting out the upper components from skins and the linings and insoles from leather or fabric and man-made sheets. Next, the edges of the upper components are tapered, or skived, to reduce the bulk of seams. The eyelets are then inserted in lacing styles and the various upper components are stitched and cemented together.

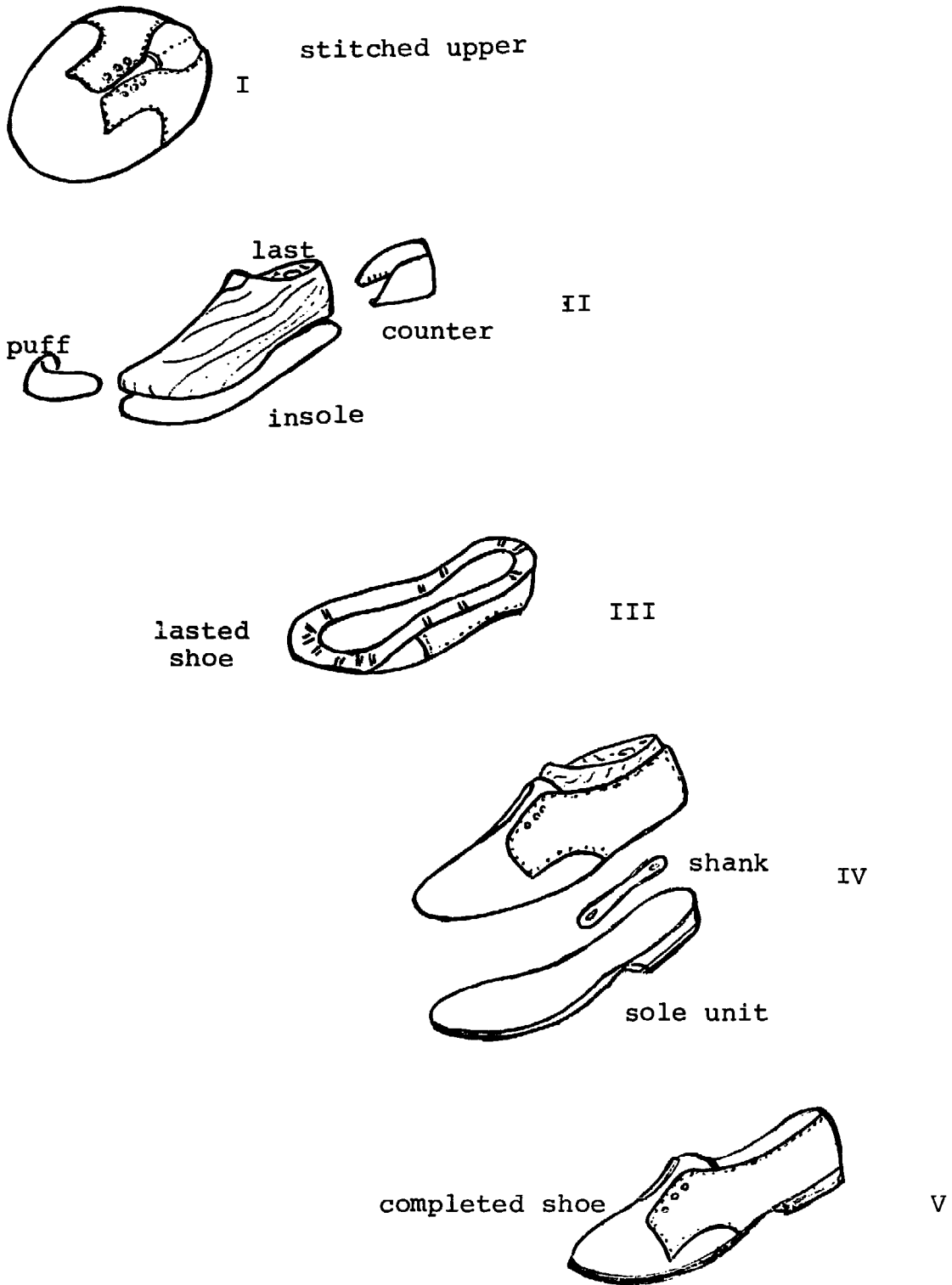

Figure II.1

Stages in the manufacture of Type 1 footwear

The stitched upper of a plain lacing style is shown at I. The insoles are then attached temporarily to the bottom of the last by tacks, and the heel stiffeners and the toe puffs (which respectively help shape the backs and toes) are located. At II, a toe puff, a heel stiffener, and an insole ready for assembly with the upper on a wooden last, are illustrated. Cement lasting involves stretching the edge of the upper round the last bottom and attaching it to the insole bottom with cement. After removing the tacks holding the insole to the last, the shoes are conditioned, the shanks which stiffen up the waist of the shoe are attached to the insoles, and the sole units are stuck on to the bottom. IV shows a shank and sole unit, and V a finished shoe after the removal of the last. The final manufacturing stages involve cleaning, inspecting and packaging.

A full list of the manufacturing stages is given in Table II.1. The departmental divisions indicated in the table are often ignored in small enterprises. The points at which major inputs occur are listed, but for the sake of clarity minor consumables such as tacks, cements and finishing solutions (mentioned in the text) are not shown. In terms of human resources, cutting, stitching and lasting require more inputs than the other operations and, consequently, they receive the greatest attention.

II. DETAILED DESCRIPTION OF PROCESSING STAGES

II.1 Cutting uppers (Operation reference No. 1)

The way in which upper components are cut, or 'clicked', out of skins can have a considerable influence on the cost, appearance, comfort and wear resistance of finished shoes and on how well they retain their shape in use. Because leather is expensive, it is important that it is cut in the most economical manner, thus providing cut components of the required quality while minimising the amount of waste leather.

II.1.1 Hand cutting

Hand cutting is exclusively used in scales 1 and 2 (8 and 40 pairs per day) and used in some of the

Table II.1

Stages in the production of leather-upper cement shoes with cemented-on unit soles

<u>Production stages</u>	<u>Op. Ref</u>	<u>Operations</u>	<u>Major materials</u>
Upper-cutting	1.	Cutting upper components	Skins and lining materials
Upper preparation	2. 3. 4. 5. 6. 7. 8.	Leather splitting Lining marking Stitch marking Hole punching Sock embossing Skiving Edge folding and cementing	
Upper stitching	9.	Stiching of uppers	Threads, tapes
Stitched Upper finishing	10. 11. 12. 13. 14. 15. 16.	Seam reducing Taping Eyelet reinforcing Punching and eyelet insertion Temporary lacing General fitting and puff attaching Upper trimming	Tapes Eyelets String Trim, puffs
Bottom component preparation	17. 18.	Insole preparation Sole cementing and drying	Insole sheeting Sole units
Making	19. 20. 21. 22. 23. 24. 25. 26. 27. 28. 29. 30.	Insole tacking Stiffener insertion Upper conditioning Cement lasting Tack removal and inspection Heat setting Bottom roughing Shank attaching Bottom cementing Bottom filler insertion Sole laying Last removal	Heel stiffeners Shanks Felt
Upper finishing	31	Upper finishing operations and packing	Packing materials

operations in scales 3 and 4 (200 and 1000 pairs per day). Choosing the best cutting pattern on a particular skin is the most important and difficult part of a leather cutter's task. Cutting by hand rather than machine should not affect the quality of the components. In hand cutting, a knife held in one hand cuts round the contour of the required shape with the material laid on a board, and the second hand preventing the pattern from slipping. Long continuous clean cuts are desirable since short cutting strokes will leave the profile with irregular edges and cause problems during the subsequent edge tapering, or skiving, operation.

The edges of hand-cut components should be cut square to their surfaces to faithfully reproduce the required shape. Cutting at acute angle to the leather surface with a straight blade produces vertical as well as horizontal forces which help hold thin leather and fabric against the board, thus preventing buckling and tearing.

When upper components are cut from skins, only one thickness can be cut at a time so that blemishes may be seen and avoided by operatives. This puts hand cutting at less of a disadvantage compared to machine cutting than if it were technically feasible to cut skins in a stack.

The equipment used in hand cutting includes the following:

(i) Clicking knives

Ranges of interchangeable, differently shaped, blades are available to fit specially designed hand clicking knives. Blades used for heavy leathers have longitudinal concave cutting edges about 30 mm. long so that the cutting edge is nearly at right angles to the surface of the leather. This type of blades avoids over-running at corners.

To keep hand cutting knives very sharp, a strip of waxed calf skin can be fixed along the edge of the cutting bench. Stropping the blade on this strip between cuts reduces the frequency with which it is necessary to sharpen the blade on emery. Apart from accelerating the blade wear, rubbing

the blade on emery heats it up and tends to remove the temper.

Clicking knives may be made out of a broken hacksaw by grinding one edge of the hacksaw to shape, and by wrapping insulating tape around part of the blade. These knives may be used in place of the special purpose knives marketed by various tools manufacturers.

Figure II.2 shows three differently shaped clicking knives.

(ii) Patterns and cutting boards

Patterns are sometimes made of galvanised sheet steel, but more often they are of rigid fibre-board with their edges bound all round with a brass channel strip to prevent knives from cutting into the card.

Cutting boards are normally 70-100 mm. thick with a roughly square surface of about one half square metre (e.g. 70 cm x 70 cm). Boards can be of artificial fibre or of wood with blocks of pine or lime bonded together so that their end grains form the cutting surface. This reduces the rate at which the surface is cut away. The benches are usually high enough to permit cutting in the standing position.

(iii) Awls

Awls about the size of old fashioned gramophone needles can be fitted to the end of a knife handle, and are used to prick stitching and lapping guide holes on upper components.

II.1.2 Mechanised Cutting

Mechanised cutting should be used in some of the operations in scales 3 and 4. It commonly uses cutting presses and strip steel knives cold bent to the shape of the pattern. Some high speed automatic processes using lasers or water jets are available for cutting stacked man-made materials but such equipment is only economical if output volumes are very large.

STRAIGHT

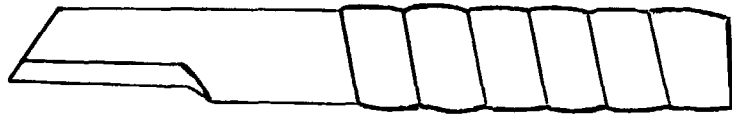

The knife may be made from hacksaw blades wrapped with insulating tape.

CONCAVE

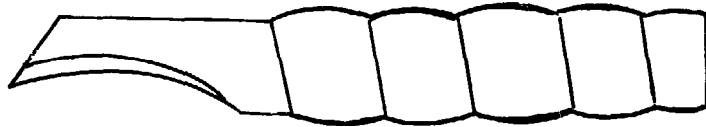

FLAT SKIVING KNIFE

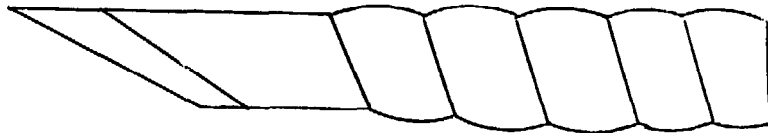

GROOVING TOOL

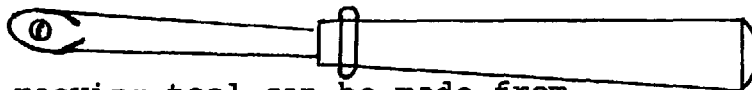

The grooving tool can be made from an old screwdriver softened before drilling, with its cutting edge formed with a very small round file, then sharpened with a narrow strip of fine emery cloth.

Note: The steel may be softened by heating and slow cooling, then hardened by heating and quenching in oil.

Figure II.2

Simply made cutting tools

The equipment used in mechanised cutting include the following:

(i) Press knives

Press knives for cutting single thickness of material are usually reversible with cutting blades on both their top and bottom edges so that only one knife needs to be used for pairs of right and left foot components. In cases where it is unnecessary to see the top surface of the material before cutting, cuts can be made from both sides of the material with a single edged cutter to produce left and right foot components. These knives are made from thin strips of steel. Frequent checks are required in order to ensure that they have not been distorted. To produce clean cuts, the knives must be sharp. Special purpose edge dressing machines are available to help regrind knives. Rotating grinding wheels can also be used for knife sharpening but care is necessary to avoid "burning" the edge by exerting too much pressure.

Notches to indicate the component size can be incorporated into the knives. Alternatively, cut edges on components can be hand dabbed with paint of different colours and in different positions so that machinists may bring together the correct components. Machines carrying several rotating wheels which each dip into a different coloured paint, can be used for this purpose. Alternatively, the cutter may merely write the necessary details on the back of the cut components with a piece of chalk. Sometimes, colour marking is undertaken in the preparation and stitching department.

(ii) Cutting presses

Some cutting presses have a "beam" supported between two columns and a cutting head that can be traversed along the beam. Other presses have a cantilevered beam that can swing over the table. The surface of the tables of swing arm presses are usually 1 m long by 0.5 m wide, while travelling head press tables are usually 1.5 or 2 m long by 0.5 m wide. The maximum press cutting forces

vary from below 10 tonnes on small beam presses to 30 tonnes on large travelling head machines. The simpler presses have hardwood, synthetic rubber or fibreboard cutting blocks, and are mechanically or hydraulically activated. Electronically controlled hydraulic machines are also available, with the attached beam reversing as soon as the knife completes an electric circuit by touching the lower cutting block. This cutting block is made of a soft aluminium alloy to avoid damaging the hardened steel cutting edge. Most manually controlled presses have two hand operated tripping buttons located on top of the beam. These buttons must be pressed simultaneously to activate the cutting cycle, thus reducing the chance of accidents. Some travelling head presses can be controlled by a joystick located on one of the columns, while other presses have a completely automatic pre-programmed cycle to traverse the head and initiate the cutting cycle. Both swing arm and travelling head presses can be equipped with devices for unrolling and feeding fabrics and synthetic material in single or multiple layers. Swinging beam presses can be used to cut wide fabric fed from rolls by arranging one cutting table under two swinging beams facing each other at right angles to the direction in which the material is fed.

The economic break-even scale of production between hand and press cutting is about two thousand pairs of cuts. The point at which the costs switch in favour of one of the two cutting techniques is not a function of the wage level since the cost of knives is the determining factor. Thus, differences in wage levels between developed and developing countries should not determine the use of hand or press cutting. It is the scale of production which determines the choice of cutting technique. For example, even the most highly mechanised factories in developed countries use hand cutting for small scales of production.

II.2 Upper Preparation

Manufacturing leather uppers involves preparation, stitching and finishing operations. They consist of a relatively large number of short operations ranging from visual inspection at a bench to assembling the various components on a stitching machine. In terms of work content, stitching is usually the most important of the three types of operations involved in upper manufacture. Usually, a greater proportion of the workforce is engaged in stitching than in any other activity. Even in its most capital-intensive form, stitching is still a labour-intensive process.

Figure II.3 shows an example of the sequence of operations necessary to produce uppers for an elaborate style of men's leather upper. The sequence of operations required to prepare components prior to stitching and finishing may vary widely from style to style. In large factories, each type of work may be carried out in a separate department and, sometimes, stitching of different types of upper is divided between a number of departments. If the lot, or batch, sizes of components were very large, each operation shown in Figure II.3 may need to be performed on a separate machine. On the other hand, small enterprises may carry out many of the stitching operations on a single machine. Since this memorandum is principally concerned with small-scale production, descriptions of the equipment available for the different types of work are grouped together.

II.2.1 Leather splitting (Operation reference No. 2)

The leather splitting may be economically performed by shoe manufacturing plants producing at least 2000 pairs per day (i.e. scale 4).

Cut leather components that are thicker than required or have uneven thickness due to loose flesh adhering to their underside can be split on a band knife machine. The thickness of the split may vary from about 5 mm. down to zero. The machine has a continuous strip knife blade running horizontally between two large rotating wheels using the principle employed in a band saw. The components to be reduced are fed between a pair of feed rolls which move the work past the knife blade. The whole area of the component is reduced to the pre-set thickness and the waste is collected in a box.

Figure II.3
Typical work flow during preparation and stitching

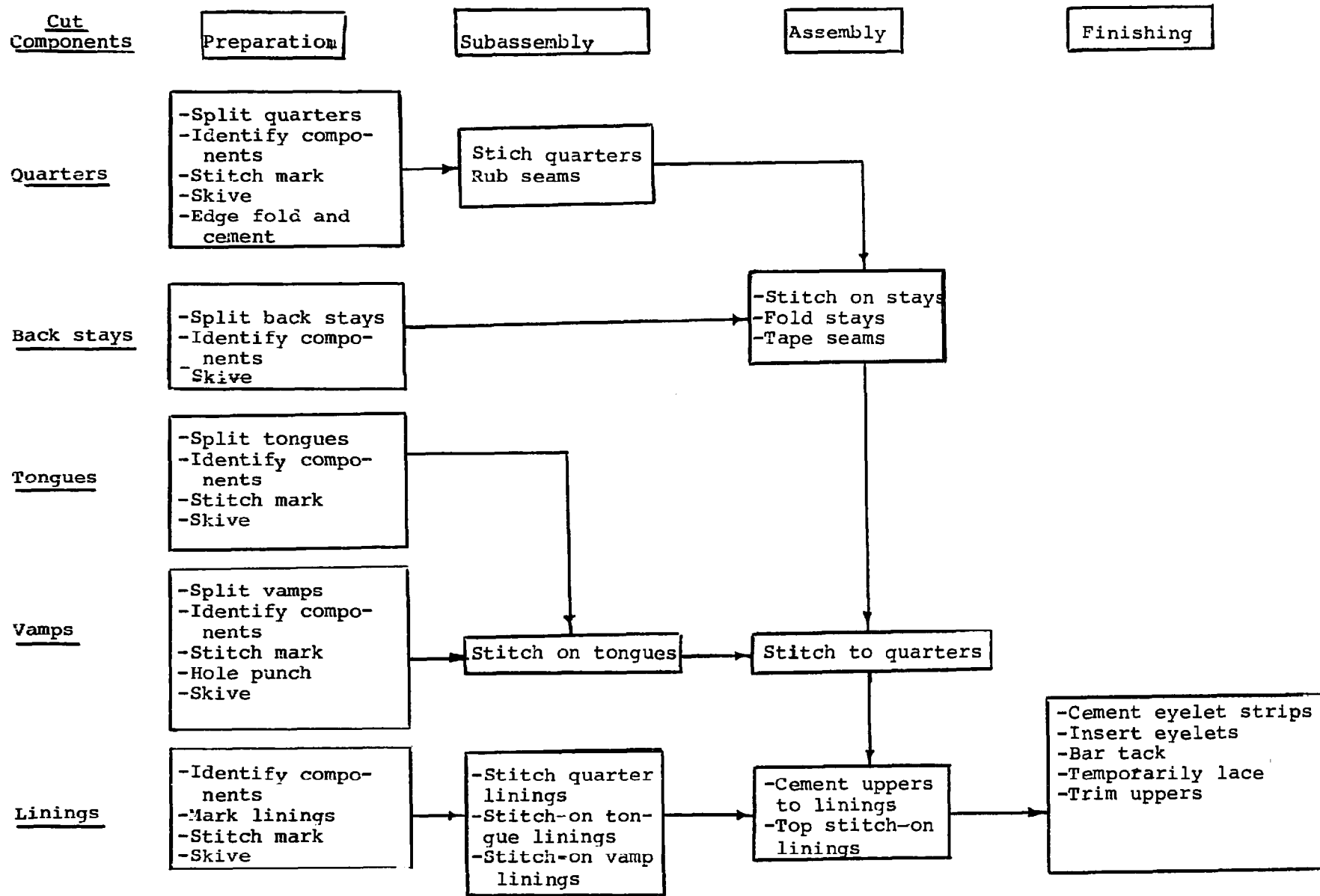

Footwear manufacturing enterprises in developing countries that do not find it necessary to invest in band knife splitters (i.e. enterprises operating at scales 1 to 3) may depend on local tanners to supply leather of the required thicknesses. Otherwise, they may remove uneven flesh areas by hand, with a sharp steel scraper blade held at right angles to the surface of the leather.

II.2.2 Lining marking (Operation reference No. 3)

It is common for details of each pair of shoes to be marked on the uppers. Marking helps identify pairs of shoes at subsequent stages of manufacture, and facilitates the ordering of repeats by trade customers. Details usually include style number, size, width fitting and last number. On unlined shoes, the information is sometimes printed on top of the tongue, but in the majority of cases it is marked on the quarter linings.

Three techniques may be used for lining marking:

- (i) Details may be written by hand with ball point pens if one wishes to convey an expensive individual appearance,
- (ii) Use of an inkpad and rubber stamp,
- (iii) Specially designed stamping machines, that can be mounted on a bench, are available for large-scale production. These machines have stamping heads, and use automatically dispensed foil embossing strips. The type is mounted on the circumference of adjustable wheels.

II.2.3 Stitch marking (Operation reference No. 4)

Guide marks help stitching machinists to accurately overlap upper sections, and to correctly position fancy stitches, buckles, eyelets and trims. Two techniques may be used for stitch marking, depending on the adopted scale of production:

- (i) Use of press cutting knives

This method may be adopted for scales 1 to 3 (i.e. 8 pairs to 200 pairs per day).

Press cutting knives may incorporate notches to indicate the positions at which seams are to start and stop, as well as pricker pins which produce stitch guidance holes. Guide lines can be drawn on upper components with a ball point pen through slots in a flat pattern or template made of fireboard. The template will, in this case, have the same shape as the component on which it is laid.

(ii) Treadle and hand-operated marking machines

For scales of production of 1000 pairs per day and higher, enterprises may use treadle and hand-operated marking machines. These machines use a printing die consisting of a sheet of pattern board to which raised metal or plastic ribs of the desired seam configuration are attached. Ink from a wide ribbon is transferred on the die to a component which is located by pegs on a guide board. Each end of the die block is located by two radial arms to provide a parallel motion. The die block is thus held in a horizontal plane as it swivels over between the inking ribbon and the component laid on the guide board. Springs centre the swivelling die block clear of both the guide board and the ribbon when the machine is not in use.

A similar manual inking method uses fibreboard patterns cut to the component shape. The patterns have plastic ribs attached to both sides in the desired stitch pattern. The pattern with the ribs on its underface loaded with ink is placed on top of a component to be marked. By inking the ribs on the top face of the pattern while pressing the pattern down onto a component, left and right components can be marked alternatively. The replenishment of ink to the ribs on the top face is by means of an inking ribbon running across the bottom face of a hinged plate. The latter is spring loaded upwards so that the operator can load and unload work, and turn the pattern over between strokes of the machine. Each pattern board may be used to cover a range of one and a half British sizes of adult shoes.

These machines can be of wood but are most often of cast iron.

II.2.4 Hole punching (Operation reference No. 5)

Some leather upper design styles require decorative perforations round the edge of toe caps. Hole patterns are also often cut on the foreparts of children's sandals. The following devices may be used for hole punching:

(i) Manual punching tools

Manual punching tools may be used for scales 1 to 3. These tools have blades of the required shape which cut one hole at a time with each hammer blow.

(ii) Hole punching machines

For larger scales of production (scales 4 and higher) hole punching machines become cost-efficient. These machines may consist of top male punches and lower female recesses which are capable of producing a whole pattern (e.g. on a sandal vamp) in one cycle of a hand fly press or light powered bench press. Edge perforations may also be produced by powered punches in which the punch action is synchronised to the edge feed.

II.2.5 Sock embossing (Operation reference No. 6)

Brand names and trade marks are usually embossed onto the plastic coated fabric or thin leather socks that are cemented over the seat or the whole of the insole once the sole has been lasted. Normally, gold coloured plastic foil is used for this transfer process although, in the past, the discolouring action of a heated die was sometimes used to produce a contrast on leather socks.

(i) Local production of embossing equipment

At production scales 1 and 2, a very inexpensive machine can be constructed by mounting an electric iron (which has a variable temperature control) on a hinged

arm with the brass embossing die attached to the bottom of the iron. The pressure and duration of contact is controlled by the operator. Consequently, the work quality relies on the operator rather than on predetermined machine settings. Such machines are used by small-scale footwear manufacturing enterprises in developing countries. When used on a continuous basis, these machines may process fifty pairs of socks per hour (see Figure II.4).

(ii) Semi-automatic embossing machines

For higher scales of production (3 and above) high throughput semi-automatic embossing machines are available. Control of die temperature, embossing pressure and dwell time are preset and the operator merely feeds the socks in one after the other. The production rates of these sophisticated machines can reach seven hundred pairs per hour on long runs. Slower, manually operated machines are less expensive but less convenient to operate.

II.2.6 Skiving (Operation reference No. 7)

Skiving is the term used to describe the tapering required on the flesh side of some edges of upper components. On fabric backed materials, it may be necessary to skive the top rather than the flesh surface. The objectives of this important operation are to permit easy assembly, good appearance and wearer comfort.

(i) Manual skiving

Manual skiving may be efficiently adopted for scales of production 1 and 2. The traditional way of carrying out this operation is by hand, using a very sharp flexible steel knife blade and a flat surface such as a solid steel plate, a slab of marble or a sheet of plate glass. The component is laid flesh side up on the surface and held down with the free hand while the excess thickness is sliced off. The knife is held across the flat of the hand and drawn back towards the operator. This method is relatively slow, with a typical output rate of

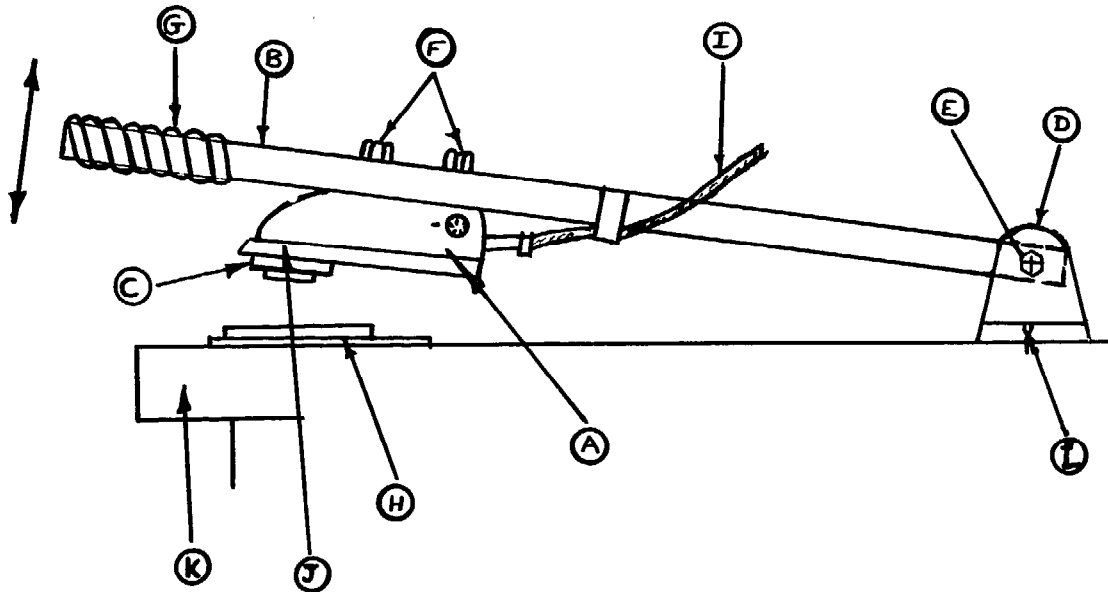

PARTS LIST

- A. Domestic electric iron with adjustable thermostat with handle removed.
- B. Steel tube, 30 mm. diameter by 650 mm. long drilled for hinge bolt and screws to hold iron.
- C. Proprietary brass embossing die.
- D. Hinge blocks of steel angle section or wood drilled to hinge and screwing to work bench.
- E. 10 mm. diameter bolt, nut and washers to act as hinge pin.
- F. Screws to attach the body of the iron to tube and the die to the sole of the iron.
- G. Insulating tape.
- H. Workpiece to be embossed with precut strip of embossing foil laid on it.
- I. Flex for mains.
- J. Sole of iron drilled and tapped for attachment of embossing die.
- K. Work bench.
- L. Two hinge bracket screwed to work bench.

Note : The best combination of pressure, temperature and application time should be found by means of trials.

Figure II.4

A simply made insole embosser for small volume production

ten pairs of components per operator hour. A good deal of practice is required to produce uniform tapers.

(ii) Skiving machines

For higher scales of production (3 and above) the use of skiving machines may become more efficient. The most widely used type of skiving machine employs a rapidly rotating steel disc with the cutting edge on its circumference, past which the component is carried. The edge support plate, which guides the component, is adjustable for scarf width and angle.

Machines are available that can be pre-set to produce two or three different knife angles at the flick of a pedal so that a component requiring different treatments along different edges may be completed in one pick up. The skill required to set these rotating cutter machines varies considerably from model to model. In operation, these machines require substantially less skill to produce good results than skiving by hand and their output can be about fifty pairs per operator hour on a typical men's style with five leather upper components per shoe.

(iii) Matrix skiving

A more recently introduced method, called matrix skiving, requires fixtures or matrices made from sheets of hard rubber or composite material which have recesses sculptured into one side. These recesses are shaped to the size and contour of the finished component. This method is, in general, economically viable when more than two edges of a component require skiving, and when there is a sufficient volume of work to justify the cost of producing the recessed work holding fixtures for each size of each component. In matrix skiving, components are laid flat in the recesses, with only the material to be removed protruding. The loaded fixtures are then guided through a band knife splitting machine similar to that described earlier in connection with leather splitting. The knife removes the surplus thickness from the areas of the component protruding above the top surface of the fixture.

II.2.7 Edge folding and cementing (Operation reference No. 8)

This operation may be carried out on unassembled components or on partly stitched uppers. Several methods of folding over and cementing down the top lines of uppers are available.

(i) Manual folding and cementing

Manual folding and cementing may be efficiently used for scales of production 1 and 2. The output rate of manual methods is estimated at approximately 12 to 15 pairs per operator hour. The usual sequence used in manual folding and cementing includes the following: adhesive application, notching of curves, folding over the straights, pleating the bends, and flattening the folds. The last operation involves tapping down the folds with a short, flat-ended metal bar or similar tool. A metal template can be useful in maintaining an even fold line.

Figure II.5 shows a hand tool for cementing down folded skived edges.

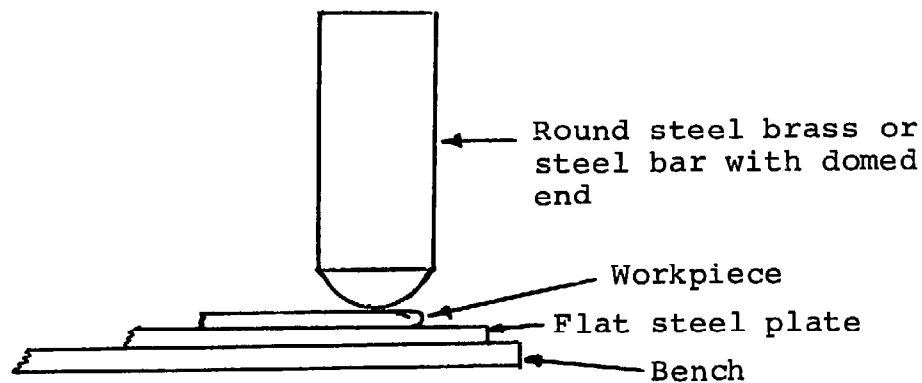

Figure II.5

Hand tool for cementing down folded skived edges

(ii) Folding and cementing machines

For higher outputs (e.g. production scales 3 and above) various expensive electronically controlled machines are available. These machines require relatively little operator skill, but need a good deal of maintenance back-up.

Electronically controlled machines incorporate photo-electric cells that automatically sense bends requiring snipping and pleating, and also dispense thermoplastic adhesive to bond the material in position. The operator feeds the components and controls the speed with a foot pedal. A narrow tape can be incorporated into the fold to limit stretch.

The output of these machines is estimated at approximately 80 pairs per operator hour. Simpler machines, similar in overall design concept to the above machines, are also available at lower prices. These simpler machines do not include electronic components, and their output rate is estimated at approximately 40 pairs per operator hour.

Equipment for producing other types of edge finishes is discussed in the section dealing with stitching.

II.3 Upper Stitching (Operation reference No. 9)

II.3.1 Stitching methods

Stitching may be carried out by hand or by stitching machines. However, manual stitching is rarely used in the construction of uppers except in the stitching of mocassins for the production of decorative effects. Even in countries where capital is very scarce and wages very low, stitching machines are usually employed in very small production units. The reason for this is that stitching machines are extremely productive. An operator using such machines can construct as much as two metres of double rowed lapped seam per minute. He can also form regularly spaced and tensioned lock stitches at a rate of forty per second. Even the most skillful hand stitcher would find it difficult to achieve one per cent of this output. Consequently,

the use of stitching machines may be shown to be much more cost-effective than manual stitching for all but the lowest scales of production.

II.3.2 Stitching machines

Most stitching machines produce lock stitches which have a top thread fed by the needle and a bottom thread fed from a bobbin. The lock between the top and the bottom threads should be concealed within the material. Chain stitches only require a top thread, but it unravels if the thread breaks.

Stitched seams can be produced on components with edges cut to matching or different contours when flat. When the contours do not match, stitching them together produces assemblies with seams curved in three dimensions at once. This reduces the amount of curvature that it is necessary to impart during last-
ing.

On some machines, the stitch length is adjustable. On variable stitch length machines, the work is stationary while the point of the needle is below the needle plate and the work is advanced between stitches. This type of machine is more often used on light work where variability of the feed-rate is unimportant. It is necessary to change the gearing ratios to alter the stitch length on fixed feed rate machines. Their needles and needle plates oscillate at the same rates so that the work is advanced while the needle is below the needle plate. On all types of stitcher, the thread tension can be varied to suit particular types of work.

Machines having flat beds are used for a wide range of work, such as stitching in eyelet reinforcing strips and other work that can easily be stitched on a flat surface.

In post bed machines, the bobbin is located at the top of a vertical post below the needle. The small working platform at the top of the post enables sprung seams to be constructed more easily than on flat bed machines, since the material can hang down clear of the area being stitched. Machines are available with a choice of the post located to the left or right of the needle.

POST BED MACHINE

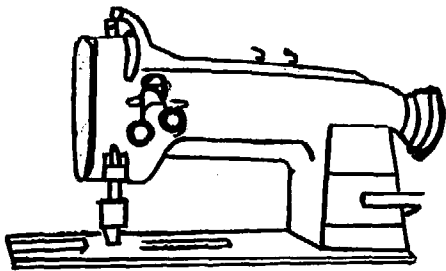
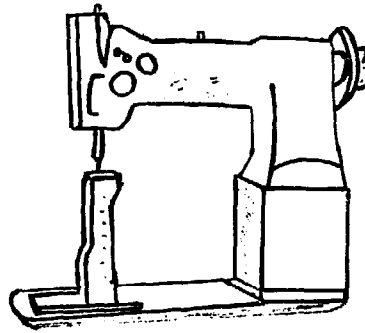

TWIN NEEDLE FLAT BED MACHINE

CYLINDER ARM MACHINE

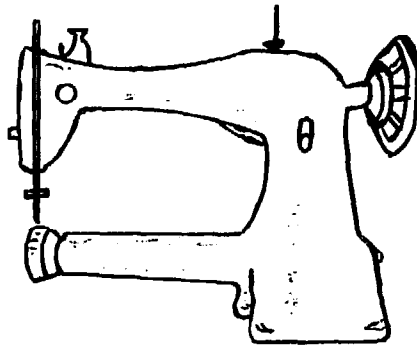

Figure II.6
Types of stitching machines

Once uppers have been closed down the back seams, they can be stitched on cylinder arm machines in which the bobbin is located at the end of a horizontal arm cantilevered out from the main vertical column. Long boots are also closed on cylinder arm machines.

Special purpose treadle driven machines which are designed so that the work can be fed in any direction during stitching are still popular for repair work in developed countries.

(i) Semi-automatic machines

Semi-automatic machines can include underbed thread trimming devices to cut off surplus yarn at the end of a seam as well as edge trimming devices. On some of these machines, the operator can pre-select to finish a seam with a needle up or down, which reduces the time required to remove work at the end of a run, or to turn sharp corners by rotating the work round the table.

(ii) Automatic machines

This type of machines, which costs approximately US\$2,000, does not require the operator to guide the work past the needle. Manufacturers normally sell automatic machine set up with cams and guides to produce a pre-determined shape of stitch pattern. These machines may be easily adjusted for stitching patterns of different sizes. However, most footwear manufacturers would find it extremely difficult, if not impossible, to adjust these machines for stitching basically different patterns.

Most enterprises in developed countries which handle a sufficiently large volume of repetitive work such as bar tacking, buckle attaching and tongue attaching use a few automatic machines. It is sometimes possible for an operator to manage two of these machines by loading and unloading one machine while the other is stitching. Some machine manufacturers offer pairs of automatic machines ganged together to carry out a back seaming and frenching sequence.

Microprocessor controlled automatic machines, each requiring an initial investment of approximately US\$20,000, are now available. These machines, which are programmed by means of tape cassettes, were first used for fancy stitch designs on the sides of boot uppers but are now also used for flat multi-part seaming.

(iii) Choice of stitching machines

Brief specifications of some types of stitching machines suitable for the footwear industry are given in Table II.2. The type of work for which each machine is likely to be appropriate is indicated in the table and further discussed below.

Stitchers are normally described according to their physical characteristics or the type of work that they are intended to carry out. Some of the more commonly specified options are listed below:

Number of needles	: single, twin or three
Type of stitch	: chain or lock
Type of top presser	: foot, idler roller or driven top roller
Stitch length	: variable or fixed
Stitch pattern	: straight or zig zag

One of the most popular combinations of these options found on machines used by small-scale enterprises in developing countries is: straight lock stitching, single needle, roller presser and flat bed. Without motor, stand clutch or lighting, such machines can cost less than US\$400. It is feasible to make good quality footwear on such general purpose machines. However, some operations will take longer on these machines than on more specialised types costing approximately US\$2,000.

Operations	Description
Under edge trimming of top lines	Single (needle), post (bed), roller (presser)
Zig zag	Single, flat, roller
Barring machine	Single, cyl. (arm), barring tack set up
Flat binding	Single, cyl., tape feed with binder
Back strapping	Single, post, for non-parallel back straps
Cording (raised seam)	Twin, flat, roller with air cording attachments
Repairs machine (treadle Powered)	Often purchased second hand
French binding	Single, post, roller with guide, top tape drum and pad needle plate
Close row (1.5mm.) stitching	Twin, flat, roller
Silking or rowing back seams of leather linings	Twin, flat, with silking row modification
Intermediate operations,	Single, post, roller
For heavy (up to 8 cord) decorative stitching	Single, cyl., roller
Intermediate operations (lighter)	Single, flat, roller, auto-underbed trimming and needle control
Intermediate operations (lighter)	Single, flat, roller (simple machine)

Table II.2

Brief description of some machines suitable for stitching uppers

(iv) Stitching aids

Stitching machine attachments and work guides can be inexpensive substitutes for operator training and experience in the achievement of high standards of accuracy and levels of output. Unfortunately, greater use of aids tends to be made in areas of the world with long experience in footwear manufacture than in areas where the industry has been recently established. Some types of aids are listed below for those readers who may not be familiar with their use:

- Work guides - Adjustable guide and presser foot for running on French bindings.
- Adjustable roller edge guide consisting of a short round vertical steel peg attached to the table for control of the overlap width on lapped seams. These guide stout leather better than soft leather.
 - Presser foot and guide to aid the insertion of zips using twin needle machines.
- Thread cutters - Treadle operated thread-end cutting and thread pulling through devices. These are often offered as original equipment.
- Needle threaders - Can be fitted to a wide variety of stitching machines
- Special control mechanisms - Electronic controls to position the needle up or down which enables work to be swivelled on the needle at corners.
- Holding aids - Clamps to hold work during such operations as decorative stitching and tongue attaching.
- General aids - Under edge trimming knives for cutting off excess lining material during top line stitching.

- General aids
- Thread break detector which stops the stitcher after a break and when the bobbin runs out.
 - Device for lowering clamp, starting machine and lifting clamp during semi-automatic tongue attaching work.

II.3.3 Mocassin seams

Mocassin seams are variants of open seams and are most often used to attach mocassin aprons to their vamp wings. They may be formed on an arm-type coarse stitching machine or by hand. Covered mocassin seams, in which the edge of the apron is doubled over the vamp, are more weather-proof than open seams, but hand stitching of the latter takes less than half as much time as on the former. Often, outworkers carry out hand stitching. Where it is carried out in-house, the operation can be simply mechanised without losing the hand-finished appearance. A needle, with an open barb to carry the thread, is fastened to the piston rod of a small air cylinder. To form each stitch, the upper components are first pushed manually onto the unthreaded needle, the thread is then laid into the bar, and finally, the cylinder is activated so that the needle pulls the thread back through the hole.

II.4 Stitched upper finishing

Between stitching operations, and after stitching is completed, it is usually necessary to perform several additional operations in order to prepare uppers for the lasting stage. These operations are briefly described below:

II.4.1 Seam reducing (Operation reference No. 10)

The first operation is seam reducing. It involves cutting down the bulk of stitched back seams by removing the excess material on the seam and then flattening what is left under pressure. These two operations are separated when performed manually. They are on the other hand combined when performed by special purpose seam reducing machines.

Figure II.7 shows the drawing of a simply made tool for reducing closed back seams. This tool can be easily manufactured locally.

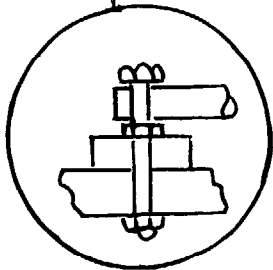
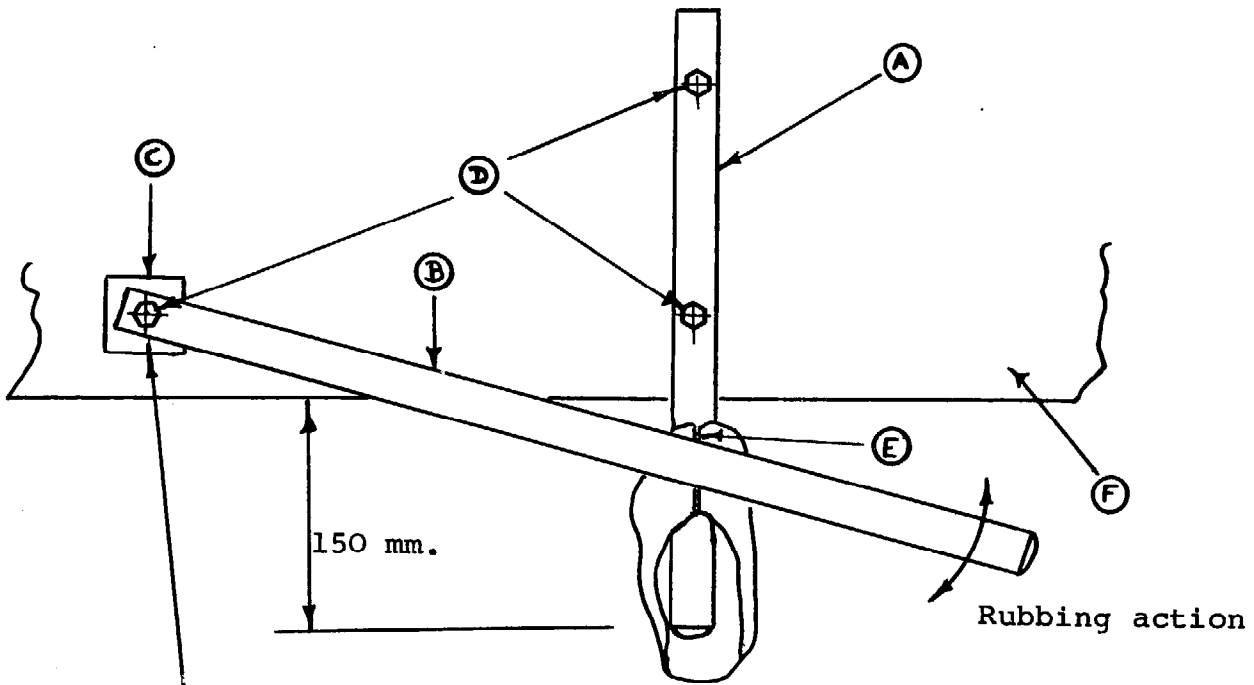

SIDEVIEW OF SWIVEL

PART LIST

- A. Bright steel support bar, 30mm diameter x 400 mm long drilled for fixing bolts.
- B. Bright steel rubbing bar 30mm diameter x 600 mm long drilled with a clearance hole at one end for the swivel bolt.
- C. 25 mm thick spacer block of hard wood drilled for swivel bolt.
- D. 12 mm diameter bolts, nuts and washers for swivel and support bar clamping.
- E. Back seam of upper
- F. Work bench.

Operation: The upper is gripped in the left hand so that the seam is stretched over the support bar. The right hand applies pressure to the rubbing bar while moving it back and forward across the seam.

Figure II.7

A simply made tool for reducing closed back seams

II.4.2 Taping (operation reference No. 11)

As an alternative to a stitched silked seam, woven tape or paper tape can be cemented to the inside of the closed back seam either with the aid of a special purpose machine or by hand.

II.4.3 Eyelet Reinforcing (Operation reference No. 12)

Eyelet reinforcements can be stitched into uppers. Alternatively various labour saving machines are available which cement strips of fabric under the wings of uppers. In small enterprises, this simple operation is usually carried out manually.

II.4.4 Punching and Eyelet Insertion (Operation reference No. 13)

There are wide varieties of techniques available for the punching of eyelet holes and the insertion and clinching of metal eyelets. Some of these are briefly described below.

(i) Manual punching and eyelet insertion

A simple technique, suitable for scales 1 and 2, involves hole punching and eyelet clinching with hand held pliers. Although the cost of the needed equipment is very low, this technique yields an output of up to 30 pairs of shoes per hour. The technique may be further improved through the use of simple tools which may be manufactured locally. These tools are described on Figure II.8. They include an eyelet hole punching tube, and a punch and die for eyelets clinching.

(ii) Mechanised punching and eyelet insertion

For large outputs (e.g. scales 3 and above) various machines may be used for punching and eyelet insertion. The most elaborate machines punch a hole, insert and clinch an eyelet, then advance the work to the position of the next eyelet where the cycle is repeated. Depending on the type of shoe and the number of eyelets, these machines can process up to about 1,500 pairs per shift.

EYELET HOLE
PUNCH



The punch may be produced from a short length of solid steel tube, filed and buffed to shape in a revolving chuck. The hole is cleared with a steel rod after use.

EYELET CLINCHING
TOOLS

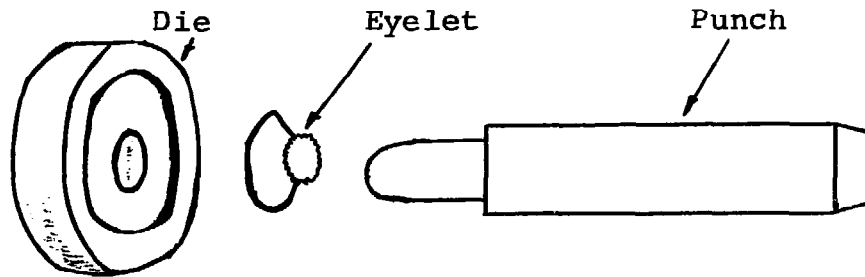

The punch and die should be turned from a steel bar to fit eyelets.

Figure II.8

Eyelet hole punch and eyelet clinching
tools

The most sophisticated manually powered machines have automatic eyelet feeds but do not advance the work automatically. In a less expensive version of this machine, the operator has to locate the position of the eyelets manually.

II.4.5 Temporary lacing

This operation can be carried out by machine or by hand. Temporary laces are tied through the eyelets on lacing shoes so that the uppers maintain their shape during lasting. When casual styles of shoe have elastic gussets rather than laces, fabric tabs are sewn in at the same time as the gussets. The tabs are cut out after lasting.

II.4.6 General fitting and puff attaching (Operation reference No. 15)

When toe puffs are assembled to the upper at this stage rather than during lasting, they may be attached with the help of a mechanical cement applicator or by hand. Decorative trims may be stapled or stuck on after lasting to reduce the risk of their being damaged. In large enterprises in developed countries there is a trend towards the use of puffs consisting of cotton impregnated with thermoplastic resins which are heat printed onto the upper and reheated before lasting to soften them. Thermoplastics are being increasingly used in the same way on stiffeners of leather-board and fabric.

II.4.7 Upper trimming (Operation reference No. 16)

The final trimming of loose threads from the uppers is carried out by hand with scissors. Although a flame is sometimes used to burn off threads, no powered machine is available for this operation. Where the lasting allowance on uppers requires cementing prior to lasting, the cement can be applied by brush or with the aid of an automatic supply unit. If hot melt adhesives are used for cement lasting this operation is unnecessary.

Linings and toe puff edges usually require trimming back to expose the lasting margin or allowance of the upper. Machines are available which can carry out this simple operation and to also roughen up the margin of the upper in preparation for cementing. However, these two operations may also be carried out efficiently by hand.

II.5 Bottom Component Preparation

II.5.1 Insole Preparation (Operation reference No. 17)

The operation includes the following sub-processes:

(i) Cutting

Insoles are cut to shape from sheets of leatherboard, cellulose board, blended strip or, exceptionally, leather. Cutting can be done manually with knives and templates of the required shape. Large

enterprises often use heavy cast steel knives to cut several thicknesses of board with one stroke of a mechanical beam press. A heavy duty press, used to cut stacks of up to four boards at once, can produce 2,400 pairs of insole blanks per shift. Swing arm mechanical presses, identical to those used for cutting upper leather, can usually cut two thicknesses of insole material.

(ii) Size stamping

To enable the various sizes and widths of insoles to be identified, numbers and letters are normally stamped onto them. This operation may be carried out with a stamping machine or manually with stamps and a hammer.

(iii) Seat bevelling

The edges of the back part of the insoles are bevelled to help the fit of the upper round the edge of the insole. This operation may be carried out either manually or with the help of a machine.

(iv) Slotting

Insoles for high heeled shoes may need a series of shallow slots cut across the undersides of their foreparts to assist flexing. These slots may be cut by hand or with the help of a rotary cutter.

(v) Insole moulding

The omission of an insole moulding operation at this stage can adversely affect the quality of the finished footwear. The operation involves shaping the insole into an exaggerated copy of the last bottom contour. During lasting, the moulded insole springs back to the last contour. The objectives are to achieve a close fit between the last and the insole (and thus prevent the insole from curving up round its edge during lasting) and to obtain a good shape retention and appearance. Many small-scale enterprises do not have presses equipped with male and female moulds capable of

permanently forming the insole. They, therefore, rely on the insole being bent roughly to the required shape by hand. Another solution for small enterprises is to fit metal insole forming moulds or lasts that have been rounded off at the feather line with the help of the press used for cement sole attaching. Sole presses are discussed in a later section.

(vi) Shank grooving

In the past, the shank - which is the narrow reinforcing strip used to strengthen the waist of the shoe - was invariably attached to the bottom of the insole after lasting. Wooden shanks are still often tacked or cemented on at that stage but the use of metal shanks contoured to the shape of the moulded insole is increasing. Metal shanks can be laid in a groove specially cut into the insole and then riveted into position. The groove is cut out before moulding by hand or with a rotary cutter.

(vii) Cementing

Insoles that will be attached to the lasting margin of uppers by means of contact adhesive require to be cemented round their edges. Neoprene cement or pressure sensitive latex adhesive is usually used. Cement dispensing machines are available or the operation can be performed manually with a brush. Drying may be in air on a rack or in a heated cabinet.

II.5.2 Sole cementing and drying (operation reference No. 18)

To prepare their surfaces for sole attaching adhesives, sole units made of PVC or polyurethane are washed with solvents. Those made of resin rubber are scoured with wire brushes, while units of leather to be cemented on can be roughened with needle sharp saw toothed rotary cutters. Application of a synthetic rubber or polyurethane adhesive to the upper surface of the sole unit can be done by brush or under pressure from a nozzle. The cemented units are normally stored on wire racks while drying.

II.6 Making

II.6.1 Insole tacking (operation reference No. 19)

Insole tacking is one of several operations carried out before lasting, whereby insoles are temporarily fastened onto the bottom of the last. This operation may be carried out manually or with the help of special purpose tacking machines.

(i) Manual insole tacking

At small levels of output, insole tacking may be carried out with the help of a worn magnetised file for tapping the tacks through the insole into the last bottom. In this operation, the socket on top of the last is located on a vertical steel column - called a jack - fixed to a bench. Figure II.9 shows drawings of the file and of the lasting jack. These tools can be manufactured locally.

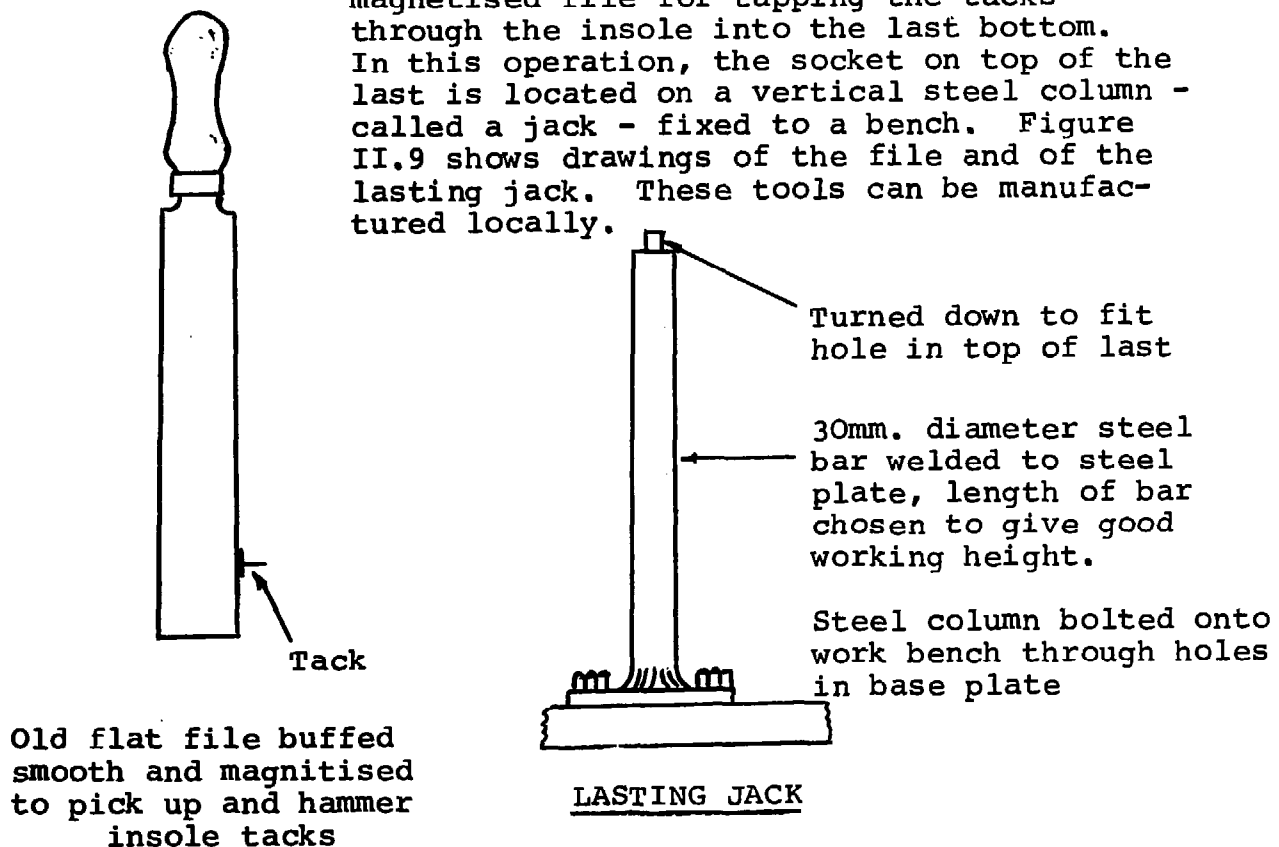

Figure II.9

Insole tacking tools

(ii) Insole tacking machines

At high levels of output, the use of special purpose tacking machines may be justified. In some systems, steel studs are permanently fixed in the bottom of the last, and insoles are pushed onto them by a machine. Although expensive, this approach has the advantage that tacks cannot be inadvertently left in the shoe.

Normally, three tacks are inserted for each insole. However, small enterprises which do not possess an insole moulding machine, often insert five or six tacks on the forepart, and two or three tacks over the waist and seat. These tacks hold the insole tight to the last during lasting.

II.6.2 Stiffener Insertion (Operation reference No. 20)

Where stiffeners do not have to be inserted immediately before lasting, and there is a sufficient volume to justify the operation being separated from lasting, heel stiffeners may be manually placed into the pocket between the quarter lining and the quarter. At this point, French chalk may be applied to the seat of the upper, and last slip paste may also be applied to the toe of the last. Both substances assist in the removal of the last from the lasted shoe.

II.6.3 Upper Conditioning (Operation reference No. 21)

The absorption of moisture by leather uppers before lasting, and their subsequent drying after lasting greatly enhance the shape retention properties of leather uppers. Although synthetic upper materials do not absorb water, their fabric backers may do so. They may therefore be heated either with or without moisture prior to lasting and then dried in the normal manner after lasting.

A variety of moisture conditioning techniques are available. For scales 1, 2 and 3, water mixed with a soapy wetting solution may be sponged on the uppers. For the same scales, a more satisfactory result may be obtained if the upper are suspended over a tray of boiling water so that steam permeates the leather. The

introduction of this relatively simple and inexpensive system can markedly improve appearance and shape retention.

A method which is unlikely to be appropriate at the lower levels of production, but which could be suitable for scale 4, involves suspending the uppers (until required for lasting) in a closed room where atomised water droplets are sprayed at ambient temperature. This approach is unsuitable when thermoplastic heel stiffeners and toe puffs requiring activation by heat before lasting are used. In a more sophisticated version of this approach, the uppers may be placed in a cabinet in which the temperature and moisture content of the air are controlled at predetermined levels. In this case, uppers require to spend a short period in the conditioning cabinet.

II.6.4 Cement-lasting (Operation reference No. 22)

Although many systems of lasting are available, they all involve pulling the upper over the last and fastening it over the bottom edge of the insole. Cement is now used in the majority of lasted shoes but the whole shoe is not always cement-lasted since tacks may be used to last the sides. A major benefit of cement-lasting a whole shoe is the elimination of the risk of having a loose tack injuring the wearer. Since other methods of lasting are described in later sections, only cement-lasting is considered here. Figure II.10 shows several alternative lasting systems.

(i) Manual cement-lasting

Manual cement-lasting techniques are usually appropriate at low production levels (e.g. scales 1 and 2). In general, one operator carries out cement lasting for a whole shoe. Some operators prefer to mount the last on a jack and to stand at a bench, while others find it most convenient to sit on a low stool beside a low bench on which are laid the materials and tools. A pair of special purpose lasting pincers, with curved and deeply serrated jaws and incorporating a light hammer head, is used to stretch the upper over the last and to fix the lasting allowance to the insole.

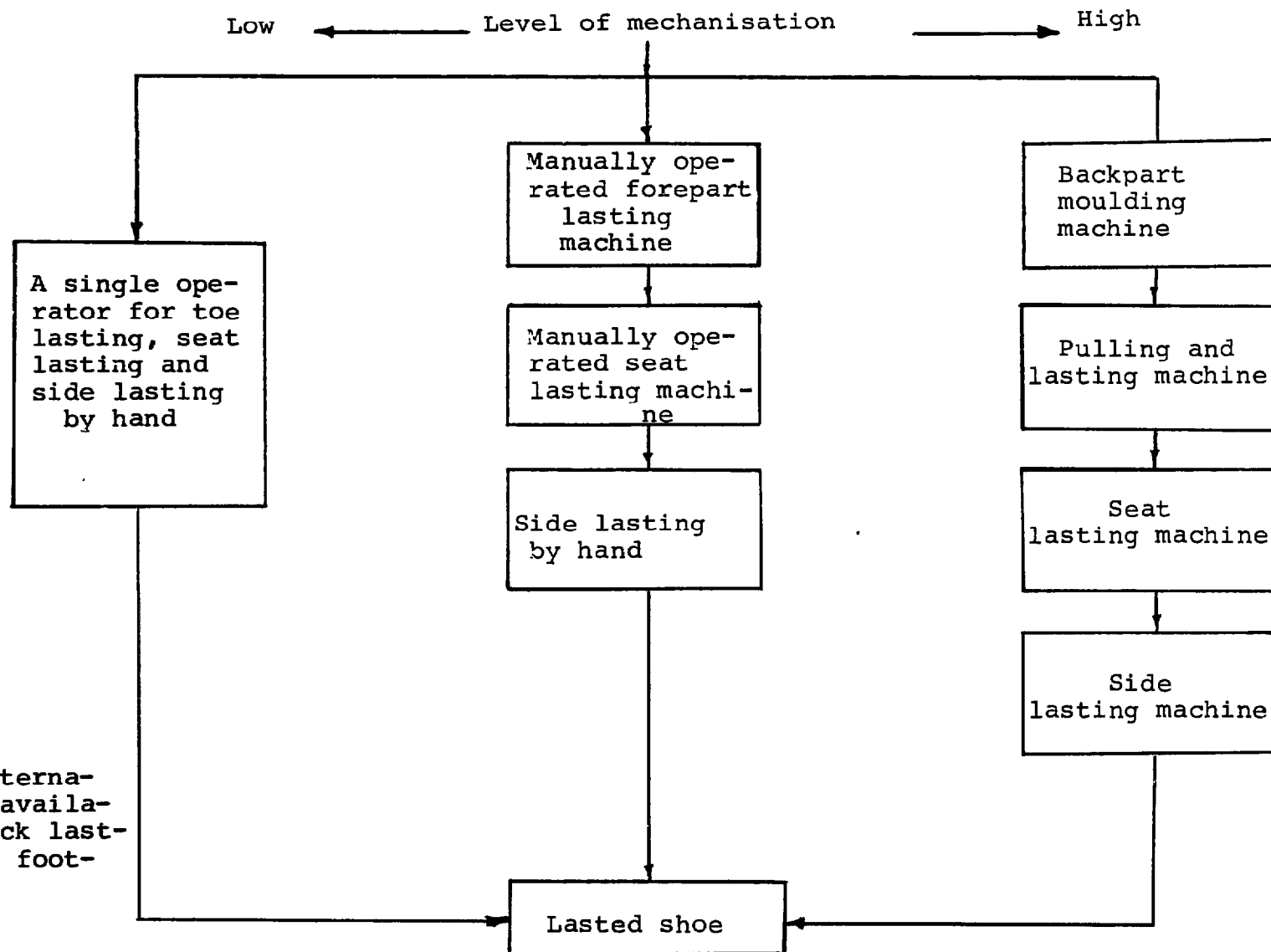

Note: Similar alternatives are available for tack lasting type 3 footwear

Figure II.10

Alternative cement-lasting sequences

If preassembled stiffeners are not used, the operator may have to dip a stiffener (usually pre-moulded leather-board) into a pot of latex and then position it. Similarly a puff (usually woven cotton) may have to be dipped into an acetone solvent before inserting it.

Hand lasting usually requires greater skill than any other footwear manufacturing task. The aspects of the job that are most difficult to master are the attainment of the correct directions and degrees of strain, and the achievement of uniformity between a pair of shoes in terms of squareness, back height and the fit and shape of the top line.

In manual cement lasting, tacks may be used to temporarily hold uppers in position on the last. Usually the toe is drafted over and fixed first. The back and sides are usually fixed after the toe area has been attached. The order in which each stage is completed depends on the preference of the operator. The final stage includes careful pleating of the lasting allowance and the removal of any puckers from the upper round the heel and toe.

(ii) Mechanised cement lasting

Manual cement lasting is generally inappropriate at high levels of production. This operation is therefore carried out with the help of special purpose machines at scales 3 and above. Simple lasting machines may be used at scale 3 while scale 4 usually requires rather more elaborate machinery.

A wide range of machines are available for cement lasting foreparts, sides and seats. Machines are also available that combine pairs of these operations. Consequently, there is a wide spectrum of complete systems that can either toe or seat-last first. As a result of recent technological developments, the quality of work now attainable with expensive modern machinery is often as good as if not better than, that produced by highly skilled operators.

(a) Simple lasting machine

Lasting systems consisting of a pair of manually powered machines are available. One operator using the two machines can generally cement last a shoe in under two minutes. In one such system, the upper is drafted onto the last and the forepart is secured by impact adhesive to the insole on the first machine. In the second machine, wiper plates sweep the lasting margin in over the insole. The wiper plates can be changed over so that toes and seats can be lasted on the same machine. A typical two machine system of this type costs approximately US\$7,500.

(b) High output lasting machine

One type of high output lasting machine uses thermo-activated stiffeners. Before lasting proper, the backparts containing the stiffeners are pre-heated and then moulded to shape in special purpose machines off the last. During this operation the seat can be hot melt cemented to the insole between the internal mould (which is chilled to accelerate setting) and inflatable external seat supports. The last is then inserted into the upper and a tack placed at the toe to hold it in position.

A simpler and less expensive version of this technique involves as a first step back moulding and seat lasting on the last. The next step is to last the forepart. In sophisticated machines, adjustable pincers grip the lasted margin of the upper and wipe it over the bottom of the insole following the automatic application of hot melt adhesive.

In one widely used type of side lasting machine, the operator holds the shoe so that the lasting margins on the side and in the waist are in turn fed through a pair of rollers. As with other cement lasting techniques, the upper and insole can be pre-cemented or immediately cemented manually (prior to lasting) with the help of a hand gun. Alternatively, the adhesive can be applied automatically during lasting.

A lasting unit consisting of a backpart moulding and seat lasting machine, a forepart laster and a side laster with an operator on each machine, might be able to produce a lasted shoe in approximately ten seconds. A high quality system of this type, consisting of three machines, costs approximately US\$100,000. Few footwear manufacturing enterprises in developing countries have sufficiently large markets for high quality footwear to justify such expensive systems.

II.6.5 Tack Removal and Inspection (Operation reference No. 23)

Tacks inserted to temporarily hold the insole to the last are removed after lasting. Usually hand held saw toothed tack lifters are used. For large scales of production, high speed tack extracting machines are also available. The operator removing tacks may also check on the quality of the lasting.

II.6.6 Heat Setting (Operation reference No. 24)

Allowing uppers that were conditioned with moisture before lasting to dry naturally has an important disadvantage: it increases the investment in work-in progress and the number of lasts in circulation. It may also lead to the development of mildew and rust stains may be caused by steel plates fitted to last bottoms. Artificial drying may therefore be used in order to avoid the above problems. Infra-red and other forms of radiant heat constitute one artificial drying source. However, they may result in uneven drying. Blown air should, on the other hand, produce more satisfactory results. One expensive method now available involves passing the shoes through a heating chamber on a conveyor belt. In the first half of the chamber moist air is circulated at high speed to stress-relieve the surface. The air circulating in the second half is hot and dry to remove all moisture and set the upper firmly. Hot air blown from a hair dryer can carry out the same operation.

II.6.7 Bottom Roughing (Operation reference No. 25)

The object of this operation is to provide a good keying surface for the adhesive used to attach the lasted margin of the upper to the sole unit. The operation removes the finished outward facing surface of the upper material and flattens the pleats round the forepart and seat.

(i) Manual bottom roughing

For production scale 1, this operation can be performed manually with a knife for levelling the folds and a wire brush for roughening the grain.

(ii) Bottom roughing machines

For scales 2 and 3, small electric portable drilling machines, costing less than US\$250 may be used for this operation. They are fitted with a wire brush or emery covered wheel and may be clamped to a bench top. Some skill is necessary to ensure that a clean "feather" edge is produced where the sole and upper meet.

A variety of similar machines working on the same principle as the electric drill arrangement are available. Some of these are fitted with wide scouring bands and powerful dust extractors. Figure II.11 shows a simply made scourer for small volume production.

For production scales 4 and above, fully automatic roughing machines are also available. They require the operator to simply fix the lasts carrying the shoes on fixtures, and remove them once the bottoms have been scoured. The cost of these machines is however high (US\$25,000 each) and they should not be adopted unless it may be shown that they are more profitable than simpler machines.

II.6.8 Shank Attaching (Operation reference No. 26)

Shanks not riveted to the bottom of the insole before lasting are attached at this stage. They can be stapled in position with a manually powered or pneumatic powered staple gun, or can be attached with adhesive applied by brush.

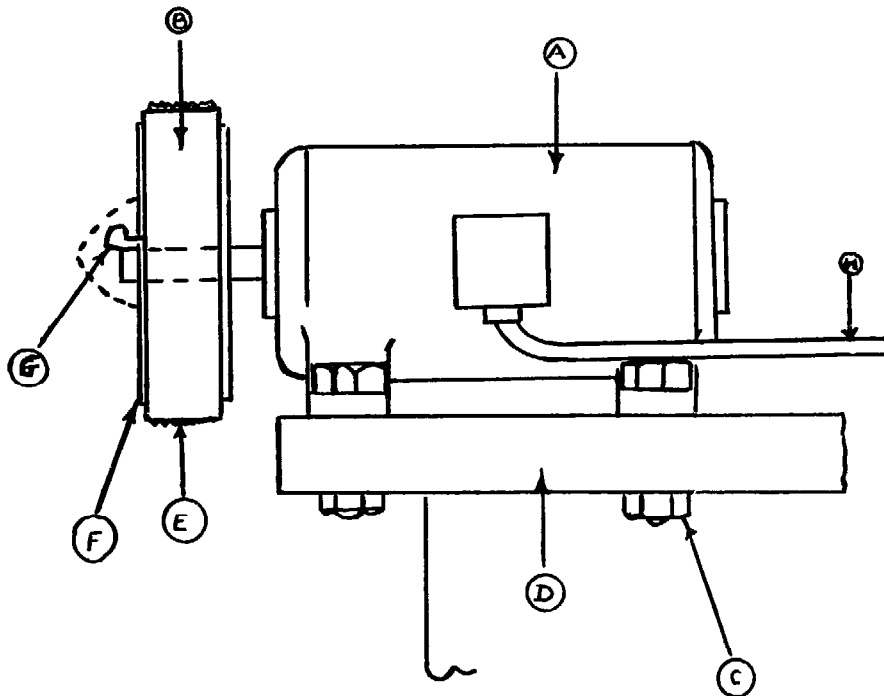

PARTS LIST

- A. Small electric motor.
- B. Wooden disc turned true to bore.
- C. Bolts, nuts and washers to hold motor.
- D. Work bench.
- E. Replacable emery cloth cemented to outer diameter of disc.
- F. Steel clamping plates bored for shaft and drilled for clamping screws. Clamps are screwed to disc with countersunk head screws.
- G. Gib headed tapered machine key for securing and driving clamp plates. Guard cap shown dotted on figure.
- H. Electric wire from mains.

- Notes :
- Check before use that wheel is sufficiently strong so that it does not break up or loosen at high speed.
 - The operator should wear goggles and a face mask since no wheel guards or dust extractors are fitted to cement a cap over the head of the key to avoid injury.
 - As an alternative to the system shown, a power drill could be used with the disc clamped in its chuck.
 - A pulley belt drive from the motor to a separate shaft to carry one or more wheels would be more satisfactory than the design shown, but would be considerably more complicated.
 - Polising discs, grind stones and rotary cutters can be power driven in a method similar to the one shown here.

Figure II.11

A simply made scourer for small volume production.

II.6.9 Bottom Cementing (Operation reference No. 27)

A brush or cement applying machine can be used to spread adhesive onto the roughened lasted margin on the bottom of the shoe. Cement applying nozzles fed from drums pressurised by a hand pump via a flexible tube are available. The adhesive may be dried naturally or by heat.

II.6.10 Bottom Filler Insertion (Operation reference No. 28)

Pieces of felt or scraps of thick leather are attached to the elliptical area in the middle of the forepart of the insole, and to the exposed part of the seat inside the lasting margin. Usually, the operation is performed manually. The cement can be applied to one side of the component with a manually fed, electrically powered machine.

II.6.11 Sole Laying (Operation reference No. 29)

Before placing the sole unit on the shoe bottom, the adhesive on both surfaces must be activated. This is often done by infra-red or quartz-halogen radiant heating.

The next step is to attach the sole unit to the shoe bottom. A number of techniques are available for this operation.

(i) Manual sole laying

Manual sole laying is often used by certain small enterprises. It consists of hammering the units to effect adhesion after careful positioning of the components. Unless care is taken, hammering may cut the upper at the feather edge.

Another technique consists in applying a steady pressure for an extended period of time, so that the cement is allowed to permeate into the lasting margin. This technique is likely to be superior to hammering. It may be adopted for scales 1 to 3, using manually operated machines that may exert pressures of over a tonne. In this type of machines, the load is applied through a

large hand wheel which, by means of a reduction gear, raises and lowers a pair of hold-down posts under which the lasted shoe sits. The sole unit is pressed into a hard rubber pad set in a metal box.

(ii) Hydraulically powered machines

For scales 4 and above, elaborate hydraulically powered machines, which can apply loads of about three tonnes, are widely used. Less expensive machines using compressed air to apply the load through a flexible rubber diaphragm are also available.

II.6.12 Last Removal (Operation reference No. 30)

Once the sole is attached, the last is removed or slipped from the shoe. This can be done manually using a lasting jack to support the last, or with the help of a pneumatically powered last-slipping machine. Whether lasts are slipped by hand or machine, top lines and seams can be damaged if care is not taken.

At this stage, the shoes are ready for finishing operations.

II.7 Shoe Finishing and Packing (Operation reference No. 31)

II.7.1 Crease Removal

Crease removal is the first operation of the finishing stage. It involves the removal of any creases on fine grained upper leathers. Various types of machines may be used for this purpose.

(i) Hot air treeing machine

These machines produce a blast of steam as well as one of hot air. They are appropriate only at higher levels of output such as 3 and 4. These machines are available at various levels of sophistication. Figure II.12 shows a simply made hot treeing machine for small volume production.

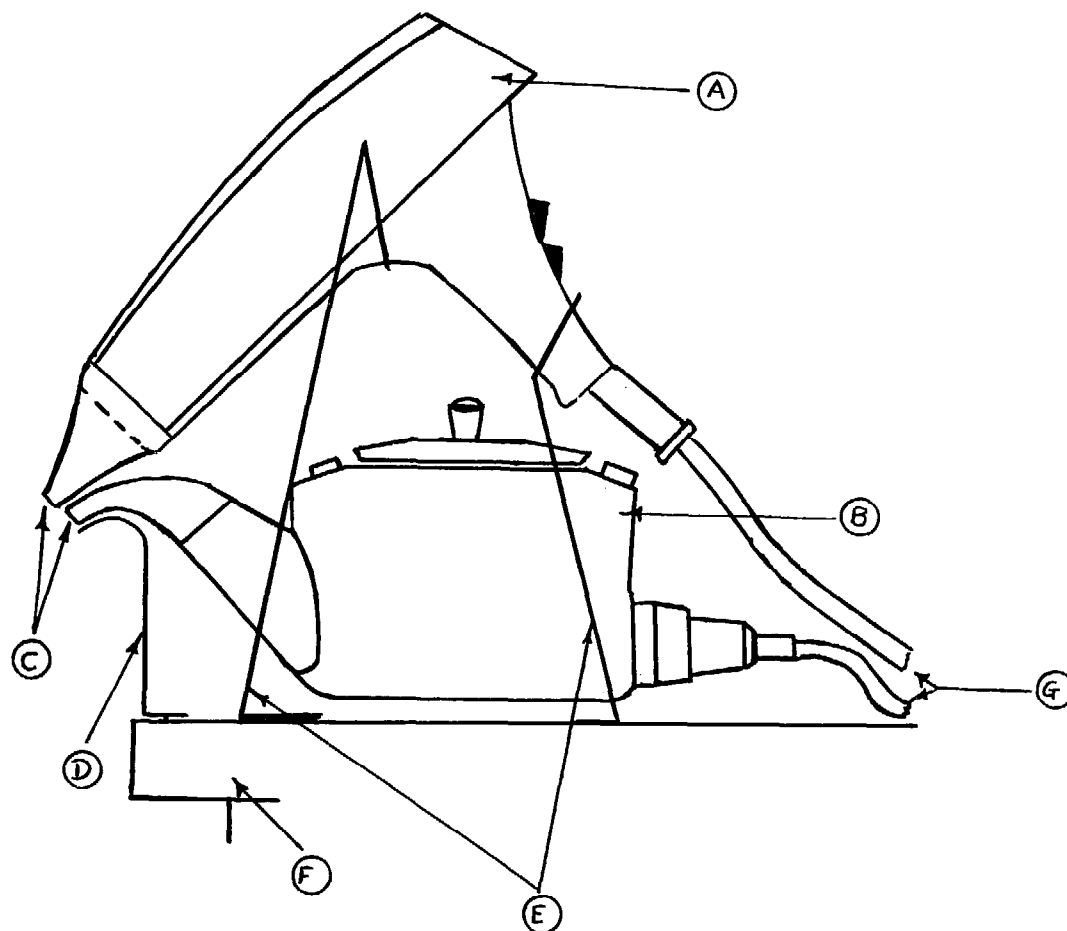

PARTS LIST

- A. Domestic electric hair dryer stapled to bench on both sides.
- B. Domestic electric kettle with handle removed
- C. Lengths of copper or steel tube flattened into slits at one end to form fish tails for dryer outlet and kettle spout.
- D. Short metal strip bent to remove drips.
- E. Two lengths of bent wires for supporting dryer.
- F. Work bench.
- G. Leads from mains.

Notes: The best size for the fish tail slots should be found by means of trials.

It is very dangerous to let hair dryers get wet.

Figure II.12

A simply made hot treeing unit for small volume production

(ii) Hair dryers

For lower levels of output, such as scales 1 and 2, a powerful domestic or professional hair dryer is capable of producing the same required finish as do treeing machines. However, the output rate is in this case much lower. The cost of a hair dryer is approximately US\$30.

II.7.2 Upper Repair

The next step is to repair damages to the surface of the upper material. This may be done with the help of wax crayon to cover blemishes and with cement to fix down cuts.

II.7.3 Sock Insertion

A sock (which may have a backing pad of foam cemented to it) can be cemented either manually, with a brush, or by passing it through an electrically powered cement applying machine. The sock is then inserted into the shoe.

II.7.4 Upper Dressing

The sequence of this operation includes the following:

- Cleaning of upper with a detergent, e.g. a proprietary cleaning fluid or a spirit based solvent,
- Application of a cream dressing by hand,
- Application of a liquid dressing with a sponge or a sprayer. Some manufacturers in developing countries use a dressing mixture made of car enamel of the required pigmentation and solvent,
- An alternative to liquid dressing is the brushing of uppers. This may be done with hand held brushes, bench mounted power drills fitted with mops, and specially designed brushing machines.

II.7.5 Lacing

In lacing styles, laces are inserted into the uppers by hand.

II.7.6 Packaging

Information on shoe styles and sizes are written or printed on labels which are attached to packaging.

Shoe boxes can be assembled either on machines or cemented or stapled by hand.

II.7.7 Inspection

Shoes rejected at the final inspection are returned to the repair section.

III. TABLE OF TECHNICAL DATA

III.1 Material Handling Resources, Work Force and Production Floor Area

Table II.3 refers to type 1 footwear and to the four scales of production covered by this memorandum. However, it also constitutes a useful guide for other types of footwear. The provided floor area should, for example, be approximately the same for footwear types 1 to 4 at each particular scale (e.g. for scale 3, the area should be approximately 250 m² for plants producing footwear types 1 to 4).

III.2 Workforce Allocation : Table II.4

The table on workforce allocation gives a detailed account of the allocation of production workers with respect to each operation and scale of production. It also provides information on the level of skills required for each operation.

III.3 Equipment Specification: Table II.5

Table II.5 provides information on the type and number of equipment required for each operation and scale of production. The four scales of production are shown on the same table in order to facilitate comparisons of equipment requirements between different volumes of output.

IV. FLOOR PLANS FOR PRODUCTION AREAS

A floor plan for each of the four scales considered in the memorandum are provided in this section. These floor plans are for type 1 footwear, but they may also partially apply to other types of footwear. The floor plan for scale 4 relates to the whole plant area (i.e. production areas as well as non-production areas - e.g. storage areas and offices).

Group of Operations	Scale 1 8prs/8hrs	Scale 2 40prs/8hrs	Scale 3 200prs/8hrs	Scale 4 1000prs/8hrs.
Raw materials storage	Racks	Racks	Separate store with storekeeper	Stores with store-keeper
Handling in cutting dept.	Boxes of work, carried	Boxes of work, carried	Boxes of work, carried	Boxes on gravity conveyor
Handling in preparation, stitching and upper finishing	Boxes	Mobile racks	Boxes on gravity conveyor	Boxes on gravity conveyor
Handling and storage before lasting	Rack	Mobile rack, last bins, bottom racks	As for scale 2	Buffer store to sort batches
Handling through making dept.	Carried by hand	Mobile trolleys	Mobile trolleys	Unpowered monorail tracks
Handling through finishing dept.	Carried by hand	Carried by hand	Mobile trolleys	Unpowered monorail tracks
Finished goods storage	Rack	Racks	Sharing raw material store	Separate store with storekeeper
Estimated cost of equipment	\$100	\$250	\$750	\$2,000
Number of indirect employees required	1	3	5	15
Production floor area(m ²)	30	70	250	700

Table II.3

Materials handling resources, work force and production floor area for type 1 footwear

Table II.4
Workforce allocation at each output scale level for type 1 footwear

Op. Ref. No.	OPERATIONS	Scale 1 8prs/8hrs	Scale 2 40prs/8hrs	Scale 3 200prs/8hrs	Scale 4 1000prs/8hrs.
1	Cutting uppers	0.8 s	1.5 s	6 s	16 s
2	Leather split				1 ss
3	Lining marking		1.0 ss	1 us	1 us
4	Stitch marking				3 us
5	Hole punching			2 ss	1 ss
6	Sock embossing				2 ss
7	Skiving			2 ss	4 ss
8	Edge folding and cementing				3 us
9	Stitching uppers	1.0 s	2.0 s	9 s	40 s
10	Seam reducing		1.0 s	1 us	1 us
11	Taping				1 us
12	Eyelet reinforcing			1 us	1 us
13	Punch and eyelet insertion				1 us
14	Temporary lacing			3 s	2 us
15	General felting and puff attaching				2 ss
16	Upper trimming				8 s
17	Insole preparation	0.2	0.5 ss	1 ss	4 ss
18	Sole cementing, and drying				1 ss
19	Insole tacking	1.0 s	1.5 s	1 us	1 us
20	Stiffener insertion				1 us
21	Upper conditioning				
22	Cement lasting			3 s	9 s
23	Tack removing and inspection		1.5 ss	1 ss	2 ss
24	Heat setting				1 us
25	Bottom roughening			1 ss	2 ss
26	Shank attaching				1 us
27	Bottom cementing			1 us	2 us
28	Bottom filling				1 us
29	Sole laying			1 ss	2 ss
30	Last removal		1.0 s	4 s	2 us
31	Upper finishing				14 s
TOTAL DIRECT WORKERS		3	10	38	130

Where an operative is only required part-time on an operation, the work is split.

*s = skilled (4 months training)
ss = semi-skilled (3 weeks training)
us = unskilled (1 week training)

Table II.5

Methods and Equipment Specifications for Type 1 footwear

Output per 8 hours: 8, 40, 200 and 1,000 pairs.

Type: leather-upper cement lasted shoes with cemented-on unit soles

Op. Ref No.	Operations and Major Equipment Items	Equipment source	No. required by scale				Estimated unit cost (\$)
			1	2	3	4	
1	<u>CUTTING UPPERS</u>						
	- clicking bench	local	1	2	6	11	30
	- clicking board	local	1	2	6	11	15
	- cutting knives	sup.list 1	3	10	20	35	6
	- mech. swing arm clicking press	sup.list 1	-	-	1	5	2,200
2	<u>LEATHER SPLITTING</u>						
	- Band knife splitting machine	sup.list 2	-	-	-	1	10,000
3	<u>LINING MARKING</u>						
	- clicking bench		OP1	OP1	-	-	
	- marking bench	local	-	-	1	-	25
	- lining stamping machine	sup.list 3	-	-	-	1	1,700
4	<u>STITCH MARKING</u>						
	- clicking bench		OP1	-	-	-	
	- preparation bench	local	-	1	-	-	25
	- marking bench	local	-	-	OP3	2	25
	- manually operated stitch marking machine	sup.list 4	-	-	-	1	600
5	<u>HOLE PUNCHING</u>						
	- bench	local	OP1	OP4	1	-	25
	- handheld punches	Loc/foreign	1	1	1	-	-
	- perforating mach.	sup.list 5	-	-	-	1	3,500

Table II.5 (cont'd)

Op. Ref No.	Operations and Major Equipment Items	Equipment source	No required by scale				Estimated unit cost (\$)			
			1	2	3	4				
6	<u>SOCK EMBOSSING</u>									
	- press using electric iron element	local	1	1	-	-	35			
	- hand controlled press	sup.list 5	-	-	1	-	550			
	-semi-auto sock embosser	sup.list 6	-	-	-	1	3,000			
7	<u>SKIVING</u>									
	- plate glass sheet	local	1	1	2	2				
	- paring knives	sup.list 1	3	6	12	12	6			
	- manually controlled skiving machines	sup.list 7	-	-	-	2	2,000			
	- skiving benches	local	CP1	OP4	2	-	50			
	- hand work benches	local	-	-	-	2	50			
8	<u>EDGE FOLDING AND CEMENTING</u>									
	- bench		OP1	OP4	OP7	-				
	- mechanical edge folder and cementer	sup.list 8	-	-	-	1	3,500			
9	<u>STITCHING UPPERS</u>									
	All machines listed include motors, clutches and stands. The mix of types is as follows:									
	<u>Needle</u>	<u>Presser</u>	<u>Bed</u>	<u>Features</u>						
	Single roller	flat	basic		sup.list 9	1	1	4	16	740
	Single roller	post	basic		"	-	2	3	10	950
	Single roller	flat	light speed		"	-	-	1	4	650
			light duty		"	-	-	1	3	1,700
	Single roller	cy.arm	basic		"	-	-	-	-	
	Single roller	post	under edge		"	-	-	-	3	2,000
			trimming		"	-	-	-	2	740
	Single roller	flat	zig zag		"	-	-	-	-	
	Single clamp	flat	barring		"	-	-	-	1	2,200
			auto		"	-	-	-	1	2,400
Twin roller	flat	cording		"	-	-	-	-		
Single foot	cyl.arm	manual		"	-	-	-	1	1,000	
		repair		"	-	-	-	-		
Twin roller	flat	silking		"	-	-	-	1	2,100	
		machine		"	-	-	-	-		

Table II.5 (cont'd)

Op. Ref No.	Operations and Major Equipment Items	Equipment source	No required by scale				Estimated unit cost (\$)
			1	2	3	4	
10	<u>SEAM REDUCING</u>						
	- fitting bench, two steel tubes with 1 fixed to bench	local	1	1	1	-	30
	- seam reducing machine	Sup.list 10	-	-	-	1	2,200
11	<u>TAPING</u>						
	- bench		OP10	OP10	OP10	-	
	- tape dispensing mach.	Sup.list 11	-	-	-	1	400
12	<u>EYELET REINFORCING</u>						
	- eyeletting bench	local	OP10	OP10	1	-	25
	- tape dispensing mach.	Sup.list 11	-	-	-	1	400
13	<u>PUNCHING AND EYELET INSERTION</u>						
	- hand operated punch and clincher	Sup.list 13	2	2	-	-	10
	- treadle operated punching and clinching machine	Sup.list 13	-	-	1	-	180
	- hole punching mach.	Sup.list 13	-	-	-	1	500
	- auto feed eyeletter	Sup.list 13	-	-	-	1	400
	- bench		OP10	OP10	OP12	-	
14	<u>TEMPORARY LACING</u>						
	- lacing bench	local	OP10	OP10	1	2	25
15	<u>GENERAL FITTING AND PUFF ATTACHING</u>						
	- fitting bench	local	OP10	OP10	2	1	25
	- loose upper roughing machine	Sup.list 15	-	-	-	1	1,600
16	<u>UPPER TRIMMING</u>						
	- powered trimming mach.	Sup.list 16	-	-	-	2	850
	- bench		OP10	OP10	OP15	-	

Table II.5 (cont'd)

Op. Ref No.	Operations and Major Equipment Items	Equipment source	No required by scale				Estimated unit cost (\$)
			1	2	3	4	
17	<u>INSOLE PREPARATION</u>						
	- bench		OP1	OP1	OP1	-	
	- press knives		-	-	30	50	40
	- sole bench		-	-	1	1	25
	- insole moulding mach.	Sup.list 17	-	-	-	1	8,000
	- insole bevelling mach.	Sup.list 17	-	-	-	1	2,500
18	<u>SOLE CEMENTING AND DRYING</u>						
	- wooden rack	local	1	1	6	10	10
	- bench	local	OP10	OP1	OP17	1	25
19.	<u>INSOLE TACKING</u>						
	- lasting bench	local	1	1	1	1	30
	- tubular steel jacks	local	1	2	1	1	5
20	<u>STIFFENER INSERTION</u>						
	- conditioning bench	local	OP19	OP19	OP19	1	25
21	<u>UPPER CONDITIONING</u>						
	- steamer using electric kettle element and feed tank	local	1	1	2	-	60
	- lasting heater	Sup.list 21	-	-	-	1	250
22	<u>CEMENT LASTING</u>						
	- lasting pincers and knives	Sup.list 22	3	6	20	50	4
	- lasting benches	local	OP19	OP19	3	4	25
	- jacks		-	-	3	7	5
	- manually operated drafting machine	Sup.list 22	-	-	1	-	3,000
	- pull toe lasting mach.	Sup.list 22	-	-	-	1	18,000
	- back part moulding machine	Sup.list 22	-	-	-	1	10,500

Table II.5 (cont'd)

Op. Ref No.	Operations and Major Equipment Items	Equipment source	No required by scale				Estimated unit cost (\$)
			1	2	3	4	
23	<u>TACK REMOVAL AND INSPECTION</u>						
	- tack lifters	Sup.list 23	2	2	3	6	4
	- bench	local	OP19	1	1	2	25
24	<u>HEAT SETTING</u>						
	- hand held hot air dryer	local	1	1	1	-	30
	- wrinkle chasing mach.	Sup.list 24	-	-	-	1	1,200
	- bench		OP19	OP23	OP23	-	
25	<u>BOTTOM ROUGHING</u>						
	- hand held wire brush	local	1	-	-	-	20
	- scouring buff with-out dust extractor	Sup.list 25	-	1	1	-	400
	- bottom roughing mach.	Sup.list 25	-	-	-	2	2,400
	- bench		OP19	-	-	-	
26	<u>SHANK ATTACHING</u>						
	- bench	local	1	OP23	1	1	25
27	<u>BOTTOM CEMENTING</u>						
	- cementing bench	local	OP26	OP23	1	2	25
28	<u>BOTTOM FILLER INSERTION</u>						
	- bench	local	OP26	OP23	OP27	1	25
29	<u>SOLE LAYING</u>						
	- manually powered sole press	Sup.list 29	1	1	1		1,900
	- twin station hydraulic sole presses	Sup.list 29	-	-	-	2	8,000
	- electric fire for heat activation	local	1	1	2	-	40
	- heat activator	Sup.list 29	-	-	-	2	450

Table II.5 (cont'd)

Op. Ref No.	Operations and Major Equipment Items	Equipment source	No required by scale				Estimated unit cost (\$)
			1	2	3	4	
30	<u>LAST REMOVAL</u>						
	- lasting jack	local	OP19	1	1	2	5
	- benches	local	-	-	-	2	25
31	<u>UPPER FINISHING</u>						
	- finishing bench	local	OP26	1	3	12	25
	- hot blast treeing mach.	Sup.list 31	-	-	-	1	1,200
	- spray booth and guns	Sup.list 31	-	-	-	1	500
	- mopping and polishing machine	Sup.list 31	-	-	-	1	400
	- manually operated cementing machine	Sup.list 31	-	-	-	1	200

¹See equipment suppliers list in Appendix II.

²The same pieces of equipment may be used in a number of operations. This is indicated by reference to the number of operation where the equipment is used for the first time (e.g. OP1, OP3).

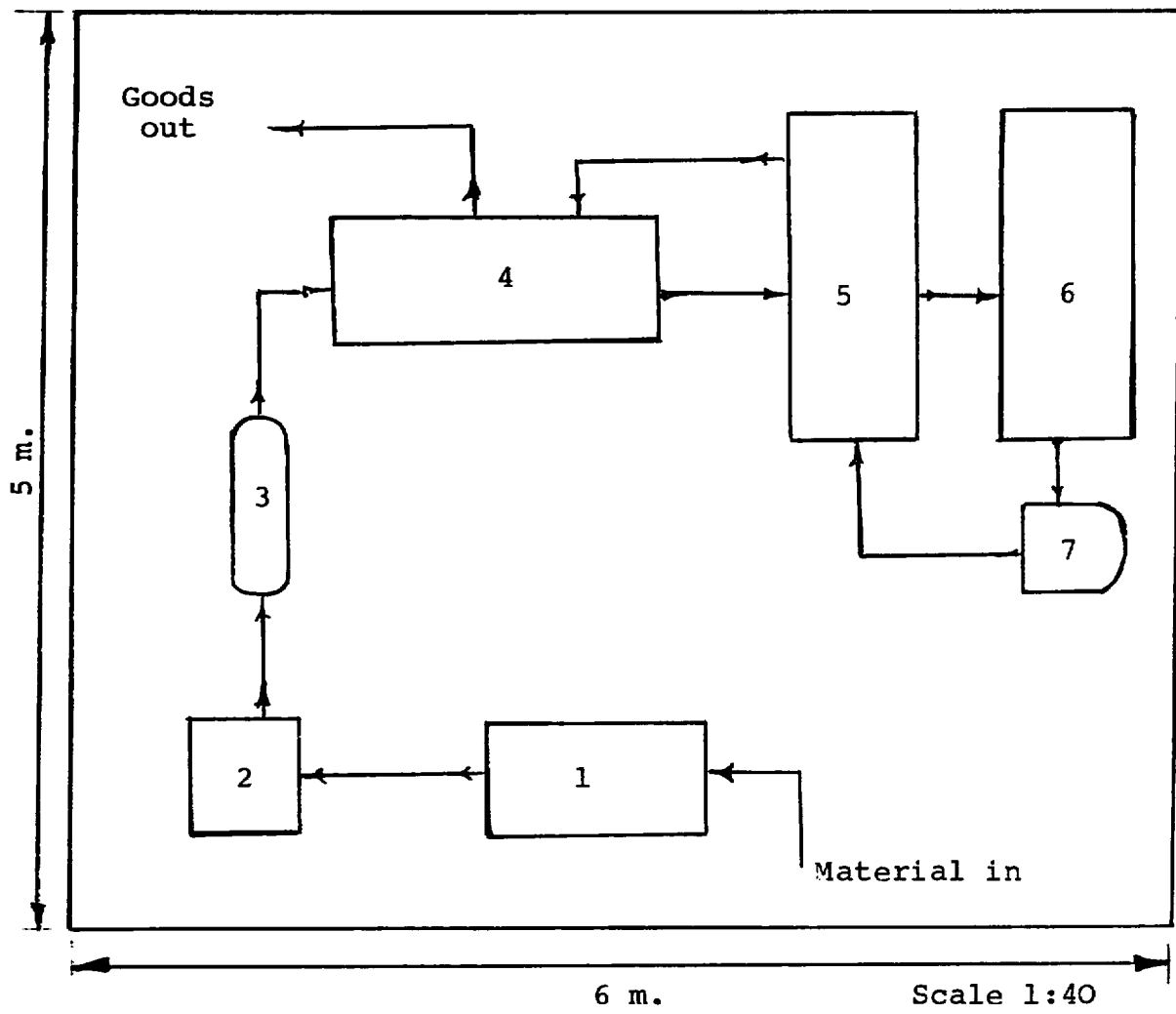

Designation of work stations

- 1. Clicking
- 2. Embossing
- 3. Stitching
- 4. Upper finishing and packing
- 5. Lasting
- 6. Bottom preparation
- 7. Sole laying

Figure II.13

Layout of production area for type 1 footwear - 8 pairs/day

Figure II.14
Layout of production areas for type 1 footwear - 40 and 200 pairs per day

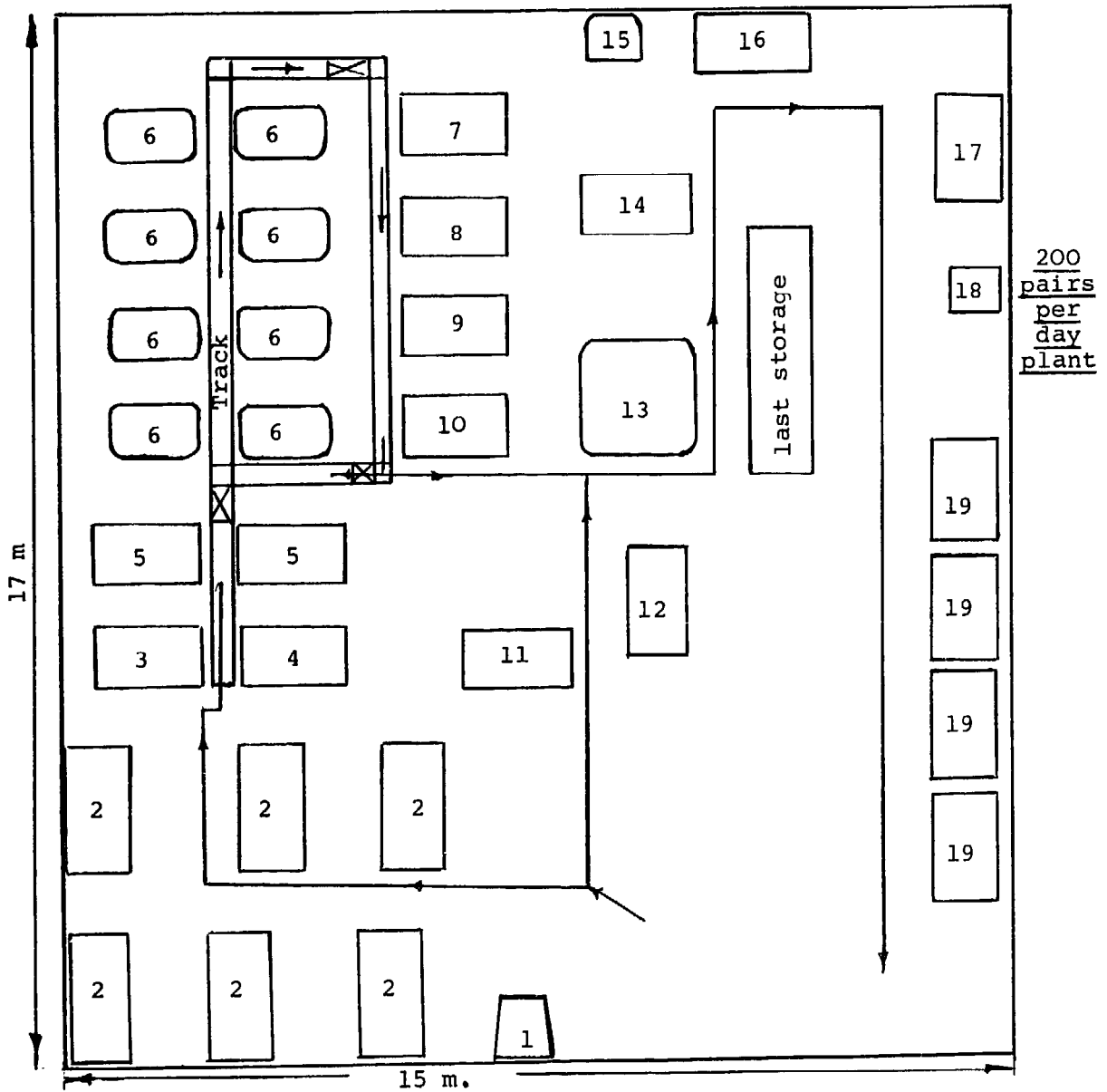
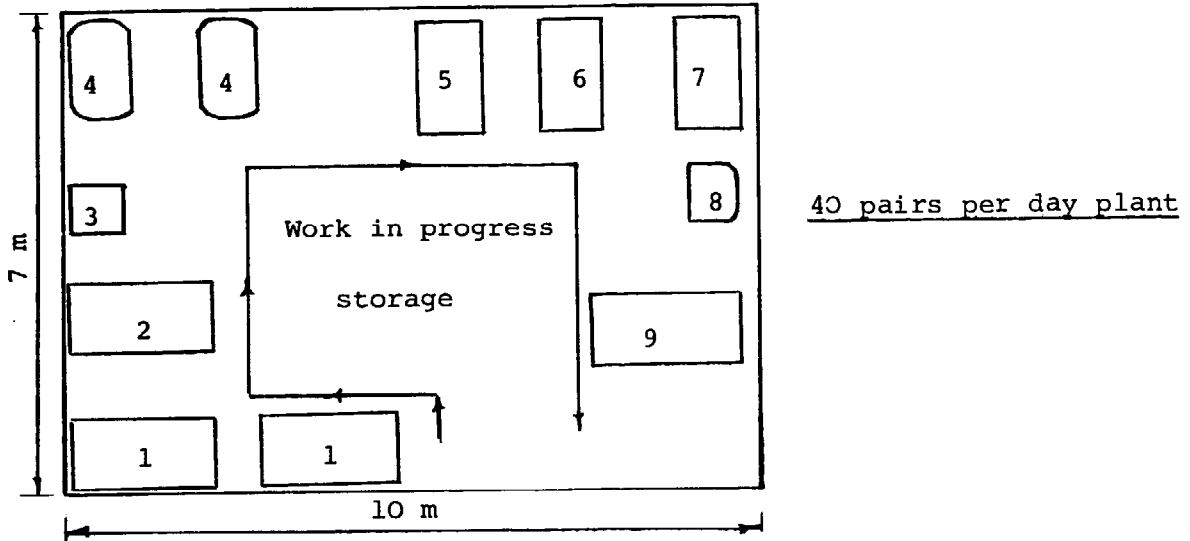

Figure II.14 (cont'd)

Keys to layouts*

40 pairs/8 hours

1. Clicking
2. Upper preparation
3. Embossing
4. Stitching
5. Upper finishing
6. Lasting
7. Bottom preparation
8. Sole laying
9. Finishing and packing

200 pairs/8 hours

1. Clicking machine
2. Hand clicking
3. Marking
4. Embossing
5. Skiving
6. Stitching
7. Seam reducing and taping
8. Eyeletting
9. Lacing
10. Upper fitting
11. Sole bench
12. Insole tacking
13. Lasting
14. Tack removal
15. Bottom roughing
16. Shank attaching
17. Bottom cementing
18. Sole laying
19. Finishing and packing

* The identification numbers in the diagrams are not Operation Reference Numbers.

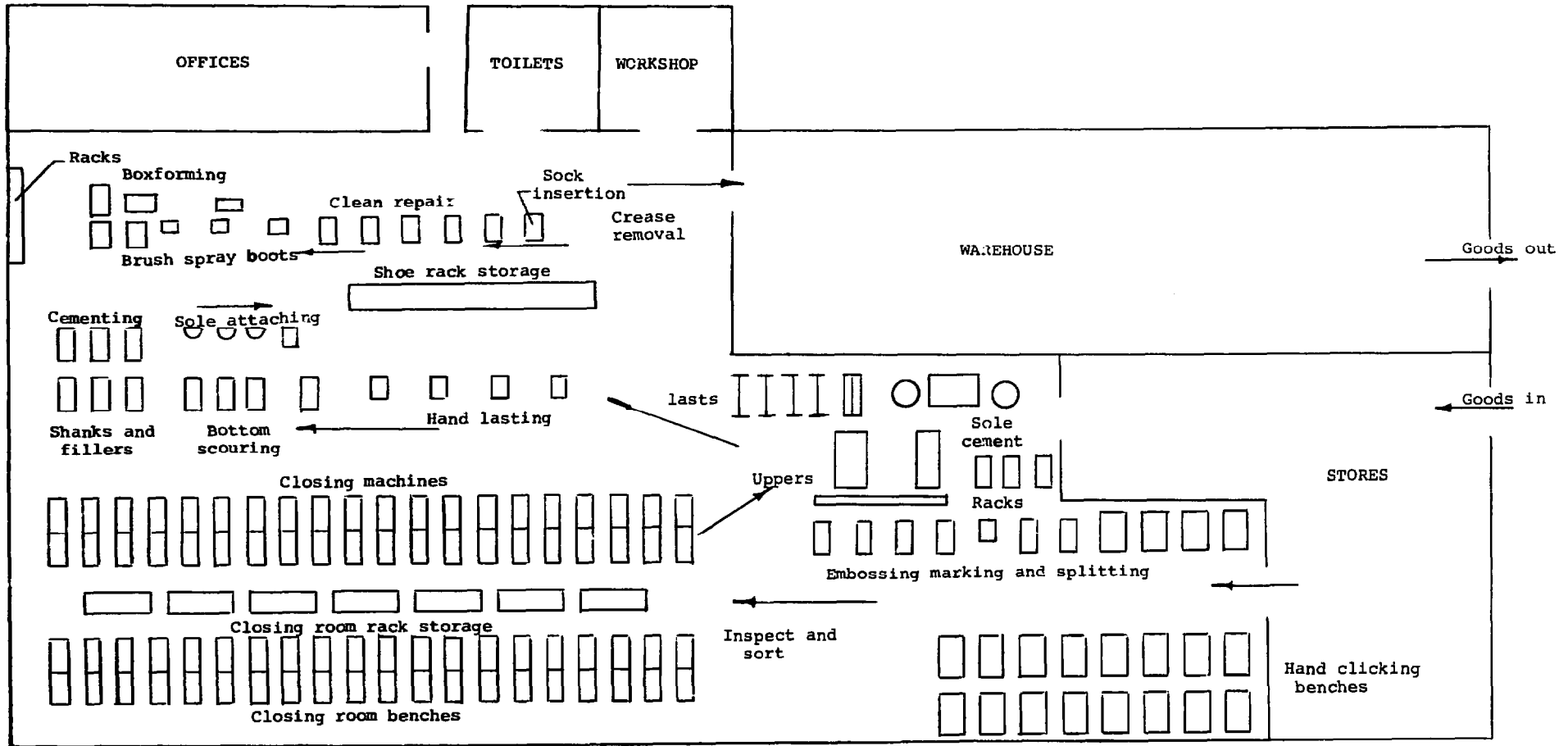

Scale 1:200

Figure II.15

Plant layout for type 1 footwear - 1000 pairs per day

CHAPTER III

MANUFACTURING TECHNOLOGIES FOR FOOTWEAR TYPES 2 TO 6

This chapter considers techniques of manufacturing footwear types 2 to 6. Methods and equipment discussed in Chapter II are referred to in this chapter but not dealt with again. Production stages are first described for each footwear type and are then followed by technical tables covering the four selected scales of production.

I. TYPE 2 FOOTWEAR: LEATHER-UPPER, CEMENT-LASTED SHOES WITH DIRECTLY MOULDED-ON SOLES

The moulding-on process occurs in a single operation. It is a development of the vulcanising method of forming a rubber blank by heat and pressure while bonding its top surface to the shoe bottom.

The principal materials used for this type are Ethylene-Vinyl-Acetate (EVA), Thermoplastic Rubber, Polyvinyl Chloride (PVC) and Polyurethane (PU). This section refers to (PVC) and (PU). The popularity of these methods rose rapidly between the mid 60s and the energy crisis of the mid-70s, and has since continued to grow but at a reduced rate.

Table III.1 lists the manufacturing stages for this type of footwear. Operations unique to this type are listed without asterisks and are discussed below.

I.1 Scrim Attaching (Operation reference No. 32)

To prevent soling material from stocking to the insole and filler, it is necessary sometimes to cement a paper scrim to the forepart of the lasted shoe so that its edge overlaps the lasted margin. This paper scrim, which is pre-cut to be a little smaller than the sole bottom, also prevents the plastic from forcing its way between the upper and insole.

Equipment - the equipment required for this operation is a cement pot, brushes and a lasting jack to hold the shoe while attaching the scrim.

I.2 Heel Core Attaching (Operation reference No. 33)

Heel core attaching is an unskilled cementing operation. Heel cores, also called filler blocks, are often cardboard blanks. These cores are attached to the underside of the seat before moulding and are buried in PVC during moulding.

Advantages - these cores speed up cooling, make the soles cheaper, lighter and reduce their elasticity. Heel cores replace the seat fillers used on cemented-on sole shoes.

I.3 Bottom Solutioning (Operation reference No. 34)

A polyurethane (PU) solution is applied to the lasting margin to ensure that the PVC adheres to it.

The following operation is last removal. It has already been dealt with in Chapter II.

I.4 Direct sole Moulding-on (Operation reference No. 35)

Direct sole moulding-on constitutes one of a number of alternative bottoming processes. Figure III.1 shows the sequence of operations used in bottoming processes for footwear types 1 to 5. Soles may be

<u>Production Stages</u>	<u>Op.Ref</u>	<u>Operations</u>	<u>Major materials</u>
Upper cutting	1*	Cutting upper components	Skins and lining materials
Upper preparation	2* 3* 4* 5* 6* 7* 8*	Leather splitting Lining marking Stitch marking Hole punching Sock embossing Skiving Edge folding and cementing	
Upper stitching	9*	Stitching of uppers	Threads and tapes
Stitched upper finishing	10* 11* 12* 13* 14* 15* 16*	Seam reducing Taping Eyelet reinforcing Punching and eyelet insertion Temporary lacing General fitting and puff attaching Upper trimming	Tapes Eyelets String Trim, puffs
Bottom component preparation	17*	Insole preparation	Insole board
Making	19* 20* 21* 22* 23* 24* 25* 26* 32 33 34 30* 35	Insole tacking Stiffener insertion Upper conditioning Cement lasting Tack removal and inspection Heat setting Bottom roughing Shank attaching Scrim attaching Heel core attaching Bottom solutioning Last removal Direct sole moulding on	Heel stiffeners Shanks Scrim paper Heel cores Sole raw materials
Finishing	31*	Upper finishing operations and packing	Packing materials

Note : The operations marked (*) are discussed in the section dealing with leather-upper, cement-lasting shoes with cemented-on soles.

Table III.1

Stages in the production of leather-upper, cement-lasting shoes with directly moulded-on soles

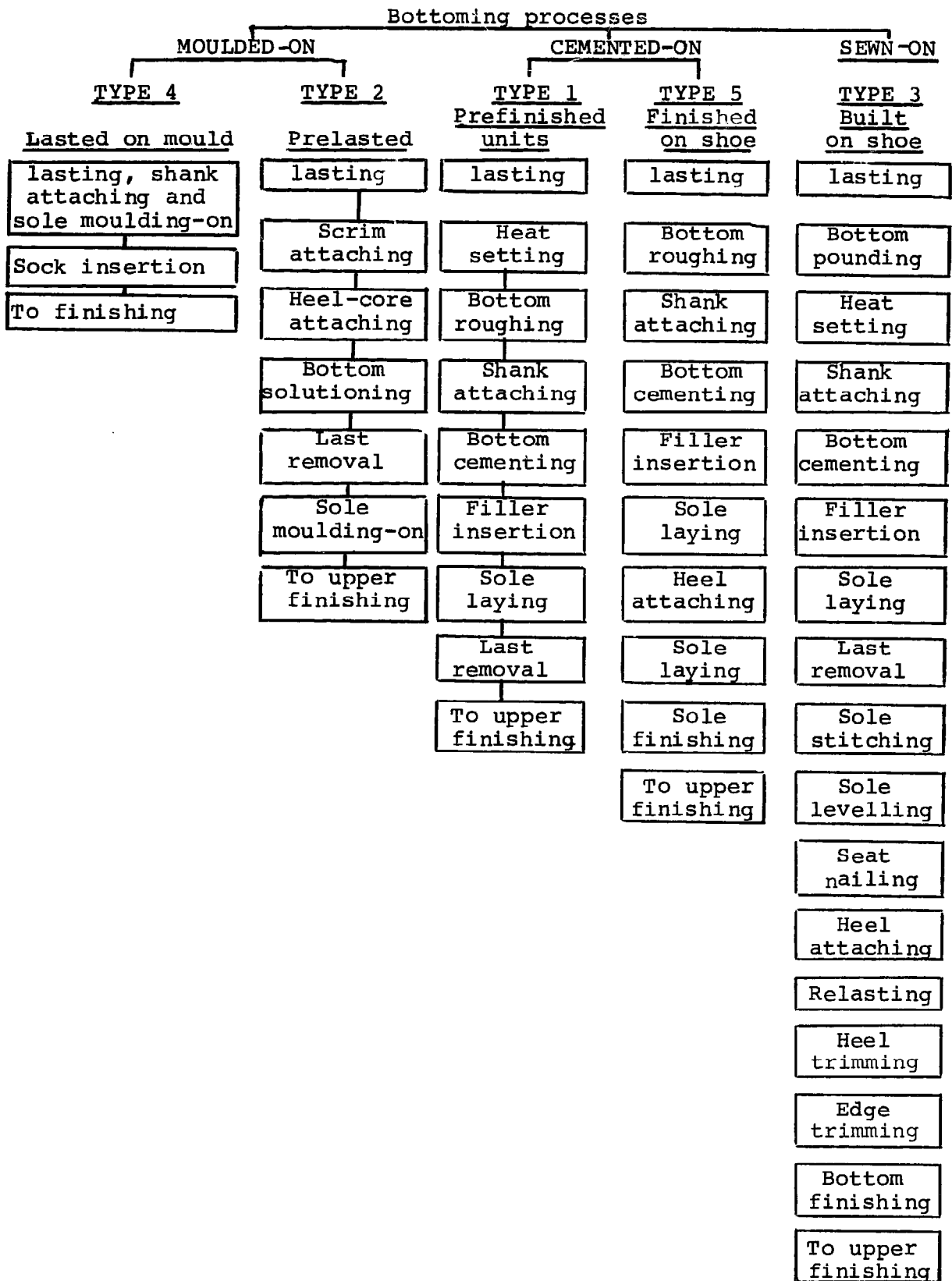

Figure III.1

Comparison of alternative bottoming processes

moulded-on (footwear types 2 and 4), cemented-on (footwear types 1 and 5) or sewn-on (footwear type 3). The figure highlights the relative complexity levels of the five alternative bottoming processes.

I.4.1 Work-in-progress storage

A buffer stock of work-in-progress waiting for sole moulding is required for the following reasons:

- (i) extended runs of one size and style are desirable as mould changing is time consuming,
- (ii) moulding machines are expensive and, therefore, small enterprises run the machines for more than one shift a day.

Mobile storage racks are suitable for this operation.

I.4.2 Moulding machines

The use of a moulding machine is required regardless of the scale of production.

(i) Description of the moulding process

The soling material, usually PVC, is supplied in bags of granules. The bags are loaded into a hopper feeding a heating chamber. A revolving screw or plunger forces the softened plastic through a nozzle into a cavity. This cavity's upper surface is formed by the shoe bottom. During moulding, the shoes are mounted on last-shaped footforms of steel or aluminium. Average moulding stations can complete a full mould-on cycle in less than 3 minutes.

(ii) Equipment

Moulding machines are available with single, twin or multiple stations. Machines with twelve stations or more are uneconomical whenever frequent mould size and style changes occur since every station must be stopped for each change. A battery of small machines (e.g. with a single or twin stations) may therefore be preferable to a single multiple stations machine even when

large outputs are contemplated. In particular small enterprises should employ single or twin stations moulding machines.

A recent innovation is the introduction of multi-mould machines that run three or four different styles simultaneously. This innovation overcomes, to some extent, the problem related to frequent size and style changes.

Prices of moulding machines vary with the precision of injection equipment and the quality of the heating arrangement. Moulds and footforms are made by specialist firms or machinery suppliers and are justifiable only for long sole style lives.

(iii) Machine operating tasks

An operator on a twin station machine can, normally, perform additional tasks within the moulding cycle time. Little skill is required to mount shoes onto the metal footforms, unload them after moulding and to remove any moulding flash by hand. Any waste PVC is ground and re-melted for further use.

(iv) Moulded-on polyurethane (PU)

An increasing number of footwear manufacturers in developed countries produce directly injected moulded-on soles of PU which has better wear resistance than PVC but has only one third of its density.

Process: The PU moulding process is similar to that of PVC except that a hardener and a resin in liquid states are injected into the mould. They react in the mould and expand into a cellular structure which fills the mould cavity and solidifies. Small enterprises in developing countries will probably find PU moulding unattractive because the process is relatively complex. Furthermore, the technical back-up from chemicals and equipment suppliers may be inadequate and could be responsible for frequent disruptions of production.

I.5 Subsequent Operations

Processing stages after sole moulding are the same as those used for type 1 footwear, namely finishing and packing. These operations are described in Chapter II and need not be further elaborated in this chapter.

I.6 Tables of Technical Data for Type 2 Footwear

Table III.2 provides estimates of labour requirements for scales of production 1 to 4, while Table III.3 lists the additional equipment needed for Type 2 footwear.

Table III.2

Workforce allocation at each output scale for
type 2 footwear

Op.Ref	Operations	Scale 1 8prs/8hrs	Scale 2 40prs/8hrs	Scale 3 200prs/8hrs	Scale 4 1000prs/8hrs
1	*Cutting uppers	0.8 s	1.5 s	6 s	16 s
2	*Leather splitting				1 ss
3	*Lining marking		1.0 ss	1 us	1 us
4	*Stitch marking				3 us
5	*Hole punching			2 ss	1 ss
6	*Sock embossing				2 ss
7	* skiving			2 ss	4 ss
8	*Edge folding/cementing				3 us
9	*Stitching uppers	1.0 s	2.0 s	9 s	40 s
10	*Seam reducing		1.0 s	1 us	1 us
11	*Taping				1 us
12	*Eyelet reinforcing			1 us	1 us
13	*Punch/eyelet insertion				1 us
14	*Temporary lacing			3 s	2 us
15	*General fitting and puff insertion				2 ss
16	*Upper trimming				8 s
17	*Insole preparation	0.2 ss	0.5 ss	1 ss	4 ss
19	*Insole tacking				1 ss
20	*Stiffener insertion	0.5 s	1.5 s	1 us	1 us
21	*Upper conditioning				1 us
22	*Cement lasting				
23	*Tack removing/inspection			3 s	9 s
24	*Heat setting		1.0 s	1 ss	2 ss
25	*Bottom roughing				
26	*Shank attaching				1 us
32	Scrim attaching			1 us	1 us
33	Heel core attaching				1 us
34	Bottom solutioning			1 us	2 us
30	*Last removal				2 us
35	Mould-on sole			1 s	2 s
31	*Upper finishing	0.5 s	1.0 s	4 s	14 s
	TOTAL DIRECT WORKERS	3.0	10	38	128

Keys to table: s = skilled (4 months training). ss = semi-skilled (3 weeks training). us = unskilled (1 week training)

Notes:*See type 1 equipment specifications for these operations. Moulding on is unlikely to be undertaken at daily output levels of 8 and 40 pairs. Jobs are shared by operatives in some cases.

Table III.3

Methods and equipment specifications for type 2 footwear

Output per 8 hours : 8, 40, 200 and 1000 pairs.

Type : Leather-upper, cement-lasted shoes with moulded-on soles.

Op. Ref. No.	Operations and Major Equipment required	Equipment source	No required by scale				Estimated unit cost (\$)
			1	2	3	4	
1-26	See Type 1 at same scale						
32	<u>SCRIM ATTACHING</u> See Type 1 for scales 1 and 2 - scrim bench	local	OP20 -	OP23 -	- 1	- 1	25
33	<u>HEEL CORE ATTACHING</u> See type 1 for scales 1 to 3 - core bench	local	OP20 -	OP23 -	OP32 -	- 1	25
34	<u>BOTTOM SOLUTIONING</u> See type 1 for scales 1 and 2 - solutioning bench	local	OP20 -	OP23 -	- 1	- 2	25
30	<u>LAST REMOVAL</u> See type 1 at same scale						
35	<u>MOULD-ON SOLE</u> - single station PVC sole injection moulding-on machine	Sup.list35	-	-	1	-	23,000
	- twin station PVC sole injection moulding-on machines (1 machine if work on a two-shift basis)	Sup.list35	-	-	-	1/2	35,000

Table III.3 (cont'd)

Op. Ref No.	Operations and Major Equipment required	Equipment source	No required by scale				Estimated unit cost (\$)
			1	2	3	4	
35	<u>MOULD-ON SOLE</u>						
	- sets of moulds and footforms	Sup.list 35	-	-	8	16	2,125
	- preheater	Sup.list 35	-	-	1	2	800
	- granulator	Sup.list 35	-	-	-	1	1,400
31	UPPER FINISHING AND PACKING See type 1 at same scale						

II. TYPE 3 FOOTWEAR: LEATHER-UPPER, TACK-LASTED SHOES
WITH MACHINE-SEWN LEATHER SOLES

The type of shoes considered in this section are leather upper, tack-lasted shoes with stitched on leather soles.

As a result of the development of effective adhesives during the last thirty years, large scale footwear manufacturing enterprises in developed countries have steadily reduced their use of tack-lasting in favour of cement-lasting. Similarly, cemented-on unit soles have replaced stitched-on soles and heels finished on the shoe. However, the traditional techniques employed in constructing tack-lasted, stitched-on sole shoes may still constitute an appropriate alternative. They are often used by small-scale enterprises in developing countries, where the available insole materials are liable to delaminate and where locally tanned sole leather is more readily available than unit soles for each size and shape of last.

Some of the operations and equipment described in this section are used in two other methods of construction whereby the sole is attached by stitching. The first is known as the veldtschoen construction while the second is known as the welted construction. Neither of these methods of construction involves tack lasting of the complete shoe. The veldtschoen method rarely uses leather soles. The welted method is now almost exclusively used on expensive walking shoes for men which are unlikely to be made by small enterprises in developing countries. For these reasons, it was decided to describe the methods available for manufacturing tack-lasted stitched-on sole shoes only. Such shoes are often referred to as machine-sewn shoes.

Table III.4 shows the operation sequence that can be used to construct these shoes. The operations marked by an asterisk have been dealt with in Chapter II and are thus not discussed below.

II.1 Insole Preparation (Operation reference No. 36)

Insoles used on tack-lasted shoes require to be stouter than cemented insoles. The best insole material for this type of shoes is leather. Leather insoles are cut in the same way as leather soles, as described below. An often used substitute material is

Table III.4

Stages in the production of leather-upper, tack-lasted shoes with stitched-on leather soles

<u>Production stages</u>	<u>Op.Ref.</u>	<u>Operations</u>	<u>Major materials</u>
Upper cutting	1*	Cutting upper components	Skins and lining materials
Upper preparation	2* 3* 4* 5* 6* 7* 8*	Leather splitting Lining marking Stitch marking Hole punching Sock embossing Skiving Edge folding and cementing	
Upper stitching	9*	Stitching of uppers	Threads and tapes
Stitched upper finishing	10* 11* 12* 13* 14* 15* 16*	Seam reducing Taping Eyelet reinforcing Punching and eyelet insertion Temporary lacing General fitting and puff attaching Upper trimming	Tapes Eyelets String Trim, puffs
Bottom component preparation	36 37	Insole preparation Sole preparation	Insole board Sole leather
Making	38 20* 21* 39 23* 40 24* 26* 41 28* 42 43 44 45 46 47 48 49 50 51 30*	Insole tacking Stiffener insertion Upper conditioning Tack lasting Tack removal, inspection Bottom pounding Heat setting Shank attaching Bottom cementing Bottom filler insertion Sole laying Last removal Sole stitching Sole levelling Seat nailing Heel attaching Re-lasting Heel trimming Edge trimming Bottom finishing Last removal	Heel stiffeners Shanks Heels
Upper finishing	31*	Upper finishing operations and packing	Packing materials

The operations marked with (*) are discussed in the section dealing with leather-upper, cement-lasted shoes with cemented-on soles.

fiberboard. Insoles made with this material are cut according to the same techniques as those described for cemented-on soles. Insoles are further processed in the same way as fiberboard and composition soles used in cemented-on sole shoes.

II.2 Sole Preparation (Operation reference No. 37)

Small enterprises which sell their footwear at the lower end of the local market may find it unnecessary to subject soles to the full sequence of operations described below.

II.2.1 Sole cutting

(i) Description of sole cutting techniques

Hides used for soles come from the largest animals. Some manufacturing concerns only use the portion down the back of each side and either use the remainder for other applications or re-sell it. The cutting pattern is usually regular and disregards all but the very largest blemishes since it is considered more economical to discard defective soles than break the pattern to avoid damaged areas. Due to its thickness, sole leather can rarely be cut cleanly the whole way with a mechanical press. Consequently, soles are cut oversize and are then edge-pared before being attached to the shoe. Soles can also be hand clicked, and then hand pared.

(ii) Sole cutting equipment

Equipment for this operation includes beam presses with heavy cutting knives. Often, only one knife is used, the hide being turned over in order to make both left and right soles.

II.2.2 Evening

Highly mechanised factories use automatic evening and grading machines. These machines, in a single cycle, sense the thickness of the thinnest part of the sole and reduce the thickness of the remainder part to this thickness. They also stamp on a number corresponding to

the final thickness. It is then simple for the operator to sort the soles into boxes or piles. On simple evening machines, it is necessary to adjust the thickness manually. Evening can be also carried out manually.

II.2.3 Tempering

Tempering involves immersing the soles in clean water for an extended period to increase their workability. The operation can be greatly speeded up if a pressure vessel is used. In some systems, as much as a 100 bars pressure is used to force water into the soles. It is important that the temper is maintained until the soles have been attached.

II.2.4 Edge paring

The purpose of this operation has been described in the sole cutting section. Machines called planetary edge rounders can be used. They employ a vertical knife and two wooden templates (i.e. cum-clamps which grip the sole between them). The knife automatically follows the contour of the lower template and produces a clean edge. Performing the operation by a hand held knife requires effort and some skill to maintain a smooth, square edge.

II.2.5 Waist reducing

To give the soles a light appearance in the waist, the outside edges can be tapered in a manner similar to that used in skiving. Usually, about a quarter of the sole thickness is removed at the outside and the 20 mm. down the middle is left at full thickness.

II.2.6 Grading

This is an inspection operation in which the flexibility, grain, size and general quality of each sole is assessed, and suitable lefts and rights are matched up.

II.2.7 Channel cutting

(i) Process

To prevent the stitching on the grain side of the sole from rubbing against the ground, it is

recessed in a channel with a lip cemented over it. The channel is cut at an angle to the sole bottom from near the sole edge back in towards the middle. A small groove is cut at the bottom of the slit. The 'flap' is lifted before stitching and cemented back in place afterwards. As an alternative, to a channel, an open groove can be cut so that the stitches can be seen on the finished shoe. Care is required to keep stitches in the groove. More latitude is possible when stitching channelled shoes.

(ii) Channel cutting equipment

The equipment used for channel cutting is a hand cranked machine through which the sole is fed by a pair of rollers past a blade fixed at the required angle. By depressing a pedal, the operator can alter the angle at which the knife cuts at different points round the waist and forepart. Both the machine method and cutting with a hand held knife in a manner reminiscent of hand skiving require considerable skill.

II.2.8 Conforming

This operation moulds the sole to the shape of the last so that it fits snugly on the finished shoe. The alternative methods of doing this job are similar to those available for moulding insoles in the cemented-on construction.

II.2.9 Sole cementing

The upper, flesh side of the soles can be cemented at this stage with a neoprene or a resin based latex solution, and then dried.

II.3 Insole Tacking (Operation reference No. 38)

Insole tacking is carried out in a similar fashion as for cemented-on sole shoes, except that the last bottom has a steel plate over it which clenches the tips of the lasting tacks back into the top surface of the insole. Holes are left in the plate at the seat, waist

and on the forepart so that insoles can be temporarily attached by tacks driven into the wood. Some experience in placing the tacks is required since the holes in the plate cannot be seen during the operation.

II.4 Tack Lasting (Operation reference No. 39)

Although many shoes of this type are now lasted by other methods (e.g. cement-lasting or combinations of cement-seat, tack-side and cement-forepart lasting), this section describes techniques and equipment for tack-lasting the complete upper. Tack-lasting combined with stitched-on soles results in stiff, and rather inflexible foreparts. To compensate for this, additional 'toe spring' is often allowed for in the last used for this construction.

II.4.1 Manual lasting techniques

(i) Back tacking

Footwear is usually hand tack-lasted with a round vertical steel peg, or lasting jack, inserted into the socket on top of the last. In this position, the bottom of the insole provides an upwards facing surface ready for tacking. Pincers, incorporating a hammer head, similar to those used for cement-lasting, are normally used for this operation. After lining up the back-seam, the upper is tacked to the seat of the insole by one or two tacks.

(ii) Pulling over

Any lining material must always be pulled tight before pulling on the upper itself. Normally, the first lasting pull is straight over the toe. The pincers lever the lasting allowance of the upper over the toe of the insole. The thumb of the free hand holds the material while the pincers push a tack into position. The tack is then hammered down. This is basically the method used to insert all tacks, although in some cases it is necessary for the pincers to pleat and twist the margin to obtain a smooth feather-edge line. When soles are to be

stitched-on, tacks are placed well back from the insole edge to leave room for the stitching. Tacks are inserted on either sides of the toe to stretch the upper forward from the heel over the toe. The seat and forepart just ahead of the waist are then tacked.

(iii) Seat lasting

Strains are taken and tacks inserted alternatively at approximately 5 mm. intervals round one half, and then the other half of the seat. Small pleats are produced between each tack.

(iv) Toe lasting

The same procedure as for seat lasting is also used for toe lasting. More skill is generally required to remove puckers over the toe and to pleat the material neatly than is needed for seat lasting.

(v) Side lasting

Tacks are generally spaced at about 10 mm. intervals down the sides. Much less force is required for this operation than for lasting the seat and toe.

II.4.2 Tack lasting machinery

Small footwear manufacturing enterprises will not find it economical to invest in elaborate tack-lasting machines. However, where output levels exceed one hundred pairs per day, there may be a case for investing in relatively simple, manually-powered drafting and lasting machines. With machines of this type, the tacks are individually driven in by the operator. Two such machines cost approximately US\$8,000, and may also be used for cement-lasting if necessary. The essential difference between these two machines is that pincers are used on the drafting machines to take the initial strains over the toe, while wiper plates are used to assist toe- and seat-lasting on the second machines. Side tack-lasting is carried out by hand in either of these machines.

A type of machine which is used for side and waist lasting by large-scale enterprises can also be used to

completely tack-last shoes. In these machines, the operator holds the work up to the machine so that the lasting margin is gripped by a pincer. A knee operated lever can twist the pincers to the left or right as required and a wiper holds the margin while a tack is automatically driven. Simplified versions of these machines are available for tack side-lasting.

II.5 Bottom Pounding (Operation reference No. 40)

The lasting margins of stitched-on sole shoes do not need to be scoured. However, after cutting off any excess material inside the tack line, the pleats around the seat and the toe must be flattened. Special purpose machines are available but the operation can be carried out with a hammer having a large, slightly-domed face. To avoid damaging the feather-edge, the blows should be directed so that they have a slight inwards component.

II.6 Bottom Cementing (Operation reference No. 41)

The purpose of this operation is to hold the sole against the shoe bottom during sole stitching. This is done through the application of a latex solution usually applied by brush. The soles can then be loaded onto racks where the cement dries naturally. (See operation reference Nos 18 and 27 for Type 1 footwear).

II.7 Sole Laying (Operation reference No. 42)

The object of this operation is to attach the sole to the shoe bottom by adhesive and to form the sole round the lasted bottom so that they are in close contact during stitching. It is important that leather-soles are mellow during this operation.

Sole presses identical to those described for attaching cemented-on soles can be used. Alternatively, soles can be tacked or stapled in position with the fasteners positioned near the edge of the channel. Thus, they can be avoided during stitching and will not leave visible holes in the finished shoe once they are removed after stitching.

II.8 Last Removal (Operation reference No. 43)

The methods available for last-removal were dealt with in connection with cemented-on shoes. However, in

this case, there is no sole to provide support to the bottom and the lasts used are normally of the hinged type so that they 'break' at the waist. The use of such lasts reduces the risk of damaging in-soles, particularly when they are made of fibreboard.

II.9 Sole Stitching (Operation reference No. 44)

II.9.1 Channel opening

The channels round the edge of the soles are opened up at this stage. Machines are available, but opening can be carried out by hand after the top surface of the lip has been moistened with a sponge to increase its plasticity.

II.9.2 Stitching

(i) Stitching techniques

All stitching machines have a swivelling horn placed inside the shoe and through which waxed thread is fed. The wax, which may be pre-heated, helps waterproof the sole. In chain stitching machines, the needle is hook shaped so that it can catch the thread when at the bottom of its stroke. It then pulls the loop through the layers of insole, upper and sole on the upstroke. It then links the loop into the chain with the preceding loop.¹ Considerable skill is required to keep stitches vertical and the line of stitching in the bottom channel, particularly around the toe curve. After traversing from the waist round to the other side of the sole, keeping about 3mm. from the edge of the insole, the operator cuts off any excess thread.

(ii) Equipment

Although machines have been used in this operation for over a hundred years, they are still expensive. Both chainstitching and lockstitching machines are available.

¹Stitching configurations are illustrated in Appendix I(Glossary of terms).

New motor driven chainstitching machines can cost up to US\$4,000. Alternatively, small enterprises may buy less expensive used machines.

II.10 Sole Levelling (Operation reference No. 45)

In this operation, the channel and lip are cemented, usually with brush applied latex. After drying, the lip is moistened to soften it and is then rubbed down with a metal bar. The shoes may require re-lasting before this operation, using a last smaller than the making last. The metal bar should be rust proof since iron can leave rust stains on the damp leather. Alternatively, this operation may be carried out with machines fitted with a rotating indented wheel. These machines reduce considerably the time needed for this operation.

To restore the curve of the waist, the shoe can then be mounted in a sole press with a female mould to compress the layers of material on the shoe bottom. Special purpose presses are available for this purpose whereby the shoe is mounted on a cast iron footform. It is then forced into a concave mould made from a non-corrosive alloy. Any press with a force of about four tonnes which may be gradually applied may be used for this operation.

II.11 Seat Nailing (Operation reference No. 46)

The back of the sole is attached to the shoe by a semi-circle of nails driven from the outside. The nails pass through the sole, the lasted margin of the upper and the insole and are finally clenched on a flat topped iron horn on which the inverted shoe rests. The operation can be carried out by hand or on a special purpose nailing machine.

Surplus material is then trimmed from the edge of the sole around the seat. This rough rounding operation can be done manually with a knife. Alternatively, the excess material may be ground away with an abrasive covered wheel or on a special purpose disc knife. The wheel or the disc knife may be incorporated into a seat nailing machine so that both operations are carried out simultaneously.

II.12 Heel Attaching (Operation reference No. 47)

When heels are built from stacked leather or leatherboard, they can be cut and built by hand with nails. However, the best results are obtained if a heavy load is used to compress the stack before nailing.

Since the shoes are unlasted at this point, they can be attached by nails driven from either inside or outside the shoe. Usually, the nail heads are on the inside of women's shoes and on the outside of men's shoes.

The nails attaching the heel can be driven manually or by special purpose machines. Heel attaching nails usually have rows of corrugations round them which helps provide a firm grip. Top pieces can be nailed or stapled onto the heel.

II.13 Re-lasting (Operation reference No. 48)

In this operation, lasts are put back into the shoes. Hinged lasts smaller than the making lasts are usually used to simplify their subsequent removal.

II.14 Heel Trimming (Operation reference No. 49)

The uneven edges of built heels can be smoothed and shaped by rough scouring on a emery covered wheel. Alternatively, a special purpose cutting machine called a heel parer can be used. The latter is preferred when heels with backward sloping concave curves are required on women's shoes.

Heel paring machines are fitted with rotating cutters consisting of a pair of knives shaped to the required contour. These cutters rotate at a very high speed. The top piece and the sole top edge act as guides for the shoe on either side of the cutter blades during paring.

II.15 Edge Trimming (Operation reference No. 50)

The edge of the sole around the forepart is trimmed back in preparation for the finishing operation. The edge is moistened to aid the operation.

Excess sole leather can be removed manually with a knife. Alternatively, special purpose machines costing

about US\$300 are available. These machines have a guarded rotating knife. The operator guides the edge of the upper past this knife.

II.16 Bottom Finishing (Operation reference No. 51)

Unless soles and heels are prefinished, a substantial amount of work remains to be carried out on them. The operations involved are described in some detail, since the view that a consumer forms of the quality of leather soled shoe is possibly influenced as much by the finish on the sole as by that on the upper.

The traditional bottom finishing sequence is very elaborate and includes several variants. However, it is rarely followed completely. A comprehensive sequence of operations is described below. Whenever appropriate, simple alternatives to the types of machines that are employed in large scale factories in developed countries are described.

II.16.1 Heel scouring

This operation removes marks left after heel paring, and polishes the surface. Usually, rough and fine grades of scouring paper are used. The work can be done by hand, or, preferably with a rotating wheel fitted with a felt backing on which is placed the scouring paper.

A number of machines, equipped with steel wheels that open into two halves to permit the ends of the felt and paper to be gripped are available. Sometimes, felts and paper are contoured to the heel shape and cut to a width that corresponds to the heel height. Square heels require only flat papers and felts. These can be cemented to the circumference of a wooden wheel, belt driven by a small motor (see figure II.11). A bicycle can also be adapted to provide the drive by removing the rear tyre, and clamping the frame in an upright position. A continuous belt drive taken around the back wheel and then around a small pulley on the wheel shaft completes the adaptation.

II.16.2 Heel dyeing

A spirit based dye of the required colour is applied with a fine hair brush. Sometimes, a wide brush is used

for the heel and a narrow one for the top edge of the sole. Since the heel fibres open when wetted by dye, a second coat containing a small quantity of filler may be applied.

II.16.3 Fine heel scouring

Very worn fine scouring paper can be used at this stage to restore the surface roughened as a result of swelling during dyeing.

II.16.4 Edge inking

A soft toothbrush may be used to ink the top, flesh and surface of the sole next to the upper. The ink has more filler than that used for dyeing. To avoid the inadvertant application of ink to the upper, this operation is sometimes carried out before sole attaching.

II.16.5 Edge setting

This is an important operation since unset leather sole edges are very porous. Hand edge setting involves applying melted stick wax or wax in an emulsion with water to the sole edge. It is then rubbed with a pre-heated iron back and forth to polish and force the wax into the edge. Often, the process is repeated to obtain the desired degree of smoothness and water resistance. Flat edges can be set using any hard and smooth round object.

The irons used for rubbing the wax have their nose shaped to a slightly exaggerated reverse contour of the trimmed sole edges in one plane, and are slightly convex in the other plane. For flat edges, a wooden or plastic disc that is free to rotate on a length of bar, or even a round glass bottle, will suffice. Machines with heated oscillating irons are available. Irons are also often fitted to finishing machines that are used by repair workshops in developed countries.

II.16.6 Heel burnishing

Heel burnishing involves a number of operations, including: applying a hard wax to the heel with a rough cloth, producing a dull polish with a finer fabric; and finally producing a high polish with a brush or mop. Alternatively, a simple machine with three

driven wheels carrying progressively finer cloths may be used for these operations.

II.16.7 Seat wheeling

This is a traditional operation that only performs a decorative function. It is now only applied to expensive men's shoes. The result of the operation is a narrow line of small vertical indentations round the seat at a level that overlaps the sole and heel. It is carried out with a handle carrying a freely rotating wheel with a milled edge. A lip to register against the upper edge of the sole acts as a guide.

II.16.8 Bottom scouring

The purpose of this operation is to produce a smooth clean surface in preparation for finishing the sole bottom. Two grades of scouring paper are used. They can be either mounted on the circumference of a driven wheel or wrapped round flat wooden blocks. When scouring by hand, a circular motion should be applied in order to avoid a grained effect. On some machines, the rotating cylinders reciprocate from side to side to produce a similar effect to hand scouring. If the leather is dry during this operation its surface structure can be damaged.

II.16.9 Naumkeaging

The purpose of naumkeaging is to scour the curved waist of leather soles. The equipment for this operation is often mounted on a vertical shaft at one end of proprietary finishing machines. It consists of a conical wheel round which scouring paper is secured. For hand scouring, the scouring paper can be wrapped around a suitably shaped piece of wood.

II.16.10 Bottom staining

Shoe bottoms can be finished in several ways, but only staining is considered here. In small enterprises, the stain - which can contain some wax - is painted on with two or three strokes of a soft wide brush.

II.16.11 Bottom burnishing

Once the stain has dried, the bottom of the sole is burnished with wax and cloth in a manner similar to that employed to burnish heels.

II.16.12 Bottom inspection

Some rectification of the bottom finishing work may be required. Melted wax and heated irons can be used to hide minor defects. After last removal, the soles may be branded on the waist or forepart. As described in the context of insole marking, the impression can be produced directly with a heated metal die or with embossing foil.

II.17 Tables of Technical Data

Tables III.5 and III.6 provide estimates of the needed workforce for the selected four scales of production, and the type, number and cost of the pieces of equipment required for each scale.

Table III.5

Workforce allocation at each output level
for Type 3 footwear

(Jobs are shared by operatives in some cases)

Op. Ref No.	Operations	Scale 1 8prs/8hrs	Scale 2 40prs/8hrs	Scale 3 200prs/8hrs	Scale 4 1000prs/8hrs
1	*Cutting uppers	0.8 s	1.5 s	6 s	16 s
2	*Leather splitting				1 ss
3	*Lining marking		1.0 ss	1 us	1 us
4	*Stitch marking				3 us
5	*Hole punching			2 ss	1 ss
6	*Sock embossing				2 ss
7	*Skiving			2 ss	4 ss
8	*Edge folding/cementing				3 us
9	*Stitch uppers	1.0 s	2.0 s	9 s	40 s
10	*Seam reducing		1.0 s	1 us	1 us
11	*Taping				1 us
12	*Eyelet reinforcing			1 us	1 us
13	*Punch/eyelet insertion				1 us
14	*Temporary lacing			3 s	2 us
15	*General fitting and puff insertion				2 ss
16	*Upper trimming				8 s
36	Insole preparation	1.0 s	1.0 ss	3 ss	4 ss
37	Sole preparation				4 ss
38	Insole tacking		2.0 s	2 us	1 us
20	*Stiffener insertion				1 us
21	*Upper conditioning				
39	Tack lasting			4 s	10 s
23	*Tack removal and inspection		1.0 ss	2 ss	2 ss
40	Bottom pounding				2 ss
24	*Heat setting				1 us

Table III.5 (cont'd)

Op. Ref No.	Operations	Scale 1 8prs/8hrs	Scale 2 40prs/8hrs	Scale 3 200prs/8hrs	Scale 4 1000prs/8hrs
26	*Shank attaching	0.2 us	0.5 us	1 us	1 us
27	*Bottom cementing				2 us
28	*Bottom filling	1.0 s	2.0 s	1 ss	1 us
42	Sole laying				3 ss
43	Last removal				1 us
44	Sole stitching			1 s	2 s
45	Sole levelling				1 ss
46	Seat nailing			3 ss	3 ss
47	Heel attaching				2 ss
48	Relasting				1 us
49	Heel trimming	0.5 s	2.0 s	1 ss	1 ss
50	Edge trimming				1 ss
51	Bottom finishing			2 s	8 s
30	*Last removal				1 us
31	*Upper finishing	0.5 s	1.0 s	4 s	14 s
<u>TOTAL DIRECT WORKERS</u>		5	15	49	151

*See Type 1 equipment specifications for these operations.

s = skilled (4 months training)

ss= semi-skilled (3 weeks training)

us= unskilled (1 week training)

Table III.6

Methods and equipment specifications for
Type 3 footwear

Output per day: 8, 40, 200 and 1000 pairs

Type: Leather-upper, tack lasted shoes with
machine-sewn leather soles

Op. Ref No.	Operations and Major Equipment required	Equipment source ¹	No. required by scale ²				Estimated unit cost (\$)
			1	2	3	4	
1-16	See Type 1 footwear at same scale						
36	<u>INSOLE PREPARATION</u>						
	- clicking bench	local	OP1	1	2	1	30
	- clicking board	local	-	1	-	-	15
	- mechanical swing arm clicking press	Sup.list 1	-	-	1	1	2,200
	- press knives	Sup.list 1	-	-	30	-	40
	- insole moulding and sole conforming mach.	Sup.list17	-	-	-	1	8,000
	- insole bevelling machine	Sup.list17	-	-	-	1	2,500
37	<u>SOLE PREPARATION</u>						
	- clicking bench	local	OP1	1	1	-	30
	- clicking board	"	-	1	-	-	15
	- tempering tank	local	1	1	1	1	50
	- paring and channeling knives	local	-	5	5	-	6
	- mechanical swing arm clicking press	Sup.list1	-	-	OP36	1	2,200
	- bench for waist reducing, bottom cementing and channel cutting	local	-	1	1	1	30
	- sole evening machine	Sup.list37	-	-	1	1	1,800
	- sole rounding machine	Sup.list37	-	-	-	1	7,000
	- manually powered channel cutter	Sup.list37	-	-	-	1	1,000
	- mechanical swing arm clicking press	Sup.list 1	-	-	OP36	-	2,200
38	<u>INSOLE TACKING</u>						
	- tacking bench	local	1	1	1	1	25
	- tubular steel jack	local	1	1	1	2	5

Table III.6 (cont'd)

Op. Ref No.	Operations and Major Equipment required	Equipment source	No required by scale				Estimated unit cost (\$)
			1	2	3	4	
20-21	See Type 1 footwear at same scale						
39	<u>TACK LASTING</u>						
	- lasting bench	local	OP38	1	1	2	25
	- jack (mounted on bench)	local	-	-	1	2	5
	- lasting pincers hammers and knives	Sup.list 22	4	-	20	-	4
	- hand tacking tool	Sup.list 22	-	-	1set	1set	1,000
	- manually operated drafting machine	Sup.list 22	-	-	1	-	3,000
	- manually operated lasting machine	Sup.list 22	-	-	1	-	5,000
	- back part moulding machine	Sup.list 22	-	-	-	1	10,500
	- pulling and lasting machine	Sup.list 22	-	-	-	1	18,000
	- tack side lasting mach.	Sup.list 22	-	-	-	1	6,000
	- tack seat lasting mach.	Sup.list 22	-	-	-	1	15,000
23	See Type 1 footwear at same scale						
40	<u>BOTTOM POUNDING</u>						
	- lasting bench	local	OP38	1	-	-	25
	- lasting jack	local	-	1	-	-	5
	- scouring buff without dust extractor	Sup.list 25	-	-	1	-	400
	- bottom roughing mach.	Sup.list 25	-	-	-	2	2,400
24,26,28	See Type 1 footwear at same scale						
42	<u>SOLE LAYING</u>						
	- bench	local	OP26	1	1	1	25
	- manually powered sole press	Sup.list 29	1	1	1	-	1,900

Table III.6 (cont'd)

Op. Ref No.	Operations and major equipment required	Equipment source	No. required by scale				Estimated unit cost (\$)
			1	2	3	4	
42	<u>SOLE LAYING</u> - twin station hydraulic sole press	Sup.list 29	-	-	-	2	8,000
43	<u>LAST REMOVAL</u> - tubular steel jack	local	1	1	1	1	5
	- bench	local	-	-	-	1	25
44	<u>SOLE STITCHING</u> - lock stitch insole sewing machine (This operation could be performed in a central facility serving several small enterprises)	Sup.list 44	1	1	1	2	6,000
45	<u>SOLE LEVELLING</u> - manually powered sole press using sole levelling plates		OP42	OP42	OP42	-	
	- twin station sole press with sole levelling plates	Sup.list 29	-	-	-	1	8,500
46	<u>SEAT NAILING</u> - bench	local	OP26	1	1	-	25
	- tools for nailing and edge paring	Sup.list 1	-	3	5	-	7
	- loose nailing and rounding machine	Sup.list 46	-	-	-	1	3,000
47	<u>HEEL ATTACHING</u> - bench	local	OP26	OP46	-	-	
	- manually operated heel attaching machine	Sup.list 47	-	-	1	-	1,600

Table III.6 (cont'd)

Op. Ref. No.	Operations and major equipment required	Equipment source	No. required by scale				Estimated unit cost (\$)
			1	2	3	4	
47	<u>HEEL ATTACHING</u> - heel nailing machines for heel building and heel and top piece attaching	Sup.list 47	-	-	-	1	9,000
48	<u>RELASTING</u> - bench	local	OP26	OP46	OP46	1	25
	- tubular steel jack	local	-	1	1	-	5
49	<u>HEEL TRIMMING</u> - trimming bench	local	1	1	1	-	25
	- heel paring machine	Sup.list 49	-	-	-	1	4,000
50	<u>EDGE TRIMMING</u> - trimming bench	local	OP49	OP49	OP49	-	25
	- sole trimming machine	Sup.list 50	-	1	1	-	300
	- edge trimming machine	Sup.list 50	-	-	-	1	1,200
51	<u>BOTTOM FINISHING</u> - bottom finishing mach. with edge irons scouring wheels, mops and brushes (can be shared with small-scale ent.)	Sup.list 51	1	1	1	4	5,500
	- hand work bench for drying, inking and staining	local	-	1	1	1	25
30-31	See Type 1 footwear at same scale						

¹See equipment suppliers list in Appendix II.

²The same pieces of equipment may be used in a number of operations. This is indicated by reference to the number of the operation where the equipment is used for the first time.

III. TYPE 4 FOOTWEAR: WELDED SYNTHETIC UPPER,
STRING LASTED SHOES WITH MOULDED-ON SOLES

Type 4 footwear is a welded synthetic upper, string lasted shoe with moulded-on sole. It is a substitute for leather upper shoes with cemented-on soles, to which it bears a superficial resemblance. As an upper material, PVC has a number of disadvantages: it is impermeable and does not therefore absorb sweat or allow it to escape, and lacks the wear resistant qualities of leather.

A process route for this type of footwear is outlined in Table III.7. Operations already dealt with in relation with footwear type 1 are marked with asterisks.

Usually, the PVC sheet that forms the upper material has a woven fabric backing. The seams are produced by means of high potential, high frequency electrical power under pressure. Rapid changes in the polarity of the particles that make up the material causes internal friction. This friction heats the material to above its melting point, and weld layers together.

Table III.7

Stages in the production of welded synthetic upper, string-lasted shoes with moulded-on soles

Production stages	Op.Ref.	Operations	Major materials
Upper cutting and welding	52	Cutting and welding uppers	PVC uppers and lining materials
	53 54 14* 17* 6*	Upper welding Lasting string attaching Temporary lacing Sock cutting Sock embossing	Lasting string String PVC or board socking
Lasting and moulding	20* 55 56	Stiffener insertion String-lasting and moulding-on Sock insertion	Heel stiffeners Sole raw materials Socks
Upper finishing	31*	Upper finishing operations, packing	Packing materials

The operations marked (*) are discussed in the section dealing with leather-upper, cement-lasted shoes with cemented-on soles.

The output capacities of the equipment described in the remaining part of this section are relatively high. Thus, although capital investments are also high, unit production costs are generally low. This type of shoes may, therefore, be particularly suitable for low to middle income groups in developing countries although the manufacturing processes are relatively capital-intensive.

III.1 Cutting and Welding Upper Components (Operation reference No. 52)

(i) Processing techniques

Upper components may be cut in the conventional manner with knives. Alternatively, heat cutting and welding can both be performed on a single machine. The machine can be fitted with a material roll feed unit enabling two thicknesses of material to be cut to shape as well as welded together during the operation. Thus, the back parts of the upper can be welded to a lining material round their top lines to form pockets for stiffeners. Similar arrangements can be made to locate toe puffs.

(ii) Equipment

Typical machines of the type described above have open fronted twin station welding areas approximately fifty centimeters square. Two work stations can be arranged on the table so that an operator can unload work at one station while a welding cycle takes place at the other. Power requirements on such machines are three kilowatts for the press and ten kilowatts for the generator needed for the high frequency welding operations. This type of machine is often operated for two or three shifts a day in developed countries.

III.2 Welding Upper Components Together (Operation reference No. 53)

The type of machine used for this operation works on the same principle as the cutting and welding machine described above, but is smaller and consumes a total of about four kilowatts. Operations performed by this type of machines replace the conventional closing operations on shoe uppers performed by means of stitching. A variety

of welding tools is required for operations such as side and back seam welding and for tongue attaching.

III.3 Lasting String Attaching (Operation reference No. 54)

Lasting string is made from strong, loosely twisted cord. It is held in position around the lasting margin of the shoe by a run of overlock chainstitch loops. This allows the string to run freely through them.

Specially adapted conventional stitching machine or stitchers of the type used for glove manufacturing are suitable for this operation.

III.4 String Lasting and Moulding-On of Soles (Operation reference No. 55)

Shoes with directly moulded-on soles can be string lasted immediately before sole moulding on metal foot-forms attached to the machines. Usually, stiff socks-cum-insoles, which cover the whole bottom, are inserted after moulding.

III.4.1 String lasting

String lasting is becoming increasingly popular for lasting light leather upper materials onto conventional insoles, using wooden or plastic lasts, prior to cementing-on sole units. Lasting involves pulling the two ends of the string tightly so that the lasted margin bunches in over the sole of the last and stretches the upper down onto it. The lasting string may run either once around the lasting margin or twice around the forepart and once around the seat. Operators should wear a leather glove for protection when lasting is performed manually. Pneumatically powered string hauling equipment is available.

III.4.2 Moulding

The lasting margin of synthetic uppers is solvent wiped prior to moulding. The sole moulding process is similar to the one described for conventionally lasted shoes with moulded-on soles.

Equipment

Moulding machines are used for this operation. They are often single or twin station machines, having two or three metal footforms per station. One footform is used for string lasting while the second footform moulds-on the sole. Soles may cool on a third footform if one is included. The footforms are indexed between moulding cycles. The waists of the footforms may have magnetic inserts so that steel stiffening shanks placed on them can be incorporated into the upper surfaces of the soles. Alternatively, arrangements of spikes can be used to locate wooden shanks.

III.5 Sock Insertion (Operation reference No. 56)

In situations where the soles are to be moulded-on immediately after string lasting, insoles need not be lasted into the shoes. Instead, socks of a heavy substance can be used to line the whole inside of the shoe's soles. These socks are cemented to the top surface of the soling material and blank off any cavities moulded into the top of the sole for lightening purposes. Inserting these stiffeners can be time consuming due to their size and stiffness.

Following this operation, the shoe is ready for finishing and packing. This latter operation is the same as that used for the previous types of footwear.

III.6 Tables of Technical Data

Table III.8 provides estimates of labour requirements for the selected scales of production, while Table III.9 lists the type and number of tools and equipment needed for each production scale.

Table III.8

Workforce allocation at each output scale for
Type 4 footwear

Note : Where an operative is only required part-time on an operation the work is split.

This construction is unlikely to be used at output levels of 8 and 40 pairs per day.

Op. Ref No.	Operations	Scale 1 8prs/8hrs	Scale 2 40prs/8hrs	Scale 3 200prs/8hrs	Scale 4 1000prs/8hrs
52	Cutting and welding uppers	-	-	1 ss	2 ss
53	Upper welding	-	-	1 ss	2 ss
54	Last string attaching	-	-		2 ss
14	*Temporary lacing	-	-	1 s	2 us
17	*Sock cutting	-	-		3 ss
6	*Sock embossing	-	-		2 ss
20	*Stiffener insertion	-	-		1 us
55	String last and moulding-on	-	-	1 s	3 s
56	Sock insertion	-	-		2 us
31	*Upper finishing and packing	-	-	2 s	7 s
	TOTAL: DIRECT WORKERS	-	-	6	26

*See Type 1 equipment specification for these operations.

s = skilled (4 months training)

ss = semi-skilled (3 weeks training)

us = unskilled (1 week training)

Table III.9

Methods and equipment specifications for Type 4 footwear

Output per day: 200 and 1000 pairs of shoes

Type: Welded synthetic upper, string-lasting shoes with moulded-on soles

Op. Ref No.	Operations and Major equipment required	Equipment source	No. required by scale		Estimated unit cost (\$)
			3	4	
52	<u>UPPER CUTTING AND WELDING</u> - twin station welding and cutting machine, generator and cutting and welding tools	Sup.list 52	1	2*	34,000
53	<u>UPPER WELDING</u> - seam welding machine with tools	Sup.list 52	1	2	8,000
54	<u>LAST STRING ATTACHING</u> - overlock chain stitching machine	Sup.list 54	1	2*	1,600
14,17 6,20	See Type 1 footwear at same scale				
55	<u>STRING LASTING AND MOULDING-ON</u> - sets of moulds and foot-forms - preheater - granulator - single station PVC injection moulding-on machine - twin station PVC moulded-on machines - last string pullers	Sup.list 35 Sup.list 35 Sup.list 35 Sup.list 35 Sup.list 35 Sup.list 35	8 1 - 1 - -	12 2 1 - 2* 2	2,125 800 1,400 23,000 35,000 1,000
56	<u>SOCK INSERTION</u> - hand fitting and cementing at bench	local	1	2	25
31	See Type 1 footwear at same scale				

*A single machine is needed when used on a two-shift basis.

IV. TYPE 5 FOOTWEAR: STITCHED SYNTHETIC UPPER, CEMENT-
LASTED SANDALS AND CASUAL SHOES WITH BUILT OR UNIT SOLES

The type of footwear considered in this section are stitched synthetic upper, cement-lasted sandals and casual shoes with built or unit soles. While the majority of the footwear of this type is manufactured for the women's market, none of the constructions covered are exclusively used for either women's or men's footwear. Shoes of the flip-flop and buckling types, with stitched synthetic uppers and with either flat or raised heels comes under the type 5 footwear. They typically have a PVC coating and a woven fabric backing. However, few changes to the basic sequence of operations would be required if leather rather than synthetic uppers were used, or if men's or children's sandals were to be produced.

In tropical climates, a large proportion of the demand for women's shoes often consists of plastic casual and sandals produced by injection moulding machines. This latter type of footwear - described in the following section of this chapter - is mostly marketed among low-income groups. On the other hand, the type of footwear described in this section are more likely to be marketed among middle-income groups.

The process sequence is shown in Table III.10. Only the five operations that are unique to this type are discussed below since the other operations have already been dealt with earlier.

IV.I Sole and Insole Preparation (Operation reference
No. 57)

Outsoles can be cut to shape from sheets of rubber or resin and man-made composite materials. This may be done by hand or with the assistance of a press. Insoles preparation is similar to that for cement-lasted, cemented-on construction, with the exception of the following: (i) the bevelling of the edge of the insole backpart is unnecessary on open backed shoes, (ii) a binding of fabric or of upper material may be cemented around the edge of the insole if it were to show on the finished sandal, and (iii) the bottom of the insole may be reduced in thickness in areas where straps must be lasted to it.

Table III.10

Stages in the production of stitched synthetic upper cement-lasted sandals and casual shoes with built or unit soles

<u>Production stages</u>	<u>Op.ref.</u>	<u>Operations</u>	<u>Major materials</u>
Upper cutting	1	*Cutting upper components	Sheets of upper materials
Upper preparation	3	*Lining marking	
	4	*Stitch marking	
	5	*Hole punching	
	6	*Sock embossing	
	7	*Skiving	
	8	*Edge folding and cementing	
Upper stitching	9	*Stitching of uppers	Threads and tapes
Stitched upper finishing	10	*Seam reducing	Tapes Trim, puffs
	11	*Taping	
	15	*General fitting/attaching	
	16	*Upper trimming	
Bottom component preparation	57	Sole and insole preparat.	Sole units and insole sheet
	58	Heel preparation	Heels
Making	19	*Insole tacking	Heel stiffeners Shanks Felt
	20	*Stiffener insertion	
	21	*Upper conditioning	
	59	Lasting uppers	
	23	*Tack removal/inspection	
	25	*Bottom roughing	
	26	*Shank attaching	
	27	*Bottom cementing	
	28	*Bottom filler insertion	
	29	*Sole laying	
	30	*Last removal	
	60	Heel attaching	
	61	Sole finishing	
Upper finishing	31	*Upper finishing and packing	Packing materials

The operations marked with () are discussed in the section dealing with leather-upper, cement-lasted shoes with cemented-on soles.

IV.2 Heel Preparation (Operation reference No. 58)

Prevailing fashions determine if women's casual shoes may have prefinished sole units, wedge or flat soles or separate soles and heels. It is nowadays unusual to carry out the finishing of the heels of women's shoes after they have been attached since most heels are made of wood or plastic covered with material which matches or contrasts with the upper. Even when heels are built from stacked leatherboard, they are prefinished before attaching.

When mould parting lines are not evident (as they may be on some type of plastic heels), heels may be painted by hand or sprayed with cellulose paint. Cementing operations associated with heel covering are, usually, carried out by hand.

IV.3 Lasting Uppers (Operation reference No. 59)

Lasting this type of footwear is much simpler than for other types of footwear since open work uppers do not require lasting at the toe and heel. The lasting techniques vary with style, but they only involve the pulling of pre-heated uppers over the lasts followed by side-lasting onto the insoles. For example, they are not needed in cases where the upper consists of two narrow straps fed through slots cut in the insoles and cemented to the insole bottom.

IV.4 Heel Attaching (Operation reference No. 60)

When separate heels are used, they are usually attached to the insole by a maximum six nails driven out into the heel through the insole. Heel attaching can be done by hand or by machine. Simple, manually operated machines costing US\$700 are available. They can attach a heel in about one minute. Hand nailing takes longer and requires skills whenever high heels are used.

IV.5 Sole Finishing (Operation reference No. 61)

Where laminated sole or heel units are built up, or when pre-cut outsoles or heels are attached to insoles so that their edges are exposed on the completed footwear, mismatches on the edges usually need trimming and smoothing.

Operators require considerable skill to produce a neat finish regardless of the type of machinery used. Simple, inexpensive machines of a type used by shoe repairers in developed countries may be used for this operation. These machines are usually bench mounted and driven by small electric motors. Elaborate machines are also available. Their use may not, however, be justified for conditions in developing countries.

IV.6 Tables of Technical Data

Tables III.11 and III.12 provide estimates of labour requirements for the four selected scales of production, and the estimated number of pieces of equipment needed for the additional operations used in the production of Type 5 footwear.

Table III.11

Workforce allocation at each output scale
for Type 5 footwear

Op. Ref No.	Operations	Scale 1 8prs/8hrs	Scale 2 40prs/8hrs	Scale 3 200prs/8hrs	Scale 4 1000prs/8hrs	
1	*Cutting uppers	0.7 s	1 s	5 s	16 s	
3	*Lining marking			1 us	1 us	
4	*Stitch marking				3 us	
5	*Hole punching		1 ss	2 ss	1 ss	
6	*Sock embossing				2 ss	
7	*Skiving				1 ss	1 ss
8	*Edge folding/cementing				2 us	
9	*Stitching uppers		1.0 s	2 s	8 s	36 s
10	*Seam reducing	1 s		2 s	1 us	
11	*Taping					
15	*General fitting and puff attachment				1 ss	
16	*Upper trimming				5 s	
57	Prep. sole and insole	0.3 ss		1 ss	1 ss	4 ss
58	Heel preparation		1 ss			
19	*Insole tacking	1.0 s	1 s	1 us	1 us	
20	*Stiffener insertion				1 us	
21	Upper conditioning					
59	Cement lasting			1 s	5 s	
23	*Tack removal/inspection			1 ss	2 ss	
25	*Bottom roughing				2 ss	
26	*Shank attaching			1 s	2 ss	1 us
27	*Bottom cementing					2 us
28	*Bottom filling					1 us
29	*Sole laying					2 ss
30	*Last removal	1 us				
60	Heel attaching	1 s	2 ss			
61	Sole finishing			4 s		
31	*Upper finishing		1 s	3 s	10 s	
	TOTAL DIRECT WORKERS	3	9	29	108	

Note: Where an operative is only required part time on an operation, the work is split.

*See type 1 equipment specifications for these operations.

s = skilled (4 months training)

ss = semi-skilled (3 weeks training)

us = unskilled (1 week training)

Table III.12

Methods and equipment specifications for
Type 5 footwear

Output per day: 8, 40, 200 and 1000 pairs

Type: Stitched synthetic upper cement-lasted shoes with
cemented-on built and unit soles

Op. Ref No.	Operations and Major Equipment required	Equipment source <u>1/</u>	No. required by scale ^{2/}				Estimated unit cost \$
			1	2	3	4	
1-16	See Type 1 footwear at same scale						
57	<u>PREPARATION OF SOLES AND INSOLES</u>						
	- clicking bench	local	OP1	1	1	1	25
	- clicking press	Sup.list 1	-	-	1	2	2,200
	- press knives	Sup.list 1	-	-	20	60	40
	- cutting knives	Sup.list 1	3	3	-	-	6
	- cutting board	local	-	1	-	-	15
	- insole moulding mach.	Sup.list 17	-	-	-	1	8,000
58	<u>PREPARATION OF HEELS</u>						
	- clicking bench	local	OP57	OP57	OP57	OP57	
	- manually operated heel attaching machine for heel building	Sup.list 47	-	-	1	-	2,500
	- heel attaching machine	Sup.list 47	-	-	-	1	10,800
19-21	See Type 1 footwear at same scale						
59	<u>CEMENT LASTING</u>						
	- bench	local	OP19	OP19	1	3	25
	- lasting pincers and knives	Sup.list 22	3	6	10	40	4
	- jacks	local	-	-	1	6	5

Table III.12 (cont'd)

Op. Ref No.	Operations and Major Equipment Required	Equipment source ¹	No. required by scale ²				Estimated unit cost \$
			1	2	3	4	
"*+ 23,25 30 60	See Type 1 footwear at same scale <u>HEEL ATTACHING</u>						
	- manually operated heel-attachment for sole press	Sup.list 29	1	-	-	-	600
	- manually operated heel attaching machine	Sup.list 47	-	1	1	-	2,200
	- heel attaching machine	Sup.list 47	-	-	-	1	10,800
61	<u>SOLE FINISHING</u>						
	- sole trimming machine on bench	Sup.list 50	1	-	-	-	300
	- edge finishing wheel on powered buff without dust extraction	Sup.list 25	1	-	-	-	400
	- bottom finishing machine with edge irons, scouring wheels, mops and brushes*	Sup.list 51	-	1	1	3	5,500
	- hand work bench for inking and drying of heels	local	-	-	1	1	25
31	See Type 1 footwear at same scale						

¹See equipment suppliers list in Appendix II.

²The same pieces of equipment may be used in a number of operations. This is indicated by reference to the number of the operation where the equipment is used for the first time.

*May be shared by several small enterprises.

V. TYPE 6 FOOTWEAR: SINGLE INJECTION, MOULDED PLASTIC SANDALS

Single injection moulded plastic sandals are typically of the 'flip-flops' type, with broad straps across the forepart and completely open backparts and toes. Closed sandal designs are sometimes produced, but may not look attractive unless the tooling quality is very high. The main merit of sandals of this type is that they are inexpensive. On the other hand, they have a number of disadvantages when compared to leather sandals: they do not absorb sweat, are difficult to repair and require a large capital investment in machining and tooling for their production.

The various operations specific to the production of plastic sandals are briefly described below.

V.I Single Injection Moulding Technique and Equipment
(Operation reference No. 62)

In the production of moulding, melted PVC is injected into a split metal mould. The process is very similar to that used for the direct moulding-on of soles to pre-lasted uppers. However, in the case of single injection moulding, the moulds incorporate spaces which allow the melted PVC to form both the uppers and the soles. After solidification of the melted plastic, the mould is opened and the finished moulding ejected. The moulding and cooling cycle time varies with the weight of the material injected, the amount of mould cooling applied and the shape of the moulding. Once the best settings and the automatic cycle have been established, it is only necessary for the machine operator to fill up the raw material hopper and to remove any flash from the mouldings. If the range of moulds on the machine does not cover the full range of sizes and styles that are required, it will be necessary to change moulds occasionally. The colour of the PVC granules may also be changed from time to time.

After moulding, sandals have any trim added and are then inspected and packed.

Since PVC is thermoplastic, mould runners, sprues, and flash can be regranulated and fed back into the process.

The moulding operation is the only important operation in the production of plastic sandals, the other

operations consisting of packaging and re-granulating of PVC wastes.

Various types of single injection moulding machines are available on the market. The choice of machine will depend on the selected batch and market sizes. These determine which of the available single-station, twin-station or multi-station machines are the most appropriate ones. In general, whenever the product mix is very wide and the batch sizes and total volumes of output are small, single station or twin station machines are likely to be more economically efficient than multi-station machines. The former machines may also be used by large-scale enterprises for the completion of small orders or the carrying out of tooling trials.

V.2 Tables of Technical Data

Tables III.13 and III.14 provide estimates of the required labour force and equipment. Given the high capital-intensity of the production process, single injection moulding may not be adopted for scales of production lower than 200 pairs per day. Thus, no data is provided for scales 1 and 2.

Table III.13

Workforce allocation at each output level for
Type 6 footwear

Note 1: Where an operative is only required part time on an operation, the work is split.

Note 2: One-shot moulding is unlikely to be undertaken at daily output levels of 8 and 40 pairs.

Op. Ref No.	Operations	Scale 1	Scale 2	Scale 3	Scale 4
		8prs/8hrs	40prs/8hrs	200prs/8hrs	1000prs/8hrs
62	One-shot injection moulding of complete sandals	-	-	2 ss	3 ss
63	Packing	-	-	1 us	1 us

ss = semi skilled (3 weeks training)
us = unskilled (one week training)

Table III.14

Methods and equipment specifications for
Type 6 footwear

Output: 200 and 1000 pairs per 8 hours

Type: Single injection moulded PVC sandals

Op. Ref No.	Operations and Major Equipment Required	Equipment source	No required by scale		Estimated unit cost \$
			3	4	
62	<u>SINGLE INJECTION MOULDING OF SANDALS</u>				
	- twin station, semi-automatic injection moulding machine, moulds and racks	Sup.list 62	1	-	40,000
	- ten-station, semi-automatic injection moulding machine, moulds and racks	Sup.list 62	-	1	110,000
	- granulator	Sup.list 35	1	1	1,400
63	<u>PACKING</u>				
	- packing bench	local	1	1	25

CHAPTER IV

FRAMEWORK FOR PROJECT EVALUATION

The previous two chapters described alternative techniques for producing various types of shoes and sandals at four different scales of production. They provided, in addition, detailed technical data on labour, equipment and materials inputs needed for each type of footwear and scale of production. The purpose of this chapter is to show how the above data may be used to estimate the feasibility of various footwear manufacturing projects and/or to identify technologies suitable for local conditions and circumstances.

I. Factors influencing the choice of technology

The choice of footwear manufacturing technologies is a function of a number of factors. The most important ones are briefly described in this section. However, it is first important to better define the expression "footwear manufacturing technology" in the context of this technical memorandum.

It may be recalled that, depending on the type of footwear, the overall manufacturing process included a number of process stages, this number varying from one stage for moulded plastic sandals to seven stages for more intricate footwear. Furthermore, each stage is subdivided into a number of operations. For example, for type 1 footwear, the seven process stages include a

total of 31 operations. Finally, each operation may be carried out with one out of a number of available techniques. A footwear manufacturing technology may therefore be defined as any particular combination of techniques needed to produce a given type of footwear.

Given the total number of operations underlying the overall manufacturing process (e.g. 31 operations as for type 1 footwear) and considering that two or more techniques may be adopted for each operation, the total number of technologies (or combination of techniques) available for each type of footwear will, by necessity, be very large (e.g. thousands or millions of technologies depending on the type of footwear). Obviously, it would not be feasible to evaluate all these technologies in order to identify the one which is most suitable to local conditions and circumstances. Nor would this be necessary for the following reasons.

Firstly, the stages of production and, to a large extent the operations, are not interdependent. In other words, one operation within a given stage should not, generally, affect the choice of technique for another operation within the same stage or subsequent stages. Thus, one may identify the appropriate technique for each operation and evaluate only those technologies which combine these techniques in the manufacture of a given type of footwear. The number of technologies to be evaluated will generally be a function of the number of types of footwear and/or the scales of production which are considered.

Secondly, within a given operation, one need not evaluate all available techniques. In many cases, some of the available techniques may never be appropriate at given scales of production. For example, a lining stamping machine may never be justified for scales of production of 8 or 40 pairs per 8-hours day. Thus, the choice of technique for a given operation should not, in many cases, require extensive evaluations.

As stated earlier, the choice of footwear manufacturing technology is a function of a number of factors. The most important ones include the following:

- the type of footwear,
- the adopted quality standard,
- the scale of production,
- the prices of the factors of production
(e.g. wages, interest on capital, materials)

and,

- the retail price of the output.

The type of evaluation needed to identify the most appropriate production technology will depend on whether the choice of footwear type and quality and/or that of scale of production are fixed or not. Depending on the latter, the evaluation may take one of the following forms:

- (i) Partial evaluation in cases where the footwear type and quality and the scale of production are pre-determined. In some cases, the market conditions and the financial means at the disposal of the shoe manufacturer are such that both the footwear type and quality and the scale of production are pre-determined. Under these circumstances, a number of cost items do not vary with the choice of technologies. These are: materials costs per unit of output, working capital, management costs and building costs.¹ Furthermore, revenues from the sale of the output are the same for all alternative technologies since these yield the same type of footwear and quality standard. Consequently, these costs and revenues need not be taken into consideration when the purpose of the evaluation is limited to the identification of the most appropriate footwear manufacturing technology.
- (ii) Full evaluation of alternative footwear manufacturing techniques. Whenever the type and quality of footwear and/or the scale of production are not pre-determined by market or financial constraints, a full evaluation of alternative technologies should be undertaken with a view to identifying the one which is most suitable to local conditions and circumstances. Such an evaluation takes into account all costs and revenues since these will generally vary with the adopted technology.²

¹Small differences in building costs may be experienced between two alternative technologies. However, these differences should, in general, be negligible.

²Materials costs per unit of output should vary with the adopted scale of production even if the type and quality of footwear are pre-determined since the wholesale price of materials is generally function of the quantity sold, and therefore of the scale of production.

The following section will describe an evaluation framework for the evaluation of alternative footwear manufacturing technologies.

II. Evaluation methodology

A number of evaluation methodologies may be used in the process of comparing alternative technologies. The one presented here should be easily applied by potential shoe manufacturers or project evaluators, and should yield reliable estimates of the profitability of alternative technologies.

The same methodology may be applied whether one is intending to carry out a partial or full evaluation of alternative projects. The only difference between these two evaluations concerns the types of costs and revenues which should be taken into consideration.

The purpose of the evaluation exercise is to identify the technology which minimises costs per unit of output (partial evaluation) or which maximises profits (full evaluation) depending on whether the scale of production and the type/quality of footwear are predetermined or not. It will now be shown how costs and revenues may be estimated to achieve the above goals.

II.1 Estimation of cost items

The estimation procedure used in this memorandum yields cost estimates for a typical year in a project life. It differs to some extent from a similar estimation procedure which yields the present value of costs incurred over the project life. However, it should be reliable enough for our purpose (i.e. to identify the most appropriate footwear manufacture technology). Total production costs include the following cost items:

- Equipment costs (depreciation + interest)
- Interest on working capital
- Labour costs (production workers)
- Management costs
- Materials costs
- Building costs (rental value)
- Energy costs, and
- Maintenance costs (of building, equipment).

It will now be shown how the above cost items may be estimated.

(a) Equipment costs

The cost of equipment may be subdivided into two items: the interest paid on invested capital and equipment depreciation cost. These two cost items are function of the equipment purchase price (K), the useful life of the equipment (n years), the prevailing interest rate (r), and the salvage value of the equipment at the end of the project (S).¹

If the salvage value of equipment is assumed to be equal to zero, the annual equipment cost may be easily obtained with the help of Appen. V by dividing the purchase price of equipment by the present worth of the annuity factor (F) for the given interest rate and the useful life of equipment. Let us, for example, assume that the purchase price of a piece of equipment is 1,000 dollars, that its useful life is 15 years and that the interest rate is 10%. Then the annual equipment cost is:

$$D = \frac{K}{F} = \frac{\$1,000}{7.606} = \$131.48$$

where the number 7 606 corresponds to the present worth of the annuity factor for a 10% interest rate and a useful life of 15 years (see in App. V the number corresponding to the intersection of the 10% column with the 15 years row).

In many cases, the salvage value may be substantial and may lower significantly the annual equipment cost. In this case, one should use the following formulation:

$$D = \frac{K}{F} - \frac{S}{F(1+r)^n}$$

Let us assume that K and F have the same value as in the above example and that the salvage value (S) is equal to 10% of K or \$100. Then we obtain the following annual cost of equipment:

$$D = \frac{\$1,000}{7.606} - \frac{\$100}{7.606(1.1)^{15}} = \$131.48 - \$3.15 = \$128.33$$

¹In equation form, the annual cost of equipment (D) is equal to:

$$D = K \left[\frac{r(1+r)^n}{(1+r)^n - 1} \right] - S \left[\frac{r}{(1+r)^n - 1} \right]$$

The value of $(1+r)^n$ may be easily calculated for given values of r and n or may be obtained from available financial tables.

(b) Interest on working capital

Depending on the scale of production and the local conditions which determine the supply of various materials inputs (e.g. whether materials are imported or produced locally), a footwear manufacturer may need to keep a certain inventory of materials inputs (e.g. a one month or three months supplies) in order to avoid discontinuing production while waiting for new shipments of materials. The cost of these inventories is either paid out of the manufacturer's own funds or through a bank loan. In either case, the cost of maintaining capital idle is equal to the interest accrued over the average inventory period.

The same reasoning applies to the value of sold output whenever payments are not made on the day of the sale. In many countries, payments are made one to three months after the sale date, and the manufacturer should thus take into account the interest (on the value of the sale) paid or foregone during the one to three months period.

(c) Building costs

Annual building costs may be estimated in the same way as in the case of equipment costs, taking into consideration the cost of the infrastructure and that of the land. Alternatively, a simpler approach may be used by assuming annual building costs equal to the annual rent which would be paid for a similar building located in the project area.

(d) Management costs

Management costs should include the salaries of the plant manager (in some cases, the owner of the factory) accountant, marketing agents, maintenance staff, etc. (i.e. the staff which is not directly involved in the production process).

(e) Estimation of variable costs

Variable costs include the wages paid to production workers, the cost of materials, energy costs and the maintenance cost of building and equipment. The last two cost items usually represent a very small fraction of total costs and may, in most cases, be neglected unless the plant is highly mechanised.

II.2 Estimation of total annual costs and of gross profits

Once the various annual cost items have been estimated, one may calculate the total annual cost associated with alternative footwear manufacturing technologies by simply adding the various cost items. Annual revenues from the sale of the output may then be estimated for the given scale of production and type of footwear, taking into consideration the estimated unit retail price. Finally, gross profits associated with each alternative technology may be calculated by subtracting the yearly total costs from the estimated yearly revenues.

The evaluation should be repeated for all relevant scales of production and types and quality of footwear, given market conditions and the financial means at the disposal of the footwear manufacturer. The adopted scale of production, manufacturing technology and type and quality of footwear should be those which maximise gross profits.

Alternatively, whenever a single type and quality of footwear and a single scale of production are being considered, one may limit the evaluation to the estimation of those annual costs which are a function of the adopted technology. The adopted technology should, in this case, be the one which minimizes production costs since annual revenues are the same for all technologies.

The following section will indicate how to obtain the necessary technical and economic data in order to apply the above evaluation procedure.

II.3 Sources of technical and economic data

(a) Sources of technical data

Technical data needed to evaluate alternative footwear manufacture technologies include the following: type and number of pieces of equipment, number of skilled-semi-skilled and unskilled labour, energy inputs, factory floor plan, materials input per unit of output, and maintenance needs and frequency. This data is needed for various types and qualities of footwear and scales of production whenever the latter are not predetermined, and for alternative production techniques available for each operation.

Chapters II and III provide the above technical data for six types of footwear and four scales of production. However, as already stated in Chapter I, this data does not cover all possible combinations of techniques or technologies. Instead, the authors have selected those technologies which, on the basis of data collected from a number of developing and developed countries, seem particularly suitable for conditions prevailing in developing countries. In other words, the technologies suggested in chapters II and III for each particular type of footwear/scale of production may be considered least-cost technologies.

This being said, there may be some special circumstances whereby these technologies may not prove to be the most cost-effective. Thus, the reader may wish to investigate other combinations of techniques on the basis of information contained in Chapters II and III or other available technical publications.

The types of footwear and the scales of production described in the previous two chapters do not either cover all possible alternatives. Obviously, no publication could cover the thousands of combinations of footwear type/scale of production. However, those covered in these two chapters should provide a sufficient basis for estimating the equipment and labour requirements for other types of footwear and/or scales of production. The same remark applies to the estimation of the required floor area for scales of production/technologies not specifically covered in Chapters II and III.

Table I.4 in Chapter I, describes the materials needed for each type of footwear. As already stated, in this chapter, the amount of materials per unit of output is the same for all technologies and scales of production. The table does not provide estimates of the actual amounts of materials needed for each type of footwear as these amounts are function of the exact shoe or sandal design, and footwear size. The reader should therefore estimate the average amount of materials per unit of output once a decision has been made on footwear design and sizes to be produced.

No information is provided on maintenance needs and frequency for various pieces of equipment as such information is equipment-specific and may be easily obtained from equipment manufacturers. The same remark applies to energy inputs: information on the latter should also be obtained from equipment manufacturers or brochures which describe the equipment.

(b) Sources of economic data

Economic data needed to evaluate alternative footwear manufacture technologies include the following: prices of imported and local equipment, cost of buildings, unit price of various materials, wages for various types of labour, unit price of energy (mostly electricity) rental value of land, unit cost of packaging materials, prevailing interest rate (for the estimation of equipment depreciation cost and interest on working capital), estimated retail price of output, and income or corporate tax rates for a full evaluation of alternative projects.

Chapters II and III provide estimates of FOB (Free On Board) international prices for the pieces of equipment which may need to be imported. These are 1980 average international prices which could be different from the actual price which would eventually be paid once the equipment has been ordered. The reader wishing to obtain an estimate of the cost of imported equipment should use the following steps:

- (i) Whenever possible, to obtain from local importers of equipment or from equipment manufacturers the actual FOB price of the equipment. If only an approximate estimate is needed, the FOB prices provided in Chapters II and III may be adjusted for inflation at, for example, a 10% rate starting from the 1980 prices,
- (ii) To add to the FOB prices the shipping and insurance costs (to obtain the CIF price) and custom duties, if any. This information is country-specific and may be obtained from local importers or custom officials,
- (iii) It is advisable to add to the cost of equipment that of spare parts which may be needed over a 3 to 5 years period in order to avoid the disruption of production for lack of spare parts.

Estimates of the prices of equipment which may be produced locally are also provided in the preceding two chapters. However, these estimates are highly tentative, and the reader is urged to obtain more precise estimates from local workshops or engineering firms.

An estimate of the cost of buildings may be obtained from local contractors on the basis of the estimated floor plan.

Cost estimates for materials, wages, energy, etc., are country-specific and may be easily obtained from wholesalers of various materials, footwear manufacturers, etc.

An estimate of the retail price of the output should be based on the actual retail price of similar footwear either produced locally or imported.

II.4 Hypothetical examples of the application of the evaluation methodology

This section provides hypothetical examples of the application of the evaluation methodology described in section I.2.2. The following section will provide real life examples from Ghana and Ethiopia.

The identification of the least-cost technique at the operation level may be illustrated by the following example in which two techniques are distinguished (see Table IV.1). The capital-intensive technique uses as equipment machine A having a total useful life of 20 years, and is used in combination with 9 full-time workers. The labour-intensive technique uses a less expensive and simpler machine B, having a useful life of 10 years (it must therefore be replaced for a second 10 years period, for a total project life of 20 years), and is used in combination with 15 full-time workers. The type and quality of footwear, and the scale of production (40 units per day, or 12,000 units per year based on 300 working days) are the same for both techniques. Therefore, all materials inputs and overheads may be assumed to be the same for both projects and may therefore be omitted from the analysis.

Similarly, the expected revenues from the sale of the output need not be estimated since the type and quality of footwear are the same for both techniques.

The pieces of equipment and annual wages are provided in units of account as follows:

- Machine A : 1,000 units
- Machine B : 300 units
- Annual wage : 10 units (the same for both techniques)

Table IV.1

Selection of a least-cost technique for an operation handling 40 pairs per day

Cost item	Technique	
	Capital-intensive A	Labour-intensive B
1. Equipment purchase price	1,000 (20 years life)	300 (10 years life)
2. Labour	9 workers at 10 units per year	15 workers at 10 units per year
3. <u>Annual cost method</u>		
- Annual equipment costs	117.45	48.82
- Annual labour costs	90	150
- Total annual costs	207.45	198.82
- Unit production cost	<u>0.0172</u>	<u>0.0165</u>
4. <u>Present value method</u>		
- Present value of equipment	1000	415.65
- Present value of labour	766	1,277
- Present value of total costs	<u>1,766</u>	<u>1,692.65</u>

The adopted interest rate is 10%, and the salvage value of equipment is assumed to be equal to zero.

Two variants of the evaluation methodology described in section I.2 will be used in this example: one yielding an estimate of annual costs for a typical year in the project life, and one yielding the present value of costs accruing over the project life (20 years). It will be shown that both variants yield the same conclusion with respect to the cost-effectiveness of the two production techniques.

(a) Estimation of annual cost

- Annual cost of equipment: Using the relationship shown in section I.2 ($D = \frac{K}{F}$) where D is the annual cost of equipment, we obtain:

$$D_A = \frac{1,000}{8.514} = 117.45 \text{ for machine A}$$

where 8.514 = present worth of the annuity factor corresponding to a 10% interest rate and 20 years period.

Similarly, the annual cost for machine B is equal to:

$$D_B = \frac{300}{6.145} = 48.82$$

where 6.145 = the present worth of the annuity factor for 10% and 10 years period.

- Annual labour costs

These are equal to:

9 x 10 = 90 units for technology A, and

15 x 10 = 150 units for technology B

- Annual total costs

These are equal to:

117.45 + 90 = 207.45 units for technology A

48.82 + 150 = 198.82 units for technology B

- Cost per unit of output : Considering that both technologies yield 12,000 units of footwear per year, the cost per unit of output is equal to 0.0172 monetary units for technology A and to 0.0165 monetary units for technology B. In this case, technology B is the least-cost technology.

(b) Estimation of the present value of costs

In this second variant of the methodology described in section I.2, all costs incurred during the project life are discounted to the present at the appropriate discount rate (in this case 10%)

- Present value of equipment costs

For Technology A, the present value of equipment cost is equal to the purchase price of equipment, that is 1,000 units.

For Technology B, the present value of equipment is equal to:

$$300 + \frac{300}{(1+0.1)^{10}} = 300 + \frac{300}{2.594} = 415.65 \text{ units}$$

The second disbursement (300) which takes place 10 years after the start of the project is discounted to the present at a 10% discount rate. Financial tables are available to facilitate this kind of calculations.

- Present value of labour costs

In order to estimate the present value of labour one must discount the stream of labour costs over the project life. This may be easily accomplished with the help of Appendix V by multiplying the annual labour cost by the relevant present worth of the annuity factor F. In this case, F is equal to 8.514, corresponding to a 10% discount rate and a 20 years period.

The present value of labour costs for Technology A is equal to:

$$90 \times 8.514 = 766 \text{ units, and for } \underline{\text{Technology B}}:$$

$$150 \times 8.514 = 1,277 \text{ units.}$$

- Present value of total costs

The present value of total costs is equal to the sum of the present value of equipment costs and labour costs.

The present value of total costs for Technology A is equal to:

$$1,000 + 766 = 1,766 \text{ units}$$

while that of Technology B is equal to:

$$415.65 + 1,277 = 1,692 \text{ units.}$$

Thus, the present value method yields the same conclusion as that yielded by the annual cost method (i.e. technology B is the least-cost technology).

The above example constitutes a partial evaluation of alternative technologies whereby costs and benefits common to the two technologies are not taken into consideration. In cases where either the scale of production and/or the footwear type and quality are not predetermined, the same approach may be used for the full evaluation of projects. The annual cost method may be easier to apply in this case since most of the cost items (e.g. materials, labour, maintenance and energy costs, and the rental value of premises) do not constitute investment costs and may be used as such without further calculations. The latter are needed for the estimation of annual equipment cost and interest cost on working capital only. Should the annual cost method be applied, the most appropriate technology/project would be the one which maximises the difference between the annual revenues from sale of the output and total annual costs.

III. Evaluation of technologies adopted by established footwear factories in developing countries

This section evaluates a number of footwear projects in Ghana and Ethiopia. The evaluations relate to various combinations of scales of production, technologies, and footwear types. The conclusions yielded by these evaluations are country-specific and time-specific (Ghana and Ethiopia, 1972), and may not be generalised to all developing countries at the present time.

III.1 Alternative technologies for type 1 footwear: A Ghanaian case study

Chapter II contains an extensive description of manufacturing methods and equipment for type 1 footwear

men's leather-upper, cement-lasted shoes with cemented-on unit soles. Being the standard method of construction of most types of footwear dealt with, the description is most detailed and includes most of the operations that can be meaningfully distinguished at the sub-process level. Particular attention will therefore be paid to technological alternatives to manufacture this type of shoe before discussing those of other types of footwear.

Following the methodological framework explained in the previous section, a least-cost technology as well as the most labour- and machine-intensive alternatives to manufacture 1,200 pairs per day of men's cemented-on, leather-upper shoes in a proposed Ghanaian shoe factory were evaluated. A complete description of the calculations is included in McBain (1977).

As shown in Table IV.2, annual production costs, fixed capital requirements and working capital are differentiated into (1) a local cost and foreign currency component, and (2) costs which are common to all technologies and those which vary with the technology adopted. The extent to which various cost items refer to locally produced or imported materials and equipment depends on the country concerned, in particular with regard to the availability and processing of hides and skins and the presence of a specialist machinery manufacturing sector, and project-specific circumstances. To obtain the local price of imported commodities, (country-specific) import duties must be added to the import price. Information on the extent to which costs vary with the technology adopted is derived from the technical data at the operations or production stage level. The actual valuation of cost items will depend on the prevailing system of local factor and commodity prices. Details of the supporting tables for production and investment are included in McBain (1977, Appendix 1. Data and calculations for Bench Mark Factory Appraisals) The general methodology to estimate the various cost figures is treated in standard texts on feasibility studies such as the UNIDO Manual (1978).

A summary of the major characteristics of the most machine-intensive, most labour-intensive and least-cost technology to manufacture 1,200 pairs per day of type 1 footwear is presented in Table IV.5. The data confirm that differences in technology to

Table IV.2
Annual total production costs at full capacity,
year 10, Ghana, machine-intensive factory (Ø thousand)

Cost item	Origin			Total	Technology	
	Im-ported	Duties	Local		Fixed	Variable
1. Direct materials	789	351	46	1,186	1,186	
2. Electricity			1	1	1	
3. Spares, tools, equipment	10	1		11		11
4. Direct production workers			54	54		54
4.1 Skilled			27	27		27
4.2 Semi-skilled			17	17		17
4.3 Unskilled			10	10		10
<u>Factory costs</u>	<u>799</u>	<u>352</u>	<u>101</u>	<u>1,252</u>	<u>1,187</u>	<u>65</u>
5. Office overhead costs	2	2	25	29	29	
6. Office and supervisory staff			70	70	70	
<u>Operating costs</u>	<u>801</u>	<u>354</u>	<u>196</u>	<u>1,351</u>	<u>1,286</u>	<u>65</u>
7. Financial costs (interests)						
8. Depreciation			22	22	3	19
<u>Production costs</u>	<u>801</u>	<u>354</u>	<u>218</u>	<u>1,373</u>	<u>1,289</u>	<u>84</u>
9. Interest on total initial capital at 10% (excluding item 7)			145	145	94	51
<u>Total production costs</u>	<u>801</u>	<u>354</u>	<u>363</u>	<u>1,518</u>	<u>1,383</u>	<u>135</u>

Note : Depreciation and interest on total capital are based on Tables IV.3 and IV.4. Cost estimates assume a 50% capacity utilisation at year 2, 85% at year 3 and 100% from year 4 to year 26 (end of project).

Table IV.3

Fixed investment cost schedule, Ghana, machine-intensive factory
(₵ thousand)

Period	Construction				Start-up and full capacity				Closure
Year	1				2, 18, 14, 20			7, 13, 19	27
Origin	Im-ported	Duties	Local	Total	Im-ported	Duties	Total	Local	Local
1. Land			1	1					(1)
2. Site works			3	3					(1)
3. Fixed buildings			26	26					(15)
4. Variable buildings			37	37					(27)
5. Furniture	2	2		4					0
6. Workshop equipment			2	2					0
7. Compressor	1	1		2					0
8. Variable production machine, tools	313	138	4	455					(3)
9. Vehicles					7	5	12	(2)	(1)
10. Formation and pre-start-up training			10	10					0
Fixed investment	316	141	83	540	7	5	12	(2)	(48)
Fixed with technology	3	3	42	48	7	5	12	(2)	(18)
Variable with technology (4 + 8)	313	138	41	492					(30)

Table IV.4

Working capital schedule, Ghana, machine-intensive
factory (₵ thousand)

Period	Start-up		Full capacity		Closure
	2	3	4	5-26	
Year					27
Production programme	50%	85%	100%	100%	0%
1. Raw materials (5 month's usage of direct materials)	247	420	494	494	
2. Work-in-progress (0.6 month's work of direct materials)	30	50	59	59	
3. Finished goods and credits (3 month's of operating costs)	189	293	338	338	
4. Cash reserves (1 month's wages)	10	10	10	10	
Working capital	476	773	901	901	0
Imported items			568		
Duties			252		
Local items			81		
Fixed with technology			880		
Variable with technology			21		
Increase in working capital	476	297	128	0	(901)

manufacture type 1 footwear mainly refer to fixed capital requirements and the number and composition of direct production workers. Fixed capital per direct production worker in the most machine-intensive case is almost three times as high as in the most labour-intensive case. Variations in fixed capital requirements itself are of a comparable magnitude. Although variations in labour requirements are less pronounced, the data suggest that the overall possibilities for technological choice are nevertheless substantial. The nature of capital-labour substitution appears to be such that capital substitutes to a larger extent for skilled than for semi-skilled and unskilled labour. The labour-intensive case not only entails a larger number of skilled workers, but its proportion in the total number of direct production workers increases as well.

To appraise the attractiveness of the different technologies distinguished in Table IV.5, either of the three cost-effectiveness methods explained in section II can be applied because revenues are equal for all technologies (300,000 pairs of shoes per annum sold at a wholesale price of ¢ 6 per pair). Because of the latter, measures of financial profitability such as the net present value of the project's cash flow (NPV) can be calculated as well. Of the cost-effectiveness method, both the annual costs and unit costs were calculated, differentiating cost figures into variable and non-variable (fixed) costs with regard to the adopted technology. Thus, the estimated annual depreciation charge (approximated by taking 4% of the fixed capital investment) and annual interest charge (10% of the total capital investment) were added to the annual operating costs to obtain the total production costs. As shown in Table IV.5, as well as in more detail in Table IV.2, the costs common to all technologies amount to a substantial 1.383 ¢ thousand. When this amount is subtracted from the total production costs, the annual costs specific to each alternative technology are obtained. By dividing the annual cost figures by the annual output, one may calculate the unit footwear cost for each technology. A comparison of the results for the three technologies suggests that the least-cost technology is fairly labour-intensive.

At this stage, one may ask how the least-cost solution shown in Table IV.5 (which reflects Ghanaian economic conditions in 1972) is related to the technical

Table IV.5

Economic characteristics of producing 1,200 pairs per day of men's cemented-shoes with different technologies in Ghana (¢ thousand in 1972 prices and relative to sale, unless indicated otherwise)

Cost or benefit item	Most machine-intensive		Most-labour-intensive		Least-cost	
	Value	Ratio	Value	Ratio	Value	Ratio
1. Direct materials, electricity and overhead costs (fixed)	1,216	0.675	1,216	0.675	1,216	0.675
2. Spare tools and equipment (var.)	11	0.006	5	0.003	5	0.003
3. Total wages	124	0.069	154	0.086	143	0.080
. Office, supervisory staff (fix.)	70	0.039	70	0.039	70	0.039
. Skilled production workers (variable)	27	0.015	50	0.028	45	0.025
. Other production workers (var.)	27	0.015	34	0.019	29	0.016
Operating costs (1+2+3)	1,351	0.751	1,375	0.764	1,364	0.758
4. Depreciation (variable*)	22	0.012	9	0.005	11	0.006
5. Corporate tax	213	0.118	208	0.115	212	0.118
Production costs (1+2+3+4)	1,373	0.763	1,384	0.769	1,375	0.764
Net profit after tax (6-1-2-3-4-5)	214	0.119	208	0.116	213	0.118
Value added (6-1-2)	573	0.319	579	0.322	579	0.322
6. Ex-factory sales	1,800	1.000	1,800	1.000	1,800	1.000
7. Fixed capital (variable)*	552	0.307	233	0.130	269	0.150
8. Working capital (fixed*)	901	0.501	910	0.505	906	0.503
Total capital (7+8)	1,453	0.800	1,143	0.635	1,175	0.653
9. Staff (no.)	36		36		36	
10. Skilled production workers (no.)	49		90		91	
11. Other production workers (no.)	70		92		68	
Total employed (9+10+11)	155		218		195	
Fixed capital/produc. worker (¢)	4,643		1,281		1,694	
12. Interest on total capital at 10% per annum	145	0.081	114	0.063	118	0.065
Total prod. costs (1+2+3+4+12), of which:	1,518	0.843	1,498	0.832	1,493	0.829
-fixed with technology	1,383	0.768	1,383	0.768	1,383	0.768
variable with technu.	135	0.075	115	0.064	110	0.061
Net profit at 10% (6-1-2-3-4-12)	282	0.157	302	0.168	307	0.071
Net profit after tax/total capital (%)		14.7		18.2		18.1
Unit cost per pair (¢) of which:	5.06		4.99		4.98	
-fixed with technology	4.61		4.61		4.61	
-variable with technology	0.45		0.38		0.37	

* To a large extent.

Source: Calculated from McBain (1977). See also Tables IV.2, IV.3 and IV.4.

data for type 1 footwear provided in Chapter II. As mentioned before, the combination of techniques reported in Chapter II is indicative of a least-cost technology typical for developing country conditions. The actual specification of production methods and equipment in a particular situation will therefore invariably differ, though not substantially in most cases, from the stylised tabulations in Chapter II. Despite these differences, the latter can fairly easily be related to the methods and equipment specification underlying the technology in the least-cost solution of Table IV.5 through the following steps:

(1) Select scale 4 in Chapter II (1,000 pairs per day) as the scale of output closest to that in Table IV.5.

(2) Identify the corresponding technology (methods and specifications of equipment for type 1 footwear at scale of production 4)

(3) Tabulate the number of direct employees and the fixed capital equipment for the identified technology (see technical tables in Chapter II to obtain estimates of direct production workers by skill and the cost of equipment). Indirect employees required and production floor area can be considered common to all technologies for a given scale.

(4) Estimate the annual unit cost of direct labour and equipment as shown in the example of Table IV.1. The resulting unit cost figure, which includes most of the cost elements relevant for the identified technology, is now comparable with the unit cost per pair of the least-cost technology in Table IV.5 (0.37 ¢ in 1972 prices).

Although the partial cost-effectiveness method is an effective instrument to select least-cost technologies, it should be kept in mind that application of a full cost-effectiveness method does exactly the same, but gives, in addition, information on the total cost structure.¹ This information is essential if, in

¹When the time involved in differentiating cost items into fixed and variable costs for each technology is substantial, application of the partial cost-effectiveness method might be more time-consuming than that of the complete method.

addition to the selection of technology, the financial feasibility of a proposed project must also be appraised. In Table IV.5, the overall profitability of the proposed shoe factory is shown by the annual net profit and by the ratio of after-tax profit to capital. Instead of calculating the NPV over the life-time of the project, the annual equivalent of the NPV called "net profit" in Table IV.5 was calculated by subtracting the annual capital charge (depreciation and interest) plus the annual current operating costs (i.e. the annual total production costs) from the annual sales. All technologies show a positive annual net profit, implying that they all earn a rent income (i.e. they add a surplus to society over and above the attributed 10% return to capital reflecting the rate of discount). Hence, at the prevailing system of prices, the proposed project is financially profitable irrespective of the technology adopted. Obviously, the least-cost technology maximises the annual project surplus.

It should be emphasised that technological alternatives can be mutually exclusive. Consequently, the net present value (NPV) of a project is the correct selection criterion. Criteria other than those derived from cost-effectiveness or discounted cash flow analysis such as the use of operating costs, production costs excluding the proper capital charge, value added, and different concepts of profits or profit-ratios are, by nature, incomplete measures of the attractiveness of technological alternatives or entire projects, and therefore unsuitable as selection criteria. This can be illustrated for the case of operating costs, production costs and net profit after tax, according to which the most machine-intensive technology would seem to be the most attractive alternative. Similarly, when value added and net profit after tax to capital are used as selection criteria, the most labour-intensive alternative is wrongly identified as the most appropriate technology. Thus, it is preferable to use, in all cases, the NPV criterion.

Because operating costs, and hence working capital, are largely invariant for different techniques, production costs, value added and profits vary only slightly across technologies. As working capital requirements account for the larger part of total capital, variations in profitability are confined within a rather narrow range. For a government strongly concerned with the creation of more employment, this might be reassuring because it indicates that a more labour-intensive technology than the least-cost one can be adopted at little

extra cost. By the same reasoning, however, entrepreneurs forego little profit when they adopt a more capital-intensive technology.

III.2 Comparison of alternative types of footwear at fixed levels of scale: Ethiopian case study

When the shoe manufacturer faces no particular demand constraint in terms of type and quality of footwear, the selection of the most attractive type(s) of shoes to be marketed becomes as important as the selection of the most attractive combination of techniques. The comparison and appraisal of alternative combinations of techniques to manufacture a different type of footwear, can, in principle, be undertaken in the same way as indicated for the case of the type 1 men's cemented-on, leather-upper shoes. Once a least-cost technology for each type of footwear has been identified and selected, the attractiveness of manufacturing different products with a least-cost technology can be compared by calculating the overall profitability of alternative projects.

For five of the six types of footwear distinguished in this study, the major characteristics of the least-cost combinations of techniques to manufacture 1,200 pairs of shoes or sandals per day are summarised in Table IV.6. The data was obtained from a number of footwear projects located in Ethiopia and is based on 1972 prices. The type 3 shoe with stitched-on leather soles is not included because its characteristics do not differ substantially from the type 1 shoe with synthetic soles.

Details of the calculations for the different types of footwear can be found in McBain (1977). The results presented in Table IV.6 can only be partly related to the tabulations included in Chapters II and III, because the latter largely refer to that part of the cost that varies with the technology.¹ As the choice between different types of footwear is necessarily based on a comparison of product profitability, variable and fixed costs are estimated separately in this case study.

¹See technical tables in Chapter II for type 1 footwear and technical tables in Chapter III for footwear types 2, 4, 5 and 6.

Table IV.6

Economic characteristics of producing 1,200 pairs of different footwear per day with a least-cost technology in Ethiopia (in thousand 1972 Ethiopian dollars)

Cost or benefit item	Stitched leather, cemented-on shoes (Type 1)		Stitched leather moulded-on shoes (Type 2)		Welded PVC moulded-on shoes (Type 4)		Stitched PVC cemented-on sandal (Type 5)		One-shot, moulded PVC sandals (Type 6)	
	Value	Ratio	Value	Ratio	Value	Ratio	Value	Ratio	Value	Ratio
1. Intermediate inputs	2,145	0.715	1,913	0.671	937	0.679	649	0.541	344	0.662
2. Wage and salaries	270	0.090	277	0.097	125	0.091	233	0.194	52	0.100
3. Depreciation	26	0.009	34	0.012	17	0.012	17	0.014	27	0.052
Production costs (1+2+3)	2,441	0.814	2,224	0.780	1,079	0.782	899	0.749	423	0.814
Net operating profit (4-1-2-3)	559	0.186	626	0.220	301	0.218	301	0.251	97	0.186
Value added (4-1)	855	0.285	937	0.329	443	0.321	551	0.459	176	0.338
4. Ex-factory sales	3,000	1.000	2,850	1.000	1,380	1.000	1,200	1.000	520	1.000
5. Average price per unit (\$)	10		9.5		4.6		4		1.3	
6. Fixed capital	660	0.220	842	0.295	423	0.307	417	0.348	295	0.567
7. Working capital	1,591	0.530	1,424	0.500	677	0.490	512	0.427	169	0.325
Total capital (6+7)	2,251	0.750	2,266	0.795	1,100	0.797	929	0.775	464	0.892
Net profit at 10% (4-1-2-3-10% of cap.)	334	0.111	400	0.140	191	0.138	208	0.173	51	0.098
Net oper. profit cap.		24.8		27.6		27.4		32.4		20.9
8. Staff and skilled production workers (no.)	86		93		29		71		22	
9. Other production workers (no.)	81		77		12		52		6	
Total No. employed (8+9)	167		170		41		123		28	
Fixed capital/employee (\$)	3,952		4,953		10,324		3,393		10,536	

Source: Calculated from McBain (1977).

One of the most striking features observed from the figures in Table IV.6 is that the variation in labour requirements across different types of footwear is substantial ranging from 28 and 41 employees for synthetic footwear types 6 and 4 to 167 and 170 employees for leather footwear types 1 and 2. However, as labour and fixed capital requirements are, to some degree, proportional to output, variations in capital-intensity are considerably less marked as shown by the estimated fixed capital per employee. The highest capital-labour ratio estimated for type 6 footwear is approximately three times higher than that for type 5 footwear (the lowest capital-labour ratio). The range of fixed capital-labour ratios across products manufactured with a least-cost technology is to a large extent similar to that across technologies for the type 1 footwear (see Table IV.5). Interestingly, the skill composition of labour across products shows a tendency for capital-intensive products to be associated with a high relative share of skilled labour in total labour requirements.

The figures in Table IV.6 show that if effective demand for footwear would be such as to justify only one type of shoe or sandal to be marketed at a time (mutually exclusive products), the higher-priced varieties would be preferred because they generate the highest surplus to the economy (type 2 shoes and type 5 sandals show the highest net profit, the annual equivalent of the NPV). Compared with the synthetic and inexpensive type 4 shoes and the very cheap one-shot plastic sandals (type 6), the higher priced varieties also appear to be considerably more appropriate in terms of resource allocation. The economic and social implications of these findings will be further considered in the next chapter.

III.3 Effects of scale on manufacturing technology for type 1 footwear: Ghanaian and Ethiopian case studies

Empirical findings on the effects of scale in footwear production show that advantages of large-scale production are significant up to a level of 1,000 pairs per shift and per day. Generally, the effects of the scale of production are primarily of importance for the mechanised operations. An examination

of the production rates of process equipment at various scales of production for 237 different types of machinery produced by the British United Shoe Machinery Company Limited shows that, in machine-intensive footwear plants, the minimum spare machine capacity is experienced at output levels of about 1,000 pairs per shift. Plants producing substantially more than 1,000 pairs per shift normally group their machines in such a way as to form separate production units specialising in different types of footwear. For manual operations, scale is less important because production operatives with related skills may be employed on capacity sharing, dividing their time between different tasks.

To illustrate the effects of scale, the Ghanaian case study for type 1 men's cemented shoes is extended to three scales of production: 200, 1,200 and 7,200 pairs per shift and per day. Full information on these scales of production was available in the country. For each scale, a most machine-intensive, a most labour-intensive and a least-cost technology are distinguished by applying the methodological framework described in subsection IV.2. The least-cost technology for output levels of 1,200 pairs per day can be related to the technical data and tabulations in Chapter II as indicated in the general treatment of type 1 footwear in section III.1. As the output level of 200 pairs per day coincides with scale 3 in chapter II, the technical data from this latter chapter can be considered indicative of the combination of techniques underlying the least-cost technology. As in the case of product comparisons, the overall profitability criteria (NPV or its annual equivalent, net profit) must be employed when appraising the effects of different scales of production.

A number of economic characteristics of the alternative combinations of techniques at different scales of production are presented in Tables IV.7 and IV.8.

The results confirm that returns, as indicated by the profitability criteria, increase rapidly between output levels of 200 and 1,200 pairs per day. This is mainly due to a marked reduction in fixed capital and labour requirements, in particular staff and skilled labour. Between output levels of 1,200 and 7,200 pairs per day only marginal changes occur, although returns still improve slightly. It should be stressed that the possibility of increased unit transportation cost of materials, equipment and footwear

Table IV.7
Economic characteristics of producing men's cemented shoes with different technologies at three scales
of production in Ghana (₵ thousand, unless otherwise stated)

Pairs per shift Technology	200			1,200			7,200		
	MM	ML	LC	MM	ML	LC	MM	ML	LC
1. Total number employed	35	45	45	155	218	195	845	1,233	1,073
Office and supervisory staff	13	13	13	36	36	36	143	143	143
Skilled production workers	19	26	26	49	90	91	291	540	486
Other production workers	3	6	6	70	92	68	411	550	444
2. Fixed capital	249	72	72	552	233	269	3,125	1,275	1,489
3. Working capital	157	158	158	901	910	906	5,362	5,404	5,365
Total capital	406	230	230	1,453	1,143	1,175	8,487	6,679	6,854
4. Ex-factory sales	300	300	300	1,800	1,800	1,800	10,800	10,800	10,800
5. Value added	92	94	94	573	579	579	3,461	3,489	3,498
6. Total wages	39	44	44	124	154	143	626	773	660
7. Depreciation	10	3	3	22	9	11	125	51	60
Net operating profit (5-6-7)	43	47	47	427	416	425	2,710	2,665	2,778
8. Direc taxes	21	23	23	213	208	212	1,355	1,332	1,389
Net profit after tax	22	24	24	214	208	213	1,355	1,333	1,389
9. Net cash flow (5-6-8)	32	27	27	236	217	224	1,480	1,384	1,449
10. Net present value at 10%	(89)	24	24	834	944	976	6,073	6,666	7,168
11. Internal rate of return (%)	7.0	11.3	11.3	17.5	20.6	20.7	19.4	23	23.7
12. Net profit at 10% (5-6-7-10% of capital)	3	24	24	282	302	307	1,861	1,993	2,093

MM = Most machine-intensive - ML = Most labour-intensive - LC = Least-cost technology

Table IV.8

Economic characteristics of producing men's cemented shoes with different technologies
at three scales of production in Ghana (ratios)

Pairs per shift Technology	200			1,200			7,200		
	MM	ML	LC	MM	ML	LC	MM	ML	LC
1. Index total employed	100	100	100	100	100	100	100	100	100.
Office and supervisory staff	37	29	29	23	17	18	17	11	13
Skilled production workers	54	58	58	32	41	47	34	44	45
Other production workers	9	13	13	45	42	35	49	45	42
2. Fixed capital/sales	0.829	0.240	0.240	0.307	0.130	0.150	0.289	0.118	0.138
3. Working capital/sales	0.524	0.526	0.526	0.501	0.505	0.503	0.497	0.500	0.497
Total capital/sales	1.353	0.766	0.766	0.808	0.635	0.653	0.786	0.618	0.635
4. Fixed capital/production worker (¢ thousand)	11.309	2.247	2.247	4.643	1.281	1.694	4.452	1.170	1.600
5. Pairs/shift/production worker	5.71	4.44	4.44	7.74	5.50	6.15	8.52	5.84	6.71
6. Value added/sales	0.308	0.315	0.315	0.319	0.322	0.322	0.321	0.323	0.324
7. Wages/sales	0.131	0.148	0.148	0.069	0.086	0.080	0.058	0.072	0.061
8. Net operating profit/sales	0.144	0.157	0.157	0.237	0.231	0.236	0.251	0.247	0.257
9. Net operating profit/capital	10.7	20.5	20.5	29.4	36.4	36.1	31.9	39.9	40.5
10. After tax profit/capital	5.3	10.3	10.3	14.7	18.2	18.1	16.0	20.0	20.3
11. Net cash flow/capital	7.8	11.5	11.5	16.2	19.0	19.0	17.4	20.7	21.1

MM = Most machine-intensive - ML = Most labour-intensive - LC = Least-cost technology

as a result of higher output levels has not been accounted for in Tables IV.7 and IV.8. Differences in returns may therefore somewhat overstate the effect of differences in scale.

Although the results presented in the above tables do not seem to favour small-scale production of footwear in the modern sector, one should be careful not to generalise these findings, because the data do not include establishments in the informal or traditional sector using artisanal production techniques and employing only a few workers. An attempt to broaden the effect of scale to include artisanal production techniques was undertaken in Ethiopia.¹ Table IV.9 provides a summary of the findings from the Ethiopian case study.

Output levels in the modern sector are 200, 1,200 and 7,200 pairs of type 1 shoes per day whereas in the very small enterprises in the informal sector 3 workers are assumed to produce 6 pairs of shoes per day. For each scale of production, the least-cost combination of techniques was identified at 1972 Ethiopian factor prices. The least-cost technology for producing 6 pairs of shoes per day is based on the combination of techniques specified for scale 1 in Chapter II.

The artisanal production units (alternative D) show by far the lowest capital-intensity as measured by the annual fixed capital charge per employee. Alternatives A and B employ a relatively capital-intensive technology and alternative C a relatively labour-intensive combination of techniques. Thus, the decrease in the capital-intensity figure between alternatives B and C.

The evaluation of the four alternative scales of production show that the combined net present value of the very small enterprises, each producing 6 pairs of shoes per day, is such that it would make them clearly preferable to the 200 pairs per day production units in the modern sector, though not to the extent that they would be able to compete successfully with the larger enterprises producing 1,200 pairs per day or more. However, since the artisanal production units sell directly to the public at retail prices (thus, no tax payments are due) and since wages are often lower than in the modern sector, returns can be satisfactory.

¹For more information on this case study, see Mc Bain and Pickett (1975).

Table IV.9

Comparison of four scales of production of type 1 footwear for a total volume of 7,200 pairs per day - Ethiopian case study (1972 prices)

Characteristic	Scale of production			
	A	B	C	D
1. Output in pairs per shift per day for a single enterprise	7,200	1,200	200	6
2. Total number employed per enterprise	904	167	42	3
Total number employed to produce 7,200 pairs of shoes	901	1,002	1,512	3,600
3. Total fixed capital excluding replacement ^{1/} (Ethiopian \$ thousand)	3,439	3,961	5,054	5,940
4. Annual fixed capital charge at 10% (Eth. \$ thousand)	378	436	556	967
Annual fixed capital charge per employee (Eth. \$)	418	435	368	269
5. Net present value at 10% ^{2/} (Eth. \$ thousand)	14,055	10,646	(2,340)	3,450

^{1/} Project life of A, B and C is 25 years and of D is 10 years. The corresponding capital charge at 10% therefore amounts to 11% and 16% respectively.

^{2/} For D at retail prices without profit tax.

IV. Concluding remarks on the choice of technology and specialisation

IV.1 Need for preliminary marketing investigations

As suggested all along in this memorandum, potential footwear manufacturers will generally need to make two types of choices: choice of production technology and choice of the type and quality of footwear, the choice of technology being made concurrently with that of scale of production. These choices determine whether a footwear project will be profitable or not. The wrong choice of technology may lower profits or lead to the closing-down of a plant for lack of price competitiveness. This is even more so the case if one were to make the wrong choice of footwear type and quality. Thus, the importance of undertaking a serious investigation in marketing with a view to identifying which footwear types and quality to produce and the scale of production.

Footwear manufacturers contemplating large-scale production of footwear (e.g. thousands of pairs per day) should use the services of a specialised firm for the conducting of a full-fledged marketing investigation: investments in large-scale footwear plants are such that one may not base investment decisions on limited marketing research undertaken by non-specialists. The same remark applies to the choice of technology: the latter should be made by a reputed engineering firm. However, since the majority of such firms tend to base their plant designs on conditions prevailing in industrialised countries, investors in developing countries should request that appropriate alternative techniques be considered. The technical and economic information contained in this memorandum should be useful in assessing plant designs prepared by foreign engineering firms.

This memorandum is, however, mostly intended for small-scale producers and artisans producing as few as 8 pairs per day to as many as 1,000 to 2,000 pairs per day. Such producers may not afford to hire the services of marketing or engineering firms with a view to identifying the appropriate type and quality of footwear, the scale of production and the manufacturing technology. The choice of the scale of production and that of technology having been already dealt with in earlier sections of this memorandum, this section provides a

few suggestions regarding the choice of footwear type and quality through a limited market investigation. The latter may be undertaken according to the following steps.

Firstly, the potential footwear manufacturer may obtain information on the volume and growth of imports of various types of footwear from the country's trade statistics. If the latter indicate a steady growth of imports, the potential investor should obtain samples of such imports and determine whether he is capable of producing close substitutes at competitive prices (i.e. prices equal or lower than the retail prices of imported footwear). In the affirmative, he should visit a few retail stores and obtain the views of the owners on the marketing of locally produced footwear (e.g. what should be the retail and wholesale prices? Will the clientele accept to buy the local substitute footwear or does loyalty to the foreign brand constitute an important constraint?). Information from trade statistics and retail stores should generally be sufficient to decide whether the production of import substitutes should be undertaken.

Secondly, the potential producer may investigate the production of footwear similar to that produced by locally established large-scale manufacturers (e.g. a subsidiary of a multinational firm). The investigation, in this case, should focus on production costs: it is essential that these be much lower than those obtained by the large-scale plants since retail prices should be lower than those of footwear produced by these plants. This is an essential condition since a relatively large difference in retail prices will be needed if customers were to shift from a well-known brand name to a less-known brand. Such a condition will require the adoption of a technology which is more cost-effective than that used by the large-scale plants.

Thirdly, the potential footwear manufacturer may consider the production of a type and quality of footwear particularly appropriate for selected income groups (e.g. in terms of retail price, design, etc.) and which is not available on the market. For example, such a footwear could be intended for the rural population (e.g. footwear appropriate for field work) or high income groups (e.g. fancy footwear worn on special occasions). The production of such footwear is more risky than that of already marketed footwear since information on their

marketability does not exist. On the other hand, high returns may be expected whenever an appropriate choice of footwear type and quality is made.

IV.2 Specialisation and organisation of production

Apart from the special market conditions under which small-scale enterprises operate and the possibility of employing non-mechanised, labour-intensive technologies, small firms can successfully increase their profitability in footwear production by specialising in a limited number of operations, or by using common facilities centres. A few examples of such schemes are briefly described below.

(a) Use of specialist suppliers

An enterprise that specialises in certain stages of manufacture converts raw materials into semi-finished components and supplies them to other enterprises. The semi-finished product might be soles and heels ready for assembly to the lasted upper, or closed uppers ready for lasting. This type of market structure is widespread in countries with industrially developed market economies and usually involves medium-scale component manufacturers supplying medium-scale enterprises that assemble and market the completed footwear. In developing countries, village shoemakers may purchase closed uppers from large factories and use these in the production of finished footwear. The purchase price of these uppers is generally lower than the cost of producing them by the village shoemakers.

(b) Sub-contracting of intermediate production stages

In this scheme, a footwear manufacturing enterprise issues raw materials or footwear components to sub-contracting enterprises which carry out some production stages before returning the work to the footwear manufacturer. In this case, the latter is often a medium-scale enterprise while the sub-contracted enterprises are often very small firms. Generally, the stitching and lasting operations are sub-contracted in such a scheme.

(c) Manufacturing cooperatives

Several forms of footwear production cooperatives exist. For example, independent enterprises, which purchase their own materials and sell their completed footwear may share common manufacturing facilities in a central workshop where specific operations are carried out. This is akin to sub-contracting, except that the shared equipment may be operated by the individual members of the cooperative. Such a system might, for example, be organised by a few very small-scale producers sharing a sole stitching machine. Another arrangement would be for a group of very small producers with an output of 8 pairs per day to have the stitching work carried out in a central unit with a daily output capacity of two hundred pairs, and have the closed uppers returned to them for lasting, finishing and marketing.

The use of specialist component suppliers, sub-contracting and manufacturing cooperatives are some of the ways used in order to benefit from technical and administrative economies of scale. These economies are usually obtained at manufacturing stages where the returns to scale are substantial, while the other manufacturing stages continue to be carried out at smaller scales.

CHAPTER V

FRAMEWORK FOR NATIONAL DECISIONS

In Chapter IV, the nature of technological choice and the selection of least-cost (combinations of) techniques in footwear manufacture were explored for various types of footwear and/or scales of production. Where necessary, the overall feasibility of alternative footwear projects in terms of financial requirements and private profitability was indicated.

In this chapter, the analysis of alternative production technologies, scales of production and product choice is placed in the broader framework of national decision making. The financial appraisal of alternatives in terms of domestic market prices, relevant to the private entrepreneur, is therefore extended to a so-called economic and social appraisal emphasising the use of accounting prices. The latter should better reflect the true scarcity of the factors of production (e.g. labour, capital) and development objectives than market prices, which, in many developing countries, may be distorted as a result of taxation, protection, monopolies and other market imperfections.

Prior to evaluating the economic and social impacts of technological alternatives, least-cost combinations of techniques used to produce the different types of footwear covered by this study are analysed in depth in section I. Special attention is paid to the impact of the choice of various types of footwear, resources allocation and the satisfaction of basic needs.

Section II deals with the appraisal of footwear projects on the basis of economic and social accounting prices rather than domestic market prices, and illustrates the effect of using different prices on the choice of appropriate, least-cost combinations of techniques. It also includes a brief discussion of the data required to conduct such evaluations, and shows how the social feasibility of various footwear projects may be affected by changes in accounting prices.

The last section of the chapter briefly outlines various aspects of a national footwear manufacturing strategy on the basis of the findings of chapters IV and V. Various factors which may influence such a strategy are discussed, and their effect on product choice, scale of production and technology choice is indicated. As this chapter is mainly concerned with national as distinct from private sector decision making, it is primarily addressed to planners, and policy makers in national or local government departments, development organisations and financial institutions.

I. Comparison of alternative footwear products

I.1 Capital and labour requirements for different technologies and types of footwear

The major conclusions reached in Chapter IV with regard to the nature of technological choice in footwear manufacture can be summarised as follows: (1) Generally, the choice of technology affects the number and required skill of production employees (direct labour) and the volume and composition of plant and machinery (fixed capital). (2) Capital-labour substitution in manufacturing a particular type of footwear is characterised, to a large extent, by the substitution of skilled labour, rather than unskilled labour for capital. Thus, labour-intensive technologies are characterised by both a large number and a high proportion of skilled workers. (3) When comparing least-cost technologies for different types of footwear, variations in labour requirements across products are substantial, but variations in fixed capital per employee are comparable to those found for technologies used to produce a given type of footwear. The nature of capital-labour substitution across products is such that capital-intensive products tend to be associated with a high proportion of skilled labour. (4) At low scales of production, the least-cost technologies are relatively labour- and skill-intensive.

Table V.I provides estimates of the capital requirements per employee for the most labour-intensive, most capital-intensive and least-cost technology used in the production of different types of footwear. These estimates are summarised from the Ethiopian case study reported in Chapter IV. The capital-labour ratios for the least-cost technology are the same as those included in the last line of Table IV.3 in Chapter IV.

Table V.I

Fixed capital per employee for manufacturing 1,200 pairs per day of different types of footwear with different technologies in Ethiopia (in 1972 Ethiopian dollars)

Type of footwear	Most labour-intensive	Least-cost	Most capital-intensive
Stitched leather, cemented-on shoes - type 1	1.856	3,952	5,100
Stitched leather, moulded-on shoes - type 2	2,650	4,953	6,016
Welded PVC, moulded-on shoes - type 4	8,158	10,324	10,828
Stitched PVC, cemented-on shoes - type 5	2,305	3,393	4,343
One-shot moulded PVC sandals - type 6	10,536	10,536	17,140

Source: McBain (1977)

Table V.I shows that for leather upper shoes, opportunities for capital-labour substitution are greater between alternative technologies for a particular type of footwear than between different types of shoes. The reverse is true, however, in the case of footwear made of synthetic material. When all types of footwear are considered together, variations in capital-intensity are definitely greater across products than across technologies used for the manufacture of a particular type of footwear.

I.2 Product choice, resource allocation
and the satisfaction of basic needs

When discussing the results of Table IV.3, it was concluded that, if effective demand for footwear would be such as to justify only one type of shoe or sandal to be marketed at a time, the higher priced varieties would be preferred. Compared with the synthetic and inexpensive type 4 shoes and the very cheap one-shot plastic sandals (type 6) the higher-priced type 2 shoes and type 5 sandals appear to be considerably more appropriate in terms of resource allocation and scale of production. Several reasons may be advanced to explain why product choice based on the latter two factors leads to this result.

First, whereas the higher-priced footwear types require more capital, returns are sufficiently high to justify their production when measured against competing investment possibilities. Second, the higher-priced types generate, proportionally, much more employment than the less expensive varieties. Although the latter require an absolute number of skilled labour that is far below that needed for the higher-priced types, it is likely that the type of skills required for footwear types 4 and 6 is far more scarce in developing countries than the type of skills necessary for the other, more craft-based products. Consequently, the factor requirements corresponding to the labour-intensive, high-priced products seem a priori much more in line with relative scarcity of factors of production in developing countries than do factor requirements associated with less expensive footwear. Third, the damage caused to existing small-scale footwear production could be substantial if footwear types 4 or 6 were to be marketed, because these products must, by necessity, be produced in large-scale enterprises. Finally, insofar as the high-priced types of footwear use leather materials, important backward linkages to domestic leather tanneries may take place. Such linkages are likely to be absent in the case of synthetic materials which, in most developing countries, will have to be imported. Thus, in terms of resource allocation, employment creation, surplus generated and backward linkages, the higher-priced footwear types 2 (or 1) and 5 appear most attractive.

Viewed from the demand side, however, the expensive type 2 or 1 shoes and type 5 sandals are typically suited to serve the higher income brackets and export markets. In terms of price and product characteristics (appearance,

durability, comfort, protection, repairability, maintenance and cleaning) these types of footwear are not likely to suit the means and needs of the majority of low-income consumers in developing countries. In contrast, the inexpensive type 6 sandals have very low status and wear out faster than the price differential with other types would justify, but are the only low-priced type of footwear that may be afforded by a large majority of people. Type 5 sandals are of better quality than type 6 sandals, and their production makes use of a technology well suited to the resource endowments of the majority of developing countries. However, their price clearly puts them beyond the reach of the poor consumer.

A low footwear price suited for the purchasing power of low-income groups may therefore create an effective barrier to the production of relatively inexpensive footwear that can be considered appropriate in terms of product characteristics and production technology. Currently, no simple alternative that may fit both requirements (i.e. use of an appropriate technology to produce an appropriate type of footwear) can easily be suggested. To this effect, a market survey would have to be conducted to ascertain effective demand for inexpensive footwear, the effect of threshold prices, and the consumer's appreciation of product performance characteristics.

Next, it should be investigated whether labour-intensive technologies which make use of local raw materials can be applied. In the affirmative, the unit cost of production should match the threshold price, and the footwear quality be such as to make the latter competitive with type 6 sandals. If these conditions do not apply, a policy decision will have to be taken with a view to reaching a balance between the satisfaction of basic needs on the one hand and the efficient use of local resources on the other.

II. Economic and social appraisal of alternative technologies and products

II.1 Social versus private benefit-cost analysis

Thus far, the analysis of footwear manufacture technologies and that of alternative types of footwear and scales of production have been conducted in terms of resource costs and sales revenues valued at actual or

expected market prices. As a rule, this is the common practice followed by private entrepreneurs, and the obtained results are therefore primarily of interest to them. Applying conventional discounted cash flow (DCF) analysis, the technology and/or type of product which add most to the firm's net present worth (i.e. maximises the net present value (NPV)) are generally adopted and may be considered the best technology or type of footwear from the viewpoint of the firm.

For a number of reasons, however, the best technology from the firm's point of view is not necessarily the appropriate technology from a society's point of view. First, the development objectives of a national, regional or local government usually differ from the objectives of a firm, in particular with regard to employment and income distribution. Second, a number of effects which matter to the government are not or are considered differently by the firm (certain indirect effects, external effects such as skill formation or pollution). Third, market prices actually paid or received do not often properly reflect the scarcity of products and factors of production. Fourth, direct taxation is a cost to the firm, but not to society for which it is a transfer to the government.

When the private and government views on appropriate technology may be expected to differ, the application of social benefit-cost analysis becomes mandatory. Starting from a financial DCF analysis, a social benefit-cost analysis aims at measuring the social benefits and costs of alternative technologies and/or products in terms of their contribution to development objectives and of their use of scarce resources at the actual proposed project location. The evaluation methodologies used in social benefit-cost analysis emphasise the use of accounting prices, not only to correct for distorted market prices but also to reflect development objectives, in particular growth, employment creation and income distribution.

In a number of cases, accounting prices can simply be expressed as conversion factors, with a view to adjusting the market values derived from the financial analysis into social values used in benefit-cost analysis. Similarly, the social net present value can be considered the selection criterion: the technology or product showing the highest social NPV is defined as the "appropriate" technology or type of product. However, as the actual selection mechanism may include more elements than can be taken care of in a NPV criterion, some additional criteria may have to be considered as well.

The substantial progress made in the derivation of consistent sets of accounting prices for investment appraisal is reflected, among others, in the work of Little and Mirrlees (the OECD Manual (1968) and its successor volume (1974)), the UNIDO Guidelines (1972), the World Bank study of Squire and Van der Tak (1975), and, most recently, in the UNIDO Guide (1978). The latter suggests that project appraisal be broken down into five stages, each of which can be considered a measure of the net benefit of the investment proposal. According to the Guide (1978, p. 3), the five stages consist of:

1. Calculation of the financial or commercial profitability at market prices, using conventional cash flow analysis,
2. Conversion of the standard cash flow table into accounting prices to obtain the net benefit at economic or efficiency prices.

The next steps attempt to adjust the economic value of the net benefits for distributional impacts, viz.:

3. Adjustment for the impact on saving and investment,
4. Adjustment for the impact on income distribution,
5. Adjustment for the production or use of goods whose social values are considered less than or greater than their economic values (luxury consumer goods and basic needs goods, respectively).

Starting from the standard financial analysis (stage 1) the use of accounting prices and adjustment factors permits a complete economic (stage 2) and social appraisal (stages 3-5) by appropriately correcting the original market value of benefits and costs.

Prior to applying social benefit-cost analysis to alternative footwear manufacture technologies or to alternative types of footwear, two remarks should be made about the nature of accounting prices. As long as project alternatives are located in the same area, accounting prices will be the same for each alternative. However, if project alternatives are located in different areas, as may be the case when comparing small-scale alternatives to a large-scale firm, accounting prices are likely to differ from one location to another location. This may

be particularly true for the social cost of labour (i.e. the shadow wage rate) since the opportunity cost of the latter is not the same for all locations.

The use of accounting prices with a view to influencing the choice of project and/or technology, reflects policy objectives such as the reduction of unemployment or the focus of development efforts on special groups or regions. Project selection is, of course, not the only instrument to achieve certain development objectives, and its efficiency will have to be weighted against other policy measures. The extent to which a government may wish to use project selection as an instrument of development policy therefore co-determines the actual value of accounting prices. For example, if income distribution is of no interest to a government, social accounting prices will coincide with economic accounting prices.

Accounting values of benefits and costs may be adjusted with a view to improving income distribution (see stages 3 and 4 above). This may be illustrated with respect to the shadow wage rate (SWR). Considering stage 3, if a marginal addition to savings and investment to sustain future growth is considered more valuable than a marginal addition to consumption, if wage income entails a greater commitment to consumption than non-wage income, and if the government considers project selection as an instrument to influence the relation between aggregate consumption and investment, then part of the commitment to consumption which arises from employing more labour can be considered a social cost to society, necessitating an upward revision of the SWR.

Considering stage 4, if wage payments resulting from a project accrue in particular to low-income groups or if the project is located in a depressed area, and if the government is committed to improve the interpersonal and interregional distribution of income through the selection of projects, part of the wage payments is considered a social benefit to society, and will result in a downward adjustment of the SWR. Depending on a project's location, its impact on special socio-economic groups, and commitment to additional consumption, the SWR in the economic analysis will thus require adjustments in the social analysis to reflect various distributional concerns.

II.2 Appraisal of alternative technologies for type 1 footwear

(a) The data base

Following the approach indicated above, the social appraisal of alternative technologies and/or types of footwear can in practice be applied in two steps. First, an economic appraisal is undertaken by converting benefits and costs in the financial analysis into accounting values expressed in economic or efficiency prices. The latter are meant to reflect the real scarcity of commodities and factors of production and serve a purely allocative purpose. Differences between the economic and financial analysis therefore include the effects of correcting for market distortions and imperfections, external effects and taxation.

Next a social appraisal is conducted by adjusting the accounting values of benefits and costs in the economic analysis with a view to reflecting the impact on income distribution and the production or use of goods to which a special social value is attached. The actual conversion of economic into social values can be achieved either by the use of social accounting prices (which convert financial values directly into social values) or by the application of social adjustment factors.

An example of the conversion of benefits into accounting prices is presented in Table V.2 with respect to the machine-intensive type 1 shoe factory reported in chapter IV. Following the Little-Mirrlees approach, the accounting price for imported goods is simply obtained by removing all import duties and surcharges from their market value. The adjustment for the market value of unskilled labour reflects the prevailing unemployment rate, and yields a shadow wage rate which is lower than the market wage. Locally produced inputs are adjusted to allow for the accounting value of labour and imports. As the domestic market for shoes is protected against imports, the extent of protection is removed from the sales value. Due to the corrections needed to bring domestic prices in line with the equivalent of world market prices, no exchange rate adjustment needs to be made. For the sake of convenience, the discount rates are assumed to be the same in both analyses.

Because import duties on most intermediate inputs and equipment are relatively high in Ghana (approximately 40 and 45 per cent, respectively), and import duties on competing types of shoes are reported to be relatively low (around 10 per cent), value added and net operating

Table V.2

Conversion of cost and benefit items from market prices into accounting prices, Ghana, machine-intensive factory (¢ thousand)

Cost or benefit item	Market value	Import duties	Conversion factor	Accounting value
1. Direct materials	1,186			828
Imported	1,140	351		789
Local	46		0.85	39
2. Electricity	1		0.69	1
3. Spares, tools and equipment	11	1		10
4. Office overhead costs	29			24
Imported	4	2		2
Local	25		0.85	22
Intermediate inputs (1+2+3+4)	1,227			863
5. Staff and skilled labour	97		1.0	97
6. Other labour	27		0.75	20
7. Depreciation	22			16
Net operating profit (8-1 through 7)	427			624
Value added (8-1 through 4)	573			757
8. Ex-factory sales	1,800		0.90	1,620
9. Fixed capital	552			394
Imported	469	146		323
Buildings	63		0.85	53
Other local	20		0.90	18
10. Working capital	901			641
Imported	820	252		568
Local	81		0.90*	73
Total capital (9+10)	1,453			1,035
Net profit at 10% (8-1 through 7-10% of capital)	282			520
Net operating profit/ capital %	29.4			60.3

* Weighted average

Source: Calculated from McBain (1977) using additional assumptions.

profit are negatively protected. Net profits and the profit ratio are therefore substantially higher at accounting than at market prices as shown in the last column of Table V.2. The corresponding input structure also appears more in line with the earlier sectoral data mentioned in Chapter IV.

(b) Economic and social appraisal of alternative footwear manufacture technologies

The full economic appraisal of alternative technologies to produce 1,200 pairs of men's cemented shoe per day is summarised in Table V.3. Whereas the most machine- and most labour-intensive technologies are the same as in Table IV.2 (although their valuation is, in this case, different), the least-cost combination of techniques at accounting prices differs from that at market prices as shown by the number and composition of production workers. As in the case of the financial appraisal, differences in the attractiveness of the three technologies, as indicated by the net annual profit, are relatively minor, and the conclusions reached in Chapter IV apply for the economic analysis as well.

A comparison of the characteristics of the least-cost technology identified on the basis of market prices (Table IV.2) with those identified on the basis of economic accounting prices (Table V.3) shows, somewhat unexpectedly, that the social least-cost technology uses 12 fewer production workers than the least-cost technology identified on the basis of market prices. This interesting result, in a labour-surplus economy, illustrates, in a seemingly unusual fashion, the sensitivity of the least-cost mix of techniques for changes in relative factor prices. First, the high rates of import duty on capital equipment and the relatively small difference between market and accounting wage costs makes the machine-intensive processes relatively less attractive in financial than in economic terms. As a result, the least-cost technology is nearer to the labour-intensive end of the range of technologies when appraised in market instead of economic accounting prices.

Second, as observed in Chapter IV, capital substitutes to a large extent for skilled rather than for semi- and unskilled labour when technological alternatives available for a given type of footwear are considered. Hence, at accounting prices, the relatively more capital-intensive combination of techniques implies a shift in the skill mix

Table V.3

Economic characteristics of producing 1,200 pairs per day of men's cemented shoes with different technologies, in Ghana, valued at accounting prices (¢ thousand in 1972 prices and relative to sales, unless indicated otherwise)

Technology Cost or benefit item	Most machine-intensive		Most labour-intensive		Least-cost at accounting prices	
	Value	Ratio	Value	Ratio	Value	Ratio
1. Intermediate inputs	863	0.533	857	0.529	857	0.529
2. Total wages	117	0.072	146	0.090	129	0.080
Staff and skilled labour	97	0.060	120	0.074	104	0.064
Other labour	20	0.012	26	0.016	25	0.016
3. Depreciation	16	0.010	7	0.004	10	0.006
New operating profit (4-1-2-3)	624	0.385	610	0.377	624	0.385
Value added (4-1)	757	0.467	763	0.471	763	0.471
4. Ex-factory sales	1,620	1.000	1,620	1.000	1,620	1.000
5. Fixed capital	394	0.243	184	0.114	249	0.154
6. Working capital	641	0.396	649	0.400	649	0.400
Total capital (5+6)	1,035	0.639	833	0.514	898	0.554
Net profit at 10% (4-1-2-3-10% of capital)	520		527		534	
Net operating profit/capital %		60.3		73.2		69.5
7. Staff (No.)	36		36		36	
8. Skilled production workers (No.)	49		90		61	
9. Other production workers (No.)	70		92		86	
Total employed (7+8+9)	155		218		183	
Fixed capital/production worker (¢)	3,311		1,011		1,694	

Source : Calculated from McBain (1977), using additional assumptions.

in favour of processes employing less skilled and more unskilled labour. This shift in the skill mix is reinforced by the lower shadow wage rate for unskilled relative to skilled labour. As a result, the reduction of the total number of production workers by 12 is accompanied by a substantial change in the skill mix of workers: in the economic appraisal, 30 fewer skilled production workers but 18 more semi- and unskilled production workers are employed. The reduction in the number of workers is therefore concentrated in the category of skilled labour. This result is consistent with the assumptions underlying the accounting price determination of labour, viz., that in a labour-surplus economy, unemployment is mainly concentrated among the semi- and unskilled labour and skilled labour can generally be considered a scarce factor of production.

II.3 Data requirements and sensitivity analysis

The data required for the financial, economic and social appraisal of projects can be distinguished in two groups. The first group consists of data which refer to the physical characteristics in terms of inputs and outputs of the proposed project and to their valuation at actual or expected market prices. These data are obtained from engineering studies and actual quotations for the financial analysis reflecting the local conditions under which the project is expected to be constructed and operated. In the actual project preparation activities, such data are normally prepared by project engineers and financial analysts.

Most of the additional information for the economic and social analysis refers to "national parameters", such as the social rate of discount, and are, in principle, applied to all projects. These data, mainly accounting prices, are usually prepared by government planners at a central or regional planning office and require the expertise of project economists. In addition, project-specific circumstances may require adjustment or even separate estimation of some of the accounting prices. For example, a nationally determined SWR may have to be adjusted to account for local circumstances, or the accounting price of a special type of footwear be estimated separately if only the accounting price for an "average" type of footwear is available. Such estimates can usually be made independently by professional economists familiar with social benefit-cost analysis.

Even when a project has been properly prepared and appraised, it should not come as a surprise that, in reality, plant performance never turns out exactly as originally foreseen due to such factors as changes in the cost of major inputs, in the rate of capacity utilisation, in the pattern of learning, in the scale of operation, etc. A number of these factors were considered separately for the case of the 1,200 pairs per day men's cemented shoe factories in Ghana and Ethiopia by McBain (1977). The results of this analysis confirm several findings reported for products other than footwear. Low wages and high capital costs, underutilisation of capacity, and small-scale production tend to favour labour-intensive least-cost mixes of techniques. Economies of scale and higher product quality standards introduce a bias towards more machine-intensive techniques. Finally, shift working, changes in labour productivity, in the cost of direct materials and in working capital requirements have little effect on the composition of the least-cost mix of techniques.

III. Towards a national footwear manufacturing strategy

III.1 Factors influencing a national footwear strategy

A national footwear strategy concerns primarily the footwear manufacturing sector as a whole rather than individual projects. It therefore involves a number of factors which are not necessarily relevant to each individual project (linkages, organisation of production, training, price and market policies, tariff policies). However, as sectoral policies directly affect individual investment decisions, the analysis of individual projects is an indispensable input in the formulation of a sectoral strategy. For example, if changes in the least-cost combination of techniques arising from the use of accounting instead of market prices are of a systematic nature in most footwear projects, this finding should have important implications for sectoral, and possibly overall economic and fiscal policies. Another example refers to the existence of various fiscal policies (e.g. high protective tariffs against imports of footwear, exemptions of duties on import of intermediate inputs) biased in favour of large-scale footwear manufacturers, and which discriminate against small-scale producers. If such biases are

confirmed at the project level, it is through sector-wide, and possibly economy-wide policy measures, that such a situation can be reversed at the project level.

Findings from this and the previous chapters suggest the following, non-exhaustive list of factors which may influence a national footwear strategy, in particular with regard to product choice, level of scale, and production technology. The interaction between sectoral and project considerations is briefly mentioned whenever this is relevant.

(1) Size and composition of the market.

Analysis of domestic and export markets is an integral part of project analysis. Sectoral studies could indicate which sections of the domestic market can best be supplied by home production and which should be supplied through imports (if at all). Export possibilities, by type and quality of product, should be investigated. As far as the domestic market is concerned, its regional dispersion will affect transportation costs and the scale of production.

(2) Purchasing power of various economic groups, with a view to determining the type and quality of footwear for both the home and export market. The identification of the various sub-markets is part of the financial analysis. When certain types of footwear are considered a basic necessity, a (differential) social premium can be attached to the output of special types of footwear so that social benefits will exceed economic benefits when appraising an investment proposal. If preference for the domestic production of basic needs is very strong, cost-effectiveness analysis may suffice.

(3) Size of the initial capital investment.

If the profitability of the footwear factory which exhausts the overall investment budget of the footwear manufacturing sector is relatively high, there is a case for requesting more investment funds to be allocated to the footwear sector at the expense of other, less profitable sectors of the economy. The present value of capital costs should be estimated on the basis of the social discount rate.

(4) Availability of material inputs, mainly finished leather. Whether domestically produced or imported, the accounting price of the major raw materials should be used in order to ensure that the true scarcity of these materials is effectively taken into consideration.

(5) Backward linkages (tanneries, local production of machinery and equipment). Expansion of the footwear sector may cause additional demand for finished leather, other intermediate inputs, and capital goods. Such linkages should be considered at the project level once it has been shown that no alternative marketing opportunities for supplying sectors outside the proposed footwear project exist. At the sectoral level, the estimated additional demand generated by backward linkages could serve as useful information for the respective supplying sectors.

(6) Employment and income generation for unskilled labour. These factors depend on the rate of expansion of the footwear manufacturing sector and the nature of the technology adopted. The consequences of policies to foster employment and income generation for unskilled labour can best be analysed at the project level through a low shadow wage rate.

(7) Availability of key skills. These are reflected in the corresponding accounting price, and partly determine the most appropriate technology. Changes in the availability of local skills can be brought about by special training programmes and should be reflected in a relative decrease in the future accounting price of skilled labour.

(8) Foreign exchange savings. Information on the foreign currency component follows from the financial analysis. The valuation of foreign exchange earnings or uses is taken care of in the economic analysis through the choice of a proper accounting price of foreign exchange.

(9) Scale of production. The choice of a scale of production follows from considerations under (1), (2), (3), (6) and (7), as well as sectoral policy preferences regarding centralisation or decentralisation of production.

(10) Organisation of production. It determines the extent of product and process specialisation in separate production units.

(11) Sectoral price, tariff and fiscal policies. These follow, ideally, as implementation measures to ensure successful operation of existing and new footwear projects and should be consistent with national policies.

Some of these factors will be considered in more detail below. As countries differ considerably in size, resource endowments and stage of development, the best combination of products, scale of production and technologies is likely to be different for different countries. The presentation of a strategy for a particular country seems therefore of limited usefulness and will not be attempted in this study.

III.2 Comparative advantage, social considerations and product choice

In terms of resources, especially materials and labour, many developing countries are well placed to expand their production of footwear. Where basic skills are available and the necessary materials are of sufficient quality (either from domestic tanneries or imported, see sub-section III.3 below), the present level of wages in most developing countries gives them a distinct cost advantage over high-income countries. The high level of labour productivity resulting from machine-intensive methods of production in the developed countries is more than offset by the high level of wages, so that labour costs per unit of output are substantially higher than in most of the less-developed countries, even though labour productivity in the latter countries could be relatively low.

Because of the variety of footwear products which can be produced at competitive prices, developing countries are faced with two major options with respect to potential markets to be served: (1) The development of a domestic industry, the market for which can be initially based on import substitution, and subsequently on increasing per capita incomes.¹ (2) The development of an export industry based on the considerable comparative advantage which developing countries can be shown to possess. Whereas the cost advantage will generally be sufficient to face international price competition, quality aspects are equally crucial for a successful penetration of the export market. Hence, the level of skills, management and quality control necessary to enter the international markets will generally be high, and is likely to be very different from the lower technical levels at which domestic products are manufactured. In the absence of

¹Being a basic needs good, the demand for footwear increases relatively fast with increasing incomes among low-income groups.

experience in modern footwear assembling methods, the development of production units for the domestic market seems therefore essential to acquire the technical and managerial experience necessary to compete successfully in the export markets.

As shown in Chapter IV and Section I , the manufacture of high-quality leather-uppered footwear appears very attractive. The use of valuable leather materials for the production of the more expensive types of footwear is justified by the high price these products command, the favourable economic surplus and private profitability, the high level of employment creation resulting from the generally labour-intensive way in which these products are manufactured, and the type of craft-based skills required. By contrast, the most inexpensive types of footwear, which are meant to serve the large majority of the population, are based on synthetic materials and require large-scale, capital-intensive production units, which create very few jobs, require specialised technical skills, have less backward linkages, if any, and are a potential threat to small-scale producers of low quality leather footwear. It is therefore suggested that future research and investment be directed towards the development of those low-priced, medium-quality footwear products that can be produced in a more labour-intensive way, make use of local, inexpensive materials and are complementary to rather than competitive with existing small-scale producers.

In cases where certain types of footwear are favoured because they constitute basic needs goods (e.g. plastic sandals), such a preference may be expressed by adding a (differential) social premium to their economic value when appraising alternative footwear projects. This is particularly relevant when low-income consumers cannot afford the initial expense to buy high-quality footwear, but the product price of the cheaper substitute matches the threshold price for low-income groups. Obviously, such a social premium will be difficult to establish in actual situations. In such a case, a practical device is to estimate the switching value of the premium, i.e. the amount by which the economic benefits of producing a particular type of footwear will have to be raised in order to make the project socially preferable to other types of footwear. In this way, the social cost of satisfying certain basic needs (employment forgone, less use of local materials, fewer foreign exchange savings) can be ascertained and be weighted against other alternatives.

III.3 Backward linkages and availability of raw materials

(a) Backward linkages

The major backward linkages resulting from the operation of footwear factories refer either to finished leather (used for the production of leather footwear) or to synthetic materials, mainly plastics, used in the manufacture of synthetic footwear. Minor backward linkages include the production of various tools and pieces of equipment used in footwear manufacturing and that of intermediate inputs such as nails, glue, fabrics, etc.

Backward linkages are of interest in the only case where these tools, equipment and materials can be produced locally since imports do not contribute to an increase of the national value added. Furthermore, the footwear manufacturing sector may need to compete against other sectors and/or exports in order to acquire the needed inputs (e.g. leather) whenever the supplying sectors cannot expand their production (supply constraint). In this latter case, benefits derived from backward linkages would be limited. The use of leather in the local manufacture of footwear instead of exporting it does not yield backward linkages with the leather producing sector.

(b) Raw materials

The decision as to which raw materials should be favoured is not an easy one to make. This may be illustrated by the following examples. If a country has no local capacity to supply plastics suitable for footwear production, but does have a number of leather tanneries producing semi-finished (wet blue or crust) and finished leather of different quality, the decision to manufacture leather types of footwear may seem obvious at first sight, but could nevertheless be premature, or even incorrect, when based on the availability of local leather only. First, if local production of plastics used for footwear is not competitive with imports, the decision not to produce plastics locally is a rational one: the foreign exchange impact of an inefficient production unit would certainly exceed the foreign exchange savings through import substitution. However, the production of sandals with imported plastics may still be economically or socially feasible (i.e. no project should be penalised for its using imported synthetic materials). Second, when leather has a potential export market, the use of locally produced finished leather in domestic footwear

production implies that potential foreign exchange earnings are foregone. Under these circumstances, it should first be ascertained which alternative use of leather yields the highest return. This factor may further justify the import of plastics for the production of sandals.

The quality of locally produced leather, reflecting both the quality of hides and skins and local tanning capabilities, is an equally important factor. If high-quality hides and skins are locally available, but tanning capabilities are yet insufficient to produce high-quality finished leather, a decision must be taken regarding the stage at which leather can best be processed (wet blue, crust or finished). In such a situation, it could well be rational to export semi-finished leather and, at the same time, import finished leather for domestic purposes. Meanwhile, the local capacity to finish leather could be gradually built up. If, on the other hand, hides and skins are of a medium to poor quality and export prospects for leather are therefore less favourable, local processing up to the stage of finished leather could be justified when the leather can be used for the manufacture of medium-quality leather footwear meant to serve local markets.

III.4 Employment, technological choice and skill requirements

For typical conditions in developing countries, the least-cost combination of techniques to manufacture footwear products turns out to be labour-intensive in terms of fixed capital per worker. Thus, the adoption of the latest developed-country technology cannot be generally recommended for a less-developed country.

Savings in capital costs and the creation of additional employment can be substantial when employing a labour-intensive or intermediate technology instead of a machine-intensive technology. Both the Ghanaian and Ethiopian case studies show that application of the most machine-intensive instead of the most labour-intensive technology implies almost a doubling of fixed capital requirements, a reduction of total employment of about 30 per cent, and hence an increase in the capital-labour ratio by a factor of 3. However, the effect on overall profitability of choosing least-cost technologies, though positive, is less pronounced. This finding carries two important implications: (1) it explains why firms adopting

latest developed country technology easily survive in an environment of low wages and high capital costs, and (2) a strong concern with employment creation need not imply important sacrifices in other areas, although the implementation of labour-oriented development strategies may face serious problems in view of the first implication.

It may also be recalled that the nature of capital-labour substitution in manufacturing a particular type of footwear product appears to be such that capital substitutes to a larger extent for skilled than for unskilled labour (i.e. labour-intensive technologies are characterised by both a large number and a high proportion of skilled workers). When comparing least-cost technologies for different types of footwear, variations in labour requirements across products are substantial, but variations in fixed capital per employee are comparable to those amongst technologies for the same type of footwear. The nature of capital-labour substitution across products is such that capital-intensive products tend to be associated with a high proportion of skilled labour.

As far as leather-upper shoes are concerned, opportunities for substitution are greater between alternative technologies for a particular type of footwear than between different types of shoes. The reverse is true, however, when footwear made of synthetic material is considered. When the various types of footwear made of different materials are considered simultaneously, variations in capital-intensity are definitely greater across products than between technologies to produce a particular type of footwear.

The higher priced leather-upper shoes generally demand an absolute number of skills far higher than that for the less expensive varieties made of synthetic materials. It is likely, however, that the type of skills required for the manufacture of synthetic footwear (both in production and maintenance activities) is far more scarce in developing countries than the type of skill necessary for the other, more craft-based products.

III.5 Other factors

A number of additional factors should be taken into consideration when formulating a national footwear production strategy. These factors, already mentioned under

points (7) to (11) in section III.1 are briefly discussed below.

(a) Foreign exchange savings

In general, the majority of developing countries - especially small to medium size countries - do not yet have a strong capital goods sector. Thus, equipment used in many industries - including the footwear industry - must generally be imported. The foreign exchange component of fixed capital equipment used in footwear manufacturing will generally be high whenever one or more of the following conditions apply:

- use of machine-intensive processes instead of labour-intensive ones to produce the same type of footwear,
- choice of capital-intensive footwear products (e.g. plastic sandals) instead of labour-intensive products (low quality leather shoes),
- adoption of large scales of production.

The choice of raw material may also increase the fraction of foreign exchange in total production costs.

On the other hand, the production of footwear may generate substantial foreign exchange earnings through exports to neighbouring developing countries and/or developed countries. Whenever exports are intended for developed countries, the required footwear quality and the volume of exports should generally be such as to require the use of capital-intensive technology and the adoption of large scales of production, thus offsetting a relatively large proportion of foreign exchange earnings (especially if quality leather must also be imported). In general, foreign exchange earnings should be larger than foreign exchange expenditures. However, the difference may not always be so large as to justify the export of footwear to developed countries.

On the other hand, export of footwear to neighbouring developing countries could be particularly attractive since the required footwear type and quality should be similar to those in demand at home, and since the volume of exports need not be too large. Consequently, labour-intensive or intermediate technologies and small scales of production may be adopted for the production of this type of exports. In general, these exports should have

a large positive impact on the balance of payments than would exports of footwear to industrialised countries.

(b) Skill requirements

Whereas the machine-intensive production processes and products require fewer skills than do the more labour-intensive alternatives, the nature of the skills differ considerably from the more craft-based skills traditionally used in the labour-intensive methods of production. At higher scales of production, this effect will be reinforced, both at the technical and managerial levels. Large-scale, machine-intensive footwear factories will therefore normally require special training programmes and/or availability of expatriate personnel.

(c) Scale of production

Least-cost combinations of techniques tend to become more labour- and skill-intensive at low scales of production. In the modern, organised sector, economies of scale through savings in fixed capital, staff and skilled labour favour the set-up of larger production units. Compared with small- and medium-scale producers in the modern sector (employing up to 50 workers), however, artisanal or handicraft production of footwear in the traditional, unorganised ("informal") sector appears more attractive. Compared with producers in the large-scale modern sector, artisanal production of footwear, usually carried out in units employing less than 10 or even less than 5 workers, is less profitable, but creates considerably more employment (in the Ethiopian case 3 to 4 times as much). Policies which favour the profitability of small footwear production units (e.g. through improvement of techniques, training) in markets where they can be expected to remain competitive, should therefore be encouraged. Policy measures may include the creation of better marketing facilities, better access to and conditions for obtaining credit, ensured supply of essential inputs, improvement of production methods to increase productivity, etc.

In addition to these measures, policies which encourage specialisation by small-scale and artisanal enterprises can substantially improve their profitability. Details of such policies were discussed in Chapter IV.

(d) Sectoral price, tariff and fiscal policies

When contrasted with an analysis based on local market prices, the analysis of alternative technologies based on economic and social accounting prices has important policy implications for sectoral price and trade policies and overall fiscal policies. In general, these policies should be designed in such a way as to induce the selection of those least-cost combinations of techniques that suit a particular country best in terms of its development objectives and real scarcity of factors of production. To this effect, (selective) price and tariff measures and various incentive schemes will have to be utilised. For instance, if the prevailing system of market prices is such that, in a labour-surplus environment, no appreciable labour-intensive techniques are selected, but rather machine-intensive varieties are preferred, the following measures to redress this situation may be applied: (1) high import tariffs on imported capital goods, (2) no application of low interest rates "to stimulate investment" indiscriminately, (3) wage subsidies, implemented through fiscal exemptions, to encourage the use of labour-intensive methods and equipment, (4) no excessive tariff protection which would remove incentives to become competitive and enable machine-intensive technologies to survive easily. Although the specific measures to be taken will differ from country to country, the examples mentioned serve as an illustration of the type of measures conducive to the adoption of more labour-intensive technologies.

APPENDICES

APPENDIX I

GLOSSARY OF TECHNICAL TERMS

- | | |
|----------------|--|
| Adhesive | - A substance used to hold materials together by surface attachment. The term is used interchangeably with cement. |
| Attaching | - Fastening of sole unit or sole and heel to a lasted upper. |
| Back-seam | - The seam down the back of a closed upper which is often covered by a vertical strip called a 'back strap'. |
| Backpart | - The rear of the shoe. |
| Binding | - The leather or tape strip that is used to cover the top line of some uppers. |
| Bottom | - The part of the shoe below the foot. |
| Bottom filling | - Cork, leather or felt used to fill the cavity between the sole and insole on the forepart and seat. |
| Brogue | - A lacing shoe with a closed front and serrated and punched upper. |
| Casuals | - Low heels footwear, produced without fasteners. |
| Cement | - See 'adhesive'. |

- Cement shoe - A shoe in which the sole is cemented to the lasted upper.
- Cement lasting - The attaching of the upper to the insole by cement.
- Chain stitch - A stitching configuration which uses a bottom thread only. It is rarely used for closing uppers (See Fig. A.1)
- Chappal - Open backed sandals with cross-over straps on the forepart.
- Clicking - The cutting of upper components from skins or sheet material.
- Closing - Assembling the components of the upper by stitching or other fastening methods.
- Conditioning - See 'Mulling'.
- Counter - A sheet component, usually with skived edges, which is inserted into the back of the upper to add rigidity.
- Court shoe - Low cut shoe for women, with medium height heels and no fastenings.
- Dress shoe - Although originally the term only referred to shoes for formal wear, it is now used for any shoe which is not a casual, sport or work shoe or slipper.
- Embossing - A method of printing in or raising up ornamentation on a surface by heat and pressure.
- Feather edge - The edge of the insole.
- Fibreboard - Sheet material made from long vegetable fibres, used for insole, stiffeners, etc.
- Finishing - Final cleaning, polishing and inspection operations.
- Flash - Plastic attached to a moulding down the mould parting line.

- Folded edge** - The edge of a skived upper which has been turned over to give a neat finish.
- Forepart** - The front of a shoe.
- French binding** - Finishing the top edge of the upper with fabric binding (this process is explained in the text).
- Heel** - The rear portion of the bottom of a shoe.
- Hide** - The skin of a large animal.
- Injection moulding** - A technique in which pre-heated plastic is forced into a cool cavity where it adopts the shape of the cavity before solidifying.
- Insole** - The layer of sheet material between the foot and the sole.
- Last** - A mould of wood or plastic on which the shoe is built. Lasts may be solid or hinged in the middle.
- Lasting** - The moulding of the upper material to the shape of the last. Often, the lasting margin is attached to the insole bottom.
- Leather finishing** - The final processing of the surface of the leather after lasting.
- Lining** - Quarter and vamp linings are of lightweight leather or other leather substitute.
- Lock stitch** - A stitching configuration which uses a top and bottom thread. It is the most popular method of stitching together upper components (see Fig. A.1).
- Making** - A term used to describe lasting and associated processes.
- Marking** - The printing or stamping of sizes and other details on linings.

- Mocassin - Shoes in which the vamp is a single piece of leather passing completely under the foot.
- Moulding-on - Injection moulding of a sole to its finished shape directly to a lasted upper.
- Mulling - The application of water or water vapour to leather in order to temporarily increase its flexibility.
- Pattern - Sheets of metal or board shaped to the outline to which the upper component will be cut.
- Pattern grading - Scaling sizes up and down from a standard sized pattern.
- PVC - Polyvinyl Chloride, a thermoplastic compound which has outstanding resistance to water, alcohols, acids and alkalis. It is widely used for shoe uppers and soles.
- Pulling over - It often constitutes the first making operation in which the upper is pulled over the last.
- Quarters - The part of the upper above the vamp line.
- Roughing - See 'Scouring'.
- Rubbing down - The flattening of seams to reduce their bulk.
- Scouring - Removal of the grain and finish on the lasted margin of the upper by wire brush or abrasive so that it may receive cement for attaching.
- Seat - The area of the shoe under the wearer's heel.
- Shank piece - Bridge of wood, metal or plastic which is attached to the bottom of the insole. It is often referred to as the 'shank'.

- Size** - A code number which distinguishes a particular shoe length.
- Skiving** - Thinning and tapering the edge of upper components to reduce the bulk of seams and to increase wearer comfort (see Fig. A.2 which illustrates various skiving methods).
- Sock** - Inner sole partially or completely covering the top of the insole.
- Sole** - The part of the shoe in contact with the ground.
- Splitting** - Dividing leathers into two or more layers.
- Style** - Usually, a particular design of footwear available in a variety of sizes, fittings and colours.
- Stitch marking** - Marking stitch guide-lines on the upper with chalk, crayon, etc.
- Suede** - Leather having a nap surface.
- Tabs** - The front part of the quarters on Derby lacing shoes which carries the eyelets and covers the tongue.
- Tack lasting** - Lasting uppers to insoles using tacks as fasteners.
- Toe puff** - Sheet stiffener attached inside the toe of the upper.
- Top piece** - The layer of the heel in contact with the ground. It is also called the 'top lift'.
- Trimming** - The removal of surplus material from the upper or from the edge of the sole and heel.
- Unit sole** - Combined sole and heel prefinished before attachment to the shoe. Also called 'unit'.
- Upper** - The part of the shoe that covers the top of the foot.

- Vamp
- The lower part of the upper which is attached to the sole between the toe-cap and the quarter.
- Vulcanising
- A chemical process used to melt, mould or attach rubber soles to lasted uppers by heat or pressure in a closed cavity.
- Welding
- A method of joining thermoplastic footwear components by the application or generation of heat.
- Welt
- A leather strip stitched to the margin of the upper in welted footwear. The welt is also stitched to the top surface of the sole.
- Width
- A letter coding for measuring shoe girths.

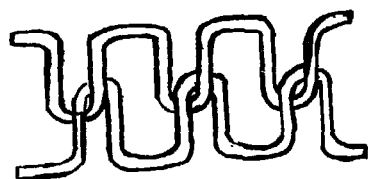

Lock

STITCH TYPES

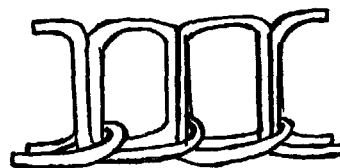

Chain

SEAM TYPES



Closed seam opened



Silked seam



Butted seam



Lapped seam



Corded seam

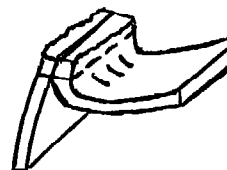

Open mocassin seam

BINDING TYPES



Flat



French

Figure A.1

Stitching Configurations

Raw edge and closed
seam edge

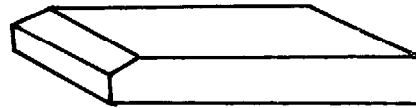

Lasting edge

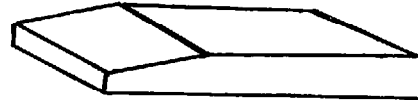

Skive for heated
iron edge

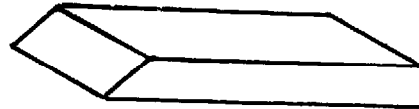

Skive for cemented
and folded edge

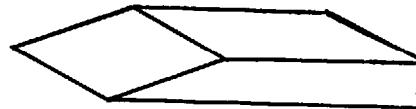

Lapped seam
edge

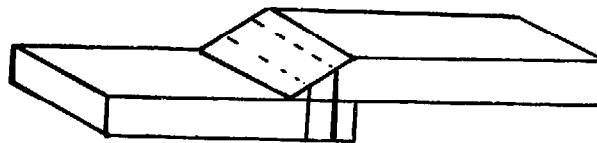

Figure A.2

Various skiving methods

APPENDIX II

List of equipment suppliers

Annex II.1 :Key to suppliers' numbers given in Annex II.2

Equipment Ref.No.	Operations	Suppliers (see list of names and addresses in Annex II.2)
1	Upper cutting	18, 74, 78, 79, 124, 41, 138, 111, 64
2	Leather splitting	5,27, 78, 29, 17, 4, 125, 149, 150, 151.
3	Lining marking	
4	Stitch marking	5, 84, 144
5	Hole punching	78, 120, 124, 4, 55, 139, 64, 115
6	Sock embossing	105, 5, 18, 77, 78, 124, 35, 101, 62
7	Leather skiving	18, 78, 35, 125, 4, 16, 104, 11, 70, 57, 19, 3
8	Edge folding	78, 126, 4, 16, 136, 11, 55, 115
9	Upper stitching	129, 22, 67, 98, 31, 68, 123, 103, 69, 16, 85, 73, 46, 137, 70, 89, 71, 142, 72, 114, 115, 107, 110
10	Seam reducing	97, 78, 37, 126, 11, 64
11	Taping	78, 106, 118
13	Eyeletting	95, 5, 6, 119, 27, 79, 121, 4, 16, 136, 106, 58, 3
15	Puff attaching	32, 124, 11, 64
16	Upper trimming	32, 124, 11, 64, 78
17	Insole cut and bevel.	5, 78, 4, 135, 67, 59
21	Upper conditioning	118, 24, 28, 33, 34, 16, 86, 61, 88, 143
22	Lasting	21, 118, 94, 5, 23, 28, 78, 30, 33, 7, 122, 124, 83, 129, 130, 4, 16, 104, 47, 11, 48, 136, 88, 139, 108, 109, 62, 56, 14, 91, 15, 59, 64, 60, 66, 141

Annex II.1 - (continued)

Equipment Ref. No.	Operations	Suppliers (see list of names and addresses in Annex II.2)
23	Tack removal	66, 59
24	Heat setting	78, 138, 139, 15, 91, 115
25	Bottom roughing	78, 129, 135, 136, 52, 12, 139, 91, 64
29	Sole laying	21, 25, 78, 99, 79, 127, 4, 132, 134, 44, 47, 91, 116
31	Upper finishing	24, 76, 32, 124, 35, 102, 16, 134, 43, 109, 92
35	Sole moulding	1, 2, 78, 99, 38, 122, 81, 39, 131, 42, 104, 50, 52, 13, 140, 65, 3
37	Sole preparation	78, 124, 136, 91, 64
44	Sole stitching	78, 124, 36, 37, 80, 45, 91, 64
46 and 47	Seat and heel nailing	96, 26, 78, 4, 16, 136, 47, 138, 91, 64, 92
49 and 50	Heel and edge trimming	28, 78, 32, 79, 8, 40, 4, 104, 138, 143, 92
51	Bottom finishing	5, 78, 121, 124, 100, 102, 16, 133, 135, 136, 51, 138, 91
52	Upper welding	79, 101, 132, 137, 53, 55, 139, 90, 60, 113, 115
54	Last string attaching	39, 82, 112
62	Injection moulding	122, 38, 125, 81, 39, 128, 42, 9, 10, 50, 13, 63

Annex II.2 Names and addresses of equipment suppliers

Supplier number	Name and address
	<u>BELGIUM</u>
1.	ACEC, 52 Dok, GHENT, B-9000
	<u>CANADA</u>
2	BATA ENGINEERING, c/o BATA INTERNATIONAL, Don Mills, Ontario
3	USM Ltd., 2610 Bennet Ave., MONTREAL H1V2T8
	<u>CZECHOSLOVAKIA</u>
4	INVESTIA, Praha 10, KODANSKA, Dept. 921
	<u>FRANCE</u>
5	ANVER S.A., 4, rue Suchet, 92470 MAISONS-ALFORT
6	V. BERAUD, 1 avenue Duchesne, 26104 ROMANS
7	R. FAVRAUD, Route de Vars-Roffit, GOND-PONTOUVRE
8	P. GOUDIN, 49 ST-PIERRE, MONTLIMART
9	MAUSERIET, B.P. 16, LES HERBIERS - 85500
10	MOURALT et Cie., 63, rue d'Allonville, NANTES
11	Ets. OMIC, 10, rue Barbanegere, 75019 PARIS
12	PROST-DAME, 94-100 rue Baraban, LYON
13	SEFOM, 19 rue Théodore de Banville, 75017 PARIS
14	SOFRAGRAF, 5, rue Marx-Dormy, 94230 CACHAN
15	SUTEAU, M. DUTEAU, rue de Cholet 49, ST MACAIRE-EN-MAUGE
	<u>HUNGARY</u>
16	KAEV K.G.V., 1064 BUDAPEST VI ROZSA FU55

Annex II.2 (continued)

INDIA

- 17 HINDUSTAN ENGINEERING WORKS, 1328/2 Jawahar Nagar,
KOLHOPUR 416001
- 18 APPEX MACHINERY, 37/209 A Saran Nagar, Dayalgaghrd, AGRA-5
- 19 CHENS BROTHERS, 50 S. Tangra Rd, CALCUTTA 700046
- 20 M/S BATA INDIA Ltd., Batanagar, 24 PARGANAS, W. Bengal

ITALY

- 21 ALBE DI ALBELLI Giuseppe, 51015 Monsummara Terme, VI
Via Francesca Nord 182,
- 22 ALFA FIAM, Via Ampere 104, MILANO 20131
- 23 ARNERI Franco, SS494 Localita S. Antonio di Parona,
27020 PARONA
- 24 T. DI BALASSO, Via Albini 3, 27029 VIGEVANO
- 25 BANF, Viale Rafaelo Sanzio,106, 27036 MORTARA
- 26 BETA, Via Giacomo 8 27029 VIGEVANO
- 27 BOMBELLI, S. Lorenzodi Parabiago, 20015 MILANO
- 28 BRUGGI S.A., C. So. Torino 114, 27029 VIGEVANO
- 29 CAMOGA S.A., Via Oroboni 27, 20161 MILANO
- 30 CERIM, C. So Novara 218, 27029 VIGEVANO
- 31 CMCI, Via G. da Mogliano 1, FERMO
- 32 COLLI F.G.B., Via Gioberti 17, 27029 VIGEVANO
- 33 DEROV, Via Gambolina 19, 27029 VIGEVANO
- 34 ELECTTRO, Via P. Luigi Albini 3, 27029 VIGEVANO
- 35 EELEGI Spa, Via Beccaria 22, 27029 VIGEVANO
- 36 FALAN, Via Trieste 6, 27029 VIGEVANO
- 37 FIMAE , Via Bellini 23, 27029 VIGEVANO

Annex II.2(continued)

38 FERRARI and Figli, Piazza Duca d'Aosta 12, 20124 MILANO
39 GESTA, Via Silvio Pellico 12, 20027 RESCALDINA
40 GUATTEO TERENCEIO, Via Carlo Alberto 160, 27023 CASSOLNOVA
41 LOMBORDO, Via S. Cecilia 6/24, 27029 VIGEVANO
42 LORENZIN, Strada Adriatica, 35020 ALBIGNOZEGO
43 MANTEGAZZA, 20089 ROZZANO MILANO
44 MEC-VAL, Via V. Bellini 21, 27029 VIGEVANO
45 MINOLA, Via Baldrini 20, 27029 VIGEVANO
46 NECCHI Spa., Via Rismondo 78, 27100 PAVIA
47 NIEVE, Via della Gioia 46/A, 27029 VIGEVANO
48 OMAV, Via M. Gianolio 15, 27029 VIGEVANO
49 OMSA, Via Sabotino 19, 27029 VIGEVANO
50 OTTOGALLI, Zona Industriale 9A Strada, 35100 PADOVA
51 PISARONI G., Via Manzoni 7, 20019 SETTINO MILANESE
52 PLASTIMATIC, Via Alessandria 7, LEGRANO
53 POLETO, F., Via Marzabotto 27, 27029 VIGEVANO
54 REMAC N., Via Gianolio 35, 27029 VIGEVANO
55 SAGITTA, Via Farini 43, 27029 VIGEVANO
56 SILVA FAUSTINO, Via Rosmini N. 10, 27029 VIGEVANO
57 SPILOTTI and Figli, Via Aguzzafame 14, 27029 VIGEVANO
58 S.P.S., Via Sesia 14, 27029 VIGEVANO
59 TECNO-2, Via Orto 70, 27029 VIGEVANO
60 TORTI and BOCCA, Via M. Gianolio 33, 27029 VIGEVANO
61 RINALDI E., Via 24 Maggio 38, P.O. Box 61, 20015 PARABIAGO
62 SICOMECC, Via Mameli 16, 27024 CILAVEGNA
63 TOMAYER E., Via Bornassa 24, 28066 GALLIATE

Annex II.2 (continued)

- 64 TORIELLI, Via L. da Vinci 130A, 20090 ZINGORE DI TREZZANO S/N
65 UNION S.A., Via Pierobon 47, 35010 LIMENA
66 Valente V., Via G. Modera 3, 20129 MILANO

JAPAN

- 67 BROTHER IND. 35-9 Chome, Horita-Dori, Mizuho-ku, NAGOYA
68 CONSEW INTERNATIONAL, Yamajin Bldg, 1 Chome, Higashi-ku OSAKA
69 TOKYO JUKI INDUSTRIAL CO., 23 Kabuki-cho,
Shinjuku-ku, TOKYO
70 SEIKO SEWING MACHINE Co., 6 Asakusa Yoshino-cho, 1 chome,
Taito-ku, TOKYO
71 SINGER SEWING MACHINE, 25, 2-Chome, Azabu-Ichibeicho,
MINATO-KU
72 SUPER-ROLL Mfg. Co, 11-18, 2 chome, Harakawa, Nishiyodogawa-ku
OSAKA

NETHERLANDS

- 73 MUVA, Valkenburg 5110, Postbus 33, CREMERSTRAT 10

UNITED KINGDOM

- 74 ART PATTERN and KNIFE Co., Bedford St., LEICESTER LE1 3JP
75 G. BARNSELY Ltd., Cornish St. SHEFFIELD S6 3AD
76 BINKSBULLOWS Ltd., Pelsall Rd. BROWNHILLS, Staffs
77 BLOCKMASTER, 56 Benwell Road, LONDON N7 7BA
78 BUSM Co., Ltd., Belgrave Road, LEICESTER LE4 5BX
79 COX AND WRIGHT Ltd., P.O. Box 27, Wellingborough Rd., RUSHDEN
80 FOOTWEAR PLANT AND EQUIPMENT Co., 10-14 Roman Road,
BRISTOL BS5 6EB
81 FOSTER-FINCH Ltd., Greengates, ACCRINGTON, Lancs.
82 GILTSPUR INDUSTRIES- Egypt Road, NOTTINGHAM NG7 7GU

Annex II.2 (continued)

UNITED KINGDOM

- 83 INTERNATIONAL SHOE MACHINERY Ltd., Radnor Road,
WIGSTON, LE82XY
- 84 LIVINGSTONE and DOUGHTY, 17 Mandervell Road, CADBY Leicester
- 85 G. MACPHERSON Ltd., 2/4 Bridgford Road, WEST BRIDGFORD,
Nottingham
- 86 PROCESS EQUIPMENT DEVELOPMENTS, 35 Strode Road,
WELLINGBOROUGH NN81JU
- 87 REMPSTONE ENGINEERING Ltd., Bakewell Road, LOUGHBOROUGH
Leicester
- 88 SALIENT ENGINEERING Ltd., 4 Oak Lane, BRISTOL BS5 1JY
- 89 SINGER CO., Ltd., 91 Coleman Road, LEICESTER LE54LE
- 90 STAFFORD TOOL and MACHINERY CO., St, Patrick Place,
STAFFORD
- 91 STANDARD ENGINEERING CO., Evington Valley Road,
LEICESTER LE5 5LZ
- 92 TRUE BROS. Ltd, 98 Cannock St. LEICESTER LE4 7HR

USA

- 93 ACKERMAN-GOULD Co., 10 neil Court, OCEANSIDE, L.I. N.Y. 11572
- 94 AMERICAN SHOE MACHINES, 30 Nashua St. WOBURN, Mass.
- 95 AMERSHOE, 456 Nordhoff Place, ENGLEWOOD, N.J. 07631
- 96 AUTO SOLER Co., ATLANTA, Georgia
- 97 BOSTON MACHINE WORKS, 7-17 Willow St., LYNN, Mass. 01903
- 98 CAMATRON MACHINES, 155 West 26th St., NEW YORK
- 99 COMPO SHOE MACHINERY Co., 125 Roberts Road, WALTHAM, Mass.
- 100 DIAMOND MACHINERY Co., River Road, LEWISTON, Maine
- 101 T.J. EDWARDS Inc., 25 William St, P.O. Box 8, BOSTON, Mass. 02130
- 102 L. FREEMAN Co., 1819 Freeman Ave., CINCINNATI, Ohio 45214

Annex II.2 (continued)

USA

- 103 H. JAFFE, 40-11 Skillman Ave. LONG ISLAND CITY, N.Y. 11104
104 LUDLOW ENTERPRISES Inc., 333 Scholes St., BROOKLYN,
N.Y. 11206
105 MARKEM MACHINE CO., P.O. Box 480, KEEN, New Hampshire
106 PRIME MFG. Co., 545 Washington St., LYNN, Mass. 01901
107 REECE FOLDING M/C Co, P.O. Box 279, WOBURN, Mass.
108 M. SCHWABE M/C's, 147 Prince St., BROOKLYN N.Y. 11201
109 SENCO PRODUCTC INC., 8485 Broadwell Road, CINCINNATI,
Ohio 45244
110 SINGER Co., 275 Centennial Ave., PISCATAWAY, N.J. 08854
111 SOUTHERN SHOE M/C's, 450 Allied Drive, NASHVILLE, Tenn. 37204
112 STITCH-RITE Corp., Locust Str. IPSWICH, Mass 01938
113 THERMATRON, 60 spence St., BAYSHORE, N.Y. 11706
114 UNION SPECIAL M/C Co., 400 N. Franklin St. CHICAGO, Ill. 60610
115 USM CORP., 181 ElliotttStr., BEVERLEY, Mass.

USSR

- 116 TECHMASH EXPORT, Mosfilmovskaja35, MOSKOW 117-330

FEDERAL REPUBLIC OF GERMANY

- 117 ADLERMASCHINEN WERKE, 4800BIENEFELD Pf. 103/105
118 ALBEKO SHOE MACHINERY, D-6000 FRANKFURT/MAIN, spf 119180
119 BERNING AND SOHNE, 56 Wupper Tal 2, OBERDORNEN
120 BIMA, 7450 HECHINGEN, P.O. Box 1205
121 DESCO, 607 Langen bei Frankfurt, Pittlestras. 46
122 DESMA, 28074 CHIM BEI BREMEN, Desmastr. 3/5

Annex II.2 (continued)

- 123 DURKOPPWERKE, 4800 BIELEFELD, Niederwall 29
- 124 DVSG, 6 FRANKFURT/MAIN, 13/31 Fredrich-Ebert Anlag
- 125 FORTUNA, 6000 FRANKFURT/MAIN 70, Dreieccstr., 59
- 126 G. FRANK, 678 PIRMASENS, Haupstr. 16
- 127 Dr. Ing. FUNCK, MUNCHEN-PASING, Haidelweg 20
- 128 GOD MASCHINENBAU 8 MUNCHEN 2, Sonnenstr. 27
- 129 w. GUTH, 6780 PIRMASENS-RUHBANK, Erlenbrunner St. 51
- 130 E.G. HENKEL, 6078 NEU ISENBURG, Pf. 365
- 131 HESTIKA WERKZ, D-7140 LUDWIGBURG, Pf. 580
- 132 KIEFEL-KORTING, D-8228 FREILASSING, Sude erstr. 3-7
- 133 LIBA, 8671 NAILA OBERKLINGENSPORT
- 134 T. LIEBROCK, 678 PIRMASENS-ERLENBRUNNER, Kettrighofstr 34
- 135 E MOHR ACH, 6661 RIESCHWEILER, Nunschweilerstr. 3-5
- 136 MOENUS, P.O. Box 1367A, FRANKFURT/MAIN, West 13
- 137 G. PFAFF, 675 KAISERSLAUTERN
- 138 J. SANDT, 678 PIRMASENS, Lembergerstr. 82, Pf 940
- 139 SCHON and Cie., 6 PIRMASENS, Pf. 115
- 140 R. SCHLICHT, 2 HAMBURG 70, Brauhaussteeg 12
- 141 SIECK INTERNATIONAL, 8580 BAYREUTH, Pf. 2928
- 142 SINGER A.G., FRANKFURT/MAIN 6, Gutleutstr 42-44
- 143 STEIN, 678 HINTERWEIDENTHAL, Turnstr. 5
- 144 J. STROBEL and SOHNE, 8000 MUNCHEN W. 12, Heimeranstr. 68-70
- DENMARK
- 145 V. PEDERSEN, DK-4270

Annex II.2 (continued)

SPAIN

- 146 ALVAREY-VALLS, Consejo di Ciento 360, BARCELONA 9
147 P. FREIRE, Paulino Freiro Pineiro 26, BONZAS (Vigo)

SWEDEN

- 148 RIWI-MASKINER, Nya Agnesfridsvagen 186, MALMO
149 AB TEXOTAN, Box 132, S-431-22 MOLNDAL 1

BRAZIL

- 150 Industria de Maquinas Enko Ltda., Ave Pedro Adams,
Filho 795, Caixa Postal 24, NOVO HAMBURGO,RS
151 Maquinas SEIKO Ltda., Caixa Postal 86, NOVO HAMBURGO ,RS

APPENDIX III

SELECTED BIBLIOGRAPHY

- Boon, Gerard K.: Technology and Employment in Footwear Manufacturing (Alphen aan den Rijn, Sijthoff and Noordoff, 1980).
- Chee Peng Lim: Manufacture of Leather Shoes and Bricks in Malaysia in A.S. Bhalla (ed.), "Technology and Employment in Industry", (Geneva, ILO, 1981).
- ILO : The employment implications of technological choice and of changes in international trade in the leather and footwear industry, Report II, Second Tripartite Technical Meeting for the Leather and Footwear Industry (Geneva, ILO, 1979).
- Little, I.M.D., and J.A. Mirrlees: Manual of Industrial Project Analysis in Developing Countries. Volume II. Social Cost Benefit Analysis (Paris, Development Centre Studies, OECD, 1968).
- Little, I.M.D., and J.A. Mirrlees: Project Appraisal and Planning for Developing Countries (London, Heinemann Educational Books, 1974).
- McBain, N.S.: The Choice of Technique in Footwear Manufacture for Developing Countries (London, Ministry of Overseas Development, H.M.S.O., 1977).
- McBain, N.S.: "Developing Country Product Choice: Footwear in Ethiopia" in World Development, Vol. 5, Nos 9/10, Sept./Oct. 1977.
- McBain, N.S. and Pickett, J.: "Developing country export potential and developed country adjustment policy: An illustrative study of Ethiopian and Ghanaian footwear production" in Adjustment for Trade: Studies on the Industrial Adjustment Problems and Policies (Paris, OECD, 1975).
- McBain, N.S. and Forsyth, D.J.C.: "An intermediate technology for shoe-making in less developed countries", in Appropriate Technology, Vol. 2, No. 3, Nov. 1975.

Squire, L., and H.G. van der Tak: Economic Analysis of Projects (Baltimore, The John Hopkins University Press, 1975).

Thornton, J.H.: Textbook of footwear manufacturer (London, Temple Press, 1964).

UNIDO: Guidelines for Project Evaluation, (New York, United Nations, 1972).

UNIDO: Guide to Practical Project Appraisal. Social Benefit-Cost Analysis in Developing Countries (New York, United Nations, 1978).

Appendix IV

Selected list of technical institutions

- ALGERIA - Soci t  nationale des Industries des Peaux et Cuirs (SONIPEC), Si ge-social Alger, 100, rue de Tripoli, Hussein-Dey.
- ARGENTINA - Camara Industrial Marraquinera Argentina, 1219 Buenos Aires
- AUSTRALIA - Footwear Manufacturers Association, 65 York St. Sydney, N.S.W.
- AUSTRIA - Verband der Schuindustrie, Bavernmarkt 13, 1011 Vienna 1.
- BELGIUM - Federation belge de l'Industrie de la Chaussure (FEBIC), 91-97 Boulevard M. Lemonnier, 1000 Bruxelles
- BRAZIL - Associaco Brasileira dos Quimicose Techicos da Industria do Couro, Rua Urugai 155, C.P. 2075 Port Alegre, R.S.
- BULGARIA - Scientific and Technical Institute for Leather and Shoe Industry, Str. "Industrialna", No. 11, Gabrovo.
- CANADA - Footwear and Leather Institute of Canada, 14 Eiffel-Mark, P.O. Box 355, Place Bonaventure, Montreal, Quebec H5A 1B5
- COLOMBIA - Comite Sectorial de la Industria del Cuero y del Calzado y sus. Carrera 13, 27-00 Piso 10, Bogota.
- CZECHOSLOVAKIA - Shoe and Leather Research Institute (VUK) 762 65 Gottwaldov.
- DENMARK - T.I. Leather Research Laboratory, Bronshojvej, 17 2700 Copenhagen
- GERMAN DEM.REP.- Forschungsinstitut f r Schuhtechnologie, 485 Weissenfels, Am Muhlberg 9
- IRELAND- Federation of Irish Footwear Manufacturers, Confederation House, Kildar St., Dublin 2
- ETHIOPIA - National Leather and Shoe Corp., Box 2516 Addis-Ababa
- FINLAND - State Institute for Technical Research, Leather Investigations Laboratory, L nnrotinkatu 37, HELSINKI 18.

- FRANCE - Fédération nationale de l'Industrie de la Chaussure de France, 30 avenue Georges V, 75005 Paris.
- GREECE - Greek Shoe and Leather Organisation, Paneplystimiou 64, Athens TT 141.
- GUATEMALA - Instituto Centroamericano de Investigacion y Tecnologia Industrial (ICAIT), Avenida la Reforma 4-47, Zona 10, Guatemala City
- HUNGARY - Research Institute of the Leather, Artificial Leather and Footwear Industries, 1047 Budapest Paksi Jozsef u43.
- INDIA - All India Footwear and Rubber Goods Manufacturers' Association, 15A Horniman Circle, Fort, Bombay.
- INDONESIA - Indonesia Leather Institute- The Academy of Leather Technology, Djl. Di Ponegoro 101, Djakarta.
- ITALY - Instituto Tecnico Industriale di Stato del Cuoio e Derivati, Corso Cirie 7, 10152 Turin
- JAPAN - Japan Shoe Manufacture Federation, 3 Kajicho 1- Chome, Kanda, Chiyodaku, Tokyo 101
- MEXICO - Asociacion Mexicana de Quimicos y Tecnicos del Cuero A-C., Tehuantepec 255, Despachos 101-102, Apdo. Postal 27-227, Mexico 7.
- MOROCCO - Syndicat des Fabricants de Chaussures, 262, boulevard Mohamed V, Casablanca.
- NETHERLANDS - Institute for Leather and Shoe Research TNO, Mr. van Coothstraat 55, 5141 ER Waalwijk.
- NEW ZEALAND - New Zealand Leather and Shoe Research Association, Private Bag, Palmerston North, 82-108 Palmerston North
- NIGERIA - Leather Research Institute, P.B. 1052, Zaria.
- PAKISTAN - Pakistan Leather Goods Manufacturers' and Dealers' Association, 6 Badshahi Rd., Garden West, Karachi.
- PANAMA - Asociacion de Industriales del Cuero y Calzados de Panama, c/o Fabrica de Calzado CODA, Panama City
- POLAND - Institute of Leather Industries, Ulzgierska, 73 Lodz 11

- RUMANIA - The Institute of Hide and Shoe Research, Bella Breiner St., 93, 74259 Bucharest 4
- SOMALIA - Hides and Skins and Leather Development Centre, P.O. Box 24, Mogadiscio.
- SPAIN - Asociacion Quimica Espanola de la Industria del Cuero, Av. José Antonio 608, Barcelona 7.
- SRI LANKA - Ceylan Leather Products Corp., 141 Church Rd., Mattakkuliya, Colombo 15
- SUDAN - Hides, Skins and Leather Institute, P.O. Box 8, Khartoum South.
- SWEDEN - Shoe Suppliers' Association, Grevgatan 34, Box 5512, S-114 85 Stockholm.
- SWITZERLAND - Verband Schweiz Schuhindustrieller, Rotel St. 84, PF 8042 Zurich.
- TUNISIA - Centre national du Cuir et de la Chaussure (CNCC) 6, rue Djebel Mansour, Tunis.
- TURKEY - Turkish Leather Research and Training Institute, P.O. Box 26, Pendik, Istanbul.
- UNITED KINGDOM - Shoe and Allied Trades Research Association, Satra House, Rockingham Rd. Kettering Northants
- U.S.A. - Sole Leather Council, 321 Summer St., Boston 02210, Mass.
- U.S.S.R. - Central Scientific Research Institute for the Leather and Footwear Industry, Ulitsa Piatn#skaia, 74, Moscow.
- VENEZUELA - Asociacion nacional de Industriales del Cuero, Esquina Puente Anauco, Apdo Postal 6974-2860, 3020 Caracas.
- FED. REP. GERMANY - Hauptverband der Deutschen Schuhindustrie, Stresemannstr. 12, D-4000 Dusseldorf.
- YUGOSLAVIA - Institute for Leather Footwear and Rubber, Visenjicka 94, Belgrad.

APPENDIX. V

Year	5%	6%	8%	10%	12%	14%	15%	16%	18%	20%	22%	24%	25%	26%	28%	30%	35%	40%
1	0.952	0.943	0.926	0.909	0.893	0.877	0.870	0.862	0.847	0.833	0.820	0.806	0.800	0.794	0.781	0.769	0.741	0.714
2	1.859	1.833	1.783	1.736	1.690	1.647	1.626	1.605	1.566	1.528	1.492	1.457	1.440	1.424	1.392	1.361	1.289	1.224
3	2.723	2.673	2.577	2.487	2.402	2.322	2.283	2.246	2.174	2.106	2.042	1.981	1.952	1.923	1.868	1.816	1.696	1.589
4	3.546	3.465	3.312	3.170	3.037	2.914	2.855	2.798	2.690	2.589	2.494	2.404	2.362	2.320	2.241	2.166	1.997	1.849
5	4.330	4.212	3.993	3.791	3.605	3.433	3.352	3.274	3.127	2.991	2.864	2.745	2.689	2.635	2.532	2.436	2.220	2.035
6	5.076	4.917	4.623	4.355	4.111	3.889	3.784	3.685	3.498	3.326	3.167	3.020	2.951	2.885	2.759	2.643	2.385	2.168
7	5.786	5.582	5.206	4.868	4.564	4.288	4.160	4.039	3.812	3.605	3.416	3.242	3.161	3.083	2.937	2.802	2.508	2.263
8	6.463	6.210	5.747	5.335	4.968	4.639	4.487	4.344	4.078	3.837	3.619	3.421	3.329	3.241	3.076	2.925	2.598	2.331
9	7.108	6.802	6.247	5.759	5.328	4.946	4.772	4.607	4.303	4.031	3.786	3.566	3.463	3.366	3.184	3.019	2.665	2.379
10	7.722	7.360	6.710	6.145	5.650	5.216	5.019	4.833	4.494	4.192	3.923	3.682	3.571	3.465	3.269	3.092	2.715	2.414
11	8.306	7.887	7.139	6.495	5.938	5.453	5.234	5.029	4.656	4.327	4.035	3.776	3.656	3.544	3.335	3.147	2.752	2.438
12	8.863	8.384	7.536	6.814	6.194	5.660	5.421	5.197	4.793	4.439	4.127	3.851	3.725	3.606	3.387	3.190	2.779	2.456
13	9.394	8.853	7.904	7.103	6.424	5.842	5.583	5.342	4.910	4.533	4.203	3.912	3.780	3.656	3.427	3.223	2.799	2.468
14	9.899	9.295	8.244	7.367	6.628	6.002	5.724	5.468	5.008	4.611	4.265	3.962	3.824	3.695	3.459	3.249	2.814	2.477
15	10.380	9.712	8.559	7.606	6.811	6.142	5.847	5.575	5.092	4.675	4.315	4.001	3.859	3.726	3.483	3.268	2.825	2.484
16	10.838	10.106	8.851	7.824	6.974	6.265	5.954	5.669	5.162	4.730	4.357	4.033	3.887	3.751	3.503	3.283	2.834	2.489
17	11.274	10.477	9.122	8.022	7.120	6.373	6.047	5.749	5.222	4.775	4.391	4.059	3.910	3.771	3.518	3.295	2.840	2.492
18	11.690	10.828	9.372	8.201	7.250	6.467	6.128	5.818	5.273	4.812	4.419	4.080	3.928	3.786	3.529	3.304	2.844	2.494
19	12.085	11.158	9.604	8.365	7.366	6.550	6.198	5.877	5.316	4.844	4.442	4.097	3.942	3.799	3.539	3.311	2.848	2.496
20	12.462	11.470	9.818	8.514	7.469	6.623	6.259	5.929	5.353	4.870	4.460	4.110	3.954	3.808	3.546	3.316	2.850	2.497
21	12.821	11.764	10.017	8.649	7.562	6.687	6.312	5.973	5.384	4.891	4.476	4.121	3.963	3.816	3.551	3.320	2.852	2.498
22	13.163	12.042	10.201	8.772	7.645	6.743	6.359	6.011	5.410	4.909	4.488	4.130	3.970	3.822	3.556	3.323	2.853	2.498
23	13.489	12.303	10.371	8.883	7.718	6.792	6.399	6.044	5.432	4.925	4.499	4.137	3.976	3.827	3.559	3.325	2.854	2.499
24	13.799	12.550	10.529	8.985	7.784	6.835	6.434	6.073	5.451	4.937	4.507	4.143	3.981	3.831	3.562	3.327	2.855	2.499
25	14.094	12.783	10.675	9.077	7.843	6.873	6.464	6.097	5.467	4.948	4.514	4.147	3.985	3.834	3.564	3.329	2.856	2.499

Present worth of an annuity factor

How much I received or paid annually for X years is worth today

Q U E S T I O N N A I R E

1. Full name.....

2. Address.....
.....
.....

3. Profession (check the appropriate case)

(a) Established footwear manufacturer
If yes, indicate scale of
production.....

(b) Would-be footwear manufacturer.....

(c) Government official
If yes, specify position:.....
.....

(d) Employee of a financial institution
If yes, specify position:.....
.....

(e) University staff member.....

(f) Staff member of a technology
institution.....
If yes, indicate name of
institution.....
.....

(g) Staff member of a training
institution.....
If yes, specify.....
.....



6. Is the memorandum detailed enough in terms of :

- Description of technical aspects..... Yes No
- Names of equipment suppliers..... Yes No
- Costing information..... Yes No
- Information on socio-economic impact.. Yes No
- Bibliographical information..... Yes No

If some of the answers are "No", please indicate why below or on a separate sheet of paper

.....
.....
.....
.....
.....
.....
.....
.....
.....
.....

7. How may this memorandum be improved if a second edition were to be published?

.....
.....
.....
.....
.....
.....

8. Please send the Questionnaire, duly completed to:

Technology and Employment Branch
INTERNATIONAL LABOUR OFFICE,
CH-1211 GENEVA 22 (Switzerland)

9. In case you need additional information on some of the issues covered by this memorandum the ILO and UNIDO would do their best to provide the requested information.



(h) Other.....

If yes, specify.....

.....

4. From where did you get a copy of this memorandum?
Specify if given free or bought.....

.....

5. Did the memorandum help you achieve the following
(Check the appropriate cases)

(a) Learn about footwear manufacturing.....
techniques you were not aware of

(b) Obtain names of equipment suppliers.....

(c) Estimate unit production costs for various
scales of production/technologies.....

(d) Order equipment for local manufacture.....

(e) Improve your current production technique....

(f) Cut down operating costs.....

(g) Improve the quality of footwear produced.....

(h) Decide which scale of production/technology
to adopt for a new footwear factory.....

(i) If a government employee, to formulate a
national footwear manufacturing strategy.....

(j) If an employee of a financial institution,
to assess a request of a loan for the esta-
blishment of a footwear production unit.....

(k) If a trainer in a training institution, to
use the memorandum as a supplementary
training material.....

(l) If an international expert, to better advise
counterparts on footwear manufacture
technologies.....



Other ILO publications

Technology series

A total of 11 technical memoranda, including the one on the tanning of hides and skins (Technical memorandum No. 1) and the present memorandum, will be jointly published by the ILO and UNIDO in 1982 and 1983. The following technical memoranda should be available in 1982: mini paper plants, small-scale weaving, maize milling, oil extraction from groundnuts and copra, and fish processing. Five additional memoranda are at various stages of preparation. These are: grain storage, production of windows and doors for low-cost housing, utilitarian ceramics production, beef processing and pork processing.

Tanning of hides and skins (Technology series - Technical memorandum No. 1)

This was the first of the technical memoranda to be published. It provides technical and economic information concerning the tanning of hides and skins at scales ranging from two hides per day (a typical rural tannery) to 200 hides per day. Six alternative tanning technologies are described, from a fully mechanised 200 hides per day project to a highly labour-intensive two hides per day project. Subprocesses are described in great detail, with diagrams of pieces of equipment which may be manufactured locally. A list of equipment suppliers is also provided for those pieces of equipment which may need to be imported.

It is hoped that the information contained in this memorandum will help would-be and practising tanners to choose and apply tanning techniques which will minimise production costs while improving the quality of the leather.

The memorandum on the tanning of hides and skins is, to some extent, complementary to the present memorandum on the small-scale manufacture of footwear.

ISBN 92-2-102904-2

Guide to tools and equipment for labour-based road construction

In recent years it has been shown that labour-based techniques of road construction can be, and often are, preferable to capital-intensive techniques, not only for their reduced cost but also for the job opportunities they create. For labour-based techniques to be effective, however, the available tools and simple equipment need to be improved. The information given in the Guide will help those responsible for planning and managing labour-based road construction projects to specify the appropriate tools and simple equipment for the job, by showing them how to establish testing procedures, how to advise local manufacturers on the production of good-quality implements, how to contact sources of supply and how to ensure the correct use and maintenance of the tools and simple equipment selected.

Whilst the Guide is concerned with road construction, it is obvious that the information provided could also find wider application in civil engineering generally, in agriculture and in forestry.

ISBN 92-2-102539-X

Small-scale manufacture of footwear

A number of developing countries have developed and successfully applied technologies that are suited to the socio-economic conditions prevailing in those countries, that is, technologies which make better use of abundant labour and scarce capital than do technologies developed in industrialised countries. Unfortunately, these technologies are rarely disseminated outside the countries where they have been developed. Consequently, the ILO and UNIDO have joined forces in order to make available to small-scale entrepreneurs in developing countries detailed technical and economic information on these technologies. This information will be published in the form of technical memoranda, and will cover products and processes of particular interest to developing countries.

This technical memorandum covers the small-scale production of footwear (shoes and sandals) of differing types and quality. It provides detailed technical and economic information covering four scales of production ranging from eight pairs per day to 1,000 pairs per day. A number of alternative technologies are described, including both equipment-intensive and labour-intensive production methods. Subprocesses are described in great detail, with diagrams of pieces of equipment which may be manufactured locally. A list of equipment suppliers is also provided for those pieces of equipment which may need to be imported.

It is hoped that the information contained in this memorandum will help would-be and practising footwear producers to choose and apply manufacturing techniques which will minimise production costs while improving the quality of footwear.

ISSN 0252-2004

ISBN 92-2-103079-2

Price: 20 Swiss francs