

# **Investigation of Agricultural Residues Gasification for Electricity Production in Sudan as an Example for Biomass Energy Utilization under Arid Climate Conditions in Developing Countries**

von der Fakultät für Maschinenwesen  
der Technischen Universität Dresden  
zur Erlangung des akademischen Grades  
Doktor-Ingenieur (Dr.-Ing.)

angenommene Dissertation

vorgelegt von M.Sc. Eng. Arig G. Bakhiet

- 1. Gutachter: Prof. Dr.-Ing. U. Gampe
- 2. Gutachter: Prof. Dr.-Ing. M. Beckmann
- 3. Gutachter: Dr. E. Fadlalla
- Vorsitzender: Prof. Dr.rer.net.habil. T. Bley

Tag der Einreichung: 30.10.2007  
Tag der mündlichen Prüfung: 08.04.2008

Dresden, Mai 2008



## Abstract

This study examines the possibility of electricity production through gasification of agricultural residues in Sudan. The study begins in Chapter 1, by providing general contextual analysis of the energy situation (production and consumption patterns) in Sudan with specific focus on electricity. It proceeded to study the potential of Petroleum, Biomass and other renewable sources for electricity production. Dramatic increase in electricity production was found to be essential especially through decentralised power plants as the current electricity production services cover ~ 13 % of the population of Sudan. Biomass potential in Sudan justifies the use of agricultural residues as energy source; its potential was estimated by ~ 350000 TJ/a. Further, the urban centres of arid regions in western Sudan were identified as the target group for this study. In chapter 2, specific investigations for selected study area through field work using statistical tools such as questionnaires, interviews and field observation show that income is highly correlated to electricity consumption. The flat rate system did not result in higher consumption thus the assumption that this consumption will not drastically change in the next 10 years could be accepted. As orientation value for BGPP, 8000 tons of GN.S are available annually, the average electricity consumption is ~ 4 kWh/day/family while acceptable price could be 40 SDD/kWh (0.15 €). In chapter 3, literature review was carried to spot out the comparative merits of the gasification technology and the most optimum gasifying and electricity production system. As a result downdraft gasifier and ICE were suggested as suitable systems. In chapter 4, fuel properties and fuel properties of agricultural residues were studied, different samples were tested and the results were presented. The main conclusions derived were: fuel properties of agricultural residues are *modifiable* properties, so utilization planning is possible as for any other energy resource. In Sudan, Baggase, Groundnuts shells and Roselle stalks could be considered as possible fuels. The experimental work done in chapter 5 showed that GN.S could be gasified in down draft gasifiers, which are less costly and simpler to operate than circulating systems. Acceptable values of gas thermal properties (c.v.~ 4 MJ/Nm<sup>3</sup>, 30 % of burnable gases) at fairly continuing processes were obtained. In chapter 6, a concept for biomass power plant was drafted, the main components are: downdraft, air based gasifier connected to ICE, multi-stage gas cleaning system (cyclones, washer and filters) mechanical ash removal and semi closed water cycle. Main operation measures are: electricity is the sole product; working time is 150 day/year between mid November-mid Mars. Environmental hazards of waste management e.g. flue gas emission and waste water management are the limiting factors. In the last part of chapter 6 an economic analysis was carried out. At a value of 3000 €/kW for the initial system and fuel price of 100000 €/year for ~6 GWh then a price of 0.23 €/kWh and a return period of 24 years could be obtained. The study concludes in chapter 7 that biomass gasification under the local conditions has its comparative merits however a high institutional support is needed at the beginning.



## **Zusammenfassung**

Diese Studie untersucht die Möglichkeit der Elektrizitätsproduktion durch Vergasung von landwirtschaftlichen Abfällen im Sudan. Die Untersuchung beginnt im Kapitel 1 mit der Bereitstellung einer allgemeinen zusammenhängenden Analyse der Energiesituation (Produktions- und Verbrauchsmuster) im Sudan mit dem besonderen Fokus auf Elektrizität, gefolgt von einer Studie des Potentials von Petroleum, Biomasse und anderer erneuerbarer Quellen für die Produktion von Elektrizität. Eine starke Zunahme bei der Elektrizitätsproduktion wurde als nötig bewertet, da dezentrale Kraftwerke, als die gegenwärtigen Elektrizitätsproduktionsbetriebe, nur die Versorgung von 13 % der Bevölkerung im Sudan abdecken. Das geschätzte Potential der landwirtschaftlichen Abfälle liegt bei ca. 350.000 TJ/Jahre damit kommen sie als Energiequelle in Frage. Weiterhin wurden urbane Zentren der ariden Regionen in Westsudan als Zielgruppe für die Untersuchung ausgewählt. In Kapitel 2 werden detaillierte Untersuchungen für das ausgewählte Studiengebiet durch Feldstudien unter Verwendung von statistischen Werkzeugen, wie Fragebögen, Interviews und Felduntersuchungen dargestellt. Das Ergebnis zeigt, dass das Einkommen im höchsten Maße mit dem Elektrizitätsverbrauch korreliert ist. Das Flat rate System hatte keinen höheren Verbrauch zur Folge, folglich kann die Annahme akzeptiert werden, dass sich der Verbrauch in den nächsten 10 Jahren nicht drastisch ändern wird. Als Orientierungswert für Biomasse Kraftwerk: 8.000 t/Jahr Erdnussschalen sind verfügbar. Der durchschnittliche Elektrizitätsverbrauch beträgt ca. 4 kWh/Tag/Familie betrachtet für 10.000 Familien. Im Kapitel 3 wird eine Literaturrecherche für die Vergasungstechnologie durchgeführt, zum Vergleich ihrer Vorteile und zur Auswahl des optimalen Vergasungs- und Gasumwandlungssystems. Als Ergebnis wurden der Festbett-Gleichstrom-Vergaser und gas Motor als passende Systeme vorgeschlagen. In Kapitel 4 werden Brennstoff Eigenschaften von landwirtschaftlichen Abfällen untersucht, verschiedene Proben getestet und die Ergebnisse präsentiert. Die Hauptschlussfolgerung daraus ist: Brennstoff Eigenschaften von landwirtschaftlichen Abfällen sind veränderbare Eigenschaften, welche eine bessere Planung erlauben und somit ihre Verwendung favorisieren. Im Sudan können Bagasse, Erdnussschalen und Rosellenstiele als optimaler Brennstoff gelten. Die experimentelle Arbeit in Kapitel 5 zeigt, dass Erdnussschalen im 75 kW Festbett-Gleichstrom-Systemen vergast werden können, welche weniger kostenintensiv und einfach zu bedienen sind als zirkulierende Systeme. Akzeptable Werte der Gaseigenschaften (c.v. ca. 4 MJ/Nm<sup>3</sup>, 35 % von brennbaren Gasen) wurden in kontinuierlichen Prozessen erreicht. In Kapitel 6 wurde ein Konzept für Biomassekraftwerke entworfen. Deren Hauptkomponenten sind: Festbett-Gleichstrom-Vergaser in Verbindung mit ICE, mehrstufige Gasreinigungssysteme (Zyklone, Wäscher und Filter), mechanische Aschensysteme und ein teilweise geschlossener Wasserkreislauf. Hauptbetriebsmaßnahmen sind: Elektrizität als das einzige Produkt, die Arbeitszeit beträgt 150 Tage pro Jahr zwischen November und April. Umweltrisiken des Abfallmanagements z.B. Rauchgas und Abwassermanagement sind die limitierenden Faktoren. Im letzten Teil von Kapitel 6 wurde eine ökonomische Analyse durchgeführt. Ein Wert von 3000 €/kW für das Anfangssystem und ein Kraftstoffpreis von 100.000 €/Jahr für 6 GWh dann ein Preis von 0,23 €/kWh und eine Amortisationszeit von 24 Jahren können angenommen werden. Die Studie schlussfolgert, dass die Vergasung unter den Bedingungen des Studiengebietes ihre Vorteile hat, jedoch ist institutionelle Unterstützung am Anfang nötig.



## Acknowledgement

This thesis was prepared as a requirement to qualify for the academics degree (Dr-Ing.) at the chair of power plant technology, Faculty of Mechanical Engineering, TU-Dresden.

First I would like to than all persons and institutions that had supported me in various ways through out the course of the study and I apologize that I can not mention them all here.

Late Prof. Zschering who had supported the unformulated idea and encouraged me to realize it. Until his death, Prof. Zschering was the co-supervisor, after the sudden death of late Prof. Gilli who had gratefully accepted to be the main supervisor and supported me during the first steps of this study. I am very grateful for their support yet sad that they cannot see the end of this work.

In these difficult circumstances Prof. Gampe accepted the supervision responsibility. I am really indebted to his continuous support and understanding which allowed me to complete this work. My graditude extends to Prof. Beckmann for his valuable comments when preparing the final version of this book

A special notation has to be made to Dr. Ing. A. Hiller, this work could not be completed without his intensive support and advices. In this context I appreciate the valuable comments and help from KWT staff especially Dr. K. Gebauer, Dr. K. Koppe, Dipl.-Ing. R. Wilhelm, Dipl.-Ing. J. Loser.

My regards extend to the staff of GAC in Kordufan University for their assistance in executing the field work in Sudan especially Dr. M. Taha, Dr. T. Mahomud, who had helped me during the preparation of the first proposal, and the field work team (Mrs. O. Kabashi and Mr.M. Muktar). The valuable advices of Prof. E. Günther during the preparation and analysis phases can not be denied.

The cooperation and understanding for the nature of the work from the staff of the Energy Research Institute (ERI) especially Prof. E. Idris and Dr. E. Fadalla was a very valuable support. As a gratitude sign I would like to mention my colleague W. Abbas for his efforts in facilitating the complicated administrative issues.

I am showing my deepest gratitude to DAAD for their financial and administrative support which had not only facilitates the finance but also recognize the importance of the study.

The personal care and emotional support from all my friends and family in and outside Sudan was simply wonderful, it helped me a lot during this difficult period away from home. Special thank for Dresden group for their help in revision and comments specially M.Salih, Katherine and Hussien.

The memory of my father had always encouraged me to work hard so as to worth being his daughter. All of what I now am could not be without the sacrifices, support and love of my mother who still strives to allow me to the make the best of myself. I am very grateful for my sister Rawa for her valuable support, help and encouragement.

To All Merciful God I am thankfully praying, for granting all this to me, to think, to learn, to work.





# Table of Contents

<b>Abstract</b>		<b>II</b>
<b>Acronym and Nomenclature</b>		<b>XII</b>
<b>Introduction</b>		<b>XVI</b>
<b>1</b>	<b>Energy Situation in Sudan: Status, Potentials and Prospects</b>	<b>1</b>
1.1	General	1
1.1.1	Global ranking	1
1.1.2	Energy balance	2
1.1.3	Electricity Supply	4
1.2	Discussion of primary energy resources and their potential for electricity production	9
1.2.1	Petroleum	9
1.2.2.	Solar, Wind and Hydropower	11
1.2.3	Biomass	14
1.2.3.1	General	14
1.2.3.2	Forests	16
1.2.3.3	Agricultural residues	18
1.3	National and International Concerns	21
1.3.1	National concerns	22
1.3.2	International concerns	23
1.4	Conclusions	23
<b>2</b>	<b>Experiences and Results from Field Studies</b>	<b>25</b>
2.1	Introduction	25
2.2	Study area	25
2.2.1	Selection requirement	25
2.2.2	General description	26
2.3	Methodology	27
2.4	Results	29
2.4.1	Actual electricity situation	29
2.4.1.1	Official system	29
2.4.1.2	Private system	29
2.4.2	Questionnaire results	30
2.4.2.1	Energy/Electricity consumption in household	30
2.4.2.2	Energy budget	32
2.4.2.3	Factors governing electricity consumption	34
2.4.2.4	Perception and Judgment	36
2.4.3	Biomass availability	38
2.4.3.1	Forests	38
2.4.3.2	Agricultural residues	38
2.5	Analysis and discussion	40
2.6	Conclusions	41
<b>3</b>	<b>Biomass Gasification</b>	<b>43</b>
3.1	Basic concepts	43
3.1.1	Definition	43
3.1.2	Biomass energy	43

3.1.3	Biomass gasification	44
3.2	Gasification technique	46
3.2.1.	Definition	46
3.2.2.	Gasification agents	46
3.3	Gasifiers	47
3.3.1	Gasifiers classification	48
3.3.1.1	Operational classifications	48
3.3.1.2	Structural classification	49
3.3.2	Downdraft gasifier	51
3.3.2.1	Process description	51
3.3.2.2	Gasification chemistry	52
3.3.2.3	Practical considerations for down draft gasifier	54
3.4	Air gasification products	55
3.4.1	Gas	55
3.4.2	Contaminants	55
3.5	Gasification for electricity	60
3.5.1	Fuel cell	60
3.5.2	Stirling engine	61
3.5.3	Internal combustion engine	63
3.5.4	Gas turbine	64
3.6	General overview	66
3.7	Conclusions	67
<b>4</b>	<b>Fuel properties of Agricultural Residues</b>	<b>68</b>
4.1	Introduction	68
4.1.1	Similarity and diversity	68
4.1.2	Internal factors	70
4.1.3	External factors	71
4.2	Significance of tested fuel properties	72
4.2.1	Energy related properties	72
4.2.2	Non-energy related properties	75
4.3	Ash	76
4.3.1	Definition	76
4.3.2	Ash analysis	77
4.3.2.1	Ash content	77
4.3.2.2	Ash melting behaviour	78
4.3.3	Ash quality	78
4.3.3.1	Alkaline material	78
4.3.3.2	Metallic compounds	79
4.4	Experimental results	80
4.4.1	Material tested	80
4.4.2	Methodology	80
4.4.3	Analysis and discussion	82
4.4.3.1	Differences within the overall collected samples	82
4.4.3.2	Differences within the same specimen	82
4.4.3.3	Different between groups	84
4.5	Conclusions	86
<b>5</b>	<b>Experiments for Gasification of Agricultural Residues</b>	<b>87</b>
5.1	Introduction	87
5.2	Test gasifier	88
5.2.1	Reactor	88

5.2.2	Measurement systems	89
5.3	Experiments procedure	93
5.3.1	Objective	93
5.3.2	Selection and preparation of material	93
5.3.3	Experimental results	97
5.3.3.1	Producer gas production and process efficiency	97
5.3.3.2	Tar and dust	100
5.4	Analysis and discussion	103
5.5	Overall evaluation	113
5.6	Conclusions	113
<b>6</b>	<b>Development of a Concept for a Decentralized Power Generation</b>	<b>115</b>
6.1	Boundary conditions for power plant operation	115
6.1.1	Fuel	115
6.1.2	Gas to electricity conversion system	116
6.1.3	Waste disposal	116
6.1.4	Electricity supply unit	117
6.2	Local factors affecting selection of system components	118
6.3	Power plant concept	118
6.3.1	Fuel unit	118
6.3.2	Gas to electricity conversion system	119
6.3.3	Waste management	121
6.4	Over all system planning	122
6.4.1	Spatial planning	122
6.4.2	Temporal planning	122
6.5	Economical evaluation	123
6.5.1	Methodology and assumption	123
6.5.2	Sensitivity analysis tests	124
6.6	Overall evaluation	129
6.7	Conclusions	129
<b>7</b>	<b>Way Forward</b>	<b>130</b>
7.1	Summary of results	130
7.2	Conclusions	131
7.3	Information Gaps	133
7.4	Recommendation	134
7.5	Limitation and application of the study	134
	<b>References</b>	<b>135</b>
	<b>Appendices</b>	<b>151</b>



## List of Tables

Table 1.1: Overall energy indicators for Sudan (2003), Germany (2004)	1
Table 1.2: Power plant production in NG (2004)	6
Table 1.3: Petroleum storage capacities and electricity need (2003)	11
Table 1.4: Average annual crops production in Sudan (2002-2005)	19
Table 1.5: Availability of agricultural residues in Sudan	21
Table 1.6: Average annual residue amount in Sudan (2002-2005)	21
Table 1.7: CO <sub>2</sub> emission in Sudan (1995)	23
Table 2.1: Demographic indicators of interviewees	30
Table 2.2: Economical indicator of the overall sample	31
Table 2.3: Electric devices in the house hold	32
Table 2.4: Electricity consumption and kWh price	33
Table 2.5: Correlation coefficient (r); total energy consumption and different parameters	35
Table 2.6: Average annual agricultural production of western Kordufan region (2002-2005)	39
Table 2.7: Average annual residues quantity in western Kordufan region (2002-2005)	39
Table 3.1: Producer gas compositions	47
Table 3.2: Tar types in relation to temperature	56
Table 4.1: Typical Carbon content and calorific value of selected biomass components	70
Table 4.2: Ignition point of some fuels	75
Table 4.3: Heavy metals in wood verses coal	76
Table 4.4: Material tested in KWT Laboratory	81
Table 4.5: Variation indicators for some fuel properties of the tested samples.	82
Table 4.6: Differences within the same material	83
Table 4.7: Fuel properties for some selected material	85
Table 4.8: Critical ash indicators	85
Table 5.1: Typical producer gas constituents (IGEL)	91
Table 5.2: Reading range and sensors used for different gas constituents	91
Table 5.3: Thermo-couples used	91
Table 5.4: Groundnuts shells combination	94
Table 5.5: Straw pellets combinations	94
Table 5.6: Selected physical and energetic properties of the tested materials	96
Table 5.7: Average results of experiment 1	98
Table 5.8: Average results of experiment 2	98
Table 5.9: Average results of experiment 3	99
Table 5.10: Average results of experiment 4	99
Table 5.11: Mass of tar and dust	101
Table 5.12: Detail information for tar types (example)	101
Table 5.13: Tar components in gas (Groundnuts shells)	102
Table 5.14: Main characteristics for frequent tar types	102
Table 5.15: Alkali in tar	103
Table 6.1: Boundary values for (BGPP) in Sudan	124



## Table of Figures

Fig. 1.1: Sudan energy balance (2004)	3
Fig. 1.2: Electricity Services in Sudan (2004)	5
Fig. 1.3: Electricity service distribution in Sudan (2004)	7
Fig. 1.4: Petroleum reserves in the Sudan (2004)	10
Fig. 1.5: Petroleum production in Sudan	10
Fig. 1.7: Wind energy intensity in Sudan (W/m <sup>2</sup> )	13
Fig. 1.8: Biomass energy in Sudan (2003)	15
Fig. 1.9: Biomass resources in Sudan	15
Fig. 1.10: Agricultural sectors in Sudan	19
Fig. 2.1: Study area.-location and administrative divisions (2005)	26
Fig. 2.2: Population percent using each energy source	32
Fig. 2.3: Financial aspects of different energy sources	33
Fig. 2.4: Perception over view for electricity in the study area	37
Fig. 2.5: Comparison between perceived evaluation and real situation in the study area	37
Fig. 2.6: Groundnuts availability and transport	40
Fig. 3.1: Biomass energy path way	46
Fig. 3.2: Gasification process overview	48
Fig. 3.3: Entrained gasifier	50
Fig. 3.4: Fluidized bed gasifier (stationary and circulating respectively)	50
Fig. 3.5: Up-draft gasifier and Down-draft gasifiers	51
Fig. 3.6: Gasification stages in down draft gasifier	53
Fig. 3.7: Gasification products as function of temperature	53
Fig. 3.8: Variation of tar compositions with gasifier type	57
Fig. 3.9: Gasification plant products	59
Fig. 3.10: Efficiency & power range for different biomass based power plants	59
Fig. 3.11: Fuel cell (SOFC) with gasifier	61
Fig. 3.12: Stirling motor and gasifier system	62
Fig. 3.13: Wiener Neustadt Gasification power plant	64
Fig. 3.14: Vernamo process (IGCC)	65
Fig. 3.15: ETC at Rostock University	66
Fig. 3.16: PG- electricity systems	67
Fig. 4.1: Coal and Biomass (Wood) structure	69
Fig. 4.2: Pyrolysis behaviours of difference biomass	71
Fig. 4.3: Effect of rain fall intensity and harvest day on the chemical compositions of the plant	71
Fig. 4.4: Calorific value in relation to moisture content	73
Fig. 4.5: Possible storage period for biomass against moisture content	74
Fig. 4.6: Ash properties in relation to harvest day	77
Fig. 5.1: Fest bed-downdraft gasifier, 75 kW at TU-Dresden (IGEL)	89
Fig. 5.2a: Measurement software interface	90
Fig. 5.2b: Temperature distribution in IGEL	90
Fig. 5.3: Tar collection system	93
Fig. 5.4: Variation of calorific value of tested material	105
Fig. 5.5: Producer gas compositions for the tested material	108
Fig. 5.6: Producer gas composition (GN.S (50:50),GN.S (P)) compared to literature values	108
Fig. 5.7: Thermal properties of producer gas	109
Fig. 5.8: Cold and hot gas efficiency of GN.S gas versus air input	110
Fig. 5.9: Over view for lambda results for the tested material	110
Fig. 5.10: Variation of tar and dust with fuel input and air flow rate (GN.S)	111

Fig. 5.11: Gasification of St.Pl and GN.S	112
Fig. 6.1: Graphic over view for planning aspects of (BGPP)	116
Fig. 6.2: Power generation concept	120
Fig. 6.3: Sketch for considered factors for economical evaluation	125
Fig. 6.4: Effect of basic specific fixed cost on kWh cost	126
Fig. 6.5: Effect of basic specific fixed cost on return period	126
Fig. 6.6: Effect of fuel cost on kWh cost	127
Fig. 6.7: Effect of fuel cost on return period	127
Fig. 6.8: Effect of operation cost on kWh cost	128
Fig. 6.9: Effect of operation cost on return period	128
Fig. 6.10: Effect of external cost on kWh cost	129
Fig. 7.1: Overview of the suggested system	133



## List of Appendices

Appendix 1-A: Sudan overview	151
Appendix 1-B: Crops in Sudan	152
Appendix 2-A: Questionnaire and key informants sheet	156
Appendix 3-A: Summary of different gasification systems requirements and products	160
Appendix 3-B: Properties of contamination removal system	161
Appendix 3-C: Sensitivity of different system to contamination	161
Appendix 3-D: Types of Fuel cells	162
Appendix 4-A: Test sheet for fuel properties of agricultural residues	163
Appendix 4-B: Results of fuel properties for tested material	164
Appendix 5-A: Calculation of Producer gas volume flow rate	166
Appendix 6-A: Dust storm over the study area	167



# Acronym and Nomenclature

## A/Abbreviations

°C	Degree Celsius
€	Euro
\$	United State Dollar
a	Annum (year)
a. o.	among others
AAS	Atomic Absorption Spectrometer
AFC	Alkaline Fuel Cell
ASTM	American society for testing material
BGPP	Biomass based gasification power plant
BkWh	Billion kilo watt hour
c.v.	Calorific value
CAS	Chemical abstract surface
CFB	Circulating fluidized bed gasifier
CHP	Combined heat and power
DAAD	Deutsche Akademische Austausch Dienst
DIN	Deutsches Institut für Normung
ECN	Energy research Centre of the Netherlands
e.g.	for example
EG	Entrained gasifier
EJ	Exajoule
ER	Equivalence ratio
ETC	External turbine cycles
FAO	Food and Agriculture Organization of the United Nations
fed	Feddan (0.42 hectar)
FNC	Forest National corporation (Sudan)
FT	Flowing temperature

<b>GAC</b>	Gum Arabic Center- University of Kordufan
<b>GDP</b>	Gross domestic product
<b>Gg</b>	Giga gram
<b>GJ</b>	Giga joule
<b>GMO</b>	Genetically modified organisms
<b>GN.S</b>	Groundnut shells
<b>GWh</b>	Giga watt hour
<b>hh</b>	House hold
<b>hr</b>	Hour
<b>ICE</b>	Internal Combustion Engine
<b>IGCC</b>	Integrated Gasification Combined Cycle
<b>IGEL</b>	Gasifier at TU- Dresden - Institut für Energietechnik
<b>IS</b>	Isolated Stations
<b>ISO</b>	International Organization for standardization
<b>ITC</b>	Internal turbine cycles
<b>kJ/kg</b>	Kilo joule per kilo gram
<b>km</b>	Kilo meter
<b>Kv</b>	Kilo volt
<b>K<sub>w</sub></b>	Gas equilibrium constant
<b>kWh<sub>el</sub></b>	Kilowatt hour electrical
<b>kW<sub>th</sub></b>	Kilowatt hour thermal
<b>kWh</b>	Kilo watt hour
<b>KWT</b>	<i>Professur für Kraftwerkstechnik</i> Professorship for Power Generation Technology
<b>LPG</b>	Liquefied Petroleum Gas
<b>m.c.</b>	Moisture content
<b>MCFC</b>	Molten carbonate fuel cell
<b>MEM</b>	Ministry of Energy and Mining (Sudan)
<b>MJ/kg</b>	Mega joule per kilo gram
<b>MOA</b>	Ministry of Agriculture (Sudan)

<b>Mol. wt</b>	Molecular weight
<b>MT</b>	Metric ton
<b>MW</b>	Mega Watt
<b>NEA</b>	National energy administration (Sudan)
<b>NEC</b>	National Electricity Cooperation (Sudan)
<b>NG</b>	National Grid
<b>ORC</b>	Organic Rankin cycle.
<b>PAFC</b>	Phosphoric Acid Fuel Cell
<b>PAH</b>	Poly-aromatic hydrocarbon
<b>PEMFC</b>	Proton Exchange Membrane Fuel Cell
<b>PFB</b>	Pressurized fluidized bed
<b>PG</b>	Producer gas
<b>R</b>	Turn ratio
<b>SDD</b>	Sudanese Dinnar
<b>FB</b>	Fluidized bed gasifier
<b>Sig-Level</b>	Significance level
<b>SOFC</b>	Solid Oxide Fuel Cell
<b>ST</b>	Softening temperature
<b>SIT</b>	Sintering temperature
<b>ST.E</b>	Stirling engine
<b>St.PI</b>	Straw pellets
<b>T ton</b>	Thousand ton
<b>TOE</b>	Ton of Oil Equivalence
<b>VOC</b>	Volatile Organic Compounds
<b>Vol.</b>	Volume
<b>VUB Brussels</b>	Vrije Universiteit Brussel
<b>W/m<sup>2</sup></b>	Watt per meter square

**Currency exchange rate at time of study**

1 \$ = 230 SDD

1 € = 270 SDD



## B/List of symbols

Symbol	Function	Unit
$\eta_h$	Hot efficiency	
$\dot{V}$	Volume flow rate	Nm <sup>3</sup> /hr
$\eta_c$	Cold efficiency	
$\dot{m}$	Mass flow rate	kg/hr
A	Area	m <sup>2</sup> ; hectare; feddan
Be	Loading of solid substances in gas	g/N.m <sup>3</sup>
c.v.f	Fuel calorific value	MJ/kg
c.v.g	Producer gas calorific value	MJ/Nm <sup>3</sup>
C <sub>d</sub>	Daily electric cost	kWh/day
C <sub>p</sub>	Specific gas capacity	kJ/kg K
CV	Coefficient of variation	%
D	Quantity of each device in house hold	
F	Availability factor	
kWh <sub>p</sub>	Actual kWh price	SDD/ kWh
L	Air requirement	kg air/kg fuel
L <sub>b</sub>	Left over agricultural residues in field	ton
m	Mass	kg, g
m.c	Moisture content of material at analysis	
n	Equivalence ratio	
P	Pressure	Pa
Q <sub>d</sub>	Daily electric consumption	kWh/day
Q <sub>p</sub>	Flow rate at pump	l/min
r	Correlation coefficient	
R <sup>2</sup>	Coefficient of multiple regression	
R <sub>A</sub>	Residues produced/Area	ton /hectare(fed)
R <sub>m</sub>	Materialistic available residues	ton
R <sub>p</sub>	Total residues produced	ton
S	Standard consumption of devices	kW
t	Time	min
T	Temperature	K, °C
U	Daily usage duration for each device	hr/day
ρ <sub>g</sub>	Gas density	kg/m <sup>3</sup>





# Introduction

## Motivation

The search for adopting new energy technology in Northern countries could be motivated by a pure scientific interest, or as economical measure such as reducing energy price/increasing profits within the context of improving the power plants economics. Lately the environmental dimension was introduced as a result of voluntary commitment to mitigate the industrialization consequences. An important factor here, the energy research is to be considered within the comprehensive analysis for the socioeconomic conditions of the production/consumption patterns in *the welfare* context.

However this study deals with electricity provision issues under developing countries condition motivated by the fact that the necessity to find a possible sustainable source of energy in countries like Sudan is so crucial and essential; the prevailing low level of infrastructure, and unsustainable use of natural resources is not only resulting in generating the vicious circle of poverty, ignorance and illness but within the context of globalization and perception of development as a basic human right then social tension and civil war are also expected<sup>1</sup>. So the classical approach of considering the technical and economical aspects only need to be revised.

Electricity production is the focal point for this work because in comparison to other energy forms such as cooking fuel it will not only improve quality of life but as pre requirement for civil life it plays an important role in sustaining a minimum level of economics growth. Further it will enhance the development/urbanization process in the long run while at the short run it will facilitate the promotion of other services like education or health. Moreover electricity is assumed to be perceived as product with very high demand. This interest can motivate people to accept, adopt and support new environmentally friendly technologies to produce electricity. In this context high cost and price could be tolerated.

Renewable energy was mostly presented in third world countries as solution for poor people in purely rural context; however, this approach doesn't encourage adoption nor secure sustainability. In this study concentration will be given to the urban centres, considering the geopolitics of countries like Sudan then the urban areas are drivers to economical development and social stability. On the same time the citizens of such cities usually inhabit the middle class who are able to purchase such product and appreciate its merits. The urban centres in western Sudan, if more stable power supply was available, can act as concentrating points for industry and service, and so improve the whole economic situation. This can also help in lowering the social and political tensions in these areas which are located in or near Sudan's major conflicts zones.

---

<sup>1</sup> UNDP report on Environment, development and conflicts in Sudan 2007

Electricity could be derived from fossil fuel however the expansion in this direction faces different problems like sustainability and economical priorities. Delivery of fossil fuel to relatively remote areas is unreliable and costly practice. Furthermore the environmental dimension cannot be ignored, the international obligation towards global warming and CO<sub>2</sub> emission is now not only concentrated on the *North* countries like USA or Australia but extend to include *South* countries like Brazil or South Africa. One expects that on the near-by future all countries will be obliged in a way or another to reduce their emissions. At this point clean energy will be the first target<sup>2</sup>. As a precaution step for such *progress* then environmental electricity production systems such as biomass gasification should be investigated to assess its suitability under *southern* countries conditions.

### **Study's scope**

The study does not claim the production of **Yes/ No** answers but looks to itself as part of continues efforts to clarify the comparative merits for thermal utilization of biomass, considering agricultural residues gasification for electricity generation as specific target. The main outcome is identifying gaps and generating recommendation for further research.

### **Objectives**

#### **Over all objective**

The overall objective of the study is to investigate the possibility of agricultural residue gasification for electricity production in Sudan.

#### **Specific objectives:**

- Study current electricity situation and the expansion possibilities.
- Assess the comparative merits of agriculture residues as source of energy in Sudan.
- Assess the technical possibility of gasifying the sudanese agricultural residues.
- Identify and quantify electricity need and agriculture residues potentiality at a typical location.
- Draft a suitable gasification based power plant and test its economics.
- Identify gaps and generate recommendation.

### **Approach used**

Energy (electricity) is not pure a technical issue<sup>3</sup> especially when it is based on local sources like biomass and aims for playing a social role. The investigations done should not only include physical issues such as resource potentiality and availability but factors such need satisfaction, acceptance or social perception are to be considered especially when the technology present itself as environmental measure. Thus the selected approach had taken in consideration that adoption/integration of different renewable energy technologies in developing countries had failed in spite that they are technically identified as *mature technology*, modern use of biomass as source

---

<sup>2</sup> G 8 summit recommendations -June 2007, see also little green data book 2007- World Bank

<sup>3</sup> Biomass energy group meeting in Dresden 30.05.2007

of energy is not an exception. In Sudan different biomass technologies at different times were introduced and huge efforts was paid by different institutes<sup>4</sup> but recognizable effect could not be claimed. The author’s interpretation that on one hand detailed/quantified technical studies for these technologies were not comprehensive and on the other hand the interdependency of the different factors were not thoroughly investigated and the real society interest, preception and acceptances were not deeply considered. Selection of *wrong* target group such as the very vulnerable social strata (poor, rural population) was a common practice.

Therefore in this work a multi dimensional approach is used, different methodologies were incorporated e.g. theoretical analysis, field work and experimental conduction. The study is carried out based on the conceptual frame work explained below and visualized in (Fig I):

**1-Input level** is composed of three parallel aggregates namely:

- Materialistic issues such as current energy/electricity state, resources potentiality, transport and distribution issues as well as national and international consideration.
- Technical aspects in which technical factors that govern biomass gasification are investigated.
- Social level by quantifying the electricity consumption/demand and the factors affecting it, issues of acceptance and perception were also considered in this level.

**2-Analysis and evaluation level** which includes the tasks of generating a concept for a suggested specific power plant components and investigating its economics.

**3-Out put level** is realized through identification of information gaps and generation of recommendation

**Input**

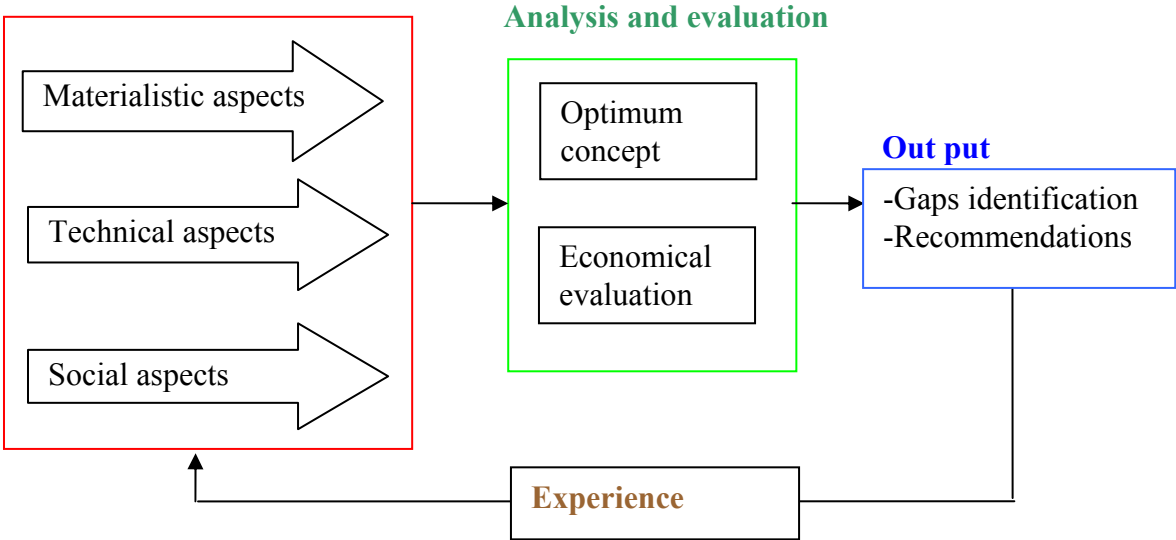
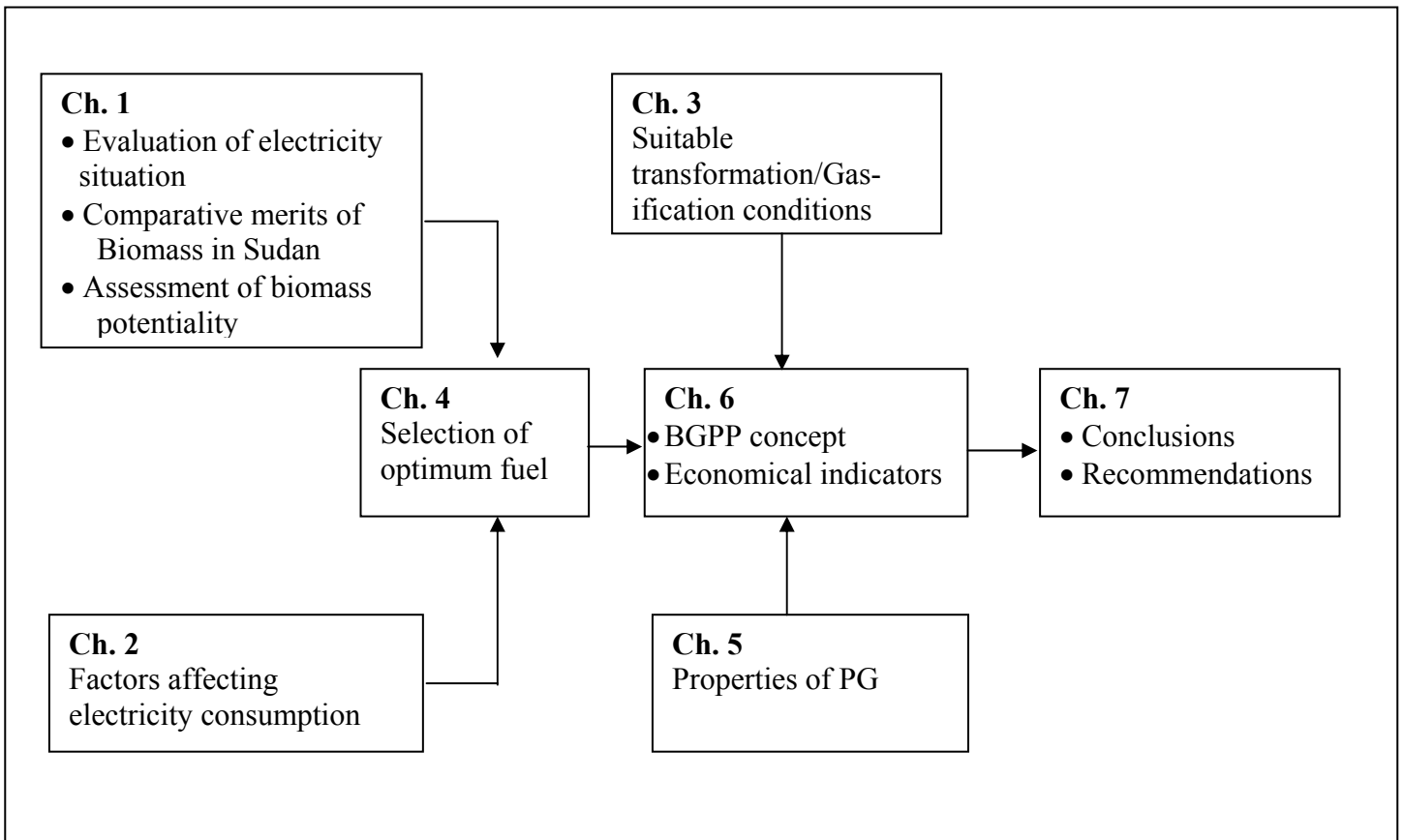

**Fig. I: Approach used**

<sup>4</sup> See e.g. ERI research work and reports about the national project for fuel wood alternatives and improved stoves in Sudan

## Built up of study

Based on the multi dimensional approach the thesis was built up of 7 chapters as seen in (Fig. I I)



**Fig. II: Built up of the study**

### Chapter 1

Chapter one deals with state of art and future perspectives in relation to electricity generation in Sudan, main questions raised are: what are the characteristics of electricity production in Sudan? is there is any electricity gap? If so, then where? Who are the more vulnerable group? In this chapter potentiality and limitation of different primary sources to generate electricity are discussed. The international and national concerns towards electricity production and consumption issues are also highlighted.

### Chapter 2

This part displays the results of field work done to investigate electricity production and consumption patterns and related factors in a case study context. Biomass availability in this site was also investigated.

### **Chapter 3**

This chapter tackles the theoretical background of biomass gasification; this is done to support the selection of gasification technology as well as to identify the practical steps that will control the experimental work and the power plant layout. It includes topics such as biomass energy merits and gasification process, further gasifier types and products were tackled. In its last part it evaluates the different systems used for electricity production based on biomass gasification.

### **Chapter 4**

This chapter discusses the aspects and factors that govern the fuel properties of biomass and discuss the interrelationship of such properties with the technical and economical efficiency of biomass gasification power plants. In its second part it displays the result for laboratory analysis of multi- origin, multi-species biomass samples.

### **Chapter 5**

It serves to asses the technical possibility of selected agricultural residues in fixed bed gasifier. Mainly it deals with the gasification results of the different biomass material in 75 kW fixed bed down-draft gasifier.

### **Chapter 6**

This chapter conceptualizes aggregates of a biomass gasification power plant (BGPP) and evaluates selected economical indicators for this system.

### **Chapter 7**

Gives an overall conclusion, identify information gaps and generate recommendations.

## **Lay out**

The study is written in chapters form in a way that every chapter could be handled as independent unit. Each chapter is preceded by listing the objectives, contents and conclusion direction and ended by statement introducing the following chapter. References are tabulated individually for each chapter and attached at the end of the study. Titles of arabic references are translated into English and (Arabic) notation is suffixed. German references titles are cited unchanged.

The Appendixes are found at the far end of the study while the Nomenclature and the list of abbreviations and symbols used are found at the beginning. Tables of contents, figures and tables are located at the study first pages and tabulate accordingly.



# 1 Energy Situation in Sudan: Status, Potentials and Prospects

The main objectives of this chapter are to:

- Provide an overview of the present energy and electricity situation in Sudan.
- Investigate the potentiality of the possible resources in relation to electricity production.
- Study selected issues of biomass potentiality in Sudan.

Thus the contents of this chapter include:

- Energy and electricity current state in Sudan.
- Possible energy sources for electricity production, potentiality and limitations with special emphasis on Sudan.
- National and international concerns with respect to electricity production in Sudan.

The conclusions aim to identify the electricity gap in Sudan and the optimum resources to fill it.

## 1.1 General

### 1.1.1 Global ranking

Sudan (Appendix 1-A) is not one of the energy consuming countries, actually it lies at the lower steps of the global consumption ladder. Consequently, the Carbon Dioxide (CO<sub>2</sub>) emission per person is also one of the lowest in the world. Comparing Sudan to other countries e.g. Germany then this gap could be assessed (table1.1).

**Table 1.1: Overall energy indicators for Sudan (2003), Germany (2004)**

<b>Indicator</b>	<b>Germany</b>	<b>Sudan</b>
Total annual energy consumption (EJ) **	15	0.55*
Per capita energy consumption (GJ/year)	183	14
Total annual electricity production (BkWh)	567	3.2
Per person CO <sub>2</sub> emission (ton)	10.5	0.3

\* including traditional energy sources.

\*\* based on primary energy figures.

**Source:** [1], [2]

### **1.1.2 Energy balance**

Based on the information obtained in [1] Sudan energy balance in 2003 could be presented as shown in (Fig. 1.1). Analysis of this balance in relation to primary resources, losses and consumption sectors, reveals the following features:

- Biomass constitutes a major energy resource in Sudan (**70 %**).
- Relatively high losses (**30 %**) encountered between primary and final energy recourses.
- The household sector constitutes the major consuming sector (**55 %**).



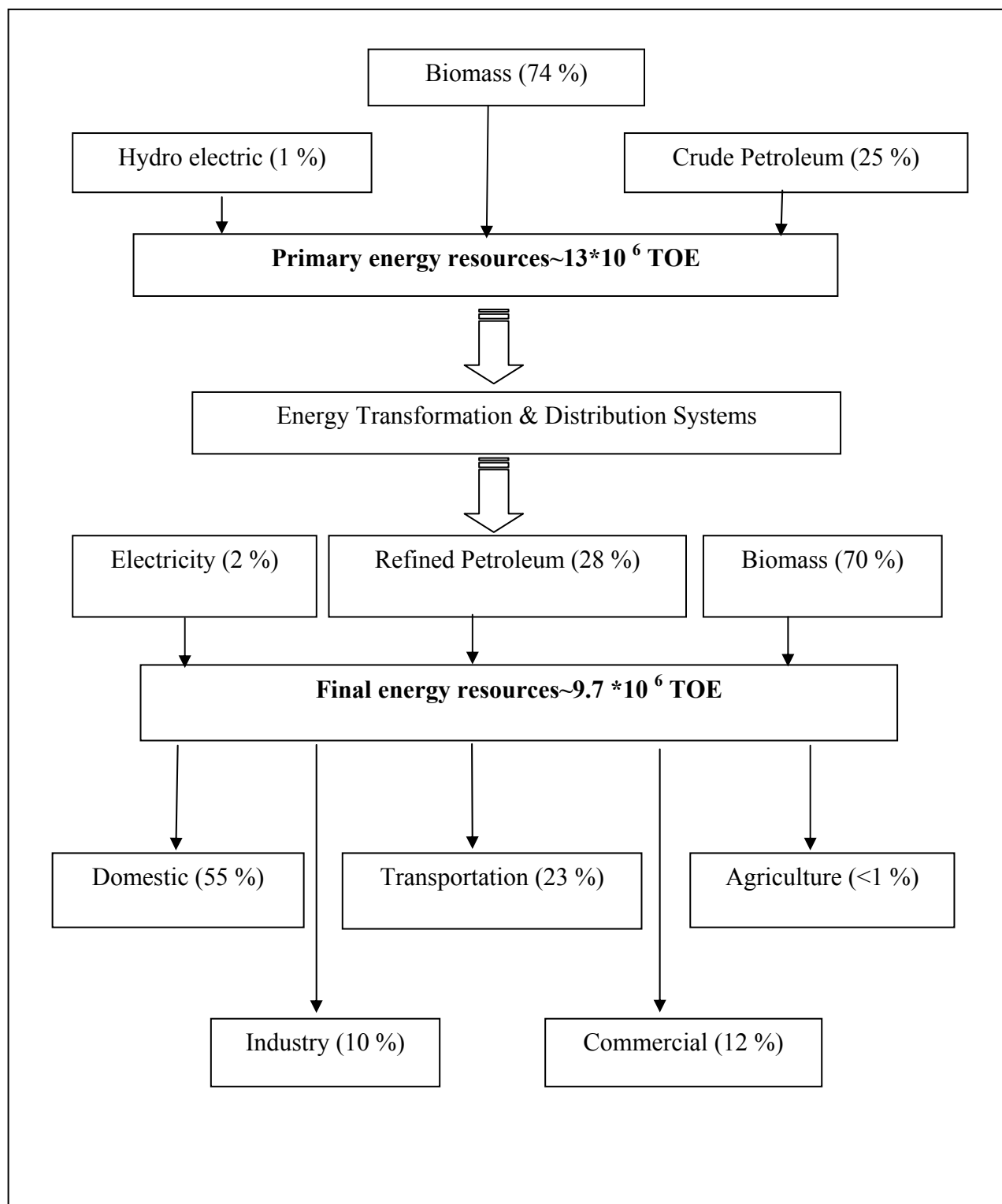

**Fig. 1.1: Sudan energy balance (2004)**

Source: based on [1]

### **1.1.3 Electricity Supply**

#### **Status of electricity Production**

The electricity supply services in Sudan (Fig. 1.2) could be classified either technically to:

- 1 Thermal power plants using different fossil fuels (Steam turbine (ST), Gas turbine (GT) or Internal combustion engine (ICE).
- 2 Hydro-power plants mainly in Roseries and Sennar.

or administratively into:

#### **National Grid (NG)**

This is a centralized system based on hydro and *macro* thermal power stations connected together in one grid. This system is flexible and relatively sustainable as a deficit in one component could be mitigated by the other components. However its capacity is limited hence it covers mainly the capital 'Khartoum' in addition to some areas in eastern and central Sudan.

#### **Isolated Stations (IS)**

This is a decentralized system in which micro thermal power plants are erected in some selected cities in Sudan (16 Cities in 2004). The installed capacities range between 1.4 MW in Wau (South Sudan) to 34 MW at Port- Sudan (main port at Red Sea). The whole system is highly fragile as it suffers from various quandaries including in-adequate fuel delivery, use of obsolete technology and inadequate maintenance. The limited capacity of the (IS) allows only the *city centres* of these cities to enjoy the privilege of electricity supply.

In 2004, the total installed electricity capacity in Sudan was 1186 MW. The (IS) had a share of ~180 MW while the (NG) produced~ 1006 MW. Within the (NG), the electricity production through hydro power stations was estimated by~ 342 MW while the thermal station production was estimated by ~665MW as seen in table 1.2. The maximum load was ~611 MW at 13 p.m. while the minimum load recorded was~ 373 MW at 4 a.m. The total electricity generated by NEC was~ 3749 GWh. [3], [4].

Analysing the electricity statistics based on [1], [3], [4] the following features could be identified:

- Ascending share of thermal-based electricity in the (NG) .This is obvious when comparing 1990 figures of the total generation (~1500 GWh, 66 % hydroelectric) to 2003 figures (~3500 GWh, of which 29 % is hydroelectric).
- Noticeable difference between installed and available capacity as seen in table 1.2 which also details the various electricity production systems used in (NG).
- High losses within different stages, in 2004 NEC had generated 3749 GWh, the sold quantity were 2496 GWh i.e.~ 33 % loss are identified between production, sale, and consumption.
- Thermal power plants are characterised by relatively high fuel consumption: 0.22-0.46 kg /kWh of fossil fuel (Petroleum products) and low efficiency generally <30 %.

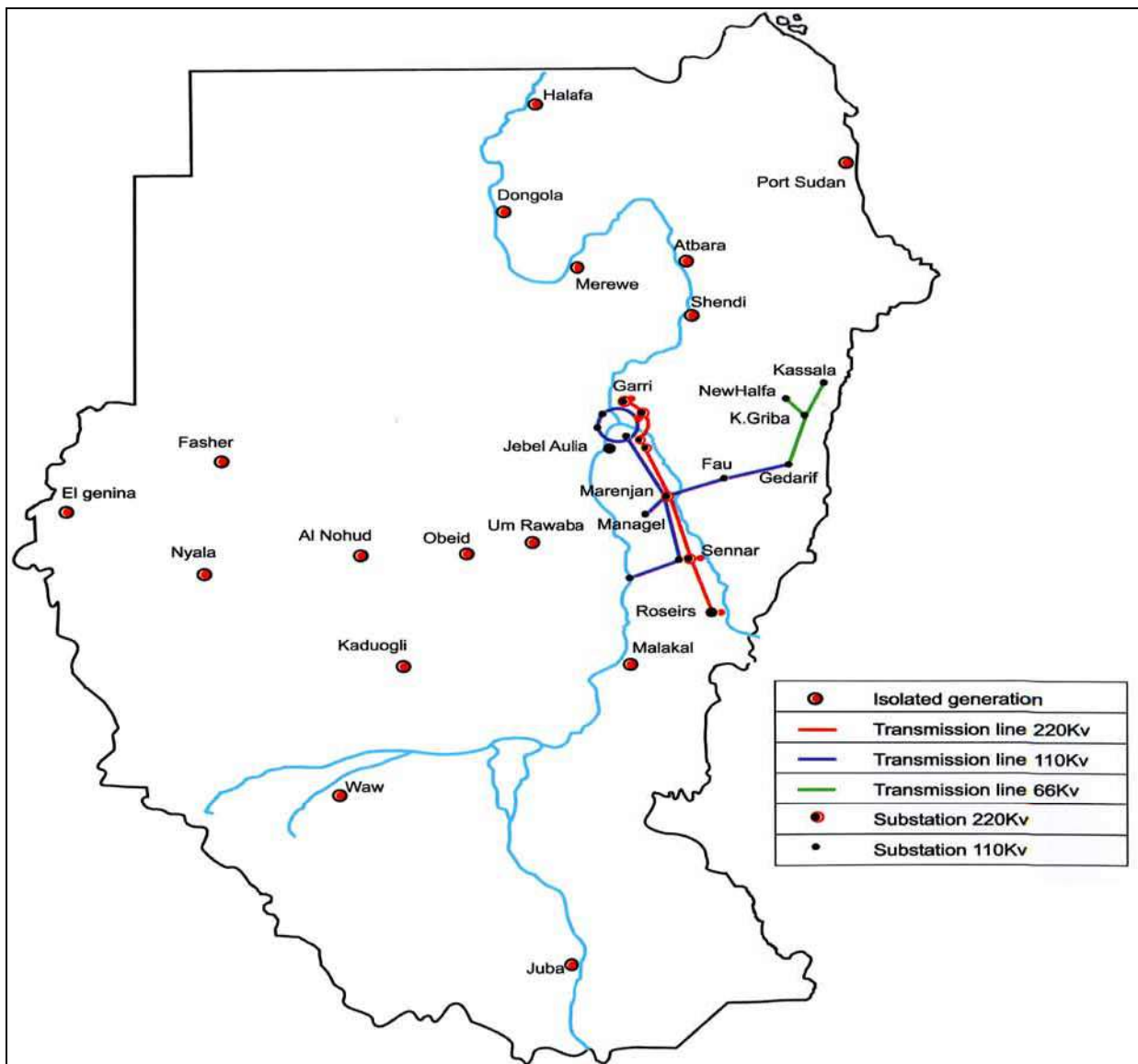

**Fig. 1.2: Electricity Services in Sudan (2004)**  
 Source: [3]

### **Status of Electricity Consumption**

Electricity distribution among the population shows high fluctuation at both the sectoral and geographic aspects. This is displayed in (Fig. 1.3) which visualizes an overview of electricity consumption patterns in 2004. In 2004 (NEC) had ~ 750.000 legal costumers only. According to the national average family size of ~ 6 persons (see appendix 1) this is equivalent to about 5 million persons out of a total population of 38 millions. Out of this figure, only ~ 55 % (based on 2002 figures) were served through the NG system which assure a relatively acceptable performance, the remaining customers were supplied through the *second class* IS and so suffer from non-efficient supply e.g. longer periods of blackouts. On the other hand unequal geographic distribution is evident

**Table 1.2: Power plant production in NG (2004)**

System	Installed capacity (MW)	Available capacity (MW)	Share to total generated electricity (%)	Process efficiency (%)
Water. turbine	342	333	29	---
Steam turbine (Furnace)	180	174	28	25-28
ICE (Diesel)	12	7	10	28
Gas turbine (Natural gas)	262	191	27	22
Combined	210	180	6	39
Total	1006	885	100 %	

\*All figures rounded to nearest whole number

**Source:** [3], [4]

from the official statistics e.g. according to [5] then in 2000, Khartoum had consumed ~ 62 % of the total electricity generated in Sudan, the Northern region 3 % and western Sudan (Kordufan and Darfur) <2 %. Also a study carried by UNDP (United Nation Development Programme) in 2003 [6] estimated the partial electricity coverage of semi-urban centres (Small cities) by 22 % of those in the Northern region while it was only 4 % in western Sudan.

### **Cost and Price of Electricity**

Electricity was always a subsidised commodity in Sudan as the production cost is higher than the average sale price. In 2004 the production cost was estimated by~ 0.08 €/kWh. This is mainly due to the high cost of fossil fuel and other operating materials that constitute the major components in the cost breakdown. In 2004, these constituted ~58 % and 21 % of the total cost, respectively. On the other hand, the growing support for structural adjustment in economical policies and the push towards privatisation resulted in different measures to address these objectives. These measures included:

- Lower subsidies in budget; in 2004, The National Electricity Cooperation (NEC) budget was subsidised by 20 % compared to 25 % in 2003, although the budget has gone down from 300000 SDD to 268000 SDD , the fuel price had increased by 16 % between 2003 and 2004.
- Higher tariff prices (tariffs are geographically unified but vary sectorally into domestic, agriculture, commercial/services, industrial and governmental), prices had increased from 0.04 €/kWh in 1998 to 0.07 €/kWh in 2004 for domestic (lowest rate) and from 0.08 €/kWh to 0.13 €/kWh in the commercial sector (highest rate) [3], [4].

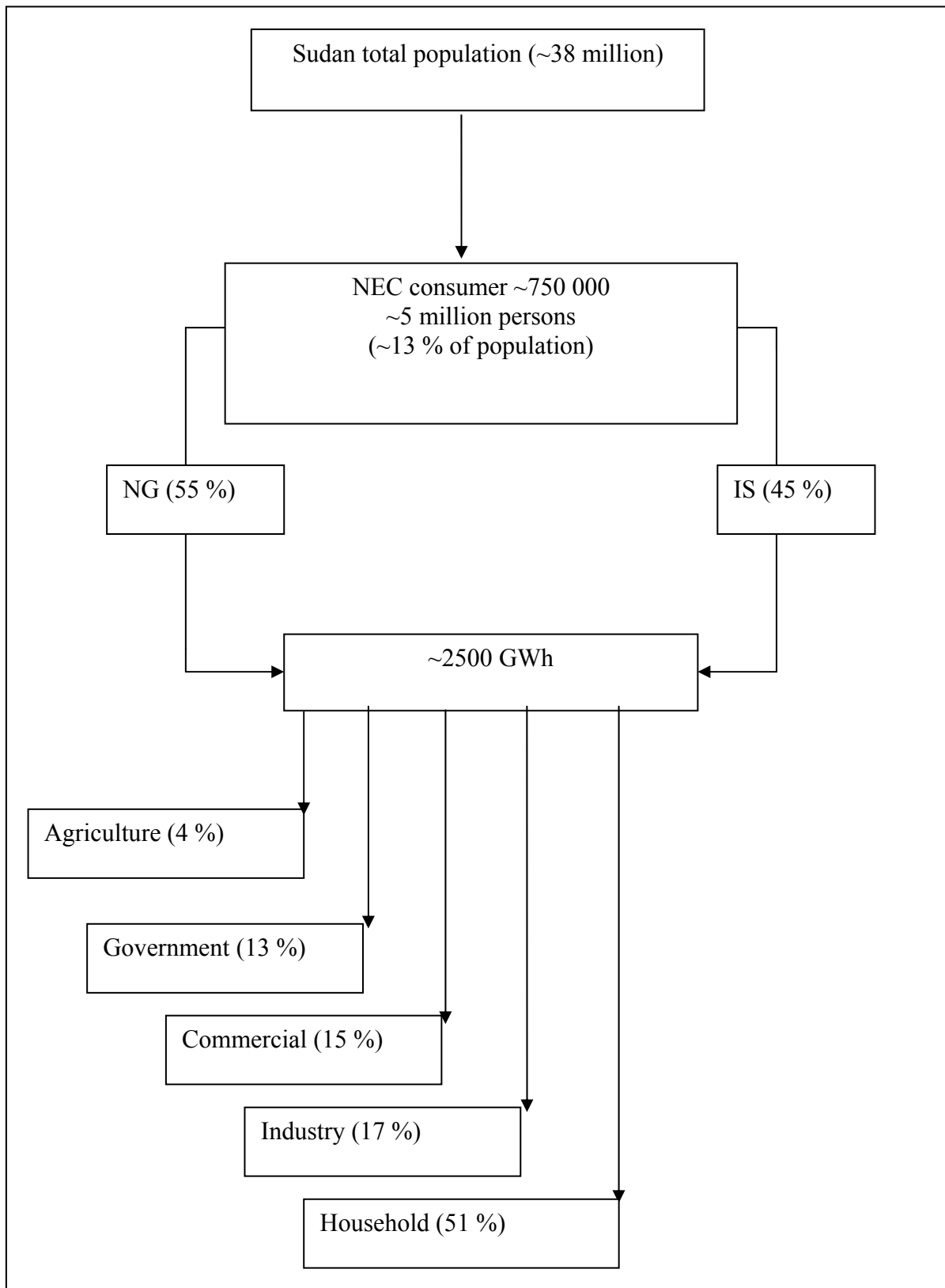

**Fig. 1.3: Electricity service distribution in Sudan (2004)**

Source: based on [1], [3], [4]

### **Distribution and losses**

In spite that Sudan is a vast country (~1400x1600 km) but the electricity distribution infrastructure i.e. transmission lines, intermediate transformers are very limited (Fig. 1.2). The main transmission lines (220, 110, 66 kV) cover only 2105 km of which the 220 kV are extended only for 1080 Km and the total capacity is estimated by 2169 MVA. The quality of the transmissions is also questionable which contribute to the 33 % loss of the generated electricity [3], [4].

Erection of decentralized power plants will help in reducing such losses.

### **Future Plans**

The main features for the future development plans for NEC according to [3], [4], [7] are:

- Increasing the generation (vertical expansion), this will be carried out through erecting new thermal and hydro power plants. One of the big projects that are in the executing phase is Merowi dam with 1250 MW. However, the big hydroelectric dams are facing a lot of problems and opposition because of the re allocation and compensation policies for affected groups.
- Expanding the NG to western and southern Sudan (horizontal expansion) .This is an old dream but the high value of extending the grid across the wide area and the limited available electricity (within the NG) restrict its realization.
- Insuring the supply sustainability through connecting the Ethiopian and the Sudanese grid (200MW). The project is based on the fact that the hydroelectric potential in Ethiopia allows stable, cheap electricity supply but besides the technical problems the fluctuating political relationship between the two countries implies doubtfulness remarks.
- Privatization through encouraging the private sector to work in all electricity sectors specially the distribution and sales sectors. However, the ability of the private sector in Sudan to undertake these plans and the social implications of this step are controversial issues.

As seen from the above data the expansion of electricity production all over Sudan and especially in western Sudan is one-step towards realising an efficient and equitable distribution of this service Considering the possible way to achieve this goal, it could be concluded that central expansion plans are constrained by the above mentioned factors, hence decentralized electricity production systems are justifiable. Possible energy source for these systems will be further discussed.

## **1.2 Discussion of primary energy resources and their potential for electricity production**

### **1.2.1 Petroleum**

#### **Production and Potential**

As stated in section 1.1.2 Sudan gets nearly quarter of its primary energy from fossil fuel. Sudan was an oil importing country until mid-nineties when commercial oil exploration started and so proved potentials are found in different regions of Sudan (Fig 1.4). In 2005 the proven potential was estimated by 0.6 billion barrels in addition to 3 trillion cubic feet of natural gas, however out of 360 000 barrel/day produced in 2005 only 82 000 barrel were locally consumed i.e. only 30 % (Fig 1.5) [2]. This is due to fact that oil revenue constitutes a growing share of the GDP that in 2005 the total exports were \$ 4,824.24 million of which petroleum constitute \$ 4,187.36 million i.e. ~ 87 % [8]. Petroleum export has a very high priority particularly from a political point of view as the sharing of oil revenues between North and South Sudan is an essential element of the peace agreement of 2005 that ended 22 years of civil war. Unfortunately, the use of Petroleum for electricity production is not profitable and limits the government immediate revenues. Petroleum could be exported at \$ 70/barrel (144 kg) i.e ~ \$ 0.5/kg while electricity production (0.3-0.5 kg /kWh) generate a revenue of ~ 0.15 - 0.24 \$/kg.

#### **Petroleum Consumption**

Petroleum products consumption in Sudan shows continuous increase totalling to ~ 300 % in the last 10 years (1.2 million Ton of Oil Equivalence<sup>5</sup> (TOE) in 1993 to 3.3 million TOE in 2003). This applies to nearly all petroleum derivatives. Nevertheless, the greatest increase was in the consumption of LPG which increased 10 times while “electricity fuels” show significantly lower increases (Diesel 1.3 times and Gas oil 3 times) [1], [2].

Petroleum consumption patterns also show both sectoral and regional imbalances. Statistics show that 64 % of Petroleum products consumed in Khartoum, mainly in the transportation sector, which is the main consumption sector in Sudan. In 2003, transportation in Khartoum consumed 43 % of the total fossil fuel consumption in Sudan. On the other hand, the statistics of Ministry of Energy and Mining (MEM) [9] showed that in between 01 Jan.-30 Nov. 2005 the total dispatch was 4768568 Ton, out of which the electricity sector get 45008 Ton i.e. ~ 9.5 % only.

---

<sup>5</sup> TOE=42000MJ

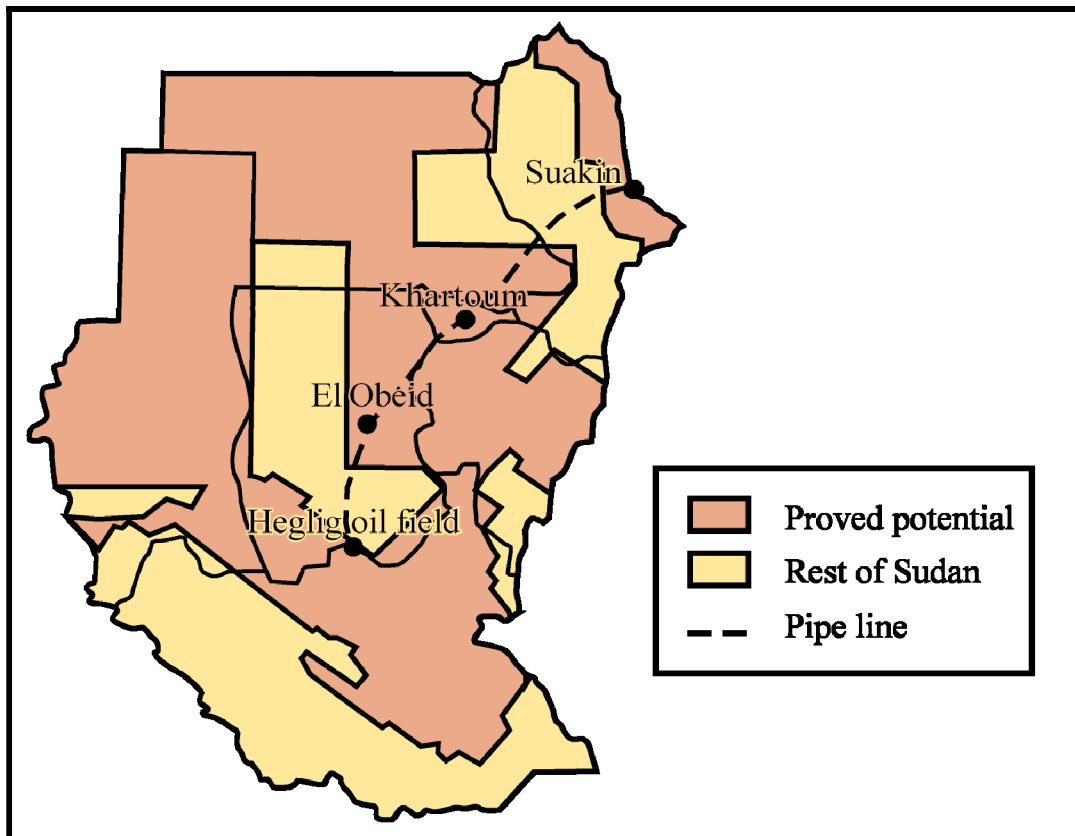

**Fig. 1.4: Petroleum reserves in the Sudan (2004)**  
 Source: modified by author based [9]

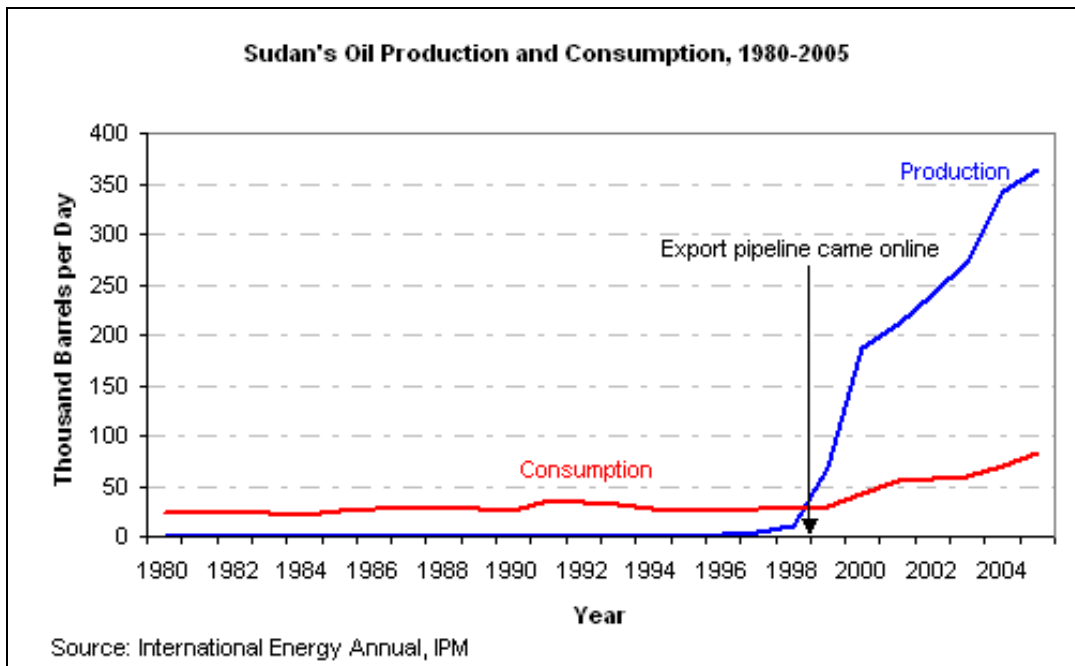

**Fig. 1.5: Petroleum production in Sudan**  
 Source: [2].



### **Petroleum Transportation and storage**

A main hurdle that faces efficient use of petroleum for electricity generation is transportation. Internal transportation of Petroleum (crude + products) takes place in three different ways. The most cost-efficient way, the pipeline transfers only 15 %. Approximately 48 % is transported via the railway while the more inefficient transport system, via road trucks, has a recognizable share of 37 %. River transportation despite its relative economic advantage plays no role at present [1].

Thus although the dispatch price (from refineries) is the same all over Sudan however at remote area fuels are only obtainable at higher prices, this is due mainly to huge transportation costs and local taxes. Furthermore, the dependence on road transportation, without the existence of adequate road networks, adds to the supply sustainability problem. The result is that more remote power plants pay higher prices for their fuel but cannot guarantee a secure supply.

Bearing in mind that fuel constitutes major component of the electricity cost (section 1.1.3) it is then highly justifiable that any saving within this factor will necessary result in reduction of the electricity cost and price allowing for better service.

The main storage depots are in the bigger urban centres mainly Khartoum and Port Sudan. The capacity of these depots is very limited; additionally the storage facilities in cities outside of the NG zone tend to be smaller. When comparing the storage capacity with the fuel requirement, then the sustainability of fuel supply for power plants tends to be uncertain as shown in table 1.3. [1], [9].

**Table 1.3: Petroleum storage capacities and electricity need (2003)**

<b>Product</b>	<b>Saving Capacity (Mt)*</b>	<b>Use of electricity (Mt/year)**</b>
Gas oil	110974	266494
LPG	5598	25460
Furnace	12000	329496

\* till 2003, \*\*based on 2004 figures

**Source: [1], [3]**

It could be deduced from the above analysis that the provision of a continuous and adequate Petroleum supply for the needs of thermal power plants, particularly (IS), is not only questionable but it could also be a troubling factor which hinder sustainable and reliable electricity supply.

### **1.2.2. Solar, Wind and Hydropower**

This section discuss the possibility of using the above mentioned resources as sources for decentralized electricity generation in Sudan as general and western Sudan in particular.

#### **Solar energy**

Due to its geographical situation between the tropics of Capricorn and Cancer then Sudan considered one of the “solar countries” as seen in (Fig. 1.6). The average annual solar energy ranges between (7 –10 GJ/ m<sup>2</sup>/year) with an average solar day of 9 hr and a total annual solar radiation

## ***Energy situation in Sudan: Status, Potentials and Prospects***

---

period of 3300 hr/year [10]. However, solar energy may not be a viable option in Sudan because in addition to the known solar energy limitations (high cost, difficulty of storage) [6], another technical problem that faces the utilization of solar energy in Sudan is the high atmospheric temperature  $>35$  °C. This could lower the PV efficiency and reduce the power out [11]. Moreover, high amounts of dust in the air can lead to reduction in the solar radiation concentration. This reduction estimated by 20-40 % of the total solar radiation in Sudan [10]. In western Sudan, with its growing desertification problems, then this is an important element to be considered.

### **Wind Energy**

Unlike solar energy Sudan's wind, energy potentials are modest. The highest value lies in the northern region with  $\sim 200$  watt/m<sup>2</sup> (6-7 m/s) followed by some regions in central Sudan with average value of  $\sim 150$  watt/m<sup>2</sup> (2-3 m/s) (Fig. 1.7). As a result of this limited potential then the main wind utilization area in Sudan is envisaged to be pumping relatively shallow water for drinking or irrigation of small agricultural plots. [5], [10], [12].

### **Hydropower**

The main hydropower possibilities are found on the river Nile and its tributaries, actually different plans is been set to make use of this source e.g. Marowi dam [7]. However the main problems are the high starting cost needed for dam erection and the compensation for social and ecological changes. Considering the width of Sudan and the low population density then hydropower connection to remote areas away from production seems not to be economical. Special concerns should be given to the problem of sustaining and management of big systems under Sudan conditions. Furthermore under the prevailing social and economical context then big cities like Khartoum with their increasingly consumption will *swallow* any increase in the supply. Some studies [5], [10] had mentioned the potentiality of small hydropower in Darfur region but they are limited to small capacities, here again connection problems represent the main obstacle.

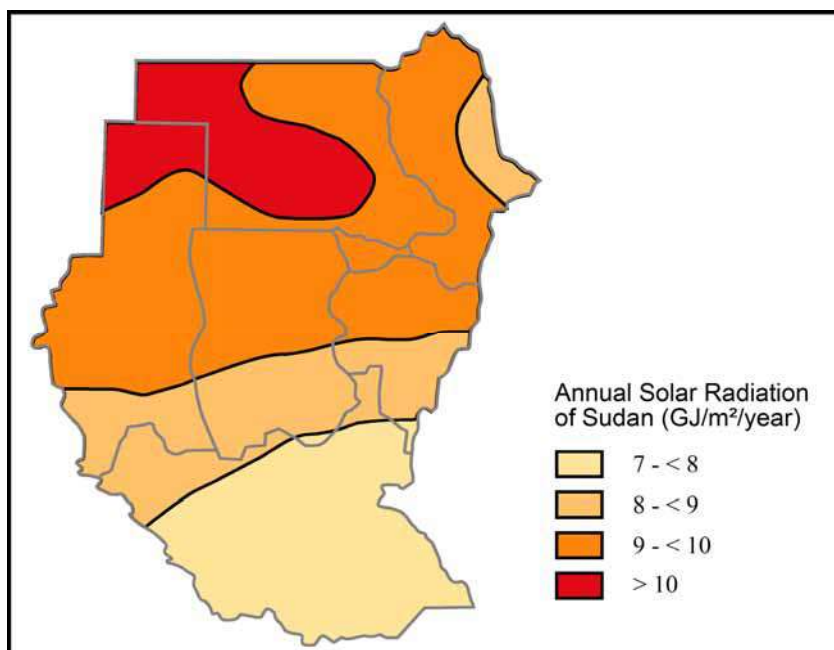

**Fig. 1.6: Average annual solar radiation of Sudan ( $\text{GJ}/\text{m}^2/\text{year}$ )**  
Source: based on [1] [5] [9]

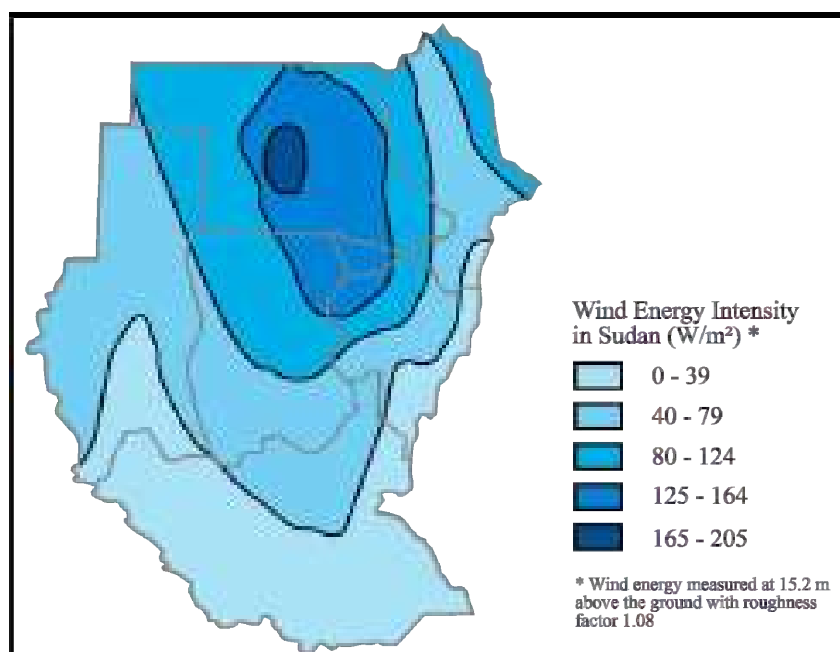

**Fig. 1.7: Wind energy intensity in Sudan ( $\text{W}/\text{m}^2$ )**  
Source: based on [1], [5], [12]

### **1.2.3 Biomass**

#### **1.2.3.1 General**

##### **Biomass as source of energy**

Biomass is the main source of energy in Sudan (section 1.1.2). This is not only valid for the household sectors in which it covers 95 % of the recorded energy consumption but it extends to the industry sectors in which biomass contributes to about 68 % of their energy need. Observing the sectoral divisions of biomass resources as shown in (Fig. 1.8) which display the biomass energy balance in 2003. It can be noticed that environmentally fragile biomass i.e. wood and charcoal are widely used while the *environmentally friendly* agriculture residues constitute only the lowest percent. [1] [5], [10].

##### **Biomass resources**

Biomass resources in Sudan are enormous. It could be classified using different criteria according to origin or use. In this work, the origin criterion was favoured. The following classifications were hence suggested as seen in (Fig. 1.9).

##### **Plant based biomass**

This includes all biomass resources originating from plants material in its raw state. Under Sudan condition these are mainly seen to be:

##### **Wood**

This source includes forests<sup>6</sup> and woodlands in addition to trees removed during land preparation process for other function such as agriculture or human settlements' expansion.

##### **Agricultural Residues**

Agricultural residues and failure-crops could constitute a considerable percent in sub-Saharan developing countries like Sudan due to frequent adverse climatic and environmental conditions (shortage of rainfall, insects plague etc).

##### **Wild Grasses and Plants**

These types of biomass are abundant in the fallow land which was estimated in [13] by 78 million ton of dry matter. When considering an average c.v. of ~10 kJ/kg then a potential of  $78 \times 10^6$  GJ could be proposed. However, animal grazing needs and biodiversity issues should be considered. On the other hand, grass species that are usually regarded as weed could be available e.g. *Water hyacinth* on the White Nile, was estimated in [12] for dry briquettes by (9 million ton/year) with energy potential of  $0.57 \times 10^6$  GJ. However, high water content and collection issue are limiting factors.

---

<sup>6</sup> Forest as defined by FAO is "Land spanning more than 0.5 hectares with trees higher than 5 meters and a canopy cover of more than 10 percent, or trees able to reach these thresholds in situ. It does not include land that is predominantly under agricultural or urban land use."  
afro cover report 2005

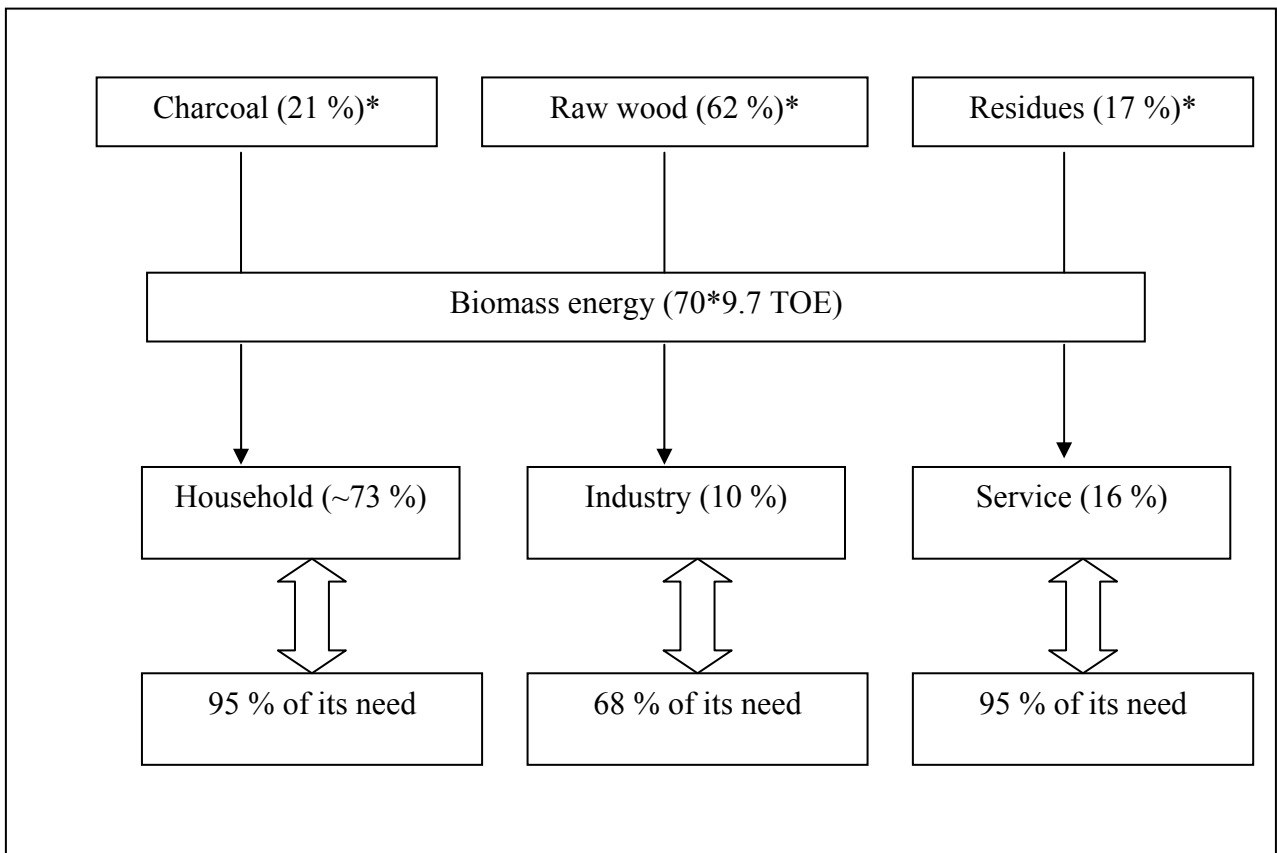

**Fig. 1.8: Biomass energy in Sudan (2003)**

\* 1999 statistics

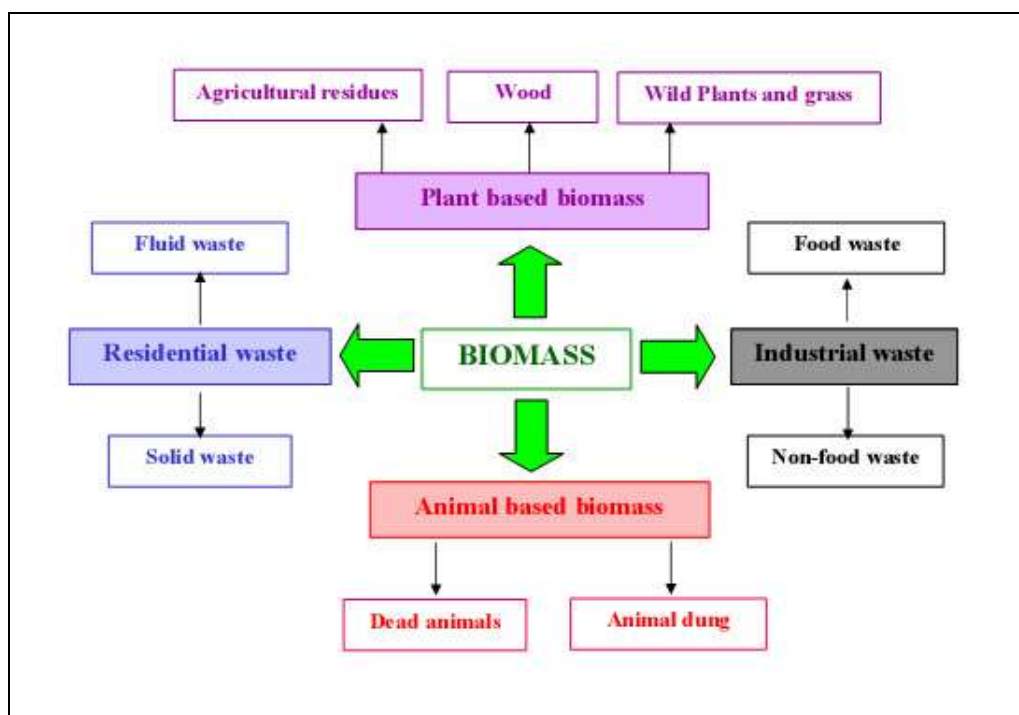

**Fig. 1.9: Biomass resources in Sudan**

### **Animal based biomass**

In Sudan as general this source could be composed of two main resources namely:

#### **Animal dung**

Livestock that are generally reared in Sudan such as cattle, sheep and camels are good dung producer both quantity and quality wise. The livestock population could be estimated by ~118 million and hence dung quantity of 550 million ton/year with c.v.~11 MJ/kg could be purposed [10]. However, the mobile nature of livestock rearing makes this potential questionable. Some studies like [5] estimated its physical availability by 10 % only. Furthermore, water shortage in areas of livestock concentration and social perceptions hinder the complete utilization of this resource.

#### **Dead Animals**

Low levels of veterinary service could results in high animal death rates, consequently animal carcasses at specific time such as plague spread or water poisoning could be available at relatively confined place. Again, the collection problems and the negative social perception do not allow much room for the promotion of such resource.

#### **Residential waste**

Housing units in developing countries like Sudan are assumed to be highly populated (average family population 5-6). Thus the waste generated (both fluid and solid) could be a considerable biomass resource. However, in such countries, these settlements are so dispersed that the overall population density is extremely low. Moreover, due to poor infrastructure, there is very limited capacity or absence of central waste management systems. It can be concluded that the utilization of such resource is questionable.

#### **Industrial waste**

This category includes: by- products and waste resulting from processing biomass products in relatively macro units. Thus include food-based activities such as baggase (waste of sugar production from sugar cane) which was generally used for internal energy supply in the sugar production plants. Surplus was always recorded; it was estimated in 1999 by 327 000 ton/ year [10]. Nevertheless, the increasing need within the factories and the high transport cost does not sustain its full utilization. On the other hand, non-food- based activities in Sudan such as macro cotton ginning or wood mills are scarce or generally non- efficient (not producing *clean waste*).

### **1.2.3.2 Forests**

#### **Potential and limitations**

Thermal utilization of wood in Sudan takes place mainly in its raw state. Sudanese wood has average c.v. of ~18 MJ/kg while charcoal (carbonized wood in kilns of 30 % efficiency) has c.v. ~30 MJ/kg [1]. The whole system of using wood in the different sectors is associated with a low energetic and exergetic efficiency due to non-optimum oven design. e.g open fire.

## *Energy situation in Sudan: Status, Potentials and Prospects*

---

Parallel, wood constitutes the main primary forest product in Sudan, according to FAO [14] the main objective of forestry activities is to produce timber, which produced in about 50 % of the forestland in 2005. Thermal use of wood constitutes the main use for timber (19 million out of 22 million m<sup>3</sup> in 2005).

This situation justifies the attempts to upgrade wood energetic utilization techniques to fit for advance uses such as electricity generation. Nevertheless, the *environmental sustainability* perspective contradicts this assumption. According to the national report for climate change [13] in Sudan, forests are under stress. In the mid 1950's forests constituted ~36 % of the total area of Sudan (~90 million km<sup>2</sup>), in the 1980's forest was 20 % and declining to 15 % of Sudan area in 1998. This drastic reduction is due to wide use of wood for energetic purpose. The consumption is about 16 million m<sup>3</sup> and the allowable cut is 11 million m<sup>3</sup>. In Kordufan region in western Sudan, forestland decreased between 1983 and 2000 from about ~ 12000 thousand hectare to ~ 2500 thousand hectare [5]. The loss of forest areas is highly connected to erosion, land degradation and desertification which characterize the ecological era in Sudan [12],[14] [15]. Furthermore, increased wood consumption limits the economic benefits of *non-timber* forest products. FAO report [14] estimated the value of wood removed in 2005 by \$ 462 million and non-wood as \$ 692 million. Moreover, *Acacia senegal* and *Acacia seyal* trees are prevailing in large areas of western Sudan [16], [17], [18], [19]. These are species, which are commonly used as fuel [16], [19]. On the other hand these trees also produce Gum Arabic (*Gummi arabicum*), a product that has high export revenue e.g. in 1999, Gum-arabic constituted 12 % of the GDP in Sudan. More wood consumption can limit the expansion of such revenue and undermine the livelihood of millions of Sudanese who depend on its production for their cash income.

At the administrative and legal levels, other obstacles for the development of energetic wood utilization could be observed. Unauthorized forest removal or trees cutting is illegal action; however, the levels of revenue it generates in comparison to other activities and the weak control make tree cutting a high quick profit activity for people of different income levels. This doesn't allow room for sustainable forest management.

On the other hand it could be realized that forests are characterized by low stocking density, extra, due to inappropriate management specifically re-plantation, the production rate does not match with the consumption rate so a deficit of 5 million m<sup>3</sup> was recorded. This gap is increasing as the total wood volume in 2005 is ~ 940 million m<sup>3</sup> while in 1998 is ~1,700,000 m<sup>3</sup> [14], [20].

Increased consumption could intensify this problem and render the authorities to be less able to address issues of sustainable forestry thus leading to further environmental degradation.

### **Future plans**

According to the strategic plan of Forest National Corporation (FNC), the plans concentrate on:

- Increasing forest reserves from less than 5 % to 20 % of Sudan area.
- Promoting non-timber forest products and increase its share in forest economics.
- Encouraging forest preservation practices through supporting alternative non-wood fuels e.g. FNC initiated *Sudagas* project for promoting Liquefied Petroleum Gas (LPG) stoves.

In view of the above analysis, it would be inappropriate to promote the use of wood as a sustainable energy source for electricity production in Sudan.

### **1.2.3.3 Agricultural residues**

Agricultural residues include all raw residues resulting from agricultural products (both food and cash crops). Agricultural residues could be found in different forms e.g. stems, stalks, shells or leaves, weeds generally with c.v. of 12-16 MJ/kg.

Due to the variation of climatic zones and agricultural systems in Sudan, there is rich diversity in crops produced both at the subsistence agricultural level and the industrial cultivation (mono cultivation) level in large schemes (Fig. 1.10). For details about crops cultivated see appendix 1-B.

#### **Agricultural residues materialistic availability**

The quantity of agricultural residues produced in a specific area varies greatly from year to year depending on the nature of treatment applied, climatic conditions and so the net yield/area. Thus the yield could be related to factors such as soil fertility, rainfall levels, pest control and irrigation practices in addition to political and economical dynamics.

In Sudan due to many reasons, the productivity is highly fluctuating and generally poor thus care should be taken when estimating the real amount of biomass. The variations between the cultivated and the harvested area and the relative low productivity/ha could be observed in table 1.4. Thus but this data reflects also the incomplete utilization of the available land, poor cultivation conditions.



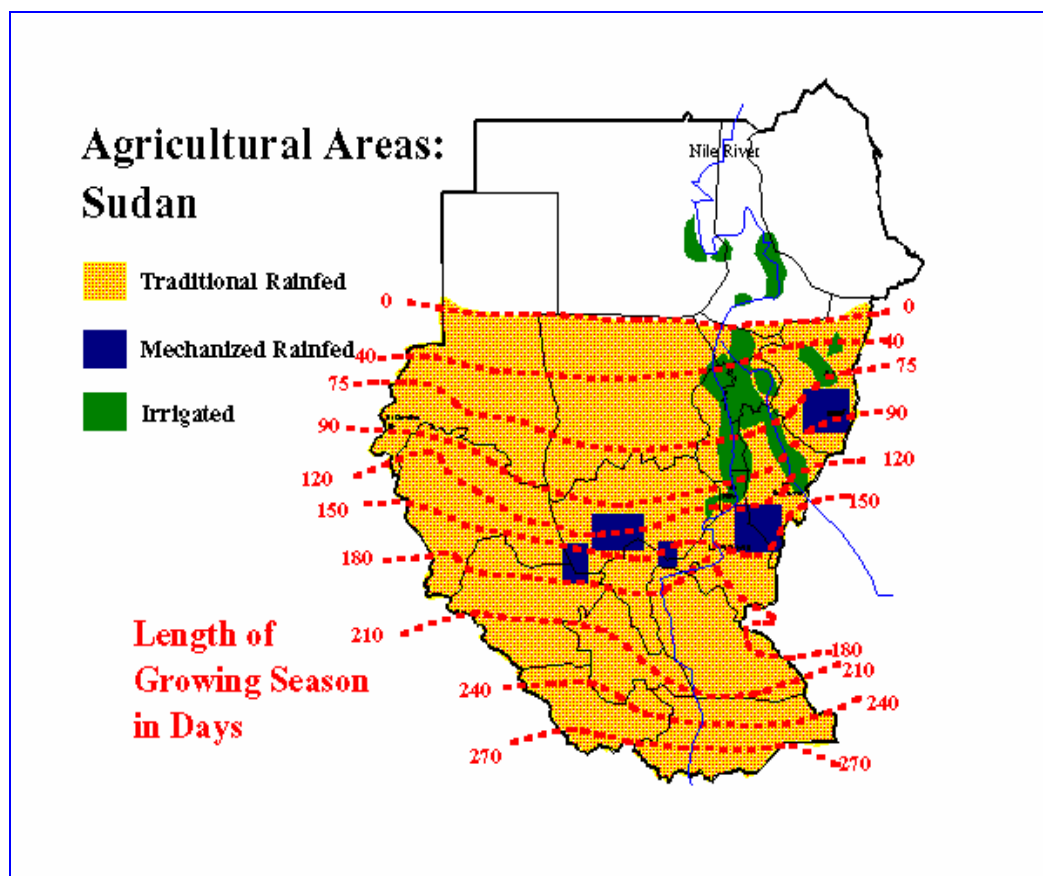

**Fig. 1.10: Agricultural sectors in Sudan**  
Source: [13]

**Table 1.4: Average annual crops production in Sudan (2002-2005)**

Product*	Area cultivated (thousand hectar)	Area harvested (thousand hectar)	Production Thousand ton	Productivity (kg/hectar)
Sorghum	7538	5628	3398	603
Wheat	162	154	364	2364
Millet	3730	2223	543	244
Sesame	1645	1294	266	205
Ground nut	1397	1018	620	609
Cotton	198	177	267	1509
Roselle	357	263	174	661

Average values based on rounded figures for years 2002/2003, 2003/2004, 2004/2005

\*\* Roselle: average values based on rounded figures for years 2001/2002, 2002/2003, 2004/2005

Source: [21]

**Agricultural residues availability factor**

The agricultural residues are defined as the non- useful parts of crops. Usefulness is mainly interpreted as synonym for edible particularly in the absence of major crop-based industries. This perception depends on the local nutrition habits and social factors in addition to the yield quantity. Part of the agricultural residues in Sudan are used for non-food purposes e.g. building, grazing or making traditional handworks [1], [5] [10], [22].

Availability factor (**F**) is the percent of residues not used for other traditional uses i.e. restudies amount “free” for energy production. It varies from pant to plant depending on uses

$$F=L_b/T_b$$

Where:

F= Availability factor.

L<sub>b</sub>= Left over agricultural residues in field (ton).

R<sub>p</sub> = Total residues produced (ton).

Different studies had tackled this issue and used different ways to calculate residues amount and availability. In this study the calculation of residues in ton/ton approach could had resulted in comparative accuracy [1], [5] due to the relatively low productivity of the cultivated land. Also the resduie types are not clearly specified in relatin to the plant e.g (percent of shells, stalks, leaves). However, the only available data for the recorded products is ton/feddan (hectar) so this criterion was used. Due to urbanization process, the author estimated that the availability factor for products (with exception of cotton) had increased by 25-35 %. Table 1.5 displays the availability factor (F), type and size of residues for some products in Sudan.

The Materialistic available residues generated in Sudan (R<sub>m</sub>) for some crops in 2005 are tabulated in table 1.6. They were estimated by the equation:

$$R_m=F*R_A*A$$

Where:

R<sub>m</sub> = Materialistic available residues (ton)

R<sub>A</sub> =Residues produced /Area (ton /ha, feddan)

F=Availability factor

A<sub>h</sub>= Area harvested (feddan, ha)

**Table 1.5: Availability of agricultural residues in Sudan**

Product	Type of residue	Size(l*d) (mm)	Residue amount (ton/feddan)(hectar)	Availability factor
Sorghum	Stalks	1500*20	2.7 (6.4)	0.4
Wheat	Stalks	750*10	2.0 (4.8)	0.4
Millet	Stalks	2000*20	1.0 (2.4)	0.3
Sesame	Stalks	750*10	1.2 (2.8)	0.8
Ground nut	Shell	30-40*10	1.2 (2.8)	0.8
Cotton	Stalks	500*15	4.0 (9.5)	0.8
Roselle*	Stalks	500*15	1.2 (2.8)	0.8

**Source: modified based on [10]**

\* average values based on field information.

**Table 1.6: Average annual residue amount in Sudan (2002-2005)**

Crop	Residue amount (000 ton)
Sorghum	14408
Wheat	296
Millet	1601
Sesame	2899
Ground nut	2280
Cotton	1345
Roselle	589
Total	23418 (~350 000 TJ)*

\* approximated based on 15MJ/kg

As seen in from the above discussion several types of agricultural residues had high materialistic availability, which encourage its use as energy source. Furthermore, although different projects were initiated to utilize agricultural residues like briquette but it is still a relatively unexploited energy source [23]. Thus the current interest for its utilization for electricity generation is highly justifiable. Under the discussed prevailing conditions,(water scarcity, interest for decentralized systems) gasification could be seen as viable option. However, the other aspects of biomass suitability had to be considered and efforts should be focused on the optimum utilization of this source depending on its comparative merits.

### **1.3 National and International Concerns**

Energy is not a purely technical issue, thus non-technical aspects especially environmental and political considerations play an important role in energy development plans. In the following

section, the main national and international environmental issues related to energy in Sudan will be highlighted.

### **1.3.1 National concerns**

#### **Desertification**

The desert encroachment southwards and the loss of soil fertility was a phenomenon that had its peak remarkably during the seventies and eighties. It played a major part in the famine catastrophe in western Sudan in 1985. Different theories addressed this phenomenon, providing a variety of models with various root causes. However, the extensive cutting of forest for the satisfaction of energy needs was always mentioned [15],[16],[17].

#### **Pollution resulting from petroleum exploration**

The trend for quick and low cost extraction systems could have led to environmental pollution through pumping the process waste in the open environment e.g. water bodies without any precautions. Furthermore, exploration often takes place in areas where large population groups are dependant on mobile animal husbandry, the exploration means change in mobility patterns. The oil related activities affects the environment further and restricts the access to water and fertile land. In spite that specific information was not available to author but as general to decrease the adverse environmental effects of oil exploration activities then expansion in this sector needs to be carefully planned. In this context, limiting oil-based electricity production systems should be considered.

#### **Pollution resulting from power plant**

Major Power plants discharge their waste without treatment to the nearby areas despite of some legal regulation. Many of these utilities lie at the banks of the river Nile and its tributaries. Environment groups e.g. Sudanese environment conservation society claims severe micro-environment pollution and increasing health hazards is taking place. Air pollution is also to be considered [24].

#### **Hydropower side-effects**

Hydropower alters the geography, topography and demography of the surrounding lands. Studies on Roseries dam (South-East Sudan) showed that some serious effects on the surrounding environment especially extinction of some types of fauna and flora had happened [25]. The on going project for Merowi dam (North Sudan) caused population migration, loss of land and livelihoods problems. This requires carefully planned mitigation measures, however inconvenience will be always claimed by some groups as mentioned in [26].

### **1.3.2 International concerns**

#### **Global warming**

Sudan had joined the Kyoto protocol that sets global obligations to reduce CO<sub>2</sub> emission despite its limited CO<sub>2</sub> emission levels. Encouragement of renewable energy techniques identified as one of the mitigation measures. The combustion products of the energy industry were identified as main contributors to emission from fossil fuel use ~ 23 % as seen in table 1.7. On the other hand, trees (sink) removal contributed by 15 Gg which is equivalent to ~75 % of total emission [13]. This highlights the deforestation problem in Sudan and shows the difficulty of using wood as sources of energy in general and for electricity production in particular.

**Table 1.7: CO<sub>2</sub> emission in Sudan (1995)**

<b>Sector</b>	<b>Official Energy sector</b>	<b>Land use</b>	<b>Others</b>	<b>Total</b>
Net CO <sub>2</sub> emission (Gg)	4.3	15.6	0.17	20.1
Energy industry (Gg)	1.0	--	-13.0(sink loss)	

**Source: [13]**

\* Total emission

#### **Population needs**

The international community is placing more efforts towards improving the situation for disadvantaged people all over the world. Some of the agreed measures include the Millennium Development Goals, which sets various criteria to be reached by 2015. This include a.o. the levels of electricity production and consumption in a state. Failure to achieve these goals and cooperate with these efforts will have adverse economic and political effects for any state.

### **1.4 Conclusions**

- Sudan energy consumption as general is minor in comparison to the international level. Electricity, which is considered as a very practical type of energy, comprises only 2 % of the total energy consumption in Sudan.
- Only 13 % of the populations get electricity and almost 50 % of them depend on decentralized thermal power plants that are very sensitive to fuel availability.
- Households is the main consuming sector within the sectoral distribution of electricity.
- Sudan in general and the domestic sectors specially suffer from an electricity gap. This gap is increasing with time due to population growth accompanied with rising living standards.
- Despite the growth in Sudan oil industry but the prevailing economic and political conditions limits its utilization internally, export is the main objective for this sector. Thus petroleum surplus does not automatically guarantee better electricity services.
- Implementing renewable energy techniques is in the interest of different institutions However; various technical and economic factors limit its use especially for commercial supply.

## ***Energy situation in Sudan: Status, Potentials and Prospects***

---

- The state of desertification that Sudan faces and the increasing benefits and interests in non-timber products (including global contribution to greenhouse mitigation measures) makes it difficult to use the existing potential of wood. The introduction of so called “energy forests” is not being currently considered.
- Agricultural residues have a great potential (350 000 TJ annually) and their use is traditionally confined to inefficient thermal use that is decreasing with time. This high potential and availability makes it an interesting option to be studied as a primary energy source for the satisfaction of the electricity need of the households sectors in Sudan.

### **Gaps**

- Detailed information about future plans for NEC and Petroleum utilization.
- Actualizing the availability factor for agricultural residues.

### **Further work**

In the following section a detailed study in specific town of the arid western regions of Sudan will be carried. The main objectives are to gain information about the actual energy and electricity production. Further consumption pattern together with influencing factors in addition to biomass potentiality will discussed.

## **2 Experiences and Results from Field Studies**

The objectives of this chapter are:

- To describe electricity situation in a typical town with arid condition in western Sudan.
- To identify and quantify the factors affecting electricity consumption in the household sector.
- To study the biomass availability issues with special emphasis on Groundnut shells.

Thus the contents of this chapter will cover the following points:

- Study area.
- Methodology of the study.
- Results, analysis and discussion.
- Finding and conclusions.

The conclusions aim to quantify the electricity demand in the study area, identify the factors affecting it as well as to assess the agricultural residues availability.

### **2.1 Introduction**

As seen from Ch.1 agricultural residues could be considered as a possible source for electricity production in arid area of Sudan. In order to assure sustainability for such projects, then in addition to technical tests (Ch.4 and 5) there is a high need to assess the actual demand for electricity and factors influencing it in addition to biomass availability in a typical location. Due to the unavailability or scarcity of such information in national, international documents or other information sources then field work was conducted to collect the required data.

### **2.2 Study area**

#### **2.2.1 Selection requirement**

As seen from (Ch. 1) the urban centres in western Sudan are the main focus for erecting BGPP, within this frame of reference, the selection criteria for the study area include:

- Stable population more than 20 000.
- Location within agricultural areas zone.
- Available electric transmission net.

### **2.2.2 General description**

El Nuhood<sup>8</sup> town was identified as possible target. Geographically it lies in western Kordufan region with an area of ~56 km<sup>2</sup>. It is located ~ 600 Km southwest of Khartoum (the capital) at longitude 28°, 50'E and latitude 12°,75'N. The population was estimated in 2002 by ~ 66.000 person (32.000 males and 34.000 females) and ~ 14 000 household [1]. A comparative description to the approximated study area location with respect to Sudan and greater Kordufan region is seen in (Fig. 2.1).

El Nuhood is found in the western part of the greater Kordufan region i.e. mean it lies in the Savannah climate, with average annual rainfall of 600 mm. The soil is fragile sandy, often inter crossed by clay compacted soil (Gardood). When compared to northern parts of the region (above latitude 13°N) then the soil of this area could be considered as a relatively fertile soil. The special nature of the soil is not encouraging huge agricultural expansion or process intensification as both types of soil (Sandy and Gardood) do not allow the use of agricultural machinery or deep plough. Therefore subsistence small scale manual agricultural system is prevailing. Mobile animal husbandry especially sheep in open ranges is a main activity in the region.

The economic activities in the town are strongly related to the agricultural nature of the surroundings and the location of the town as a main administrative centre in the region. Therefore the main employment chances are available within the general trading sector specifically crops and animal trading or in oil-mills<sup>9</sup> in addition to the governmental and services sector [2].

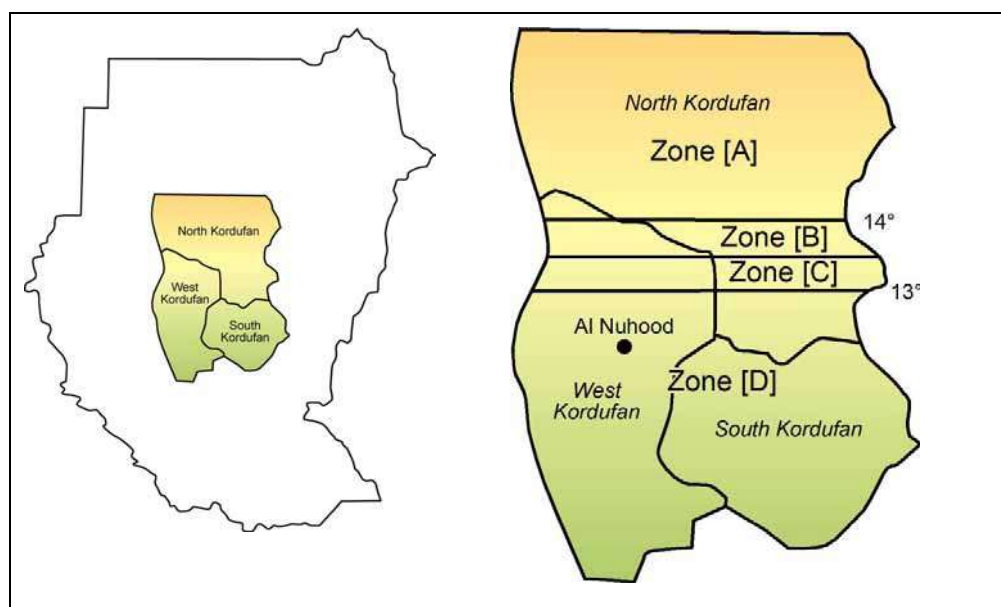

**Fig. 2.1: Study area.-location and administrative divisions (2005)**

<sup>8</sup> Other names are En Nuhood, Al Nuhood (النهود)

<sup>9</sup> Ground nuts and Sesame oil are the main food oil types used in Sudan



### **2.3 Methodology**

Different literature tackled field studies methodologies and approaches in relation to optimum surveys design and statistical analysis [3], [4], [5], [6], [7], [8], [9]. They discuss among others the effect of population nature and objectives of the survey on sample selection, analysis scheme and methodology adopted. Accordingly, as the undertaken research could be characterized by exploratory nature then the following methodologies were adapted.

#### **2.3.1 Primary data collection**

Primary data were collected through interviews and observations with selected authorities. The main objectives were to get official information about the town, energy/electricity situation and biomass (including forest) availability.

The interviewees were:

- City administration & local administrative committee.
- Officers working in electricity supply and distribution offices.
- Private electricity suppliers & shops selling local electricity systems (Gen-sets, spare parts. etc)
- Agricultural & forest officers.
- Crop market authority.
- Oil mill operators.

#### **Instructed questionnaire**

Instructed closed questionnaire was carried to collect basic information about the energy/electricity consumption in the study area. The main objectives of the questionnaire were:

- To quantify the energy/electricity consumption in terms of kWh.
- To monetize the respective costs.
- To quantify the factors affecting the electricity consumption.

Hence the questionnaire was designed according to the following considerations

#### **Target group:**

The target group was the household sector in El-Nuhood town, this sector was selected because it constitutes the main consumers sector in Sudan and it is assumed that this fact is also valid in the study area. Within the socio-economic situation in Sudan then the household sector is also considered as the most affected/influencing grouping within the consumers' profile. The establishing of commercial relationship (supply and sale of electricity) between the power plant and this group will be reflected directly on the economics of the suggested power plant.

#### **Sampling techniques:**

Target population was stratified into 2 groups (strata). The first group (group 1) was characterized by the official connection to electricity; this group is geographically located within

## ***Experience and Results from Field Studies***

---

the old city centre. The other group (group 2) lives in a circle around the old group, but they do not enjoy such privilege and depend on local private systems to get limited electricity supply.

According to the above literature then 25 persons are enough to explain social phenomena. In this study 60 respondents (30 each in each stratum) were randomly selected.

### **Layout**

The lay out of the questionnaire incorporate the following characteristics:

- i) Closed structure questionnaire (for both groups) which was built-up of three sections:
  - Demographic structure to get background information (based on actual family members).<sup>10</sup>
  - Ownership and income so as to evaluate the economical status of the interviewee.
  - Energy and electricity consumption to get detailed information about devices used consumption period and eventually electricity consumption.
- ii) The technical suitability indicators which included monthly hours of black out, Number of non working devices plus accidents/death cases in addition to information regarding the satisfaction degree by the current electricity service (for group 1).
- iii) Overall information concerned with judgment and perceptions towards the current electricity situation (suitability, availability and sustainability). Additionally possible suggestions for improving the electricity services were collected through key informants that were randomly selected during questionnaire filling.

### **Analysis**

The analysis steps undertaken could be summarized in the following points:

- Response was obtained through Scale, Ordinal or Nominal answers.<sup>11</sup>
- Frequency, mode and average calculations were considered the main statistical parameters for displaying the demographic information and the electric consumption.
- Correlation and regression were conducted to identify and quantify the factors affecting the electric consumption.

The main analysis tool was SPSS 11.5, a copy of the questionnaire and the list of key informants questions could be checked in Appendix 2-A.

---

<sup>10</sup> Family members who are now normally living in this house for more than 10 month /year,

<sup>11</sup> Some assumptions and rounding were made in relation to monthly income/monthly income (average), usage duration and specific consumption of different equipment.

### **2.4 Results**

#### **2.4.1 Actual electricity situation**

##### **2.4.1.1 Official system**

NEC had newly established a thermal power plant with a rated capacity of 2 MW (2 units each 1 MW). The unit price could be estimated by 1.5million US dollar.<sup>12</sup> The supply is provided generally between 8:00 am-11:00 pm and till 1:00 am in special events. During the day only one unit is working, the other unit catch-on at night (6-7 pm). The distribution net covers limited part of the inner city. Electric current *nominal* parameters are: single phase mode, 220V and 50  $\mu$ Hz however, actual parameters (in houses) are expected not to coincide with the nominal values<sup>13</sup>. The electricity generation in 2005 was estimated by 4.3 GWh (net). Fuel consumed was 1235 ton/year (ranging from 79-148 ton/month)<sup>14</sup>. Fuel was delivered from Khartoum so the fuel transport builds up the main trouble through:

- i) Cost addition; transport cost was assumed to be SDD 1.8/gallon but it turned to be SDD 45/gallon. As a result real cost varies in 2005 between 16-45 SDD/kWh at average of 29 SDD/kWh.
- ii) Production fluctuation; fuel provision is not steady and it depends on the political and economical circumstances. So high intensity of black-out had occurred (time duration of 10 days black out was mentioned).

As general the electricity service is limited, the number of consumers in the distribution company records are 2600 of which only 300 are non residential (commercial, governmental). Billing get through flat rate system (~10 \$/month). Conventional metering system is rarely recorded; at January 2006 there were only 223 meter. The expansion is very limited, in spite the high demand but new connection in inner circle is not guaranteed. Simultaneously the new connection per household cost differs with average minimum of \$ 500. According to official authorities black-outs and fluctuating voltage are frequent and *normal*.

##### **2.4.1.2 Private system**

A series of private system for electricity generation at local level was found in the study area. The average system composed generator 7-10 kW. The most used brands are of chinese origin which are characterised with low price and availability of spare parts. The purchasing prices are ranging from \$ 950-1200, the operation cost is \$ 150-160 monthly and the maintenance cost was estimated with \$ 250-300/year.

The system works as follows:

---

<sup>12</sup> According to evaluation for market value of chinese systems

<sup>13</sup> Special connection is made for some strategic places e.g. drinking water station

<sup>14</sup> 1ton  $\approx$  260gallon@ $\sim$ 126000KJ/gallon

## *Experience and Results from Field Studies*

---

- The owner buys the generator and motor and then makes contract with 20- 30 households.
- The consumer buys the connection necessities e.g. electric wires, plugs etc.
- The owner has to provide electricity to the consumer from 6/7 -11 pm while the consumer must insure that only fixed number of white lamps (1-4) and one coloured T.V set are connected.
- The consumer pays a flat rate ranging \$ 8- 12 /month.
- The owner controls the load by connecting ampere meter and tracing it back to the consumer.
- The main problem encountered by consumers is the quality of supply. As the connection is in series then some get weaker supply than others.
- The whole system depends on the strong personal relationship between the partners.
- In spite the very critical technical safety measures but the system is quite legal, moreover annual governmental fees are collected from the owners.
- There is no official organization for the owners but they have a weekly non official meeting to discuss things together.

### **2.4.2 Questionnaire results**

#### **2.4.2.1 Energy/Electricity consumption in household**

##### **Demographic background**

The more frequent values (mode) and frequency percent for some selected parameters are tabulated in table 2.1. These figures agree with the national statistics (1993 census) average family member of 5 and the overall illiteracy rate in urban Sudan of 33 % and with the local statistics of 5 persons per family.

**Table 2.1: Demographic indicators of interviewees**

<b>Parameter</b>	<b>Mode</b>	<b>Frequency percent (%)</b>
Family size	6-10 person	50.8
No of units	1	89.8
No of rooms	6	20.3
No of youth	4-5 person	37.2
No. of students	2-3person	38.9
Father education	Illiterate-	27*
Mother education	Illiterate-	50

\* mode is basic with 38 % but illiteracy rate was indicated s to ease comparison to Sudan

## ***Experience and Results from Field Studies***

---

### **Economical status**

Table 2.2 shows the mode and frequency percent for the main economical indicators collected. This was done so as to get an over all evaluation about the economical status of the interviewee.

**Table 2.2: Economical indicator of the overall sample**

<b>Parameter</b>	<b>Mode</b>	<b>Frequency percent</b>
Type of House hold structure	Mud /brick(permanent)	50
Average monthly income	< SDD 50.000	42
Type of house ownership	Owned	79

### **Consumption details**

#### **No of devices**

The mode for main electric devices possessed by the house hold (excluding zero) together with the frequency percent of this mode is displayed in table 2.3.

#### **Daily electric consumption**

The daily electric consumption for every household (kWh/day) (table 2.4) was calculated using the following equation:

$$Q_d = D * U * S$$

$Q_d$  = daily electric consumption (kWh/day)

$D$  = quantity of each device in house hold

$U$  = daily usage duration for each device (hr/day)

$S$  = standard consumption of each device (kW) (assumed upon values provided by NEC)<sup>15</sup>

The primary analysis for peak and minimum division among family members was not possible due to highly in accurate responses and high percent of not applicable. However the field observations show generally that peak lies between 7-10 pm. Due to relatively low consumption great differences between day and night is not of great effect on the further analysis.

---

<sup>15</sup> Since most radios used dried battery, mobiles were assumed to be of negligible consumption so these two categories were not included in final electricity consumption.

The *other* category was divided into two subgroups; one subgroup contained iron and oven with assumed usage duration and other do not contain such devices.

**Table 2.3: Electric devices in the house hold**

Device	Mode	Frequency (whole sample)
White lamp	2	15.3
Red lamp	1,2,4,5,6	5.1 (each)
Neon big	4	3.4
Neon small	2	6.8
Fan	1	6.8
T.V.	1	57.6
Radio	1	57.6
Refrigerator	1	23.7
Mobile	1	42.4
Others	1	15.3

**2.4.2.2 Energy budget**

**Energy resources**

Fig 2.2 shows the percentage of population using each type of energy sources. Extra a record was generated for the main consumption activities in relation with these types (other than electricity). The results show that:

- Biomass (wood/charcoal) is used for cooking and/ironing, water heating.
- LPG is used for cooking and lighting.
- Kerosene is used for lighting.
- Others (mainly batteries) is used for small devices e.g. radios and torches. Other sources like solar or car batteries were rarely recorded (observed).

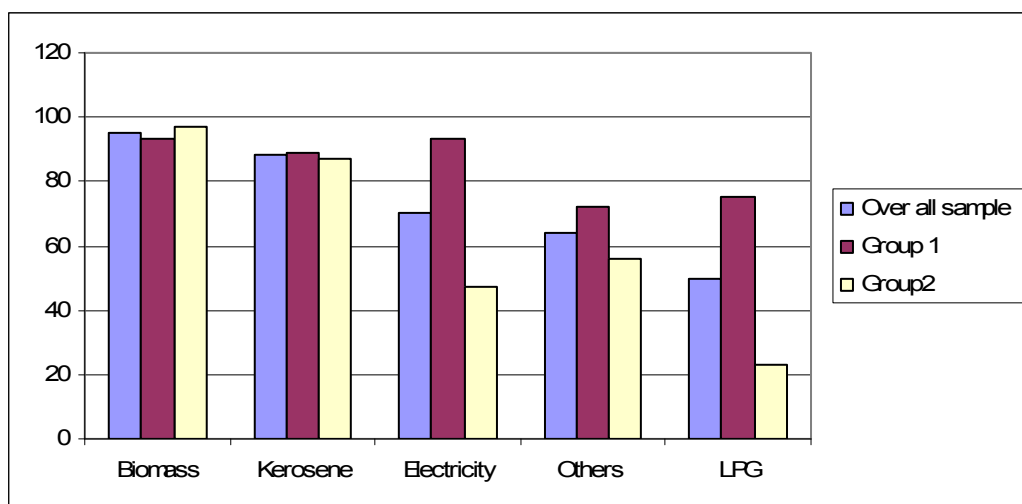
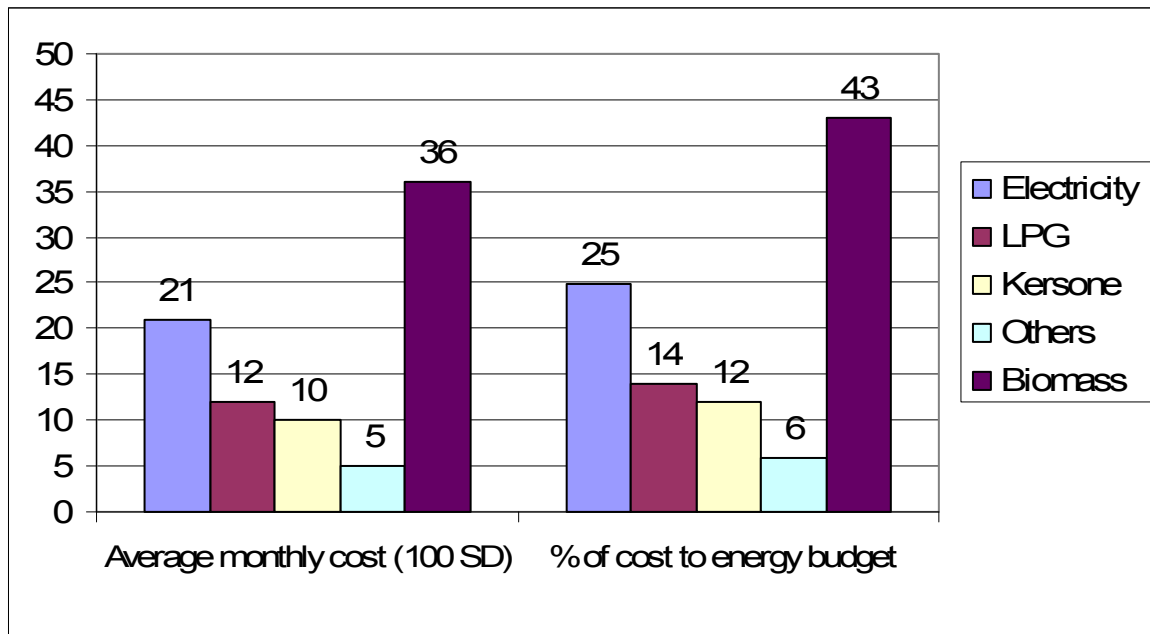

**Fig. 2.2: Population percent using each energy source**

## Experience and Results from Field Studies

### Energy/electricity expenditure

To evaluate the monetary value of the energy/electricity consumption, the average detailed monthly expenditure for each energy source was recorded. The percentage of each energy cost to the total energy expenditure and the cost percent to the average income were calculated (Fig. 2.3). As general it was found that the total expenditure on energy constitutes an average of 13 % of the house hold income.



**Fig. 2.3: Financial aspects of different energy sources**

\* rounded figures

To monetize the real electricity consumption i.e. calculating actual kWh price ( $kWh_p$ ) paid by the household the following equation was used:

$$kWh_p = C_d / Q_d$$

where

$kWh_p$  = actual paid kWh price (SDD/kWh)

$C_d$  = daily electricity cost (SDD/day)

$Q_d$  = daily electric consumption(kWh/day)

Summary of results could be seen in table 2.4

**Table 2.4: Electricity consumption and kWh price**

Parameter (average value)	Group 1	Group 2
Average actual kWh price (SDD/kWh)	38	73
Average daily electric consumption (kWh/day)	3.7	0.33

## *Experience and Results from Field Studies*

---

### **2.4.2.3 Factors governing electricity consumption**

#### **Correlation**

Correlation analysis (table 2.5) shows that monthly income constitutes the major factor affecting the total consumption of electricity for the overall sample as well as for group 1 and group 2 individually with ( $r= 0.7$ ). (Its significance was (0.000)).

In the overall group it was followed by type of house structure and number of rooms. However, other factors like education of household and housewife indicate significant correlation, ( $r = 0.45$  and  $0.47$  respectively. (Their significance were 0.001 and 0.000 respectively). On the other hand factors like family size, number of students are not significant when correlated with the consumption. Considering each group for the major (significant) factors affecting the total consumption of electricity other than income, it was found that the number of rooms is the major factor for group 1 ( $r =0.53$ ). (Its significance was 0.003). Examining group 2 it was found to be the number of rooms and cost of LPG with  $r =0.59$  and  $0.43$ . (Their significance were 0.001, 0.018 respectively). The other factors show weak correlation or non significant.

#### **Regression**

Total daily electricity consumption was regressed against different factors that indicate significant correlation. Linear multiple stepwise regressions were followed to stimulate the most statistically accepted equations for electricity consumption (C), based on income (I), numbers of room (NR), cost of LPG (L) and number of students (NS). The following equations were written :

#### **Overall sample**

$$C = -1.428 + 0.426 I + 0.306 L -0.208 NS+ 0.262 NR$$

Sig.-level (0.019) (0.000) (0.006) (0.014) (0.018)

T-value (-2.412) (4.362) (2.877) (-2.549) (2.437)

**Adjusted  $R^2 = 64 \%$**

Adjusted  $R^2$  shows that the coefficients of multiple regression is 64 which illustrates that about 64 % of the variation in total consumption was explained by consumers' income (I), number of rooms (NR), cost LPG (L) and number of students (NS). All the coefficients were significantly different from zero. The equation showed that a one unit increase in consumers' income (I), cost of LPG (L) and number of rooms (NR) lead to increase the total consumption by 0.426, 0.306 and 0.262 respectively, while the increase in number of students by one unit leads to decrease the total consumption by 0.208 when the other factors are constant.

#### **Group 1**

$$C = -0.493 + 0.699 I$$

Sig.-level (0.599) (0.000)

T-value (-0.532) (5.085)

**Adjusted  $R^2 = 47 \%$**



## ***Experience and Results from Field Studies***

Adjusted  $R^2$  shows that the coefficients of multiple regression is 47 which illustrates that 47 % of the variation in total consumption was explained by the consumer income (I). All the coefficients were significantly different from zero. The equation showed that a one unit increase in costumer's income (I) lead to increase the total consumption by 0.699 when the other factors are constant.

### **Group2**

$$C = -0.163 + 0.477 I + 0.502 L$$

Sig.-level (0.113) (0.000) (0.000)

T-value (-1.636) (4.022) (4.226)

**Adjusted  $R^2 = 68 \%$**

Adjusted  $R^2$  shows that the coefficients of multiple regression is 68 which illustrates that 68 % of the variation in total consumption was explained by cosumers income (I), cost LPG (L). All the coefficients were significantly different from zero. The equation showed that a one unit increase in costumer's income (I) and LPG cost (L) lead to increase the total consumption by 0.477, and 0.502 respectively.

**Table 2.5: Correlation coefficient (r); total energy consumption and different parameters**

<b>Parameter</b>	<b>Overall group</b>	<b>Group 1</b>	<b>Group 2</b>
Ed. level of hhh	0.45**	0.213	0.162
Ed. level of main hhw	0.47**	0.320	0.082
Monthly income of hh	0.701**	0.702**	0.707**
Kind of house ownership (ownership)	0.098	0.235	0.065
Type of house structure (brick)	0.519**	0.296	0.347
Source of lighting other than electricity	-0.010	0.266	0.074
No. of rooms	0.629**	0.527**	0.593**
No. of students	0.016	-0.158	0.169
LPG	0.321*	0.105	0.428*
Average family size	0.155	-0.230	0.131

\*\* Correlation at 0.01(2-tailed), \* Correlation at 0.05(2-tailed).

Where

- Ed level of hhh = educational level of household head
- Ed level of hhw = educational level of household wife
- Monthly income of hh = monthly income of household (total members of family)

## *Experience and Results from Field Studies*

---

### **2.4.2.4 Perception and Judgment**

Social and Psychological factors such as perception plays an important role in the adoption of new processes and technologies [10], [11], [12]. Since the limitations of the study don't allow deep investigation of these issues then only an overall evaluation was required which can help in adopting a new plant with properly higher electricity price. Hence a perception overview was accordingly built (Fig. 2.4) which shows the possible *positiv and negativ* preception(s) of electricity. Further an application for this model is conducted, the input data were the questionnaire results and the key informants response, in additional to points of views and opinions collected from the official sector. As output the following indicators were noticed; Electricity is appreciated as a very useful type of energy but perceived as luxury as the costs of connection and monthly costs are high and electricity availability is not continuously insured. Bureaucratic procedures especially in relation to new connection are seen to be the main hurdle. Technical quality of the electricity supply, especially voltage fluctuation and frequent non programmed blackouts, limits its suitability for common needs particularly small commercial and industrial sector because they are *poor negligible group*. Concerning electricity shortage issues, possibility of erecting a private power plant and efficiency of communal management of electricity services then the study reveals that electricity services were perceived as complicated and high-tech issue. Remarkable point, that in spite of the average monthly black out of 40 hours but a high ratio of satisfaction is recorded 84 % (**Group 1**). Concerning rationality of use then 42 % of group 1 recognizes themselves as rational users although some recorded indicators opposing this claim e.g. relative absence of switches.

It was concluded from the key informants that the suggested power plant is acceptable and seen as realistic if there is enough biomass. The possible operator is seen to be international organization or big private sector as this business is seen to be complicated. The current experience of local private generators was not seen as first step to such system. The (*negative*) Perception of the electricity price and rationality of use should be considered in planning for erecting such plant. The perceptions for the main indicators of the current electricity situation were presented in (Fig. 2.5) which aims to compare the prevailing perceptions to the actual situation.

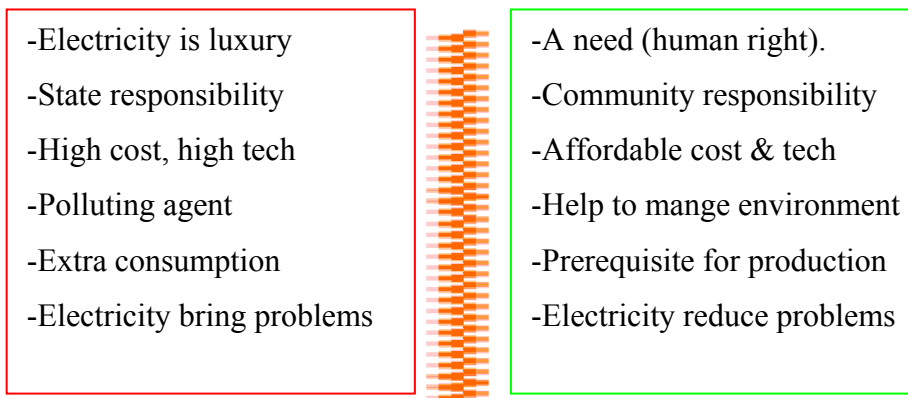

**Fig. 2.4: Perception over view for electricity in the study area**

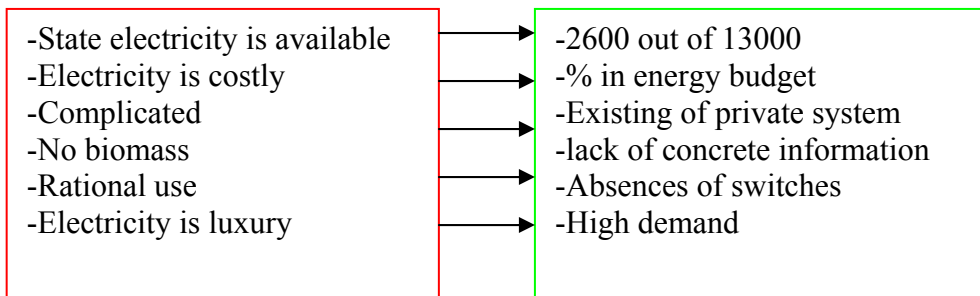

**Fig. 2.5: Comparison between perceived evaluation and real situation in the study area**

### **2.4.3 Biomass availability**

The actual availability of biomass resources in the study area was investigated using the methodology described in [13] accordingly the main features were:

- Mobile animal husbandry.
- Small fragmented agricultural system.
- Scarcity of water.
- Absences of food industry except for oil mill.

In the following section detail information will be presented about forest and agricultural residues.

#### **2.4.3.1 Forests**

In the 1998 the forest statistics [14] showed that greater Kordufan possesses the second largest wood volume in northern Sudan (~ 44 million/166 million m<sup>3</sup>). Further, although wood and charcoal are considered as the most common energy sources in the study area (see questionnaire results) but according to forest statistics the total consumption of fuel wood constitute only 4.4 % of total consumption in Sudan [15]. Thus an increase in direction of wood utilization was seen to be possible. However according to local forests authority, in a circle of 100 km radius forests are sparse and only minute scattered woodlands is found, field observation proved this claim. Consequently up to 2004 the forest area that is gazetted (under control of FNC) in western Kordufan constitute only 0.07 % of the total area gazetted in Sudan [16]. Having in mind that El Nuhood is located in the Hashab belt which was suffered by intensive reduction due to man made and natural reasons. Different efforts have been directed to re-establish it because of its economics and environmental benefits [2], [17]. Wood sustainable availability under such conditions is then very questionable.

#### **2.4.3.2 Agricultural residues**

El-Nuhood is considered to be an important crops market in the geographical region, *western Kordufan*, where by crops from area 30-50 km radius are marketed in it. The traded crops are mainly Millet, Sorghum, Groundnuts, Sesame and Roselle. The crops are manually harvested, collected in sack with different weights then transferred by lorries with capacity of 150-200 sack with average cost \$ 1-1.5/sack. The production data for different crops in western Kordufan region is shown in table 2.6.

#### **Agricultural residue availability**

The same procedure that was used in (section 1.2) will be used here to estimate the residue amount and the results are shown in table 2.7. Based on field observation for: production site, transportation means, storage conditions and fuel properties (Ch.3 and 4) special emphasis was given to GN.S. As stated in (Ch.1) the residue estimation based on harvest area was questionable (low productivity per area and residue type) then residues quantity was estimated as follows.

## *Experience and Results from Field Studies*

### **Groundnuts shells availability**

Greater Kordufan region produces 35-40 % of the total Groundnuts production in Sudan; El Nuhood town is considered as one of the important centres for its trade and processing [19]. Groundnuts is either processed in oil industry or traded as export commodity; both cases require the detaching of the outer shell. The shelling process in which the shells are completely separated from the seed takes place in the so called threshers units which are concentrated (a.o.) in El Nuhood town. The main current use of the shells produced is as fuel in oil mills but this utilize only (20-25 %) of the available residues. Other uses include insulating material for local coolers or as secondary fuel in bakeries and brick kilns.<sup>16</sup>

**Table 2.6: Average annual agricultural production of western Kordufan region (2002-2005)**

<b>Product</b>	<b>Area cultivated 1000 fed (hectar)</b>	<b>Area harvested 1000 fed( hectar)</b>	<b>Production (1000 ton)</b>
Ground nuts	930 (390)	665 (280)	56
Sesame	156 (66)	123 (52)	9
Millet	1708 (718)	1002 (421)	80
Sorghum	725 (305)	507 (213)	80
Roselle**	505 (212)	331(139)	30

**Source: [18]**

\* Average values based on rounded figures for years 2002/2003, 2003/2004, 2004/2005

\*\* Roselle: average values based on rounded figures for years 2001/2002, 2002/2003, 2004/2005

**Table 2.7: Average annual residues quantity in western Kordufan region (2002-2005)**

<b>Product</b>	<b>Residue amount (1000 ton /year)*</b>
Ground nuts	627
Sesame	116
Millet	303
Sorghum	545
Roselle	311
Total	1902 (~2.9*10 <sup>10</sup> MJ)

\*Rounded figures based on equation at section 1.2.3.3  
Total energy based on 15 MJ/kg

<sup>16</sup> Previously a factory for shells briquettes as charcoal alternative was established in 1985 the product was accepted.

## ***Experience and Results from Field Studies***

---

Surplus of shells was recorded, the health safety office forbid storing of shells in the threshers premises then thresher had to pay about 10 SDD/sack as disposal cost (Fig. 2.6).

To calculate the shells availability, different options were considered, in all cases it was assumed that shells constitute 30-35 % by mass from the total raw seeds mass and that 75-80 % of the shell is available as surplus [20].<sup>17</sup>

- 1 Agricultural production; as El Nuhood town is considered as main commercial point for crops trading, it could be assumed that 75 % of the groundnuts produced in western Kordufan region get into it (46,000 ton at 2004). Then the estimated shell amount is approximately 7.7 T ton.
- 2 Crop market statistics [21]; the quantity of Groundnuts sold inside the crop market in 2005 was estimated by 18 T ton allowing 50 % more for off market sell we end up with 27 T ton of nuts and ~7.2 T ton of shells.
- 3 Threshers activities; the shells production in the local threshers was estimated by 300-400 sack daily (40-45kg/sack) then assuming 150 working day/season, field result had recorded 6 threshers of such capacity. Allowing 25 % for losses and other uses, we get around ~8 T ton.

As a result a value of 8000 ton/season was considered for further calculations.



**Fig. 2.6: Groundnuts availability and transport**

**Source: Field results 2006**

## **2.5 Analysis and discussion**

The results showed that the electricity supply in the study area covers less than 20 % of the town (Household sector). The industrial sectors needs are completely not satisfied. The daily town average supply is ~12000 kWh/day with an average of 275 kWh/year/person (based on consumer number and family population) compared to household consumption in Germany of 1100 and in

---

<sup>17</sup> A study estimated that 50 % of the shells (based on production ) are available [18]. However it could be claimed that utilization of other fuel systems in small industries can lower this to 20-25 %.

## ***Experience and Results from Field Studies***

---

Khartoum of 720 kWh/year/person (based on the basic 300 kWh per family). Thus further growth of the electricity service is highly justifiable. From the economic point of view the *operation cost* calculated by the supplying company is SDD29/kWh (total fuel cost/total kWh produced). This value is higher than the current national cost of SDD 22.6 (section 1.2). This could be mainly referred to high fuel transportations cost. The extra transportation cost which amounts to 10 % of the fuel price in addition to non smooth fuel delivery system justify the search for new fuel sources. Examining the consumption side, average price at typical house (120 kWh/month), SDD 19/kWh could be calculated based on the flat rate monthly bill. On the other hand the kWh price at the metering system (in Khartoum) is SDD 17/kWh. Moreover, the analysis showed that ~ 70 % of the population uses electricity and the electricity cost ~25 % of the total energy budget in the household. A price of 40 SDD could be realistic when planning for the power plant based on current price paid by the two groups and that the total consumption will be relatively stable at 100-120 kWh/month i.e. 4000 SDD/month which is comparable to biomass cost. Field observation showed that electricity is perceived as very practical source of energy however it is high tech, high cost service and cannot be tackled by the community.

From correlation and regression it could be said that income is the main determining factor in relation to consumption. As no foreseen changes in the economical situation of the population could take place within the next 10 years then it could be highly expected that the current consumption pattern will continue. When comparing household in Khartoum with average monthly consumption of 300 kWh and metering system, to the study area with consumption of 120 kWh and flat rates system, it could be claimed in the study area that the relationship between electricity price and consumption is weak. This could be explained mostly by the prevailing poverty state which limits the possessing of electric devices. Looking for biomass gasification possibility; El Nuhood location in a desertified fragile area does not encourage fuel wood use as energy source. On the other hand considering the economical activities of the region then agricultural residues seems to be a possible sustainable energy source estimated by 1902 Tton. Groundnuts shells are estimated by 8000 ton/season. Considering the social acceptance there is no culture restriction or other use of shells expect for oil mill boilers (~25 % of total shells). However, this percent could be decreased in the future due to the petroleum replacement. Moreover, using shells could lead to saving of ~\$ 15 000 seasonally (360 000 sack) which is paid by the industry for dumping of the shells.

## **2.6 Conclusions**

- The existing electricity service is inadequate for all sectors.
- The electricity consumption is lower than Khartoum and more expensive.

## ***Experience and Results from Field Studies***

---

- Income is the more determining factor influencing electricity consumption.
- The electricity need /house could be estimated for the next 10 years by 4 kWh/day.
- A price of 40 SDD/kWh could be realistic for the power plant planning.
- Study area suffers from desertification; thermal use of fuel wood could not be encouraged.
- Available Groundnuts shells could be estimated by 8 Tton/year.
- Erection of agricultural residues power plant is acceptable by local community.
- Perception of electricity price and rationality should be considered when planning for erection of power plants of such types.

### **Information gaps**

- Reliable analysis of other agricultural residues transport system and hence cost prediction.
- Assessment of the heat demand of local industry that can improve the economics of the project.
- Psychological and social aspects governing the adoption of new technologies.

### **Further work**

In the next chapter, gasification techniques including optimum gasifier and gas to electricity system comparative merits in relation to agricultural residues under arid conditions will be studied.



### **3 Biomass Gasification**

The objectives of this chapter are to present theoretical background in relation to biomass gasification within the context of the over all objectives of the thesis. Mainly it tackles the following issues:

- Gasification position and comparative merits within the biomass energy context.
- Gasification process and gasifiers.
- Producer gas utilization for electricity production.

The content of this chapter will include:

- Biomass energy and gasification characteristics.
- Gasifiers and gasification products.
- PG-Electricity transformation system.

The conclusions aim to list out the main features within biomass gasification systems and hence electricity production possibilities.

#### **3.1 Basic concepts**

##### **3.1.1 Definition**

Biomass is the term that is generally used for organic non fossil material of biological origin. It includes wide spectrum from animal manure and corpses, to food residues and household waste. For the sake of this work the definition is confined to organic material derived from plants directly or indirectly through photosynthesis in presence of sunlight.

##### **3.1.2 Biomass energy**

###### **Biomass as source of energy**

Energy production from biomass is not a new trend. Biomass was the first source of energy used by human kind. In 2005 **FAO** estimated that biomass constitutes 10 % of the global energy mix [1]. In developing countries it is considered the main energy source e.g. it was estimated in Sudan at 2003 by 74 % of the primary energy sources. Biomass energy was seen as a primitive energy form that cannot be utilized for modern uses as electricity generation. Nowadays a global increasing interest is arising again and lot of research groups and governments are interested in modern energetic utilization of biomass e.g. biomass constitute 64 % of the renewable energy in West Europe in 2002 [2]. This could be referred to the specific biomass energy characteristics which will be highlighted in the following section.

## ***Biomass Gasification***

---

### **3.1.3 Advantages of biomass as an energy source**

Biomass as an energy source shows enormous comparative merits to fossil fuel, these merits could be according to [3], [4], [5], [6], [7] grouped into:

**Technical advantages:** Biomass contains lower corrosive compounds (e.g.  $\text{SO}_x$ ) than coal, thus it is safer to be used in power plants components (pipes, turbines, motors etc). Under special conditions especially for small scale, biomass can be more efficient as energy source than fossil fuels.

**Economical advantages:** Biomass is generally cheaper than the traditional fossil fuel in addition they allow the independence from *imported* oil. As a result better fuel prices could be obtained.

**Environmental advantages:** Biomass resources are sustainable compared to fossil fuel as they need shorter regeneration time. Considering the international interests in  $\text{CO}_2$  minimization then biomass based power plant merits of emitting exhaust gases with low  $\text{CO}_2$  concentration cannot be ignored.

#### **Biomass energy resources**

Biomass energy had diverse resources and uses (Fig. 3.1). Biomass could be obtained as main product i.e. energy crops which are special species cultivated mainly for energetic purposes (biological mines) or as by-product e.g. field residues or agricultural products processing waste, food rubbish could also be considered as plant biomass resource. A prerequisite for efficient thermal utilization of biomass is its availability in the required site and in the required form and size. Therefore intermediate processing and management measures such as crushing, pelleting, grinding, transportation and storage should be undertaken to insure these requirements [8],[9].

### **3.1.3 Biomass gasification**

Different processes could be used to derive energy out of biomass. The selection of the specific method depends on the biomass type and the end use. Then for every process a different form of “end energy form” (gas, liquid or solid) is produced [10],[11]. These processes are classified into:

- Bio-chemical e.g. biogas
- Physio-chemical e.g. handling rape seed to get diesel oil
- Thermo chemical e.g. gasification, pyrolysis

As far as this study is concerned only thermo chemical process will be considered, this could be further classified according to equivalence ratio ( $n$ ) and temperature ( $T$ ) into 3 main categories [7], [10], [12].

- Pyrolysis:  $n < 0.2$ ; Temperature  $< 400\text{-}700^\circ\text{C}$
- Gasification:  $n < 0.2\text{-}0.5$ ; Temperature  $< 700\text{-}900^\circ\text{C}$
- Combustion:  $n > 1$ ; Temperature  $> 900\text{-}1200^\circ\text{C}$

# ***Biomass Gasification***

---

## **Agricultural residues gasification**

The main interest in this work will be given to agricultural residues gasification based on the following consideration which was discussed in [3], [7], [13], [14] .

### **i) Biomass gasification merits**

Biomass gasification is a practiced process that had recently witnessed a boom worldwide within the efforts to replace fossil fuel by biomass. In addition to its higher efficiency especially for small scale, then gasification main merit is that *gas* could be produced, this is a very valuable energy form due to:

- Flexible transfer (distribution is not site linked).
- Increased energy density.
- Possibility for further use e.g. liquefaction or Hydrogen production.

### **ii) Benefits of agriculture residues gasification**

In this direction agricultural residues gasification are favoured to woody biomass as they are:

- Relatively cheaper than other biomass e.g. wood.
- Available in end use sites.
- Allow sustainable production (problem of forest depletion).
- Improve the economics of agricultural production systems.
- Allow better energy /electricity provision by adapting decentralized systems.
- Mitigate further problems and reduce efforts resulting from waste handling.

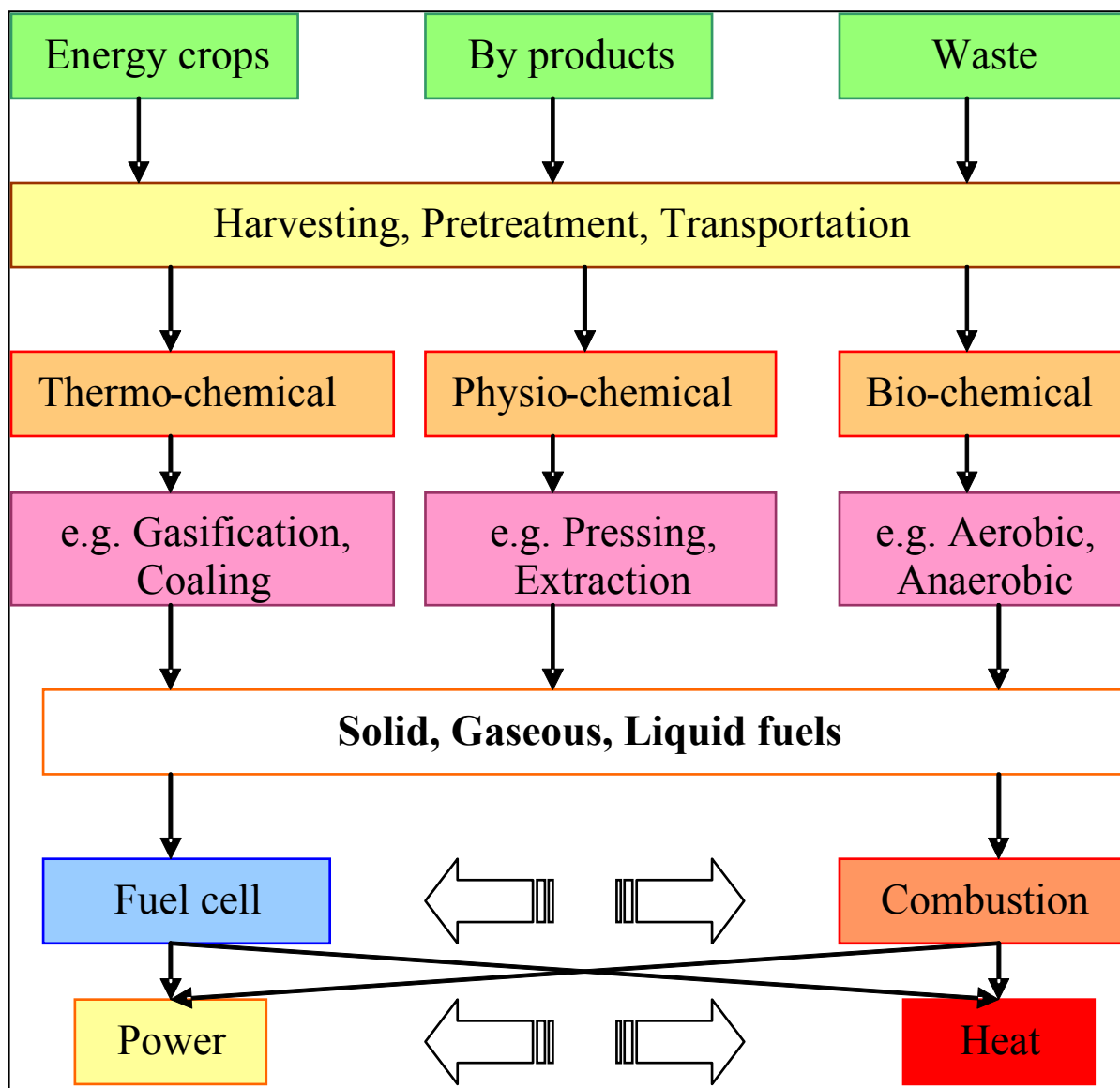

**Fig. 3.1: Biomass energy path way**

## 3.2 Gasification technique

### 3.2.1. Definition

Gasification is a thermo-chemical conversion technology in which solid fuel is transformed into a combustible gas as shown in the equations below [10]. Limited supply of Oxygen, air, steam or combination serves as the oxidizing agent. The gas produced known as producer gas (PG), is a burnable gas which consists mainly of CO, H<sub>2</sub>, CH<sub>4</sub>. PG can be directly used for heat source or for electricity production; alternatively it can be transformed to other products e.g. Hydrogen.

### 3.2.2. Gasification agents

Different gasification agents as shown below are used to allow for the gasification process to take place. Every agent will result in different type of gas as seen in table 3.1 [14], [15], [16], [17].

## ***Biomass Gasification***

---

### **i) Air**

It is the "basic" gasifying agent. Due to dilution with Nitrogen then the gas produced (Gengas) is of low c.v. 4-7 MJ/Nm<sup>3</sup>. Air gasification is relatively simple and low cost technology.

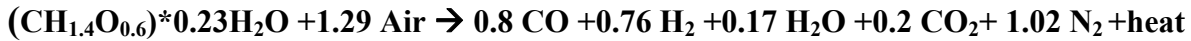

### **ii) Oxygen**

Pure Oxygen from external source is used in Oxygen gasification to produce relatively higher calorific value gas >12 MJ/Nm<sup>3</sup> (Syngas). Oxygen price and the extra safety measures taken to mitigate the explosive nature of pure Oxygen hinder its use.



### **Steam**

By using steam a high value gas can be produced 12-13 MJ/Nm<sup>3</sup>. The gas is rich in Hydrogen which makes it very promising product. However controlling steam temperature through out the process need a sound heating system, clean water and good insulation which adds to the complexion and price of the gasification plant.

**Table 3.1: Producer gas compositions**

<b>Parameter</b>	<b>Air</b>	<b>O<sub>2</sub></b>	<b>Steam</b>
CO (Vol. %)	10-20	40-50	25-47
H <sub>2</sub> (Vol. %)	9-20	9-17	35-50
CH <sub>4</sub> (Vol. %)	1-8	<1	14-25
CO <sub>2</sub> (Vol. %)	10-20	19-25	9-15
N <sub>2</sub> (Vol. %)	40-55	15-30	2-3
c.v (MJ/Nm <sup>3</sup> )	3-6	12	>12

Source: [15]

## **3.3 Gasifiers**

Gasifier is the name given to reactor where the gasification process takes place. Gasifiers are classified according to different parameters e.g. gasification agent, operational measure or gasification technique. Overview about gasifier types and products is illustrated in (Fig. 3.2). Limited description of the more wide spread systems is given in the following section. Numerical details could be checked in Appendix 3-A.

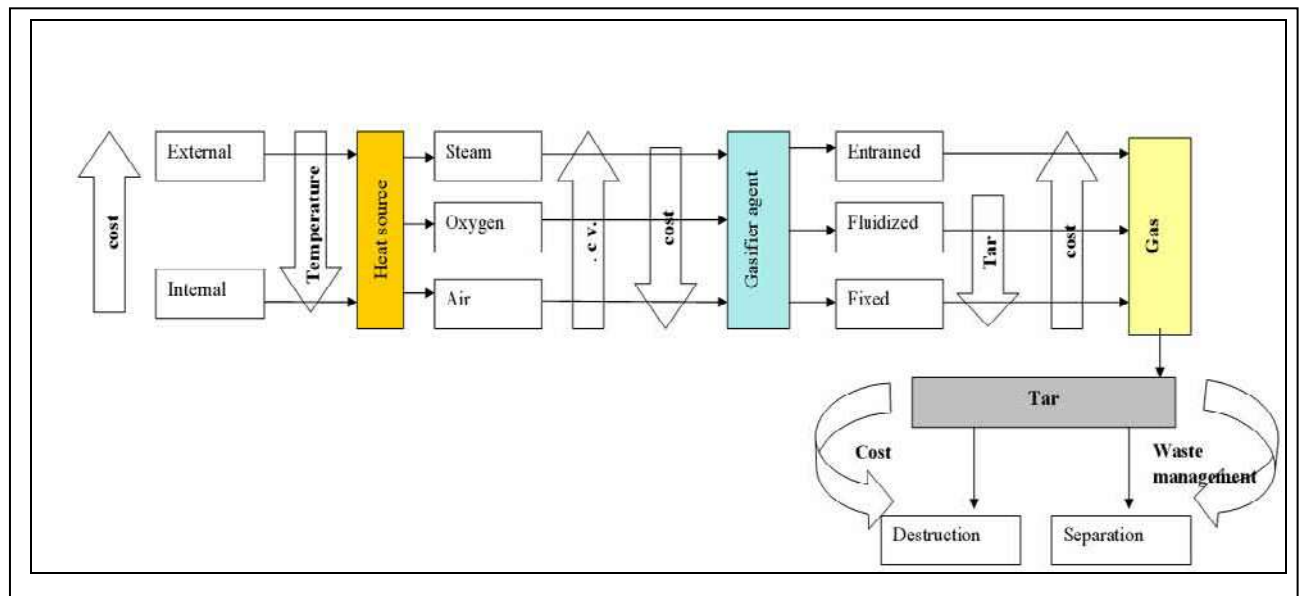

\* Entrained gasifier produce low tar but tar indication was not included in this diagram.

**Fig. 3.2: Gasification process overview**

## 3.3.1 Gasifiers classifications

### 3.3.1.1 Operational classification

#### i) Allo/Endo thermal

##### Allo thermal

In this system an external heat source is used for heating the reactor's body, the aim is initiation /catalyzing the gasification chemical reaction. Producer gas of better quality could be produced. On the other hand the main hurdle is the need of external heat supply. The heat source and reactor should be designed in a way to minimize heat transfer loss to the surrounding [14], [17].

##### Endo thermal

Here the heat needed for the chemical reactions is generated within the gasifier reactor as output of reactions (initial ignition is needed). Higher amount of char is generated due to relatively low temperature [14], [17].

#### ii) One/multi-step

##### One step

In the case of one step pyrolysis, gasification, and combustion take place in one vessel. Gasifying agent is introduced together with fuel in one reactor. They are simple and low cost type of gasifiers.

##### Multi/step

Here pyrolysis and gasification occur in one vessel while the combustion in another vessel(s). Gasification agent is supplied at the specific stage according to requirements. Sometimes in fluidising bed an inert heat transfer medium such as sand is used as heat carrier. It carries heat generated in the combustor into the gasifier in order to drive the pyrolysis and char gasification

reactions. This improves the economy and efficiency of the process. The Viking gasifier in TU – Denmark had showed positive results especially with respect to tar content  $50 < \text{mg/m}^3$ . As commercial example the Carbo-V could be mentioned. [18], [19].

### **3.3.1.2 Structural classification**

Gasifiers structure and operation wise are generally grouped into main three groups namely:

- **Entrained**
- **Fluidized**
- **Fixed bed**

#### **Entrained Gasifiers (EG)**

Based on [14], [20], Entrained gasifiers (Fig. 3.3) are characterised by very high temperatures conditions, the bottom combustion zone can reach  $2000^\circ\text{C}$ . Due to the fast reaction times, entrained bed gasifiers can have high out puts rates at relatively small reactor sizes, especially when operating at high pressures. Fuel is generally fed to the gasifier in a very fine powder form, usually under high pressure in a direct gasification mode so that residence time is extremely short. As result of high temperature the tar content is very low. EG could be operated in “slagging” or “non-slagging” mode, referring to either molten or dry ash production. Slagging entrained gasifiers are preferred to non-slagging gasifier because:

- Some melting could never be avoided.
- Slagging entrained flow gasifier is more fuel flexible.

#### **Fluidized bed gasifiers**

Fluidized bed systems (Fig. 3.4) could be subdivided into 2 further groups namely “stationary” **FB** and “circulating” **CFB**. In both cases reactors contain a hot bed material; fuel usually in powder form is fed under pressure. Air is blown through the bed of hot solid particles at a sufficient velocity to keep them in a state of suspension. The fuel particles, mixed with the bed material and almost instantaneously heated up to the bed temperature. As result of good heat transfer between fuel and bed relatively large gas quantity is produced. Further gasification and tar-conversion reactions occur in the gas phase. Ash and bed particles could be carried over in the gas stream. Most systems are equipped with an internal cyclone in order to clean the gas before further use. The design and operation of fluidized bed is seen as rather complicated process. [21], [22], [23] The major points to be considered with fluidized bed gasifiers:

- Feedstock size and flexibility.
- Possibility to use *difficult* fuels as the low temperature below the ash melting or fusion limit.
- Problems with continuous feeding and need of particle size control.
- Bed, fly-ash agglomeration and sintering.

## Biomass Gasification

- Difficult control over equivalence ratio ( $n$ ).
- High tar content ( $\sim 500 \text{ mg/m}^3$ ).

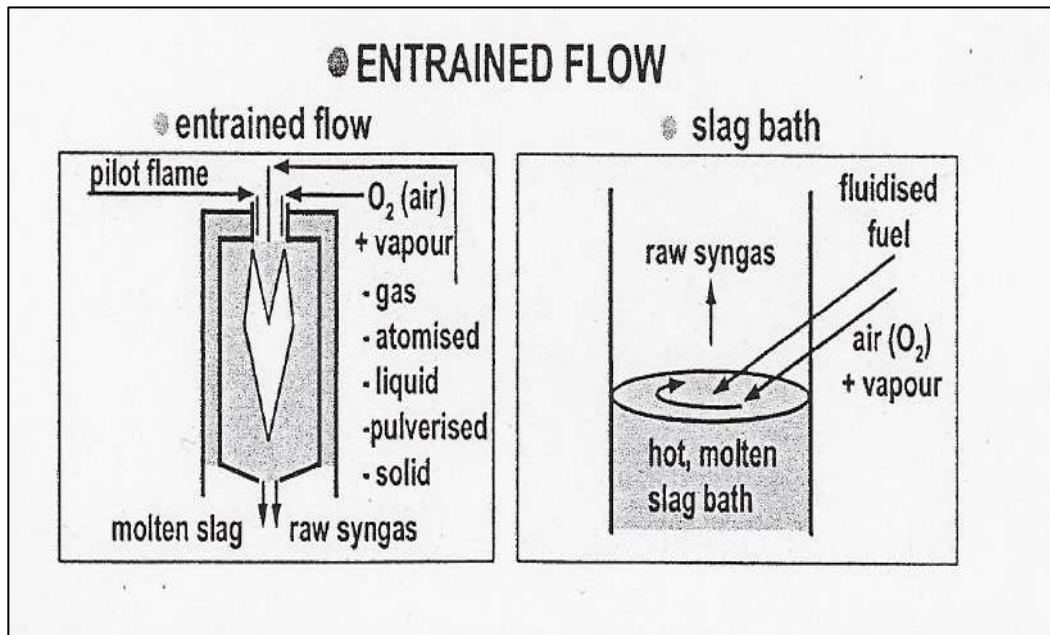

Fig. 3.3: Entrained gasifier

Source: [22]

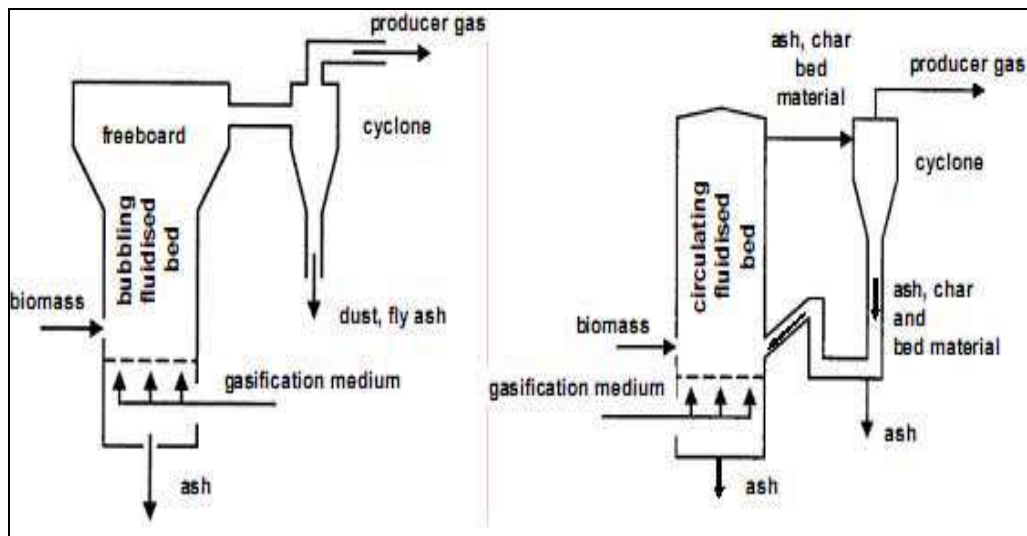

Fig. 3.4: Fluidized bed gasifier (stationary and circulating respectively)

Source: [22]

### Fixed bed gasifiers

Fixed bed systems as described in [14], [15], [23], [24] are the simplest and the most common types of gasifiers. They are further classified into up and down draft system. The main difference is the reactions sequence as seen in (Fig. 3.5).which lead to different gas parameters.



# Biomass Gasification

## Up-draft (counter-current)

In “Up-draft” system (Fig. 3.5), fuel particles flows down wards, the generated gas flows in the counter direction – upwards. Their main merit that they are tolerant to biomass moisture (40 or 50 % m.c) because drying occurs as the gas is produced but the gas is highly loaded with tar (5 % to 10 % tar) as it does not pass through the hot reduction zone. The “dirty” gas is not applicable for most applications that require clean gas, such as, gas engines. The best application is for heat production such as boiler firing.

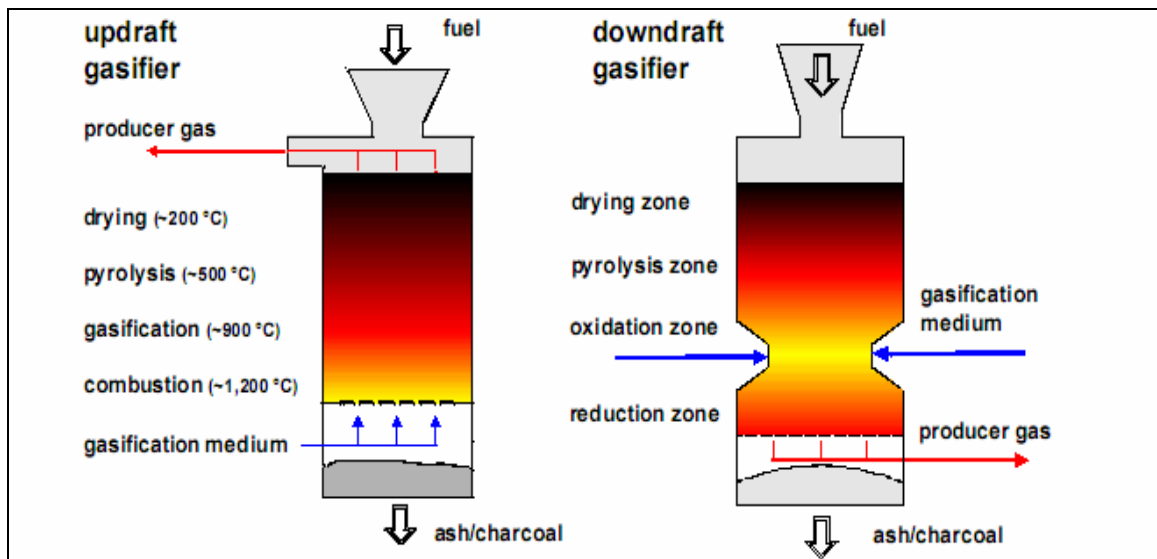

Fig. 3.5: Up-draft gasifier and Down-draft gasifiers

## 3.3.2 Downdraft gasifier

### 3.3.2.1 Process description

In contrary to Up-draft systems, the downdraft gasifier features a co-current flow of gases and solids in which fuel and gas flow in the same direction through packed bed which is supported across a constriction known as a throat where the reduction reactions occur (Fig. 3.5). Its main feature is that the reaction products are well mixed in the turbulent high temperature region around the throat which aids tar cracking. Some cracking also occurs below the throat within the fuel residual bed where the gasification process is completed. This configuration results in a high conversion rate and hence a relatively clean gas. The main characteristics could be summarized in:

- Simple and relatively low cost.
- Reliable and proven technology for relatively dry and coarse biomass (< 30 % m.c, 30-50 mm size).
- Clean gas low tar content (< 6 g tar/Nm<sup>3</sup>), suitability for use in ICE.
- Recommended to be used for small scale capacity 0.5-2 MW.

## ***Biomass Gasification***

---

### **3.3.2.2 Gasification chemistry**

#### **i) Gasification stages**

Gasification (in fixed bed systems) consists of a series of chemical reactions which can be classified into stages (Fig. 3.6). Variation of the gasification inputs (chemical or physical) e.g. temperature; residence time will affect the process. In practice these stages are neither subsequent nor separate but could take place in a parallel or overlapping manner. Stages description details and equilibrium issues are discussed below: [10], [25], [26].

#### **Drying**

Drying is the stage at which all the moisture content is driven away from the fuel particles, usually at 110°C. Due to relatively low thermal conductivity of biomass larger pieces could apparently dry up and still hold up moisture inside “it burns from outside- only”. On the other side due to its high reactivity small particles “burns away” an optimum size must be set.

#### **Pyrolysis**

In this zone the thermal breaking of the hydrocarbon starts. It is the process in which biomass is converted to vapours, primary char and primary gas; the vapours are generated near the surface. Time and temperature are controlling factor i.e. if the residence time in the hot zone is too short or the temperature too low, then molecules can escape and condense as tars and oils. On the other hand if the temperature is too high then the fuel will burn rather than gasified.

#### **Combustion (oxidation)**

At this stage the pyrolysis products react with the Oxygen derived from the gasification agent. Reactions with Oxygen are highly exothermic and result in a sharp rise of the temperature up to 1200°C. The reaction is described by the following chemical formulae:

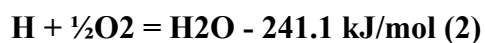
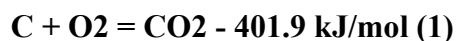

#### **Reduction**

It is the stage at which most of the desired components i.e. CO, CH<sub>4</sub> and H<sub>2</sub> are produced. As it can be seen the reaction is endothermic i.e. it require heat. As a result the temperature will decrease to about 900°C. The reaction follows the following equations:



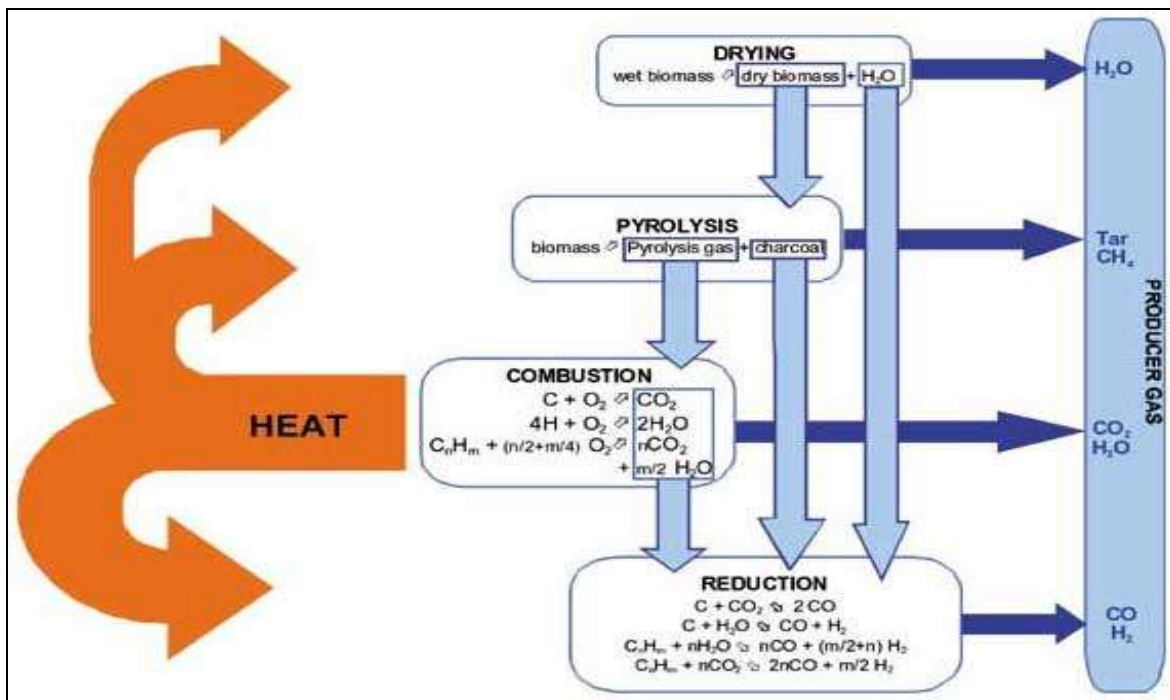

Fig. 3.6: Gasification stages in down draft gasifier

Source: [26]

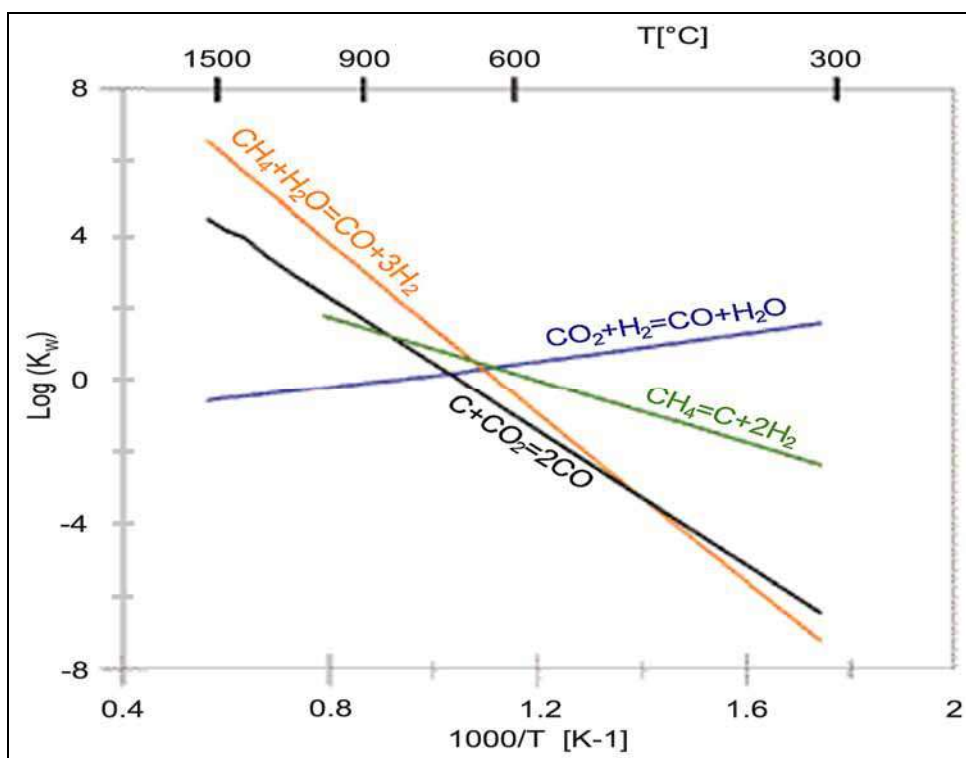

Fig. 3.7: Gasification products as function of temperature

Source: [26]

## ***Biomass Gasification***

---

### **ii) Equilibrium state**

Within the gasification process the system tries to reach a state of equilibrium that is limited by the gas equilibrium constant ( $K_w$ ) which can be defined as the ratio between the products and the reactants at any temperature. Actually the producer gas is a composition of different gases produced at different percents as result from each equilibrium process. These reactions are highly temperature and pressure sensitive (Fig 3.7). This could be illustrated by the Boudouard reaction.

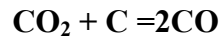

The equilibrium of this reaction is shifted with increasing temperature favouring CO production.

### **3.3.2.3 Practical considerations for down draft gasifier**

At the practical aspect downdraft system had shown different problems, these short comes were discussed in [19], [27], [28], [29] and could be classified into:

#### **Scaling**

The trial to scale up the reactor is always associated with various obstacles. Non uniform distribution of Oxygen leads up to creation of hot and cold spots. In order to avoid cold spots in the oxidation zone, air inlet velocities and the reactor geometry must be well chosen.

Generally two methods are employed to obtain an even temperature distribution:

- Reducing the cross-sectional area at a certain height of the reactor ("throat" concept).
- Spreading the air inlet nozzles over the circumference of the reduced cross-sectional area.
- Alternatively using a central air inlet with a suitable spraying device.

#### **Fuel selection**

- The fuel size must be in the range from 3-5cm (in pieces form) feed stock should remain sufficiently large during flaming pyrolysis and subsequent gasification to prevent the fuel bed from plugging and to limit the bed pressure drop.
- Fuel with high content of Silica or Alkaline compounds could lead in presence of high temperature to agglomeration and deposition problems.
- Low m.c. generally 30 %.

#### **Feeding system**

Due to the sensitivity of fixed bed to gasification room geometry and so to fuel quantity then an efficient feeding system which should be capable of transporting, dosing and feeding is required.

Taking in consideration that fuel for fixed bed should be of specific size, form and hardness (well defined pieces) then the selection of the feeding system is not easy job. Partial load operation mode result in limiting/decreasing the hot regions and can lead to incomplete gasification.

#### **Temperature**

Temperature is a main factor in controlling the gasification process through controlling the products at the equilibrium state which temperature dependant. As biomass is more reactive then it is

## ***Biomass Gasification***

---

more sensitive to temperature variation. The maximum temperature attained in a gasifier affects the cracking and decomposition of the biomass; this in turn is strongly related to calorific value and tar content of the produced gas. High temperature  $> 1200^{\circ}\text{C}$  will lead to combustion rather than gasification, “good” cracking occurs at  $900^{\circ}\text{C}$ . Temperature is strongly linked to (clogging and packing). In case of alkali rich fuel then this could have adverse effects.

### **Pressure**

Increasing pressure results could result in better gas quality in some systems e.g steam or entrained gasification by raising the level as it act as catalyst for reaction and insure better gas production, however pressure requires special techniques (compressors) which require extra cost and reduce the efficiency. On the other hand (PG) from pressurized gasifier could be used directly” to operate gas turbines. This eliminates the need to cool the gas before compressing it again. At high pressure the power output relatively increases and so the efficiency is remarkably increased. Pressurised gas as generally also enhances further chemical synthesis. However a general favourization is very critical especially for fixed bed systems as the equilibrium state products are highly dependant on the pressure.

## **3.4 Air gasification products**

Dependent of gasifier agent or gasifier design then the gasification products have specific characteristics, in this study only air gasification products under atmospheric pressure condition systems will be considered.

### **3.4.1 Gas**

The producer gas in air -fixed bed gasifier systems is generally characterised:

- Combustible gases  $\text{CH}_4$ ,  $\text{H}_2$ ,  $\text{CO}$ . (35-40 %).
- Non combustible or inert gases as Nitrogen and  $\text{CO}_2$  (50%).
- The heating value of the gas is proportional to the total percent of combustible gases.
- Gas production is estimated by  $\sim 2 \text{ Nm}^3/\text{kg}$  of biomass.

### **3.4.2 Contaminants**

Contaminants mainly include inert particulate, tar, alkali and non tar chemical compound ( $\text{NO}_x$ ,  $\text{SO}_x$ ) in addition to Halogens [30]. They are expected products at any gasification process. They negatively affect the gas quality and the efficiency of process. Contaminants are affecting the whole gasification chain, starting with the sustainability of the gasification processes and ending with the end use systems. The sensitivity of electricity generation system to contaminants content in gas is highly variable, as seen in Appendix 3-B, thus the selection of the optimum gas cleaning system is highly linked to end use. On the other hand contaminants have diverse nature and properties [31],

[32]. Different methods are used to eliminate them each method had its comparative merits as seen in Appendix 3-C. This section is focused on tar and particulates while Alkali are discussed further in (Ch. 4).

### **Tar**

#### **Nature and hazards**

Tar can generally be defined as un-cracked hydrocarbon produced within any thermo chemical reactions with molar mass > than Benzene (78g/mol). The main tar groups are Phenols, (PAH),<sup>18</sup> at different percents depending (a.o.) on gasifier design as seen in (Fig. 3.8). It illustrates the variation between fixed bed and fluidized bed systems based on value for (real) biomass gasification power plants. Operationally, tar formation is temperature dependant as seen in table 3.2 where by Phenols are produced at the low temperature range and the PAH at the higher range. Both groups are considered hazardous and environmentally destructive (see Ch .5).

**Table 3.2: Tar types in relation to temperature**

<b>Compound</b>	<b>Mixed Oxygenates</b>	<b>Phenolic Ethers</b>	<b>Alkyl Phenolic</b>	<b>Heterocyclic Ethers</b>	<b>PAH</b>	<b>Larger PAH</b>
Temperature (°C)	400	500	600	700	800	900

**Source: [26]**

Tar varies according to gasifier, fuel used and operation mode. It is generally produced as a gaseous product; in this state its negative impacts could be eliminated. The problem arise when it condensate as the gas cools (~300 °C) thus due to high viscosity it will accumulate on the gas pathways causing soot formation or packing and subsequently erosion. As the temperature increases (900 – 1000 °C) a series of reaction take place in which tar components form more stable bonds (polymerising). Further condensation and accumulation of these products in the reactor or engine (tar had low saturation concentration at temp below 100°C) may lead to more complicated problems of clogging, erosion and corrosion which could cause complete engine or gasifier failure. Tar is considered as the main obstacle for wide spread of gasification technology. An important aspect of tar production is its higher energy content which lowers the thermal efficiency of the process. Also tar is *non useful* percent of the fuel component thus lowering the gasification efficiency. Tar as one of the “pollutant” of producer gas can be removed through “gas cleaning package which will be discussed in the following section.

---

<sup>18</sup> PAH=Poly cyclic aromatic hydrocarbons , low molecular weight, sever health hazard  
Phenols= Aromatic Hydrocarbon with at least one OH group, corrosive  
Oxygenates= organic non aromatic with at least one O<sub>2</sub> atom

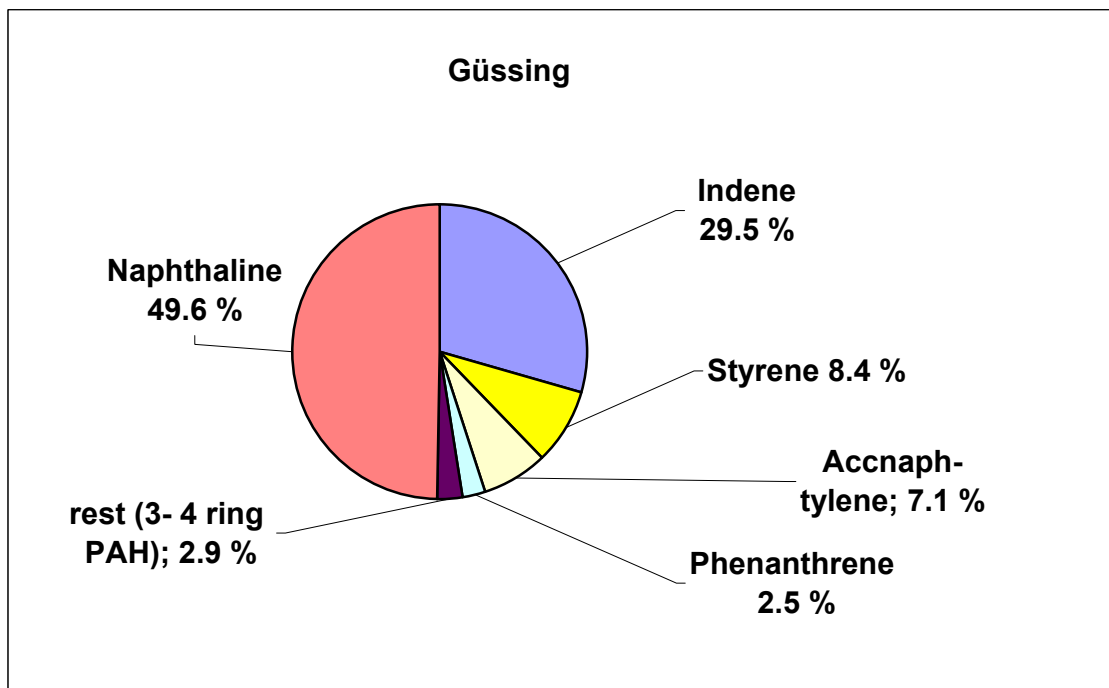
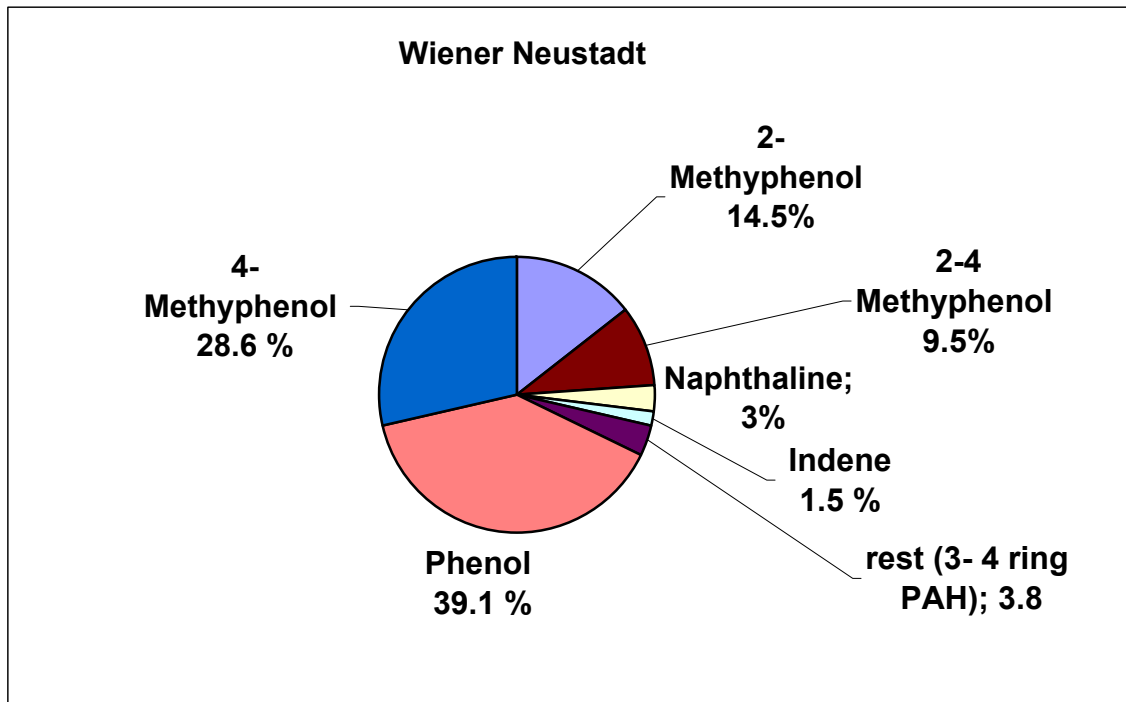

**Fig. 3.8: Variation of tar compositions with gasifier type**

\* Wiener Neustadt (Fixed bed -2MW), Güssing (Fluidised bed -8MW)

Source: [33]

### **Tar handling methods**

Methods used to handle the tar problem were tackled by [30], [31], [34]. It can be classified into:

#### **i) Tar separation methods**

These systems are commonly known as filters and separators and serve the complete removal of tar in the materialistic sense. They could be further classified into hot systems e.g. cyclone or cold systems e.g. washers. Both systems are characterised with relatively low cost, simplicity of construction and operation with exception of electric filter. The main draw back is generation of other problem "waste handling", considering the toxic nature of tar and the interest in clean environment then these problems are of the same consideration.

#### **ii) Tar destruction methods**

This includes methods like (thermal) (catalytic) (partial) oxidation/hydration of tar or adjusting the gasification process parameters e.g. increasing temperature in reduction zone. In these systems the tar existence at exist is prevented at either pro or post gas production point. These systems are considered as sophisticated expensive systems thus adding much to the cost of the gasification plant and so its products. This factor is highly sensitive at small scale plants. On the other hand, reconstruction of reactors may contradict with other requirement e.g. properties of available material.

### **Particulates**

#### **Nature & Hazards**

Particulate is the collective term which includes ash, not reacted biomass and dust found in air. Alternatively particulate was defined by [35] as "any object having precise physical boundaries in all directions". Particulate size is the one of the determining factors when evaluation particulate issue then assuming that they are chemically inert then the main particulates hazards are erosion and agglomeration, both factors disturb smooth gas passage. In practical experience the particulate hazards exists even at low loading level. One particle can form a central nucleus for further collection alternatively it could act as carrier for other compounds like Alkali thus enhancing corrosion.

#### **Particulate handling**

Particulates differ in size and nature. The main way to handle this problem is to separate them at gas exit, cyclone are the classical examples however they generally require certain minimum particle size (5  $\mu\text{m}$ ) and so they are non effective for finer size. On the other hand electric and bag filter systems have higher separation efficiency but the efforts paid for continuous change of the filter material and ensuring the particulates cleanness (not contaminated by tar) are the main hurdles when using this system. Further, down stream problems like disposing off the filter material or managing the collected particle had also to be considered [31], [35].



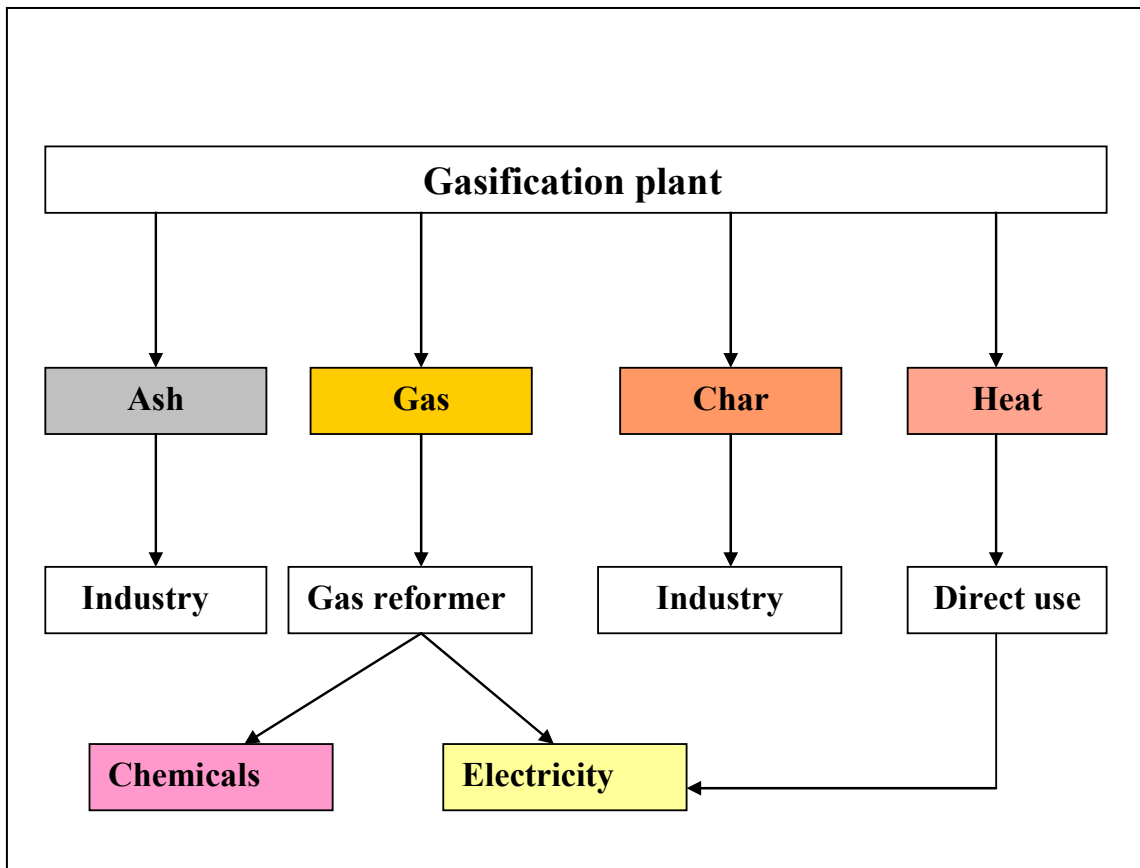

**Fig. 3.9: Gasification plant products**

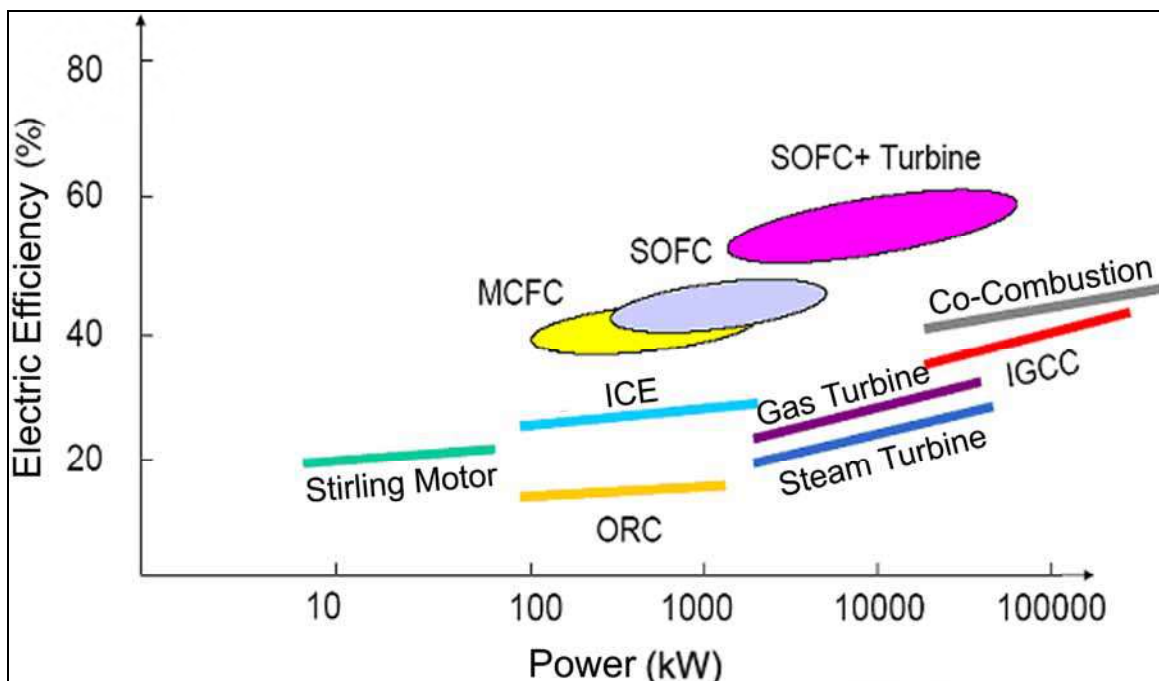

**Fig. 3.10: Efficiency & power range for different biomass based power plants**

Source: [38]

### **3.5 Gasification for electricity**

Gasification plants could be used for different purposes as shown in (Fig 3.9). However the increasing demand for electricity accompanied with the global interest in climate change encourage more power plants to incorporate different technologies to produce the so called environmental and economical electricity. Electricity production based on biomass gasification systems is very efficient especially at lower range from < 1-2 MW and in the very big range of >10 MW as seen in (Fig. 3.10). The transformation could take traditional paths e.g. gas engines or gas turbine but also new paths are researched e.g. e fuel cell or Stirling motor. Biomass gasification for electricity production is strongly linked to sustainable supply of biomass and homogeneity of its characteristics. When selecting the specific system for electricity production then beside technical limitations like the maximum allowable contaminants value (Appendix 3-C), other surrounding factors should be considered e.g. waste management and safety. The Different systems for transforming PG to electricity will be discussed in the following section based on [19] [36], [37], [38].

#### **3.5.1 Fuel cell**

##### **General requirement**

Fuel cells based on [39], [40], [41] (Fig. 3.11) are considered as a very practical electricity production system as the gas is electrolyzed at a process that has better efficiency than the combustion process. Nevertheless for smooth coupling with biomass gasification then gas purity plays an important role. Operation and maintenance requirement are highly strict; this could be illustrated for two factors:

- Gas components: H<sub>2</sub>, CH<sub>4</sub> and CO are acceptable components while CO<sub>2</sub> and SO<sub>x</sub> have diluting and poisonous effects.
- Gas temperature: the input temperature should be optimized in relation to fuel cell requirement (there are two types of fuel cell, low temperature type 20-200°C e.g. AFC, PAFC, PEMFC and high temperature type of 600-1000°C e.g. MCFC or SOFC). Details about fuel cells types and properties could be found in Appendix 3-D.

##### **Positive aspects when used with biomass gasification (SOFC, MCFC)**

- Suitable for gas containing higher percentage of CO.
- Working temperature of 700 °C is relatively suitable to PG exit temperature.
- Higher elect efficiency > 40 %.
- Quick power change.
- Excess heat could be utilized for further use.
- No emission.

## Biomass Gasification

### Negative aspects when used with biomass gasification

- Degradation with time (2 %/year in (SOFC)).
- Variability in gas composition depending on biomass sources.
- Slow start.
- High price which can reach to more than 50000 \$/kW.
- Availability problem.

### Application in reality

Until now there is no real commercial application but a lot of research is taking place e.g. Biocellus [www.biocellus.com]. The test results obtained at different institutes are producing positive indicators for further research e.g. experimental results at ECN- Holland recorded operation of 7- 12 MW<sub>el</sub> system with net efficiency of 42-43 %.

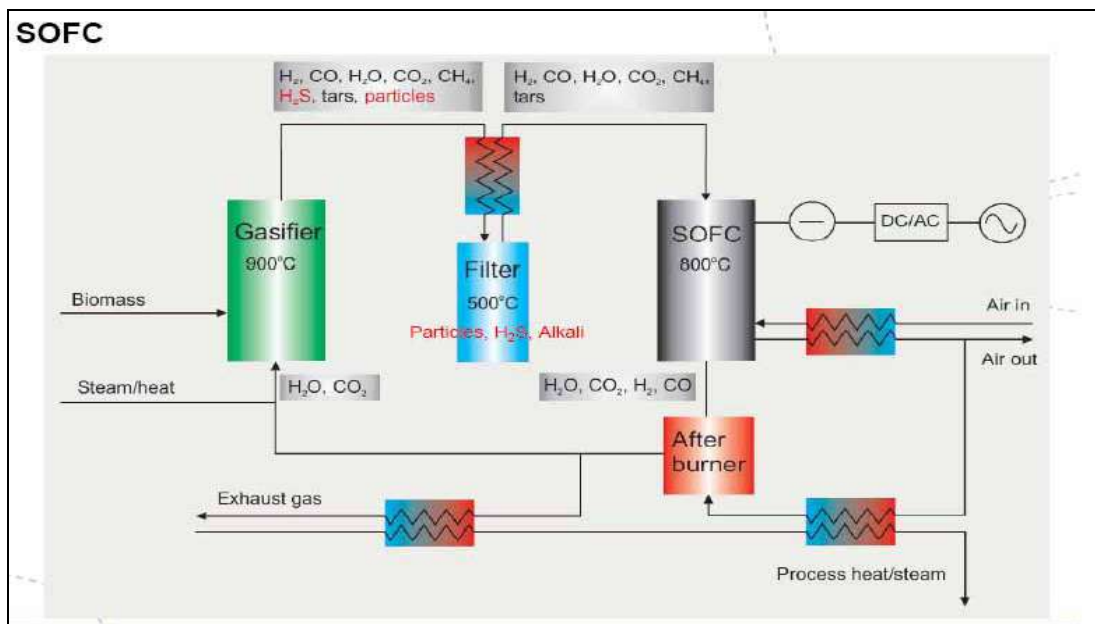

Fig. 3.11: Fuel cell (SOFC) with gasifier

Source: [39]

### 3.5.2 Stirling engine

#### General requirement

Stirling engine (ST.E) is characterized by external combustion mode, fuel is burnt in external chamber and heated air is used as piston pushing force. Due to this characteristic (ST.E) is suitable for different types of gases with high tar content. The requirement of robust material to stand the high temperature is a limiting factor. Stirling motors are usually coupled to biomass combustion however the use of (PG) enables-better efficiency and cleaner process [38], [42].

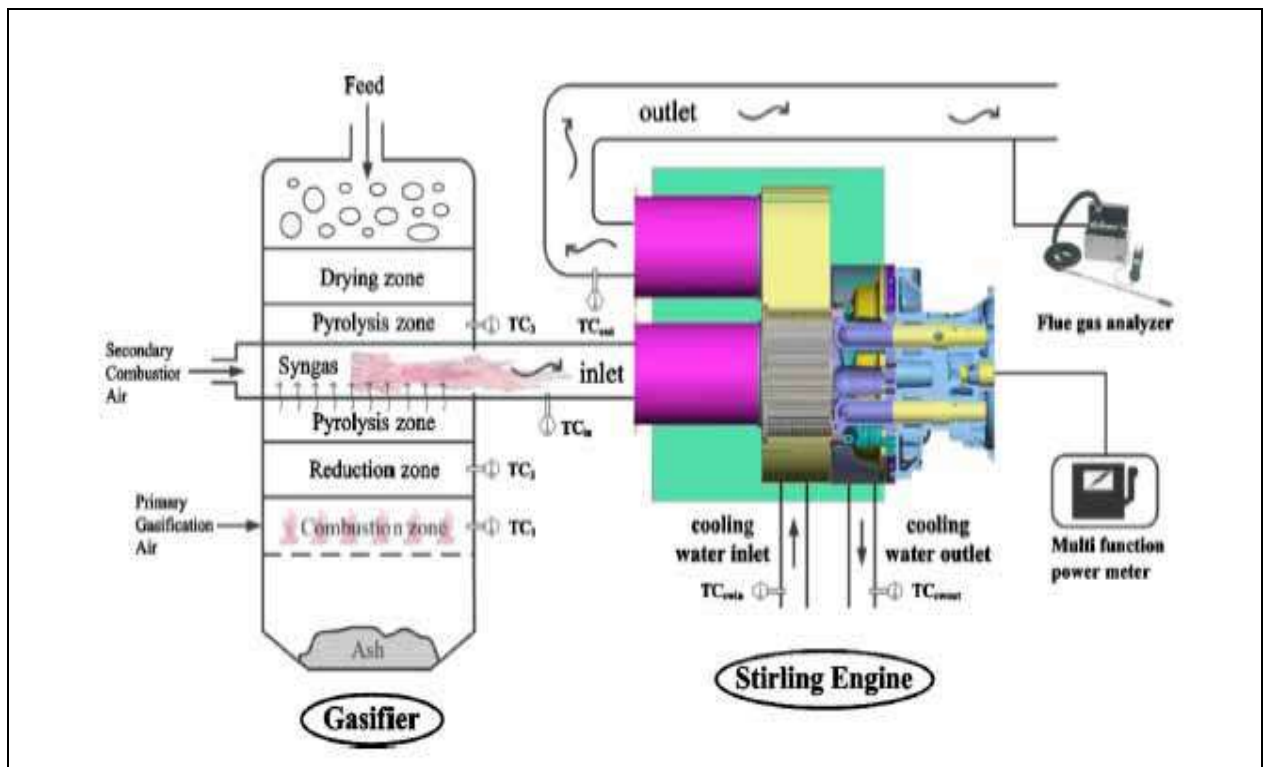

Fig. 3.12: Stirling motor and gasifier system

Source: [42]

### Positive aspects when used with biomass gasification

- Suitable for tar loaded gases.
- Flexible use of different biomass.
- No need for cooling.
- Lower temperature (less robust material) and cleaner emission than biomass combustion.

### Negative aspects when using with biomass gasification

- Extensive cleaning of particulate and alkali (to avoid erosion and corrosion).
- Variability in gas production may affect the system stability.
- Low power range <math>< 50 \text{ kW}\_{el}</math>.
- Non availability in market, lack of operation experience.

### Application in reality

As for fuel cell no real experience is recorded, the research in relation to PG use is rather limited and generally confined to very low power output. In [42] (Fig 3.12) an experiment was conducted for connecting updraft gasifier with 25 kW with ST.E. He recorded that operation of the engine was possible at electric efficiency of 26 %. At the end he concluded that "The proposed system could be considered as a feasible solid biomass powering technology"

### **3.5.3 Internal combustion engine**

#### **General requirement**

ICE (Otto or Diesel) is one of the most reliable power production systems; this is also valid when it is coupled with gasification unit. It has efficiency more than 30 %. It was mentioned that it could reach 38 % but the smooth operation requires a cold (40-60°C) clean gas. At the range of 100 -1000 kW, ICE is considered the most suitable technology. [15], [41], [43] [44] [45].

#### **Positive aspects when used with biomass gasification**

- Allows simple gas cleaning package (washing).
- Available and reliable technology.
- Suitable for small scale.
- Does not require major modification in the engine or extra aggregates.

#### **Negative aspects when used with biomass gasification**

- *Lower* thermal properties compared to fossil fuel (low c.v., leaner combustion, different stoichiometry).
- Lower flame temperature and speed.
- CH<sub>4</sub> content in relation to Methane number and the knocking phenomena.

#### **Application in reality**

The CHP-plant in Wiener Neustadt (Austria) is semi commercial power plant. It has a fuel (wood pieces with m.c < 20 %) capacity of 2 MW. The fixed bed gasification reactor is air blown and has downdraft design. The calorific value is in the range of 4.5 to 5.5 MJ/Nm<sup>3</sup>. The plant was recorded to have electric efficiency of ~28 % (Fig 3.13).

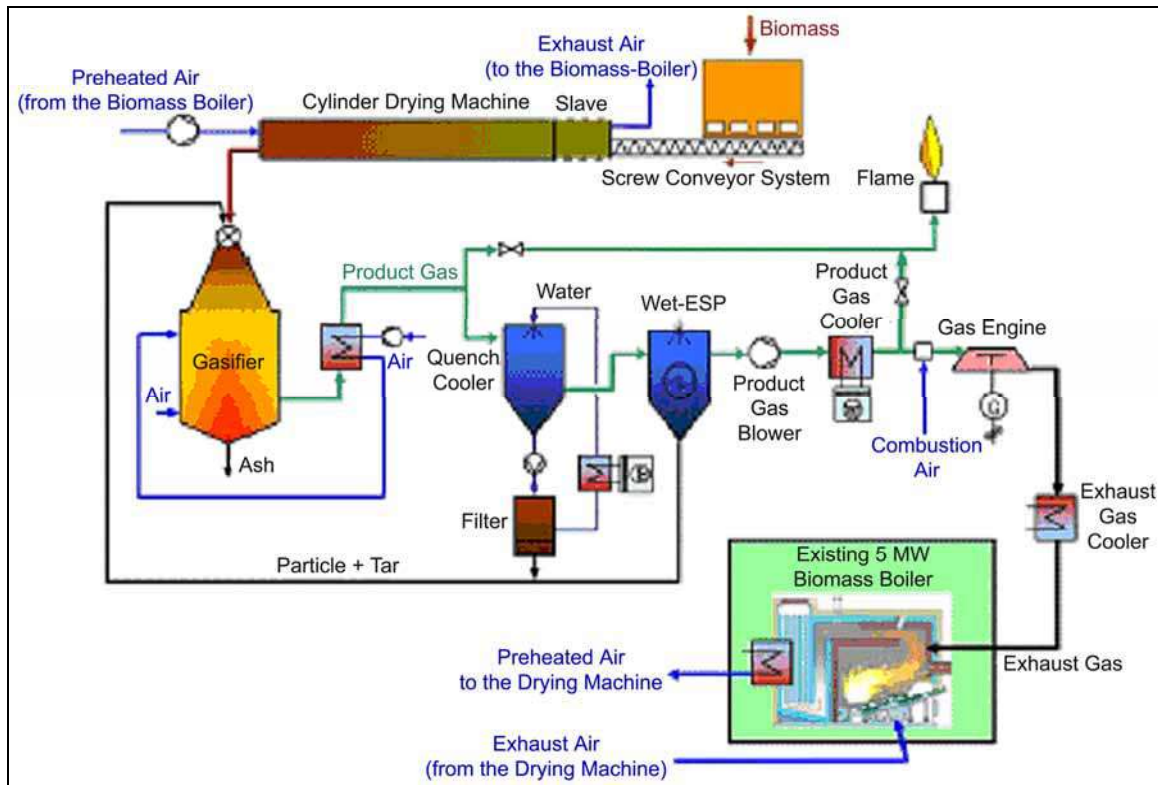

**Fig. 3.13: Wiener Neustadt Gasification power plant**

Source: [33]

## 3.5.4 Gas turbine

### General requirement

Gas turbine is well practiced technology in the field of gaseous fossil fuel. In coupling with gasification some examples already exist. Turbines operation does not require cooling of gas and favoured pressurized systems therefore efficiency  $>35\%$  could be attained especially at large scale production e.g. (IGCC) ( $>10$  MW) [46], [47].

Gas turbine systems could be divided into:

#### i) Internal turbine cycles (ITC)

Gas is fed directly to turbine combustion chamber.

#### ii) External turbine cycles (ETC)

The producer gas is burned in a close coupled combustor–heat exchanger system and the gas turbine is then coupled through a medium usually air, sometimes ORC is practiced.

### ITC

#### Positive aspects when used with biomass gasification

- The use of the hot gas produced without cooling increase the efficiency.
- High energy content in the exhaust gas, extra systems could be coupled (higher exergy).
- No temperature optimization (reduction) is required.

# Biomass Gasification

## Negative aspects when used with biomass gasification

- Afford hot (pressurized) gas cleaning systems which are usually very expensive.
- Economical only at larger capacity.
- Lower thermal properties compared to fossil fuel (low c.v., leaner combustion different air/fuel ratio).
- Boiler design material and size, fouling occurrence and attaining of high temperature.

## Application in reality

Vernamo Demonstration project in Sweden (Fig. 3.14) was established 1995 based on IGCC concept. Fuel energy (mainly wood chips, Straw and RDF) was 18 MW. The gas has c.v. of  $5\text{MJ}/\text{Nm}^3$ . The operating pressure is 18 bar, temperature  $950\text{-}1000\text{ }^\circ\text{C}$ . The filtering system utilizes the high temperature and bed material through catalytic cracking process in addition to ceramic filter. The average net electrical efficiency recorded was 32 %. Vernamo project operated relatively satisfactorily till 1999 and achieved 3500 hr of operation [19], [48].

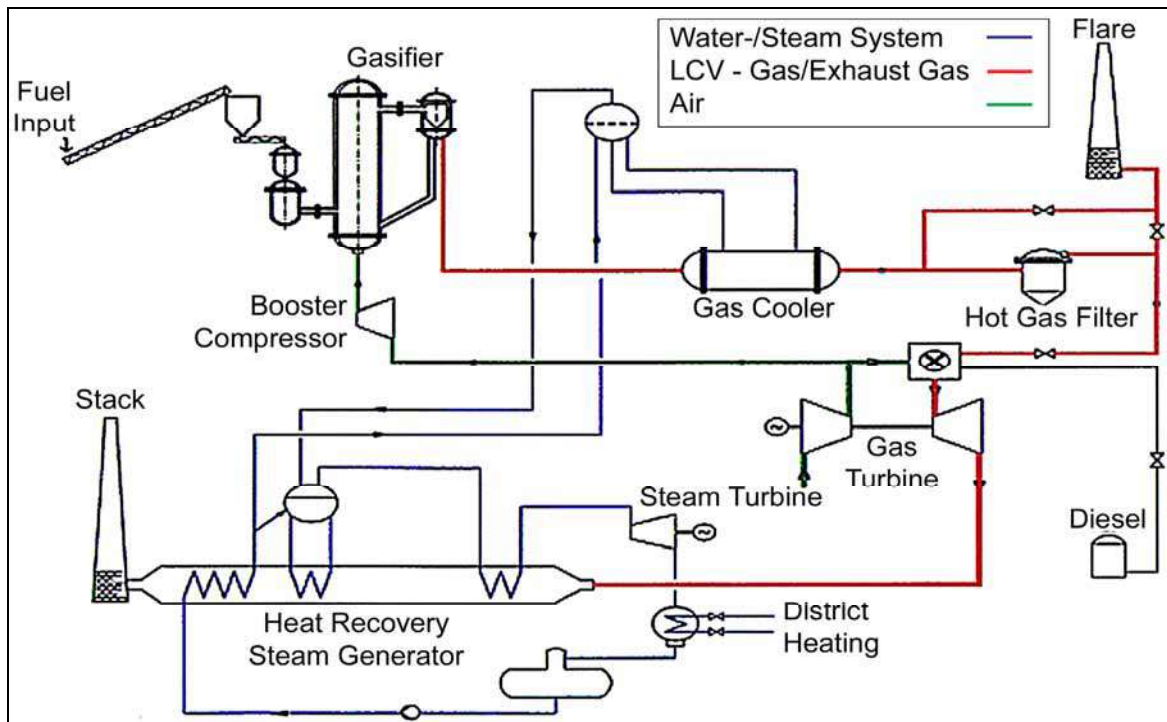

Fig. 3.14: Vernamo process (IGCC)

Source: [19]

## ETC

## Positive aspects when used with biomass gasification

- The use of the hot gas produced without cooling favours the usage of turbine systems.
- Comprise indirect heating of hot air so that tar removal effort can be reduced.
- Zero emission circuit.

# Biomass Gasification

## Negative aspects when used with biomass gasification

- The required heat exchanger lowers the efficiency.
- In case of pressurised system e.g. turbines then (*costly*) pressure optimization may be necessary.
- Heat exchanger design, selection of material to allow for more than 1500 °C.
- Complete particulates removal is necessary.
- Boiler design, fouling occurrence and attaining of high temperature (hot, *dirty* gas).

## Application in reality

A typical project exists at VUB (BINAGAS). The system consists of an atmospheric fluidized gasifier operating between 725-850 °C to produce 500 kW<sub>el</sub>. A natural gas combustion raises the temperature >1000°C. The PG is first delivered to the combustion chamber and then to heat exchanger as a result air can be heated up to 850 °C. Electric efficiency lies at 24-30 %. Another system is found in Rostock University (Fig. 3.15) [49], [50].

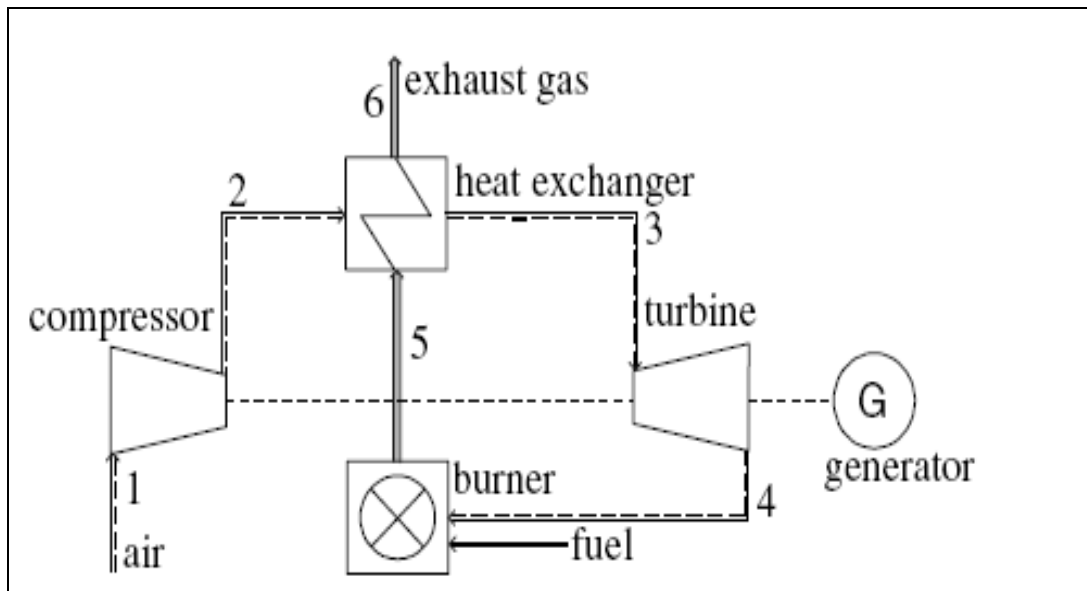

Fig. 3.15: ETC at Rostock University

Source: [49]

## 3.6 General overview

As seen from above then every technology has its strength and weakness points. With help of (Fig. 3.16) an overview evaluation could be obtained at a glance. The main evaluation characteristics were grouped into sub groups which were internally scaled from 5-1 in descending order, these groups are:

- Tar tolerability, needed efforts for tar (contamination) reduction.
- Suitability for direct use: lower operational measures needed for PG e.g. fuel preparation, pressure increase before further use.



## ***Biomass Gasification***

---

- Achievable electricity efficiency.
- Availability: includes cost in addition to maximum size available in market, existing operational experience/scientific information.
- Independency on other components e.g. heat exchanger.

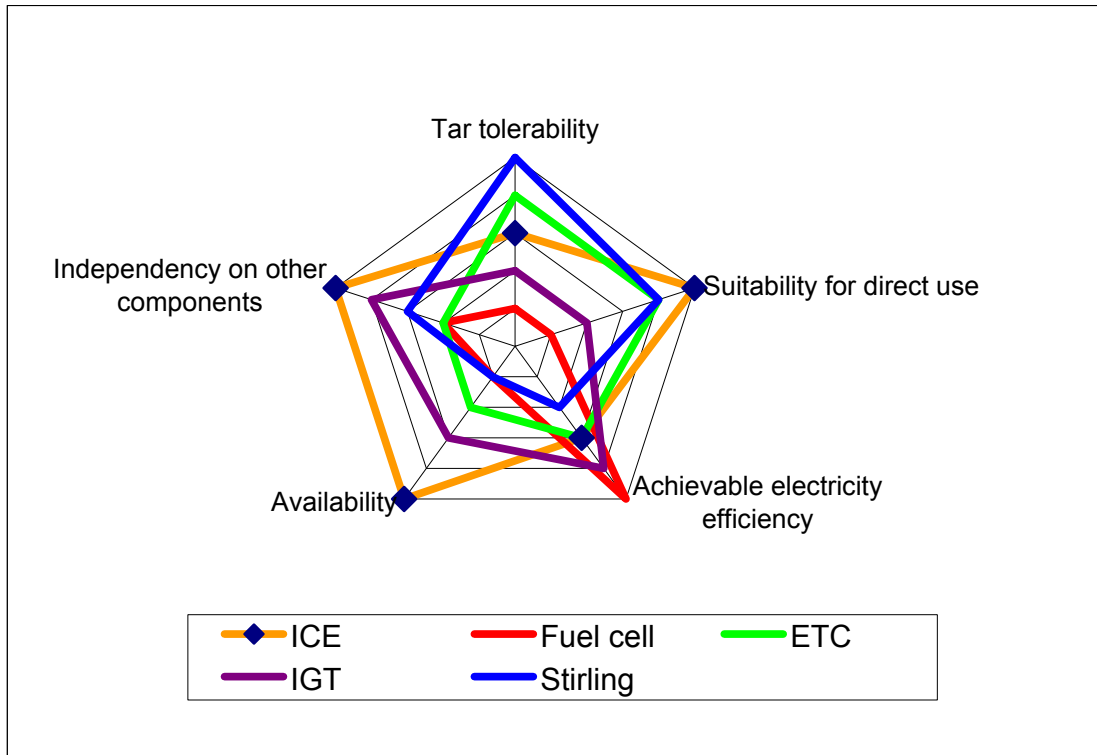

**Fig. 3.16: PG- electricity systems**

### **3.7 Conclusions**

#### **Findings**

- Gasification of agricultural residues offers possible energy form in arid land.
- Atmospheric fixed bed gasifier offers better possibility considering operation and design.
- ICE is the most suitable system to use especially under developing countries conditions.

#### **Gaps**

- Detailed studies about effect of gas from agricultural residues on ICE.
- Studies about waste management for (BGPP) especially under developing countries conditions.

#### **Further work**

In the next chapter fuel properties (in relation to gasification) of some agricultural residues will be studied and the results of some tested material.

## 4 Fuel properties of Agricultural Residues

The objectives of this chapter are:

- To study the inter-relationship between biomass properties and its suitability as fuel.
- Investigate the suitability of different sudanese agricultural residues for thermal utilization.
- To select optimum materials for further investigation (within the study overall objectives).

Thus this chapter includes:

- Causes and consequences of different fuel properties.
- Experiment's built-up and materials tested.
- Analysis and discussion of the results.

The conclusion aims to specify the optimum product for further testing in fixed bed gasifier.

### 4.1 Introduction

#### 4.1.1 Similarity and diversity

Plant biomass in its different forms has the same chemical composition i.e. Carbon(C), Oxygen (O), Hydrogen (H) in addition to other metallic and non metallic compounds.[1], [2], [3], [4]. It is in a way or another set of  $C_xH_yO_z$  chains formed according to [1] through the following equation:



When compared to coal, biomass has less Carbon and more Oxygen atoms, Nitrogen and Sulphur atoms are strongly fixed in the coal structure than in biomass as seen in (Fig. 4.1) which visualize biomass and coal molecule [5]. This results in coal having different (better) fuel properties than biomass but more polluting effect. In an (*ideal*) full combustion process biomass react generally according to [1] through the following equation:

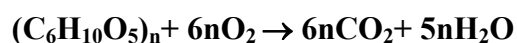

Nevertheless, when comparing different types of biomass (wood, Straw, stalks etc) in relation to their fuel properties then variations are realized. These variations show a recognizable relationship with the technical and economical efficiencies of the thermal process. Moreover, their effects extend to the quality and quantity of the products including ash and waste [1], [2], [6], [7], [8], [9]. These differences could be referred to internal and external factors which will be considered in the following section.

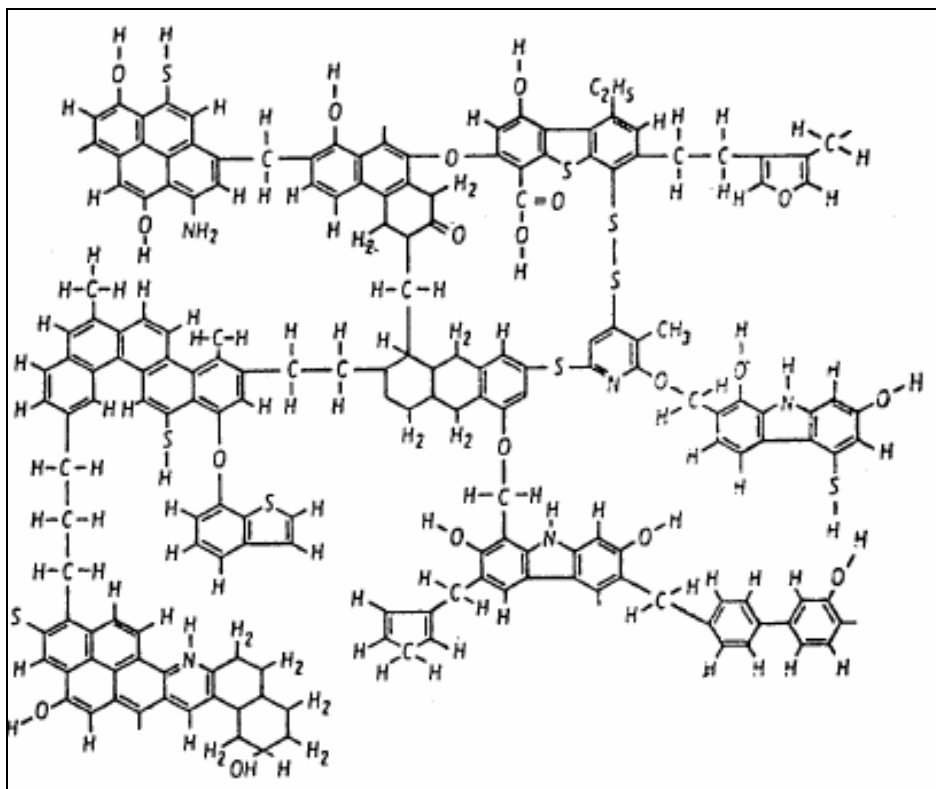
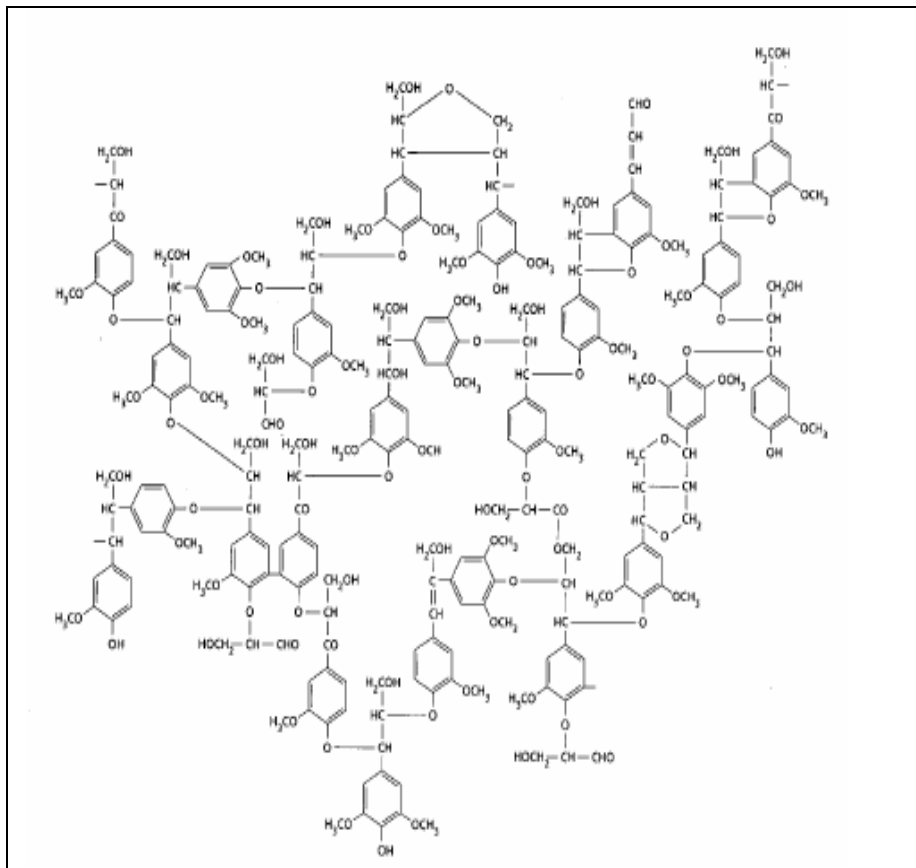

**Fig. 4.1: Coal and Biomass (Wood) structure**

Source: [5]

### **4.1.2 Internal factors**

Internal factors are more or less unchangeable characteristics of plant that effect its fuel properties. These include a.o the photosynthesis pathway and so Cellulose, Hemicellulose and Lignin percentages in the plant. The fuel properties, and so the thermal behaviour, of a certain biomass are governed by the specific percentage of these components in it [4], [5], [7], [10], [11]. Consequently [1] had investigated these components (table 4.1). He concluded that biomass types with higher lignin content have higher Carbon content and so higher calorific value.

**Table 4.1: Typical Carbon content and calorific value of selected biomass components**

<b>Component</b>	<b>Carbon content (mass %)</b>	<b>Calorific value MJ/kg</b>
Mono saccharides	40	16
Poly sacharides	44	18.
Liginin	63	25

\* All figures are averaged and rounded

**Source: [1]**

In a study carried by [11], he classified the biomass into three categories:

- Material with relatively high cellulose content e.g. Straw and stalk materials (40 %).
- Woody material with high lignin content e.g. wood chips, peanut shell (30 %).
- Cellulosic materials mainly composed of pure cellulose e.g. cotton (> 90 %).

He then conducted tests to study the pyrolysis behaviour of these materials and found that cellulosic materials quickly decomposed at temperature range between 590–670 K followed by Straw material then woody material with the longest duration (Fig. 4.2).

Internal factors are assumed to be species dependant and modifiable. However, a room for GMO could be here introduced but the over all effect of internal factors is only partial compared to the effect of the external factors.

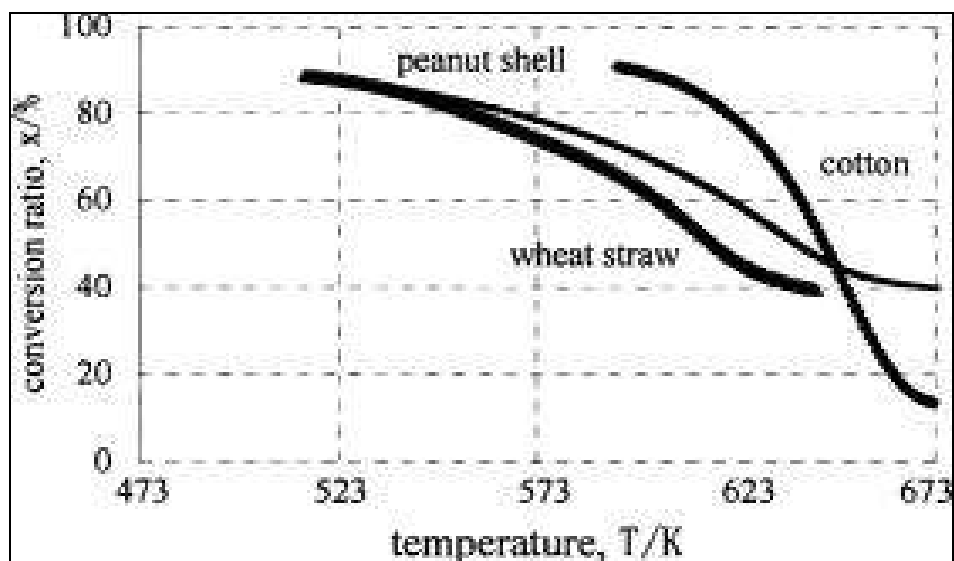
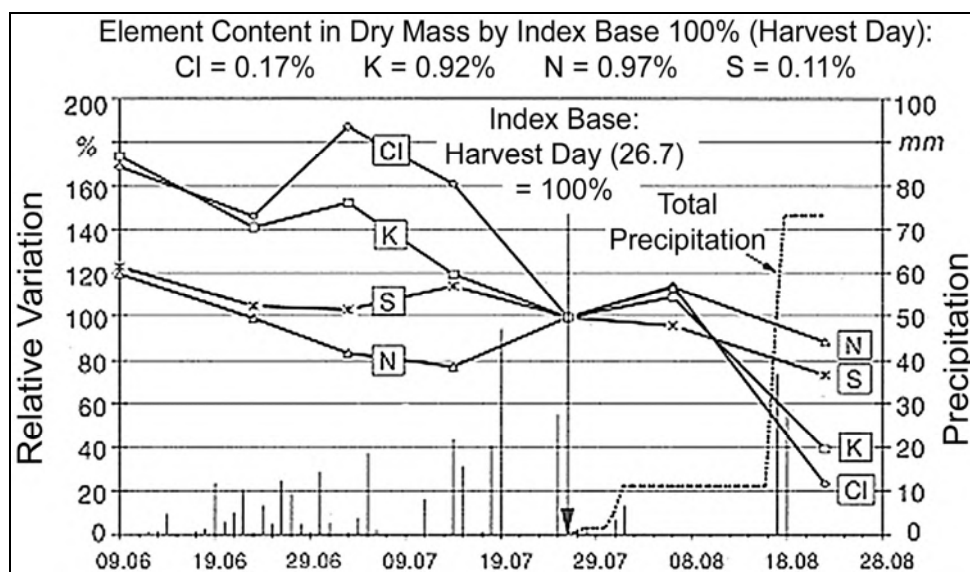

**Fig. 4.2:** Pyrolysis behaviours of difference biomass

Source: [11]

### 4.1.3 External factors

According to some studies e.g. [3], [5], [7] external factors such as chemicals used in the fields, harvest date or climatic factors such as precipitation play an important role in acquiring these differences (Fig. 4.3). This implies that appropriate agricultural practices could lead to better properties of biomass which lead to better planning and operation. However, this requires an optimization process between biomass’s main objectives such as food and the *secondary* objectives such as energy. In this direction energy crops are the best objects for such practices.



**Fig. 4.3:** Effect of rain fall intensity and harvest day on the chemical compositions of the plant

Source: [3]

## 4.2 Significance of tested fuel properties

The fuel properties of biomass could be affected by two groups of properties namely:

- Physical properties.
- Chemical properties.

The physical properties (volume, density, size distribution etc.) are related to *in – field* situations and could be (easily) modified e.g. by mechanical process [12], [13] while the chemical properties are inherent and permanent and show a relative great difficulty to be changed, hence it will be the focus of our interest. The identification of the chemical compositions takes place through carrying out Ultimate and Proximate Analysis which is the term assigned to the set of basic laboratory tests undertaken to determine the percentage of basic elements in the biomass mainly Carbon (C), Hydrogen (H), Nitrogen (N<sub>2</sub>) Sulphur (S) in addition to its calorific value, ash content, volatile material percent and moisture content. These sets of analysis gives to some extent a good overview over the tested material and act as a base for evaluation [1], [6], [7]. In the next section detailed information about the importance of each factor will be given. According to [7] the sum of these elements percent should follow the equation:

$$\text{Water} + \text{Ash} + \text{Carbon} + \text{Nitrogen} + \text{Oxygen} + \text{Hydrogen} = 1$$

### 4.2.1 Energy related properties

#### Calorific value (c.v.)

It is a direct measure for energy that can be generated from certain material after a complete thermal reaction; it is generally dimensioned as kJ/kg or kcal /kg. The higher the calorific value, the higher is heat energy generated. According to [7] the calorific value is intrinsic parameter of the material and it is related to its internal structure of the biomass so it is fixed and cannot be changed. This classification was also adopted by [4] [14], [15].

On the other hand calorific value is not a constant parameter but it is related (inversely proportional) to the moisture content prevailing at that point as seen in (Fig 4.4). In countries like Sudan due to dry climate one expects that biomass will have their highest possible calorific value. The calorific value at any moisture content can be found according to [13] through the following equation:

$$c.v_{.(w)} = \frac{c.v_{.(wf)}(100-w) - 2.44w}{100}$$

#### Where:

c.v<sub>.(w)</sub> = Calorific value (MJ/kg) at specific water content (w)

c.v<sub>.(wf)</sub> = Calorific value at water free basis (MJ/kg)

2.44 = Enthalpy of evaporation for water at 25°C (MJ/kg)

w = Water content of material (kg/kg)

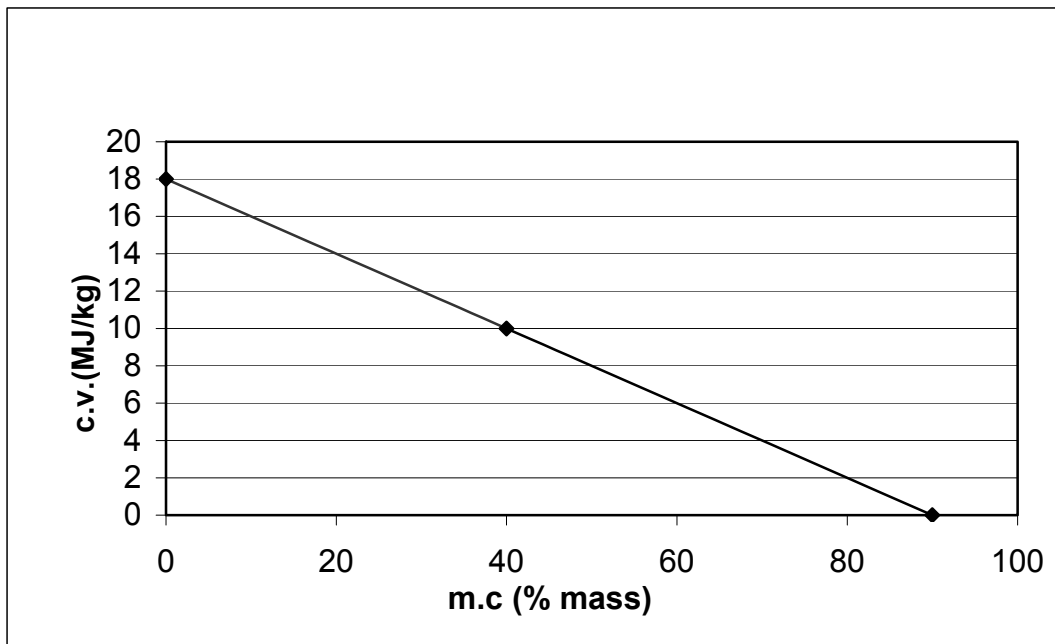

**Fig. 4.4: Calorific value in relation to moisture content**

**Moisture content (m.c.)**

It is a measure for the amount of water in the material recorded in (%) mass at that specific time. From the technical point of view, moisture content is considered as one of easiest to change parameters, however, the economical and the thermal efficiencies has to be weighted against each other. The degree of zero moisture is practically impossible. According to [1] [6], [7], [16] then water content is, beside calorific value, interconnected with the following fuel properties:

**Flame temperature**

Fuels with higher water content have generally relatively lower energy content; consequently the flame temperature for the same biomass is affected by the prevailing moisture content. As an example for this fact, [1] had mentioned that for a same material flame temperature of 2000°C could be attained at 10 % m.c. versus 1600 °C at 50 % m.c.

**Energy density and efficiency**

Energy density stands for the energy generated/unit volume at specific condition. In this context, water enlarges the volume, often hinders volume reduction process and so reduces the energy density. Water content is an indicator of the available energy (efficiency of the process). [1] claimed that the reduction of moisture content for a tested material from 70 % to 30 % requires 37 % of the available energy.

**Fuel storage and economics**

Water content is an important parameter to be considered when tackling issues as storing and transportation. Material with low water content does not encourage growth of fungi or other organisms. Another risk to be tackled with material of higher moisture content is the warming up of stored material which can even lead to self ignition (Fig. 4.5).

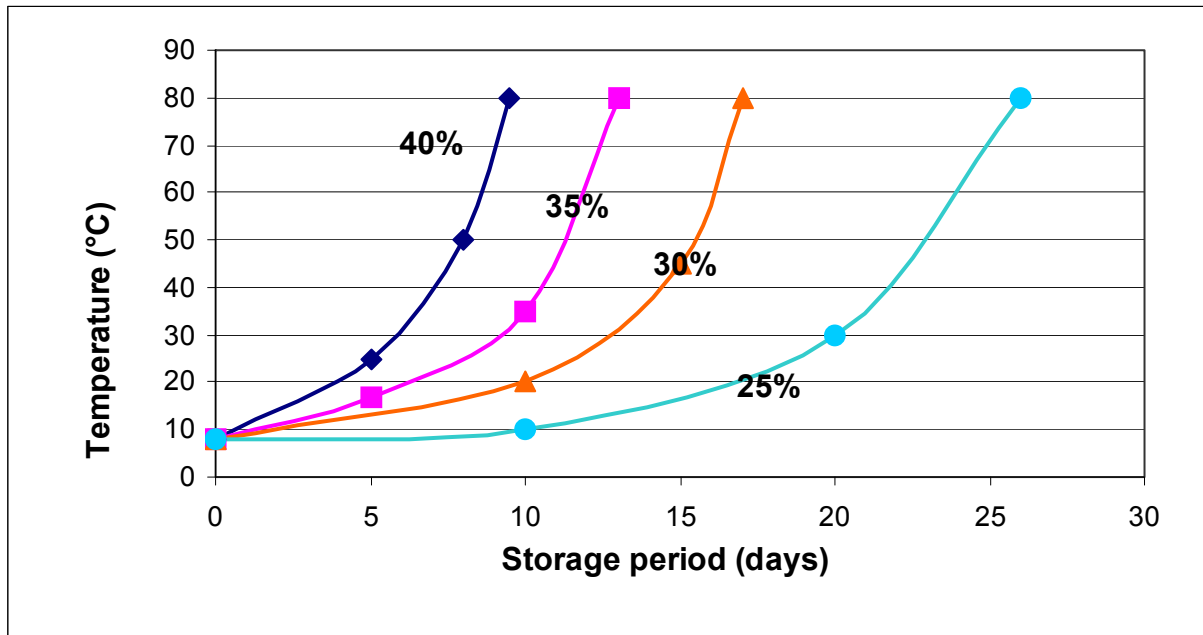

**Fig. 4.5: Possible storage period for biomass against moisture content**

Source: [12]

Reducing moisture content means that relatively lower storage precautions should be taken, on the same time it allows longer storage periods and relative higher energy density which implies relatively smaller storage volume, consequently lower storage cost. The same principle implies for transportation. On the other hand, for processes aiming at Hydrogen generation then high water content is positively considered, according to [17] biomass with higher moisture content is favoured to dry one as more Hydrogen can be produced from the reaction of water molecules in the following equation:

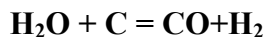

Another aspect is lowering tar content; it was mentioned in a study carried by [18] that an increase of m.c. from 10 % to 45 % may reduce tar content of the producer gas in fluidized gasification from 14 to 8 g/m<sup>3</sup>.

### Carbon Content

Carbon is a major thermal component in biomass; it reacts with Oxygen giving out energy. A rule of thumb is: materials with higher Carbon content has higher heating value. Generally wood due to its higher lignin content had higher Carbon content than biomass residues. The calorific value according to [1] is related to Carbon content on dry basis through this equation:

$$\text{c.v. (MJ)/ kg} = 0.4571 (\% \text{ C}) - 2.7$$

Materials with low Carbon content have lower ignition point as seen in table 4.2 [11], [19], [20].



**Table 4.2: Ignition point of some fuels**

<b>Material</b>	<b>Carbon content (% mass)</b>	<b>Ignition temperature (°C)</b>
Coke	>80	550-600
Coal	70-80	215-400
Wood	40-50	200-300

**Source:** [1], [20]

### **4.2.2 Non-energy related properties**

#### **Nitrogen content**

Wood and woody like biomass have lower Nitrogen content than Straw and crops residue, variations also exist between specific plant species, this could be referred to different reasons e.g. crops with more protein have more Nitrogen content [3], [13]. This could be due to the fact that these plants are rich in Rhizobium which fixes atmospheric Nitrogen in soil [21] so species like Groundnuts may show higher values. Alternatively some plants absorb chemical compounds more than others e.g. Millet which is known to be a soil exhauster plant then Nitrogen content in such plants is expected to be higher [22], [23].

Higher Nitrogen concentration is a negative indicator as it increases the percent of the poisonous compounds (Nitrous oxides( NO<sub>x</sub>)) in flue gases [24]. Additionally extra Oxygen will be needed for attaining equilibrium in the thermal reactions (Nitrogen oxidization). Alternatively non reacted Nitrogen constitutes high percent in the flue gas; both situations lower the efficiency of the process [1], [7], [9].

#### **Volatile components**

Biomass is generally more reactive than coal, being dominated by volatile matter (80:20) [10]. Volatile components percent is an indicator for the easiness of thermal reaction. The higher the volatile material content is the quicker is the reaction. Volatiles consist of wide spectrum; *they include favourable* substances which raise the process efficiency such as the different hydrocarbon radicals (C<sub>x</sub>H<sub>y</sub>) that are released at different temperatures and forms. On the other hand *problematic* materials such as Potassium (K) which is released at 750 °C could also be found [19],[6],[9], [25].

#### **Chlorine (Cl)**

Wood and forest biomass have lower Chlorine content than farm crops. Further Chlorine reacts with other elements producing corrosive compounds e.g. Alkali chlorides such as Potassium Chloride (KCl). Parallel it is one of the substances that are responsible for bed agglomerations in fluidized bed systems. A specific hazard is the catalyst effect of Chlorine in the Dioxin and Furan formation process [3], [26]. Like other chemical compounds their main effective domain is mainly the gas transport and utilization systems. It could be eliminated by simple measures such as water washing.

### **Sulphur & heavy metals**

#### **Sulphur**

Biomass compared to coal due to its nature of formation generally does not have high Sulphur content but some traces could be found as result of chemical interaction e.g. fertilizer used during cultivation or irrigation by polluted water. Agricultural residues have more Sulphur content compared to wood [1]. Similar to Nitrogen, Sulphur in biomass reacts with other elements producing compounds like SO<sub>x</sub> and Alkali Sulphates compounds which are directly related to the corrosiveness of the gases produced and the erosion process. Additionally waste material (tar, ash) can contain such hazardous compounds which hinder their handling and requires pre treatment before any further use [1], [4], [9]. [27], [28]. On the other hand [2] mentioned that Sulphur can reduce the formation of Dioxin and Furan.

#### **Heavy metals**

Heavy metals content such as Copper (Cu), lead (Pb) Chrome (Cr) are normally low in biomass compared to coal as seen in table 4.3. Wood has higher content compared to annual plants, this could be due to the fact that trees has more time to absorb these elements from soil enhanced by the higher acidic soil that usually prevail in forests [1], [13], [20]. Comparison values for some heavy metals in (mg/kg) was recorded by [1] the result shows: 3.5 Pb, 0.05 Hg, 135 Zn in needle trees bark compared to 0.05 Pb, 0.01Hg and 10 Zn in Wheat Straw. Generally higher percent of heavy metals is an indicator of polluted environment (acidic rain, improper agricultural chemicals).

**Table 4.3: Heavy metals in wood verses coal**

<b>Metal</b>	<b>Wood (mg/kg)</b>	<b>Coal (mg/kg)</b>
Lead	<0.5-5	25-200
Copper	<0.5-5	10-100
Chrome	<0.5-5	5-100

**Source: [20]**

## **4.3 Ash**

### **4.3.1 Definition**

Theoretically ash is generally defined as the inorganic, non-combustible components that remain after complete combustion has taken place [29]. Ash is not always waste, it (alone or mixed) can be used for different purposes e.g. soil conditioner, fertilizer or as input in industry e.g. concrete industry. Ultimately it could be upgraded into a valuable by-product [30], [31], [32], [33], [34].

Biomass ash compared to coal ash contains more benign (environmentally friendly) materials and has a lower melting point. Ash is on one hand an intrinsic property of the fuel which is governed by the percentages of Cl .K, N. S compounds of the biomass; however these elements are strongly related to the growing conditions (soil, fertilizer use etc). Moreover, it was mentioned in [3] as

## ***Fuel Properties of Agricultural Residues***

shown in (Fig. 4.6) that the date at which the analysis is made (No. of days after harvesting) has considerable effect on the results. It could be concluded that management factors could result in better ash properties.

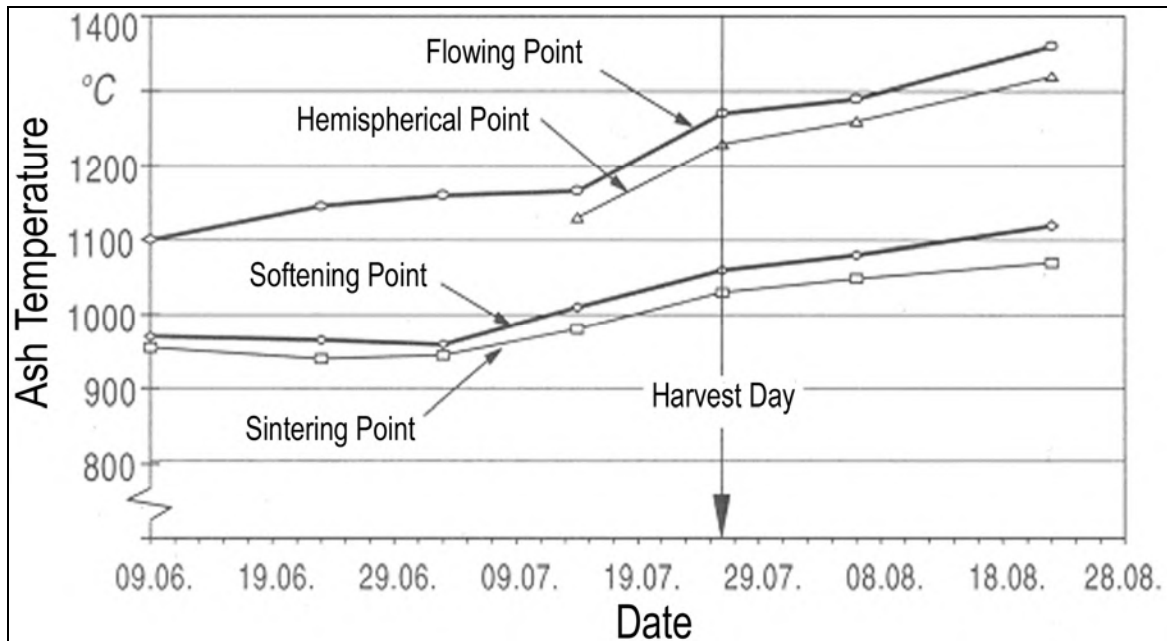

**Fig. 4.6: Ash properties in relation to harvest day**

**Source: [3]**

### **4.3.2 Ash analysis**

Evaluation of ash properties with respect to operational conditions and environmental measures in power plants requires investigation of three aspects. These aspects will be highlighted in the following section.

#### **4.3.2.1 Ash content**

The ash content of a material is related to technical and economical evaluation of that specific material. Technically; part of the fuel is worthless, i.e. it fill up part of the reactor volume and gives *useless* products. Further ash has to be removed; ash removal is a complicated issue which reduces the technical and economical efficiencies. Moreover, materials with high ash content are generally highly reactive .i.e. they burn up before the desired products are evolved. Economically; material with high ash content had lower energy density thereby storage and transportation costs will remarkably increase [2], [9], [35].

### 4.3.2.2 Ash melting behaviour

Ash melting behaviour could be understood through defining the temperature for consecutive states through which ash passes, namely sintering softening and flowing temperatures<sup>19</sup>. These states are critical since they are linked to phenomena such as agglomeration, slagging and fouling<sup>20</sup> that occur in pathways and heat exchanger and lead to clogging and corrosion. However, reactors equipped with slagging *type* ash removal mechanism could benefit from this criterion.

Further, small temperature difference between sintering and flow temperature is not preferred. The adverse effects of *low* ash melting temperature could be mitigated by different factors e.g. reactor's design or adding additives [26], [27], [36], [37]. In opposite to calorific value the ash melting temperatures is not a pure intrinsic property but it is claimed to be a result of compounds concentration [3], [26]. These compounds could be modified through in-field treatments and measures (Fig.4.3) and so pre control is possible.

### 4.3.3 Ash quality

The previous ash problems are also linked to ash quality which considers the chemical reaction of the different constituents of ash. The outcomes of these reactions are adversely affecting the technical and economical feasibilities of the power plant especially operation and waste management aspects [1] [39] [40]. On the other hand these problems are more severe in combustion rather than in gasification process [1]. This was explained in [26] by: gasification shows lower peak temperature than combustion. In the following section Alkaline and metallic compounds will be considered as examples for factors contributing to ash quality based on discussion given in [27], [26] [6], [1], [39], [9]. [38] [40].

#### 4.3.3.1 Alkaline material

Alkaline elements like Sodium (Na), Potassium (K), are found within the plant constituents. These elements react, in thermo-chemical process to form alkaline compounds which cause different problems e.g. the silicate cause slagging, the Sulphates, Chlorides lead to fouling and

---

<sup>19</sup> **Beginning of sintering (SIT):** describes a stage, where single ash particles stick together. Thereby by it changes its original dimension without showing further modification

**Beginning of softening (ST):** the sample shows the first signs of softening, e.g. surface changes, the rounding of the edges are complete and the sample starts filling out the gas volume between the particles

**Flowing point (FT):** Indicate the temperature where the sample's volume had shrunken to one third of its original height and begin to melts, eventually flow into liquid or slurry.

<sup>20</sup> **Agglomeration.** Particles gathered in a cluster.

**Slagging:** Deposits in molten or highly viscous state found in the flame section of the furnace.

**Fouling:** Deposits from materials that have vaporized then condensed in cooler regions of the furnace.

**Sintering:** formation of a coherent mass by heating without melting

**Clinkering:** A clinker is a solid residue formed by melting of minerals or through sintering

Source: <http://www.GrassBioenergy.org>, Bioenergy Information Sheet No.5 Cornell University, 13.09 2006

## ***Fuel Properties of Agricultural Residues***

---

corrosion while agglomeration could result from eutectics [37]. High amounts of Alkali metals and Chlorine present in the biomass lead to formation of Alkali salt-rich layers on the surface of the fly ash particles increasing their stickiness and therefore their tendency to deposit and create deposition and corrosion problems [39]. Gaseous Chlorine reacts to form corrosive HCl that can penetrate through metal oxide layer and react with iron and chromium present in the steel [27] while volatile potassium reacts with other plant constituents such as (Chlorine, Sulphur) and/or process steam/Oxygen in temperature range 800-1100°C forming KCl and KOH consequently K<sub>2</sub>SO<sub>4</sub> which is known for their corrosive effect.

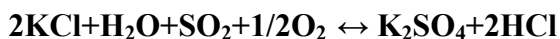

Furthermore, Alkali metals react with the Aluminosilicate particles of the fly ash to produce alkali and Alkali-calcium aluminosilicates with melting points that are well below the normal operating temperature (Eutectic). K<sub>2</sub>O 4SiO<sub>2</sub> mixed with CaO SiO<sub>2</sub> and Na produces eutectic with melting point up to 540 °C. These molten deposits are more problematic relative to solid substances due to its higher mobility [38], [42].

Potassium in many studies [9], [26], [27] is considered as the most effecting ash component, this is due to its abundance and reactivity in addition to its catalyst effect (it allows further release of alkali). Additionally Potassium is abundant in fly ash thus affecting further use of gas more than Mg and Al which are mostly retained in bed ashes. Potassium compounds content in fly ash (as Sulphates (K<sub>2</sub>SO<sub>4</sub>) and Chlorides (KCl)) are inversely proportional to the silicon content e.g. (Alkali Silicate) explained by the fact that silica capture potassium in bed ash.

In low temperature systems which are more similar to gasification [26] concluded that volatile Alkali species may either condense into pre-existing particles or surfaces or form new particles via nucleation thus causing fouling and agglomeration more than corrosion.

Several studies tried to identify the critical value of Alkaline content in biomass e.g. [15] mentioned that fuels having ratio (Na<sub>2</sub>O+K<sub>2</sub>O/SiO<sub>2</sub>) > 2 may cause fouling problems while [26] marked in their literature that (Na<sub>2</sub>O+K<sub>2</sub>O > 0.34 kg/GJ) will be problematic.

Formation of Alkaline compounds in thermal reactions is effected by many factors e.g. temperature and air fuel ratio. Additives, reactor design, fuel selection or simply washing by water are some of the mitigation measures for this problem [26], [27], [37], [43], [44].

### **4.3.3.2 Metallic compounds**

Metallic elements include elements such as Iron (Fe), Copper (Cu), Aluminium (Al) which are usually found as traces in biomass. However they react with other elements (mainly Oxygen) and so form different compounds which are retained mostly in bed ash which constitutes the bulk amount of ash in fixed bed systems. These compounds affect the further use of ash as fertiliser or

soil conditioner. Care must be taken when dumping such compounds in soil, on one hand they are useful for soil nutrition but on the other hand excess percent in soil could end up in different soil problems [34], [36].

### **4.4 Experimental results**

#### **4.4.1 Material tested**

Within the context of biomass as source of energy and for the purpose of evaluating the suitability of agricultural residues for thermal use, diverse types of agricultural residues and biomass were analyzed. As a whole they constitute 19 samples which cover 10 different types. The samples were mainly collected from Sudan, based on their availability in the study area and common local use as fuels. The analysis took place in TU- Dresden, KWT-laboratory at the *Institut für Energietechnik*. The detailed information about the tested material is displayed in table 4.4 while Appendix 1-B gives description of the nature of the Sudanese material.

#### **4.4.2 Methodology**

The following sections will highlight the consideration that was taken in carrying out this analysis, mainly sampling procedure, sample preparation and measurements techniques.

##### **Sampling techniques**

An arbitrary random sample was taken from fields as to resemble the real situation of thermal biomass use. Basic general information about origin, and cultivation conditions was collected from field. At the laboratory level the available sample amount were completely used.

##### **Sample preparation**

Samples were pre cleaned (foreign bodies' removal, sieving out soil) almost in a manual way, and then grounded. Material noted (R) were first grinded in small electrical (commercial) grinding shop in Sudan. The mitigation measures for contamination exclusion undertaken for samples prepared in Sudan include: primary grinding of *dispose off* amount (mill cleaning), collecting in sealed plastic bags and direct labelling.











Other samples were completely prepared in Germany, first grinded in the institute workshop using workshop-type grinding machine and finalized in the laboratory using laboratory-type grinding device. Samples were immediately collected in the designed laboratory containers.

##### **Testing procedure**

Different methods could be used for estimating biomass fuel properties like **ASTM, ISO, DIN**. Every method had its own short comes and merits. According to [5] deviation in results was apprehending for every method. Thus the selection of the specific method was mainly based on availability and experience. In this work DIN was used for three reasons: first the labour staff had

## Fuel Properties of Agricultural Residues

**Table 4.4: Material tested in KWT Laboratory**

Material	Latin <sup>21</sup> , English name	Origin	Material tested	Type of residue
	---- <b>Wood</b>	Germany	W.(1) <sup>1</sup> W.(2) <sup>3</sup>	Pieces
	<b>Straw</b>	Germany	St.PI <sup>3</sup>	Pellets
	<i>Miscanthus giganteus</i> China grass	Germany	Ch.grass <sup>3</sup>	
	<i>Arachis hypogaeae</i> <b>Groundnuts</b>	Sudan, China	GN.S (R) <sup>1</sup> GN.S (ch) <sup>2</sup> GN.S (H) <sup>2</sup>	Shells
	<i>Gossypium</i> <b>Cotton</b>	Sudan	Cotton <sup>2</sup>	Stalks
	<i>Saccharum</i> <b>Sugar cane</b>	Sudan	Baggasse <sup>2</sup>	
	<i>Sorghum bicolor</i> <b>Sorghum</b>	Sudan	Sghm(M) <sup>2</sup> Sghm (F) <sup>1</sup> Sghm( A) <sup>2</sup> Sghm (R) <sup>1</sup>	Stalks
	<i>Pennisetum glaucum</i> <b>Millet</b>	Sudan	Millet (A) <sup>2</sup> Millet (R) <sup>1</sup> Millet (H) <sup>2</sup>	Stalks
	<i>Sesamum indicum</i> <b>Sesame</b>	Sudan	Sesame (R) <sup>1</sup> Sesame (A) <sup>2</sup>	Stalks
	<i>Hibiscus sabdarifa</i> <b>Roselle</b>	Sudan	Roselle (R) <sup>1</sup>	Stalks

1. Natural plantation or limited use of chemical
2. Assumed wide use of Chemicals
3. No information

<sup>21</sup> latin names obtained from www.wikipedia.com [25]

## ***Fuel Properties of Agricultural Residues***

---

good experience with this method, secondly the available literature, thirdly to ensure research sustainability in future. The specific DIN tests undertaken could be revised at Appendix 4-A, the results overview in Appendix 4-B.

The detailed results obtained were modified to water free bases this was done through the equation.

$$PT_{wf} = P_{aw} / (100 - m.c) * 100$$

Where

$PT_{wf}$  = Parameter at water free basis

$PT_{aw}$  = parameter at analysis

m.c = moisture content of material at analysis

Calorific value was obtained using eq. in section 4.2.1

### **4.4.3 Analysis and discussion**

#### **4.4.3.1 Differences within the overall collected samples**

Variations in fuel properties were realized within the different samples. To verify these observations descriptive statistical analysis were undertaken. The mean, standard deviation (SD) and coefficient of variation (CV) were calculated and the results were tabulated as seen in table 4.5. It can be realized that some parameters like Nitrogen (N) shows greater variation than other parameters like calorific value (c.v.). These results show the need to differentiate between biomass types however, since the variation is mainly seen in *non energetic* parameters such as Nitrogen and Sulphur then main consideration within thermal uses of agricultural residues must be concentrated on effluent related issues such as gas usage and ash removal.

**Table 4.5: Variation indicators for some fuel properties of the tested samples**

<b>Parameter</b>	<b>Mean</b>	<b>SD</b>	<b>CV%</b>
<b>c.v.(kJ/kg)</b>	17294	972.	5.6
<b>C (% mass)</b>	47.	2.41	5.3
<b>N (% mass)</b>	0.78	0.42	54.3
<b>S (% mass)</b>	0.1	0.08	76.1
<b>Ash content (% mass)</b>	4.64	2.45	52.9
<b>MgO (% mass)</b>	7.86	4.28	54.5
<b>Na<sub>2</sub>O+K<sub>2</sub>O (% mass)</b>	6.62	4.89	73.9
<b>ST (°C)</b>	1020.	108.1	10.6

#### **4.4.3.2 Differences within the same specimen**

This section is concerned with summarizing the diversions of fuel properties within the same specimen as seen in table 4.6. The comparison was mainly concentrated on samples noted (R) collected from Kordufan region-western Sudan and (A) from Gadrif region in eastern Sudan. This selection was made as in the origin of these two samples the rain fed agriculture system is prevailing (Appendix 1-A) and so the irrigation factor could be eliminated. For Groundnuts, the



## ***Fuel Properties of Agricultural Residues***

comparison was carried between imported sample originating from china (ch) and local sample (R). A reference and limit value for wood chips and pellets based on the german standards was inserted to provide comparison. Brief explanations for sources of variation were suggested.

**Table 4.6: Differences within the same material**

<b>Material</b>	<b>c.v (kJ/kg)</b>	<b>S (% mass)</b>	<b>N (% mass)</b>	<b>Ash content (% mass)</b>	<b>ST (°C)</b>	<b>Na<sub>2</sub>O+K<sub>2</sub>O (% mass)</b>	<b>Si<sub>2</sub>O (% mass)</b>
Wood (1)	18700	0.02	0.49	0.3	1177	17.08	26.50
Wood (2)	18607	0.02	0.30	0.26	1092	16.04	13.03
Sorghum( R)	16264	0.15	0.71	5.33	926	20.21	56.27
Sorghum (A)	16530	0.1	0.77	7.3	836	37.85	41
Sesame (R)	16753	0.06	0.6	5.87	1059	17.98	57.18
Sesame (A)	16498	0.03	1.23	6.40	1019	70.84	2.02
Millet A	15988	0.07	0.66	7.20	917	17.08	60.5
Millet R	15899	0.30	1.70	8.50	991	25.74	49.9
GN.S (R)	18826	0.11	1.48	4.02	958	28.45	47.70
GN.S(ch)	18805	0.042	0.95	2.20	1070	32.8	28.25
<b>Reference value (Willow wood)</b>	18400**	0.08*	0.3* 1-2 % +	0.6**	1283**		

\* Limit value for wood pellets according to DIN 51731 [13]

\*\* Reference biomass combustion data [13]

+ Tolerable value for biomass combustion system (900 kW) [24]

R= Kordufan region-western Sudan

A= Gadrif Region .eastern Sudan

Ch= China

### **Wood**

In this work two samples originating from Saw mill in Bavaria (Germany). The mill used wood from near by forest. The two samples were delivered in 2005 and 2006 respectively. Wood samples show relatively consistent results especially for calorific value which lies within the acceptable range found in literature 19.2 -18.4 MJ/kg. Nitrogen values are found consistent within the two samples but are higher than the reference value while the Sulphur is significantly lower than the limit. The softening temperature is slightly lower than the reference values this could be due to higher Alkali content found. The difference in SiO<sub>2</sub> content could be explained by post harvest operations [40].

### **Sorghum, Millet & Sesame**

The residues (stalks) of these three crops where tested. Two different samples were analyzed one from western Sudan (relatively poor sandy soil). The sample is from eastern Sudan (rich, silty soil). Although some consistency are realized in relation to calorific value, ash softening temperature and ash content but relatively great differences could be found in relation to Sulphur and Nitrogen

## ***Fuel Properties of Agricultural Residues***

---

content. This could be referred to differences in variety cultivated e.g. red Sesame in western Sudan and white Sesame in the east. Extra, the nutrient availability in the soil is also a determining factor in attaining such differences [3]. As the two soils had different characteristic then this explanation could be adopted. Consequently Silicon percent is higher in material suffixed (R) as these originate from sandy soil (western Sudan).

### **Ground nuts**

Two types were investigated here; one type was from western Sudan, the other from China. The Chinese type was characterized by harder and larger shell than the Sudanese one. The differences in shell appearance show the effect of field conditions on plant. The main difference is by the Silicon content; this could be due to the referred to soil factor as the sample originate from sandy soil.

#### **4.4.3.3 Different between groups**

Selected samples were analysed based on practical possibility for thermal use in Sudan. The analysis is done compared to the tested wood and with respect to some parameters chosen based on their influence on their utilization in power plants [45]. Thus this section is like the former one, adopts pragmatic analysis scheme which is based on the importance of the parameters and availability of results.

### **Wood**

Wood shows as expected high calorific value, low ash content accompanied with relatively low Sulphur and Nitrogen content. The high percent of Potassium and Sodium can be the result of external factors (soil and chemicals used) yet the limit recommended by [15] is satisfied.<sup>22</sup>

### **Groundnuts shells**

As seen from table 4.7 then Groundnuts shells (GN.S) (R) show relatively equal calorific value compared to wood, 18826 to 18700 kJ/kg. This can be explained by high lignin content (see section 4.1). Also as oil producing crop some oil traces could be found in shells. The shells had lower ash content 4.02 % compared to some other agricultural residues like Millet (8.5) or Sorghum ( 5.3).

Nitrogen shows relatively high value due to its nature as Nitrogen fixing plant [21] while for Sulphur it shows a low value of 0.1 The relatively softening temperature of ~1100 °C enhance its use but the percent of Alkali (Na, K) is considerably greater than wood which require special care with ash issue. Generally Groundnuts shells could be accepted for further thermal uses.

### **Straw pellet**

Straw are hemicellulose and different studies show it is very reactive, its ash content is relatively high and the heating value is lower than other residues e.g. ground nuts and Baggase. Additionally

---

<sup>22</sup> If  $N_{a_2O}+K_2O/SiO > 2$  then fouling could occur  
If  $N_{a_2O}+K_2O/SiO < 2$  then erosion could occur

## ***Fuel Properties of Agricultural Residues***

it had relatively high Sulphur content and the softening temperature is as low as 851 °C only. Straw could be considered as problematic fuel.

**Table 4.7: Fuel properties for some selected material**

<b>Material</b>	<b>c.v. ( kJ/kg)</b>	<b>S (% mass)</b>	<b>N (% mass)</b>	<b>Ash content (% mass)</b>	<b>ST (°C)</b>	<b>Na<sub>2</sub>O+K<sub>2</sub>O (% mass)</b>	<b>SiO<sub>2</sub> (% mass)</b>
Wood (1)	18700	0.02	0.49	0.3	1177	17.08	26.50
St.Pl	17289	0.18	0.6	5.4	851	37.87	45.27
GN.S (R)	18826	0.11	1.48	4.02	1070	28.45	47.7
Baggase	17818	0.02	0.24	2.3	1128	8.16	64.71
Roselle	16515	0.19	0.71	3.56	1035	25.41	19.46
Sorghum (R)	16264	0.155	0.71	5.33	926	20.21	56.27
Millet (R)	15899	0.3	1.7	8.5	991	25.74	49.9

**Table 4.8: Critical ash indicators**

<b>Material</b>	<b>ST (°C)</b>	<b>FT (°C)</b>	<b>Na<sub>2</sub>O+K<sub>2</sub>O/SiO<sub>2</sub> (% mass)</b>
Wood (1)	1177	1413	0.65
St.Pl	851	1122	0.85
GN.S (R)	1070	1148	0.60
Baggase	1128	1260	0.13
Roselle	1035	1413	1.30
Sorghum (R)	926	1171	0.36
Millet(R)	991	1195	0.51

### **Millet stalks**

Millet is traditionally considered as bad fuel, the analysis proved this as the tested sample shows low calorific value and high ash content. Further, relative high percent of Nitrogen and Sulphur which could generate emission problems were recorded. This could be explained by the *soil exhausting* nature of Millet [22]. The existence of gypsums layer in wide areas of Kordufan region (material origin) could also contribute to this value. Additionally to its high ash content, Millet has low softening temperature thus efficient ash removal mechanism should be added to system and larger fuel storing capacity should be available. Remarkably it shows high content of Silica which could leads to erosion problems [15]. This could be explained by the sandy soil in which it grows, this explanation adopts what [5] claims about the existence of Silicon in plant cell wall as crystalline Silica.

From the technical point of view Millet can hardly be used as fuel.

### **Sorghum**

Sorghum shows relatively better fuel properties compared to Millet e.g. with respect to calorific value, also the Sulphur and Nitrogen are remarkably lower. On the other hand, low softening temperature (for both) was recorded which, in spite of the relatively low ash content, hinders its use

## ***Fuel Properties of Agricultural Residues***

---

in closed burners or gasifiers. It could be concluded that in practical operation conditions then regardless that Sorghum shows relatively higher materialistic availability in Sudan but its utilization in thermal systems is not recommended.

### **Baggase**

The ash content of sugar cane found to be consistence with the international standard 2 % [40]. Baggase shows lower heating value than wood and ground nuts but lower value of Nitrogen and Alkaline material (Na, K) accompanied by high melting point. The main problem with Baggase is Silicon content. According to [40], [41] this high content is influenced by the harvesting method practiced and could be relatively easily mitigated. The pervious experience of Baggase combustion in the sugar factories strengths the recommendation of considering Baggase as very suitable fuel.

### **Roselle stalks**

Roselle has relatively low c.v. but also relative low ash content. It has high softening and flow temperatures. With respect to Nitrogen, Sulphur and Alkali it lies within the middle value between wood, Groundnuts shells in one side and Straw and Millet on the other side. Roselle is not generally used as fuel but it can be used as fuel under the consideration of energy density and ash problem.

## **4.5 Conclusions**

### **Main findings**

- Fuel properties are inter-dependent and modifiable, thus required properties could be obtained. Agricultural residues could be treated as industrial energy source.
- Functional evaluation of biomass fuel characteristics should be comprehensive; the selection should follow comparative merit criteria.
- The effect of external factors such as soil and climatic condition were obviously recognized among the Sudanese products.
- Sudanese products compared to wood have relatively good heating value but show critical values with respect to some problematic factors e.g. ash content, Nitrogen and Sulphur.
- Within the sudanese agricultural residues; Baggase shows good fuel properties followed by Groundnuts shells , Roselle could also be considered for thermal use.

### **Information gaps**

- Biomass fuel properties with special reference to gasification at one piece level.
- Predictable, reliable relationships between soil, cultivar, external factors and fuel properties.

### **Further work**

Gasification of selected material fuel in 75 kW fixed bed, down-draft gasifier.

## 5 Experiments for Gasification of Agricultural Residues

The objectives of this chapter are to:

- Test the possibility of gasifying agricultural residues mainly Groundnuts shells.
- Quantify the main products of this process.
- Make the process more transparent by analyzing the factors governing it.

The contents of this chapter will cover the following points:

- Equipment, materials and procedures that were used during the experimental work.
- Summary of experimental results.
- Analysis and discussion for selected results.

The conclusion aims to evaluate the possibility of gasifying agriculture residues.

### 5.1 Introduction

For the sake of this work **Gasification** can be defined as the thermal reaction of biomass that takes place with limited amount of air. Gasification could be simply referred to as incomplete combustion of fuel to produce burnable gas commonly known as *producer gas* (PG). Although different gasification systems exist however this set of experiments were carried out in a down draft fixed bed gasifier as such structure had the merits of being simple to fabricate and operate. Furthermore downdraft system has the merit of producing relatively clean gas (minimum tar content). This favours its application for electricity production. (see Ch. 3).

The main gasification products that will be considered here are:

**Producer gas:** It is the main required product in this work (for further use in electricity generation). It is a combination of different gases mainly CO, H<sub>2</sub> and CH<sub>4</sub> with a theoretical calorific value of about 3–6 MJ/Nm<sup>3</sup>.

**Tar.** It is non reacted pyrolysis products as well as evaporated organic components from raw fuel and their combinations. Tar quantity and types are important factors when considering the further use of gas. High tar content tends also to reduce the thermal efficiency of the process.

**Particulate (dust):** It is collective term which includes dust particles from surrounding air, fly ash and non-reacted biomass particles that could be found in gas. Analogous to tar, dust quantity is a limiting factor for further use of gas.

**Ash and Char:** Ash results as product of complete thermal reaction and it is considered as *valuable* waste so it is highly related to the sustainability and economics of the process (see Ch.3 and 4).

Char is not fully reacted biomass found with ash (charcoal). It could be differentiated from ash by its relatively high calorific value. Its quality and quantity also affects the gasification process.

### **5.2 Test gasifier**

This section gives brief description of the main equipment and measurement techniques-used during conducting these set of experiments. Main references used in this context are [1], [2], [3].

#### **5.2.1 Reactor**

The test gasifier (**IGEL**) (Fig. 5.1) was located in the test hall of *Institut für Energietechnik TU- Dresden*. It is 75 kW- downdraft gasifier designed for gasification of wood pieces 30-50 mm length with a maximum moisture content of 30-35 %. The gasification medium was slightly pressurised air. Air was soaked from the surrounding atmosphere, passed through a compressor and then introduced to the gasifier. Compression was a requirement for the continuity of the gasification process, as it insures that the reactor would be operating under (negative pressure) condition. This prevented gas leakage and ensured fluent suction of air. A separate metering system had allowed the control of air input into the gasifier. Previous experience showed that IGEL had worked successfully between 6 and 14 m<sup>3</sup>/hr i.e. it is has a turn down ratio of 2.3:1.

Structurally the IGEL gasifier is composed of three sections in cylindrical form. At the top the feeding and transfer section with length 750 mm followed by the gasification section with length 1000 mm. The ash disposal section is found at the bottom with length of 780 mm. The gasifier has total height of 5.2 m above ground while it has a maximum radius of 0.8 m (Fig. 5.1).

The feeding system was manual; in which fuel loads had to be fed at the top, two slide gates, which open one after another, acted as control for overload. Ignition was done through gas igniters at a specific ignition point at *Schuss 3*. The gasifier was equipped with computerized ash removal system (that can be also manually controlled). The system composed of conical cylinder through which ash passes into a collector. The condensing water from the different gasification process flew down by gravity, collected in a double slide water-gate then passed to waste water outlet.

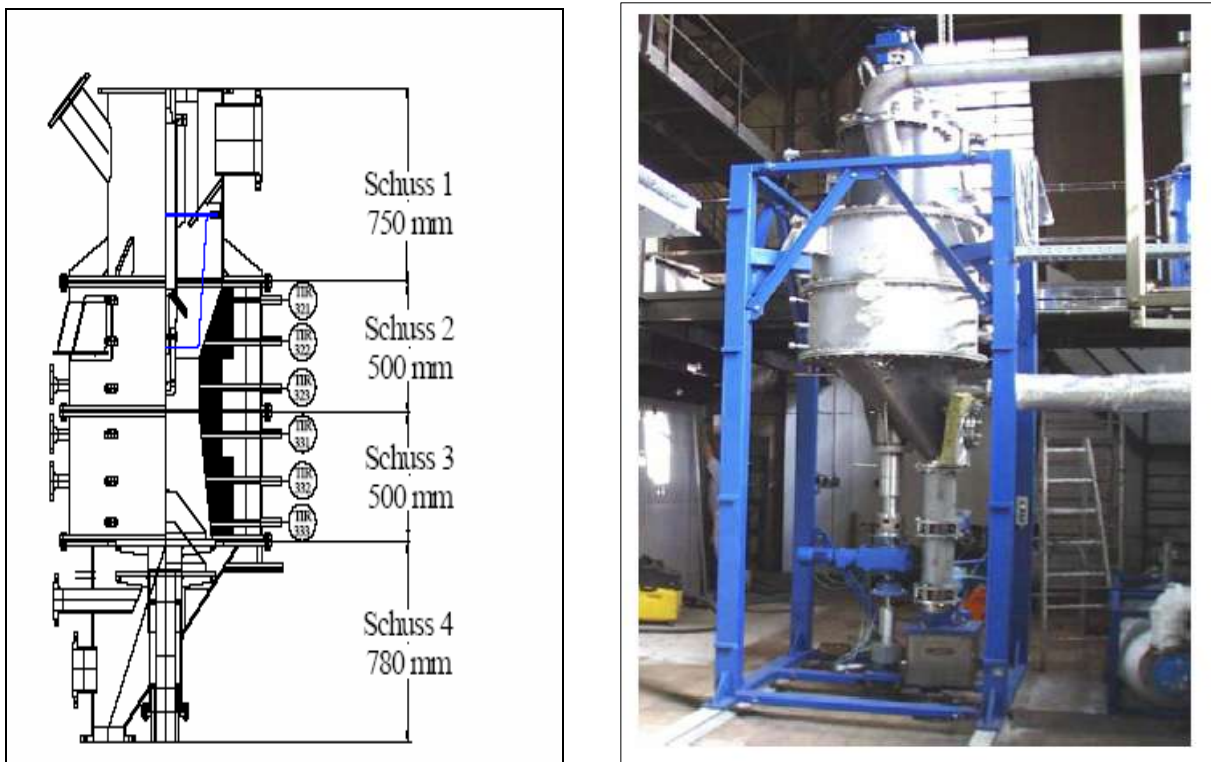

**Fig. 5.1: Fest bed-downdraft gasifier, 75 kW at TU-Dresden (IGEL)**

**Source [1]**

The producer gas was then filtered and passed to online measuring system connected to a data logger. At the end it was derived into a closed combustion chamber where it was mixed with natural gas and burned. This process was done as safety measure for insuring elimination of gas in the working atmosphere. As an alarm measure two functions were installed.

- Automatic control for natural gas flow in such a way that was *turned on* whenever the temperature of the burner went below a selected value.
- If for any reason the natural gas flow failed then air inlet to gasifier will be *turned off* and the gasification process will consequently stop.

### **5.2.2 Measurement systems**

#### **Gas properties**

The gasifier was equipped with different metering sensors which were linked through a computerized system (software Siemens S7 with 265 Power tags) to a data logger that allows the metered parameters to be displayed and saved in an excel sheet form (Fig 5.2 a). Thus the following parameters could be measured:

- Concentration of producer gas constituents** namely: CO, CO<sub>2</sub>, H<sub>2</sub>, CH<sub>4</sub> in addition to O<sub>2</sub> in (Vol. %). Table 5.1 shows typical gas components with their concentrations for wood chips gasified

## Experiments for Gasification of Agricultural Residues

in the IGEL gasifier. Each gas concentration was measured using special sensor fitted into a gas analyser as shown in table 5.2.

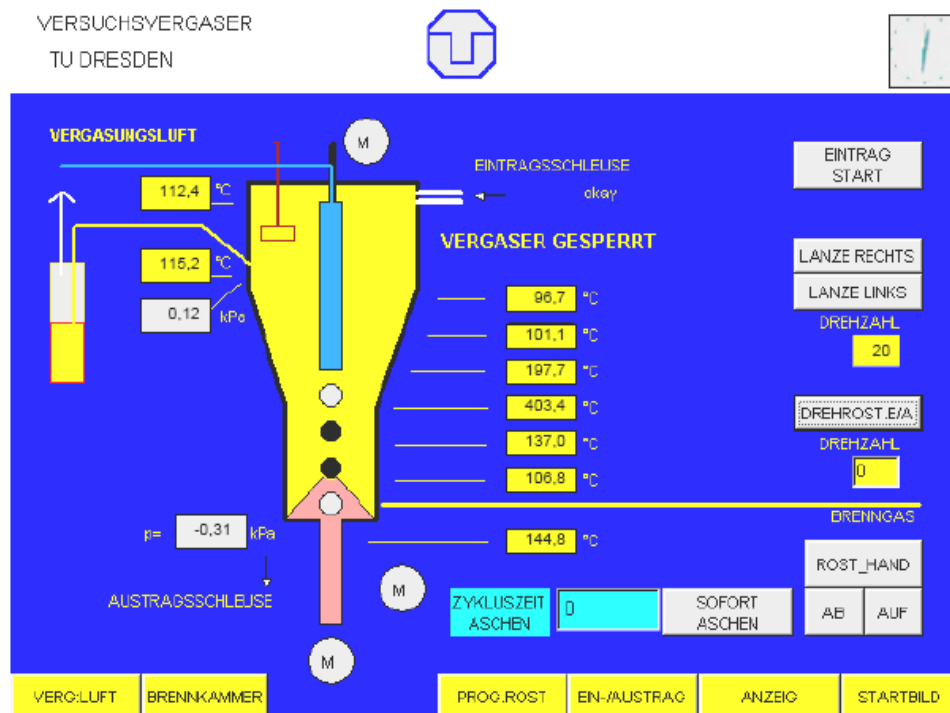

Fig. 5.2a: Measurement software interface

Source [1]

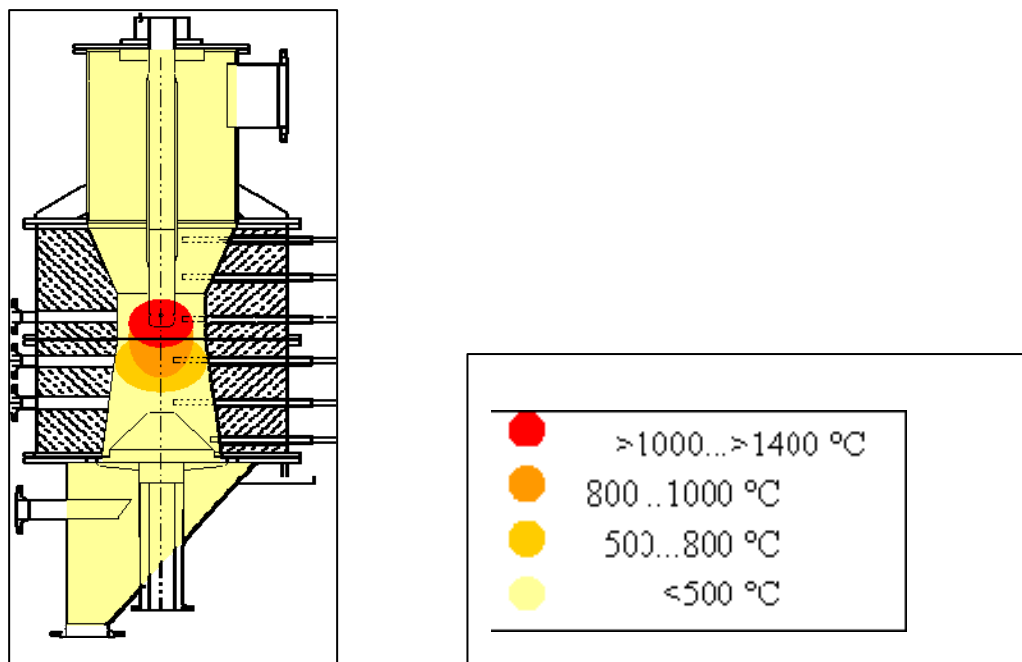

Fig. 5.2b: Temperature distribution in IGEL

Source: [4]



**Table 5.1: Typical producer gas constituents (IGEL)**

	Component	Concentration ( $C_i$ in Vol.%)	Remarks
1	CO	22	
2	CO <sub>2</sub>	12	
3	H <sub>2</sub>	10	
4	CH <sub>4</sub>	4	
5	O <sub>2</sub>	(2)	leakage
6	Water	10	assumed
7	Nitrogen	40-42	$100 - \sum_1^6 C_i$
	Sum	100 %	

**Table 5.2: Reading range and sensors used for different gas constituents**

PG constituent	Range (Vol. %)	Sensor used
CO	0-30	Infrared activity
CO <sub>2</sub>	0-30	Infrared activity
H <sub>2</sub>	0-30	Thermal conductivity
Ch <sub>4</sub>	0-30	Infrared activity
O <sub>2</sub>	0-25	Magnetic susceptibility

- ii. **Temperature:** The system could display the gasifier temperature at 4 different stages (*schusses*) as shown in (Fig. 5.2b) in addition to the temperature of the combustion chamber. The measuring system includes different types of thermo couples which were capable of measuring the temperature range of 0-2000°C as seen in table 5.3.

**Table 5.3: Thermo-couples used**

Temperature (°C)	Thermo-couples used	Existing zone
1000	NiCrNi	Pyrolysis
1000-1600	PtRh	Reduction
1000-2000	Tantal with isolation material Yttrium oxide	Hearth

**Flow rate & pressure:** The air flow rate was detected in range 0-20 m<sup>3</sup>/hr by using a built-in flow meter. The pressure was hence automatically recorded through built-in pressure meter. Both values were simultaneously explicitly recorded through the computer interface.

For recording the producer gas flow rate an external manometer and orifice system was used as seen Appendix 5.A. The system was connected to gasifier at specific time points. The calculation is done through an excel program (provided at the institute). A material properties program enables the recording of the gas density at specific temperature and pressure.

### **Tar & dust measurement**

The tar and dust collection-measurement system that was used in this work had been developed and tested in the institute by [2]. It measures collected tar and dust in producer gas based on their condensation and gravimetric properties. The main criteria for selecting this system in this work were:

- Efficient collection of tar.
- Applicability for different fuels and gasifier conditions.
- Ease of construction & use.
- Possibility of storing and transporting collected material.
- Low cost.

The system is composed of an aluminium cylinder 100 mm length and 230 mm diameter with two screws lids at both ends. Plastic pipes from the gasifier to the cylinder and out of the cylinder to the pump were connected at both ends of the lids (Fig. 5.3). The size of the cylinder is designed so as a commercial cellulose test tube (*Hülse*) could pass in easily. At the collection point, the tubes were placed in an ice bath, connecting pipes fitted and ends closed. Gas from the gasifier was allowed to flow in the tube (through by pass) in direction of the round end (Kallote). Then the gas was passed through 3 washing flasks for condensation, followed by drying column (CaCl). Finally the cold gas passed through the pump and disposed to atmosphere. The pump was used to suck the gas from the gasifier and to allow for determining of the gas flow rate through internal flow meter. In general the pump was allowed to work for 3 minutes. As a final step, the tube (full of tar and dust) was removed, saved in an aluminium foil and send to the laboratory for further investigation. The laboratory methodology will be highlighted in a later section.

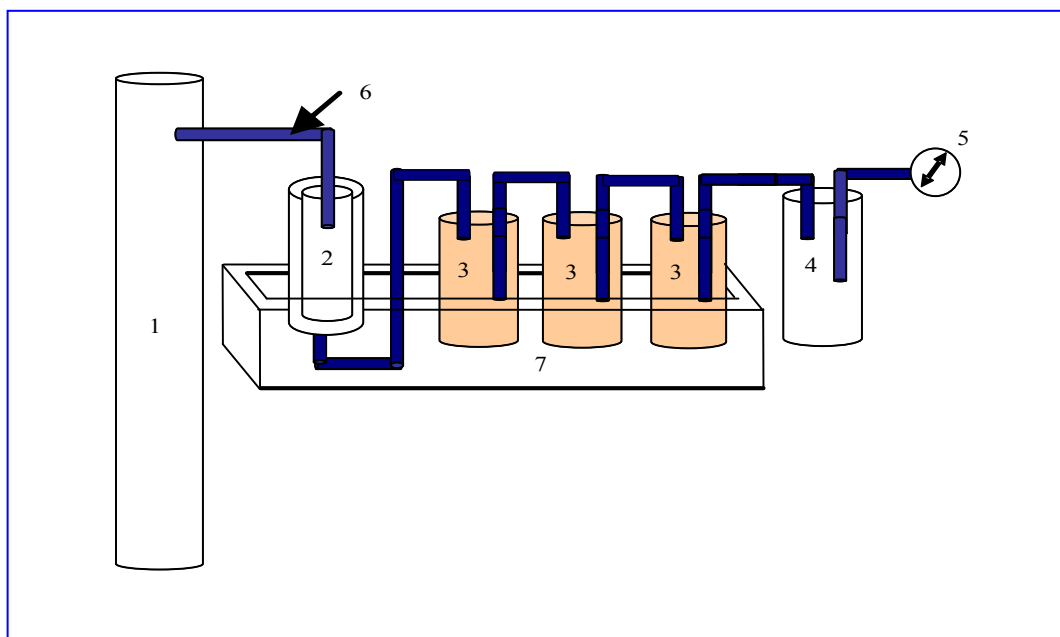

**Fig. 5.3: Tar collection system**

*1=gasifier, 2=tar collecting tube, 3=washing flasks, 4=drying tower, 5= pump, 6= gas tubes, 7= ice bath*

## **5.3 Experiments procedure**

### **5.3.1 Objective**

These set of experiments were designed and conducted as continuation to the analysis work done on chapter 4 for identifying the fuel properties. The main aim of the whole laboratorial work was to obtain basic information (indicators) concerning agricultural residues gasification behaviour. Theses indicators are the starting point for further research aiming towards developing industrial gasifier.

### **5.3.2 Selection and preparation of material**

#### **Groundnuts shells**

##### **Selection**

It was selected based on its availability in the study area (see Ch.1, Ch.2) and its suitable fuel properties (Ch. 4). Experience about thermal utilization of Groundnuts shells (mass production of charcoal) were recorded in Sudan and Senegal [4], [5]. Further, it was also tested for different thermo chemical process. [6] [7]

##### **Preparation**

Groundnuts were manually shelled, part of it was grinded. For preparing one volume unit for test, 50 % raw shells with 0.8 kg/volume unit and 50 % grounded shells with 1.6 kg/volume unit were mixed together. The final mixture is 1.2 kg/volume unit. Another mix of the above mix and

## *Experiments for Gasification of Agricultural Residues*

wood in the ratio of 50:50 and 75:25 was also prepared. Table 5.4 shows the combinations used with their masses.

**Table 5.4: Groundnuts shells combination**

<b>Material</b>	<b>GN.S (Raw)</b>	<b>GN.S (Powder)</b>	<b>GN.S (100 %)</b>	<b>Wood</b>	<b>Mix (50:50)</b>	<b>Mix (75:25)</b>
<b>Mass /volume unit* (kg)</b>	0.8	1.6	1.2	1.6	1.4	1.3

\* volume unit= bucket used for feeding the fuel during the experiment ~ 10 liter

### **Straw pellets**

#### **Selection**

Straw is one of the most common agricultural residues all over the world. In these experiments Wheat Straw, due to its availability in Germany, was used as representative for other Straw types. Straw as (cheap) fuel, in spite of its critical fuel properties, was a focus of research at different institutes e.g. a research project to investigate the optimality of Straw to produce liquid fuels through pyrolysis is taking place [8] Straw pellets were successfully gasified in two stage gasifier [9].

#### **Preparation**

The Straw that was used in this experiment was pelletized in the size of 10-20mm length and 50 mm diameter with a bulk density of ~530 kg/m<sup>3</sup>. According to the delivery specification no external material as binding agent was used. During the experiments it was used in its raw state and mixed with wood as seen in table 5.5.

**Table 5.5: Straw pellets combinations**

<b>Material</b>	<b>Straw pellets</b>	<b>Wood</b>	<b>50:50</b>
<b>Mass/volume unit* (kg)</b>	5.5	1.6	3.5

\* volume unit= bucket used for feeding the fuel during the experiment ~ 10 liter

### **Miscanthus**

#### **Selection**

It is kind of wild grass that can reach till 4m length known also as China grass [10]. It originates from Asia but found in different countries. It was selected as an example of *good* non-wood fuels. Miscanthus was used in different research e.g. it was successfully gasified in PFB [11].

#### **Preparation**

Miscanthus was delivered in relatively small pieces with length of about 20-40mm. It was tested as its current state, no further measures was undertaken.

### **Wood**

#### **Selection**





Wood as the classical example of biomass was used in this work as reference for comparing the other material concerning their gasification properties.

**Preparation** wood was delivered in small pieces form (*hackschnitzel*). According to the delivery specification it is assumed to be collected from natural forest and delivered without any addition of chemicals. Table 5.6 summaries selected physical and energetic properties of the tested material.

#### **Carry out of the experiment**

The experiment started by heating up the gasifier. This is done by feeding on around 30-40 kg of wood chips to the gasifier. After ignition a short time was allowed then specific feeding (usually at 3-5 minutes intervals) had started. Simultaneously air input was adjusted (generally at 12-14 m<sup>3</sup>/hr) until stabilization was reached (gasifier indicator on the computer interface display full sign, temperature reached ~300 °C and gas analyzer showed acceptable values, 3-4 hr). At this point the air intake had been adjusted again to the desired rate followed by gasifier feeding according to the experiment requirements.

**Table 5.6: Selected physical and energetic properties of the tested materials**

	Groundnuts shells	Miscanthus	Straw pellets	Wood
				
Density(kg/m <sup>3</sup> )	40.3	71.4	527	99
Size* (mm)	20-40*10	30-50*10	10-20*(5)	30-50*10-20
Calorific value (MJ/kg)**	18.8	18.1	17.3	17.7
Energy density (MJ/m <sup>3</sup> )	758	1292	9117	1752

\* Length x width (diameter)

\*\* at water free basis

### 5.3.3 Experimental results

#### 5.3.3.1 Producer gas production and process efficiency

This section shows the main results of the carried experiment. These experiments were carried out after heating the gasifier with wood as previously described. A summary of results will be displayed in tables 5.7-5.10. The following formulae and equations were used for further calculations of the needed values.

#### i) Formulae & equations used

##### 1) Producer gas calorific value(MJ/Nm<sup>3</sup>) :

$$cv_g = 1.2 \times 0.089 \times H_2 + 0.5001 \times 0.718 \times CH_4 + 0.1011 \times 1.251 \times CO$$

##### 2) Equivalence ratio

$$n = \frac{L_a}{L_{\min}}$$

##### 3) Hot gas efficiency

$$\eta_h = \frac{c.v._g \times \dot{V}_g + (\dot{V}_g \times C_p \times \rho_g \times \Delta T)}{\dot{m}_f \times cv_f}$$

##### 4) Cold gasifier efficiency

$$\eta_c = \frac{cv_g \times \dot{V}_g}{\dot{m}_f \times cv_f}$$

#### Where:

$\dot{V}_a$  = air flow rate (kg/hr)

$\eta_h$  = hot efficiency

$\dot{V}_g$  = gas volume flow rate (Nm<sup>3</sup>/hr)

$L_a$  = actual air requirement (kg air/kg fuel)

$c.v._f$  = solid fuel calorific value (MJ/kg)

$c.v._g$  = producer gas calorific value (MJ/Nm<sup>3</sup>)

$C_p$  = specific gas capacity (kJ/kg K)

$\dot{m}_f$  = fuel mass flow rate (kg/hr)

$n$  = equivalence ratio

$L_{\min}$  = minimum air requirement (kg air/kg fuel)

$\Delta T$  = temperature difference (K)

$\rho_g$  = gas density(kg/m<sup>3</sup>)

$\eta_c$  = cold efficiency

## Experiments for Gasification of Agricultural Residues

### Experiment 1

This was primary experiment to test suitability of Groundnuts gasification. Miscanthus (m.c.~10 %) was also tested. After stabilization the gasifier was loaded by wood for (~2 hr) followed by Miscanthus (~2 hr) then GN.S (~2 hr). At this experiment the GN.S was tested as its raw conditions (without mixing with grounded fraction).

**Table 5.7: Average results of experiment 1**

Parameter	Wood	Ch. grass	GN.S
Air volume flowrate ( $\dot{V}_a$ )	10.2	10.1	7.8
Fuel mass flowrate ( $\dot{m}_f$ )	12.8	11.2	9.6
Burnable gas concentration $V_b$ (% Vol.)*	34	31	22
Gas calorific value( $c.v_g$ )	4.8	4.5	3.4
Equivalence ratio ( $n$ )	0.20	0.23	0.20

\* Sum of CH<sub>4</sub>, H<sub>2</sub>, and CO

### Experiment 2

This was an experiment to study Straw pellet (m.c.~ 8.3 %) performance. Wood (m.c.~ 11.8 %) was first loaded. After reaching stabilization Straw pellet was fed in mix form (~1:15 hr) then in pure form (~1 hr).

**Table 5.8: Average results of experiment 2**

Parameter	St.Pl 50:50	St.Pl.(100 %)
Air volume flowrate ( $\dot{V}_a$ )	11	10.5
Fuel mass flowrate ( $\dot{m}_f$ )	19	11
Burnable gas concentration $V_b$ (% Vol.)*	32	27
Gas calorific value( $c.v_g$ )	4.5	3.8
Equivalence ratio ( $n$ )	0.15	0.25

\* Sum of CH<sub>4</sub>, H<sub>2</sub>, and CO

\*\* based on pervious analysis



## Experiments for Gasification of Agricultural Residues

### Experiment 3

This was an experiment to ensure the suitability of GN.S (m.c.~ 9.8 %) for gasification. For better optimisation of energy density and volume efficiency, 3 different combinations (section 5.3.2).of GN.S (50:50), (75:50), (100 %) were used for (~2 hr), (~1:30 hr) and (~1:40 hr) respectively.

**Table 5.9: Average results of experiment 3**

Parameter	50:50	75:50	GN.S (100 %)
Air volume flowrate ( $\dot{V}_a$ )	12	9.6	6.1
Fuel mass flowrate ( $\dot{m}_f$ )	10.7	9.7	10
Burnable gas concentration $V_b$ (% Vol.)*	31	27	25
Gas calorific value ( <i>c.v.g</i> )	3.3	3.2	3.6
Equivalence ratio ( <i>n</i> )	0.28	0.24	0.15

\* Sum of CH<sub>4</sub>, H<sub>2</sub>, and CO

### Experiment 4

This was an experiment using GN.S (m.c.~10.3 %); the same procedure was repeated but for (~1:30 hr), (~1:30 hr) and (~2 hr) respectively. Furthermore, care was taken to optimize the air and fuel flow rate.

**Table 5.10: Average results of experiment 4**

Parameter	50:50	75:50	GN.S (100 %)
Air volume flow rate ( $\dot{V}_a$ )	10.2	8.4	8.2
Fuel mass flow rate ( $\dot{m}_f$ )	11.2	10.4	9.6
Burnable gas concentration $V_b$ (% Vol.)*	27	25	29
Gas calorific value ( <i>c.v.g</i> )	4.1	3.4	4.1
Equivalence ratio ( <i>n</i> )	0.22	0.20	0.21

\* Sum of CH<sub>4</sub>, H<sub>2</sub>, and CO

### Efficiency and gas extraction rate

The hot and cold gas efficiencies were extra determined as to assist in evaluation of the gasification process. This was mainly determined from data in experiment 3. The results range between 0.55 and 0.59; 0.46 and 0.49 for combinations of (GN.S 50: Wood 50) and pure GN.S respectively. The gas volume flow rate ( $\dot{V}_g$ ) was 21 Nm<sup>3</sup>/hr for GN.S (100 %) and 29 Nm<sup>3</sup>/hr for (50:50). Therefore the extraction rate was in the range of ~2 Nm<sup>3</sup> /kg.

### **5.3.3.2 Tar and dust**

Tests were carried based on using GN.S as fuel. Wood values were used as comparison. The following tar parameters were quantified.

#### **Tar quantity**

Tar and dust that were collected in tubes (which were dried for 4 hour at 60°C before use) would again be dried at 60°C for 4 hours then at room temperature for 1hour and reweighed. To determine the amount of tar and dust, the net mass before and after the use was recorded. For determining the tar quantity only, the tubes were extracted for 7 hours with 150 ml Cyclohexan, this allows the tar to dissolve while the dust hanged in cases. Finally the tubes were dried again and reweighed.

The following calculation was then carried out to estimate the mass of either of them in gram (g).

- 1) mass of empty case (before experiment) (g) =  $m_{he}$
- 2) mass of full case (after drying ) (g) =  $m_{hf}$
- 3) mass of solid (tar and dust) =  $m_{t+d} = 2-1$
- 4) mass of partial full case (after extraction) (g) =  $m_e$
- 5) mass of dust (g) =  $m_d = 2-4$
- 6) mass of tar (g) =  $m_t = 3-5$

As the pump was on for 3 minutes then the mass of tar and dust in  $g/m^3$  is found as through

$$Be = m_{t+d}/t/ Q_p *1000$$

#### **where**

Be= loading of solid substances in gas in ( $g/Nm^3$ )

$Q_p$ =flow rate at pump in (l/min)

t= time in min=3

## Experiments for Gasification of Agricultural Residues

### Tar Results

Table 5.11 shows loading of tar and dust (Be) in ( $\text{g}/\text{Nm}^3$ ) according to the obtained results for each sample.

**Table 5.11: Mass of tar and dust**

Sample No.	Air input ( $\text{m}^3/\text{hr}$ )	Fuel type*	Fuel mass flow rate ( $\text{kg}/\text{hr}$ )	Solid mass ( $\text{g}/\text{Nm}^3$ )	Tar mass ( $\text{g}/\text{Nm}^3$ )	Dust mass. ( $\text{g}/\text{Nm}^3$ )
A	12	1	10.7	8.69	3.62	5.07
B	10	2	9.7	9.09	3.64	5.45
C	6	3	10	4.617	1.5	3.16
D	6	3	10	3.2	00	3.2
E	10	1	11.2	7.31	3.01	4.30
F	10	1	11.2	6.25	N.A.----	N.A.----
G	10	1	11.2	5.1	1.82	3.8
H	10	1	11.2	8.54	N.A.----	N.A.----
I	8	3	9.6	2.8	N.A.----	N.A.----
J	8	3	9.6	4.32	1.97	2.34
K	8	3	9.6	3.33	1.12	2.22
L	8	3	9.6	4.07	N.A.----	N.A.----

\* 1= 50:50 (Groundnuts shells: wood)

2=75:25 (Groundnuts shells: wood)

3=Pure Groundnuts shells

N.A= not analyzed

### Tar types

The solution of Cyclohexan and tar that was former obtained was concentrated in rotation – evaporator (through evaporation of Cyclohexan). A new solution composed of 2-3 mg tar and 0.5-1 ml dichloromethane was prepared.  $1\mu\text{l}$  from this solution was injected in a gas chromatograph at temperature range of 110-340 °C.

Tar types constituted an area more than 0.5 % of the chromatograph were identified and tabulated with percent of equivalent area in addition to resident time. Finally tar types with existence quality >70 % and concentration > $0.05\text{ g}/\text{m}^3$  were considered for further information (CAS, formula) as in table 5.12.

**Table 5.12: Detail information for tar types (example)**

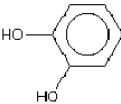
CAS	Name	Formula	Mol. Wt.	Structure
120-80-9	1,2 benzenediol	$\text{C}_6\text{H}_6\text{O}_2$	110.	







## Experiments for Gasification of Agricultural Residues

The further effect of tar is the main consideration when tackling tar issue. The registered tar types could be classified into two main groups: Phenols derivatives, PAH compounds. Table 5.13 shows the concentration in [g/m<sup>3</sup>] of different tar types in each sample. For better understanding for their effects, the main characteristics for selected compounds are presented in (table 5.14).

**Table 5.13 Tar components in gas (Groundnuts shells)**

Sample name Tar component [g/m <sup>3</sup> ]	C	B	A	E	K	J
Phenols derivative	0.50	1.84	0.75	1.08	41	0.66
PAH	0.16	0.26	0.17	0.48	0.12	0.15

**Table 5.14: Main characteristics for frequent tar types**

Name (CAS)	Solubility in water (g/l)	Mol.wt	Hazards: * <sup>23</sup> ** <sup>24</sup>
<b>1,2 benzenediol</b> (120-80-9) <b>PHENOLS</b>	Soluble in water	110	  * Xn N ** R: 21/22-36/38 S: 22-36-37
<b>Acetophenone</b> (98-86-2) <b>PHENOLS</b>	5.5g/l	120	 * Xn ** R: 22-36 S: 2-26
<b>Fluoranthen</b> (206-44-0) <b>PAH</b>	0.265 x10 <sup>-6</sup> µg/l	202	 * Xn ** R: 21/22-68 S: 22-24/25-36/37
<b>Anthracen</b> (120-12-7) <b>PAH</b>	Non soluble	178	  * Xi N ** R: 36/37/38-50/53 S: 26-60-61

Source: [12],[13], [14]

<sup>23</sup> **Gefahrensymbol**; Anhang II, Richtlinie 67/548/EWG (EU)

<sup>24</sup> **R- und S-Sätze**; Anhang III und IV, Richtlinie 67/548/EWG (EU)

**Alkali in tar**

**Methodology**

The collected tar tubes were cut into small pieces and grinded in an electric mill. A solution of 50mg tube +2ml HNO<sub>3</sub> was dried in a laboratory microwave, then it was set in Atomic Absorption Spectrometer (AAS) to determine the mass of Sodium (Na) and Potassium (K) as (μg) of Alkali/(g) of tube as prerequisite to calculate its absolute mass and hence its content in gas. As a precaution an empty tube was analysed for possible *contamination* with such compounds and the outcome was considered in the final result (*Blind value*).

**Results**

Table 5.15 shows the Alkali (Soduim only) concentrations results in (mg) against the fuel composition and air input. Column 5 shows the Alkali content in gas in (mg/Nm<sup>3</sup>). It was calculated according to the same equation used to calculate mass of tar and dust.

**Table 5.15: Alkali in tar**

Sample No.	Air input (Nm <sup>3</sup> /hr)	Fuel type	Mass flow rate (kg/hr)	Mass of tar and dust (g)	Alkali content (mg)	Alkali Content (mg/Nm <sup>3</sup> )
F	10	1	11.2	0.55	0.22	2.3
H	10	1	11.2	0.82	0.34	3.6
I	8	3	9.6	0.23	0.20	2.4
L	8	3	9.6	0.33	0.82	2.2

1= 50:50 (Groundnuts shells: wood)

3=Pure Groundnuts shells

**5.4 Analysis and discussion**

**Energetic parameters**

Theoretically a comparable calorific value (to wood) was a prerequisite for selecting the material. Practically the difference between the water free state (0 %) and the actual moisture content (act.m.c.) had lead to some lowering in the calorific values for the tested material but generally they remain in acceptable range of ~15-16 MJ/kg (Fig. 5.4 a). However, large fluctuation was realized when comparing the energy density especially Straw pellet (Fig.5.4b). This on one hand justifies the advantages of pelletization from the management point of view (see energy density Ch. 4). On the other hand this high density had adverse effect on feeding the gasifier on volume bases. As a result an increase in fuel feeding rate was practiced, this in turn affected various parameters such as equivalence ratio. Pulverization was conducted to overcome the expected problem with fuels of lower energy density. Pure pulverised fuels were predicted not to show optimum gasification behaviour in fixed bed systems so optimization measure was suggested by mixing.



a

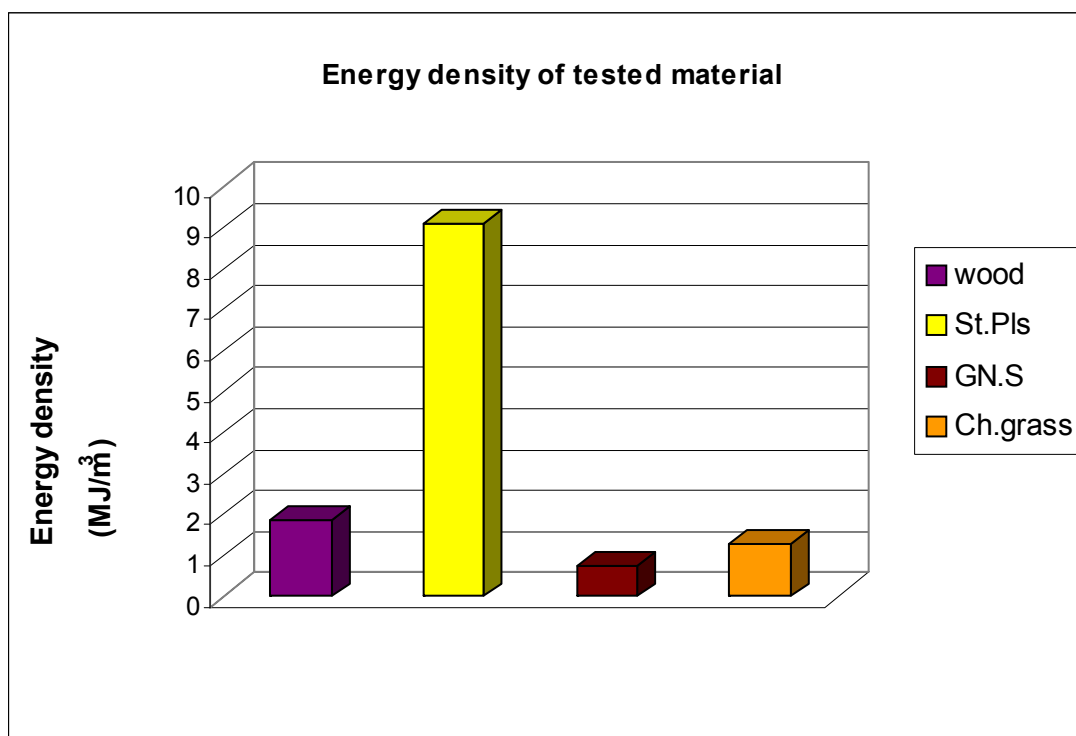

b

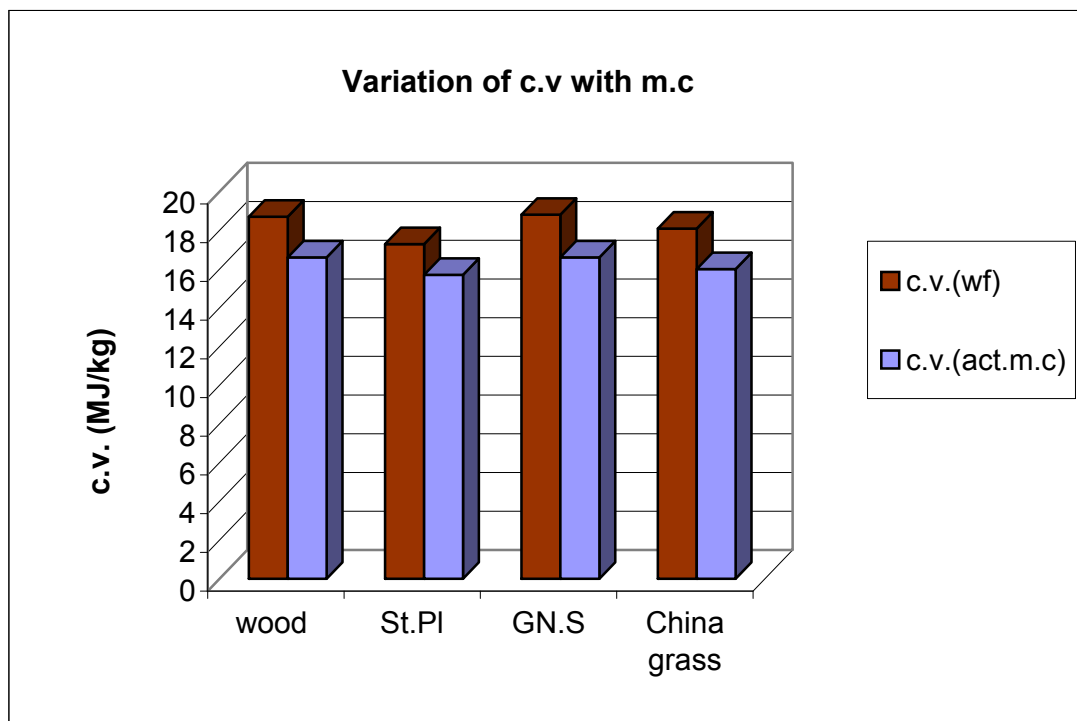

Fig. 5.4: Variation of calorific value of tested material

a/ with moisture content, b/ with density

### **Calorific value and gas composition**

In comparison to wood and to some values found in the literature with respect to gas composition, calorific value and percent of burnable gas, then the experimental results shows a relatively lower values e.g. at test for wood gasification for turbine [15] (4.4 MJ/N.m<sup>3</sup>, 38 %) was recorded (Fig. 5.5, 5.7). Nevertheless GN.S shows acceptable values in reference to fixed bed specification as recorded in [1]. They also match the results for hazel nuts gasification in [16] (Fig. 5.6).

### **Efficiency**

It can be seen that the cold efficiency of GN.S gasification lies within the range of 0.46-0.59 as seen in (Fig 5.8). This is actually lower than what is found in the test gasifier literature for wood at similar moisture content (60-65 %) [17] and of 65 % for Pecan nuts shells found in the study done by [18]. This could be referred to relative high char production observed during the experiment. Gasification process is expected to improve through *possible* mitigation measures like optimization of air distribution scheme. Another factor that had especially influenced the hot efficiency results was the relatively hot temperature (compared to [17]) measured at Schuss 4. Under the experiment conditions, this efficiency range was found acceptable.

### **Equivalence ratio**

Generally the process had taken place at average value of (n) ~0.2–0.25 (Fig. 5.9) but some lower values were also recorded. They were a result of the efforts done to optimize the gasification process (over feeding and lowering air input). However, some studies had recorded successful gasification experiments at 0.15 [19] and 0.18 [20]. The recorded values were found acceptable for agricultural residues gasification due to its high reactivity accompanied by lower bulk and energy density [21].

### **Char and ash**

Compared to other values obtained for the IGEL by [17], great variations were realized especially in the Carbon content of the char (50 % for wood). Taking into consideration that char and ash samples were only collected at the final end of the experiment then these values was considered as unreliable, further analysis were not possible.

### **Tar**

Tar content in GN.S samples could reach up to 3.6 g/Nm<sup>3</sup> while the dust content was recorded by 5.4 g/Nm<sup>3</sup>. Both values are higher than the limit for gas turbine and ICE (see Ch.3). It could be realized that tar content varies proportionally with fuel input and air input as shown in (Fig. 5.10). The tar types of GN.S are similar to that of wood i.e. Phenols and PAHs. These compounds are characterized by being slightly denser than water. Phenols are generally soluble while PAH are non soluble. The relative solubility of Phenols allow for relatively *simpler* tar removing systems e.g., washing. Nevertheless both groups show substantial environmental and health hazards. The higher frequency of Phenols indicates the relative low temperature that was prevailing at the gasifier.



## *Experiments for Gasification of Agricultural Residues*

---

The (Na) value was used as indicator for Alkali. The measured value of GN.S tested sample lies between 3.6 and 2.2 mg/Nm<sup>3</sup>. These values are higher than 0.24 mg/Nm<sup>3</sup> value used by [15] in testing a micro gas turbine under biomass gasification conditions. These results reflect the difficulties of using the gas in temperature range below 700°C (condensation point for Alkali). However, for uses at temperature lower than 60°C then Alkali compounds are found in non gaseous state. Thus with relative simple gas conditioning scheme their effects could be mitigated.

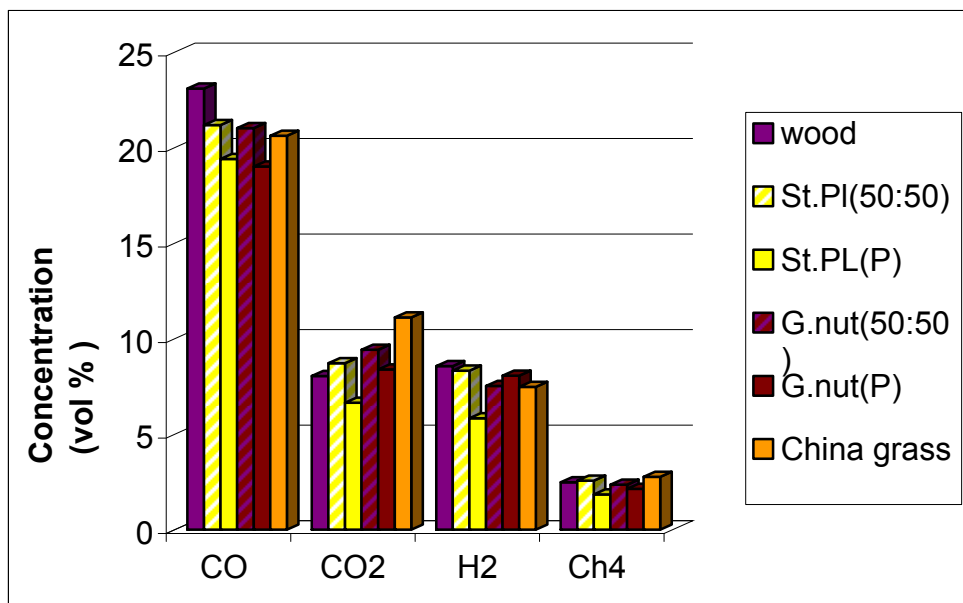

**Fig. 5.5: Producer gas compositions for the tested material**

- Average adjusted values

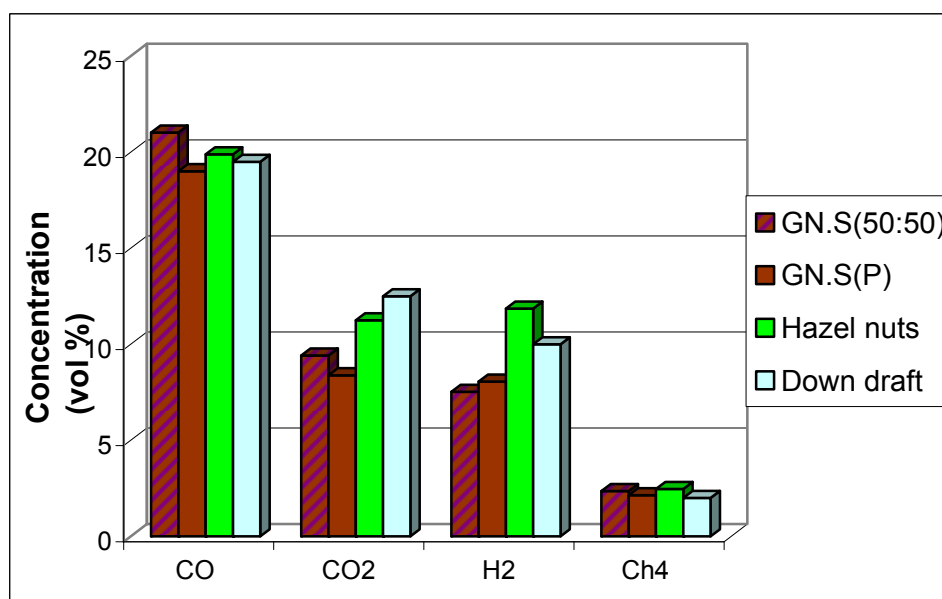

**Fig. 5.6: Producer gas composition (GN.S (50:50),GN.S (P)) compared to literature values**

\* Sources for comparisons: Hazel nuts [16], Down draft [1].

a

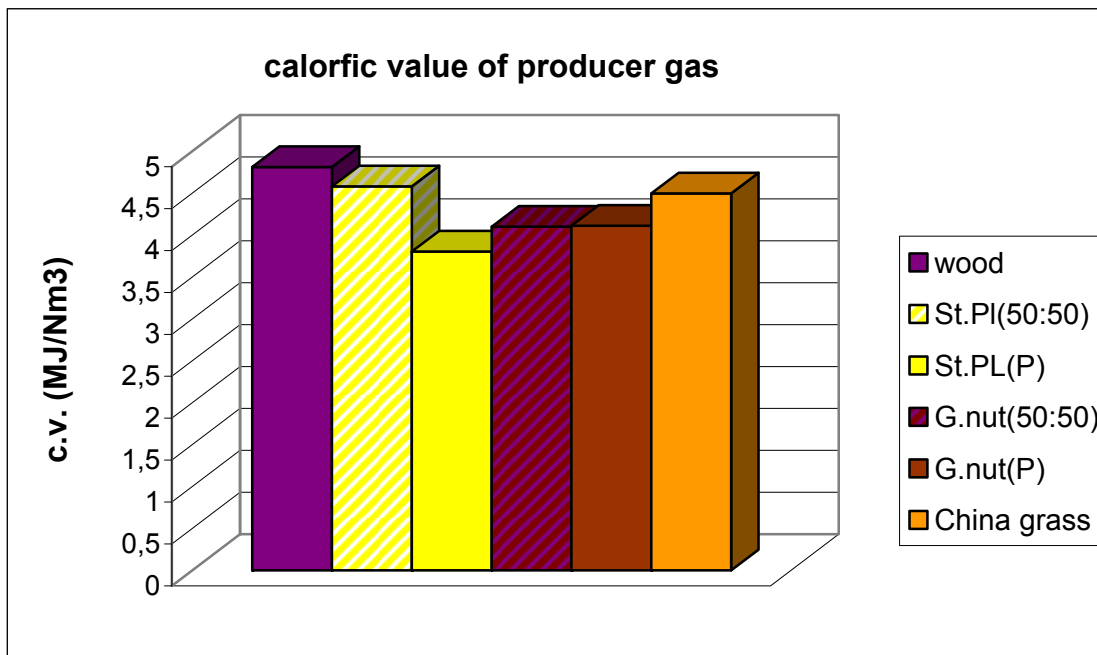

b

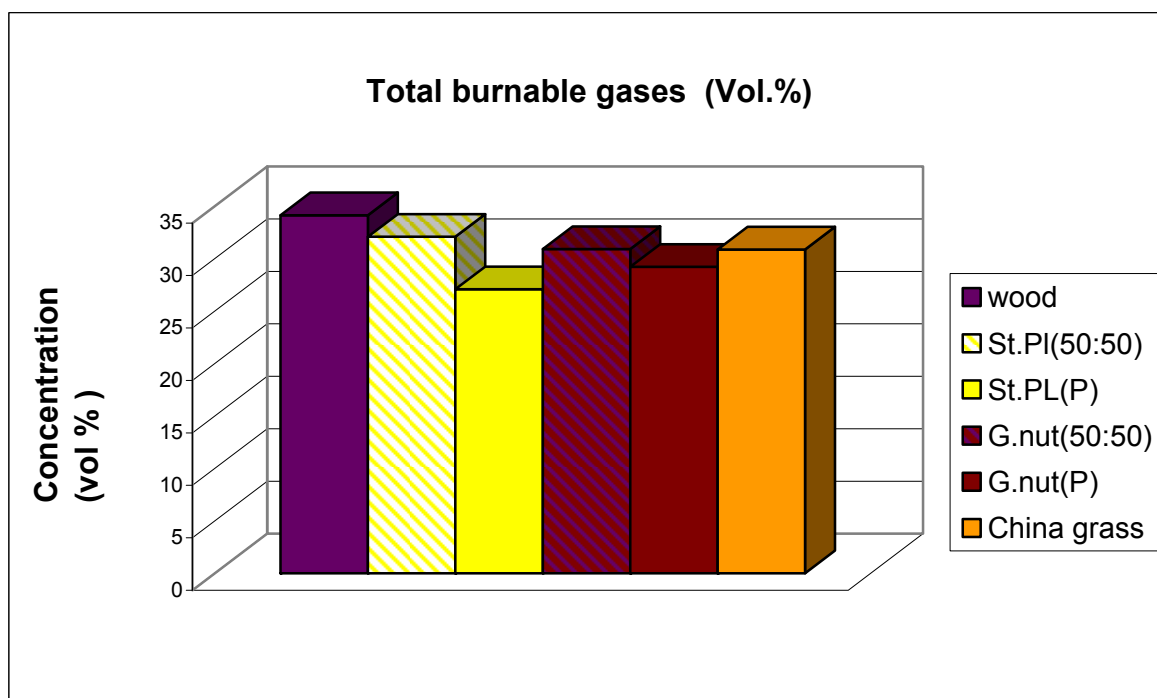
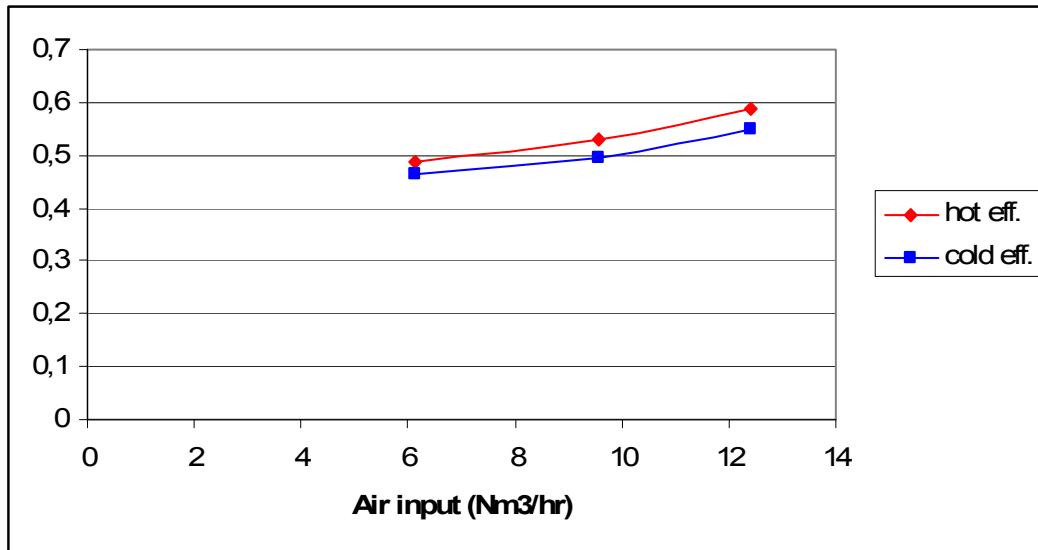
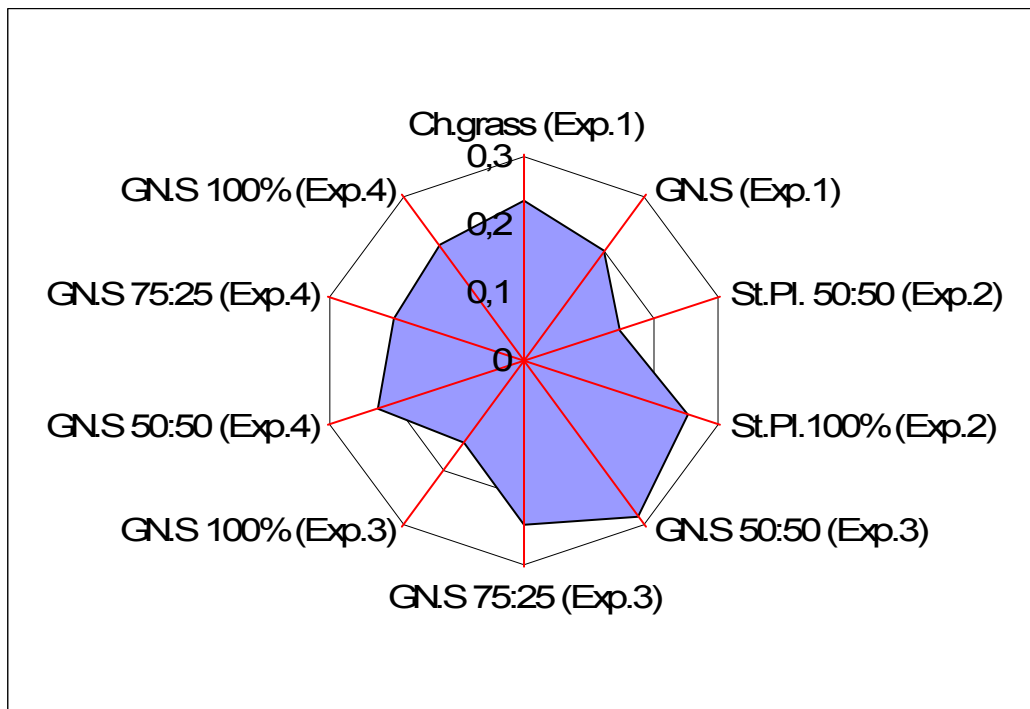

Fig. 5.7: Thermal properties of producer gas

a = c.v of PG, b=Total percent of burnable gases



**Fig. 5.8: Cold and hot gas efficiency of GN.S gas versus air input**



**Fig. 5.9: Overview for lambda results for the tested material**

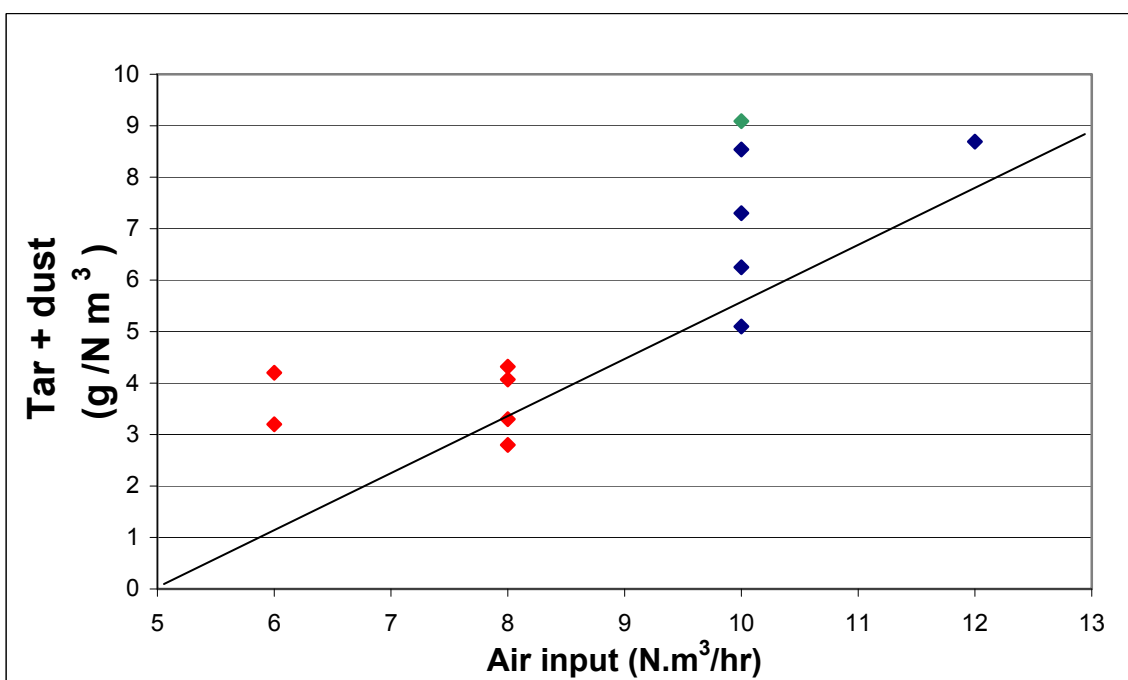
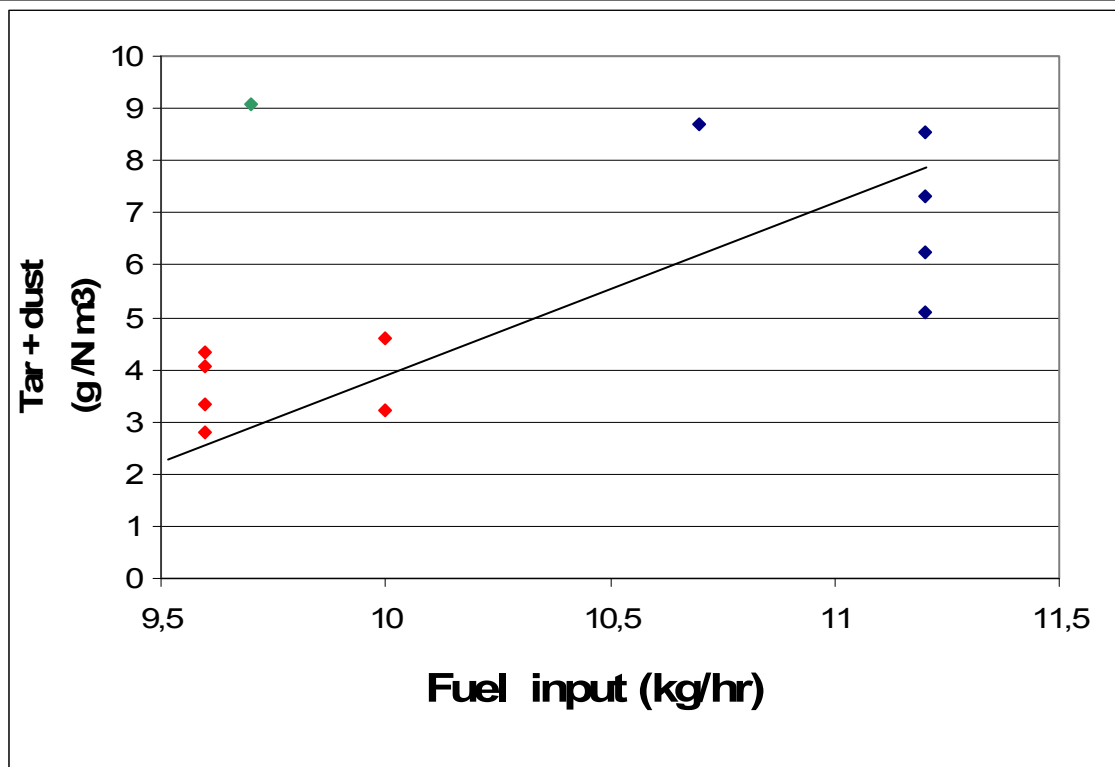
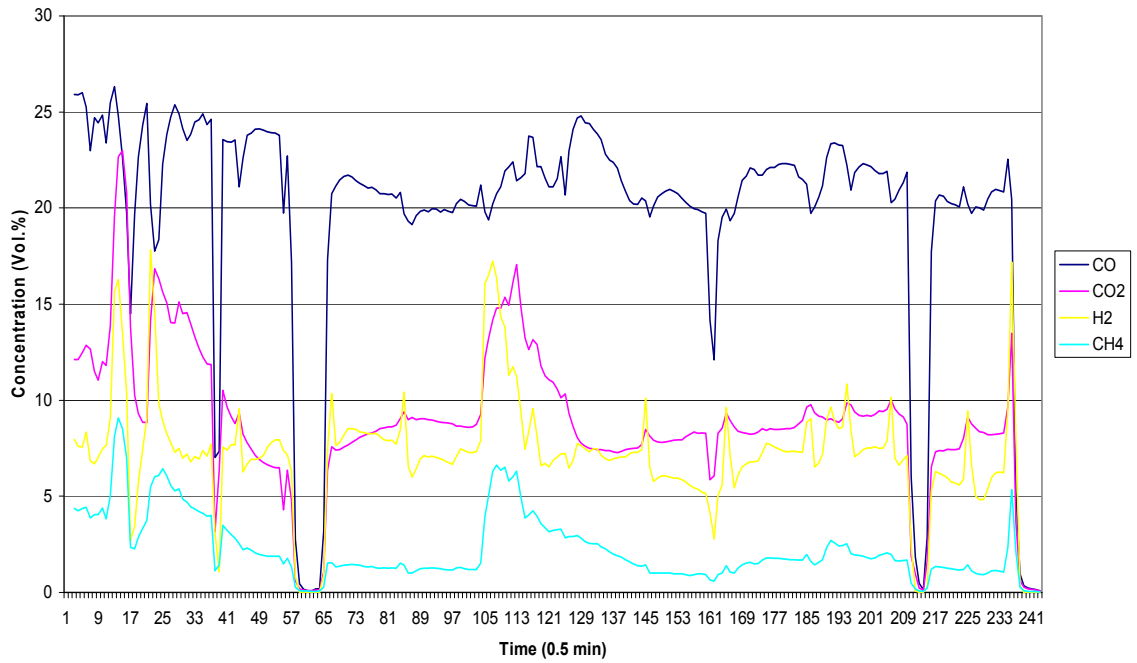

Fig. 5.10: Variation of tar and dust with fuel input and air flow rate (GN.S)

Legend:

- ◆ GN.S : Wood (50:50)
- ◆ GN.S : Wood (75:25)
- ◆ GN.S 100 %

Fuel mix= GN.S:Wood 50:50



Fuel mix=St.Pl:wood 50:50

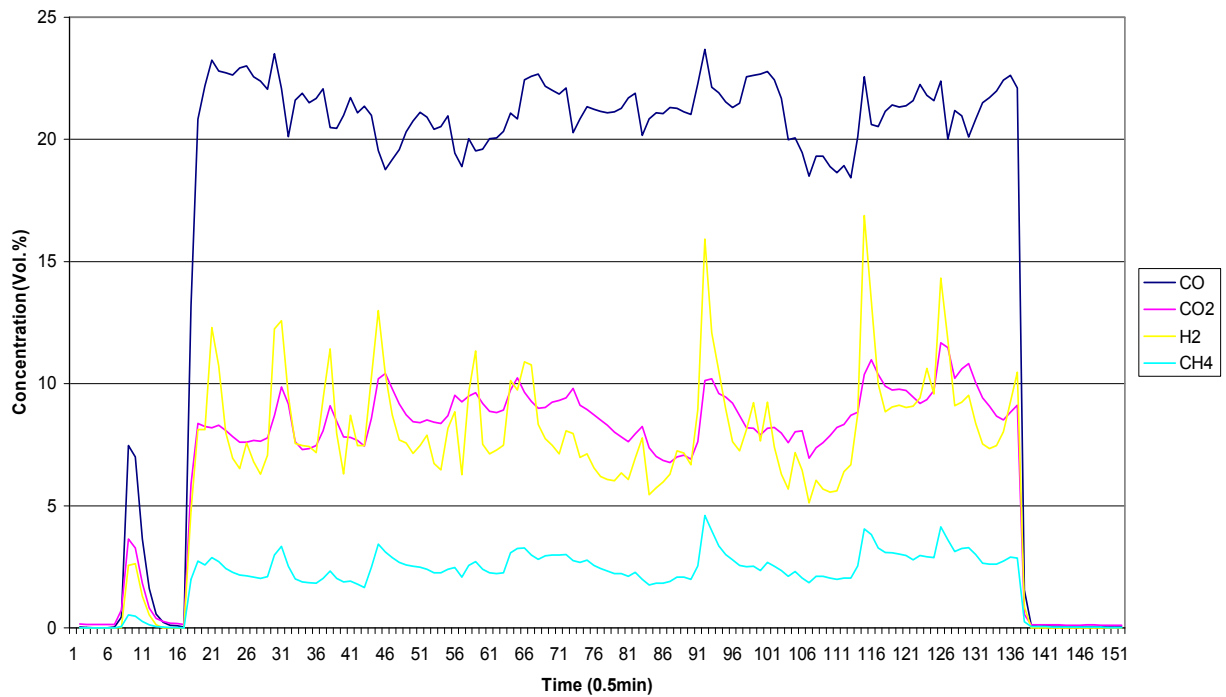

**Fig. 5.11: Gasification of St.Pl and GN.S**

### **5.5 Overall evaluation**

Generally the test had shown satisfactory profile for stabilization indicators such as producer gas constituents and gasification continuation (Fig. 5.11). Nevertheless packing phenomena was realized at some experiments. This could be elucidated by the explanation given by [22] about the special thermal reactions for Straw and wood and by [23], [24] about pellets thermal reactions. Thus in the current case it explained by: the trial to fill up the gasifier core (on volume basis) assuming complete, homogenous fuel behaviour had lead to clogging at specific moment. This hindered the gasification process, fuel particles assembled together and so packing was encountered. In case of GN.S its light weight accompanied by its higher reactivity end up in forming a *bridge-like form* inside the gasifier, therefore preventing char passage downwards. Additionally droplets of oil could (contained in the shell) cause smoke generation which in turn alters gasification conditions. On the same time these oil droplets create a magnetic like effect attracting more particles to bind with each other. In case of lower air input then more char is formed. On the other hand according to [25] the four gasification zones in the test gasifier were relatively intensively overlapping, and the temperature decreased rapidly in a relatively short distance thus the high temperature zone was relatively limited (Fig. 5.2). Beside operation measures such as fuel load and air input optimization, other measures include redesign of ash and char removal system to match other fuels. Alternatively enlarging the hot zone to allow efficient reactions room and prevent volumetric packing. This could be done through extending the reaction zone or introducing hotter air to the gasifier. The overall result for the gasification process was evaluated as acceptable but long term tests are needed before application in reality.

### **5.6 Conclusions**

#### **Findings**

- Groundnuts shells could be gasified in fixed bed system.
- The gas calorific value for Groundnuts shells could reach 4 MJ/m<sup>3</sup>.
- The cold efficiency could lies in the acceptable range of 49-55 %.
- Tar content for PG using GN.S lies above the acceptable limit for turbine and ICE.

#### **Gaps and recommendations**

- Long term experimental program for agricultural residues at constant gasification parameters to optimize the gasification operation.

## *Experiments for Gasification of Agricultural Residues*

---

- Optimization of gas conditioning system according to the contaminants nature of agricultural residues.
- Long term test for gas engine using PG from agricultural residues gasification.

### **Further work**

Based on the results of this chapter and the pervious chapters a suggested concept for a power plant will be drafted as shown in chapter 6.



## **6 Development of a Concept for a Decentralized Power Generation**

The main objectives of this chapter are to:

- Identify the main factors and considerations that affect the conceptualization of biomass gasification power plant (**BGPP**).
- Draft a concept for (**BGPP**) under the local conditions of the study area considering agricultural residues as fuel with special reference to Groundnuts shells.
- Test the economics of such power plant under the current market conditions.

The content will cover:

- Planning and operation aspects for (**BGPP**).
- Suggested power plant components.
- Economics and other consideration.

The conclusion aimed to identify the main operation considerations.

### **6.1 Boundary conditions for power plant operation**

For satisfactory operation of any power plant diverse aspects and factors integrate together at the different levels of input, process and output [1], [2], [3]. Therefore identification process for such aspects and hence the required components for (**BGPP**) is under taken based on the conceptual frame work summarized on (Fig. 6.1). The development of the concept is based on representative factors which were selected for their comparative importance. Within the context of observing the whole process of electricity generation then brief functional description and role specification for each of these factors will be given in the next section.

#### **6.1.1 Fuel**

Fuel quality, quantity and cost control the electricity amount produced, influence the smoothness of internal operation in the power plant and affect the over all economics of the power plant. The fuel aspect here was further divided into:

##### **Fuel logistic**

Due to relative biomass high bulk density and size heterogeneity then factors such as fuel quantity, transportation, storage and pre-preparation belong to this block. This consideration should include both technical possibility, market availability and cost related issues.

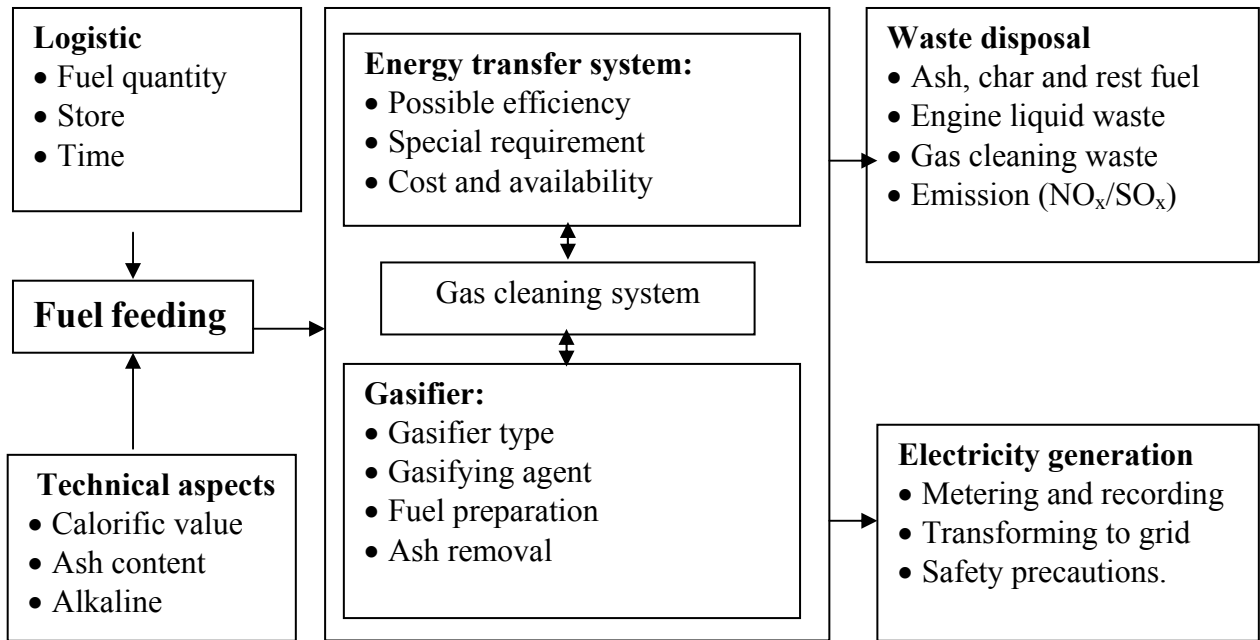

**Fig. 6.1: Graphic over view for planning aspects of (BGPP)**

### **Fuel technical parameters**

In this block the main interest is derived towards the current/attainable fuel properties of fuel such as calorific value, alkaline content or ash melting behaviour (see chapter 4). These parameters are highly related to gasifier selection and specification of the complementary aggregates such as ash removal system. The feeder design and the optimum feeding rate are cross-cutting aspects.

### **6.1.2 Gas to electricity conversion system**

The different processes which are involved in the eventual process of electricity generation such as gas production, cleaning and reforming as well as gas to electricity transformation are included in this block. This block is hence divided into three main aggregates that are further affected/controlled by different factors as described below:

- Gas producer (Gasifier): type, size, gasifying agent etc.
- Gas reforming system: tar handling, temperature and pressure optimization.
- Electricity generation system: possible achievable efficiency, special engine requirement.

A cross cutting factor that affect the selection/design process in this block is the availability/price for such components in the commercial market.

### **6.1.3 Waste disposal**

Within this block issues of waste management and disposing are tackled. Main considered options are dumping in open ground or normal/special closed depots underground. Reuse and recycling inside or out side the plant premises could also be considered as a viable option.

## ***Development of a Concept for a Decentralized Power Generation***

---

Alternatively pre or post intervention such as gas catalyser could reduce the waste quantity. The specific selection of waste management scheme depends on the economics of the process which in turn varies according to the maximum level found and strictness of the legal requirement. The waste term used in this study include mainly:

### **Emission**

Explained by the high concentration of elementary Nitrogen and Sulphur in agricultural residues compared to wood then flue gas emission such  $\text{NO}_x$ ,  $\text{SO}_x$  are expected to be higher. These gases are considered very hazardous to the environment especially in relation to their roles in the acidic rain and air pollution phenomena. The emission intensity is dependant on the specific fuel used as well as other factors such as gasification technique, and the conditions of gas to electricity process.

### **Ash and char**

In (BGPP) compared to traditional combustion system more char is generated and should be disposed off. This product has relatively good calorific value that could increase the economics of the process; making use of such product is highly encouraged. On the other hand when the biomass used is not chemically polluted then dumping of such products in open or close ground could also be considered.

### **Gas cleaning refuses**

Tar and particulate trapped by the specific gas cleaning system could include hazardous materials which are often soluble in water. From the thermal point of view then tar itself is considered as product of high calorific value that can (a.o.) improves the economics of the gasification process [4]. On the other hand particulates are of inert nature and smaller quantities thus particulate handling on the short run requires relatively easy and simple measures.

### **Other waste**

Water and oil used for cooling of the different components of the system such as engine or feeders could be discharged and managed in similar way to any other thermal system. Considering the engine-motor section specifically then water is relatively clean and it is discharged with unchanged chemical parameters. Nevertheless huge increase in temperature calls for more care concerning thermal pollution. On the other hand as the gas is assumed to be clean and relatively cooler than fossil fuel then it could be assumed that less oil could be needed.

## **6.1.4 Electricity supply unit**

Electricity production from a gasifier system could be either for self need or for commercial purposes. In both cases specific components are needed. For both cases the electricity supply unit is concerned with recording quantitative parameters of the electricity production and optimizing the

## ***Development of a Concept for a Decentralized Power Generation***

---

properties of the electric current produced according to the need. These functions are performed through these components:

- Transformers: the normal gas to electricity system produce electricity at 220-415 Volt while distributing grid requirement could be 16 000 Volt.
- Meters: this allows metering and recording the real electricity quantity produced.
- Control unit: in case of net distribution a control unit to shut down electricity connection in case of grid fall down is essential for life saving.

### **6.2 Local factors affecting selection of system components**

Biomass as general and agricultural residues specially are, more or less, site-related energy type. Therefore the selection of the optimum system is linked to the local factors in the erection site. Having in mind the objective of execution of such plant in arid regions such as Kordufan region, the following factors and site characteristics should be considered:

- High atmospheric dust content<sup>25</sup> (appendix 6-A), high temperature (35°C), water stress.
- Fuel: relatively dry (<10 % m.c.) and chemical free, possible high fibre content (stalks).
- Low technical know-how and poor infrastructure, low labour cost.
- Relatively Stable electricity supply through out the day/year.
- Optimum working time including preparation (6 month) November-April.
- Energy need is based on 10 000 houses at ~ 4 kWh daily consumption.
- The total actual full hours will be considered (2250), 15 hr/day, 5 months/year.
- No strict obligations for emission, wide construction and dumping area available at relatively low cost.

### **6.3 Power plant concept**

In the following section the main components that are considered suitable for satisfactory operation under study area condition will be illustrated (Fig 6.2).

#### **6.3.1 Fuel unit**

The fuel preparation unit is concerned with storing, preparation and feeding of fuel according to specifications set. The dry climate prevailing in the region during the suggested working time eliminates the need for closed store. However, the expected high impurity content that might be found as result of harvesting processes in addition to atmospheric dust requires pre cleaning system;

---

<sup>25</sup> Atmospheric dust is a prominent feature of the Saharan and Sahelian environments, and dust generation events can give rise to dust clouds that are transported large distances, traversing northern Africa and adjacent regions and depositing dust as far away as Europe, Western Asia and the Americas. (Moulin, et al; **Control of atmospheric export of dust from North Africa by the North Atlantic Oscillation**, *Nature* 387, 691-694; 1997.

## ***Development of a Concept for a Decentralized Power Generation***

---

e.g. a sieve and air blower to clean fuel before feeding. One of the main objectives of the pre-preparation unit is size reduction through crushing; an extra mill could be used when needed. This process is expected to be relatively smooth as foreign bodies are generally absent and the material is at relatively dry state (m.c. less than 10 %).

The feeding unit consists of upper hopper that could be manually fed from the ground storage. This position makes use of the gravity force and eliminates excess transport system from storage to feeding point. A mechanical feeding system composed mainly of set of auger and electronic controlled feeding room, based on volume sensors, could be used to transport, meter and dose the required fuel quantity from the upper hopper to the gasifier. This system had the advantages of relatively easy operation and low cost. Due to the high bulk density and fibrous nature of the material, flow disturbances such as clogging could be expected. As a mitigating measure for this problem an external mechanical vibrator could be installed.

### **6.3.2 Gas to electricity conversion system**

#### **A/Gasifier**

##### **Gas production**

Fixed bed gasifier is selected due to its satisfactory operation under the study area conditions (see Ch.3, 5). Air is chosen as gasifying agent due to its convenient availability and low cost. Specific dosing through blower is favoured for open-top air feeding system. Main selection criteria for this are: more accurate air/fuel ratio could be attained in addition to its flexibility to be used for different fuels in addition to atmospheric dust problem. The experience gained from gasification of typical agricultural residues in fixed bed systems (Ch.5) shows that better air distribution will improve gasification process therefore air injection through nozzles distributed around the drying and the reduction zones will be favoured. For prevention of bridge forming phenomena an agitator/shaker could be used to shake the fuel inside the reactor. Due to high dust content then air filtration is essential requirement; this could be done through allowing the air through successive cloth filter into a suction room, a blower then sucks air from this room into the gasifier. This serves both efficient filtering and low cost.

##### **Char and Ash removal**

Bottom char and ash and un reacted material could be collected continually by screw system through well sealed insulated metallic pipe, to prevent fire hazards, to a closed ash holder at bottom of the gasifier connected. A pan like rotating device at the bottom of the gasifier assists to derive the ash through the desired passage. The collected ash containers could then be cooled in water bath filled with waste water from gas washer or sand bath before it is left to cool down at ambient temperature.

## *Development of a Concept for a Decentralized Power Generation*

---

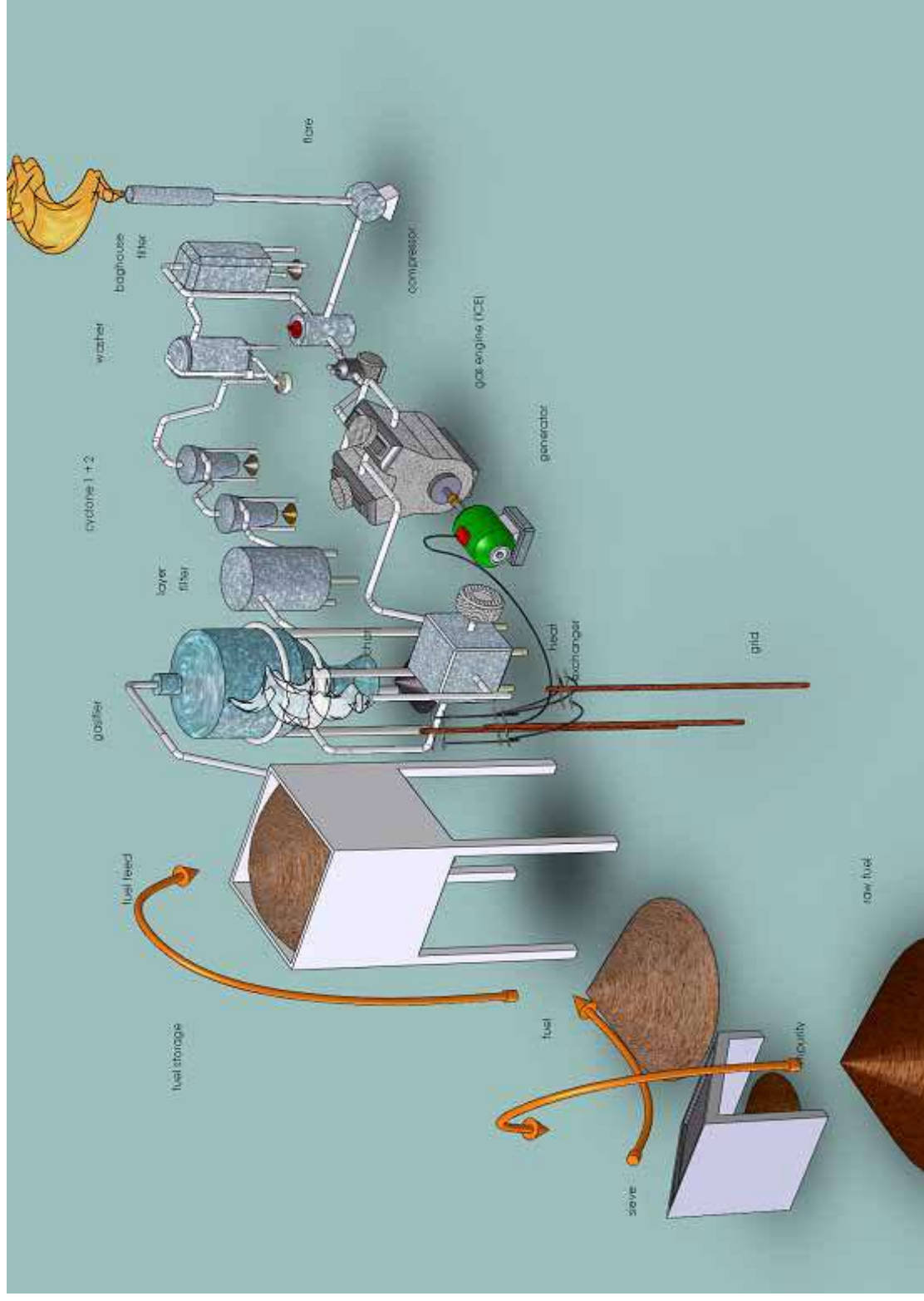

**Fig. 6.2: Power generation concept**

## ***Development of a Concept for a Decentralized Power Generation***

---

### **Gas cleaning**

The results of GN.S gasification shows that high percent of Phenols compounds are expected in tar. These compounds are relatively soluble in water, this increase the favourability of water based cleaning system but intensify the problem of liquid waste management; additionally the study area lies under relatively water scarcity. Therefore the suggested gas cleaning system is recommended to incorporate the following features:

- water use should be minimized.
- allow the reuse of tar.
- closed water cycle.
- low cost, ease of operation.

It is purposed that systems follow the stage system as in the companies of Pyroforce ([www.pyroforce.ch](http://www.pyroforce.ch)) and Wood power ([www.woodpower.ch](http://www.woodpower.ch)). This system is composed of hot gas cyclone followed by a bag filter that is assisted with alkaline material as CaOH to remove acidic material. Water washers between gas cyclone and bag filter is placed so that excess tar will simply condensate/solved, parallel gas temperature will be lowered to match the engine requirement.

### **B/Gas transformation system**

Compared to other gas to electricity transformation systems such as external gas turbine or Stirling engines, ICE has lower efficiency and less flexible operation conditions (see section 3.5). Nevertheless, pragmatic observation explained by market and cost constraints limit the selection possibility to ICE system only.

Company Jenbacher ([www.Jenbacher.com](http://www.Jenbacher.com)) had developed a special engine to work on LCV gases including PG. The maximum market limitation is about 350 kW however engines designed entirely for biogas could also be used considering the special nature of PG (higher c.v., lower volumetric efficiency and less corrosive nature). In the Jenbacher system some modification had been introduced so as to insure sustainable efficient operation, this includes (a.o.):

- Ignition-Voltage 40 kV rather than 7.5 kV (standard).
- Three-point ignition (Double primary-ignition plus final ignition).
- Leaner air/fuel ratio (Air fuel ratio in the engine 1:1).
- Fuel air premixing and use of turbocharger.

### **6.3.3 Waste management**

#### **Gas cleaning refuses**

The waste generated at the bag filter and washer is assumed to be of high calorific value, thus it could be reused either as secondary fuel in the gasifier thus increasing technical efficiency or by selling it to external partner so improving the economics of the power plant. In the first case, preparation measures for drying and feeding could be carried out. Feeding problem could occur so a special feeding auger based on particle size distribution is required. For the second option possible

## ***Development of a Concept for a Decentralized Power Generation***

---

customers could be the boilers in the nearby oil mills. Alternatively waste could be then dumped in containers underground.

### **Water**

The water management system serves to great extend the objective of close loop so as to assess the environmental benefits and the economics of the system. Cooling water from the gas washing will be allowed to cool down collected in separate closed tank finally it will be filtered then allowed to settle. The water stream could then be reused for gas washing or ash cooling. Alternatively chemical- cleaning plants such as *Azadrachta indica*<sup>26</sup> could be grown around the power plant premises, the waste water can then be used for irrigation of such species. Finally it could be used for trees growing. The filtered material is treated like filter refuse.

### **Emission**

In such power plant NO<sub>x</sub> are expected to be the main emissions (see Ch.4). This is due to high Nitrogen content in the fuel. Additionally the relative low calorific value of PG requires leaner mixture for the complete combustion of the gas. The only room available to reduce these emissions is using special catalyst to remove excess gases from flue gas after the motor. In spite the high cost but the objective of sustaining the environmental aspects of such power plants requires such cost.

## **6.4 Over all system planning**

### **6.4.1 Spatial planning**

The required system is in the range of 3 MW but the market allows for 500 kW maximum then a set of small gasification plants set in parallel is suggested, this allows flexibility of construction, operation and maintenance however a central fuel storage and gas reforming is favoured as they are more cost effective. Tree plantation around can act as a pre filter for air and emissions.

### **6.4.2 Temporal planning**

The operation period is assumed to be from November- April, actual production takes place between mid November to mid Mars. The operation time is selected so as to serve different objects. The main characteristic is basic supply for relatively wide sector of society, thus a steady continuous operation is favoured. It allows the system to work smoothly at constant supply rather than applying peaks for limited beneficiaries. A very important factor is fuel availability on this time of the year. Other factors related to operation measures are the optimum climatic conditions; dry weather is expected, this lowers the storing cost. Additionally dust and temperature are at their lowest values compared to other times of the year. Finally during this period the population density and so demand is at its maximum which improves the system economics.

---

<sup>26</sup> This tress were used as environmental measure in the oil refinery in El Obied (Sudan)



## 6.5 Economical evaluation

### 6.5.1 Methodology and assumptions

To test the economics of the suggested system a cost – price analysis was carried out. This analysis was based on VDI Richtline 2067 for year 2007. The dynamic calculation method was used in this evaluation where by the annuity method was favoured. The calculated annuity factor is 0.117 based on an interest rate of 10 %. The erected system is assumed to be of  $\eta \sim 35\%$  (considering near future product development). The total annual cost ( $C_T$ ) for electricity production based on (BGPP) incorporates three cost types namely:

1. Fixed cost ( $C_F$ ); this includes the total gasification system, gas cleaning system, fuel feeding and preparation arrangements, gas engine and accessories. The basic fixed cost includes reactor, gas cleaning system and engine. The basic value for ( $C_F$ ) was assumed to be 3000 €/kW<sub>el</sub> based on:
  - Information obtained through personal contacts with some companies.
  - Calculation done by [5] but neglecting construction cost as well as cost for heat exchanger, fuel storage and assuming 10 % price reduction at future.
2. Consumption cost ( $C_C$ ) which includes basic cost and fuel preparation cost. It is calculated based on the assumptions that fuel its self is costless and only preparation cost had to be considered. The preparation cost is estimated based on field information by 0.5 €/sack (40 kg). This assumption is mainly for the basic case but a possibility of *price existence* is considered in the further cases.
3. The operation cost ( $C_O$ ) which is composed mainly of the maintenance expenses in addition to labour and management cost. This is calculated according to VDI Richtline 2067, 2007 as 14 % of the total annual fixed cost. This assumption is debatable but in absence of other statistics from Sudan then this could be accepted as starting estimation. The overestimated value (if any) could be used for further improving of the system.

Hence the total cost is calculated based on the following equation.

$$C_T = C_F + C_C + C_O$$

Other parameters assumed are

- Waste management cost of 5 % should be considered to test the effects of *external cost* on the economics of the process.
- The total annual expenditure is assumed be 10 % less than total annual cost as subsidy of 10 % of the annual total cost is foreseen.
- Selling price for kWh<sub>el</sub> price is assumed to be 110 % of kWh cost.

As pioneer project and according to official intention of government to support renewable energy project then the 10 % subsidy of the annual total cost is assumed to be paid as

## ***Development of a Concept for a Decentralized Power Generation***

encouragement for renewable energy. Alternatively this subsidy could be collected through CDM or volunteer programmes for CO<sub>2</sub> emission compensation. As the project is foreseen to be attractive for investment then the selling price for kWh<sub>el</sub> is assumed to be higher than the actual cost by 10 %. The main income will be based on electricity selling. In the time being and the near future no commercial market for excess heat is foreseen. This is a very realistic assumption in spite of its adverse effects on efficiency and economics but it should be applied as the basic evaluation should consider the present situation.

The main economical considerations in developing countries like Sudan are:

- Manual labour are more cost effective than in Europe further more this provide jobs which will enhance the acceptance of the project hence it accelerates the adoption of such technology. (considering the total labour cost then more labour personal is possible)
- Wide area available for construction which allows the erection of the required blocks on horizontally level thus reducing construction cost. Finally it favours relative low cost for waste management e.g. dumping.
- Dry climate reduces drying and storing cost.

### **6.5.2 Sensitivity analysis tests**

A sensitivity analysis for variation of the kWh cost and the return period according to 4 different scenarios was carried out. The results are displayed in Fig 6.4 - 6.10. The Boundary values for the input parameters needed for the economical evaluation of the **(BGPP)** in Sudan are tabulated in table 6.1 and Fig. 6.3 which are constructed based on the undertaken assumptions.

**Table 6.1: Boundary values for (BGPP) in Sudan**

<b>Parameter</b>	<b>Unit</b>	<b>Value</b>
Fuel amount	ton/season	8000
Basic fuel cost	€/ton	0
Preparation cost	€	100000
Total fuel cost	€	100000
Gas calorific value	MJ/ Nm <sup>3</sup>	4
Gas extraction rate	Nm <sup>3</sup> /kg	2
Total seasonal energy available	MJ/season	6.4 *10 <sup>7</sup>
Assumed elect eff.		0.35*
Assumed thermal eff.		0.60
Produced kWh <sub>el</sub>	kWh/season	6.2*10 <sup>6</sup>
Produced kWh <sub>th</sub>	kWh/season	10.6*10 <sup>6</sup>
Useful period	year	20
Interest rate		0.1
Daily electric consumption	kWh	4
Daily hours	hr/day	15
Days of supply/year	day/year	150
No. Consumers	household	10000
Total full hours	hr/year	2250

\* Assumed values based on process and system improvement in future

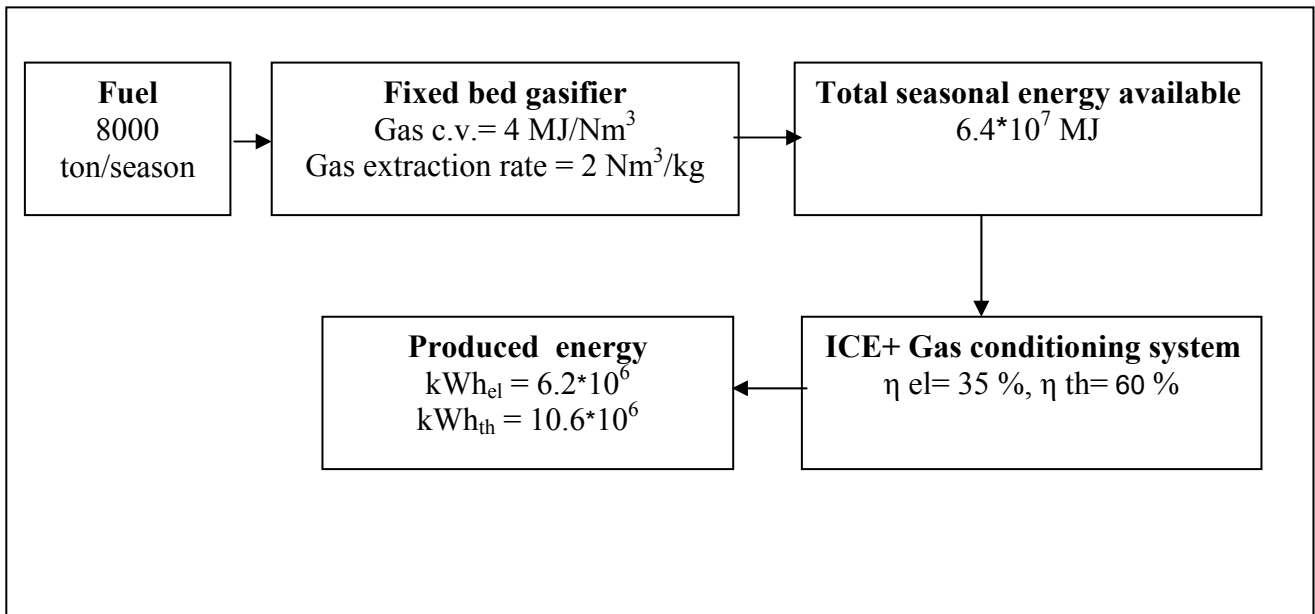

**Fig. 6.3: Sketch for considered factors for economical evaluation**

## Development of a Concept for a Decentralized Power Generation

**1- Input:** Varying the basic fixed cost and fixing other costs, starting with basic of 3000 €/kW (1) [basic case (BC)] then lowering it into 2000 €/kW (2) finally to 1000 €/kW (3).

**Output:** Costs range between 0.21 € and 0.08 € while return period between 24-16 year.

**Result:** Return period had been reduced by 33 % and cost by 60 % (Fig. 6.4, 6.5).

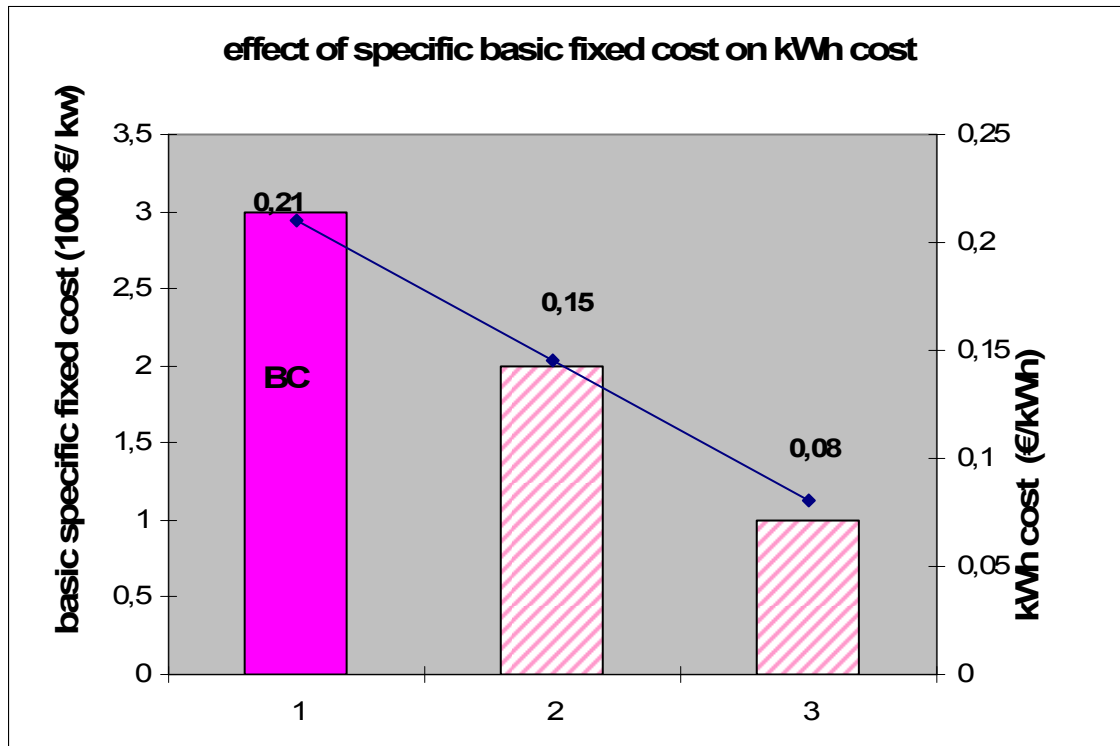

Fig. 6.4: Effect of basic specific fixed cost on kWh cost

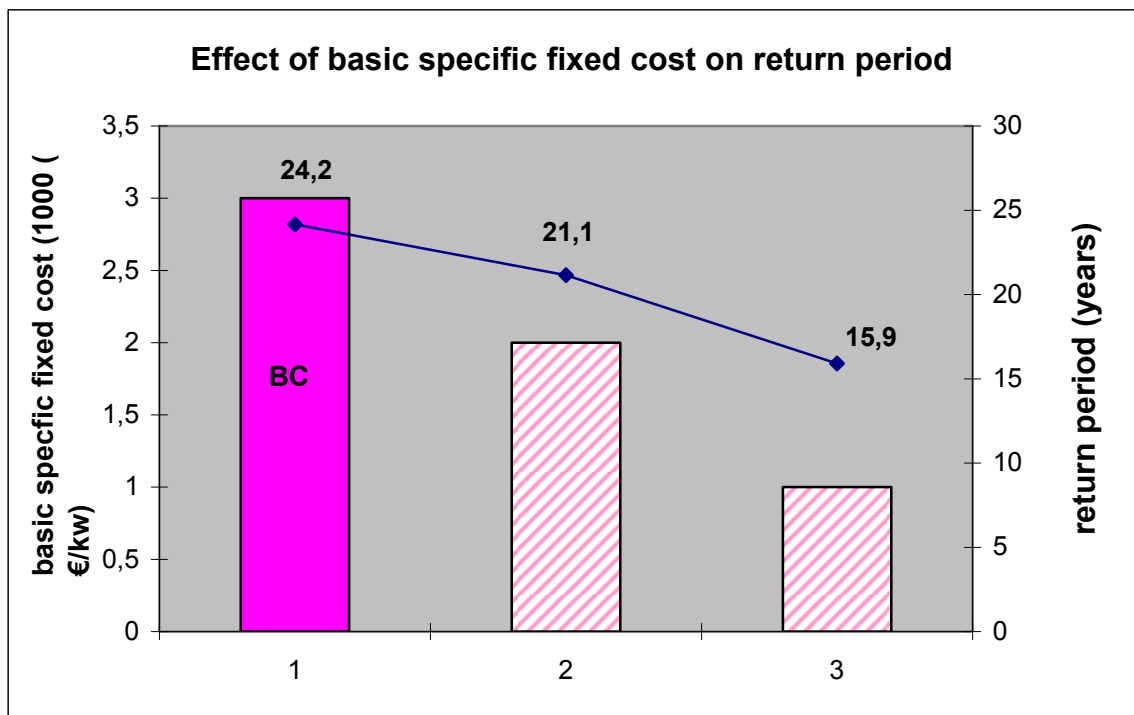

Fig. 6.5: Effect of basic specific fixed cost on return period

## Development of a Concept for a Decentralized Power Generation

**2-Input:** Varying the fuel cost and fixing other costs, starting with basic of 100000 €/year (1) [basic case (BC)] then increasing into 200000 €/year (2) and 300000 €/year (3).

**Output:** Costs ranges between 0.24 € and 0.21 € while return period between 24-16 year.

**Result:** Return period was decreased by 33 % while cost increased by 15 % (Fig. 6.6, 6.7).

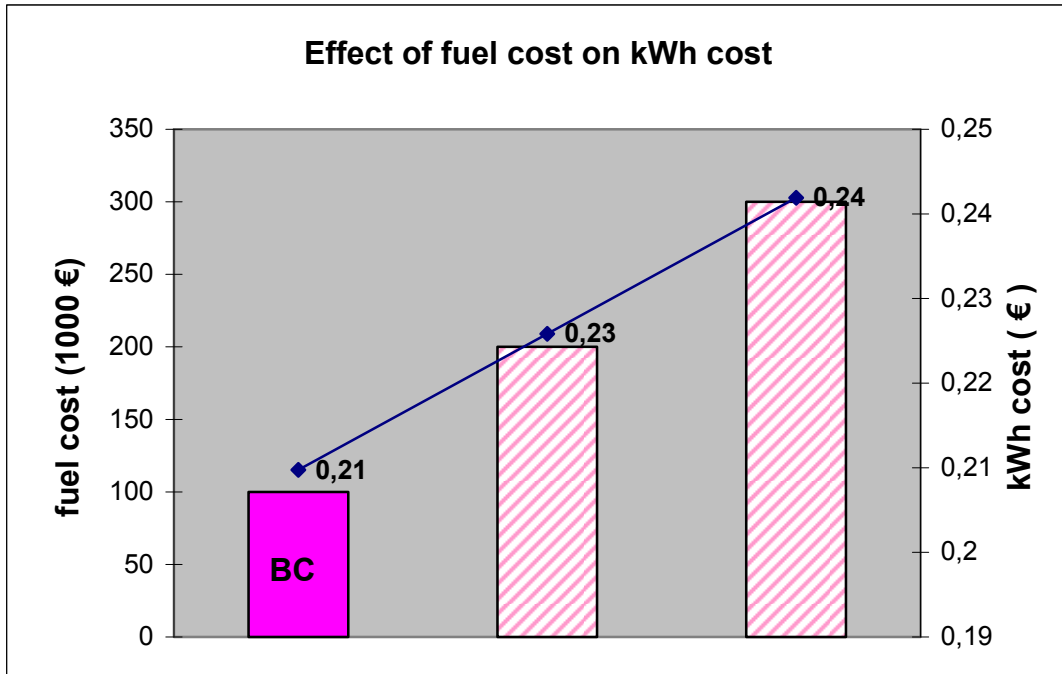

Fig. 6.6: Effect of fuel cost on kWh cost

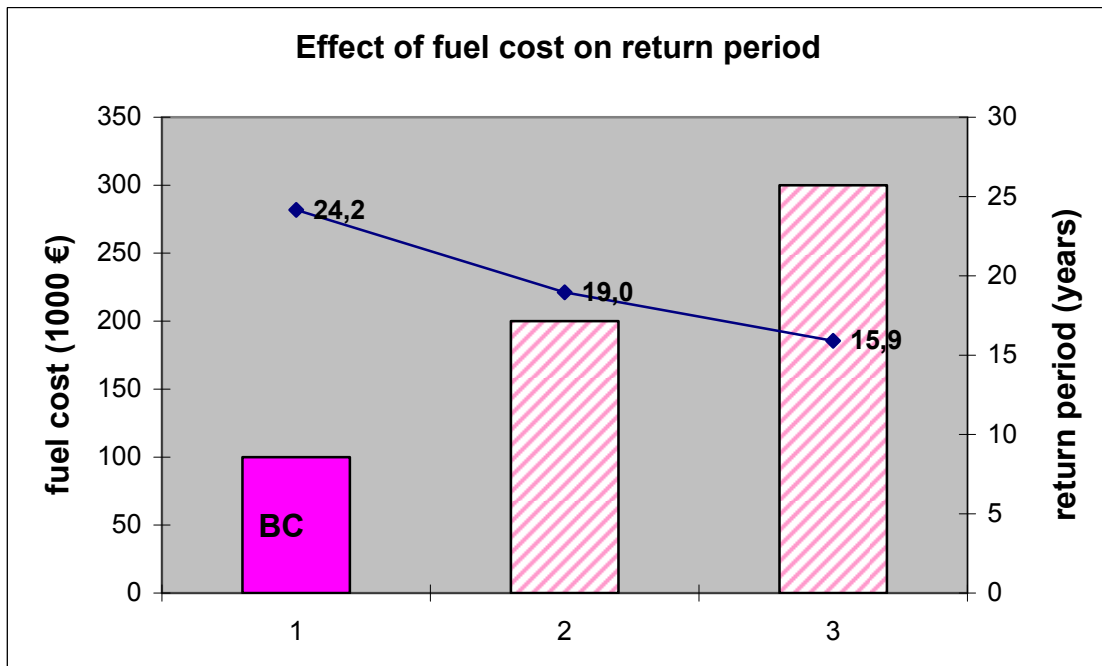

Fig. 6.7: Effect of fuel cost on return period

## Development of a Concept for a Decentralized Power Generation

**3-Input:** Varying Operation cost of basic of 14 % (1) of the annual fixed cost [basic case (BC)] then lowering it to 10 % (2) and 7 % (3).

**Output:** Costs ranges between 0.21 € and 0.20 € while return period between 32-24 year.

**Result:** Return period increased by 25 % while cost had decreased by 5 % (Fig. 6.8, 6.9).

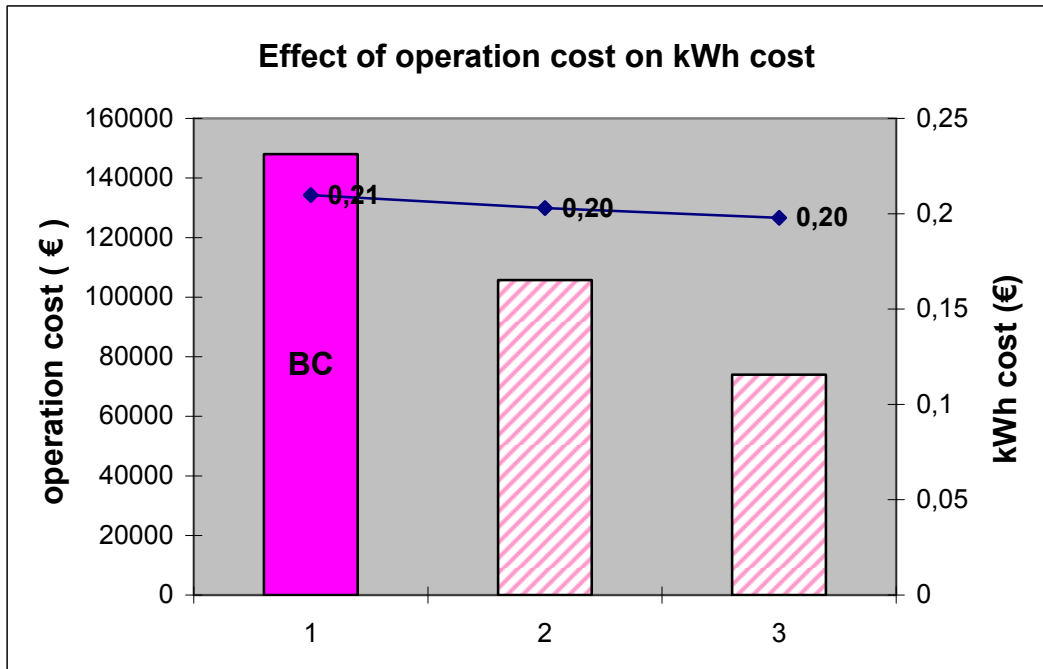

Fig. 6.8: Effect of operation cost on kWh cost

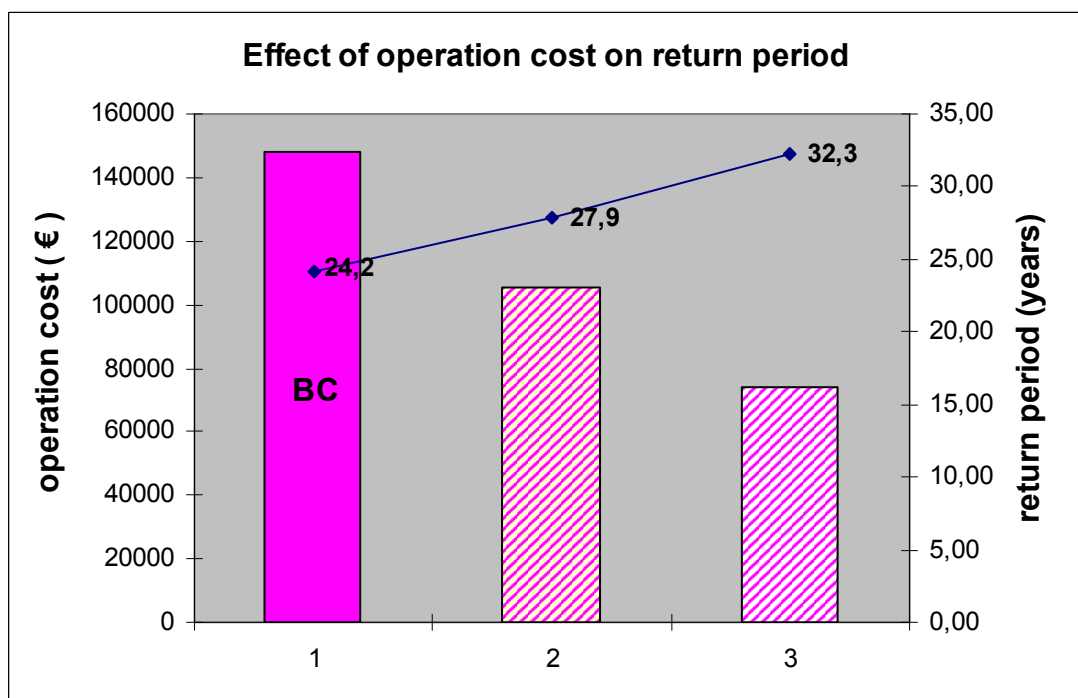

Fig. 6.9: Effect of operation cost on return period

**4-Input:** Effect of 5 % external costs (based on the first scenario (basic case (BC))).

**Output:** Costs lie between 0.22 and 0.09 €.

**Result:** Compared to original case no remarkable difference (Fig. 6.10).

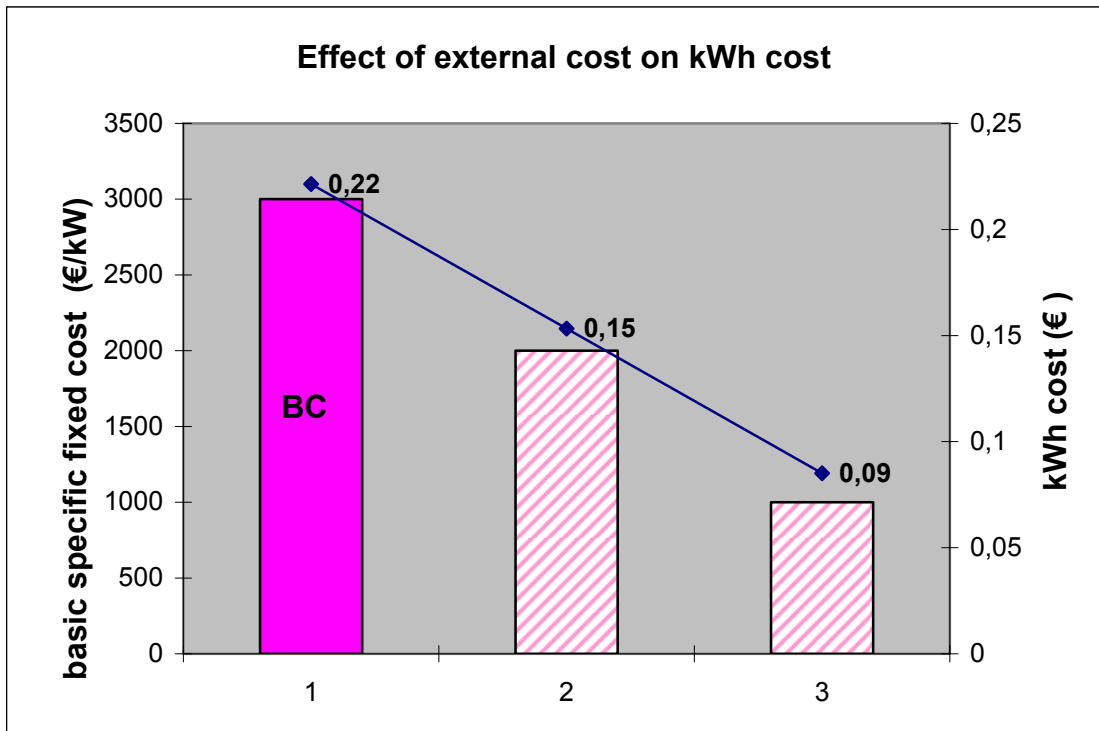

Fig. 6.10: Effect of external cost on kWh cost

## 6.6 Overall evaluation

The erection of gasification power plant that utilizes agricultural residues is possible from the technical point of view but special consideration should be given to waste management. The interest should be intensified in this direction as this is a limiting factor for the sustainable operation.

From the economical point of view, the use of the *cheap* manual labour makes up for the expensive technical system. The non-continuous operation allow room for everyday maintenance and monitoring thus extending the useful time.

Based on the undertaken factor of selling price = 110 % of cost then the price for the basic case at the first scenario will 0.23 €/kWh while the overall price profile is between 0.25-0.1 €/kWh.

## 6.7 Conclusions

- The kWh price profile (based on 110 % cost) for the above scenarios range between 0.27-0.1 €.
- The return period rate between 32-16 year.

## **7 Way Forward**

### **7.1 Summary of results**

The first step in this study was to investigate the energy and electricity situation in Sudan; main points were the current energy and electricity balance, electricity sources and consumptions sectors. Results show high unsatisfactory situation at both levels of production capability and geographical distribution. The main outcome is that more efforts for electricity generation are required to meet population need. In a vast land, characterized by low population density, decentralized systems offer comparative merits to central systems especially in urban centres of Sudan. In this context the capital Khartoum was found to enjoy relatively the best service standard while rest of Sudan is very critical. In the western regions of Sudan the situation is worse as utilization of other renewable sources is limited by different technical, geographical and social limitations. Under the current national and international conditions in Sudan then in spite the reliability of fossil fuel based power plant but the interest in other possibilities is highly justified by numerous economical, political and environmental considerations. Agricultural residues in Sudan shows high potential as renewable, environmental energy source and compared to other solid biomass then thermal utilization techniques in small scale power plant systems namely gasification is a cost effective and environmentally friendly technique. A scientific effort was needed to investigate the possibility of such vision, main questions raised here are: Are agriculture residues in Sudan suitable for thermal use, gasification specifically, could it be compared to classic fuel like wood? Other questions are there enough biomass, where, when and under which conditions is the biomass available? Here it was found that Groundnuts shells is the optimal fuel to be used, main merits are availability in relatively central place at a selected study area, absence of other competing uses and acceptable fuel proprieties. Unfortunately these merits are temporally and limited to fraction of year the fact that should be taken as main consideration within planning and operational processes for a suggested power plant. Under gasification condition of fixed bed gasifier at TU-Dresden the shells shows satisfactory results in respect to calorific value, gas production and the overall cold and hot gas efficiency. The majority of the tars types were Phenols which are relative soluble in water thus simplify the problem of tar content reduction in gas but intensify the waste management problem. From the technical point of view tar elimination is relatively controlled hurdle. However, considering agricultural gasification special interest should be given to gas quality in relation to component such as Nitrogen and Sulphur due to their adverse effects on process and environment. Thus the main challenge for such plants is the attaining of sustaniable and enivormentally friendly



## ***Way Forward***

---

waste management system, otherwise the high environmental and economical benefits of such projects will be destroyed. To assess if this technology could play a considerable role or not under urban western Sudan conditions then the required electricity amount was quantified and its profile illustrated. Factors affecting consumption were investigated to predict the consumption pattern in future. The results show that consumption is relatively low compared to national and international level. The consumption could be assumed to follow a mathematical equation in which income is the main factor. For realization of such vision the overall view of the operation conditions and the main components of a suggested power plant were presented. Issues discussed include questions as how the suggested power plant is could be differentiated from other *traditional* power plant? What are the main economic considerations under the present market conditions? Main outcomes are adoption of fixed bed gasifier with multi-stage gas cleaning system coupled to gas motor as basic components for BGPP. Under the local condition manual labour intensive is favoured to sophisticated automatic systems so process like feeding and ash disposing could be finished conveniently through man power. The main negative aspect is the absence of heat need. Measures such as pre air filtration, utilizing excess heat for preheating of gasification air, mixing fuel with tar collected are recommended as means for efficiency increase. The economical analysis of such power plant under local conditions shows that the initial specific cost is the main challenge not only being a relatively high sum of money which require special efforts for providing it but due to lower effect of other factors then a parameter such as return period is relatively constant. This could discourage *purely commercial* investment in such sector.

## **7.2 Conclusions**

The major conclusions that could be generated under study conditions and considering the assumptions and limitations undertaken are:

- Energy balance in Sudan is highly distorted both at production and consumption level. Biomass constitutes about 70 % of the primary energy, 33 % losses are observed at different stages from production to sale.
- The electricity services in Sudan cover only 13 % of the population, 45 % of them depend on decentralised system.
- Both thermal and hydro electricity generating systems in Sudan are not efficiently planned and operated
- For western Sudan the problem is intensified as other sources like hydroelectric are missing. Renewable like wind or solar are limited by the geographical location and technical restriction while petroleum is limited by political environmental and economical restrictions. Commercial use of wood is not recommended under current environmental conditions.

## *Way Forward*

---

- Non woody biomass could be used as suitable energy source encouraged by its economical and environmental merits like low cost and CO<sub>2</sub> neutral emission.
- Agricultural residues annual potential in Sudan could be estimated by 24 million ton with total energy content of ~350000 TJ. Less than 20 % is currently utilized, mainly as cooking fuel.
- Due to dry climate then gasification of agricultural residues could be seen as viable option.
- Electricity consumption for a household in the study area is mainly affected by income. For the official supplied sector it could be explained by the equation:

$$C = -0.493 + 0.699 I$$

Where: C= consumption, I= income

- Considering the economical situation in the study area then for the medium term (4-12 years) consumption for each hold could be assumed to be 4 kWh/day.
- A price of 40 SDD/kWh (~0.15 €) is suggested to be affordable in the study area under the current consumption and economical conditions.
- Due to its relative simplicity and low cost then fixed bed, down-draft gasifier with gas motor is the optimum technology under Sudan conditions.
- Fuel properties of some Sudanese agricultural residues are comparable to wood e.g. calorific value (GN.S ~18, wood ~18 MJ/kg), ash softening temperature (GN.S~1000°C, wood~ 1100°C).
- Gasification of pure GN.S under fixed gasifier is possible. It generates gas with calorific value up to 4 MJ/Nm<sup>3</sup> with gas extraction rate of 2 Nm<sup>3</sup>/kg at cold efficiency of ~ 50 %.
- Dust filtering and fuel preparation are the main different (compared to wood in Europe) components of BGPP in the study area in Sudan.
- The electricity price varies according to fixed, consumption and operation costs, in addition to extra waste management cost. The price profile ranges between 0.27 and 0.10 €/kWh.
- Return period is relatively independent of fixed cost; the relatively long return period is main economical obstacle.

The main outcomes of the suggested system could be seen in (Fig. 7.1).

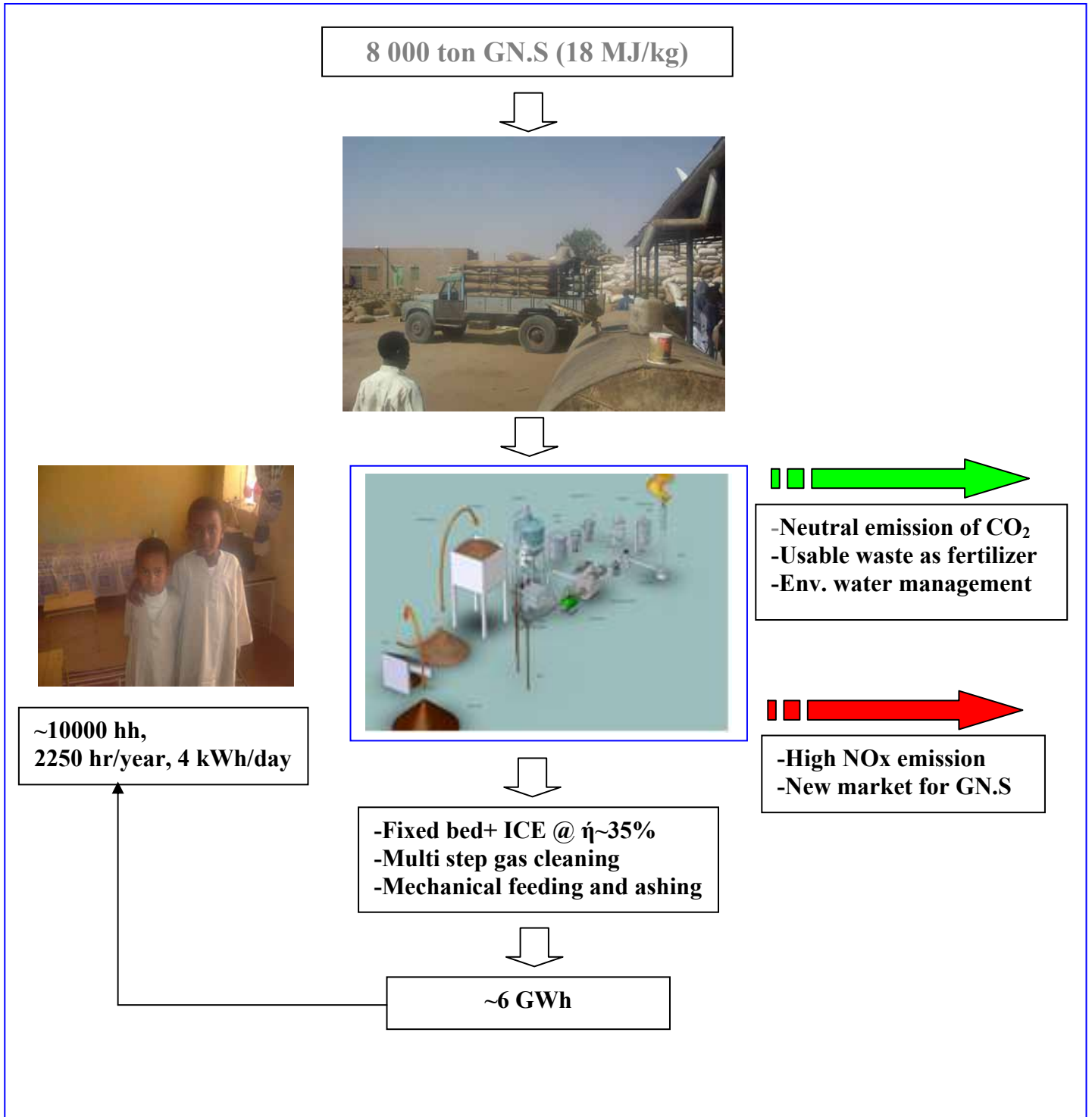

Fig. 7.1: Overview of the suggested system

### 7.3 Information Gaps

As stated in introduction one of the study objectives is identification of information gaps. This allows better understanding for the interrelation ship of different factors that governs the

## ***Way Forward***

---

thermal use of agricultural residues gasification for electricity generation and eventual the optimum power plant design and operation scheme. Therefore the following issues are mentioned:

### **Process<sup>27</sup> related information**

- Thermal behaviour tests at one piece level for different biomass types.
- Long term gasification experiments for selected biomass under different conditions.
- Optimization of gas cleaning system in relation to PG properties and engine requirement.
- Long term performance tests for engines derived by PG from non woody biomass.

### **Technology<sup>28</sup> related information**

- Prediction of biomass availability in future.
- Relationship between soil, cultivator and climatic conditions and fuel properties.
- Economics of internal transportation of biomass, storage and pre preparation process.
- Environmental effects of BGPP on micro environment especially waste management issues.
- Acceptance and preption of renewable energy resources and its final application.
- Economical, social, political and legal factors affecting erection of decentralized power plants.

## **7.4 Recommendation**

Concerning practical steps for introduction and integration of BGPP in Sudan the study recommends the following:

- Intensified academics studies for the above mentioned information gaps.
- Erection of (50-100) kW gasifier to serve as focal point for research work for such purpose.
- Better communication and collaboration with the different sectors, to insure support for the gasification research and projects e.g. community leaders, private sector, government and international partners.
- Introduction of economical programs to encourage private sector investment in electricity generation as general and through renewable energy specifically.

## **7.5 Limitation and application of the study**

The study is limited to identifying the main governing factors and their interrelationships, presenting basic quantitative results under the available time and expenses. The actual decision of applying this technology requires more research considering the above mentioned gaps.

---

<sup>27</sup> Process refer to the technical aspects of gasification and electricity generation process

<sup>28</sup> Refers to all issues related to commercial production of electricity based on biomass gasification systems.

## References

## References of Chapter 1

1. Sudan Energy Hand Book; NEA ; Khartoum- 2004,
2. Energy Information Administration; <http://www.eia.doe.gov>
3. Electricity annual report; NEC; Khartoum-2004; (Arabic version)
4. Electricity annual report; NEC; Khartoum-2004; (English version)
5. National Energy Evaluation, overall view; MOEM; Khartoum- 2001;(Arabic)
6. Assessments of the energy demands on semi-urban Sudan; MOE and UNDP; Khartoum- 2003
7. NEC, development medium plan 2005-2010 *personal information*
8. Bank of Sudan [www.bankofsudan.org](http://www.bankofsudan.org) , May-2007
9. Internal documents MEM; Khatoum-2006
10. National Energy evaluation, Renewable Sector; MOEM; Khartoum- 2001; (Arabic)
11. **Yates, T.;**  
Solar Cells in concentrating systems and their high temperature limitations. B.Sc Thesis;  
University of California; Santa Cruz- 2003  
[http://quantum.soe.ucsc.edu/research/SolarCell/Tarn\\_Senior%20Thesis.pdf](http://quantum.soe.ucsc.edu/research/SolarCell/Tarn_Senior%20Thesis.pdf)
12. Review of Renewable Energy Activities NEA – Khartoum; 1982
13. Sudan's first national communications under the United Nations framework convention on climate change , Volume 1, HCEN, Khartoum - 2003  
<http://unfccc.int/resource/docs/natc/sudnc1.pdf>
14. AFRO cover 2005; FAO global forest resources assessment 2005; Sudan country report; Khartoum-2006
15. **Ibrahim, F**  
Anthropogenic causes of desertification in western Sudan in *Geo Journal*;  
Vol.2, No. 3pp.:. 243-254; 1978
16. **Rahim, A.;**  
Economic analysis of deforestation: the case of the Gum arabic belt in Sudan PhD-thesis  
Wageningen University-2006
17. **Elmqvist B, , Olsson, L;. Elamin E; Warren; A.**  
A traditional agroforestry system under threat: an analysis of the gum Arabic market and cultivation in the Sudan, in *Agroforestry Systems* (64), pp.: 211–218; .2005  
<http://www.springerlink.com/content/k3744235100174qq/fulltext.pdf> ; 2005

- 18. Mahmoud, T.**  
The adequacy of price incentives on production, processing and marketing of Gum arabic in Sudan; Ph.d Thesis; TU- Dresden.- 2004
- 19. Taha M. E.**  
The socio-economic role of Acacia Senegal in sustainable development of rural areas in the gum belt of the Sudan; Ph.d Thesis; TU Dresden-1999.
- 20.** Handbook of forestry sector statistics; FNC-Sudan; Khartoum-1998
- 21.** MOA statistics; Khartoum -2005
- 22. Bakhiet, A.;**  
Towards a holistic definition of biomass availability in 15 European biomass conference; under publication; Berlin -2007
- 23. El Hassan A.;**  
La re`duction de la de`pendance e`nerge`tique du Soudan, Contribution potentielle des re`sidus d'origine agricole; Ph.d thesis CERAD-2000 ;.(French)
- 24. Ministry of Electricity**  
Report abut environmental and social hazard for electricity production in the power plant in Khartoum; April-2005 ( internal report)
- 25. E. Barton Worthington**  
The Nile catchment's; Technological changes and Adequate biology- 2005  
<http://www.iucn.org/themes/ceesp/Publications/SL/CT/Chapter%2012%20-%20The%20Careless%20Technology.pdf> ; May 2007
- 26. Gesellschaft für bedrohte Völker**  
<http://www.gfbv.de/inhaltsDok.php?id=761&stayInsideTree=1> ; May 2007

## References of Chapter 2

1. Population Statistics, El Nuhood Locality; Elnuhood-2005 (un published ) (Arabic)
2. **Ibrahim, A.;**  
The role of Acacia Senegal in the live hood of households in En-Nuhud province, western Kordofan state (Sudan); M.Sc. thesis; TU-Dresden-2005.
3. **El khidir,O.;**  
Elementary statistics and Experimental design; Khartoum- 2001
4. **Upton, M.;**  
The economics of tropical farming systems; Cambridge university press; Cambridge-1996
5. **Walonick, D.,**  
Survival statistics;  
<http://www.statpac.com/surveys/surveys.doc>
6. **Gomez, K; Gomez, A.;**  
Statistical procedure for agricultural research; John Wiley & Sons ; New York- 1984
7. **Bryman, A.; Cramer; D.;**  
Quantitative data analysis; Routledge – London-1999
8. **Neuman, W.;**  
Social research methods; Allyn & Bacon; Boston-2000
9. **Hinton, R.;**  
Statistics explained: A guide to social science students; London-1995.
10. **Jaeger, M.; Beisel, U.; Schweizer-Reis, P.;**  
Engendering participation in energy – related interventions: p practitioners and local perception in WERC; Florence-2006
11. **Bakhiet , A.;**  
Urban Energy in Developing Countries (UEDC) technical facts and human perceptions  
Doktoranden Seminar –Otto von Guericke Universität; Magdeburg- 2007
12. **Schwizer –Reis, P.; Villalobos Montoya, C.;**  
Involvement of end-users in multi user solar hybrid grids- implication for professionals in the field; 18 -European photovoltaic solar energy conference ; 2004
13. **Bakhiet; A.;**  
Towards holistic evaluation of biomass availability; 15 European conference for biomass;  
Berlin- 2007
14. National forest inventory FNC- Sudan; Khartoum -1995



- 15.**Hand book of forestry sector statistics; FNC-Sudan; Khartoum-1998
- 16.**FNC statistical records-2005 (Arabic)
- 17.Mahmoud, T.;**  
The adequacy of price incentive on production, processing and marketing of Gum arabic in Sudan; Ph.d thesis ; TU-Dresden 2004.
- 18.Valk, M.;**  
Thermo chemical conversion of agricultural residues to energy; UNIDO Vienna-1986
- 19.**Federal Ministry of Agriculture Statistics; Khartoum- 2005 (Arabic)
- 20.Osman, A.;**  
Groundnuts production in rain fed traditional sector; Ministry of Science & Technology; Khartoum-2003 (Arabic)
- 21.**El Nuhood Crop market records-2004 (Arabic) (un published )

## References Chapter 3

- 1. FAO Bio energy Report;**  
Committee of agriculture 19th Session, Rome-2005,  
<http://www.fao.org/docrep/meeting/009/j4313e.htm>
- 2. Erneuerbare Energien,** BMU – Germany; 2004.
- 3. Sptizer, J;**  
Umwandlung von Biomasse in elektrische Energie und Kraftstoffe; in Biomassevergasung der Königweg für eine effiziente Strom und Kraftstoffbereitstellung; FNR Schriftreihe Band 24; Münster -2004.
- 4. Hofbauer, H.; Nordenkampf, M.; Kaltschmitt, M.; Vogel, A.;**  
Stromerzeugung über die Biomassevergasung; Herausforderung und Perspektiven in Biomassevergasung; der Königweg für eine effiziente Strom und Kraftstoffbereitstellung; FNR Schriftreihe Band 24; Münster -2004
- 5. Schwarz, W.;**  
Technische und wirtschaftliche Aspekte von Cogeneration- Anlagen in Europa; Diplomarbeit - Institut für Volkswirtschaftslehre, der Karl-Franzens Universität; Graz -2003
- 6. Koppe, K.; Juchelkova, D.;**  
Nutzung der Biomasse; Ostrava-2003
- 7. Reed, T.; Jantzen, D.;**  
Introduction; in Biomass gasification, principles and technology; New Jersey- 1981
- 8. Hartmann, H;**  
Ernte und Aufbereitung in in Energie aus Biomasse; M. Kaltschmitt und H. Hartman (hrsg); Springer Verlag; 2001.
- 9. Hartmann, H;**  
Transport, Lagerung, Konservierung und Trocknung in in Energie aus Biomasse; M. Kaltschmitt und H. Hartman (hrsg); Springer Verlag; 2001.
- 10. Klass, D.;**  
Biomass for renewable energy, fuels, and chemicals; San Diego-2004
- 11. Hartmann, H.; Thuneke, K.; Höldrich, A.; Roßmann, P.;**  
Handbuch Bioenergie- Kleinanlage; FNR; 2003
- 12. Hofbauer, H; Kaltschmidt, M**  
Thermochemische Umwandlung in Energie aus Biomasse; M. Kaltschmitt und H. Hartman (hrsg); Springer Verlag; 2001
- 13. Bakhiet, A.; Hiller, A.; Wilhem, R.;**  
Agricultural residues gasification in fixed bed gasifier in proceeding of the 15 European conference for biomass; Berlin- 2007

- 14. Reed, T.;**  
Types of gasifiers and gasifiers design consideration; in Biomass gasification, principles and technology; New jersey-1981
- 15. Kubel, M.;**  
Vergasungstechniken; in Hersteller und Marketbetrachtung der Thermo-chemische Umwandlung Von Biomasse Arbeitbericht für FNR; Nordenkampf, M;( Ed).  
[http://www.hessenenergie.de/Info-Bereiche/Biomasse\\_Holz/Verstromung-fester-Biomasse/Biomassevergasung1-Hersteller-%20und%20Markt-betrachtung.pdf](http://www.hessenenergie.de/Info-Bereiche/Biomasse_Holz/Verstromung-fester-Biomasse/Biomassevergasung1-Hersteller-%20und%20Markt-betrachtung.pdf)
- 16.**<http://www.frontlinebioenergy.com/id17.html>
- 17. Schneider, M.;**  
Untersuchung von Möglichkeiten für Produktion eines wassernreichen Brenngas durch holz Vergasung , Grosses Beleg Nr. 696 TU- Dresden- 1999
- 18. Henriksen, U.; Ahrenfeldt, J ; Kvist ,T.; Jensen Gøbel., B, Bentzen, J.; Hinds Gaul, C ; Sorensen , L.;**  
The design, construction and operation of a 75 kW two-stage gasifiers; presented in ECOS - Copenhagen, Denmark-2003
- 19. Vogel, A.;**  
Dezentrale Strom und Wärmeerzeugung aus biogenen Festbrennstoffen; Ph.D Thesis; TU Hamburg-Harburg -2007
- 20. Van der Drift, A.; Boerrigter, H.; Coda, B.; Cieplik M.; Hemmes, K.;**  
Entrained flow gasification of biomass; ECN Reports ECN C 04-039; 2004  
<http://www.ecn.nl/docs/library/report/2004/c04039.pdf>
- 21. Karl, J.;**  
**Wirbelschichtvergasung;** Stand der Technik in Biomasse Vergasung; der Königsweg für eine effiziente Strom und Kraftstoffbereitstellung ; FNR Schriftreihe Band 24; Münster-2004
- 22. Dahmen, N.;**  
Synthesekraftstoff aus Stroh- Das Karlsruhe BTL-Konzept in Einsatz von Biomasse in Verbrennung und Vergasungsanlagen. VDI- Wissensform; Leipzig- 2004
- 23. Wood gas as engine fuel , FAO, Rome 1986**  
<http://www.fao.org/docrep/t0512e/t0512e00.htm>
- 24. Kleinhapfl, M.;**  
Festbett Vergasung –Stand der Technik in Biomasse Vergasung – der Königsweg für eine effiziente Strom – und Kraftstoffbereitstellung ; FNR Schriftreihe Band 24; Münster-2004
- 25. Desrosiers, R.;**  
Thermodynamics of gas – Char Reactions in Biomass gasification, Principles and Technology; New jersey-1981
- 26.**<http://www.btgworld.com/technologies/gasification.html>

- 27. Vogel, A.; Kaltschmitt, M.; Nordenkamp, M.;**  
Festbettvergasung zur Stromerzeugung- Lessons learned in Biomasse Vergasung der Königsweg für eine effiziente Strom – und Kraftstoffbereitstellung; FNR Schriftreihe Band 24 Münster- 2004
- 28. Kaltschmitt, M.; Baumbach, G.,**  
Grundlagen der thermochemischen Umwandlung; in Energie aus Biomasse; M. Kaltschmitt und H. Hartman (hrsg); Springer Verlag-2001
- 29. Knoef, H.;**  
Hand book of biomass gasification, Enschede-2005
- 30. Klemm, M.;**  
Heißenteerung von Brenngas aus der Vergasung von Biomasse durch katalytische partielle Oxidation,; VDI Fortschritt-Berichte, Nr.525; Düsseldorf- 2005
- 31. Nordenkamp, M.;**  
Gas Reinigung; in Hersteller und Marketbetrachtung der Thermo-chemische Umwandlung von Biomasse; Arbeitbericht für FNR; M. Nordenkamp ( Ed)-  
[http://www.hessenenergie.de/Info-Bereiche/Biomasse\\_Holz/Verstromung-fester-Biomasse/Biomassevergasung1-Hersteller-%20und%20Markt-betrachtung.pdf](http://www.hessenenergie.de/Info-Bereiche/Biomasse_Holz/Verstromung-fester-Biomasse/Biomassevergasung1-Hersteller-%20und%20Markt-betrachtung.pdf)
- 32. Mörsch, O.;**  
Entwicklung einer online Methode zur Bestimmung des Teergehalts im Gas aus der Vergasung von Biomasse ; VDI Fortschritt-Berichte Nr.853; Düsseldorf- 2000
- 33. Aichernig, C.**  
Project "Wiener Neustadt in Internationale Tagung Thermo-chemische Biomasse-Vergasung für eine effiziente Strom-/Kraftstoffbereitstellung - Erkenntnisstand ; Leipzig 27-28. Februar 2007  
[http://www.energetik-leipzig.de/Veranstaltungen/13\\_Aichernig.pdf](http://www.energetik-leipzig.de/Veranstaltungen/13_Aichernig.pdf)
- 34. Devi L, Ptasinski .k; Janssen F**  
A review of the primary measures for tar elimination in biomass gasification processes in Biomass and Bioenergy ; 24 pp.:125 – 140; 2003
- 35. Hansen, C.;**  
Physical and Chemical Characterization of Particles in Producer Gas; Master Thesis; TU- Denmark-1998
- 36. Schmid, M.;**  
Dezentrale Strom Erzeugung mit Feststoffbiomasse; Ökozentrum – Langenbruck- 2007
- 37. [http://energytech.at/\(de\)/kwk/portrait\\_kapitel-2\\_6.html](http://energytech.at/(de)/kwk/portrait_kapitel-2_6.html)**
- 38. Hofbauer, H.;**  
Neue Entwicklungen bei der Stromerzeugung aus Biomasse;  
<http://www.normen.at/akademie/Hofbauer.pdf>
- 39. Norheim, A; Skreiberg ; Hustad, J.;**  
Electricity generation from producer gas -State of technology - Fuel Cell in International Tagung Thermo-chemische; Biomasse-Vergasung für eine effiziente Strom-

- 40.Oudhuis, A.; Bos, A.; Ouweltjes, J.; Rietveld, G.; van der Giesen, A.;**  
High efficiency electricity and products from biomass and waste;  
Experimental results of proof of principle of staged gasification and fuel cells  
ECN Reports; ECN-RX--04-045; May 2004
- 41.Herdin; G.**  
Biomassenutzung zur Stromproduktion; Vergleich verschiedener Techniken;  
Jenbacher AG
- 42.Jeng-Chyan Muti Lin,**  
Combination of a biomass fired updraft gasifier and a Sterling engine for power production in  
*Journal of Energy Resources Technology*; Volume 129, Issue 1; pp.: 66-70, 2007
- 43.Hellat, J.; Wimmer, A.; Strasser, C.;**  
Elektrizitätserzeugung aus Schwachgas; stand der Technik aus der Motorensicht in Biomasse  
Vergasung – der Königsweg für eine effiziente Strom – und Kraftstoffbereitstellung; FNR  
Schriftreihe Band 24, Münster 2004
- 44.Barrio, M.; Fossum, M. ; Hustad, J.;**  
A small-scale stratified downdraft gasifier coupled to a gas engine for combined heat and  
power production.
- 45.Stassen , H ; Koele, H.;**  
The use of LCV- gas from biomass gasifiers in internal combustion engines; in biomass  
gasification and pyrolysis; M.Kaltschmitt and A. Bridgewater (Ed) ; CPL- Press UK-1997
- 46.Haselbacher, H.;**  
Gas turbines for electricity production from LCV gas in Biomass gasification and pyrolysis  
M.Kaltschmitt and A.Bridgewater (Ed) ; CPL- Press UK-1997
- 47.Biomass Engineering Ltd.**  
Development of a micro turbine plant to run on gasifier producer gas  
B/U1/00762/REP URN NUMBER: 06/675
- 48.Stahl, K.; Neergaard, M.; Nilsson, P-A.,**  
Pressurized CFB Gasification- The Värnamo Plant; in Biomass gasification and pyrolysis  
M.Kaltschmitt and A.Bridgewater (Ed) ; CPL- Press UK 1997
- 49. Kautz, M.;Hansen,U.;**  
The externally-fired gas-turbine (EFGT-Cycle) for decentralized use of biomass in *Applied  
Energy* 84;pp.: 795–805; 2007
- 50.Schmid, M.,**  
Talbot -100 Kw project (personal information)

## References of Chapter 4

1. **Klass, D.;**  
Biomass for renewable energy, fuels and chemicals; San Diego - 2004
2. **Nussbaumer, T.; Kaltschmitt, M.;**  
Grundlagen der festbrennstoffnutzung in Energie aus Biomasse; M. Kaltschmidt und Hartman. H.; (Hrsg.); SpringerVerlag - 2001
3. **Hartmann, H.;**  
Biomasse als Energieträger in Biomasse Vergasung - Der Königen weg für eine effiziente Strom und Kraftstoffsbereitstellung; FNR band No. 24; Münster – 2004
4. **Jenkins, M.; Baxter, L.; Miles, Jr.; Miles, T.;**  
Combustion properties of biomass. in *Fuel Processing Technology* No.54, pp17–46; 1998
5. **von Puttkamer, T.;**  
Charakterisierung biogener Festbrennstoffe; Ph.d thesis; IVD - Universität Stuttgart 2005
6. **Graboski, M.; Bain, R.,**  
Properties of biomass relevant to gasification. in "Biomass gasification, principles and technology" Tom reed (Editor); New Jersey-1981
7. **Koppe, K.; Juchelkova, D.;**  
Nutzung der Biomasse; Ostrava-2003
8. **Sridhar, G.; Sridhar, H.; Dasappa, P.; Rajan, N.; Shrinivasa, U.; Mukunda, H.;**  
Technology for gasifying pulverized bio fuels including agricultural residues; in *Energy for sustainable development* Volume III No.2- 1996; pp.:9-18.
9. **Carvalho, I.;**  
Agriculture biomass for small scale combustion systems; M.Sc thesis; Lulea University of technology; Sweden – 2006.
10. <http://www.frontlinebioenergy.com/id15.html>; 2.9.2006
11. **Zhang, X., Xu, M.; Sun, R.; Sun, L.;**  
Study on Biomass Pyrolysis Kinetics; *Journal of Engineering for Gas Turbines and Power*; Vol. 128, No. 3- 2006, pp. 493–496.
12. **Hartmann, H.;**  
Transport , Lagerung, Konservierung und Trocknung in Energie aus Biomasse, M. Kaltschmidt und Hartman. H.; (Hrsg.); Springer Verlag - 2001
13. **Hartmann, H.; Thuneke, K.; Höldrich, A.; Roßmann, P.;**  
Handbuch Bioenergie- Kleinanlage; FNR; 2003
14. **Haykırı-Açma, H.; Erol, M.; Küçükbayrak, S.;**

Estimation of heating values of biomass, WERC; Florenz- 2006

**15.Barrio,M.;**

[www.tev.ntnu.no/MariaBarrio/dring/biomass.pdf](http://www.tev.ntnu.no/MariaBarrio/dring/biomass.pdf)

**16.Kaltschmitt, M.; Merten, D.; Fröhlich N.; Nill, M.;**

Energiegewinnung aus Biomasse, Report für WBGU-2003

**17.Schneider, M.;**

Untersuchung von Möglichkeiten für Produktion eines wassersreichen Brenngas durch Holzvergasung , Grosse Beleg Nr. 696; TU- Dresden- 1999

**18.van Passen, S.; Kiel, J.;**

Tar Formation in fluidized bed gasifier; ECN Report No.C-04-013;. 2004

**19.Küçükbayrak, S.; Haykiri-Acma, H.;**

Relation between proximate analysis results and combustion characteristics of Biomass; in WREC;Forenz-2006

**20.Koppe, K.;**

Einführung in das Praktikum; Studien Brief; TU Dresden-2002

**21.The microbial world;**

<http://helios.bto.ed.ac.uk/bto/microbes/nitrogen.htm#Top>

**22.Krogh, L.;**

Field and village nutrient balances in Millet cultivation in northern Burkina Faso; in *Journal of Arid Environment* Vol.35-1997; pp.:147-159.

**23.Buschiazzo, E.; Aimar S.; Garcia queijeir, J.;**

Long-term Maize, Sorghum, and Millet monoculture effects on an Argentina typic Ustipsamment in *Arid Soil Research and Rehabilitation*, vol.13-1999, pp.:1- 15,

**24.Vetter, A.; Herring, T.;**

Bereitstellungskosten und Qualitäten land- und forstwirtschaftlicher Energieträger. KWK Kolloquium; Dresden -2005

**25.Wikpikaida - periodic table**

**26.van Drift, A.; Olsen,.A.;**

Conversion of biomass, predication and solution methods for ash agglomeration and related problems; ECN-C-99-090; Holland-1999

**27.Tuomas, V.;**

Potassium behaviour during combustion of wood in circulating fluidized bed power plants; Ph.d thesis; Helsinki University of technology- 2000

**28.Klärschlammverordnung (AbfKlärV); 15- April 1992**

**29.[www.nscorp.com/nscorphtml/coal/glossary/definitions.html](http://www.nscorp.com/nscorphtml/coal/glossary/definitions.html) (12.9.2006)**

- 30.** [www.flyash.org](http://www.flyash.org)
- 31. Pels, J.; De Nie, D.; Kiel, J.**  
Utilization of ashes from biomass combustion and gasification; 14 European biomass conference and exhibition; Paris -2005
- 32. Obernberger, I.; Biedermann, F.; Widmann, W.; Riedl, R.;**  
Concentration of inorganic elements in biomass fuels and recovery in different ash fractions in *Biomass and Bioenergy*; Vol.12 No. 3-1997; pp.: 211-224.
- 33. Dockert, B; Kurt, E.;**  
Development of management options for biomass combustion by products; International ash utilization symposium; paper 82; University of Kentucky; <http://www.flyash.info>
- 34. Heinrich, H.;**  
Die Verwendung von Holzaschen aus Biomassefeuerungen zur Düngung von Acker und Grünland; Ph.d thesis; Wien Universität -1999  
<http://www.2-arcs.ac.at/dissdb/rn033726>, 13.09.2006
- 35. Bridgewater, A.;**  
The future for biomass pyrolysis and gasification: status, opportunities and policies for Europe Bio-Energy Research Group; Aston University ; Birmingham B4 7ET, UK -2001
- 36. Obernberger, I.;**  
Asche aus Biomassefeuerung, Zusammensetzung und Verwertung; VDI Bericht No.1319; Düsseldorf -1997
- 37. van der Drift, A.; Boerrigter, H.; Coda, B.; Cieplik, M.; Hemmes, K.;**  
Entrained flow gasification of biomass; ash behaviour, feeding issues, and system analyses Report No. ECN-C -04-39; Holland -2004
- 38. Korsgren, J.; Hald, P.; Davidsson, K.; Pettersson, J.;**  
Characterization of alkali metal emission from fuels and samples collected from fluidized bed gasification; in proceedings of the 15 th international conference on fluidized bed combustion; May-1999
- 39. Arvelakis, S.; Folkedahl, B.; Johansen, K.; Hurley, J.;**  
Studying the melting behaviour of coal, biomass, and coal/biomass ash using viscosity and heated stage XRD data in *Energy Fuels*, Vol.20 (3)-2006; pp.: 1329 -1340.
- 40. Gabra, M.,**  
Study of possibilities and some problems of using cane residues as fuel in a gas turbine for power generation in sugar industry; Ph.d thesis- Lulea university of technology; Sweden-2000
- 41. Miles, P.; Miles, J.; Baxter, L.; Bryers, R.; Jenkins, B.; Oden, L.;**  
Alkali deposits found in biomass power plant; Summary report for NREL  
[http //www. Trmiles.com/alkali/alkali.htm](http://www.Trmiles.com/alkali/alkali.htm) 14.09 .2006
- 42. Sorensen, L., Fjellerup, J.; Henriksen, U; Moilanen, A.; Kurkela. E.; Winther, E.;**  
An evaluation of char reactivity and ash properties in biomass gasification;



Denmark- Rea tech; 2000

**43.Scott T, et al**

An experimental investigation of alkali removal from biomass producer gas using a fixed bed of solid sorbent; in *Industrial& Engineering Chemical Research.* ; Vol.40-2001, pp: 1960-1967.

**44.Davidsson, K.; Korsgern, J.; Pettersson, J.; Jäglid U;**

The effect of fuel washing techniques on Alkali release from biomass; in *Fuel* vol.81, No.2-2002; pp.:137-142

**45.Bakhiet, A.; Gebauer, K.; Koppe, K.:**

Vergasung landwirtschaftlicher Abfälle mit dem Ziel der Stromerzeugung. in: Bilitewski, B.; Schnurer, H; Zechmar-Lahl, B. (Hrsg.): Müllhandbuch. Erich Schmidt Verlag; Berlin-2006.

## References of chapter 5

1. **Hiller, A.;**  
Beiträge zur energetischen Nutzung von Biomassen in ZWSF-Anlagen und Festbettvergasungs-anlagen; Ph.d Thesis ; TU-Dresden-2004.  
<http://nbn-resolving.de/urn:nbn:de:swb:14-1090402071796-88678>
2. **Klemm, M.;**  
Heißenteerung von Brenngas aus der Vergasung von Biomasse durch katalytische partielle Oxidation; VDI Fortschritt-Berichte; Nr.525; Düsseldorf- 2000
3. Vergaser Praktikum script  
TU- Dresden -2003
4. **Jargstorf .B.;**  
Biocoal from Groundnuts shells in PYNE newsletter issue 13; May-2002  
[www.pyne.co.uk/doc](http://www.pyne.co.uk/doc)
5. **Valk,M.;**  
Thermo-chemical conversion of agricultural residues in Sudan to energy;  
Vienna-1986
6. [http://www.teriin.org/case\\_inside.php?id=17066](http://www.teriin.org/case_inside.php?id=17066)
7. **Evans, R.; Czernik,S.; Chornet, E.; Feik,C.; French, R.; Philips, S.;**  
Engineering scale of renewable hydrogen production by catalytic steam reforming of peanuts shells pyrolysis products. in proceeding of U.S DOE hydrogen Program Review; NERL/CP-610-32405; 2002
8. **Dahmen, N.;**  
Synthese Kraftstoff aus Stroh in VDI Wissensform Einsatz von Biomasse in Verbrennung und Vergasung Anlagen; Leipzig 2004
9. **Bentzen, J.; Hindsgaul, C.; Henriksen, U.; Sorensen, L.;**  
Straw gasification in a two stage gasifier, TU-Denmark
10. [www.miscanthus.de/kurzsinfo.htm](http://www.miscanthus.de/kurzsinfo.htm)
11. **Jonge, W.de.; Andries, J.; Hoppesteyn, P.;**  
Miscanthus Gasification in a Pressurised Fluidised Bed Gasifier; in Proceedings of the 1st World Conference on Biomass for Energy & Industry, Spain- 2000. pp.1595-1598,
12. <http://webbook.nist.gov/>
13. <http://de.wikipedia.org/>

14.<http://en.wikipedia.org/>

**15.Biomass Engineering Ltd.**

Development of a micro turbine plant to run on a gasifier producer gas; B/U1/00762/REP  
URN No. 06/675

**16.Dogru, M.; Howarth, C.; Akay, G.; Keskinler, B.; Malik,A.;**

Gasification of hazelnut shells in a downdraft gasifier in *Energy* No.27; pp. 415–427; 200

**17.Wilhem, R.;**

Einfluss auf die Produktgaszusammensetzung in einem Festbettvergaser durch  
Brennstoffvariation; Diplomarbeit TU-Dresden- 2002

**18.Giordano P.; Hasler, P.; Dasappa, S.;**

Test of different biomass into the IISc open top co-current gasifier; Final report for Project  
39772; Contract 80847; Swiss Federal Office of Energy-2001

**19.Mörsch, O.;**

Entwicklung einer online Methode zur Bestimmung des Teergehalts im Gas aus der  
Vergasung von Biomasse, VDI Fortschritt-Berichte Nr.853, Düsseldorf- 2000

**20.Gabra, M.;**

Study of possibilities and some problems of using cane residue as fuel in a gas turbine for  
power generation in the sugar industry; Ph.d thesis; Luella University of technology Sewden-  
2000

**21.Bakhiet, A.;Hiller; A.;Wilhem, R.;**

Agricultural residues gasification in fixed bed gasifier in proceeding of the 15 European  
conference for biomass, Berlin- 2007

**22.Graboski, M.; Bain R.;**

Properties of biomass relevant to gasification in biomass gasification T.Reed (Ed)

**23.Patisson, F.; Ablitzer, D.;**

Physicochemical and thermal modeling of the reaction between a porous pellet and gas in  
*Powder Technology* 128, pp300– 305; 2002.

**24. Erlich, C.; Bjornbom, E.; Bolado, D.; Giner, M.; Fransson,T.;**

Pyrolysis and gasification of pellets from sugar cane baggase and wood in *Fuel* 85  
pp.1535–1540; 2006

**25.Klemm, M.; Wilhelm, R.; Schneider, M.;**

Erzeugung eines anwendungsgerechten Brenngases aus Biomasse in einem system aus  
Gleichstromvergaser und Heißenteuerung in Beiträge zum Abschlussworkshop. LIES  
Dresden-2005

## References of Chapter 6

1. **Straus, K.;**  
Kraftwerkstechnik, Springer Verlager-2006
2. **Koppe, K.;**  
Auslegung und Gestaltung von Energieanlagen; Studien brief; TU-Dresden-2006
3. **Knoef, H.;**  
Hand book of biomass gasification, Enschede-2005
4. **Wood power, personal information**
5. **Vogel, A.;**  
Dezentrale Strom und Wärmeerzeugung aus biogenen Festbrennstoffen; Ph.D Thesis; TU-Hamburg-Harburg -2007
6. **Herdin, G.;**  
Standesanalyse des Gasmotors imVergleich zu den Zukunftstechniken (Brennstoffzellen und Mikroturbine) bei der Nutzung von aus Biomasse gewonnenen Kraftstoffe; Jenbacher AG

# Appendices

## **Appendix 1-A**

### **Sudan; Overview**

#### **Land and People**

Sudan lies in North- East Africa broadening the Red Sea, surrounded by nine countries. It is considered the largest country in Africa with an area of about 2,500,000 km<sup>2</sup>.

Geographically Sudan extends between latitude 3° and 22° N and longitude 21°–39°E. This vast area consists of different ecological zones from deserts in extreme North to tropical rain forest in extreme South with an average rainfall of 200–500 mm/year in the middle.

Demographically Sudan has varying population density ranging from 3-162 person/km<sup>2</sup> with total population of 36 million (in 2003 estimated from 1993 census) and average family size of 6, this accompanied with average growth rate of 2.2 %.

Politically Sudan is a federal state under a presidential government. It is composed of 26 states (Wilaya), however for the sake of this research purposes only regional division will be considered i.e. North, East, West (Kordufan+ Darfur), South and Central Sudan in addition to the capital Khartoum. See Fig. (1I), Table (1I) (Source: [www.unfpa.org](http://www.unfpa.org), [www.fao.org](http://www.fao.org))

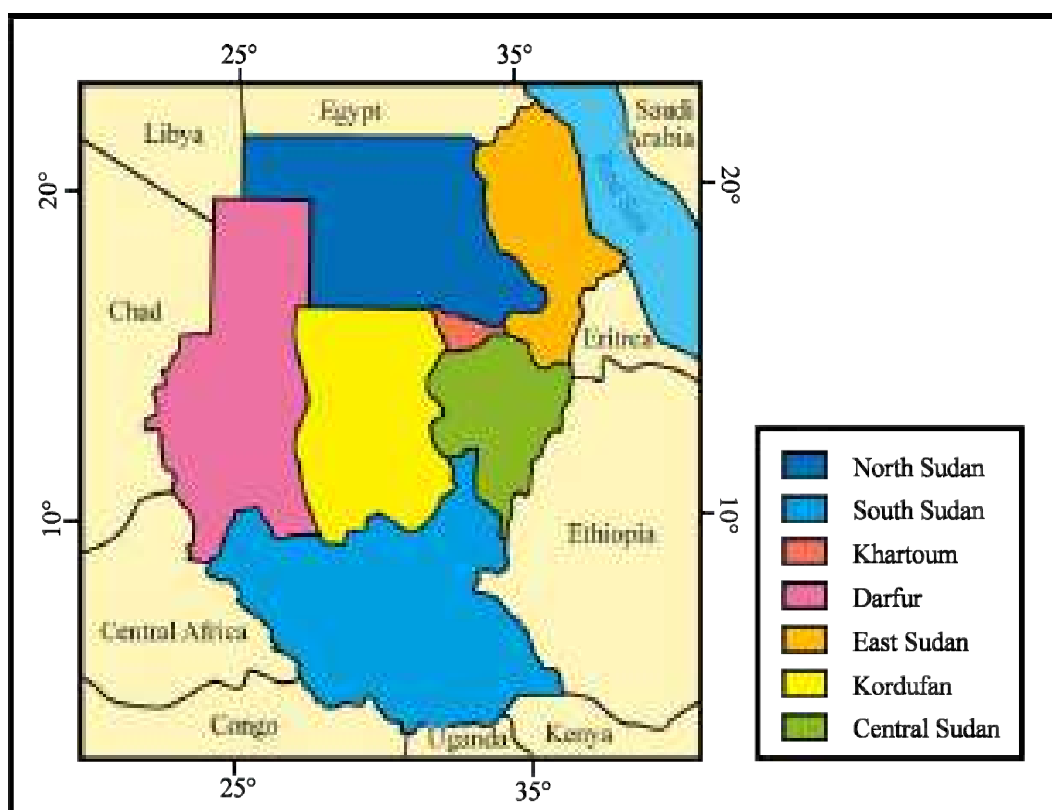

**Fig. 1I: Sudan geographical situation and internal divisions**

**Table II: Sudan demographic characteristics (1993)**

<b>Region</b>	<b>Area (million hectare)<sup>a</sup></b>	<b>Population (million)<sup>b</sup></b>
North	48	1.3
South	65	3.8
Khartoum	20	3.4
East	14	3.1
Central	34	5.4
Darfur	50	4.7
Kordufan	38	3.2

<sup>a</sup> Area rounded to nearest million hectare

<sup>b</sup> Population 1993 census rounded to next 100 thousand

**Source: Hand book of forestry statistics 1998**

## **Appendix 1-B** **Crops in Sudan**

### **Groundnuts, *Arachis hypogaea* L.**

It is annual bushy plant which extends about 25 cm above ground. Fruits are found as capsules (shells) underground and its main residues are in form of shells each about 3 cm length. Groundnuts is a cash crop grown for local oil extraction or for export as raw nuts Groundnuts is cultivated mainly in western Sudan but it is also common in some irrigated schemes mainly Gezira (central Sudan). In western Sudan it is cultivated in July/August and harvested in November/December

The main use of residues (shells) is for animal fodder (mixed with other components) or as second class fuel.



**Source: Field results**

**Sorghum, *Sorghum bicolor*** (L.) Monech)

annual grassy cereal producing plant with height up to 2m above ground .Useful part (seeds) is found in heads. It is cultivated nearly all over Sudan, within the rain fed traditional and mechanised sectors (especially eastern Sudan).

In western Sudan it is cultivated in July/August and harvested in November.

Residues are mainly in form of stalks. They are generally used as animal fodder and as a local building material for light structures.



**Source: Field results**

**Millet, *Pennisetum glaucum*** (L.) R. Br.

Annual grassy, cereal producing plant of height up to 1.5 m. Millet and Sorghum belong to the same *family* and are the main staple food in Sudan. The cultivation of such crops is the main objective of the subsistence agriculture system. In western Sudan, Millet is cultivated in May as dry season cultivation or more commonly in July and harvested in October/November. The residues (stalks) are used as fodder with possible use as local building material for light structures.



**Source: Field results**



**Sesame, Sesamum indicum L.**

Sesame is a typical cash crop in Sudan . Sesame seeds are valuable export product in addition to its use by the local cooking oil and food industries. Sesame is a perennial crop and it is mainly concentrated in eastern Sudan within the rain fed mechanized sector. Sesame is a grassy annual crop with length about 1m above ground, fruits are found in light capsules above ground. In western Sudan it is cultivated in July and harvested in November. There is no remarkable use for residues (stalks).



**Source: Field results**

**Roselle, Hibiscus sabdariffa (L.)**

Roselle (hibiscus) is annual grassy plant with length about 1m aboveground. The useful part is the flowers which are used for drinks or as medicinal herb. A local market exists but the main market is the international market. The main production area is western Sudan in which it is cultivated in August and harvested in November. There is no remarkable use for the residues (stalks).



**Source: Field results**

### **Sugar cane, *Saccharum officinarum***

Sugar cane is a grass with stout jointed fibrous stalk which is 2-6 m tall. In Sudan it is cultivated by the sugar companies for sugar production in the so called factory farms. Together with cotton they are only grown on irrigated industrial levels mostly in central Sudan. Sugar cane residues are used mainly by the factories to satisfy some energy needs (through combustion). Surplus are recorded, which sometimes used in animal fodders industry. In Sudan, Sugar cane is planted as *ratoons* and harvested in November.



Source: <http://en.wikipedia.org/wiki/Sugarcane>.

### **Cotton *Gossypium***

Cotton is perennial shrub (cultivated in annual bases) with length up to 1 m with the *flowers fibers* been the most important part which is grown in Sudan as a cash crop. Cotton was considered for more than 80 years the main export for Sudan thus contributing by about 45 % to GDP. It is mainly cultivated in Gezira scheme (central Sudan). The use of residues was legally forbidden but this law was amended in the eighties (to allow for a carbonization project to take place). In Gerzira it is planted in July and harvested twice in December and February.



Source: <http://en.wikipedia.org/wiki/cotton>

Text sources: [www.wikipedia.com](http://www.wikipedia.com), Filed results

## Appendix 2-A

### Questionnaire and key informants sheet

#### Questionnaire about energy consumption in El Nuhood town, January 2006

Serial no: □□□

#### 1 Demographic and social characteristics

- a) Name of household head -----
- b) Tribe-----
- c) Date of residence-----
- d) Original residence-----
- e) No of family members-----
- f) No of families in house-----
- g) No of housing/ unit house hold-----
- h) No of rooms in house -----
- i) House hold members -----

Name	Age (yr)	Educational level	Occupation	Sex

#### 2 Economic status

##### 2.1 House information

House location		House structure			Ownership	
in city /down town	outskirts	permanent	temporary	mix	owned	rented

##### 2.2 Monthly income

- Less than 50 000 SDD
- Between 50 000and 100 000
- Between 100 000and 200 000
- Greater than 200 0000

##### 2.3 Properties

Please fill in the following table which explain your assets

livestock		Real states		Vehicles and mc		Others	
type	amount	type	area	type	amount	type	Amount

### 3 Energy & Electricity consumption

#### 3.1 What are the energy sources in your house?

- Electricity
- Wood/charcoal
- Kerosene
- LPG
- others

#### 3.2 If you use electricity, then please state the source

- NEC
- Outside production
- Private production

#### 3.3 Does NEC provide electricity around your house

- yes
- No

#### 3.4 Do you use the electricity of the NEC

- yes
- No

#### 3.5 If you are not using NEC services, then why?

- High initial cost
- High running cost
- Both 1, 2
- Others

#### 3.6 Please fill in the table below concerning the electric devices you have:

Name of device	quantity of each device	Electricity consumption of each device(kW)	consumption duration (hr/day)	Remarks

#### 3.7 Please give information about your daily routine according to the following table:

Time	5-8	8-15	15-19	19-23	23-5
Detailed activities					
Categorized activities					
active person (sex & age)					
Remarks					

#### 3.8 What is the next device you plan to have?

#### 3.9 What is the main energy source used for cooking?

- LPG
- Biomass

#### 3.10 What is the main energy source used for lighting?

- Hand torch
- Kerosene

**3.11 Please state the cost of other energy sources according to the following table:**

Source of energy	expenditure daily / monthly	
Electricity		
Wood/charcoal		
LPG		
kerosene		
Others		

**4 Electricity use (Overall evaluation)**

**4.1 What are the technical problems that face when using electricity?**

- **Stability:** no of blackout /day, month.
- **Technical efficiency:** No. of non working or damaged electric devices in the past year.
- **Safety :** No. of accidents in the last year ( excluding personal carelessness)

**4.2 How do you categorize the stability of the electricity supply?**

- stable
- To some extent
- Not stable

**4.3 How do you categorize the technical stability of the electricity supply considering its quality and voltage stability?**

- Stable throughout the day
- Stable some times (specify period)
- Not stable throughout the day

**4.4 What are the problems that are facing you when using other energy sources?**

- Inconvenient
- Non healthy/ non safety
- Unavailability and high cost
- Others

**4.5 Are you satisfied with the current electricity situation?**

- Yes
- No
- to some extend

**4.6 How do you evaluate your electric house consumption?**

- Rational
- Irrational

## **General Assessment Key informants**

- 1. How do you rate the availability of the electric supply to the different sectors in the city?**
  - Available to all
  - Available to more than 50 %
  - Available to less than 50 %
  
- 2. How do u rate the accessibility to the electricity services?**
  - Easy
  - To some extent
  - Difficult
  -
- 3. If it is not easy what the main constrain?**
  - Complicated Bureaucracy
  - High price
  - Others, specify <sup>1</sup>
  
- 4. Do you think that a power plant fueled by agricultural residues is acceptable /realistic project? why**
  - Yes
  - No
  
- 5. In your opinion who is eligible or suitable to execute such project? why**
  - Government
  - Private sector
  - Community
  - NGO

## Appendix: 3-A.

### Summary of different gasification systems requirements and products

Grundtyp	Festbett		Wirbelschicht		Sonderverfahren		
	Gegenstrom	Gleichstrom <sup>g</sup>	stationär	zirkulierend	Festbett <sup>c</sup>	Flugstrom <sup>d</sup>	Dampfreformierung <sup>e</sup>
Parameter	Einheit				2 Bett <sup>f</sup> (allotherm)		
Leistungsbereich [MW <sub>BWL</sub> ]		0,1 – 10	0,02 – 3	10 – 100		in Entwicklung <sup>h</sup>	
Brennstoffqualität							
- Körnung		grobkörnig, eng klassiert, holzartig	grobkörnig, eng klassiert, holzartig	feinkörnig, eng klassiert, holzartig	grobkörnig, eng klassiert, holzartig	breites Körnungsband, holz- und halmgutartig	
- Korngröße [mm]		5 - 100	20 – 100 <sup>k</sup>	10 – 100	5 – 150	< 1 <sup>l</sup>	k. A.
- Wassergehalt [%]		43 (max. 60)	12 (max. 25)	< 40	< 45	< 25	20 – 50
- Aschegehalt [Ma-% <sub>wf</sub> ]		< 15	< 5	k. A. <sup>n</sup>	k. A.	< 20 <sup>i</sup>	k. A.
Rohgaseigenschaften <sup>a</sup>							
- H <sub>2</sub> O	[Vol.-%]	k. A.	6 – 20	12 – 17	k. A.	7,3	23
- CO <sub>2</sub>	[Vol.-%]	8 – 10	11 – 13	11 – 19	15,4	10,6	18
- H <sub>2</sub>	[Vol.-%]	10 – 14	15 – 21	6 – 19	30,5	20,5	44
- CO	[Vol.-%]	15 – 20	10 – 22	9 – 21	19,6	20,2	14
- CH <sub>4</sub>	[Vol.-%]	2 – 3	1 – 5	3 – 7	1,2	0,0003	1
- Partikelgehalt <sup>b</sup> [g/Nm <sup>3</sup> ]		0,1 – 3	0,1 – 8	4	0,1 – 0,6	< 0,05	k. A.
- Teergehalt <sup>b</sup> [g/Nm <sup>3</sup> ]		10 – 150	0,1 – 6	12	< 0,1	<< 0,05	k. A.
- Heizwert [MJ/Nm <sup>3</sup> ]		3,7 – 5,1	4,0 – 5,6	3,0 – 6,5	5,6	4,5 – 9,5	ca. 13
Kaltgaswirkungsgrad <sup>m</sup> [%]		50 – 70	65 – 75	k. A.	70 – 85	> 80	ca. 75

Source: Vogel, A

Dezentrale Strom und Wärmeerzeugung aus biogenen Festbrennstoffen; Ph.D Thesis; TU Hamburg-Harburg -2007

### Appendix 3-B: Properties of contamination removal system

Abscheideprinzip	Abscheidegrad %	Gasgeschw. m/s	Druckverlust mbar	Energiebedarf kWh / 1000 m <sup>3</sup> /h
Zyklon	85 – 95	15 – 25	6 – 15	0,3 – 0,65
Gewebefilter	99 – 99,99	0,5 – 5	5 – 20	0,75 – 1,9
Trocken-Elektroabscheider	95 – 99,99	0,5 – 2,0	1,5 – 3,0	0,26 – 1,96
Nass-Elektroabscheider	95 – 99,99	0,5 – 2,0	1,5 – 3,0	0,17 – 2,3

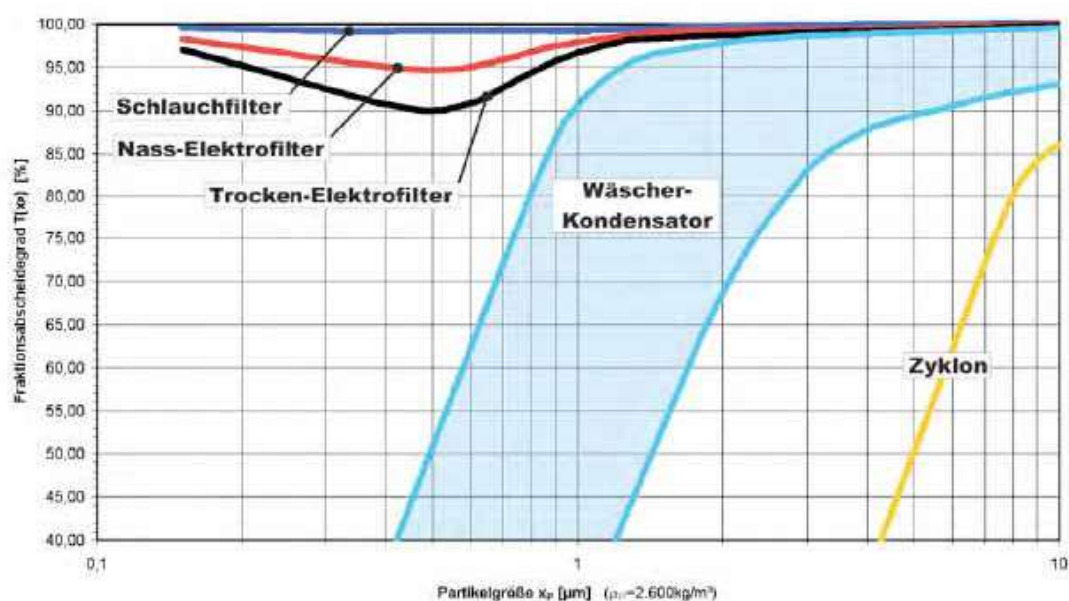

Source : Nussbaumer, T

Luftreinigung und Explosionsschutz bei Holzfeuerungen und Stand der Technik der Holzvergasung presented in 7 holzenergie\_ Symposium 18. Oktober 2002, ETH Zürich

### Appendix 3 –C Sensitivity of different system to contamination

Parameter	Dimension	Fixed bed	ICE	Turbine	Fuel cell (SOFC)
Tar	mg/ Nm <sup>3</sup>	100-8000	<100	<5	150-250
Particulate	mg/Nm <sup>3</sup>	100-6000	<50	10-30	<10
Alkali	mg/ Nm <sup>3</sup>	300-500	50	<0,2-3	0,1
Halogens	mg/ Nm <sup>3</sup>	10-100	<100-500	<1- 2	1 ppm
S compounds	mg/ Nm <sup>3</sup>	10-100	150-500	<1	200ppm
N compounds	mg/ Nm <sup>3</sup>	200-800	50	10-30	<0,1



## Appendix 3-D

### Types of Fuel cell

	AFC	PAFC	PEMFC	MCFC	SOFC
Fuel Cell Types	Alkaline Fuel Cell	Phosphoric Acid Fuel Cell	Proton-Exchange Membrane Fuel Cell	Molten Carbonate Fuel Cell	Solide Oxide Fuel Cell
Operation Temperature	< 100° C	200 - 220° C	60 - 20° C	600 - 650° C	800 - 1000°C
Efficiency	> 70 %	40 % > 40% H <sub>2</sub> -fuel	40 % > 40% H <sub>2</sub> -fuel	> 60 % (expected)	70% (exp.)
Start Up	slow	slow	fast	slow	slow
Load Changing	slow	quick	fast	quick	quick

**Source: Herdin,G**

Standesanalyse des Gasmotors im Vergleich zu den Zukunftstechniken (Brennstoffzellen und Mikroturbine) bei der Nutzung von aus Biomasse gewonnenen Kraftstoffen,  
<http://images.energieportal24.de/dateien/downloads/gasmotoren-analyse.pdf>

## Appendix 4-A

### Test sheet for fuel properties of agricultural residues

TU DRESDEN – Institut für Energietechnik, Lehrstuhl für Kraftwerkstechnik –  
Kraftwerkschemisches Labor

Probenbezeichnung :

Auftraggeber :

Entnahmeort :

Probenahme am :

Probeeingang am :

Probenehmer :

Untersuchungsparameter	Einheit	Analysewert		Methode
		roh	wf	
Wassergehalt	%			DIN-conform
Aschegehalt	%			DIN 51 719
Kohlenstoff	C %			DIN-conform
Wasserstoff	H %			DIN-conform
Stickstoff	N %			DIN-conform
Flüchtige Bestandteile	%			DIN 51 720
Schwefel, gesamt	S %			DIN-conform
Chlor	Cl %			
Heizwert	H <sub>u</sub>	kJ/kg		DIN 51 900
Heizwert , waf	H <sub>u</sub>	kJ/kg		DIN 51 900
Ascheschmelzverhalten nach				DIN 51 730
Sintertemperatur	t <sub>s</sub>	°C		
Erweichungstemperatur	t <sub>A</sub>	°C		
Halbkugeltemperatur	t <sub>B</sub>	°C		
Fließtemperatur	t <sub>C</sub>	°C		
Chem. Zusammensetzung der Brennstoffasche				DIN 51 729
Silicium	SiO <sub>2</sub>	%		
Aluminium	Al <sub>2</sub> O <sub>3</sub>	%		
Eisen	Fe <sub>2</sub> O <sub>3</sub>	%		
Calcium	CaO	%		
Magnesium	MgO	%		
Sulfat	SO <sub>3</sub>	%		
Natrium	Na <sub>2</sub> O	%		
Kalium	K <sub>2</sub> O	%		
Phosphor	P <sub>2</sub> O <sub>5</sub>	%		

Bezugszustände: roh = Anlieferungszustand

wf = wasserfrei

waf = wasser-und asche frei

## Appendix 4-B

### Results of fuel properties for tested material

Name	m.c.) (% mass)	c.v. (kJ/kg)	C (%mass)	N (%mass)
W. P.(W)	5	18700	50,1	0,49
W.P.(W2)	3,9	18607	51,3	0,3
Str.pellets	6,2	17289	46,59	0,6
Ch.grass	6,5	18092	48,4	0,28
Gr.nuts ((ch)	5,2	18805	50,5	0,95
Gr.nuts(R)	3,9	18826	48,3	1,48
Gr.nuts (H)	5,9	17644	48,1	0,86
Cotton( H)	7,1	17448	47	0,62
Bagg.(K)	5,1	17818	48,5	0,24
Sghm( R)	3,05	16264	43,7	0,71
Sghm(M)	4,8	16510	45,2	0,59
Sghm(F)	4,4	17486	48,4	0,46
Sghm( A)	6	16530	45	0,77
Millet (A)	2,8	15988	43,6	0,66
Millet (R)	3,23	15899	43,1	1,7
Millet (F)	5,2	16910	46,3	1,5
Roslle(R)	3,9	16515	45,3	0,71
Sesem (R)	3,6	16753	43,6	0,6
Sesem (A)	6,6	16498	45,2	1,23

Name	VOC (%mass)	H (%mass)	Cl (%mass)	S (%mass)
W. P.(W)	84	6,18		0,02
W.P.(W2)	84,86	6,44		0,02
Str.pellets	74,7	5,88		0,18
Ch.grass	80,3	5,82		0,1
Gr.nuts ((ch)	73,4	5,74		0,042
Gr.nuts(R)	71,76	5,86	0,02	0,107
Gr.nuts (H)	71,2	5,62		0,06
Cotton( H)	72,3	5,73		0,24
Bagg.(K)	83,7	5,83		0,02
Sghm( R)	74,44	6,02		0,155
Sghm(M)	72,2	5,51		0,07
Sghm(F)	78,5	5,77		0,068
Sghm( A)	70,1	5,67		0,1
Millet (A)	72,8	6,2		0,07
Millet (R)	67,86	5,55		0,301
Millet (F)	71	5,63		0,14
Roslle(R)	76,86	5,97		0,192
Sesem (R)	72,67	5,59		0,06
Sesem (A)	71	5,7		0,03

Name	Ash conten (%mass)	ST °C	FT °C	Cl (%mass)	SiO <sub>2</sub> (%mass)	Al <sub>2</sub> O <sub>3</sub> (%mass)
W. P.(W)	0,3	1177	>1413	n.b.	26,5	3,65
W.P.(W2)	0,26	1092	>1397	0,073	13,03	3,77
Str.pellets	5,4	851	1122	0,503	45,27	0,45
Ch.grass	2,1	n.b.	n.b.	n.b.	n.b.	n.b.
Gr.nuts (CH)	2,2	1070	1174	0,7	28,25	3,74
Gr.nuts(R)	4,02	958	1148	0,008	47,7	2,86
Gr.nuts (H)	6,5	n.b.	n.b.	n.b.	n.b.	n.b.
Cotton( H)	4,6	n.b.	n.b.	n.b.	n.b.	n.b.
Bagg.(K)	2,3	1128	1260	0,047	64,71	8,96
Sghm( R)	5,33	926	1171	0,152	56,27	1,06
Sghm(M)	7,5	1068	1249	4,722	19,28	0,42
Sghm(F)	2,8	1009	1090	0,073	42,76	1,6
Sghm( A)	7,3	836	1076	n.b.	41	0,96
Millet (A)	7,2	917	1250	n.b.	60,5	1,81
Millet (R)	8,5	991	1195	0,94	49,9	1,01
Millet (F)	6	1190	1258	7,736	20,02	2,03
Roslle(R)	3,56	1035	>1413	0,056	19,46	1,07
Sesem (R)	5,87	1059	1203	0,103	57,18	3,22
Sesem (A)	6,4	1019	>1409	n.b.	2,02	0,7

Name	Fe <sub>2</sub> O <sub>3</sub> (%mass)	CaO (%mass)	MgO (%mass)	SO <sub>3</sub> (%mass)	Na <sub>2</sub> O (%mass)	K <sub>2</sub> O (%mass)	Na <sub>2</sub> O+K <sub>2</sub> O (%mass)
W. P.(W)	3,91	25,91	7,34	0,11	2,84	14,24	17,08
W.P.(W2)	6,16	32,54	11,47	8,38	0,75	15,29	16,04
Str.pellets	0,66	9,8	2,49	2,95	n.b.	n.b.	37,877
Ch.grass	n.b.	n.b.	n.b.	n.b.	n.b.	n.b.	n.b.
Gr.nuts (CH)	1,91	11,84	5,82	3,78	5,63	27,17	32,8
Gr.nuts(R)	5,56	5,19	6,34	3,9	n.b.	n.b.	28,45
Gr.nuts (H)	n.b.	n.b.	n.b.	n.b.	n.b.	n.b.	n.b.
Cotton( H)	n.b.	n.b.	n.b.	n.b.	n.b.	n.b.	n.b.
Bagg.(K)	0,61	4,02	2,72	0,69	1	7,16	8,16
Sghm( R)	1,18	7,75	7,16	3,96	1,13	19,08	20,21
Sghm(M)	5,61	5,69	3,58	2,66	1,32	57,51	58,83
Sghm(F)	1,14	6,94	12,94	5,24	1,42	20,85	22,27
Sghm( A)	0,93	7,92	8,13	3,21	n.b.	n.b.	37,85
Millet (A)	1,81	8,34	7,99	2,47	n.b.	n.b.	17,08
Millet (R)	0,83	3,87	8,94	7,85	1,44	24,3	25,74
Millet (F)	0,69	4,81	5,58	2,07	2,41	50	52,41
Roslle(R)	0,88	17,41	20,05	12,32	1,5	23,91	25,41
Sesem (R)	2,06	7,85	8,1	1,07	1,03	16,95	17,98
Sesem (A)	0,79	16,79	7,11	1,745	n.b.	n.b.	70,845

\* (.) stands for the decimal sign (.)

## Appendix 5-A

### Calculation of Producer gas volume flow rate

The calculations for producer gas flow rate were done based on Bernoulli equation for steady state incompressible fluids using an orifice and manometer system (Fig 5.I) . The final equation used is:

$$\dot{V} = \frac{KA_1}{\sqrt{1-K^2}} \sqrt{\frac{2\Delta p}{\rho}}$$

Where

$$K = A_1/A_2$$

$A_1$  = cross sectional area inlet pipe (m<sup>2</sup>)

$A_2$  = cross sectional area of orifice (m<sup>2</sup>)

$v_1$  = gas velocity at inlet (m/s)

$v_2$  = gas velocity at orifice (m/s)

$P_1$  = pressure of gas at inlet (Pa)

$P_2$  = pressure of gas at orifice (Pa)

$\rho$  = density of gas (kg/m<sup>3</sup>)

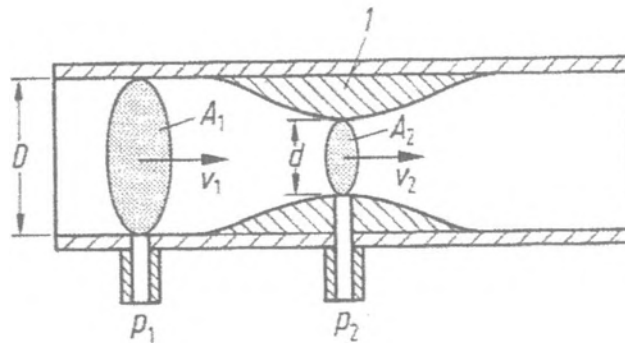
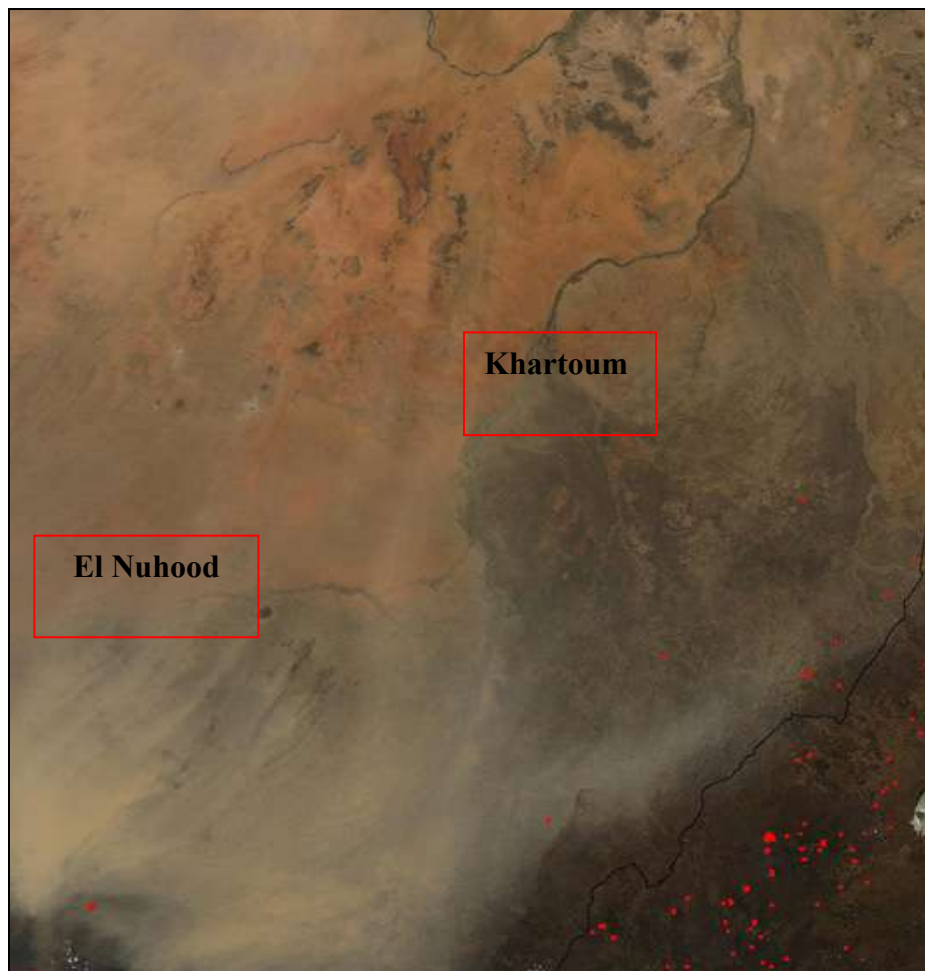

Fig. 5.I: Sketch for orifice plate

**Appendix 6-A**  
**Dust storm over the study area**



\*The white colour illustrates to the dust *particles*.

Fig (III) dust storm in Sudan and mainly in the western part  
Image Acquired: March 26, 2003

Source : interpreted by M. Khiery, Institute of Photogrametry, TU-Dresden,  
from <http://earthobservatory.nasa.gov/>, August 2007