

EL 6153 6226

11/4/94  
82

Southeastern Regional Biomass Energy Program

# **Cogeneration from Biofuels: A Technical Guidebook**

*Administered For  
The United States  
Department of Energy*

Tennessee Valley Authority  
National Fertilizer and  
Environmental Research Center  
Biotechnical Research Department  
Muscle Shoals, Alabama 35660



104 page

**COGENERATION FROM BIOFUELS:  
A TECHNICAL GUIDEBOOK**

October, 1986

James L. Easterly, P.E.

Dr. Michael Z. Lowenstein

Prepared Under TVA Contract No. TV-67207A  
Tennessee Valley Authority Biomass Program  
Southeastern Regional Biomass Energy Program  
U.S. Department of Energy

Under Contract to:  
Meridian Corporation  
5113 Leesburg Pike, Suite 700  
Falls Church, VA 22041



# Cogeneration from Biofuels: A Technical Guidebook

## TABLE OF CONTENTS

<u>Chapter</u>	<u>Page</u>
1. Overview.....	1-1
2. Feasibility Study Methodology.....	2-1
3. Fuel Procurement.....	3-1
4. Fuel Handling and Storage.....	4-1
5. Energy Conversion Technologies.....	5-1
6. Systems Considerations.....	6-1
7. Utility Interconnection.....	7-1
8. Environmental Issues.....	8-1
9. Economics and Financing.....	9-1
Appendix A - Southeastern Region State Biomass Contacts.....	A-1
Appendix B - Southeastern Region State Environmental Agencies.....	B-1
References.....	C-1
Glossary.....	D-1



## LIST OF TABLES

<u>Table</u>		<u>Page</u>
1-1	Comparison of Conventional Electrical and Process Steam Technology with Cogeneration (Greenwood Chips as Fuel).....	1-3
3-1	Total Green Weight of Potential Annual Energy Wood by Source and Species Group for 13 Southeastern States.....	3-3
3-2	Comparison of Wood Fuel Source Characteristics.....	3-4
3-3	Principle U.S. Crops, in Order of Decreasing Residue Production (1983).....	3-6
3-4	Principal Crops by Source for 13 Southeastern States (1983)....	3-7
3-5	Comparison of Agricultural Fuel Source Characteristics.....	3-8
3-6	Typical Composition of Municipal Solid Waste from a Large City in the United States.....	3-10
3-7	Total Livestock on Farms for 13 Southeastern States (1983).....	3-12
3-8	Estimated Manure Production Rates and Biogas Generation Potential from Animal Wastes.....	3-13
4-1	Fuel Use and Storage Needs for a Wood Fueled Boiler.....	4-4
4-2	Capacities for Various Sizes of Concrete or Steel Silos.....	4-5
4-3	Characteristics of Wood Fuel Conveying Systems.....	4-6
5-1	Cogeneration Topping Cycle Performance Parameters.....	5-12
6-1	Applications Temperature Ranges.....	6-2
6-2	Thermal Sizing Options.....	6-6
6-3	Key Parameters for Cogeneration Design.....	6-8
8-1	Emissions From Uncontrolled Industrial Burners.....	8-2
8-2	Comparison of Particulate Removal Devices.....	8-7
8-3	Environmental Protection Agency Regional Offices.....	8-11
9-1	Cogeneration Project Cash Flows.....	9-2
9-2	Costs of Unloading Equipment.....	9-3
9-3	Costs of Biomass Fuel Storage.....	9-3





## LIST OF TABLES (CONT'D)

<u>Table</u>		<u>Page</u>
9-4	Costs of Mechanical Conveyors.....	9-4
9-5	Costs of Fuel Preparation Equipment.....	9-4
9-6	Costs of Biomass Fuels.....	9-10
9-7	Typical Wood Waste Cogeneration System Costs (Using a Backpressure Turbine and Wood Boiler, 1986).....	9-12



## LIST OF FIGURES

<u>Figure</u>		<u>Page</u>
1-1	Comparison of Conventional Electrical and Process Steam Technology with Cogeneration.....	1-4
1-2	Schematic of a Typical Biomass Cogeneration System.....	1-5
2-1	Feasibility Study General Plan Outline.....	2-2
4-1	Receiving and Unloading Systems.....	4-3
5-1	Topping and Bottoming Cogeneration Systems.....	5-2
5-2	Typical Travelling Grate Boiler .....	5-4
5-3	Fluidized Bed Combustion System.....	5-5
5-4	Biomass Updraft Gasifier.....	5-7
5-5	Cross Section of the Modified Full Scale Plug Digester.....	5-8
5-6	Steam Turbine Topping Cogeneration System.....	5-9
5-7	Gas Turbine Topping System.....	5-10
5-8	Combined Cycle Topping System.....	5-11
5-9	Engine-Generator Cogeneration System.....	5-12
6-1	Energy Demands.....	6-1
6-2	Short-Term Load Variability.....	6-3
6-3	Annual Load Variations Due to Space Heating and Air-Conditioning.....	6-4
7-1	Cogeneration System Electrical Diagram: Use and Sell Power....	7-4
7-2	Cogeneration System Electrical Diagram: Sell All Power.....	7-5
8-1	Multiple Cyclone.....	8-4
8-2	Dry Scrubber.....	8-5
8-3	Baghouse.....	8-6
8-4	Electrostatic Precipitator.....	8-7
8-5	Outline of Preconstruction Review of Major Pollution Control Regulations.....	8-10



LIST OF FIGURES (CONT'D)

<u>Figure</u>		<u>PAGE</u>
9-1	Capital Cost of Steam Generating System (1986\$).....	9-6
9-2	Estimated Installed Costs for Condensing and Noncondensing Steam Turbine Systems.....	9-7
9-3	Combustion Turbine-Generator Cost Estimates -- Installed.....	9-8
9-4	Diesel Generator Total Installed Costs.....	9-9
9-5	Third-Party Lease.....	9-14
9-6	Leveraged Lease.....	9-15
9-7	Sale-Leaseback ("Safe-Harbor" Lease).....	9-16



## CHAPTER 1: OVERVIEW

### INTRODUCTION

Cogeneration, the simultaneous production of more than one form of useful energy, has long been used by industry as a means of producing both thermal and electric energy to meet on-site process requirements. Biomass feedstocks such as wood are currently used as the fuel in many cogeneration systems, yet there are substantial opportunities for expanding the use of these feedstocks in the southeastern region of the U.S. The extensive quantity and diversity of biomass resources in the Southeast provide an excellent opportunity to reduce the use of fossil fuels.

This guidebook focuses primarily on issues related to the use of biomass fuels for cogeneration in the Southeast. It is targeted toward those plant managers and engineers who could use a biomass fueled system but are not knowledgeable or aware of the potential or applications of biomass fuel for cogeneration. The guidebook emphasizes a systems level understanding and is not intended to be a detailed "nuts and bolts" handbook. Detailed technical information is limited to biomass fuel characteristics, an area where engineers' standard reference documents may be inadequate.

### ORGANIZATION

The guidebook is organized into nine chapters, each of which deals with a particular aspect of the application of biomass fuels to cogeneration. The successful design of a biomass fueled cogeneration facility involves a study of complex interactions between economic, fuel, and technical issues. Chapter 2 provides a framework within which the decision-maker can operate to develop a successful design. The steps that must be taken to decide which technologies to use are outlined, and a design checklist is included to assist in planning.

Chapter 3 addresses fuel procurement, a subject area which is often the number one concern of decision-makers in considering a biofueled system. The characteristics of biomass fuels are also summarized, including wood, agricultural residues, manure and municipal waste. In Chapter 4, fuel handling and storage considerations are addressed. Since biomass is a bulky fuel, handling and storage tend to be the second greatest concern of decision-makers regarding the use of biofuels (after fuel procurement). Chapter 5 covers the wide spectrum of technologies that can be used to convert biomass into thermal and electric energy in cogeneration systems. Systems considerations are addressed in Chapter 6, such as assessing energy loads and their relationship to cogeneration system design. One of the key criteria for a viable cogeneration system is the presence of a substantial year-round thermal energy requirement or demand.

Chapter 7 covers the establishment of the Public Utility Regulatory Policies Act (PURPA), which was enacted in 1978 to provide benefits and incentives for cogeneration. Under this Act, there is

significant support and economic incentive for the installation of biomass fueled cogeneration facilities. Environmental issues are covered in Chapter 8, with most attention paid to fuel use issues rather than fuel production issues. There are significant environmental advantages to burning biomass fuels instead of fossil fuels, particularly coal. Biomass fuels contain insignificant amounts of sulfur and thus, a whole area of pollution control for sulfur emissions is eliminated.

Chapter 9 deals with the economic and financial aspects of a biomass fueled cogeneration system. Costs of various fuels and equipment are discussed. An overview is also provided on the impact of the new 1986 tax law on biofueled cogeneration systems. With a 10 percent biomass energy tax credit in 1987, and accelerated 5-year depreciation for biofueled cogeneration, the new tax law seems to have enhanced the attractiveness of these systems as an investment, relative to other types of investments. As a result, 1987 might be a particularly good year to install a biofueled cogeneration system. Finally, methods of financing are outlined and the calculation of economic return is addressed.

## BIOMASS FUELS

Concern over energy supply reliability and rapidly fluctuating energy costs have provided the incentive for many businesses to investigate alternative energy resources. Biomass has long been used for energy and in fact, during the 18th century, wood was the primary fuel source. Wood was displaced as an industrial fuel by the development of fossil fuels. However, the "rediscovery" of wood and other forms of biomass for fuel is rapidly underway.

The drive to use wood for fuel has been led by the forest products industry and has been encouraged by environmental regulations that make the disposal of wood wastes an expensive proposition. Major wood users within the pulp and paper industry are now utilizing almost 100 percent of their wood wastes and many have achieved energy independence for their facilities through this use. In the southeastern region of the United States there are large quantities of wood available as logging residues which are not normally collected. More wood wastes are available from sources such as sawmills and furniture manufacturers. But the catalog of available biomass fuels includes more than wood resources.

Agricultural residues are available in large supply. Walnut shells, almond shells, peach pits, and cotton gin waste are all being burned for energy. Corn stover, rice and wheat straw, and other crop residues are being collected or have been studied for use as fuels. Bagasse and other sugar cane wastes are being fully burned by the sugar industry. Municipal solid wastes are becoming more available as more communities face the reality of shrinking landfill availability.

A special mention should be made of manure as an energy producing agricultural waste. The generation of biogas, a fuel gas comprised of equal parts of methane (natural gas) and carbon dioxide, from anaerobic



digestion of manure is now commercially viable. On any farm where animal movements are contained, such as dairy and poultry farms and hog feeding operations, anaerobic digestion provides a fuel and, at the same time, reduces the cost and environmental impact of waste disposal.

Although biomass fuels have traditionally been burned in boilers to produce steam and process heat, with the large increase in electricity prices, legislative incentives, and new technologies, it is becoming increasingly cost-effective to use the biomass-produced steam in a cogeneration mode.

## COGENERATION

Cogeneration is the simultaneous production of electrical or mechanical energy and thermal energy from the same heat source. In the United States, cogeneration is actually an old technology that is recently experiencing new growth. More than 80 years ago, when industrial electrification was emerging, the availability or dependability of centrally supplied electricity was not widespread, and many factories cogenerated in order to ensure the supply of both heat and electricity. With the availability of inexpensive and reliable electric power from utilities, cogeneration was no longer used. More recently, rapidly rising fuel and electricity costs, legislative incentives, new technologies and the increased awareness of available low cost biomass fuels has helped lead to renewed interest in biomass cogeneration.

The basic energy economics of biomass fueled cogeneration can be shown by a simple example. Table 1-1 contains data on the production of steam only and electricity only and cogenerated steam and electricity from wood. This example is illustrated in Figure 1-1. A schematic of a typical biomass cogeneration system is shown in Figure 1-2.

Table 1-1  
**COMPARISON OF CONVENTIONAL ELECTRICAL AND  
 PROCESS STEAM TECHNOLOGY WITH COGENERATION**  
 (Greenwood Chips as Fuel)

PROCESS	LBS STEAM	kWh ELECTRICITY	TONS FUEL
Conventional Steam	9600	0-	1.75
Conventional Electricity	0-	680	1.00
Total for Both	9600	680	2.75
Cogeneration	9600	680	2.25
Fuel Savings by Cogeneration			0.50

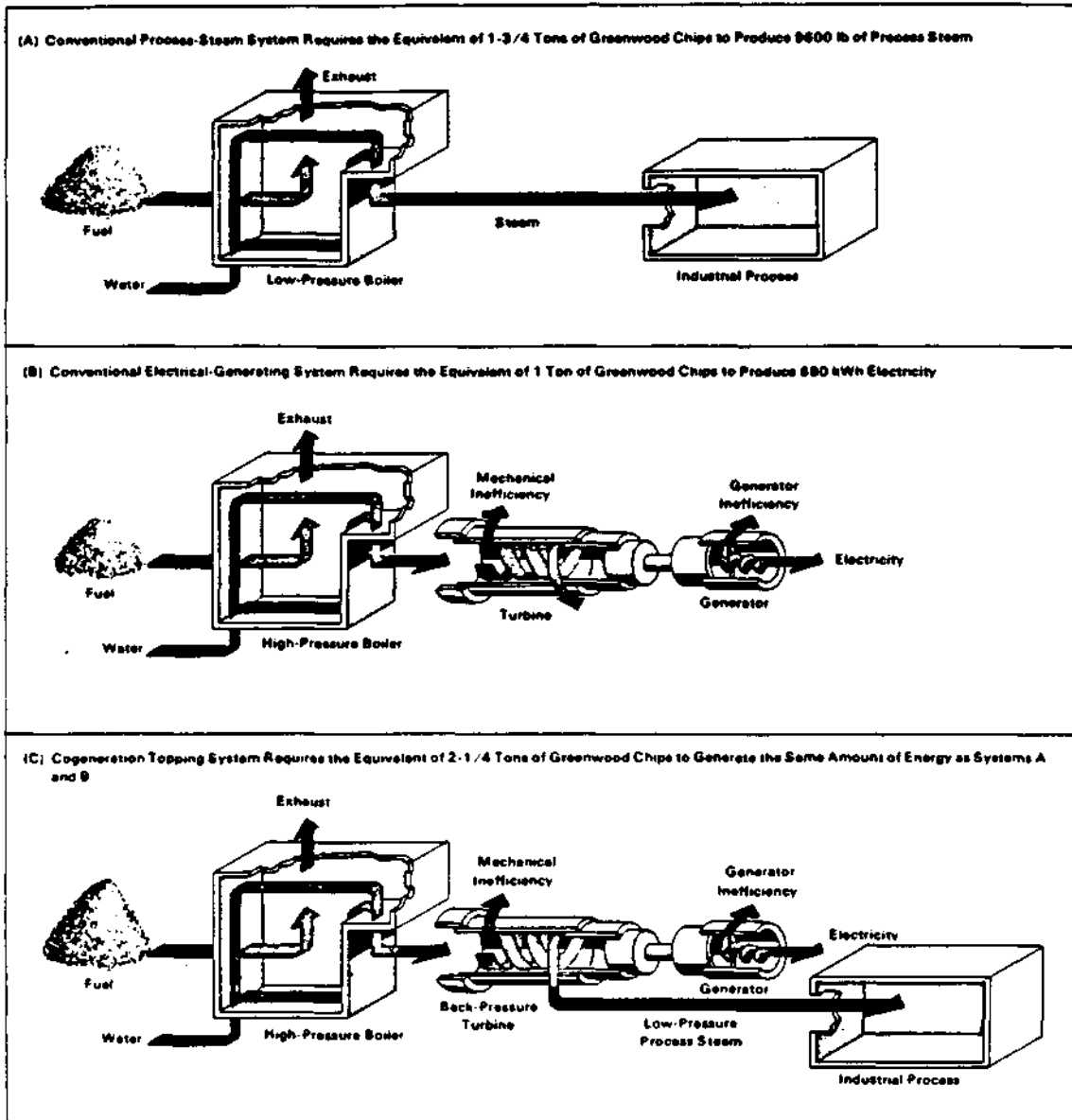

Adapted from *Cogeneration: Technical Concepts, Trends and Concepts*, U.S. Department of Energy, DOE FEU 1703, September, 1978

Figure 1-1  
 COMPARISON OF CONVENTIONAL ELECTRICAL AND  
 PROCESS STEAM TECHNOLOGY WITH COGENERATION

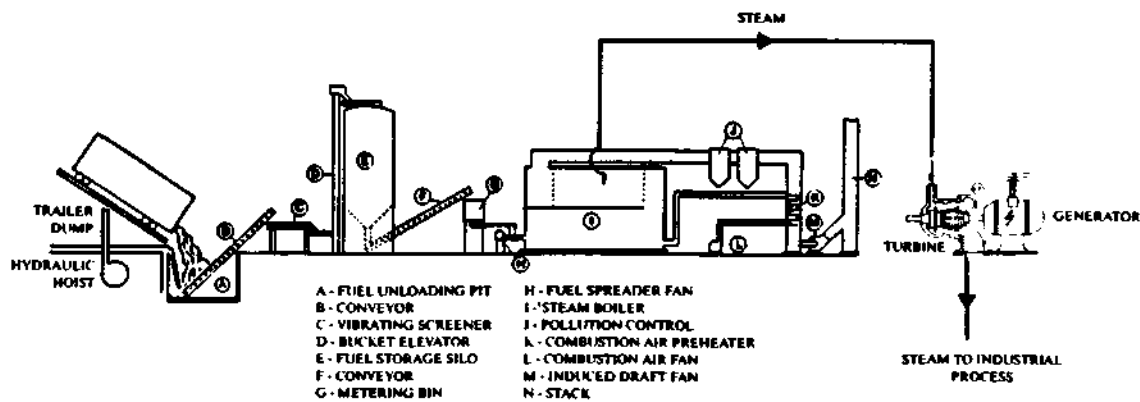

**Figure 1-2**  
**SCHEMATIC OF A TYPICAL BIOMASS**  
**COGENERATION SYSTEM**

### SUMMARY

Biomass fueled cogeneration offers a number of benefits to any industrial firm that uses both process heat and electricity. These benefits are summarized as follows:

- o Reduced energy costs: the cost of biomass fuels on a per Btu basis is often considerably lower than the cost of fossil fuels. Fuel costs may be reduced further by credits for solid waste disposal.
- o Reduced environmental control costs: the absence of sulfur in biomass fuels removes one particularly important source of pollution, especially relative to coal. Particulate control for biomass emissions uses well established technology, and ash disposal is easy.
- o Favorable tax treatment: 10 percent biomass tax credit in 1987 and accelerated 5-year depreciation under the new 1986 federal tax legislation.
- o Proven technology: biomass waste has been burned for years, and cogeneration technology is well established. The advent of modern electronic control technology has greatly simplified the electrical aspects of cogeneration and, with the increasing demand, companies are producing suitable cogeneration equipment in sizes as small as 50kW of electrical output (e.g., small on-farm anaerobic digester systems or small gasifiers with engine generators).

- o Local economy enhancement: most biomass fuels are collected in the area in which they will be used. Instead of buying fuel from outside the region, the operator of a biomass fueled cogeneration facility will be supporting local producers.
- o Aid to local utilities: utilities facing the prospect of building large, new centralized power plants may find relief by encouraging small industries to install biomass fueled cogeneration facilities instead.

The advantages of biomass fueled cogeneration to the industrial sector are well documented. It is hoped that this guidebook will encourage industrial and institutional decision-makers to promote the development of cost-effective biomass fueled cogeneration systems.

## CHAPTER 2: FEASIBILITY STUDY METHODOLOGY

### INTRODUCTION

The successful design, installation and operation of a biomass fueled cogeneration facility requires the integration of a number of issues. Complex interactions exist between issues such as economics, fuel supply, utility interface, environmental impact, zoning, and available technology, and no one issue can be addressed independently. For example, in designing the system, environmental impacts and regulations must be considered, but the applicable regulations depend upon the type of fuel and the size of the system. The size of the system cannot be determined until the steam and electrical generation requirements are known, and electrical generation will depend upon utility interconnections and rates.

In order to carry out the feasibility study in an organized and efficient manner, a definite plan must be followed. While certain steps within the study will be site specific, plans will generally have similar components. In this chapter, a generalized plan for conducting a feasibility study will be outlined and described; the various elements of this plan will be covered in more detail in following chapters.

### FEASIBILITY STUDY PLAN

#### Outline

Figure 2-1 presents an outline of a generalized plan for conducting a feasibility study. Each of the steps shown in this outline are discussed below.

### DATA COLLECTION PLAN

A significant amount of data must be collected to determine the feasibility of a biomass fueled cogeneration facility. To maximize the efficiency of data collection, a systematic approach should be developed and should include the following:

- o identification of the data required;
- o identification of data sources;
- o determination of the types of data analysis to be performed; and,
- o identification of outside resources, if required.

It is particularly important to recognize that the amount of information on successful biomass fueled cogeneration facilities is rapidly growing and that expertise in this field is available. The

planner can reduce costs significantly by taking advantage of this expertise and experience.

### Company Data

Preliminary company data are collected and used as the basis for an early "go/no-go" decision. If certain conditions are not met, or will not be met in the foreseeable future, then further detailed study of the biomass fueled cogeneration system should not be considered. The primary determining factors are the plant's thermal load, physical space considerations and availability of local supplies of biomass fuel.

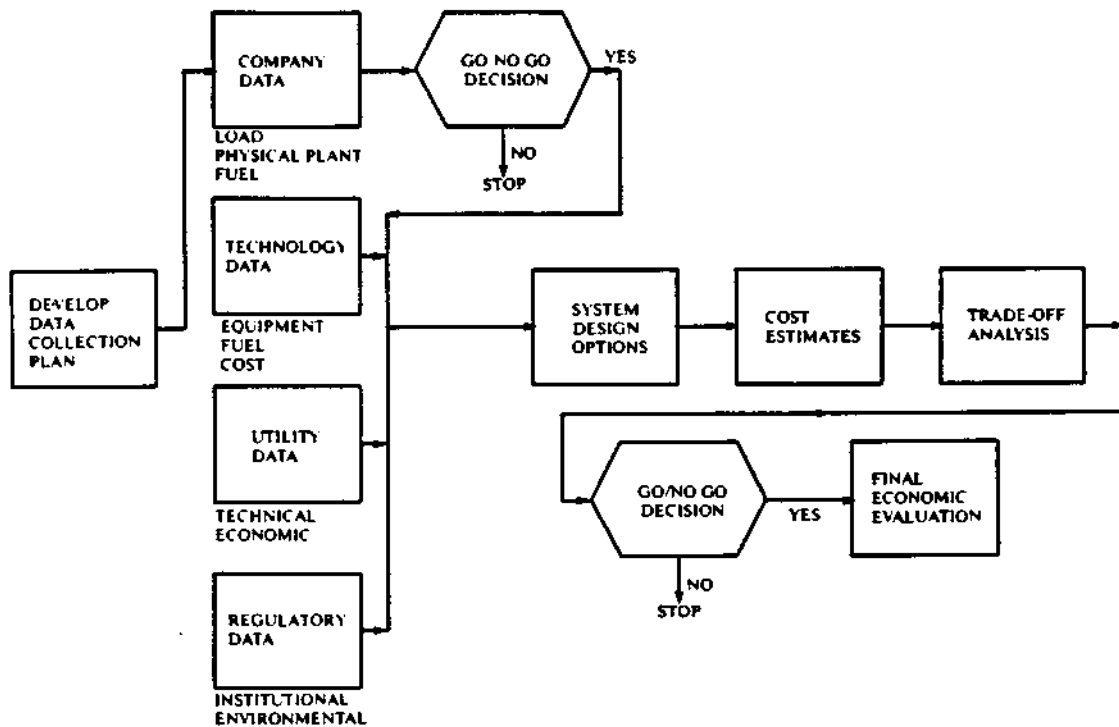

Figure 2-1

## FEASIBILITY STUDY GENERAL PLAN OUTLINE

### o Thermal Load

The plant thermal load should be examined both for adequacy and for consistency. In general, if the plant thermal load is below 2000 pounds of steam per hour, cogeneration is unlikely to be

economically feasible. Further, the daily variations of the load has a significant impact on feasibility. Fluctuating loads require that generation equipment operate at part load (and greatly reduced efficiency) for a significant portion of the time. If the ratio of an average thermal load to peak thermal load is less than 30 percent, cogeneration is probably not feasible (unless the turbine size is based on the average or partial steam-rate flow). The same consideration must be paid to seasonal variations. A heavy heating load in winter with no equivalent load in summer will require that the system operate well below capacity during long periods of time. Generally, it is highly important to have a substantial thermal demand year round to justify installing a cogeneration system. Plant thermal load data should be the first data collected.

#### o Physical Plant Adaptability

Biomass fueled cogeneration facilities require significant amounts of plant space. Space is required for the cogeneration equipment and for storage of biomass fuels, which are less dense than fossil fuels and therefore require larger storage areas. The cogeneration equipment must be located near existing steam boilers and be constructed to provide adequate access for maintenance. The physical plant data should be the second data collected.

#### o Fuel

If the plant that is being considered for the cogeneration facility has a potential fuel generated internally (such as food processing wastes and packing wastes), then the size of this resource must be compared to the amount of fuel required to meet the thermal load. If no internal source of fuel is available, then a quick investigation into local biomass fuel resources should be made and the availability of a reliable supply determined.

#### o Go/No-Go Decision

If the plant thermal load is adequate and of the proper consistency, if sufficient plant space is available, and if reliable fuel supply is assured, then the feasibility of installing a biomass fueled cogeneration system should be thoroughly examined. However, if one or more of the above three factors appears to be unattainable, then a biomass cogeneration system is probably not justified.

### Technology Data

Technologies for cogeneration are well established. However, the use of biomass fuels in cogeneration, while carried out for years in the pulp and paper industries, has not been widely applied in other industries. Therefore, a thorough examination of this area is required.

## o Equipment

Data are required on the available equipment for biomass fueled cogeneration and the possible configurations of equipment. Both technical and cost data on available equipment are needed. Equipment to be considered includes:

- Convertors: biomass fuels can be burned in a number of different convertors and the characteristics of the burner must be matched to the fuel used.
- Boilers: both firetube and watertube boilers can be used.
- Prime movers: steam turbines of several types, gas turbines, or internal combustion engines are all suitable in certain situations.
- Generators: either synchronous or induction generators are available.

## o Fuel

A wide variety of biomass fuels are available. Once the preliminary investigation has determined that such fuels are available in the vicinity of the plant, a thorough and detailed analysis of the biofuel supply availability must be undertaken. This analysis will produce data on the following:

- Type: wood, agricultural residue, industrial wastes, and municipal solid wastes are among the types of fuels to be considered, and the characteristics of each must be determined.
- Availability: data on the quantity, quality, and reliability of supply are required.
- Storage and handling: each fuel type introduces certain storage and handling requirements and the characteristics must be known.

## o Cost

Data must be obtained which identifies costs for equipment as well as for fuel. This data should cover all possible technologies and a wide range of sizes of equipment.

## Utility Data

### o Technical

Early in the feasibility study, discussions with the local utility should be initiated to ensure that the technical plans being made are in accordance with the utility's requirements. Items to be considered include:



- Power quality: voltage, phase, and frequency must all be controlled within limits set by the utility.
- Safety: automatic disconnects, such as manual over-rides, are among the safety devices that may be required to protect both the utility and the customer.

o Economic

The principal economic factors which involve the utility are rate structures. Both the rates charged by the utility and the payback price the cogenerator can receive from the utility have impact on the project. Data are required on the following:

- Buy back rates: the price paid by the utility for excess power sold by the cogenerator and special pricing features (time-of-day, guaranteed capacity, etc.) must be determined.
- Standby rates: the cost of power to the cogenerator on an intermittent basis.
- Any additional interconnect costs.

Regulatory Data

Regulatory data are needed in both the institutional and environmental areas.

o Institutional

Institutional constraints which must be examined include:

- Regional master planning and zoning
- Building codes and permits
- Legislative restrictions
- Citizens' groups (if any).

o Environmental

Environmental data are needed to establish the basis for decisions regarding pollution control technologies or procedures required to comply with pertinent environmental regulations. Data to be gathered relate to:

- Air emissions
- Groundwater
- Waste disposal
- Fuel storage.

**SYSTEM DESIGN OPTIONS**

Once the data collection is completed, the next step is to develop a number of different possible biomass fueled cogeneration configurations by combining the available technologies. The facility must be sized to satisfy the desired level of electrical and thermal loads. A fuel must be selected that is available in suitable quantity

and quality and the converter must match the fuel. The choice of operating cycle and prime mover depends on the load characteristics. Pollution controls and utility interfaces must be matched to the conversion equipment. The selection of each of the items in the system will be made easier if the data collection phase has been thorough.

As the information is assembled and synthesized, various cogeneration configurations should be developed with major components selected and sized to meet projected loads. Finally, those configurations that appear to be technically feasible (in terms of fuel use, compatibility, and optimal sizing of components to meet projected loads) should be identified for further analysis.

## **COST ESTIMATES**

Cost estimates for possible biomass fueled cogeneration configurations should address the following:

- o Capital costs
- o Fuel and operating costs
- o Cost of meeting regulatory requirements (environmental, safety, zoning codes).

## **TRADE-OFF ANALYSIS**

The trade-off analysis involves ranking the systems and evaluating the benefits of these systems. Hardware costs may outweigh the desired energy-output level or vice-versa. Environmental or institutional factors may be significant considerations under certain circumstances. The trade-off analysis leads to selecting a biomass fueled cogeneration configuration that will provide cost-effective energy supply while satisfying various regulatory restrictions.

## **GO/NO-GO DECISION**

The costs of the biomass fueled cogeneration system should be compared with the costs of a biomass fueled system supplying only thermal energy and to a conventionally fueled energy system. Should the total cost (both thermal and electrical energy) of the energy supply be lower in the case of biomass fueled cogeneration, then the decision to proceed with final detailed economic evaluations is justified.

## **FINAL ECONOMIC EVALUATION**

Once a cogeneration configuration has been selected, a final economic evaluation can be made. The final evaluation will contain information on how to obtain and operate a system that has been deemed technically acceptable. The final economic evaluation will include:

- o Investment costs
- o Life-cycle costs
- o Payback (return on investment)
- o Effects of fuel cost escalation
- o Effects of electrical cost escalation
- o Ownership possibilities
- o Methods of financing
- o Tax implications.

## CHECKLIST

The checklist on the following page can be used to keep track of progress on the feasibility study plan.

### FEASIBILITY STUDY CHECKLIST

ACTION	PLANNED TIME	START DATE	END DATE
DEVELOP DATA COLLECTION PLAN	_____	_____	_____
COMPANY DATA			
load	_____	_____	_____
physical plant	_____	_____	_____
fuel	_____	_____	_____
GO/NO-GO DECISION	_____	_____	_____
TECHNOLOGY DATA			
equipment	_____	_____	_____
fuel	_____	_____	_____
cost	_____	_____	_____
UTILITY DATA			
technical	_____	_____	_____
economic	_____	_____	_____
REGULATORY DATA			
institutional	_____	_____	_____
environmental	_____	_____	_____
SYSTEM DESIGN OPTIONS	_____	_____	_____
COST ESTIMATES	_____	_____	_____
TRADE-OFF ANALYSIS	_____	_____	_____
GO/NO-GO DECISION	_____	_____	_____
FINAL ECONOMIC EVALUATION	_____	_____	_____

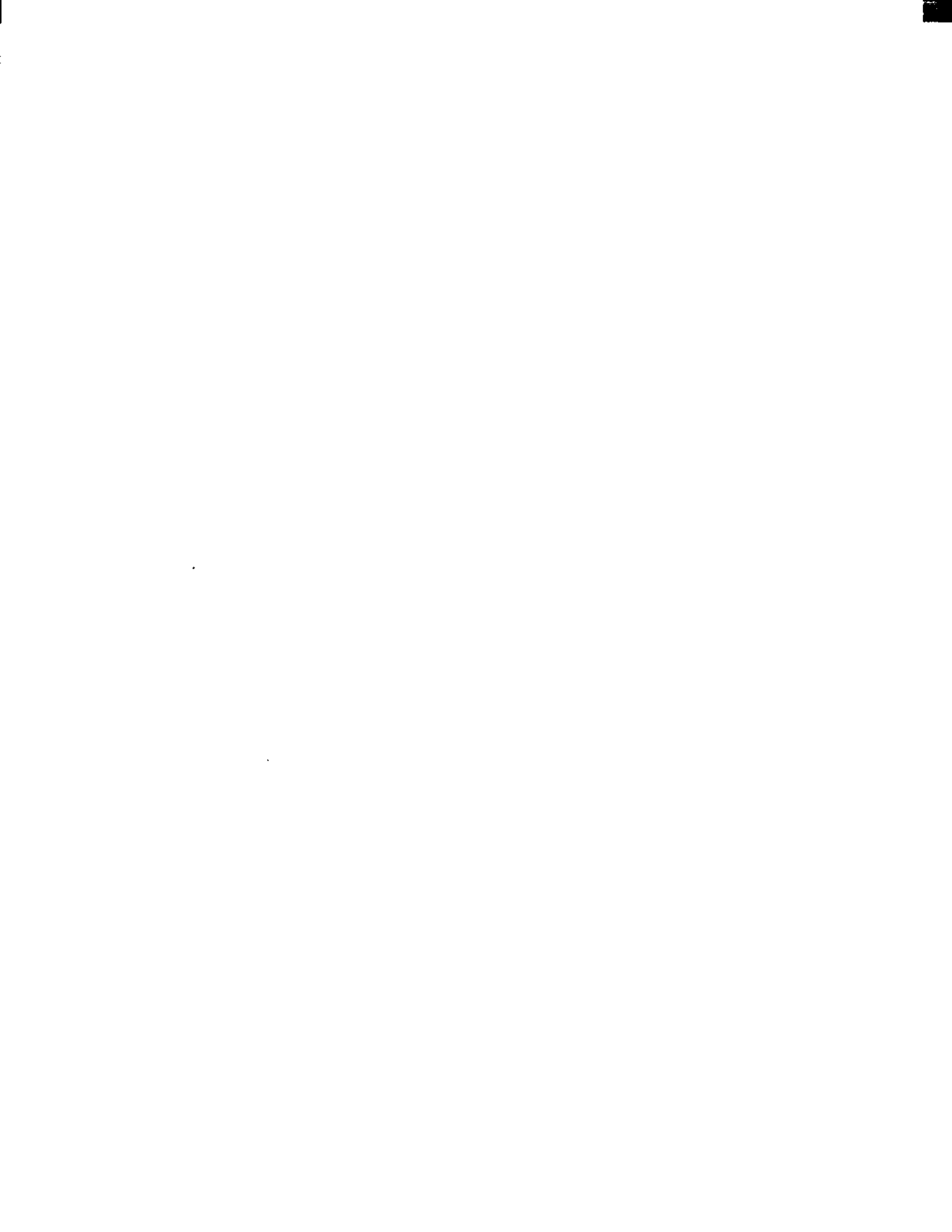

## CHAPTER 3: FUEL PROCUREMENT

### INTRODUCTION

A wide variety of biomass feedstocks is available to fuel cogeneration systems. Some of these feedstocks, such as wood and agricultural residues, are available throughout the southeastern United States in large quantities and could be purchased as fuel in much the same manner as coal or oil. Others, such as cotton gin trash, food processing wastes, municipal solid wastes, manufacturing by-products, and manures, are available in limited locations and, while not necessarily available for purchase, could be used by the operators of the waste-producing facility. In this chapter, a number of potential feedstocks will be discussed. Questions to be answered include:

- o How much of the biomass fuel is available?
- o What is the cost relative to fossil fuels?
- o What are the biomass fuel characteristics?
- o What are some of the considerations in purchasing biomass fuels?

### SOURCES OF INFORMATION

#### Wood

Information on timber and wood by-product availability is published by both the Federal and state governments. The U.S. Department of Agriculture, through the Forest Service, regularly surveys standing tree biomass. The U.S. Department of Energy, through the Regional Programs, supports many surveys and studies on woody biomass. Contacts for the Southeastern Regional Biomass Energy Program, administered by TVA, and biomass state contacts for each of the 13 states in the Southeastern region are provided in Appendix A (the TVA and state contacts are also good sources of information for the biomass fuel options listed below). Each state has a department of forestry that conducts surveys of forest products. For example, the Commonwealth of Virginia conducts surveys of manufacturing by-products (sawdust, bark, chips, shavings) every three years and annually estimates forest harvests in each county.

Sources of wood residues can be identified through state agencies focusing on commerce, industry, and trade issues and are listed in each state's manufacturing directory by standard industrial classification (SIC) code. Relevant codes include:

<u>SIC Code Number</u>	<u>Classification</u>
2421	sawmills and planing mills - general
2426	hardwood dimension and flooring mills

2431  
2448

millwork  
wood pallets and skids

### Agricultural and Food Residues

Both the Federal and state governments publish information on agricultural residues. The U.S. Department of Agriculture, through the agricultural extension officer or through county agents, can characterize the local agricultural residue resource. The "Statistical Abstract of the United States" provides complete data on crop production. Each state has an agricultural agency that compiles data on crop production and residues.

Sources of food residues from agricultural processing can be identified in each state's manufacturing directory through their SIC codes. Relevant codes include:

<u>SIC Code Number</u>	<u>Classification</u>
0723	crop preparation services for market
2033	canned fruits, vegetables, preserves, etc.
2062	cane sugar refining
2076	vegetable oil mills
2099	food preparation, miscellaneous

### Municipal Solid Wastes

Information on municipal solid waste (MSW) is available from a number of sources. The U.S. Department of Health, Education and Welfare and the Environmental Protection Agency have thoroughly characterized MSW from cities of all sizes, and many private publications on solid waste management are also available.

One of the best sources of information on planned or operating RDF systems is published by the U.S. Conference of Mayors in their City Currents periodical, which includes a "Semiannual Survey on Resource Recovery Activities" (U.S. Conference of Mayors, 1620 Eye Street, NW, Washington, D.C. 20006; (202) 293-7330). As of April 1986, there were a total of six RDF systems operating in the 13 southeastern states: two in Florida (Dade County and Lakeland); one in New Orleans, Louisiana; and three in Virginia (Petersburg, Richmond and Portsmouth). Four of the six facilities burn all their refuse in dedicated boilers and do not sell RDF to industry. The facilities in Petersburg and Richmond, Virginia, sell RDF to industry and represent possible prototypes for RDF producers supplying fuel for industrial boilers.

### Manures

Information on dairy farms and feedlots as sources of manure can be found in publications prepared by the U.S. Department of Agriculture. This information is available through regional

agricultural extension officers, county agents, and state agricultural agencies.

## WOOD

A recent Forest Service survey found the total green weight of above-ground tree biomass on commercial forestland in the United States to be almost 36 billion green tons. Of this total, an estimated 14.3 billion tons is located in the Southeast. Tree biomass available for fuel use is primarily found as residues in timber harvesting. Logging residues, usually left behind during harvest, can amount to as much as 50 percent of total tree biomass. The total amount of woody biomass potentially available each year for energy, and not needed to meet anticipated demands for other products, consists of residues from conventional logging operations, cull trees, and surplus growth. By this definition, the 13-state region produces 246 million tons of potential energy wood annually. This production is summarized by state in Table 3-1.

Table 3-1

### TOTAL GREEN WEIGHT OF POTENTIAL ANNUAL ENERGY WOOD BY SOURCE AND SPECIES GROUP FOR 13 SOUTHEASTERN STATES

State	Logging Residues			Cull Trees			Surplus Growth			All Sources		
	Hardwood	Softwood	Total	Hardwood	Softwood	Total	Hardwood	Softwood	Total	Hardwood	Softwood	Total
----- Million Tons -----												
Alabama	2.64	4.39	7.04	11.49	3.45	14.93	0.32	0.00	0.32	14.45	7.64	22.09
Arkansas	2.40	2.88	5.28	7.80	0.53	8.33	1.51	0.32	1.84	11.71	3.73	15.44
Florida	1.07	3.98	5.05	7.28	0.57	7.85	1.01	0.90	1.90	9.37	5.46	14.82
Georgia	4.19	9.55	13.73	5.90	0.42	6.32	3.77	0.47	4.23	13.66	10.44	24.30
Kentucky	1.97	0.10	2.07	3.62	0.41	4.04	2.70	0.52	3.22	8.29	1.03	9.32
Louisiana	1.99	3.15	5.13	8.73	1.06	9.80	2.42	1.48	3.90	13.14	5.69	18.83
Mississippi	2.70	3.44	6.14	8.74	0.99	9.73	1.95	0.95	2.90	13.39	5.38	18.77
Missouri	2.38	0.07	2.46	10.24	0.09	10.33	0.00	0.14	0.14	12.62	0.30	12.92
North Carolina	4.38	3.43	7.80	13.41	1.01	14.42	4.34	1.31	5.65	22.13	5.57	27.88
South Carolina	1.98	3.03	5.02	6.43	0.99	7.42	3.81	5.06	8.87	12.22	9.08	21.30
Tennessee	2.78	0.34	3.12	9.57	0.45	10.02	4.08	1.05	5.12	16.43	1.84	18.27
Virginia	4.17	1.74	5.91	15.48	0.86	16.34	3.93	0.16	4.28	23.58	2.96	26.54
West Virginia	2.66	0.12	2.78	7.12	0.38	7.50	3.62	1.62	5.24	13.40	2.12	15.52
Southeast	35.32	36.21	71.54	115.82	11.22	127.03	33.45	14.16	47.61	184.52	61.59	246.11

\* Totals may not add due to rounding.

Source: Woody Biomass Analysis for 13 Southeastern States (1984)

This resource of green wood in the Southeast is most often available in the form of green whole-tree chips, and an infrastructure is developing to make these chips available to industrial users for use as fuel. Most energy wood available today comes from the collection of forestry wastes. At present, the greatest use of energy wood is in the Northeast, where about 20 percent of the sites harvested are harvested exclusively for energy. However, as the market develops for fuelwood, it is expected that fuel producers across the U.S. will begin to

harvest wood specifically for energy, rather than as a by-product of timbering operations. This should stabilize the supply of wood for cogeneration.

The availability of manufacturing residues has diminished as the forest products industry has embraced the use of this material for cogeneration. It is estimated that by 1990 the pulp and paper industry will have more than 90 percent of its energy needs satisfied by woody biomass. Sawmills now view waste products as saleable commodities and, while it is still possible to find some wastes that are available for the cost of hauling them away, more and more sawmills are using their waste for in-house energy needs or are selling the waste for fuel at a fair market value.

### Characteristics

Wood for fuel is generally not of high enough value to justify much processing or preparation; in fact, it is usually burned as produced. Although some effort is underway to produce densified wood pellets, the cost is presently quite high. Characteristics of wood for fuel are presented in Table 3-2.

**Table 3-2**  
**COMPARISON OF WOOD FUEL SOURCE CHARACTERISTICS**

Fuel Source	Moisture Content %*	Heat Value (Btu/lb)	% Ash Content	% Sulphur Content
Green Whole Tree Chips	50	4250	2.7	Trace
Dry Sawdust	13	7000	2.7	Trace
Dry Planer Shavings	13	7000	2.7	Trace
Densified Wood (Pellets)	10	7650	2.7	Trace
High Sulfur Coal (Western)	5	13,000	5-15	2-8
Low Sulphur Coal	2.5	13,000	7-19	0.6-2.0

\* -- % moisture content measured on a wet basis.

Source: *Industrial Wood Energy: A Guide for Virginia* (1985)

### Wood Fuel Costs

The actual cost of wood fuel depends on local conditions. In many localities there is an active market and supply and demand determine the cost of wood fuel. In areas without a large fuelwood market, the



builder of a cogeneration facility may be instrumental in determining the cost of wood fuel. The presence of an active pulp and paper industry will tend to stabilize the cost, since that industry will be able to place a value on both wastes and chip supplies.

Timber Mart South, a private forest products price reporter, maintains up-to-date listings of costs for both whole-tree chips and forest product industries wastes (Publisher: F. W. Norris, P. O. Box 1278, Highlands, NC 28741). A comparison of biomass fuel costs is provided in Chapter 9.

### Wood Fuel Procurement

The wood buyer's goal is to obtain a fuel of uniform quality, delivered on a dependable schedule over an extended period of time, at a satisfactory price. Wood may either be procured by direct contract with the supplier or purchased through a wood broker. Each method has advantages and disadvantages.

A broker simplifies the procurement process for the cogenerator by locating feedstock producers, negotiating contracts, providing liaison, and regulating the fuel flow to a number of users from a number of producers. Using a wood broker improves the reliability of fuel supply by broadening the supplier base. However, the broker takes a fee for this service, thus increasing the delivered cost of the feedstock.

Directly purchasing the feedstock eliminates brokerage fees and grants the buyer the freedom to choose suppliers, which may allow greater control over fuel price and fuel quality. However, direct purchase requires buyer participation in the time-consuming process of locating individual suppliers and physically procuring the fuel. In addition, quantity constraints may be faced: a supplier may want the buyer to purchase his or her entire output.

Contracts for wood purchase must contain guidelines specifying what is acceptable for the buyer's particular application. There are no existing standardized grading methods for wood fuels; therefore, testing of the delivered product to make sure that it meets the pre-determined specifications is the responsibility of the user. It benefits both the user and the supplier to set specifications on the lowest grade acceptable for the handling and combustion system. If this is done, the supplier will have an easier time finding acceptable wood fuel and the user will pay the lowest price. In general, the specifications included in the contract should take into account the fuel handling, storage, transportation, and burning facilities of the user. Items to be considered in developing specifications include:

- o Size -- Wood handling and burning systems are designed for a particular range of sizes and fuel outside this range may cause problems.
- o Moisture content -- A high moisture content has a marked effect on handling and combustion characteristics, as well as

delivered weight. Moisture content over 50 percent should be considered unacceptable.

- o Dirt and grit -- Fuel should be available with less than 3 percent noncombustible material.
- o Delivery schedule -- Both quantity, frequency, and method of delivery should be specified.

## AGRICULTURAL RESIDUES

Agricultural residue refers to the portion of plant material that remains after a crop has been harvested and separated. Primary residues are those that are the result of farm-level activities; they include items such as stalks and leaves that are left over after harvest. Secondary residues are those that result from processing, such as cotton mill wastes, peanut shells, etc. For most crops, primary residues are produced in quantities approximately equal in weight to the crop production. The amount of secondary residues varies widely depending on the crop and the processing methods used. Table 3.3 lists the principle crops produced in the United States and the residues associated with these crops.

Table 3-3  
PRINCIPLE U.S. CROPS, IN ORDER OF DECREASING  
RESIDUE PRODUCTION (1983)

Crop	Area Harvested (Thousands of Acres)	Crop Production (Millions of Tons)	Residue Production (Millions of Tons)
Corn for grain	72,700	230	230
Wheat	77,900	82	123
Soybeans for beans	69,400	65	98
Oats	10,300	14	28
Sorghum for grain	14,100	19	19
Rice	3,300	8	12
Cotton	9,700	3	3
Hay	59,800	149	0
Potatoes	1,300	18	0
Sugar beets	1,000	21	0
Tobacco	900	2	0
Sugar cane	700	28	0*
Sugar cane (Mainland)	6	.02	0*

\* All sugarcane residue (bagasse) produced is currently burned by sugar mills; no excess is available for sale.

Source: *Statistical Abstract of the U.S.* (1985)

In the Southeastern region, the principle crops are corn, soybeans, cotton, sorghum, and peanuts. Table 3-4 shows crop and waste production by state for corn, soybeans, and cotton.

Table 3-4  
PRINCIPLE CROPS BY SOURCE FOR 13 SOUTHEASTERN STATES (1983)  
(Millions of Tons)

STATE	CORN FOR GRAIN	SOYBEANS FOR BEANS	COTTON (Thousand Bales)
Alabama	.8	.8	183
Arkansas	- *	2.1	323
Florida	.5	-	-
Georgia	2.0	1.2	112
Kentucky	-	6.9	-
Louisiana	-	2.0	532
Mississippi	-	1.0	900
Missouri	6.0	2.9	73
North Carolina	4.7	.9	43
South Carolina	1.1	.7	53
Tennessee	1.7	.9	151
Virginia	1.9	.3	-
West Virginia	-	-	-
Southeast Region	18.7	19.7	2370

\* = no production reported.

Source: *Statistical Abstract of the U.S.* (1985)

Availability of crop residues is limited because a portion of the residue must be returned to the soil for conservation purposes such as controlling water and wind erosion. Further, widespread removal of residues would require an increase in mineral fertilizer use. Residues contribute approximately 40 percent of the nitrogen, 10 percent of the phosphorus, and 80 percent of the potassium fertilizer needed for crops. Crop residues will be available for removal only if calculated erosion rates do not exceed the soil tolerance limit, which is calculated for each soil using an equation that takes into account rainfall, soil erodibility, slope length, crop management factors, and erosion control practices. This tolerance limit varies widely by state. For example, in the Atlantic Coastal Flatwoods of Georgia, 75 percent of the residues produced are available for fuel or other uses, whereas in Mississippi and Alabama, less than 10 percent are available. Before planning a cogeneration facility using agricultural residues, one should check carefully with local USDA agricultural agents to ensure availability of fuel.

The availability of secondary processing residues is extremely site-specific. Prime candidates for cogeneration using such residues are the processing facilities themselves. For instance, the addition of a cogeneration facility to a cotton gin would provide energy and eliminate the gin trash disposal problem. The Farmers Cooperative Gins, Inc. in Buttonwillow, California has successfully demonstrated

the feasibility of this approach. Firms that are presently paying to have secondary crop residues hauled away might be good sources of fuel for a biomass cogeneration facility.

### Characteristics

Agricultural residues are generally burned as produced, although in some cases natural drying is allowed to take place. The fuel characteristics of a number of residues are compared in Table 3-5.

**Table 3-5**  
**COMPARISON OF AGRICULTURAL FUEL SOURCE**  
**CHARACTERISTICS**

Fuel Source	Moisture Content % *	Heat Value (BTU/lb)	% Ash Content	% Sulphur Content
Bagasse	52	4500	1.8	--
Corn Stover	47	4000	3.0	0.08
Cotton Gin Trash	14	6500	--	--
Wheat Straw	10	6700	8.1	--
Peach Pits	10	9200	0.6	Trace
Almond or Walnut Shells	5	8100	3.3	--
High Sulphur Coal (Western)	5	13,000	5-15	2-8
Low Sulphur Coal (Eastern)	2.5	13,000	7-19	0.6-2.0

\* -- % moisture content measured on a wet basis.

Source: Adapted from *Biomass Cogeneration. A Business Assessment* (1981)

The availability of most agricultural residues is seasonal: they are usually available in large quantities immediately after harvesting or processing of the crop. Residues may have to be stored for up to a year to ensure year-round supply to the cogeneration facility. Field residues, such as corn stover, can be baled and stored. The most economical method of storage is in large round bales that can be stored, single layer, at the rate of about 300 tons per acre. The land cost for storage, along with handling losses, must be included when determining the final cost of such residues to the cogeneration facility. Some processing facilities using their own wastes may find it economical to operate on a part-year basis, with the availability of fuel paralleling the operating period.

## Cost

A number of studies have been conducted on the cost of crop residues delivered to a power plant. Total costs include harvesting, transportation, storage, and handling. The most widely studied residue, corn stover, can be delivered to a cogeneration facility for \$30 to \$35 per dry ton, for a cost, as fuel, of \$2.00 to \$2.35 per million Btu. Costs of in-house generated residues should be well known to the management, and will often be negative due to the elimination of disposal problems.

## Procurement

The operator of a cogeneration facility using agricultural residues has the same concerns as those outlined earlier in the section on wood. Because it is less likely that a broker will be found for these residues, direct arrangements with either a producer or a group such as a farmer's co-operative will likely be necessary. In contracting for delivery, special attention must be paid to continuity of supply. Acreage devoted to a particular crop often varies from year to year, and weather can affect not only the amount of residue produced, but transportation and harvesting costs as well. The grower's primary concern will be maximizing profit on the primary crop; residue production will be of secondary importance. For this reason, the use of agricultural residues for cogeneration should be approached with caution and, if year-round operation is required, the possibility of supplemental biomass fuel supplies (such as wood) should be considered.

## **MUNICIPAL SOLID WASTE**

Municipal solid waste (MSW) is the assortment of castaways disposed of in the residential, commercial, and institutional sectors, and is generated by all communities. In the United States, more than 240 million tons of solid waste is generated per year, equivalent to about one ton of solid waste per person. Traditionally, MSW has been regarded strictly from a disposal viewpoint, with dumping and sanitary landfills the chosen methods of disposal. More recently, municipalities have been turning to incineration to dispose of such wastes.

MSW resource availability is estimated at over 3.5 to 5 pounds per day per person. More precise estimates can be obtained from local sanitation or waste management authorities. In general, due to high equipment costs for converting waste to energy or processing it into fuel, the quantity of waste available is insufficient to produce refuse-derived fuel if local populations are under 50,000.

## Characteristics

The composition of MSW from a large city in the United States is shown in Table 3-6. Due to the variable composition of MSW and the presence of large amounts of nonburnable material, waste must be burned

in a specially designed "mass burn" boiler which can accommodate the nonburnable material, or it must be processed to remove the non-combustible material to produce a "refuse-derived" fuel (RDF). In a disposal system operated by a municipality, this is done through a complex, dedicated facility. RDF is typically burned directly and is not usually available for sale. The operator of a cogeneration facility is unlikely to invest in the separation operation, so the use of MSW for fuel in private facilities has been limited.

Table 3-6  
**TYPICAL COMPOSITION OF MUNICIPAL SOLID WASTE FROM  
 A LARGE CITY IN THE UNITED STATES**

Constituents	Weight Percent (As-Received Basis)
<b>Paper</b>	
Newspaper	13
Corrugated box board	4
Magazines/books	4
Miscellaneous	<u>25</u>
Subtotal	46
<b>Plastics</b>	
Plastics	4
Wood	2
Textiles	3
Yard clippings	2
Food wastes	11
Rubber & leather	<u>1</u>
Subtotal	23
<b>Metals</b>	
Ferrous	9
Aluminum	<u>1</u>
Subtotal	10
<b>Other</b>	
Glass & ceramics	8
Rocks & dirt	2
Miscellaneous (organic and inorganic)	<u>11</u>
Subtotal	<u>21</u>
Total	100
Moisture content	25
Estimated higher heating value (Btu/lb)	4,380 Btu/lb

Refuse-derived fuel is currently available as a fuel source for industry in some locations. As the technology for producing RDF is refined, the production of RDF for sale as an industrial fuel will most likely become more prevalent. RDF consists of the (primarily combustible) portion of municipal solid waste that remains after metals, glass, sand, and other extraneous materials are removed from the waste stream. RDF is processed to be fairly uniform in size. Because RDF consists of a higher percentage of combustibles, it has a heating value that is higher than raw MSW (approximately 5800 Btu per pound compared with 4400 Btu per pound for MSW ).

Three types of RDF are currently produced for combustion in commercial waste-to-energy facilities: fluff, densified, and wet. Fluff RDF is by far the most commonly used form of RDF. Fluff RDF (fRDF) is processed for the removal of noncombustibles and reduction of particle size. If the fRDF will be used in a suspension-fired boiler, then it is shredded down to a very small (0.50 - 1.5 inches) particle size. If the fRDF will be used in a dedicated, spreader-stoker boiler, then particle sizes as large as 5 inches are satisfactory.

Densified RDF (dRDF) is produced by compressing finely shredded fluff RDF into pellets, briquettes, or similar forms. The dRDF can be more easily stored and transported than fluff RDF and is usually produced for co-firing with lump coal in spreader-stoker boilers. The production of dRDF has thus far been problematic, and currently only one facility (Richmond, VA) produces dRDF for sale as a fuel. Wet RDF is produced using a wet pulping process in which the MSW is slurried with water in a large vat. The combustible materials become part of the slurry, while noncombustibles are removed by centrifugal force. The slurry is dewatered to approximately 50 percent solids before being used as a boiler fuel. The only commercial facility currently using wet RDF is a 3000-TPD waste-to-energy facility in Dade County, Florida.

### Cost

MSW is generally available on a daily basis, but the cost is difficult to determine, since MSW receiving facilities charge tipping fees for each unit of MSW delivered by collection vehicles (representing a negative cost for the fuel itself). There are several RDF facilities in operation. The City of Baltimore recently signed a contract for long-term supply of RDF to a municipal power plant at a cost of \$20 per ton. Other facilities have quoted prices for the delivery of RDF within the range of \$22 to \$35 per ton, which represents a cost of \$1.90 to \$3.02 per million Btu.

### Procurement

The operator of a cogeneration facility designed to use RDF is generally limited to a single supplier of fuel. In fact, the decision to build such a facility would be based on the availability of a nearby economical RDF source. Before the construction of a facility begins, the cogenerator should negotiate and establish a contract with the RDF facility for a reliable and steady fuel supply. (As noted earlier, a

nearby economical fuel source and a firm fuel supply contract are desired characteristics for all biofuelled systems.)

## MANURE

Manure is produced in significant quantities on any farm that raises animals. Manure is different from other biomass feedstocks in that it is not usually burned. Rather, it is converted into a gaseous fuel by the action of bacteria in a device called an anaerobic digester. In the digester, the complete absence of air (anaerobic) allows four separate groups of bacteria to convert the manure into biogas, a mixture of primarily carbon dioxide and methane (natural gas). This biogas is then burned or used to fuel an engine. Biogas contains about half the energy content of natural gas. (Anaerobic digestion is described in greater detail in Chapter 5).

Table 3-7 lists livestock production on farms in the southeastern United States.

**Table 3-7**  
**TOTAL LIVESTOCK ON FARMS FOR 13 SOUTHEASTERN STATES**  
(in Thousands, Chickens in Millions) 1983

	Dairy Cattle	Pigs	Chickens (layers)
Alabama	52	440	14
Arkansas	84	395	24
Florida	190	190	7
Georgia	129	1310	15
Kentucky	242	1000	1
Louisiana	101	110	2
Mississippi	95	300	7
Missouri	254	3550	5
North Carolina	135	2300	11
South Carolina	47	510	4
Tennessee	214	950	3
Virginia	170	550	3
West Virginia	*	*	1
<b>Southeast Region</b>	<b>1713</b>	<b>11,605</b>	<b>97</b>

\* = Information not Available

Source: *Statistical Abstract of the U.S.* (1985)



Total estimated manure production rates and biogas generation rates are shown in Table 3-8.

Table 3-8

**ESTIMATED MANURE PRODUCTION RATES AND BIOGAS GENERATION POTENTIAL FROM ANIMAL WASTES**

	Dairy	Swine	Poultry Layers
Number of animals per 1000 pound liveweight	0.8	7.7	250
Manure production wet lbs/1000 lb lw/day	85	65	53
wet lbs/animal/day	106.3	8.5	0.05
Total Solids % TS	12.5	9.2	25.2
dry lbs/animal/day	13.3	0.8	0.014
Biogas Production ft <sup>3</sup> /1000 lb lw/day	40.9	35.1	75.0
ft <sup>3</sup> /animal/day	51.1	4.6	0.30

Source: *The Feasibility of Biogas Production on Farms* (1982)

In order for manure to be economically utilized for anaerobic digestion, the animals producing it must be confined. If the animals are not confined, manure collection costs become prohibitive. Chicken layers are, by the nature of the operation, confined. Increasing numbers of dairy and pig farms are also confining animals, and when building any new confinement facility, the collection of manure for anaerobic digestion should be incorporated into the design. Because of the localized nature of the biomass feedstock and the high cost of shipping, it is unlikely that manure would be purchased for generation of fuel off the farm. However, on-farm cogeneration systems can be quite cost-effective and are now commercially available.

Cost

Manure is a free fuel feedstock; even the cost of the collection and handling system can generally be ignored since it would be needed even if a bio-energy system were not installed. The cost of the anaerobic digestion system for producing the biogas is usually included

in the overall cost of the cogeneration facility since the biogas is used directly, rather than being sold (these costs are addressed in Chapter 9). The avoided costs due to improved disposal of wastes and the meeting of EPA sanitation requirements must be included in the value of the system.

## CHAPTER 4: FUEL HANDLING AND STORAGE

### INTRODUCTION

The use of biomass fuels for cogeneration requires handling, storage space, and equipment that are visibly different from the requirements for natural gas, oil, or coal (although, as solid fuels, coal and biomass have numerous similarities in handling and storage). Many of the requirements are the same for all biomass fuels, though a few are fuel-specific and site-specific. Because of the low density of biomass fuels, the volume which must be handled is large and the process of moving and storing the fuel represents a significant portion of the operational expenses. In the case of anaerobic digestion of manure, the handling and storage techniques are unique to that fuel. If careful attention is paid to the design and installation of the fuel handling and storage portion of the biomass-fueled cogeneration system, maximum economy will result. Questions to be answered when designing fuel handling and storage systems include:

- o How is the fuel delivered?
- o What type of storage is best for each biomass fuel?
- o How is the fuel best handled and moved from receiving storage to point of use?
- o What, if any, special preparation is needed before the fuel can be used?

### WOOD

#### Delivery

Wood is usually delivered by truck. The type of truck used and the methods needed to unload the truck depend on the form of the fuel and the size of the cogeneration facility. Smaller facilities (less than 25,000 pounds per hour of steam) usually cannot justify the cost of complex unloading and handling systems, whereas larger facilities that require more fuel can afford to invest in more sophisticated machinery.

Four types of trucks are used to haul wood fuels: dump trucks, live-bottom trailers, conventional semi-trailers, and hopper-bottom trucks. Dump trucks and live-bottom trailers have the advantage of being able to dump wood fuel directly into storage piles. Conventional semi-trailer delivery may require that the wood energy user have some type of unloading equipment. Hopper-bottom trucks can only be utilized for delivery of densified or dry fuels.

Dump trucks are best for small systems requiring no more than 2 to 3 loads per day, particularly where transportation distances are short (for example, when the fuel is sawdust and the cogeneration facility is within a few miles of the sawmill). For longer delivery distances, the transportation cost per ton may be 2 to 4 times that of conventional semi-trailer delivery, however. If the cogeneration facility obtains fuel on a "pick-up" basis, rather than by delivery, capital cost of dump trucks is generally low.

Self-unloading trailers offer another option for smaller systems. In most cases, these trailers are equipped with a live floor that "walks" the load out. Trailers range from 30 feet to 50 feet in length, and carry between 18 and 28 tons of wood fuel. A hydraulic power take-off, which receives its power directly from the tractor truck or an external pump, makes unloading a one-person operation. The unloading operation averages 10 minutes. Several sites use these trailers for short-term storage with the unloading rate controlled by fuel demand. The main advantage of this unloading system is that it does not require on-site unloading equipment. However, the cost of a live-bottom van is at least \$32,000, approximately twice the cost of an open trailer of equivalent size.

Conventional semi-trailers offer the most economical method of transporting wood fuels. These trailers can hold up to 22 tons of wood fuel and do not require special design for wood fuel use. In fact, the method most widely used by suppliers of fuel chips is to blow the fuel directly from the chipper into a conventional semi-trailer. In small installations, semi-trailers can be unloaded by front-end loaders which, with the proper ramp or loading dock design, can be driven directly into the semi-trailer. A well trained operator can unload a trailer in less than an hour. The principal expense in this type of unloading is for labor. One drawback is that there is a high potential for damage to the trailer by careless operators, but this is still the preferred method for small installations.

Large cogeneration facilities are likely to employ hydraulic dumpers which can unload an entire semi-trailer in 3 to 5 minutes. Some hydraulic dumpers lift the entire truck and trailer while others require that the trailer be unhitched before being dumped. In either type, the maximum tilt is about 60 degrees and the hydraulic dumper can be fitted with automatic scales so that the weight of the load can be printed out as the truck is dumped. For very wet, finely divided fuels (such as green sawdust) some sticking in the trailer may occur, and mechanical scrapers or shakers may be incorporated into the dumper to ensure that the entire load is released.

Another device used to unload conventional semi-trailers at larger facilities is the Scoop-Roveyor. This apparatus is capable of unloading a 40-foot van in less than 15 minutes. Its functions are controlled by an operator who rides on the collection end of the scoop. These truck unloaders range in cost from \$80,000 to \$100,000 and are considered cost-effective for medium and large-sized plants.

Densified fuel is usually shipped in hopper-bottom trucks. These trucks are unloaded over a pit which is usually equipped with some kind of continuous transport conveyor to move the fuel to the storage area.

Unloading of densified fuel is an extremely rapid and continuous process, but this advantage may be offset, as mentioned in Chapter 3, by the high cost of such fuel.

Three receiving and unloading systems are shown in Figure 4-1.

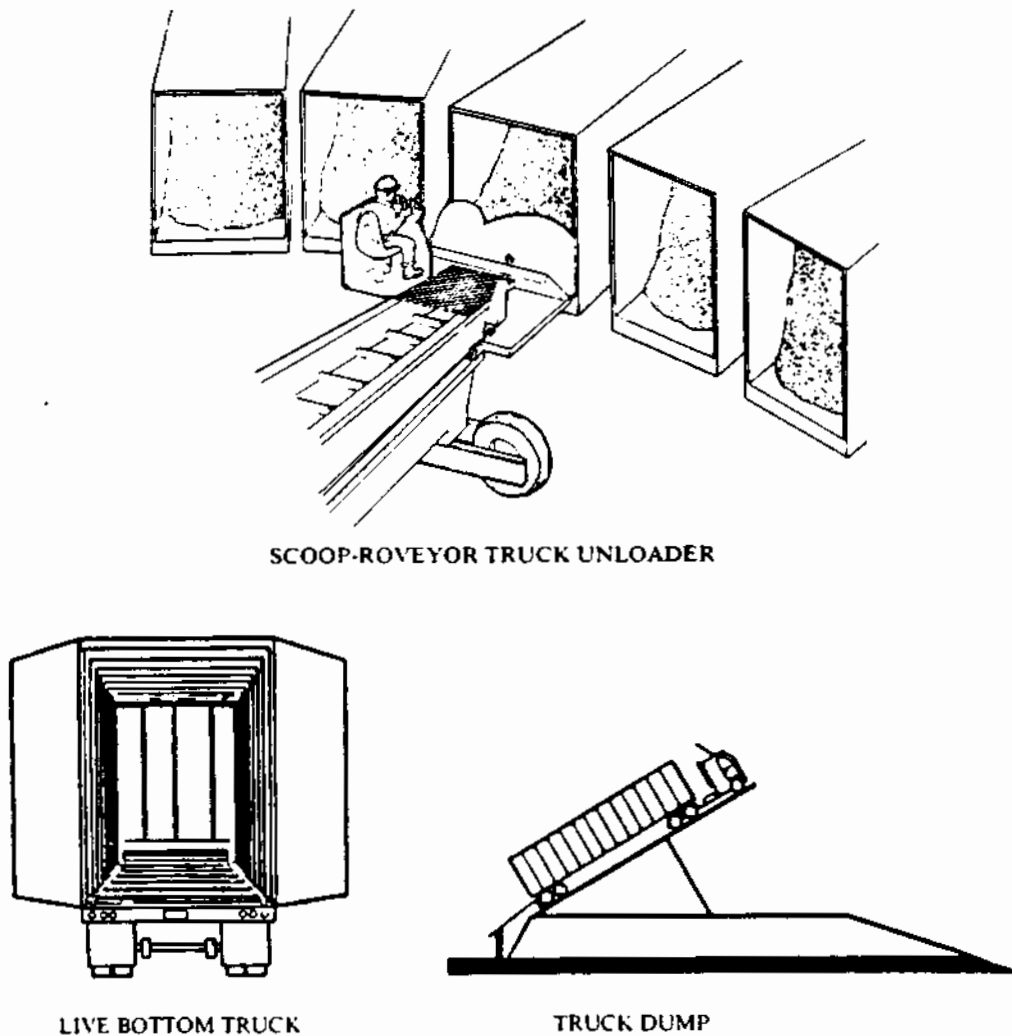

Figure 4-1  
RECEIVING AND UNLOADING SYSTEMS

## Storage

Biomass fuels are less dense (bulkier) than fossil fuels and therefore require large storage areas to ensure continuous supply for a cogeneration facility. The amount of wood fuel that must be stored is dependent on the reliability and delivery schedule of the fuel supplier and the form of fuel being received. If sawmill residues are used, then enough sawdust fuel must be stored to weather the longest anticipated shutdown of the sawmill. Historical records provide information on past operation. In this regard, purchase from a broker, rather than directly from a supplier, can prove to be beneficial, since a broker will likely buy from numerous suppliers. Studies of wood chip supplies carried out in Tennessee show that in an average year, fuel can be harvested 270 days with no down period longer than 10 days. Thus, in most cases, a ten to thirty day fuel storage capability at the cogeneration facility should suffice.

A brief example illustrates the amount of storage needed and is outlined in Table 4-1.

**TABLE 4-1  
FUEL USE AND STORAGE NEEDS FOR A WOOD FUELED BOILER**

Capacity	50,000 lbs/hr steam
Fuel	whole-tree chips
Moisture content	45%
Fuel use rate	13 tons/hr
Fuel used per day	312 tons
Fuel volume per day	27,000 cubic feet
To store 15 day supply	20 feet high by 1/2 acre

Green wood fuels may be stored outside in uncovered piles. The storage area should be well-drained and situated on solid, non-porous ground. An asphalt or concrete pad helps to reduce moisture seepage into the fuel and prevents the mixing of soil with fuel. To repel rainwater, the piles should be built in the shape of a cone or topless pyramid with very steep sides. Front end loaders are often used to move wood fuel to and from the pile, though conveyors are frequently employed at larger facilities.

Open storage piles are the most economical storage option; they provide the greatest storage volume for the lowest cost. However, the wood may absorb moisture from rainfall, which will reduce its fuel value. Green whole-tree chips can be stored in open areas with acceptable increases in moisture content, but storage of dry sawdust for even a few days can result in unacceptable moisture levels. This problem also precludes open storage of dry mill residue or densified wood fuels.

Dry fuel may be held in outside covered storage. A common form of covered storage is an open-sided shed erected over a concrete pad. Partial walls (6 feet or less in height) are often added to help contain the fuel. The wood products industry uses the more elaborate A-frame building storage concept. These buildings frequently have automatic conveyors to move the fuel between storage and boiler locations. Costs for these storage sheds range from \$7 to \$12 per square foot, but they can cost much more when all the required additions such as fire sprinklers, conveyors and site preparation are included. While outside covered storage is also a suitable option for green fuels in some areas of the Southeastern region, freezing temperatures in northern parts of the region preclude its use for wood chips and green mill residue. Outside covered storage should not be used for densified fuels because they tend to fall apart if they get wet.

Enclosed silos are a suitable, although expensive, method of storage for small cogeneration systems and can provide short-term, final storage to facilitate automatic feed systems in larger installations. They are the preferred method of storage for densified fuel since the fuel is less bulky and generally has controlled moisture content, and also for storing other dry fuels where, again, moisture control is important. Table 4-2 lists the capacities of various silo sizes.

Table 4-2  
CAPACITIES FOR VARIOUS SIZES OF  
CONCRETE OR STEEL SILOS

Storage Capacity (Cubic Feet)	Weight of Wood Stored (Tons)	Silo Size (diameter × height)
10,000	100 - 200	20' × 56'
15,000	150 - 180	20' × 72'
20,000	200 - 240	24' × 68'
30,000	300 - 360	30' × 72'
40,000	400 - 480	30' × 88'

Source: A.B. Curtis and B.S. Dixit. Wood Fuel Handling for Industrial Plants. Georgia Institute of Technology, 1980.

### Handling

At a cogeneration facility, fuel must be transported to and from storage, to any preparation equipment, and to the combustion unit. In smaller facilities, a front-end loader is the prime device for the unloading and transportation of fuel, as well as for ash removal. In larger facilities, front-end loaders may be used for these same operations, or may be available as standby units to ensure continuous operation if the primary fuel handling system should suffer a shutdown.

In large facilities, the primary fuel handling equipment may be one of a number of different conveying systems. The particular system selected will depend on the type of fuel, the distance it is to be transported, and the slope (up or down).

The success of a wood handling system is dependent on the selection of the proper conveyor. In most cases, handling problems have resulted from the failure to match the conveyor to the fuel or from improper sizing. Before selecting the type of conveyor to be used, both the type and volume of fuel to be transported must be determined. Table 4-3 lists the features of a number of different conveyors.

**Table 4-3**  
**CHARACTERISTICS OF WOOD**  
**FUEL CONVEYING SYSTEMS**

Type	Cost	Advantage	Disadvantage
Belt Conveyors	highest capital cost, energy efficient	any type of fuel	limited to 15° incline, light dry particles easily blown off
Screw Conveyors	high capital cost, energy efficient	when site space is a premium, easily used on inclines	not applicable for large pieces of stringy wood
Chain Conveyors	medium capital cost, energy efficient	rugged and adaptable to plant conditions	high maintenance, possible fire hazard
Bucket Conveyors	medium capital cost	applicable for inclines and vertical transport	not suitable for long horizontal runs
Oscillating Conveyors	low capital cost, energy efficient	dense, bulky and stringy wood fuels, horizontal transport	not applicable for small light fuels such as sawdust, limited incline
Pneumatic Conveyors	high operating (energy) cost	small, lighter fuels, i.e., finely hogged dry waste, sawdust and sanderdust, long distances	not applicable for larger particles, fugitive dust problems

*Source: Industrial/Commercial Wood Energy Conversion (1986)*



## Preparation

In the ideal situation, fuel would be delivered to the cogeneration facility in a ready-to-burn form. One of the important considerations when selecting a fuel supplier is the quality and uniformity of the product. In many cases, preparation involves screening the fuel for size. Uniformly sized particles of wood facilitate the handling and combustion processes. If particle size reduction is necessary, it is usually done in conjunction with a screen.

Disk and vibrating screens are the types most widely used for wood fuel applications. The disc screen consists of overlapping rotating discs which allow fuel of the proper size to fall through while oversized material is carried off. A vibrating screen passes the fuel over a mesh and can be used to remove either oversized or undersized pieces. Since dirt which may be incorporated with the fuel usually consists of small particles, a vibrating screen can also be used to remove dirt, thus reducing the formation of ash in the burner. Disc screens are less easily clogged than vibrating screens, but vibrating screens are better able to remove smaller particles.

Size reduction is accomplished in a device commonly called a "hog". Two types of hogs are commonly used for wood: the knife chipper, which reduces particle size by forcing the wood against knives, and the hammermill, which beats and grinds the fuel against a fixed screen. Knife chippers can handle fuels with any moisture content. Hammermills, to operate successfully, require that the fuel be relatively dry. Since hogs are expensive to operate, it is advisable to place the hog in a bypass loop and size it to reduce only the portion of the fuel that is too large to be used as is.

## AGRICULTURAL RESIDUES

### Delivery

Primary agricultural residues will usually be delivered by a truck. If the residues are in a finely divided form, the same delivery methods that apply to wood are used. If the residues are in large round bales, the most economical method of transporting field harvested material is delivery by a flat-bed trailer. Specialized handling equipment has been developed for these bales. The unloader is similar to a fork lift and is designed to pick up a bale and move it with little damage to its integrity. Some trailers, designed especially for handling these bales, have a self-contained unloading system which picks the bales from the bed and lowers them to the ground.

If wastes from food processing plants are used in-house for cogeneration, a method of delivering them to a central location is usually in place. Instead of disposing of the wastes, the same equipment is used to transfer it to the storage or burning site. In fact, the location of the burner will often be determined by the location of the waste. Delivery of food processing wastes to an

outside user is usually accomplished by truck, in the same manner that wood waste is delivered.

### Storage

The seasonal availability of agricultural residues requires that a large storage area be planned if year-round operation of the cogeneration facility is desired. Large round bales cannot successfully be stacked, so the storage area required is quite large. Allowing for the required handling space between the bales, one acre can store about 300 tons, or about one day's supply for the wood storage example quoted previously. Storage of a ten month supply, required for year-round operation, would require a storage yard of almost half a square mile. An alternative would be to use agricultural residues in season and other fuels, such as wood, at other times. Whether this would prove to be more economical than simply using wood all year round would have to be determined for each individual case.

Operators of food processing plants who use wastes internally for cogeneration should find peak demand for fuel coinciding with the peak production of fuel. Thus, large amounts of excess feedstock might not be available for storage, and the capability to burn an auxiliary fuel might be all that is necessary to ensure dependable operation.

### Handling

Handling techniques for agricultural residues are the same as those discussed for wood. The exception is the special handling required to move large round bales into and out of the storage area to the facility. These bales cannot be moved by conveyors, and must be handled with the special equipment identified in the delivery section.

### Preparation

Food processing residues will generally be of uniform size and no initial screening is needed. If the material must be reduced in size and is relatively dry, the hammermill is the most suitable hogging device. If the fuel is in large round bales, it requires more preparation. A special machine, referred to as a bale breaker, is used to prepare the fuel for size reduction in the hog. Also at this time, if the bales are plastic wrapped to exclude moisture, the plastic must be removed. Since all of the fuel to be burned must be treated, the hog must be sized accordingly.

## **MUNICIPAL SOLID WASTE**

### Delivery

Municipal solid waste is usually purchased as refuse-derived fuel (RDF) with the non-burnable material removed. It is delivered in trucks which are usually closed semi-trailers. RDF is delivered on a continuous basis since it is produced year-round.

## Storage

The continuous availability of RDF reduces the storage requirements. A 10 to 15 day supply should be sufficient to carry the cogeneration facility through weekends, holidays, and unplanned breakdowns of the supply facility. Uncovered storage is not suitable for this fuel since it readily soaks up moisture and will become waterlogged. Either covered sheds or silos are the preferred storage method. Since the amount to be stored is modest, the cost of covered storage should not be prohibitive.

## Handling

RDF is usually moved from unloading to storage to the burner by conveyor. Since the fuel is quite uniform and has a high enough moisture content (about 30 percent) to flow easily, any type of conveyor listed in the wood section will be suitable.

## Preparation

RDF requires no sizing or screening since it is delivered in a ready-to-burn form.

## **MANURE**

### Delivery

Manure is used at the point of origin. However, transportation from the point of collection to the digester is usually needed.

### Storage

Since manure is produced continually and the cogeneration system is sized to use the average daily supply, a large storage facility is not needed. A holding tank, in which the manure is stored prior to loading in the digester, is the only storage usually provided.

### Handling

The manure is delivered to the anaerobic digester in the form of a slurry containing 5 to 6 percent solids. It is often collected by flushing or scraping the floor of the animal confinement building and is generally moved to a holding tank. Manure is pumped through pipes, although in a few cases, a front-end loader is used to transfer the more solid material.

### Preparation

In the holding tank, the manure may be mixed with additional water to provide the proper consistency for disposal into the digester. The pumps used to transfer the slurry may incorporate coarse screens on the inlet to exclude very large chunks of material, but no further screening or sizing is usually carried out.



## CHAPTER 5: ENERGY CONVERSION TECHNOLOGIES

### INTRODUCTION

Cogeneration is the simultaneous production of electrical (or mechanical) energy and thermal energy from the same fuel source. For the industrial user considering a switch to biomass fuels for energy generation, the installation of a dual purpose power plant offers both technical and economic benefits. The equipment and technologies for cogeneration are well established and the user who is considering a cogeneration facility can draw from a wide pool of experience, particularly in the pulp and paper industry. In this chapter, various biomass cogeneration technologies will be discussed. Equipment will be broken into three categories: (1) electrical generators; (2) biomass converters, which produce either steam or gaseous fuel; and (3) prime movers, which produce shaft power to drive the generator. Questions to be answered include:

- o What are the technical characteristics of cogeneration equipment?
- o What are the operating characteristics of cogeneration equipment?
- o How is each biomass fuel matched to a cogeneration system?

### TOPPING VS. BOTTOMING COGENERATION CYCLES

The two basic cogeneration systems that are available are "topping" and "bottoming" cycles. In a topping cycle, electricity is produced first and the heat rejected from the prime mover is used for process heating. In the bottoming cycle, electricity is produced from the heat remaining in the steam after the process heat requirements are met.

Current technologies for topping cycles offer a number of prime mover options. Steam turbines, gas turbines, and internal combustion engines may be used. The choice will depend on the relative amounts of process heat and electricity desired and the temperature of the process-heating application. Most cogeneration systems use topping cycles.

Bottoming cycles can be employed by industries that operate combustion equipment to produce high temperature process heat, where the combustion exhaust gas or the steam rejected from an industrial process is available at high temperatures. The waste heat must be at a high enough temperature to produce the necessary steam to drive a turbine. A notable feature of bottoming cycles is that, by using waste heat, no additional fuel is needed to generate power. Note that it is

possible to add heat to raise the temperature of process waste heat to a more usable temperature for turbine power production, but this is not a higher efficiency use of the fuel.

Topping and bottoming cogeneration systems are illustrated in Figure 5-1.

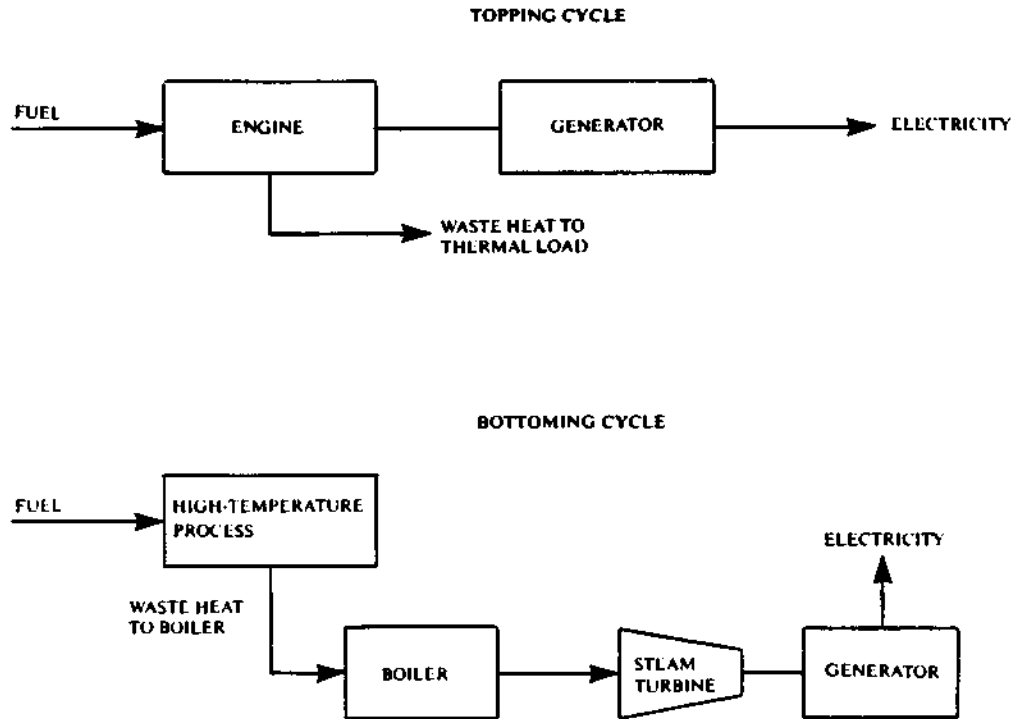

Figure 5-1  
TOPPING AND BOTTOMING COGENERATION SYSTEMS

## ELECTRICAL GENERATORS

The two types of electrical generators that are available for cogeneration systems are synchronous generators and induction generators.

### Synchronous Generators

Synchronous generators are widely used by electrical utilities and are most economical in large sizes (above 10 MW.) Synchronous generators are self exciting and the AC frequency is dependent upon the rotation speed of the generator. As a result, these generators must have a very constant rotational speed (RPM) to produce AC current at a constant 60 cycle frequency. Since each generator operates independently, a cogenerator must invest in protective devices in order to interface with and sell power to a utility. If the utility power

should be interrupted, the cogeneration generator must be instantly removed from the line to avoid having the entire load placed upon it. It must also be isolated so that it does not feed power into a line that the power company thinks is "dead" and endanger the lives of utility linemen. When a synchronous generator is placed on-line, it must be carefully brought into phase with the utility or the sudden shock to the generator can shear the shaft. Fortunately, modern electronics makes this a simple task and line connection is easily accomplished either manually or automatically.

### Induction Generators

Induction generators use electricity from the utility to energize their electrical fields. As a result, the power which they generate is always in phase with the utility and no additional phase matching is necessary. However, voltage is controlled by rotational speed, so induction generators must also be brought on-line carefully. They also produce no power when the utility is off, thus eliminating the disconnects necessary for protection of linemen. (From the standpoint of the utility, though, this is considered an advantage -- repairmen do not have to worry about danger from an unexpected source of power.) Induction generators are generally less expensive than synchronous generators. The primary disadvantage of an induction generator is that it ceases to function when the field is off. Thus, a cogenerator will not have the advantage of standby power during utility outages. If the proper disconnects are installed to completely isolate the cogeneration facility from the utility during outages, a small standby synchronous generator can be used to energize the field of a cogeneration induction generator to provide emergency power on a temporary basis. An induction machine can also operate as an isolated AC generator by supplying the necessary exciting or magnetizing current from capacitors connected across the terminals of the machine (for such installations, disconnects would be needed to protect linemen).

## **BIOMASS CONVERTERS**

Biomass can be converted either into heat (thermal) energy which is used to generate steam, or into gaseous fuels, which can be used to operate internal combustion engines or gas turbines. The most common form of biomass conversion is direct combustion to produce heat by burning biomass in any one of a number of types of furnaces. Conversion to gaseous fuels is accomplished either by heat in a gasifier or by anaerobic digestion.

### Burning

All biomass fuels are suitable for burning except for undried manure. The type of burner used will depend on the size of the fuel and the moisture content. The most common type of burner is the pile burner which is suitable for fuels with high moisture content or

irregular size and shape, such as green wood chips and residues, agricultural wastes, and RDF.

Pile burning designs place the biofuel on a grate to expose as much of the fuel as possible to the combustion environment. Usually, underfire air flows through the grate to provide oxygen for combustion and to promote turbulence. Fuel movement and ash removal are accomplished by using either a moving grate (reciprocating, travelling, rotary or dump grates) or a spreader stoker (mechanical or pneumatic) to transport fuel across a stationary grate. A typical travelling grate boiler is shown in Figure 5-2. Pile burning designs are very tolerant of variations in the quality of the feedstock. These units are usually large in size and have a great deal of thermal inertia because of the quantities of feedstock and refractory lining contained in the boilers.

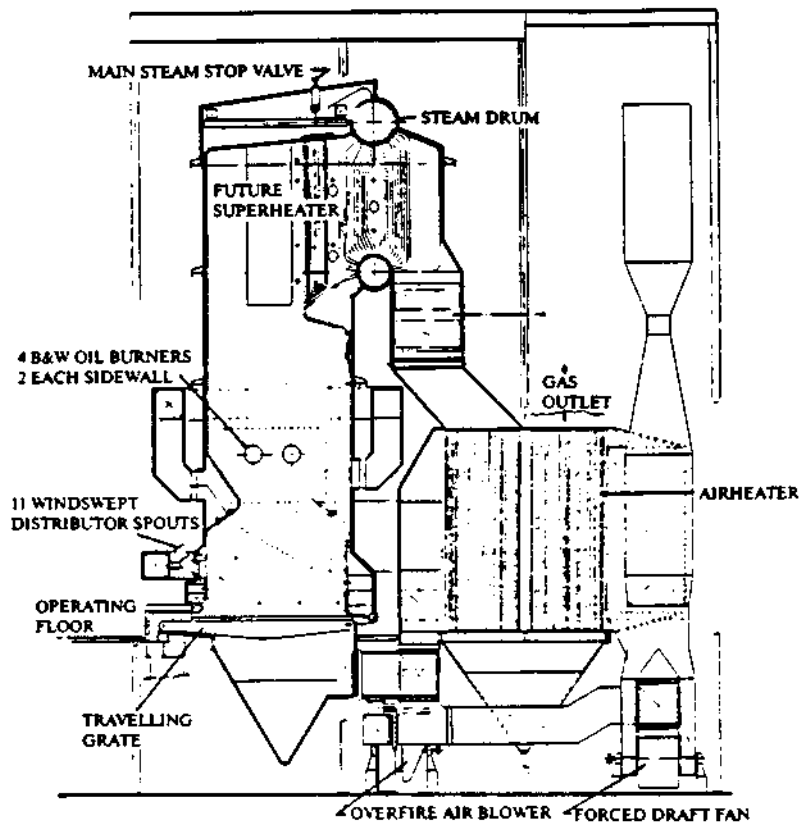

Figure 5-2  
TYPICAL TRAVELLING GRATE BOILER  
*(Babcock & Wilcox Canada Ltd.)*

The second most common type of burners are cyclone or suspension burners. Cyclone or suspension burner designs are adapted from pulverized coal burners. They can only be used with dry, small-sized



biofuel feedstocks, such as wood chips having less than 15 percent moisture content and particle sizes of less than 1/4 inch diameter. These burners turbulently mix the fuel with forced air and the fuel is combusted while suspended in the air stream. Further, they are much more responsive, function more efficiently at part load, and have less thermal inertia than pile burning designs, but the feedstock generally requires a great deal of processing prior to combustion, typically to a quarter-inch particle size or less.

Fluidized bed reactors have a combustion chamber that has many holes drilled in the floor through which underfire air passes. The "bed," consisting of small particles of sand or limestone, is kept suspended by forced air and heated initially by auxiliary fuel. Solid fuel is introduced and burns completely in the turbulent particle bed. These reactors are particularly well adapted to burning dirty, irregularly sized, wet fuels. Fluidized beds can easily handle food processing wastes such as peanut shells and peach pits, as well as all wood and agricultural wastes. Fluidized beds have a high initial cost (approximately 10 percent more than grate burning systems) and higher power requirements for the fans which keep the bed suspended. However, these factors are offset by a number of advantages, including a fast reaction to changes in heat demand, higher combustion efficiency, and reduced maintenance. A fluidized bed combustor is illustrated in Figure 5-3.

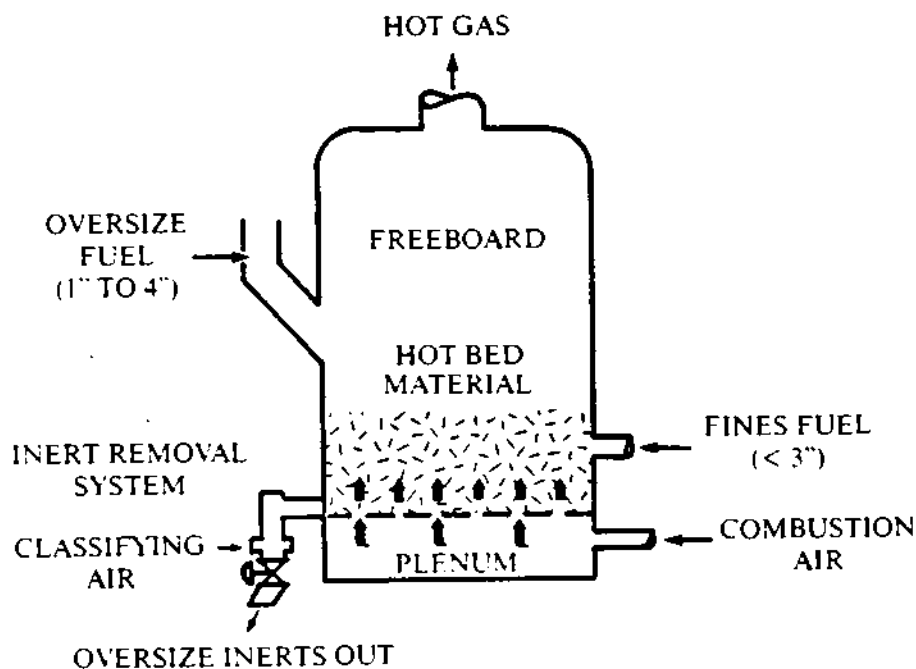

Figure 5-3  
FLUIDIZED BED COMBUSTION SYSTEM

(Drawing After Combustion Power Company, Inc.)

There are two basic types of boilers that are available; these are the firetube and watertube boilers. In a firetube boiler, the hot gases pass through tubes immersed in a water jacket. In a watertube boiler, the water being heated passes through tubes located in the hot gas stream. Firetube units are initially less expensive to purchase and require lower routine maintenance than watertubes. However, they are not suitable for high pressure steam production (above 300 psi), which is generally a requirement if a steam turbine is to be used for cogeneration, and they are limited to about 40,000 pounds of steam per hour.

### Gasification

Thermochemical gasification is a technology based on the partial combustion (with limited air) of biomass fuel to produce heat, and the decomposition by heat of the rest of the fuel to produce a fuel gas. This gas, which consists of a mixture of carbon monoxide, hydrogen, carbon dioxide, and nitrogen (from the air) has a heating value of about 150 Btu/cubic foot (natural gas, or pure methane, has a heating value of 1000 Btu/cubic foot) and can be used to fuel a gas turbine or an internal combustion engine. Once the gasifier reaches operating temperature, the presence of small amounts of water result in the production of more hydrogen, so wet fuel can actually be beneficial to the process. Gasifiers are capable of burning almost any biomass fuel except manure, but they work best when the fuel is uniform in size. Particularly good results have been obtained with RDF.

Figure 5-4 is one type of gasifier configuration known as an updraft. A recent gasifier design in which the combustion air is blown in at the top (downdraft) shows considerable promise for biomass gasification. In this design, corrosive acids and tars, which are produced by all gasifiers, are forced through the fuel bed and combustion zone where they react further to produce more fuel gas. Thus, the cleanup of the gas, which usually requires scrubbing to remove harmful components, is simplified. Sidedraft configurations for gasifiers have been used, and a fluidized bed gasifier is undergoing testing. The gasifier may prove to be the combustion design most suited to a number of cogeneration cycles.

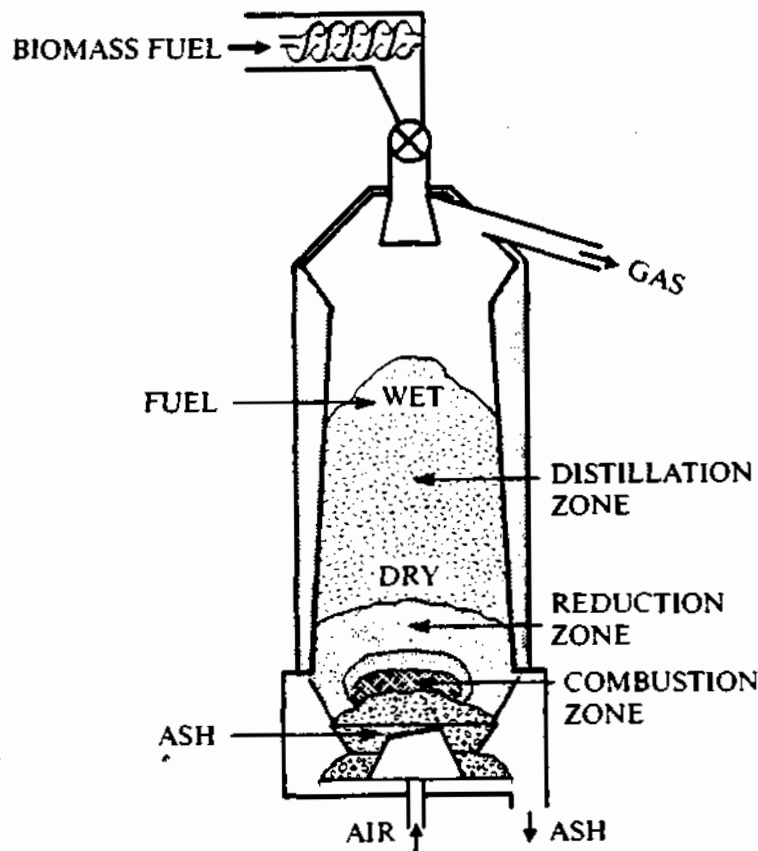
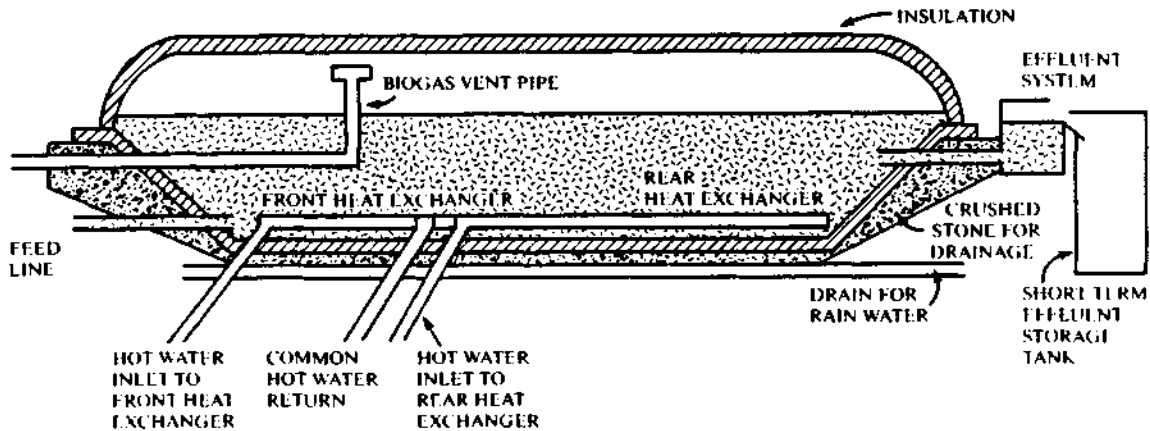

Figure 5-4  
BIOMASS UPDRAFT GASIFIER

### Biochemical Gasification

Biochemical gasification, or anaerobic digestion, involves the use of natural biological processes in the absence of oxygen for the breakdown of organic materials producing "biogas," a mixture of methane (natural gas) and carbon dioxide. The conversion is a complex process carried out by a variety of bacteria which are present in manure. The biogas has a heating value of 500 to 600 Btu/cubic foot and can be burned in gas turbines or in internal combustion engines. The most simple and best suited digester for farm manures is the "plug flow" design shown in Figure 5-5. Manure is loaded in one end of the digester on a periodic basis, one or more times per day. The effluent is forced out by the loading of manure and can be used as fertilizer. The digester is heated to operating temperature (about 95° Fahrenheit) using some of the gas as fuel or, for cogeneration, by using some of

the heat produced in the electrical generation process. A typical plug flow anaerobic digester is illustrated in Figure 5-5.



**Figure 5-5**  
**CROSS SECTION OF THE MODIFIED**  
**FULL SCALE PLUG FLOW DIGESTER**

Source: Feasibility of Biogas Production on Farms (1982)

## PRIME MOVERS

Prime movers convert thermal energy, in the form of steam or fuel gas, into mechanical energy which can be used to spin a generator for the cogeneration of electricity. The prime mover most often used for biomass cogeneration is the steam turbine. Steam turbines for cogeneration systems typically operate with inlet steam pressures of 450 to 650 psig, although they can operate at lower pressures if required process heat temperatures are also low. The type of turbine selected is determined by the relative demand for electricity and process steam. In most cases, the cogeneration system will be designed to provide process heat (since it is replacing boilers) and the electrical generation will vary. The turbine best designed to meet variations in both steam load and electrical load is the condensing extraction turbine. The chief liability of such a turbine is that it results in significantly lower overall system efficiency. This is because condensing extraction turbines rely on a cooling tower or condenser downstream from the turbine to create a maximum pressure drop across the turbine. Steam is condensed at the exhaust of these turbines, and the heat available in the condensate is at too low a temperature to be utilized, thus representing wasted energy; process steam must be extracted at midpoints in the turbine. The extraction of steam results in a decrease in the amount of electricity produced per

unit of steam and an increase in the amount of thermal energy delivered for process applications.

Non-condensing or backpressure turbines simply act as a steam pressure reducer; steam is rejected downstream from the turbine and is still suitable for process heat applications. For smaller installations (less than a few megawatts), a back pressure turbine is usually specified. The pros and cons of condensing versus extraction turbines for cogeneration applications are discussed further in Chapter 6. Figure 5-6 illustrates the use of a steam turbine in a typical topping configuration.

Bottoming configurations for steam turbines use the exhaust heat from a high temperature process to produce steam which is then run through a low pressure turbine for electrical production. However, such installations are not very common.

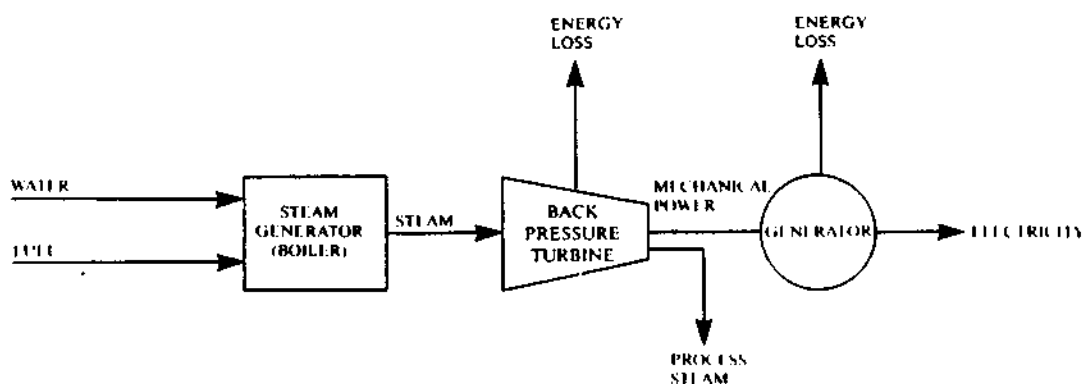
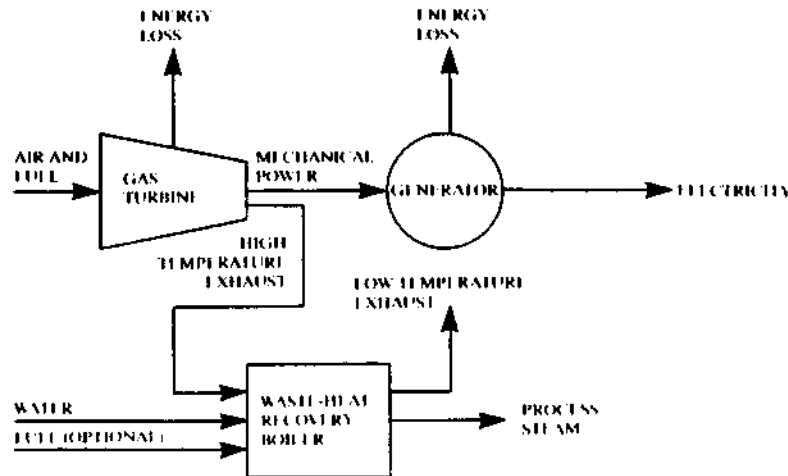

Figure 5-6  
STEAM TURBINE TOPPING COGENERATION SYSTEM

### Gas Turbines

Gas turbines use the gas produced by a biomass gasifier as fuel to produce shaft power. The turbine mixes and compresses an air-fuel mixture, burns it, and releases the combustion products through an expansion turbine which drives an electrical generator. Waste heat is captured by a boiler and produces steam. In its simplest form, the steam is used for process heat. However, the steam may be produced at a temperature higher than needed. In such cases, a combined cycle cogeneration system includes a steam turbine and an additional generator. Steam is extracted from the steam turbine to meet process heat needs. This configuration produces maximum recovery of heat from the biofuel. A gas turbine topping system and a combined cycle system are shown in Figures 5-7 and 5-8.



**Figure 5-7  
GAS TURBINE TOPPING SYSTEM**

Gas turbines are essentially stationary jet engines. Electric utilities frequently use gas turbines for power generation at their peak load. In this application, the mechanical shaft energy of the gas turbine drives a generator unit.

In cogeneration, the high temperature (800<sup>o</sup> - 1000<sup>o</sup> Fahrenheit) exhaust heat from a gas turbine can be used as a heat source for process use or input into a waste heat boiler to generate steam. For a given quality of steam requirements, gas turbines can produce more electricity than steam turbines.

Small gas turbines, because of their relatively low electrical efficiency and high excess air requirements, are of interest in applications where heat usage is four to five times electricity usage.

In combined-cycle cogeneration, a gas turbine with a waste heat boiler is combined with a steam turbine. Both engines produce work and then use the exhaust heat or turbine exhaust steam for a heating process. A combined cycle is most often used when the distribution of heat and work is such that a simple cycle will not meet load requirements effectively.

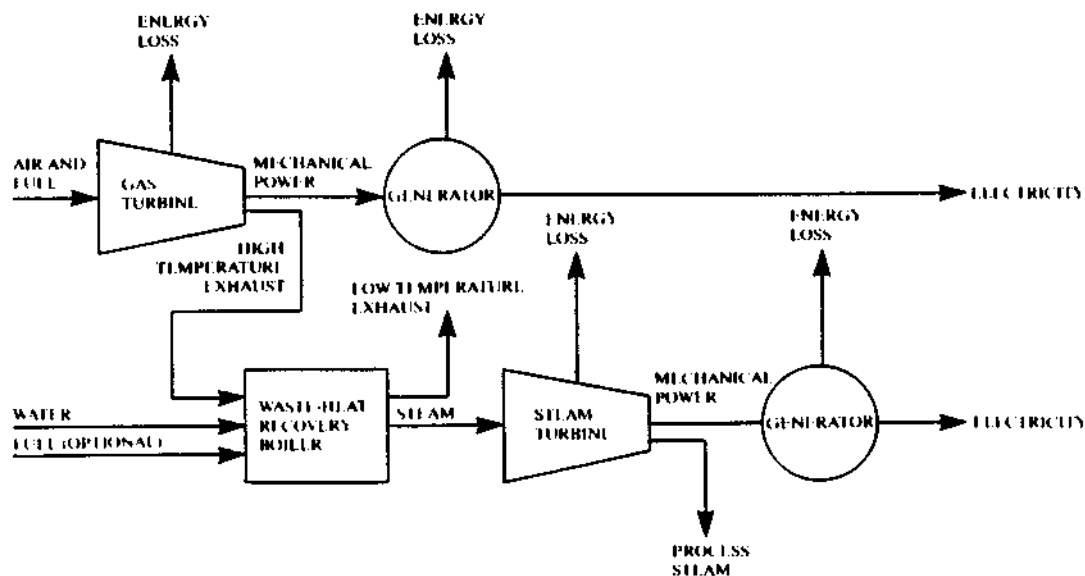

Figure 5-8  
COMBINED CYCLE TOPPING SYSTEM

In a combined-cycle system, the gas turbine drives an electrical generator, and the rejected heat is recovered by a waste heat boiler. The recovered steam is used in a steam turbine driving a generator to produce additional electricity. Steam rejected from the turbine is then used directly in the industrial process or for heating.

### Internal Combustion Engines

Internal combustion engines can operate on low-Btu gas from a biomass gasifier or on biogas from an anaerobic digester. The technology currently exists for utilizing these gases for cogeneration of electricity, steam, and hot water. Gas fueled spark ignition engines are commercially available and small-scale electrical generation equipment is also accessible for power generation, either independently or in parallel with a utility.

In cogeneration operations, the engine produces shaft power for electrical generation. Waste heat is recovered directly from the engine cooling system as process hot water, and recovered from an exhaust heat exchanger as low pressure steam. A typical engine-generator cogeneration system is illustrated in Figure 5-9.

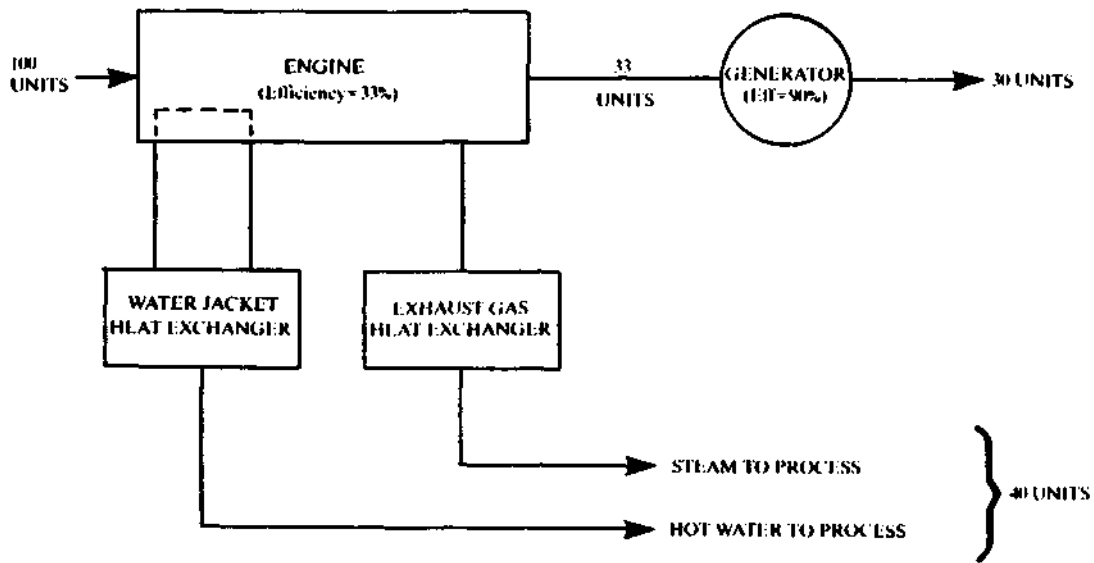

**Figure 5-9**  
**ENGINE-GENERATOR COGENERATION SYSTEM**

Prime Mover Summary

Table 5-1 summarizes information on a number of cogeneration topping cycles that are available and can be fueled by biomass.

**Table 5-1**  
**COGENERATION TOPPING CYCLE PERFORMANCE PARAMETERS**

Cogeneration Systems	Electrical Capacity of a Single Unit (kW)	Heat Rate <sup>2</sup> (Btu/kWh)	Electrical Efficiency (%)	Thermal Efficiency (%)	Total Efficiency (%)	Exhaust Temperature °F	Steam (#/hr.) Generation @ 125 psig
Small Reciprocating Gas Engines	1-500	25,000 to 10,000	14-34	52	66-86	600-1200	0-200 <sup>1</sup>
Large Reciprocating Gas Engines	500-17,000	13,000 to 9,500	26-36	52	78-88	600-1200	200-10,000 <sup>1</sup>
Industrial Gas Turbines	800-10,000	14,000 to 11,000	24-31	50	74-81	800-1000	3,000-30,000
Utility Size Gas Turbines	10,000-75,000	13,000 to 11,000	26-31	50	76-81	700	30,000-300,000
Steam Cycles	500-100,000	60,000 to 10,000	7-34	28	35-62	100-1000	10,000-100,000

<sup>1</sup> Hot water @ 250°F is available at 10 times the flow of the steam.

<sup>2</sup> Heat rate is the heating value input to the cycle per kWh of electrical output. The electrical generation efficiency in percent of a prime mover can be determined from its heat rate by the following formula:  $EFFICIENCY = \frac{3413}{Heat\ Rate} \times 100$



## Conversion Technologies Overview/Summary

The following is a summary of the status and attributes of biomass conversion technologies.

- o Pile Burning Boilers -- proven technology; slow response to load changes; poor efficiency at part-load; fuel flexibility regarding shape and moisture content.
- o Cyclone or Suspension Burners -- require very dry and small particles (approximately 1/4 inch in size); faster response to thermal load changes than pile burners; good part-load efficiency.
- o Fluidized Beds -- recently commercialized; higher initial cost (approximately 10 percent higher than pile burners); higher parasitic fan power; substantial flexibility regarding fuel characteristics; fast response and good part-load efficiency; significantly higher efficiency (approximately 68-70 percent) than pile burners (approximately 65 percent) when using high moisture fuels (40-50 percent moisture).
- o Gasifiers -- currently in developmental to early commercial status; lower capital cost; uncertainty regarding use of producer gas with engines or turbines due to concerns with tars and other liquids in the gas; attractive retrofit option for natural gas or oil boilers.
- o Anaerobic Digesters -- proven technology for digesting sewage sludge and food processing residues; initial barriers related to high capital cost and maintenance costs for on-farm manure digestors have recently been overcome.



## CHAPTER 6: SYSTEMS CONSIDERATIONS

### INTRODUCTION

The technical feasibility of a biomass fueled cogeneration facility depends on a few major considerations. The characteristics and availability of a suitable fuel source have been discussed in some detail in previous chapters. Once an adequate fuel supply at a reasonable cost has been identified, the next consideration involves the nature and magnitude of the energy demand. In this chapter, the energy demand, its characteristics, and the technology needed to satisfy the demand will be discussed. Questions to be answered include:

- o How are energy requirements evaluated?
- o What is the relationship between the energy load and cogeneration system design?
- o What design strategies will maximize the benefits of biomass cogeneration?

### ENERGY DEMAND

In assessing the feasibility of a biomass cogeneration system, the first issues to be addressed involve the magnitude and characteristics of the facility's energy needs. One of the key criteria for a viable cogeneration system is the presence of a substantial year-round thermal energy requirement or demand. The relative proportions of electrical and thermal energy required and the variation of demand over time must also be considered. The energy demands to be considered for a cogeneration facility design are shown in Figure 6-1.

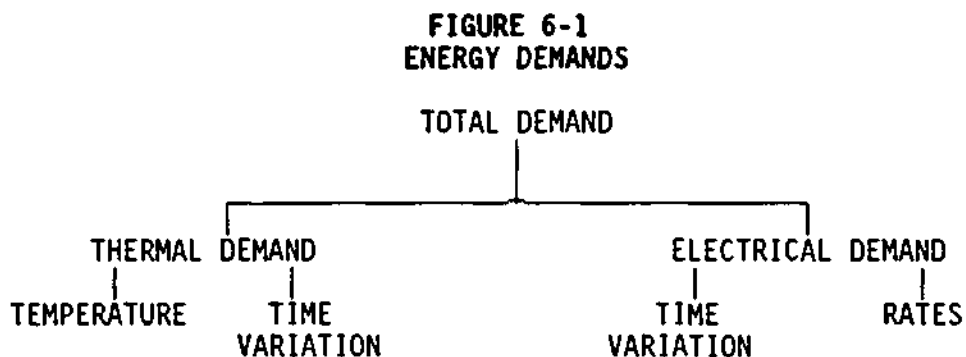

## Thermal Demand

### o Temperature

Steam is the predominant heat transfer medium in industrial production. Different industrial processes require different temperatures, though a majority are within the range of 100°F to 350 °F. A number of processes, along with the required process temperatures and the input steam temperatures and pressures, are shown in Table 6-1.

Table 6-1  
APPLICATIONS TEMPERATURE RANGES

APPLICATIONS	TEMPERATURE °F	STEAM	
		Temperature °F	Pressure psia
Food Processing	100-350*	200**-450	15-420
Textile Mill	200-300	300-400	70-250
Malt Beverages	200-300	300-400	70-250
Soft Drinks	100-200	200**-300	15-70
Organic Chemicals	200-300	300-400	70-250

\* 200 except for deep fat frying

\*\* hot water

Since most processes require steam at low to moderate temperatures and pressures compared to turbine generator requirements, a topping cogeneration cycle is likely to be the configuration used. As described in Chapter 5, topping cycles use high temperature steam to first produce shaft power for generating electricity, and then the exhaust from the turbine is used to provide process heat.

### o Time Variation

The demand for thermal energy in industrial applications is rarely constant; the manner in which demand fluctuates will influence both the design of a cogeneration facility and its economic viability. Both short-term and long-term variability in demand occurs. Figure 6-2 illustrates an industrial process with short-term demand variability. The typical design capacity of the biomass cogeneration system's thermal output is also shown set to allow the system to operate in a more efficient, steady state mode; peak thermal demands could be met with a back-up gas or oil boiler.

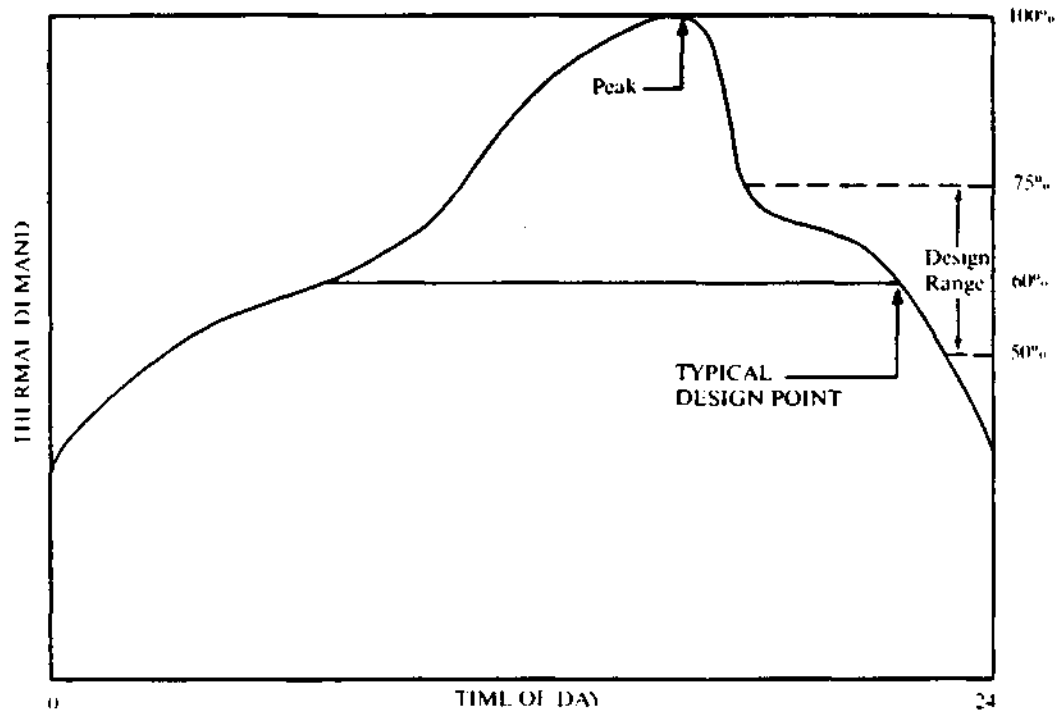

Source: *Cogeneration Handbook* (1982) Calif. Energy Commission

**Figure 6-2**  
**SHORT TERM LOAD VARIABILITY**

In addition to the short-term variations, one may encounter longer term variations such as seasonal demands brought on by winter space heating requirements. This type of variation is shown in Figure 6-3. Seasonal variations can be offset and the seasonal demand leveled out if summer cooling loads are met using thermal absorption chillers

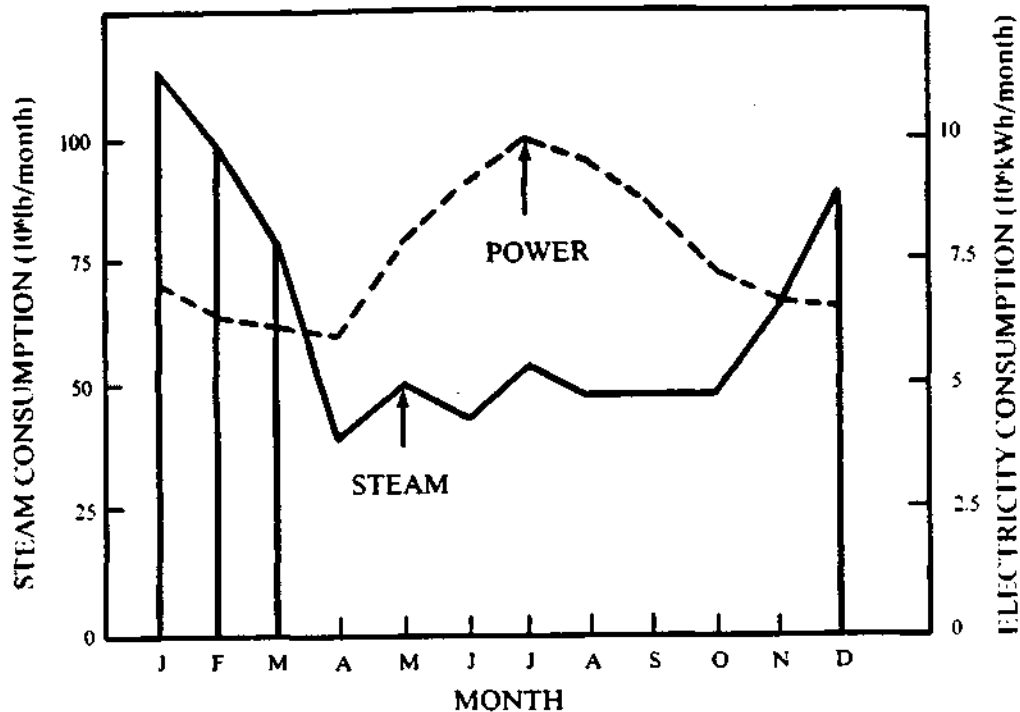

**Figure 6-3**  
**ANNUAL LOAD VARIATIONS DUE TO**  
**SPACE HEATING AND AIR-CONDITIONING**

Electrical Demand

o Time Variation

The electrical demand will vary with time in much the same manner as thermal demand, but the short-term variations will generally be greater. In the operation of electrical equipment there are many on-off cycles that require high surge current supply capability. In most cogeneration facilities, however, the power production is backed up by the utility, and demand surges above the generating capacity are covered by purchased power. Seasonal variations in electric demand tend to be much smaller than seasonal thermal variations and are usually not as important as thermal load profiles in sizing a cogeneration system.

## o Rates

The purchase and buy-back rates charged for electricity by the local utility can be a determining factor in designing the power producing portion of the cogeneration facility. Under the Public Utility Regulatory Policies Act of 1978 (PURPA), utilities must pay reasonable rates for the electricity produced by such a facility, and a number of strategies can be utilized to take maximum advantage of the law. PURPA is discussed in more detail in Chapter 7.

## DESIGN STRATEGIES

In industrial processes, providing steam is a key concern of plant operators. As a result, industrial cogeneration systems usually track the steam demand rather than the power demand. (This is in strong contrast to the commercial power plant where meeting the power demand is the primary concern.) Therefore, most design strategies for cogeneration concentrate on proper thermal sizing. The optimal system will make complete sequential use of the heat input to the system. All heat is added at the beginning of the cogeneration cycle, flows through the power producing and heat using system, and then is rejected at as low a temperature as possible. As noted earlier, most industrial heat use is in the low- to medium-temperature range (100<sup>o</sup>-350 <sup>o</sup>F). Thus, topping cycles are commonly used to cogenerate energy since the electric power is produced first by using high temperature steam; then, after passing through the turbines, the steam is used at lower temperatures for the industrial process.

### Thermal Sizing Options

The thermal sizing of a cogeneration system depends on the type of variations found in the steam load. Biomass fueled boilers, as discussed in Chapter 5, are best suited for continuous operation and are not capable of tracking rapid fluctuations in demand. When the load is relatively constant, a biomass fueled cogeneration system can be sized to produce steam to cover the full load. However, when the load has significant peaks, this may not be feasible. In general, there are three thermal sizing options which must be considered, as shown in Table 6-2.

TABLE 6-2  
THERMAL SIZING OPTIONS

PORTION OF PEAK THERMAL DEMAND	DESIGN IMPACT
100%	Supplemental boilers needed only for backup (optional).
< 100%	Supplemental boilers required to meet demand.
> 100%	Excess steam or hot water available for sale or plant use.

The first option will allow the maximum amount of load to be met by the cogenerated heat rather than by supplemental boilers. However, if a biomass cogeneration system is sized to meet the maximum peak load, it will operate at reduced capacity much of the time. This means that the prime mover will be oversized and generally will result in lower overall system efficiency; unused capacity also generally represents a poorer investment. Thus, unless the load is relatively constant, sizing the cogeneration boiler to meet 100 percent of the thermal load is usually unattractive.

Cogeneration systems are therefore often sized to meet a large portion, but not all, of the thermal requirements with supplemental heat provided by auxiliary boilers. (In the case where a biomass cogeneration system is replacing existing boilers, these existing boilers may be retained for supplemental supply.) The prime mover will operate at full capacity most of the time and may even generate excess electricity which will provide additional revenue if sold to the electric utility. Any of the prime movers, including steam turbines, gas turbines, or internal combustion engines, are considered suitable for this type of operation.

Where an additional steam load has been identified either from within or outside of the plant, the generation of excess steam may be investigated. However, this option is not often feasible either due to the difficulties of finding a suitable steam buyer nearby who is willing to purchase the steam, or because of the inefficiencies and costs associated with piping steam more than about two miles.

With the typical, fluctuating thermal load profile of most small industries, cogeneration systems are usually designed to meet from 50 percent to 75 percent of the maximum thermal load. This allows the facility to meet the average thermal load over 90 percent of the time and will result in a high level of system utilization.



## Electrical Sizing Options

There are three possible operating conditions for the electrical part of the cogeneration system:

- o Design the system to generate less than (or equal to) the maximum electrical load; use all cogenerated electricity to satisfy internal electrical loads and purchase additional power from the utility as necessary. Thus, all power produced displaces the purchase of electricity at the utility's normal rates.
- o Design the system to produce electric power in excess of plant needs; use power produced to satisfy internal requirements, displacing purchase of retail electricity from the utility; excess power is sold to the utility at PURPA avoided cost rates (discussed in Chapter 7), i.e., wholesale rates.
- o Sell all cogenerated power to the utility at a "wholesale" rate and simultaneously purchase plant power needs at a "retail" rate.

The third option, simultaneous sale and purchase, is sometimes the only contract a utility will agree to. Generally, revenues are maximized if power used internally can offset use/payment of retail electricity from the utility. The cost to cogenerate the power must be less than or equal to the avoided cost or the negotiated rate at which the utility will buy the power. The option with the greatest economic return will be determined by the cost to cogenerate power and the buy-back rate that can be negotiated with the utility. All options should be investigated thoroughly since the final choice of the type of biomass fueled cogeneration system to be installed will depend on the overall economics of the situation, which will be discussed further in Chapter 9.

## Technical Considerations

Three types of prime movers are considered suitable for biomass fueled cogeneration: steam turbines, gas turbines, and internal combustion engines. Steam can be supplied to turbines by boilers heated by any one of the biomass fuel conversion technologies discussed in Chapter 5. Gas turbines and internal combustion engines require a gaseous fuel which could be produced from biomass through gasification or anaerobic digestion. Key parameters used to evaluate cogeneration configurations are shown in Table 6-3.

**TABLE 6-3  
KEY PARAMETERS FOR COGENERATION DESIGN**

PARAMETER	DEFINITION
Power to heat ratio	The relative amounts of electricity and heat produced by the cogeneration system.
Fuel use efficiency	The ratio of electric output plus heat recovered per Btu to the fuel input in Btu. This parameter helps determine the useful thermal output of the system.
Incremental heat rate	The ratio of fuel consumed minus heat supplied to the net power output of the prime mover. This represents the additional amount of fuel needed to generate each increment of power.

These parameters vary with each prime mover and can be summarized as follows:

- o For a given capacity, the power to heat ratio is lowest for the steam turbine and highest for the internal combustion engine.
- o For a given capacity, the fuel use efficiency rate for industrial applications is highest for the steam turbine and lowest for the internal combustion engine.
- o The incremental heat rate, at a given capacity, is lowest for the steam turbine and highest for the internal combustion engine.

#### Steam Turbines

It would appear that for most biomass fueled cogeneration systems, in which providing process steam is a higher priority than power production, the steam turbine would be the prime mover of choice, provided that there is sufficient load for the size of the units available. For most cogeneration applications, a non-condensing turbine (i.e., backpressure turbine) is generally specified. In the non-condensing unit, process steam, pressure and flow are requirements to be satisfied. Since electric generation is a direct function of steam flow, periods of low steam demand correspond to low electrical generation. Electrical loads in excess of the available power produced must be satisfied from the local electric utility. Excess electrical power can be sold to the local utility.

If it is viewed essential to meet variations in both process steam and electrical requirements, a condensing turbine is required. In times of high steam demand, most of the power is generated by the steam before extraction, and power output is low. When little steam is needed, the entire steam flow is through the turbine and power output is high. Thus, variations in both power generation and steam requirements can be accommodated. The power to heat ratio can, using an extraction/condensing turbine, be varied from about 30 to 75 kWh per million Btu. This variation can be done without changing the fuel input, which is of particular importance for biomass fueled boilers. Excess power produced when process steam demands are low can be sold through the utility interconnect. It should be noted, though, that condensing turbines require a cooling tower or condenser which results in higher system costs and complexity and lower overall system efficiency (unusable waste heat is discharged from the condenser).

TVA has found that the most suitable turbine for a low-pressure, topping cycle system is a small, single-stage, back-pressure turbine. It can utilize the relatively low pressure available from the plant boiler to produce electric power, while exhausting steam at any pressure required by the process. The back-pressure turbine is usually smaller and less costly than the condensing and extraction turbines. In the past, it was generally believed that steam generation at a pressure of 250 to 400 psig was required to realize any appreciable work from a turbine exhausting at pressures usable for process needs. However, TVA has studied the feasibility of using low-pressure inlet steam (125 psig) for the production of electric power at small commercial/industrial facilities and found the results economically feasible for certain project sites.

#### Intermediate Gaseous Fuels

If an anaerobic digester using manure is the source of the biomass fuel, the only practical prime mover is the internal combustion engine. The conversion efficiency obtained by burning biogas in boilers and then generating steam for a turbine is much lower than that obtained by direct use of the biogas in an engine. Also, most biogas-producing digesters are much too small to provide the fuel necessary for a steam turbine. The greatest electrical efficiency is obtained from internal combustion engines when they are operating at full load, so biomass cogeneration systems using this fuel should be sized for maximum electrical production with the heat produced (mostly as low temperature steam or hot water), supplemented by other fuels where necessary. In many cases the sale of excess electricity will more than pay for supplemental heat.

The use of biomass fueled gas turbines, with the fuel gas produced by gasification, is still in the engineering field test stage. If gasification of biomass fuels appears to be the technology of choice, these gas turbines should be seriously investigated as prime movers for

a cogeneration system. (The TVA Regional Biomass Energy Program has been helping support the development of this turbine).

### Emission Controls

Some type of pollution control equipment is usually required on biomass fueled burners since a large quantity of particulate matter is often generated. The design of many biomass fuel burners has been optimized to reduce particulates, and technologies for particulate removal are well known. In general, biomass fuels produce negligible amounts of sulfur oxides ( $SO_x$ ), so sulfur removal is much less of a concern than that for fuels such as coal. The exception is the anaerobic digester where hydrogen sulfide ( $H_2S$ ) is produced along with the biogas. Often  $H_2S$  is removed by a trap before the fuel reaches the gas engine, as  $H_2S$  is highly corrosive when burned. Anaerobic digesters have the added advantage of alleviating manure disposal problems. The effluent from an anaerobic digester is free of disease-causing bacteria and emits less odor than the original manure. It can be used as fertilizer, and the avoided costs due to meeting EPA requirements for manure disposal can be used to offset the cost of the digester system.

### Operation and Maintenance

Biomass fueled cogeneration systems often require more attention to operation and maintenance than do oil or gas fired equipment. Costs are quite similar to those for coal, with the added requirements for handling a larger quantity of less dense fuel. Extra electrical costs due to larger fans or more complex fuel handling equipment are often offset by lower fuel costs. Biomass conversion equipment is reliable and the lifetime should not differ from equipment used for other fuels. System life expectancy can be regarded as well documented since most equipment design is standard. There is some evidence that small industrial gas engines operated on biogas from anaerobic digesters may suffer premature bearing failure due to acids formed by the hydrogen sulfide in the gas. This is alleviated by using a  $H_2S$  trap in the gas line before the engine.

## SYSTEM DESIGN SUMMARY

The items which must receive consideration in the design of a biomass fueled cogeneration system are summarized as follows:

### Fuel Selection

- o The fuel selected should have continuous availability in a form that will ensure reliable operation of the cogeneration facility.

- o Adequate storage space for enough fuel to bridge possible interruptions of supply must be provided.
- o Handling systems for moving the fuel to and from storage and to the converter must be designed.

### Converter Selection

If the fuel is to be burned, the burner must be matched to the fuel type and sized to meet the projected needs of the cogeneration facility.

- o If an intermediate gaseous fuel is to be produced from the biomass, the gasifier must be matched to the biomass fuel (i.e., anaerobic digestion for manure and a thermal gasifier for other biomass fuels).
- o Steam boilers for biomass cogeneration systems are often sized to produce steam at approximately 700° F and 650 psig. Above this level, a licensed boiler operator is generally required.
- o If temperature requirements for process heat are low (e.g., 90 to 100° F), it may be possible to use a boiler with output pressures as low as 125 psig to power a backpressure turbine for cogeneration.

### Prime Mover Selection

- o If steam is generated, a number of different configurations of turbines (condensing, extracting, back-pressure) should be examined to select the one that meets the energy needs of the system; usually a back-pressure turbine is used for biomass cogeneration, especially for systems below a few megawatts in capacity.
- o If a gaseous intermediate fuel is produced, the prime mover must be either a gas turbine or an internal combustion engine.
- o For varying loads, recoverable heat in the required temperature and pressure range should be equal to 50-75 percent of the peak thermal load.

### Generator Selection

- o With modern technology for systems larger than a few megawatts, the selection of an induction versus a synchronous generator should be made based on economic considerations since either type is reliable and easy to operate.

- o For systems less than approximately one megawatt, induction generators are usually less expensive and less complex to operate and are thus generally preferable to synchronous generators.

#### Emission Control

- o Standard particulate removal procedures can be used for the flue gases.
- o Sulfur dioxide emissions are usually negligible.

#### Capital Costs

- o Capital costs for biomass energy systems are higher than for oil or gas systems, due to the additional fuel handling and storage equipment needed, and more massive boiler sizes to accommodate bulky fuel.
- o Cogeneration systems have higher capital costs than systems which produce only heat, but higher costs are offset by the return from electrical generation.

#### Construction Time

- o In most cases, construction time for a biomass fueled cogeneration system will be similar to that for a coal-fired system and slightly longer than required for an oil or gas fired system.

## CHAPTER 7: UTILITY INTERCONNECTION

### INTRODUCTION

This chapter briefly summarizes the technical and regulatory aspects of electrical connection of a biomass fueled cogeneration facility to the utility. Until cogeneration is considered, the electrical system of the utility need only be designed to regulate power flow in one direction -- that is, from the utility to the customer. However, cogeneration facilities can take power from the utility grid or deliver power to the grid, resulting in a two-way flow. The two-way flow of power requires that special attention be paid to the interconnection between the cogenerator and the utility. Interconnection is not a simple procedure and steps must be taken to ensure that both the utility and the cogeneration facility are protected from variations in operating conditions that could endanger both equipment and human life. Barriers to the sale of cogenerated electricity to utilities have been substantially removed as a result of the Public Utility Regulatory Policies Act of 1978 (PURPA). Questions to be answered in this chapter include:

- o How is the cogenerated power synchronized with the utility?
- o What devices are necessary to protect both life and equipment?
- o How will the utility/cogeneration interface be designed?
- o What are the requirements under PURPA that will allow the sale of cogenerated electricity to utilities?

### GENERATORS

Two types of generators are available for use in a biomass fueled cogeneration system. The advantages and disadvantages of the synchronous and induction generators are outlined below.

#### Synchronous Generator

As described in Chapter 5, a synchronous generator is what is referred to as a "self-exciting" generator. The electrical current to provide the field is produced by the generator. Therefore, the production of electrical power is independent of the load and the generator can operate independently of the grid, providing power at its own frequency and phase. When a synchronous generator is interconnected with the grid, the frequency and phase are electronically matched and automatically controlled.

#### Induction Generator

An induction generator is not capable of generating power unless it is connected to an outside source of electricity to provide the field current. The generator must be connected to the grid to operate

and when the grid fails, the generator stops producing power. Since power produced by the generator is dependent on the grid, it is always in phase and frequency-matched with the grid. However, voltage is dependent on generator speed, which must be externally controlled.

## TECHNICAL ISSUES

### Utility Breaker Tripping

The utility interconnection in a cogeneration system contains a utility breaker which disconnects the system from the grid when necessary. Should this breaker open, the in-plant generator will become isolated from the grid and will still be attached to the load. In the case of an induction generator, the loss of the grid will stop generation of electricity and the plant will lose all electric power.

The loss of generator load may cause overspeeding of the prime mover and automatic cut-offs should be installed to prevent damage to the equipment. A synchronous generator will continue to supply the full plant load. If the cogeneration facility was not meeting the full load and the grid is lost, the generator will be overloaded with possible damage to both generator and load. To prevent damage, nonessential loads must be removed from the generator by automatic load-shedding devices.

It is also good practice to provide an automatic disconnect which isolates the cogeneration system from the grid in the event there is trouble with the system. This would prevent damage to the generator and provide personnel protection as well.

### Automatic Utility Breaker Reclosing

Automatic reconnection of the cogeneration system to the grid must be approached with caution. An induction generator is turned off when the grid connection is broken, and when reconnected it will automatically be in phase. If the generator speed has been maintained, the voltage will still be within limits. However, a synchronous generator that is still operating may have fallen out of phase with the grid during the disconnect period. When the grid is suddenly connected, the generator will try instantly to match phases and the resulting shock can shear the generator shaft and cause extensive damage to equipment within the plant. Although automatic phase matching is available to bring the generator into phase with the grid, a manual reconnect is recommended for safety reasons.

### Power Quality

The utility will require that the cogeneration facility provide power to the grid that is of suitable quality. Voltage, frequency, and phase of power are factors to be considered.

Utilities generally require that voltage be maintained within plus or minus 5 percent of the nominal voltage. Should the voltage from the



cogeneration facility fall outside this range, an automatic over/under voltage relay will disconnect the system from the grid. Synchronous generators have internal voltage regulators, while induction generators require external devices to control generator speed.

Requirements for frequency control are quite strict since many timing devices are based on the grid frequency. The frequency of induction generators is controlled by the grid and no further controls are necessary. Synchronous generators have their own frequency controllers which can be automatically matched with the grid. Most utilities will disconnect a cogeneration facility that does not maintain proper frequency control.

The design and installation of protective relays, matching equipment, and power factor correction is the responsibility of the cogenerator. While utilities may have published guidelines for the protection package, the customer is free to choose any package. If the power produced does not meet utility standards, the cogeneration facility will be disconnected by the utility.

#### Standby Power

The operator of a biomass fueled cogeneration facility may want to use the facility to provide emergency power when the grid is down. If a synchronous generator is chosen, emergency operation is easy since power production is independent of the grid. Precautions must be taken to ensure that the generator is not overloaded and that it cannot be automatically reconnected to the grid when the utility power comes back on. An induction generator can be used for standby power if a small synchronous generator is used to provide excitation current. This generator might be powered by a fossil-fueled internal combustion engine. It would require frequency control since the induction generator frequency would follow the small generator frequency. If such an emergency system were installed, control devices would be required to ensure that the small generator was shut down before the cogeneration system was reconnected to the grid.

#### Personnel Protection

All cogeneration facilities must be designed so that there is not the possibility of connecting any operating generators to the grid when it is down. If such a connection is made, utility employees working on the system would be placed in a life threatening situation. Likewise, if a presumably dead in-plant system is suddenly energized, plant workers would be in danger. To provide maximum safety, all reconnections should require manual intervention and be equipped with warnings and safety interlocks.

#### Metering

When the biomass fueled cogeneration system is operated so that power is both received from and supplied to the utility, a method of metering in both directions is needed. This is most easily accomplished with the use of two meters in series, each ratcheted to

turn in only one direction. During normal operation, in-house generated power would flow directly to the plant load, supplemented by utility power which would be recorded by the "in" meter. When excess power is available, it will flow to the grid and be recorded by the "out" meter. In the case where all power generated is sold to the utility, and all power needed is bought from the utility, two separate lines, each with its own meter, are required. Another option is to size and operate the cogeneration system so that no excess electricity is produced beyond in-house requirements, thus avoiding the issue of sale back to utilities.

In a "buy all, sell all" mode of operation (illustrated in Figure 7-1), two utility lines are needed. One will supply power to the utility from the cogeneration facility and one will be used to provide purchased power to the plant load. In this case, each line would require individual metering and the line sending power to the grid would require the protections discussed in previous cases.

Electrical block diagrams which show the electrical interface elements of stylized cogeneration systems are shown in Figures 7-1 and 7-2.

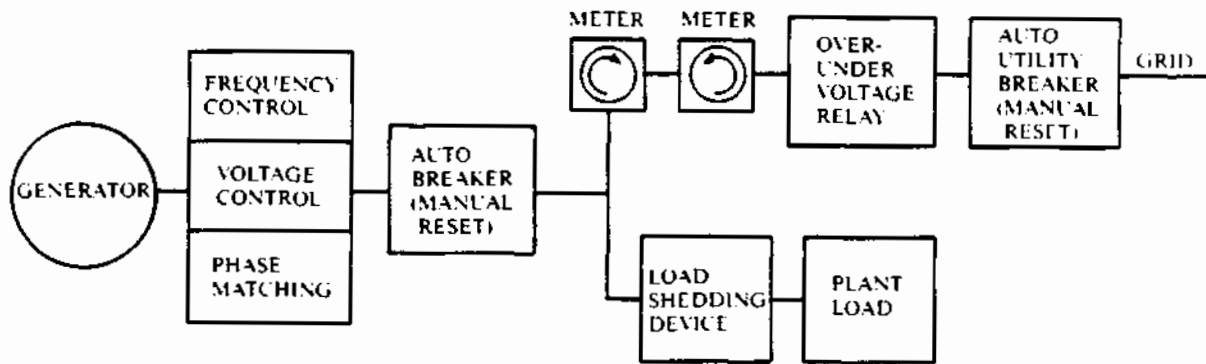

**Figure 7-1**  
**COGENERATION SYSTEM ELECTRICAL DIAGRAM:**  
**USE AND SELL POWER**

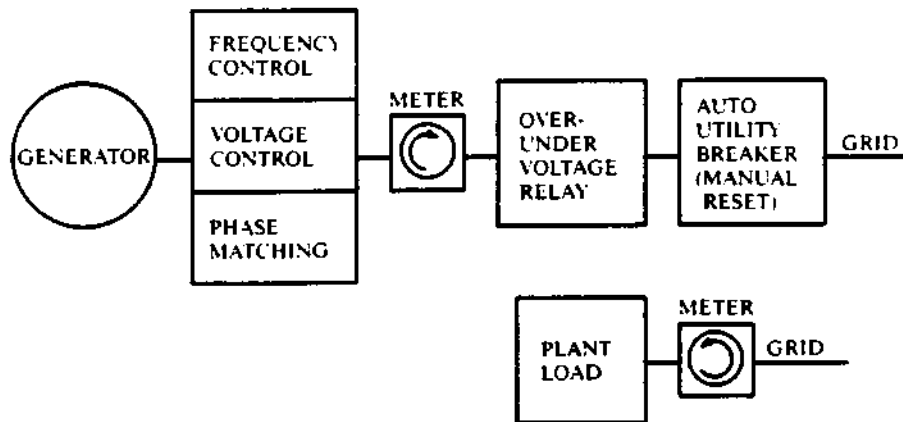

**Figure 7-2**  
**COGENERATION SYSTEM ELECTRICAL DIAGRAM:**  
**SELL ALL POWER**

#### PURPA

As part of the National Energy Act of 1978, the Public Utility Regulatory Policies Act (PURPA) was established to provide benefits and incentives for cogeneration facilities. This Act was designed to remove the regulatory obstacles that made small facility cogeneration uneconomical. Small-scale electrical power producers fueled by biomass can qualify to sell power to utilities under the legislation. The legislation also requires that state regulatory agencies establish cogeneration rules governing interconnection of cogenerators and electric utility systems, and set rates at which power exchanges may occur. To meet the criteria for benefits under PURPA, biomass fueled cogeneration facilities must produce electricity and other forms of useful energy (steam, heat, hot water, etc.) for industrial or commercial heating or cooling through sequential use of the fuel-supplied energy. In addition, PURPA stipulates that at least 50 percent of the facility must be owned by an organization that is not a utility or utility holding company. Any facility that wishes to take advantage of the PURPA benefits must be certified to be in compliance with PURPA requirements. Certification is handled by the Federal Energy Regulatory Commission (FERC) and may be carried out by writing to the Commission at: 825 North Capitol Street, N.E., Washington, D.C. 20426. PURPA leaves the choice of regulation methods and rules to the individual states. Detailed information on the regulations in any particular state can be obtained from the state public utilities commission, corporation commission or public service commission.

## Utility Requirements

Under the PURPA regulations, utilities are required to:

- o Interconnect with cogenerating facilities and small power producers. Utilities may not require extensive equipment redundancy to ensure reliability of electrical service. Access to a market for cogenerated power must be assured.
- o Purchase electrical power from small-scale producers at "just, reasonable, and nondiscriminatory" rates. Utilities must pay up to their "avoided costs" for purchase of electricity from cogenerators.
- o Provide backup power to the cogenerator at "reasonable" rates. Utilities cannot discriminate against cogenerators who require backup power on an intermittent basis.

## Rate Determination

PURPA requires that state energy agencies set rates for utilities to purchase power from cogenerators. The concept of "avoided costs" has been advanced to ensure that the rates are set fairly. These avoided costs are the marginal costs the utility would have incurred had it generated the electricity itself or purchased it from another utility. Not only must the utility purchase all the power available from a qualifying cogenerator but, where utility capacity needs are reduced, the cogenerator must also be given a credit for the cost savings resulting from this reduction in utility capacity requirements as part of the purchase price. Thus, the rates paid by utilities for cogenerated power must include both an energy component and a capacity component. Generally, each utility in a state will have its own different buy-back rates for cogenerators.

- o Energy Component: This component is often based on the utility's fuel cost. Incremental fuel costs are averaged over the preceding quarter and the resultant savings, modified by time-of-day differentials (the utility will pay more for power during peak load periods than during off-peak periods), makes up the rate to be paid to the cogenerator.
- o Capacity Component: Capacity price offers depend upon the size of the cogenerator and its commitment to provide a specified amount of capacity to the utility on a continuing basis. For cogenerators providing over 100 kW to the utility, price offers for the capacity component are calculated on the basis of dollars per kilowatt per year. For cogenerators providing less than 100 kW, the capacity price offer is usually based on the monthly capacity factor (the monthly generation in kWh divided by the maximum possible monthly generation) and is paid in terms of dollars per kilowatt per month.

## CHAPTER 8: ENVIRONMENTAL REGULATIONS AND ISSUES

### INTRODUCTION

There are a number of environmental issues which should be considered when evaluating the installation of a biomass fueled cogeneration system. These issues include environmental regulations, types of pollutants, environmental impacts of the various prime movers and fuels, and current emission control technology. In addition, a number of environmental issues are a concern in the collection and supply of biomass fuels. If fuel collection is to be carried out in conjunction with operation of the cogeneration facility, these issues must be addressed. However, most operators of biomass fueled cogeneration facilities use their own biomass waste products or purchase their fuel and, while aware of the fuel production regulations, leave it up to the fuel suppliers to be in compliance. Thus, this chapter deals primarily with environmental issues directly connected with the conversion of biomass fuels to energy for cogeneration. Questions to be answered include:

- o What are the most common types of pollutants emitted by biomass fueled cogeneration facilities?
- o How is pollution control implemented and how do control devices work?
- o What environmental regulations and permitting requirements are applicable to a biomass fueled cogeneration facility?

### ENVIRONMENTAL IMPACTS OF BIO-FUELED COGENERATION FACILITIES

#### Direct Combustion

The environmental impact recognized as having the most immediate, visible, potentially harmful and regulated impact, is air pollution resulting from the combustion of biomass feedstocks. Specifically, these feedstocks include wood, agricultural residues, and refuse-derived fuels (RDF). The amount and type of air emissions depends upon a number of variables, including fuel combustion, furnace design, fuel feed rates and the air/fuel ratio during operation.

If the fuel used is wood or agricultural residues, the pollutants of primary concern are carbon monoxide (CO) and particulates. Nitrogen oxide (NO<sub>x</sub>) emissions are less of a concern than with conventional fossil fuels. When RDF is burned, there are concerns regarding other emissions which will be discussed later in this section.

Small-scale, poorly controlled, and thus, less efficient burning of biomass (such as in residential woodstoves) increases the emissions of CO and unburned hydrocarbons, including polycyclic organic matter

(POM). Some POM compounds are toxic, carcinogenic and/or mutagenic. Larger, industrial and utility burners, in which a more complete burn typically occurs, produce substantially lower emissions, although particulates and POM can still be a concern. However, efficient pollution control devices (e.g., electrostatic precipitators) are economically available for larger units located in "non-attainment" areas. In other areas, cyclone separators are all that is required to meet air quality standards.

A significant advantage of bio-feedstocks is their low sulfur content (especially compared to coal), which results in less sulfur oxide ( $SO_x$ ) emissions than occurs with fossil fuel burning. Nitrogen oxide ( $NO_x$ ) and  $SO_x$  emissions from coal burning plants can be economically reduced by co-firing coal with refuse-derived fuels, agricultural or forestry residues (although hydrocarbons and CO may again be a concern due to the lower combustion temperatures). One exception to the low sulfur advantage of biomass is the combustion of spent black liquors in the pulp and paper industry resulting from sulfite processing. Boilers using these feedstocks require wet or dry scrubbers for  $SO_x$  removal under federal regulations. Table 8-1 contains a comparison of the emissions of wood-fueled combustion systems to those using other common fuels.

**Table 8-1**  
**EMISSIONS FROM UNCONTROLLED INDUSTRIAL BURNERS**  
(Pounds of pollutant per million Btu)

FUEL	PARTICULATES	CO	NO <sub>x</sub>	SO <sub>2</sub>
Natural Gas	0.006	0.04	0.62	0.0007
Fuel Oil	0.013	0.03	0.13	0.29
Coal	4.7	0.18	0.51	2.12
Wood	0.88-4.7	0.04-4.7	0.28	0.02-0.04

At a macro level, biomass combustion may be beneficial since it does not increase the long-term atmospheric concentration of carbon dioxide, an issue which is receiving increasing attention with the combustion of fossil fuels. This is because the  $CO_2$  released from biomass combustion is non-fossil  $CO_2$  that would eventually cycle to the atmosphere naturally, whether or not it is burned.

Soil and water resources also can be adversely affected by the ash and residues removed from pollution control devices. This material requires disposal, most often by landfilling, with potential subsequent leaching of contaminants to ground and surface water. The average ash yield (by weight) for wood is typically one-half or less than that of coal, and wood ash is more environmentally benign than coal ash. Wood ash also contains fewer heavy metals and is less toxic than coal ash.

The burning of RDF has several potential impacts inherently different from those of other bio-energy feedstocks. Emission of dioxins and furans, which are carcinogenic and extremely toxic, is the main area of current concern. However, at present, EPA believes these emissions do not pose a significant health risk due to the extremely minute quantities (parts per trillion) found in fly ash. Another area of concern is that the fly ash can sometimes absorb other micropollutants such as trace heavy metals (Cd, Pb, Be, Hg) along with airborne micropollutants which escape pollution control devices.

Although attempts at siting energy-from-municipal-waste facilities are often faced with the public sentiment of "not-in-my-backyard," they offer a potential solution to two needs; satisfying energy demands and reducing landfill requirements. Finding suitable space for landfills is becoming an increasing problem. Further, landfills can threaten ground and surface water supplies.

### Gasification

Gasification, another thermochemical bioconversion process, produces far fewer emissions of CO, hydrocarbons and particulates, than direct-fired wood boilers. However, potential pollutants include NO<sub>x</sub>, SO<sub>x</sub>, fly ash and trace metals absorbed on the ash or present in gaseous form. The hazardous nature of such toxic gases at small, on-farm facilities can be a concern. However, when product gas is burned or upgraded, most toxics are eliminated or reduced. Wastewater from gasifiers may be contaminated with NH<sub>3</sub>, HCl, and phenols as well as trace elements. The tars produced may be carcinogenic, although further research is necessary to confirm this potential. Nonetheless, from an overall perspective, biomass gasification does not present any problems which are new or unfamiliar, or any difficulties which are unprecedented or unexpected.

### Anaerobic Digestion

Anaerobic digestion is actually an adaptation of a pollution control process since the process converts animal manure, sewage and food processing wastes to more benign, stable, odor-free sludges as gaseous fuel is produced. A major, potentially beneficial impact from anaerobic digestion is reduced runoff from agricultural feedlots. Such runoff is extremely high in bacteria, dissolved solids, and suspended solids, including organic matter, which when decomposed can lower oxygen levels in water bodies.

On the other hand, anaerobic digesters require large quantities of water which can pollute surface and groundwaters when the wastewater is discharged in an uncontrolled manner. Water contamination can also result from runoff from manure/sludge storage piles.

Solid residue from digesters contains significant quantities of protein and nutrients and can be used as fertilizer, soil conditioner

or as a supplement to animal feed if it is determined to contain safe levels of contaminants such as viruses and enteric bacteria.

Finally, the air pollution associated with an anaerobic digester results not from combustion of the product gas, but from leaks of raw gas from the system. Exposures to 500 ppm  $H_2S$  can lead to unconsciousness and death within an hour, and 100 ppm can cause respiratory problems.  $H_2S$  is also very corrosive. Further, if methane ( $CH_4$ ) is allowed to mix with air, it can become explosive.

## EMISSION CONTROL DEVICES

There are four main categories of devices used for control of particulate emissions from stack gases. These categories are cyclones, scrubbers, baghouses, and electrostatic precipitators.

### Cyclones

The most common and least expensive of particulate control devices is the cyclone separator. This device swirls the gases and reverses the flow direction. Particulate matter is separated by centrifugal force as the heavy particles cannot follow the sudden change in direction of the gas stream and are precipitated out. A number of cyclones can be operated in a series to remove the finest particles. The efficiency of separation in a cyclone increases as the diameter and the flow rate increase. Figure 8-1 illustrates a typical multiple cyclone installation.

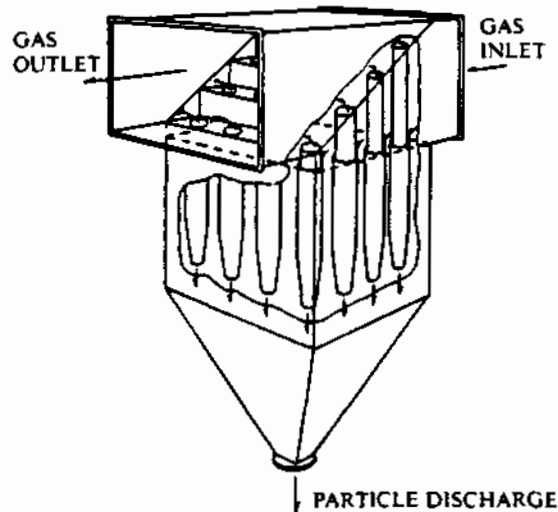

Figure 8-1  
MULTIPLE CYCLONE



## Scrubbers

Wet scrubbers remove particulate matter by spraying a fine mist of water into the exhaust stack. They are effective in removing the ultra-fine particles that escape from a cyclone. They can also easily follow load changes without losing efficiency since their particulate removal action does not depend on gas flow. Wet scrubbers do produce a liquid waste stream which must be treated. This adds extra expense to the system and requires extra space as well. While wet scrubbers are the most effective particulate control devices, extra expense and complexity of operation should preclude their use unless other methods of cleaning the flue gas are not environmentally acceptable. Dry scrubbers have been developed to overcome some of the negative features of wet scrubbers. A dry scrubber filters with a slow-moving bed of gravel. As the flue gas comes into contact with the gravel, particles stick to the bed and are removed. Filter plugging is avoided by the continuous movement of the bed. The dry filter can operate over a wide range of gas flows and is tolerant of temperature swings during start up. Figure 8-2 illustrates a dry scrubber. Wet and dry scrubbers are also effective for removing acid gases ( $\text{SO}_x$ ,  $\text{HCl}$ ,  $\text{HF}$ ) from stack gases if a basic chemical such as calcium oxide ( $\text{CaO}$ ) is added to the scrubber process to neutralize the acids.

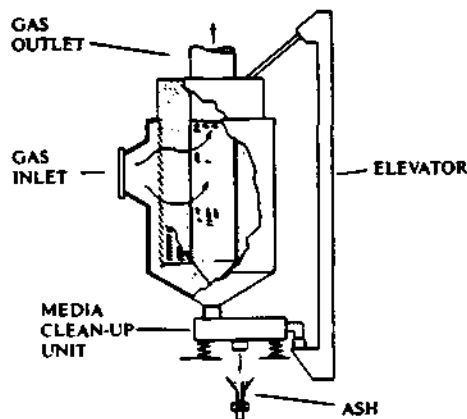

Figure 8-2  
DRY SCRUBBER

## Baghouses

A baghouse filter consists of a number of fabric bags which trap particulates in the same manner as a home vacuum cleaner bag. Baghouses are very efficient at removing fine particulates. Particulates are removed from the bag by shakers or scrapers. A drawback to baghouses is that they are susceptible to fires and explosions caused by hot particulates. (A baghouse should never be installed on a solid-fuel system without a cyclone ahead of it to remove these hot sparks.) They also have a limited lifetime. Maintenance costs and downtime to replace filter bags are high. A baghouse is illustrated in Figure 8-3.

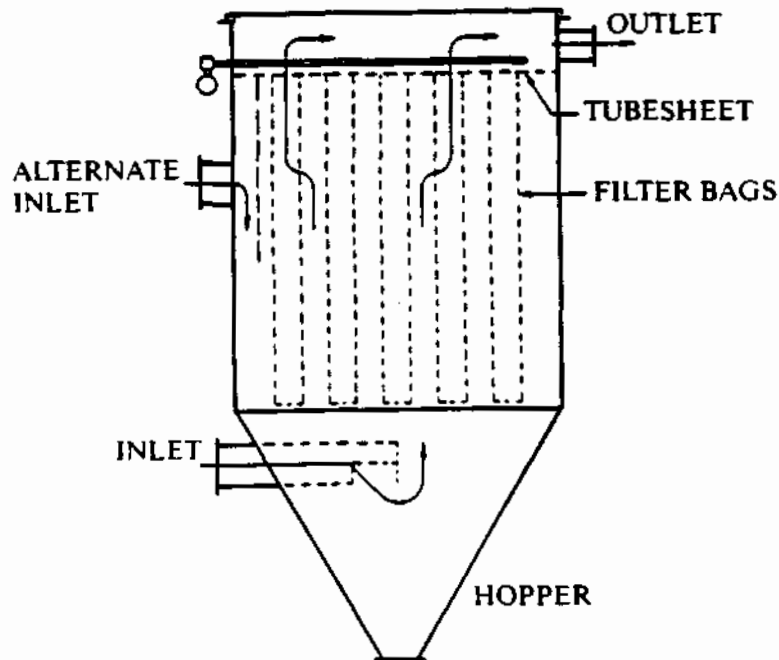

Figure 8-3  
BAGHOUSE

### Electrostatic Precipitators

Electrostatic precipitators take advantage of the attraction of oppositely charged particles to remove particulate matter from flue gases. As gases enter the precipitator, the particles are negatively charged from a suspended electrode. The gases are then passed by a positively charged plate. Particles are attracted to the plate and stick to it, and are then removed by shakers or scrapers. An electrostatic precipitator is illustrated in Figure 8-4. It should be noted that TVA and others have found that biomass ash generally does not take a good charge, thus electrostatic precipitators would not be the method to choose for exhaust gas clean up from a biomass-fired system.

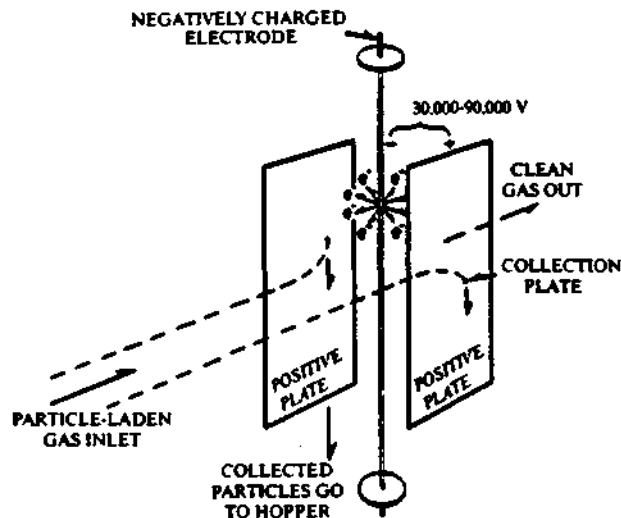

Figure 8-4  
ELECTROSTATIC PRECIPITATOR

The advantages and disadvantages of various devices used to remove particulate matter from flue gases are outlined in Table 8-2.

Table 8-2  
COMPARISON OF PARTICULATE REMOVAL DEVICES

TYPE	COST	ADVANTAGE	DISADVANTAGE
Cyclones	low cost	simple design. minimal space	subject to erosion. increased power requirement. low collection efficiency for small particles
Wet Scrubbers	medium cost	minimal space. insensitive to moisture and temperature	high opacity. liquid waste disposal. nozzle plugging
Dry Scrubbers	medium cost	insensitive to fluctuating operating conditions. tolerant of sparks	subject to plugging. dust disposal problems
Baghouses	high cost	high efficiency independent of particle size. high reliability. modular construction	limited temperatures. high maintenance. safety problems
Electrostatic Precipitators	high cost	high efficiency. low moisture. adaptable to modification	sensitive to changes in dust. low efficiency in submicron range. subject to corrosion

Source: *Industrial/Commercial Wind Energy Conversion* (1986)

## PERTINENT ENVIRONMENTAL REGULATIONS

The storage and handling of biomass fuels is not normally environmentally regulated except for the water runoff from outdoor storage piles. However, combustion products (both airborne and solid) are of concern to the EPA. The major EPA documents relevant to a biomass fueled cogeneration facility are:

- o National Ambient Air Quality Standards (NAAQS)
- o Prevention of Significant Deterioration, Clean Air Act (PSD)
- o Solid Waste Management Act

NAAQS covers six pollutants and identifies the thresholds at which damage to human health or plant and animal life are thought to occur. Of these six, only one, hydrocarbon emission, is not directly related to biomass fueled cogeneration plants. Pollutants which are regulated are:

- o sulfur dioxide (SO<sub>2</sub>)
- o ozone (O<sub>3</sub>)
- o carbon monoxide (CO)
- o particulates
- o nitrogen oxides (NO<sub>x</sub>)

PSD regulations have a considerable impact on the burning of biomass fuels. These regulations limit the amount that the ambient air quality may be decreased for particulates and SO<sub>2</sub>. Major pollution emitting facilities are required to have a PSD permit before construction can begin. This permit certifies that all PSD emission requirements will be met by the facility, and that all required hearings and reviews have been held. In addition, this permit states that the best available control technology for each pollutant will be used and that proper air quality monitoring will take place. There are exemptions for certain facilities that emit relatively small amounts of specified pollutants.

Solid waste from wood combustion (ash) is considered less detrimental than solid residues of coal combustion. There are few if any toxic substances in wood ash. Such ash is, however, considered solid waste and must be disposed of according to EPA regulations. A facility may operate its own solid waste disposal site or may contract for such disposal. The primary focus of the regulations is on the effect of ash disposal on water quality and wildlife.

Runoff from biomass storage piles is considered a possible source of contamination for water supplies. Contamination can generally be avoided by providing a sloped storage pad so that water will run off immediately and not collect and dissolve water soluble compounds in the fuel (organic acids can be created if the biomass is left standing in water for a long period of time).

Special mention must be made of regulations governing the use of manure in anaerobic digestion. The usual practice of manure disposal (when energy production is not considered) is to either store it in a lagoon or spread it on the fields. Increasing concern about water pollution has resulted in the limiting of manure spreading. The use of an anaerobic digester to "treat" the manure is one environmentally sound way of solving the waste disposal problem. The effluent from the digester is reduced both in odor and in organic material, but is still rich in inorganic nutrients (phosphorus, nitrogen, etc.). It can be spread on the fields as fertilizer. Thus, cogeneration using anaerobic digestion of manure to produce energy can increase the degree of compliance with EPA regulations.

### State Regulations

The intent of the Clean Air Act is for states to assume primary responsibility for carrying out the PSD program. States have developed legally enforceable state implementation plans (SIP) describing the strategies which will be pursued to maintain NAAQS. Some states are satisfied with enforcing the federal regulations while others include provisions stricter than those outlined by the federal government. In planning a biomass fueled cogeneration facility, close contact should be maintained with the state agencies to ensure full compliance with all facets of the SIP. A list of state agencies for the 13-state region is found in Appendix B. In addition to regulatory agencies, many states have biomass energy contacts which can help with the process of applying for both state and federal permits. These state biomass energy contacts are listed in Appendix A.

An outline of preconstruction review procedures that is designed to lead the planner through the steps which must be followed to obtain needed state and federal permits is presented in Figure 8-5.

STEP 1 COLLECT SIZE, LOCATION  
AND FUEL INFORMATION  
AND CONTACT THE EPA

STEP 2 VERIFY STEPS REQUIRED  
AND OBTAIN EPA  
RECOMMENDATIONS  
ON BEST AVAILABLE  
CONTROL TECHNOLOGY

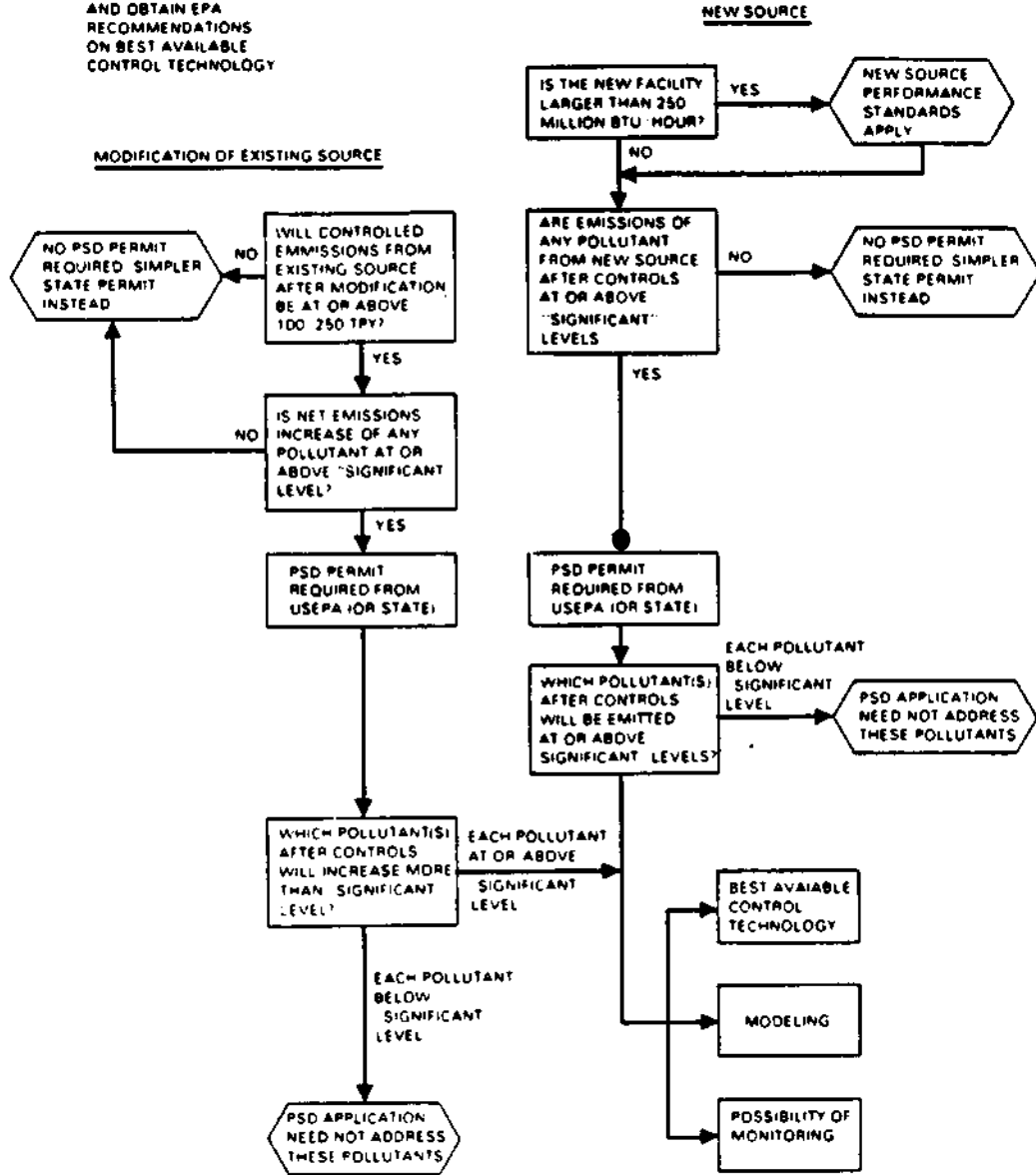

Figure 8-5

OUTLINE OF PRECONSTRUCTION REVIEW OF MAJOR  
POLLUTION CONTROL REGULATIONS

Source: Cogeneration Handbook for the Pulp and Paper Industry (2/84)

## Federal Regulations

Although the state environmental agencies are the primary ones to contact in determining the required pollution control equipment and regulatory steps necessary to gain approval for a biomass fueled cogeneration facility, in rare instances you may also want to contact the Environmental Protection Agency (EPA) regional office responsible for the area in which the cogeneration facility is to be built. For the 13 southeastern states, the regional offices of interest are listed in Table 8-3.

**TABLE 8-3  
ENVIRONMENTAL PROTECTION AGENCY REGIONAL OFFICES**

STATES	OFFICE
Delaware, D.C., Maryland, Pennsylvania, Virginia, West Virginia	Curtis Building Sixth and Walnut Streets Philadelphia, PA 19106 (215) 597-8175
Alabama, Florida, Georgia, Mississippi, Kentucky, North Carolina, South Carolina, Tennessee	345 Courtland, NE Atlanta, GA 30308 (404) 881-3043
Arkansas, Louisiana, New Mexico, Oklahoma, Texas	First International Bldg. 1201 Elm Street Dallas, TX 75270 (214) 767-2745

For additional information on environmental regulations in the Southeastern states, refer to the publications Permits-Regulations for Biomass Energy Facilities in the Southeast, 1986, by R. DeZeeuw and R. Gay. The publication was sponsored by, and is available through, the Southeastern Regional Biomass Energy Program, managed by TVA (see Appendix A for the address and phone number).





## CHAPTER 9: FINANCIAL AND ECONOMIC EVALUATION

### INTRODUCTION

Establishing the performance of a biomass fueled cogeneration system is an essential first step toward determining the most cost effective system. However, choosing the best cogeneration system for a given situation depends upon financial and economic considerations.

An economic analysis is needed for two reasons. It must be determined whether biomass fueled cogeneration is worth undertaking, and which combination of fuel, equipment configuration, and operating strategy is best for a given situation. Questions to be answered include:

- o How are the economics of biomass cogeneration assessed?
- o How are system capital costs determined?
- o How are installation costs determined?
- o What are the operation and maintenance costs?
- o What revenues can be expected?
- o What financing strategies should be considered?

### ASSESSING SYSTEM ECONOMICS

Organizations typically have their own established procedures for determining whether to invest in a project -- usually payback or rate-of-return from an investment. To evaluate the economic merit of investing in a biomass cogeneration system, a cash flow analysis should be done comparing the difference in costs with and without cogeneration.

There are two possible sources of revenue (or savings) from cogeneration. The first is from potentially lower fuel cost for meeting thermal demands -- for example, from lower fuel costs for biomass. The second source of potential revenue (or savings) is from sale of electricity to a utility, or internal use of cogenerated electricity produced more efficiently and at a lower cost than electricity from the local utility. Table 9-1 provides a sample form for assessing cogeneration project cash flows. Costs or revenues recorded in the table would be the difference between costs with and without cogeneration (i.e., cogeneration project costs minus costs for a conventional or existing system without cogeneration). Fuel "costs" and electricity "costs" in the table would have a negative sign if savings occur with biomass cogeneration. Depreciation and tax credits would also have a negative sign since they represent reductions in costs with cogeneration.



hydraulic truck dumpers, by front-end loaders, or by specialized unloading equipment such as scoop conveyors. The costs of several unloading systems are shown in Table 9-2.

**Table 9-2**  
**COSTS OF UNLOADING EQUIPMENT**

	Front-End Loaders	Truck Dumpers	Scoop Conveyor
Costs	\$16,000-32,000	\$26,000-105,000	\$80,000-100,000

Storage of biomass fuels can result in large capital expenditures. In most cases, a 10 to 30 day fuel storage capacity is necessary to ensure uninterrupted supply to the cogeneration facility. In the case of green wood chip storage for a 50,000 lb/hr steam boiler, a pile approximately 20 feet high by 1/2 acre should provide a 15 day supply. Fuel of this type would normally be stored in a paved open area. If dried fuels are used, then covered storage must be provided. This type of storage is considerably more expensive than open storage. Storage in silos is the most expensive method of storage. The capital costs for several storage options are listed in Table 9-3.

**Table 9-3**  
**COSTS OF BIOMASS FUEL STORAGE**

	OPEN ON-SLAB (per sq. ft.)	OPEN SHED (per sq. ft.)	CLOSED SHED (per sq. ft.)	SILO (per cu. ft.)
Cost	\$1.00-1.60	\$6.90-9.60	\$8.75-12.25	\$2.80-8.70

A number of different devices can be used to transport fuel to and from storage and to the fuel preparation equipment or the combustor. While smaller biomass cogeneration systems may use front-end loaders for all transportation of fuel, larger or more automated systems use various types of conveyors. The approximate installed costs of a number of conveying systems are shown in Table 9-4.

Table 9-4  
**COSTS OF MECHANICAL CONVEYORS**

CAPACITY (tons/hr)	BELT SCREW CONVEYOR (dollars/ft)	CHAIN CONVEYOR (dollars/ft)	BUCKET CONVEYOR (dollars/ft)	CONVEYOR (dollars/ft)
8	200	220	150	--
50	--	240	150	160

Fuel Preparation

To obtain uniform size particles for the biomass fuel cogeneration system, the fuel must often be screened and reduced to proper size. However, these steps can be avoided if fuel of uniform size is purchased. In this case, the cost of sizing and screening would be included in the fuel price and no capital investment on the part of the cogeneration facility builders would be needed. Size reduction is accomplished with a "hog" that either chips or beats the fuel into smaller particles. If baled agricultural wastes are the fuel source, the extra costs of bale breakers must be added. Several different types of screening devices are available which will separate the fuel particles according to size. The costs of a number of biofuel preparation devices are listed in Table 9-5.

Table 9-5  
**COSTS OF FUEL PREPARATION EQUIPMENT**

	Hog or Hammermill	Disc Screen	Shaker Screen
Cost	\$10,500-42,000	\$21,000 + 74,000	\$8,900-52,000

Biochemical Gasification

The assessment of capital costs for the anaerobic digestion of manure has some unique considerations relative to other biomass conversion systems. Manure is used at the point of origin and the

capital costs are often hidden, since the equipment needed to collect and handle manure (scrapers, holding tanks, pumps, etc.) would be needed even if an energy system were not installed. Data are available on the capital cost per cow of constructing a dairy operation both with and without an anaerobic digester. The capital investment for a dairy operation can total as much as \$2500 per cow (1976 dollars). The total capital cost of an anaerobic digester for a 100-cow dairy varies from \$200 to \$500 per cow, and includes the cost of all extra equipment for manure handling and the digester. This is less than 20 percent of the investment for the dairy farm operation and the additional investment may produce a return both in the form of energy and in the form of avoided costs for environmental treatment of the manure waste product.

### Conversion Equipment

The cost of packaged biomass boilers is approximately 4 or 5 times as much as natural gas or oil boilers. Considering the cost of fuel handling, biomass boiler systems, are approximately 9 times more expensive than oil or gas boilers. An investment in biomass boilers is justified when biomass fuel costs are sufficiently lower than gas or oil to achieve an acceptable payback. Fluidized bed gasifiers tend to cost a little more per unit of capacity than conventional pile boilers, but their higher combustion efficiency allows capital cost savings because smaller boilers can be used for a given output. Gasifiers can be substantially less expensive than biomass boilers where the gasifier is retrofited to an existing natural gas or oil boiler. (As noted in Chapter 5, though, there is some need for caution in that there is a lack of long term operational experience with gasifiers, and tars and other liquids in the producer gas are a concern regarding their use with engine generators or combustion turbines).

Figure 9-1 indicates approximate capital costs versus system capacity for the various combustion technologies, including fuel handling costs. Note that biomass boiler systems are somewhat more expensive per unit of output than coal boiler systems, due to the fact that biomass is a more bulky fuel (i.e., has less energy density) than coal. However, it is also important to note that the coal system costs shown in Figure 9-1 do not include costs for SO<sub>2</sub> scrubbing equipment, which can be substantial, particularly if high sulfur coal is used.

### Prime Movers

Prime movers used for biomass fueled cogeneration systems include steam turbines, gas turbines, and internal combustion engines. Steam turbines can be obtained as either condensing or noncondensing, depending on the way in which the steam and electrical loads are to be met, as discussed in Chapter 6. In general, condensing turbines are difficult to produce in smaller power ranges, and sizes below 5,000 kW are not normally available. Noncondensing turbines can be obtained in sizes as small as 500 kW, but unit cost for smaller sizes is greater.

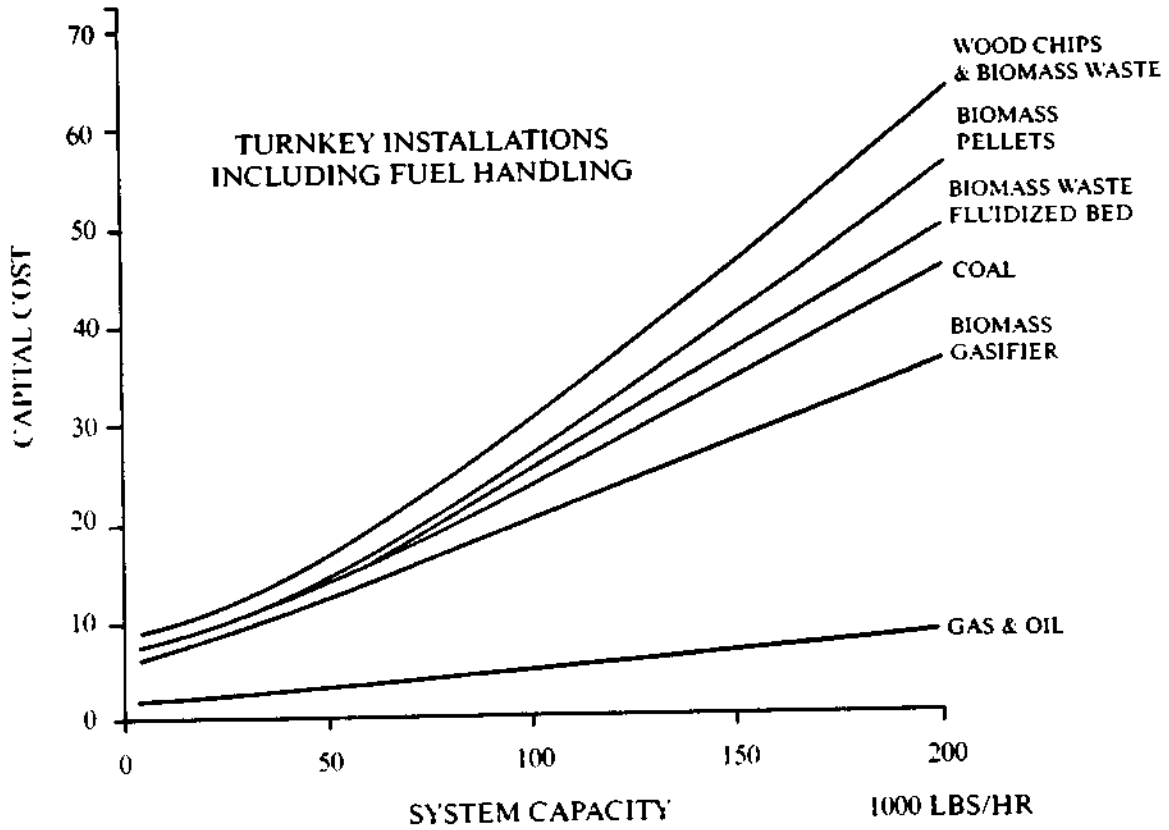

**Figure 9-1**  
**CAPITAL COST OF STEAM GENERATING SYSTEM (1986\$)**

Source: Adapted from the *Industrial Wood Energy Handbook* (1984)

Figure 9-2 indicates the approximate installed capital cost for condensing steam turbine generators versus their capacity in megawatts. (The costs in Figures 9-2, 9-3, and 9-4 include the baseplate, lube system, piping, switchgear and other auxiliary elements.)

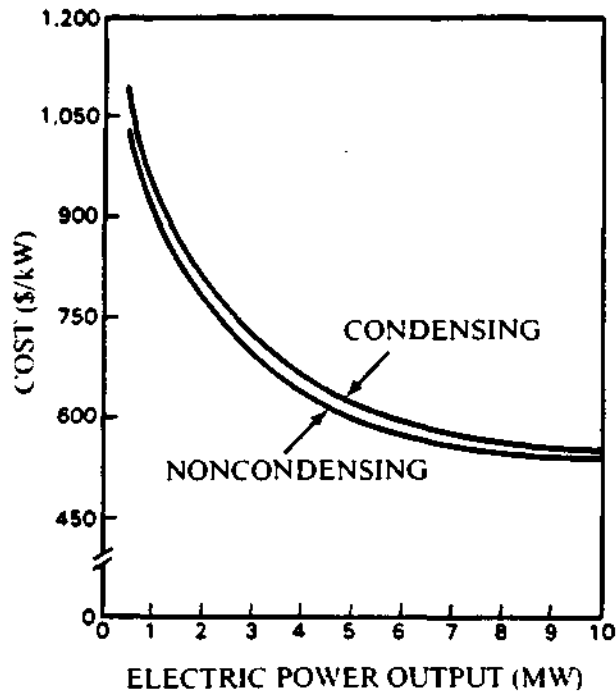

Figure 9-2

**ESTIMATED INSTALLED COSTS FOR CONDENSING AND NONCONDENSING STEAM TURBINE SYSTEMS**

Source: *Cogeneration Handbook for the Pulp and Paper Industry* (1984)

Gas combustion turbines suitable for cogeneration are available in sizes ranging from 800 to 75,000 kW. Figure 9-3 indicates the approximate installed capital cost for combustion turbine generator systems versus their capacity in megawatts.

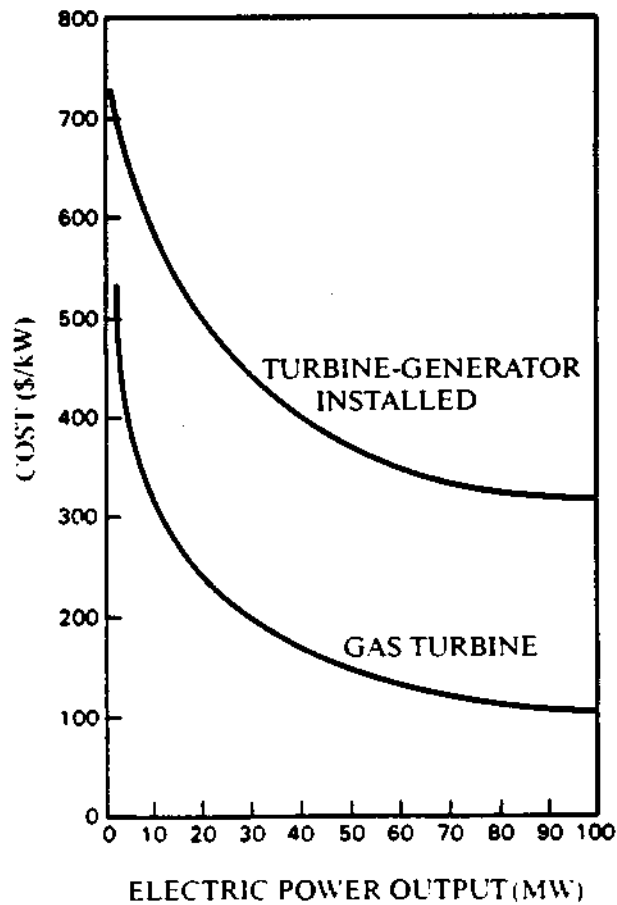
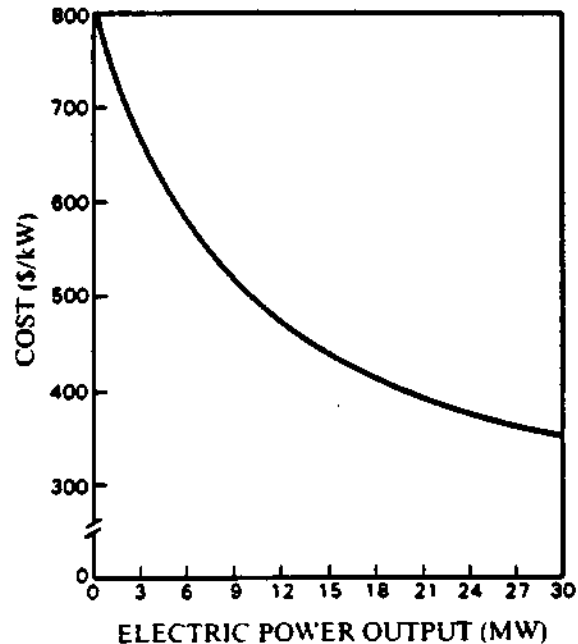

Figure 9-3  
**COMBUSTION TURBINE-GENERATOR  
 COST ESTIMATES -- INSTALLED**

Small internal combustion engines suitable for cogeneration are available from a number of manufacturers. Both spark-fired and diesel engines are available, and operation of these engines on gas mixtures similar to biogas from anaerobic digesters is well documented by the oilfield industry. Operation of internal combustion engines on producer gas from gasifiers has had mixed success. Figure 9-4 indicates typical installed costs for diesel generator equipment.





**Figure 9-4**  
**DIESEL GENERATOR TOTAL INSTALLED COSTS**

*Source: Cogeneration Handbook for the Pulp and Paper Industry (1984)*

#### RETROFIT OF EXISTING EQUIPMENT

Many firms are evaluating biomass cogeneration in terms of a retrofit to existing equipment. This practice significantly reduces the capital costs of biomass cogeneration, especially if there is excess or unused boiler capacity, and if the boiler was originally designed to produce superheated steam suitable for a turbine. Retrofitting existing equipment has not been found to significantly affect the reliability of the associated facilities. Because the retrofit of existing equipment will often take boilers out of service for an extended period of time, the opportunity costs of such a loss must be included in the overall economic evaluation.

#### SYSTEM INSTALLATION COSTS

The variable cost to install a biomass fueled cogeneration system is site-specific. If the system is installed in a newly constructed facility, the costs will be the same as those for construction of any process steam production facility. Standard construction methods can be used and the only extra installation costs may be for switch gear to interconnect the generator with the utility. If the cogeneration system is to be retrofitted into an existing facility, installation costs may include alterations or additions to buildings or existing equipment. The cost of on-site storage of fuel will be larger than for

conventionally fueled systems due to the low bulk density of the biomass fuels. In general, however, standard methods used to determine the cost of any industrial construction are fully applicable to the biomass fueled cogeneration system.

### FUEL COSTS

The cost of fuel is a dominant factor in the operating costs of a biomass fueled cogeneration system since the plant will burn more fuel to generate electricity than it would if only process steam were being produced. However, the incremental fuel cost for the electricity generated is considerably lower than the cost to generate electricity as the sole product. (Generation of electricity as the sole product using wood fuel requires approximately 16,000 Btu/kWh, while in a cogeneration configuration, the generation of electricity requires only about 6,000 Btu/kWh.) The additional cost of fuel above that required to generate steam must be balanced against the value of the electricity produced. Table 9-6 provides approximate unit costs for a number of biomass fuels.

Table 9-6  
COSTS OF BIOMASS FUELS

FUEL	COST (\$/Ton)	COST (\$/Million BTU)
Greenwood Chips	10-20	1.75-3.50
Dry Sawdust	10-15	.90-1.35
Wood Pellets	40-70	3.35-5.85
Corn Stover	30-35	2-2.35
RDF	22-35	1.90-3.00

### ELECTRICITY COSTS/REVENUES

To determine the electricity cost or revenue of a biomass cogeneration system, the three operating conditions discussed in Chapter 6 must be examined. If part of the plant load is supplied by cogeneration and additional power is purchased, the annual cost of electricity is determined by multiplying the electricity deficit (the amount that must be purchased) by the rate charged by the utility. It may be possible, by examining the daily profile of energy use and production, to operate the cogeneration facility in such a manner that power is purchased during off-peak hours at a lower rate.

In the case where excess power is available for sale to the utility, the operator may again take advantage of time-of-day pricing and operate the cogeneration facility to produce excess power during peak load times when the highest return is realized. In the case where the utility's avoided cost for new capacity exceeds the price to produce cogenerated power, it behooves the operator of the cogeneration facility to sell as much power generate as it can to the utility.

#### **O & M COSTS**

In addition to fuel and electricity costs, other operation and maintenance (O&M) costs, such as operating labor, annual routine maintenance, and overhead charges for administrative and support labor for a biomass cogeneration facility are similar to those for any other process steam production facility. Additional costs are to be expected for operation of more complex equipment and the expanded fuel handling system which biomass cogeneration requires. A rule-of-thumb for estimating O&M costs for biomass handling and conversion systems is to use 5 percent of the original capital cost per year. Costs for operating and maintaining the cogeneration portion of the biomass fueled facility are estimated at 2 to 2-1/2 percent per year of the capital costs for the prime mover and generator. Taxes and insurance are estimated at 2-1/2 percent of the capital cost per year.

#### **TYPICAL TOTAL SYSTEM COSTS**

The overall costs for three typical wood fired cogeneration systems are shown in Table 9-7.

#### **SYSTEM UTILIZATION**

The number of hours that the system is in operation has a significant impact on the economics of biomass cogeneration. Higher utilization means capital resources are being used more efficiently. In many studies, a system utilization rate of 70 percent is assumed to account for planned and unplanned system downtime. However, typical biomass cogeneration systems have achieved availability rates in excess of 95 percent. This increase may improve the overall economics of biomass cogeneration by as much as 5 percent. Other systems have experienced a lower utilization due to the seasonal variance of their fuel supply.



## FINANCIAL STRATEGIES

Because the ability to qualify for or effectively use tax incentives varies among potential cogeneration system owners, arrangements other than ordinary sales may sometimes improve the economics. Alternative arrangements may allow tax incentives to be effectively used by one party in the transaction, who then makes the cogeneration system available to the system user at a lower price.

The two essential parties to any financial transaction are the buyer and the seller. However, the transactions might also include "third parties" -- other institutions that intervene in transactions between the buyer and seller, as opposed to working through either one of them. A third party is somewhat like a wholesaler, who buys from the seller and then sells to the buyer.

This section describes alternative methods of financing biomass cogeneration projects, including ordinary sales, sales with borrowed financing, four types of leases, energy service contracts, and joint ventures. In many situations, alternative financing arrangements can significantly enhance the economics of cogeneration projects by providing a way to efficiently allocate elements of risk, return on investment, required capital investment, and tax benefits.

### Ordinary Sale

In an ordinary sale, the user would simply receive the cogeneration equipment from the manufacturer in exchange for the purchase price. An industrial plant will usually choose to own and operate its cogeneration equipment.

Another possible arrangement is for a third party to own and operate the cogeneration facility. The third party, an independent cogeneration company, will receive the tax benefits in return for designing, building, and operating the facility.

### Sale With Borrowed Financing

A sale with borrowed financing involves a bank as a third party. The user (industrial plant) takes out a bank loan to help finance the purchase of the cogeneration equipment from the manufacturer. The user then repays the loan with interest.

### Lease

A lease is a rental agreement in which the equipment user (lessee) promises to make a series of payments to the equipment owner (lessor). At the end of the lease term, the lessee has the option to purchase the equipment or take out a new lease. The owner obtains the tax benefits of ownership during the lease term and can pass these savings on to the lessee through lower payments.

Leasing provides various advantages to both parties. For the lessor, benefits include availability of accelerated depreciation to reduce tax liability, applicable energy tax credits, and the residual value of the equipment. For the lessee, advantages include 100 percent financing (no capital requirement); the possibility of lower payments than a bank loan would require, assuming that the value of tax benefits is passed on; and, because of off-balance-sheet financing, no direct decrease of the leaseholder's net worth.

Leasing offers particular tax advantages in cogeneration financing. In a typical arrangement, a corporate investor would buy the cogeneration equipment and lease it to the energy user. The user could realize significant savings if the tax credits available to the corporation (and not available to the user) were passed on to the investor through lower lease payments.

In the following subsections, several types of leases are described: ordinary lease, third-party lease, leveraged lease, and sale leaseback.

#### Ordinary Lease

In what is called an "ordinary lease," only two parties are involved, and the user would agree to make regular lease payments to the equipment manufacturer in return for use of the equipment. This type of leasing arrangement operating directly between the manufacturer and user is rare. Usually, a third party would be involved in the lease transaction.

#### Third-Party Lease

A third-party lease would involve the manufacturer, the user, and the owner (Figure 9-5). In this arrangement, the owner, most likely a corporate investor, would purchase the equipment from the manufacturer and lease it to the user in exchange for regular payments. The owner would receive tax benefits, which could be passed on to the user in the form of reduced lease payments.

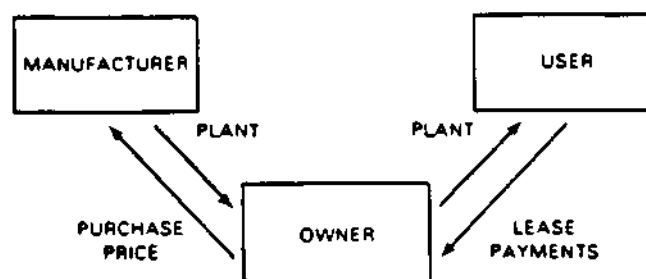

Figure 9-5  
THIRD-PARTY LEASE

## Leveraged Lease

In leveraged leasing, part of the cost of the leased equipment is financed through a loan secured by the equipment and the lease payments; the owner issues debt and equity claims against the equipment and the lease payments (Figure 9-6). The owner is the intermediary among all the parties involved and finances most of the capital needed to buy the equipment by obtaining a loan. The remaining capital is contributed by equity investors. After purchasing the equipment, the owner makes a lease agreement with the user and receives regular lease payments. The lenders have a security interest in the leasing contract. The lease payments received by the owner are used to repay the lenders. The amount remaining after repaying the loan and interest is distributed to the equity investors. Tax benefits received by the lessor are also passed on to the investors.

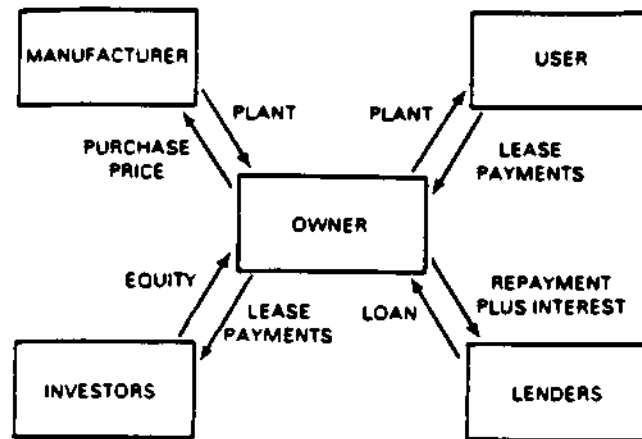

Figure 9-6  
LEVERAGED LEASE

Leveraged leasing offers tax advantages to the owner. The owner benefits from the tax shields created by the interest payments on the loan, as well as by accelerated depreciation. Although the owner has only a modest equity investment in the equipment, the total equipment cost can be depreciated.

## The Sale-Leaseback Method

Under the Economic Recovery Tax Act of 1981 (ERTA), companies that previously were unable to take advantage of investment tax credits may be allowed these benefits through sale-leaseback financing (sometimes called "safe-harbor leases"). In the sale-leaseback method, a company that does not benefit from tax credits sells equipment to a company that can benefit from such credits. The new equipment owner then leases the equipment back to the original owner under contract. The

equipment owner and user are then able to share in the tax benefits allowed the lessor.

There are three basic requirements involved in the sale-leaseback method: (1) the lessor must be a "regular corporation;" (2) the lessor's minimum investment in the leased equipment must not be less than 10 percent of the equipment's cost (25 percent for energy equipment); and (3) the term of the lease, including extensions, must not exceed 90 percent of the equipment's useful life for depreciation purposes or 150 percent of the present class life of the equipment. An additional requirement is that the lessor must buy the equipment within three months of the lessee's original purchase.

A sale-leaseback arrangement for cogeneration financing involves two basic steps (Figure 9-7). In the first step, an industrial plant would buy and assemble the necessary equipment. A corporation with extensive capital but needing tax deductions buys the equipment from the industrial plant. The seller receives a fraction of the entire equipment cost (not less than 25 percent) in the form of a down payment. In the second step, the corporation leases the equipment back to the seller (industrial plant). The transaction is arranged so that the remaining purchase payments are exactly offset by the lease payments. Thus, no additional cash is exchanged between the two parties. Following the leaseback transaction, the industrial plant is able to use the equipment. Meanwhile, the corporation benefits from the tax credits. When the term of the lease is up the industrial plant can choose to repurchase the equipment for as little as one dollar.

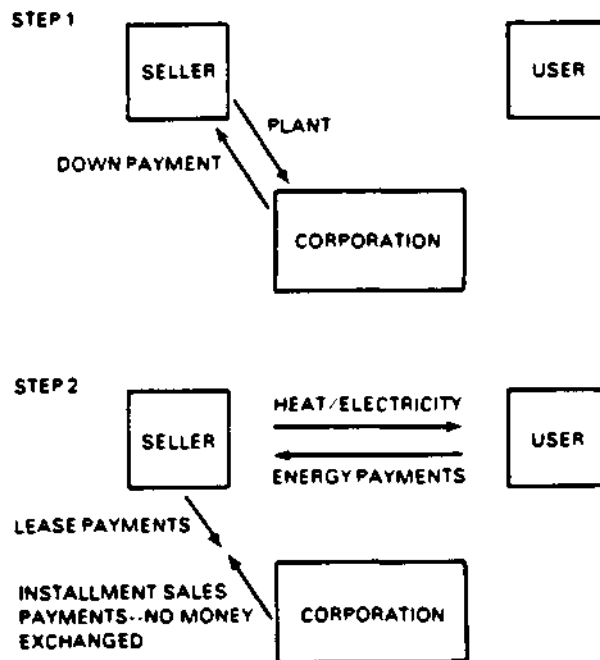

Figure 9-7  
SALE-LEASEBACK ("SAFE-HARBOR" LEASE)



This type of package provides advantages to both the seller and the corporation. The net cost of the equipment to the seller is reduced by the amount that the corporation paid the seller for the tax benefit. The corporation receives a tax write-off because the lease payments are equal to the debt payments, and because the depreciated equipment may be sold back to the original seller for less than the fair market value, realizing no capital gain. Furthermore, the corporation has a relatively small amount of money at risk and eventually recovers this sum. The original seller has accepted most of the risk in the investment.

### Energy Services Contract

The energy services contracts is another form of third party financing. Under this contractual arrangement a developer agrees to finance, own and operate a cogeneration facility selling power and/or heat to an end user. Users generally have an obligation to purchase a contractually specified quantity of power and heat, if available, from the cogeneration system. The provisions of the Wallop Amendment as described below must be satisfied if the contract is to be classified as an energy services contract.

The Deficit Reduction Act of 1984 contains a special rule, the "Wallop Amendment," which provides a detailed list of statutory criteria which an energy sale contract must satisfy in order to qualify as a service contract. The effect of these criteria is to establish specific measures which will facilitate third party cogeneration by removing uncertainty regarding the system's tax status. The amendment applies to contracts for the sale of electrical or thermal energy produced by a cogeneration system.

The Wallop Amendment classifies an energy sale contract as a service contract if it satisfies four specific requirements. First, the service recipient cannot operate the facility. The second requirement is that the end user cannot incur any significant financial burden if there is nonperformance. Accordingly, contracts with minimum payment clauses will not qualify as service contracts. The third requirement is that the end user cannot receive a significant financial benefit if the operating costs of the facility are less than those contemplated in the contract. The final requirement is that the energy customer does not have an option or an obligation to purchase all or part of the project at a price other than the fair market value. Under this provision, discount purchase options and fixed price options at any price may not be included in a power sale contract.

### Joint- Venture Financing

Joint-venture financing is an option that offers the benefits of combining the skills and experience of different organizations through cooperative agreements. The range of possible partners in joint-

venture financing is virtually limitless. However, some likely participants include municipal or investor-owned utilities, leasing corporations, banks, equity firms, individual investors, engineering firms, energy management companies, equipment manufacturers, equipment vendors, local government entities, nonprofit organizations, and private nonprofit foundations. Financing mechanisms that may not be possible or conceivable using traditional arrangements may be developed effectively when the resources and expertise of two or more entities are used. The various parties involved may facilitate creative combinations of financing methods. These arrangements may include techniques such as issuing bonds, raising capital from private investors, lease financing, and direct purchase. Because of the originality of many joint-venture agreements, it is particularly crucial that all parties involved understand and accept their responsibilities.

For additional information regarding the evaluation of biomass system financing and economics, refer to the following two publications:

- o Biomass Energy Systems: An Investment Decision-Making Guide for the Small Business, 1986, by S. Sinclair, P. Smith, and R. Bush.
- o Financing Options for Biomass Energy Systems, 1986, by N. Pennycooke.

Both of the above publications were sponsored by, and are available through, the Southeastern Regional Biomass Energy Program, managed by TVA (their address and phone number are in Appendix A).

## Appendix A: Southeast Region State Energy Office Contacts

Ed Davis  
Arkansas Energy Office  
No. 1 Capitol Mall  
Little Rock, AR 72201  
(501) 371-1370

Leon Thompson  
State Energy Program Office  
University Square Mall  
Clemson, SC 29631  
(803) 656-4732

Phil Grimm  
Virginia Division of Forestry  
Box 3758  
Charlottesville, VA 22903  
(804) 977-6555

Harold Draper  
Florida Governor's Energy Office  
301 Bryant Building  
Tallahassee, FL 32301  
(904) 488-6931

J. Fred Allen  
Georgia Forestry Commission  
P.O. Box 819  
Macon, GA 31298  
(912) 744-3357

Brian Hensley  
Department of Economic and  
Community Development  
Energy Division  
6th Floor  
320 6th Avenue, North  
Nashville, TN 37219-5308  
(615) 741-2994

John Stapleton  
Kentucky Energy Cabinet  
Box 11888 IRW Works RK  
Lexington, KY 40578  
(606) 252-5535

Norman Lenhardt  
Missouri Department of Natural  
Resources and Energy  
P.O. Box 176  
Jefferson City, MO 65102  
(314) 751-4000

Keith Overdyke  
Louisiana Department of  
Natural Resources  
Energy, Research and Planning  
Division  
P.O. Box 44156  
Baton Rouge, LA 70804  
(504) 342-4669

P. Tal Bankston  
Department of Energy and  
Transportation  
501 George Street  
Watkins Building  
Jackson, MS 39202  
(601) 961-4733

John Herholt  
West Virginia Fuel and Energy  
Office  
1426 Kanauba Boulevard, East  
Charleston, WV 25301  
(304)348-8860

Ralph M. Stanford  
Energy Division-Alabama  
Department of Economic and  
Community Affairs  
3465 Norman Bridge Road  
Montgomery, AL 36105-0939  
(205) 284-8938

Doug Culbreth  
North Carolina Department of  
Commerce  
P.O. Box 25249  
Raleigh, NC 27611  
(919) 733-2230

Phillip C. Badger  
Southeastern Regional Biomass  
Energy Program  
435 Chemical Engineering  
Building  
Muscle Shoals, AL 35660  
(205) 386-3086



## Appendix B: Southeastern Region State Environmental Agencies

### ALABAMA

Alabama Department of Environmental Management, 1751 Federal Drive,  
Montgomery, AL 36130

Air Division.....(205) 271-7861  
Industrial Water Division.....(205) 271-7823  
Land Division.....(205) 271-7730  
Permits Coordination Branch.....(205) 271-7715

### ARKANSAS

Arkansas Department of Pollution Control and Ecology, 8001 National  
Drive, P.O. Box 9583, Little Rock, AR 72219

Air and Hazardous Materials Division.....(501) 562-7444  
Water Quality Division.....(501) 562-7444  
Solid and Hazardous Waste Division.....(501) 562-7444

### FLORIDA

Department of Environmental Regulation, Division of Environmental  
Programs, Twin Towers Office Building, 2600 Blair Stone Road,  
Tallahassee, FL 32301

Bureau of Air Quality Management.....(904) 488-1344  
Bureau of Waste Water Management.....(904) 488-8163  
Bureau of Waste Management,  
Solid Waste Management Section.....(904) 488-0300  
Division of Environmental Permitting.....(904) 488-0130

### GEORGIA

Georgia Department of Natural Resources, Environmental Protection  
Division, 27D Washington Street, S.W., Atlanta, GA 30334

Air Protection Branch.....(404) 656-4713  
Water Protection Branch.....(404) 656-4713  
Land Protection Branch.....(404) 656-4713

## KENTUCKY

Kentucky Department for Environmental Protection, Fort Boone Plaza, 18  
Reilly Road, Frankfort, KY 40601

Division of Air Pollution Control,  
Permit Review Branch.....(502) 564-3382  
Division of Water, Permit Review Branch...(502) 564-3410  
Division of Waste Management, Permit  
Review Branch - Solid Waste.....(502) 564-6716

## LOUISIANA

Louisiana Department of Environmental Quality, 625 North Fourth Street,  
(see below for P.O. Box), Baton Rouge, LA 70804-4091

Air Quality Division.....(504) 342-1206  
P.O. Box 44096  
Water Pollution Control Division.....(504) 342-6363  
P.O. Box 44091  
Solid Waste Division.....(504) 342-1216  
P.O. Box 44307

## MISSISSIPPI

Mississippi Department of Natural Resources, Bureau of Pollution  
Control, 2380 Highway 80 West, P.O. Box 10385, Jackson, MS 39204

Air Division.....(601) 961-5171  
Water Quality Division.....(601) 961-5171  
Solid and Hazardous Waste Division.....(601) 961-5171

## MISSOURI

Missouri Department of Natural Resources, Division of Environmental  
Quality, 205 Jefferson Street, Jefferson Building, 1st Floor, P.O. Box  
176, Jefferson City, MO 65102

Air Pollution Control Program.....(314) 751-4817  
Water Pollution Control Program,  
Permit Section.....(314) 751-1300  
Waste Management Program,  
Solid Waste Section.....(314) 751-3176

**NORTH CAROLINA**

Department of Human Resources, Division of Environmental Management,  
512 North Salisbury Street, P.O. Box 27687, Raleigh, NC 27611

Air Quality Section.....(919) 733-3340  
Water Quality Section.....(919) 733-5083

Department of Human Resources, Division of Health Services, Solid and  
Hazardous Waste Management, P.O. Box 2091, Raleigh, NC 27602-2091

Solid and Hazardous Waste Branch.....(919) 733-2178

**SOUTH CAROLINA**

Department of Health and Environmental Control, J. Marion Sims  
Building, 2600 Bull Street, Columbia, SC 29201

Bureau of Air Quality Control.....(803) 734-4750  
Bureau of Water Pollution Control.....(803) 734-5300  
Bureau of Solid and Hazardous  
Waste Management.....(803) 734-5200

**TENNESSEE**

Department of Health and Environment, Customs House, 4th Floor, 701  
Broadway, Nashville, TN 37219-5403

Division of Air Pollution Control.....(615) 741-3931  
Division of Solid Waste Management.....(615) 741-3424

Department of Health and Environment, TERRA Building, 4th Floor, 150  
Ninth Avenue, North, Nashville, TN 37219-5404

Division of Water Pollution Control  
Permit Section.....(615) 741-2275

**VIRGINIA**

Virginia Air Pollution Control Board, Division of Program Development,  
Room 801, Ninth Street Office Building, P.O. Box 10089, Richmond, VA  
23240

Telephone: (804) 786-5789

Virginia Water Control Board, P.O. Box 11143, Richmond, VA 23230

Telephone: (804) 257-6384

Virginia Department of Waste Management, Division of Solid and  
Hazardous Waste, Monroe Building, 11th Floor, 101 North 14th Street,  
Richmond, VA 23219

Telephone: (804) 225-2667

**WEST VIRGINIA**

West Virginia Department of Natural Resources, 1260 Greenbrier Street,  
Charleston, WV 25311

Division of Water Resources,

Industrial Section - Permits.....(304) 348-8855

Division of Waste Management.....(304) 348-5935

West Virginia Air Pollution Control Commission, 1558 Washington Street,  
East, Charleston, WV 25311.....(304) 348-3286



## REFERENCE LIST

- Biogas Electric Power Cogeneration: 25kW or Greater, Energy Research and Applications, Inc., for Tennessee Valley Authority Solar Applications Branch, June 1981.
- Biomass Cogeneration, W SUN/113, Western Sun, November 1981.
- Biomass Cogeneration: A Business Assessment, Skelton, J.C., Battelle-Columbus Division, November 1981.
- Biomass Energy: A Technical and Financial Primer, Envirosphere Company, California Energy Commission Report, June 1983.
- Biomass Energy Systems and the Environment, Braunstein, H. M., et.al., Pergamon Press, 1981.
- Connecticut Cogeneration Handbook, Resource Dynamics Corporation, April 1985.
- The Costs of Using Crop Residues in Direct Combustion Applications, SERI/TR-353-513, Flaim, Silvio and Urban, David, Solar Energy Research Institute, March 1980.
- Crop Residues: Availability for Removal and Requirements for Erosion Control, Larson, W. E. and Pierce, F. J., technical paper.
- Cogeneration Handbook, Resource Dynamics Corporation, California Energy Commission Report, September 1982.
- Cogeneration Handbook for the Food Processing Industry, Pacific Northwest Laboratory, Washington, DC: US Department of Energy, 1984.
- Cogeneration Handbook for the Pulp and Paper Industry, Pacific Northwest Laboratory, Washington, DC: US Department of Energy, 1984.
- Cogeneration of Electricity and Heat from Biogas, SERI/STR-231-2844, Jewell, W. J., et.al., a subcontractor report for the Solar Energy Research Institute, March 1986.
- Cogeneration Project Evaluation Manual, Ringo, M. J. and Wilson, W. H., ELI Corporation, a North Carolina Alternative Energy Corporation report, 1985.
- Cogeneration Technology Handbook, Orlando, Joseph A., Rockville, MD: Government Institutes, Inc., 1984.
- Energy from Biomass and Wastes IX, Symposium sponsored by Institute of Gas Technology, January 28-February 1, 1985.

Electric Power From Biofuels: Planned and Existing Projects in the U.S., Easterly, James L. and Saris, Elizabeth, C., Washington, DC: US DOE, 1985.

The Feasibility of Biogas Production on Farms, SERI/PR-9038-1-T1, Jewell, W. J., et.al., Department of Agricultural Engineering, Cornell University, January 1982.

Fuel Alcohol Technical and Economic Evaluation (Draft), SERI/SP-231-2904, Solar Energy Research Institute, February 1986.

Handbook of Industrial Cogeneration. Springfield, VA, NTIS, 1981.

Hardware for Energy Generation in the Forest Products Industry, conference proceedings, Forest Products Research Society, January 30-February 1, 1979.

Industrial/Commercial Wood Energy Conversion, A Guide to Wood Burning, Fuel Storage, and Handling Systems, Great Lakes Regional Biomass Energy Program, 1986.

Industrial and Commercial Cogeneration, Congress of the United States, Office of Technology Assessment, Washington, DC: US GPO, 1983.

Industrial Wood Energy: A Guide for Virginia, Grim, P. T., Department of Conservation and Historic Resources, Virginia Division of Forestry, September 1985.

The Industrial Wood Energy Handbook, Georgia Institute of Technology, New York: Van Nostrand Reinhold Company, Inc., 1984

Tree Biomass - A State-of-the-Art Compilation, Forest Service, U.S. Department of Agriculture, General Technical Report WO-33.

Turning Great Plains Crop Residues and Other Products into Energy, Heid, Walter G., Jr., Economic Research Service, U.S. Department of Agriculture, Agricultural Economic Report Number 523.

Waste-To-Energy: A Primer for Utility Decision-Makers (Final Draft), Easterly, J., et al., Meridian Corporation, July 18, 1986.

Waste Wood for Energy, Hall, E. H., et.al., Battelle Columbus Laboratories, June 11, 1981.

Waukesha Cogeneration Handbook, Waukesha Power System, Diesel Industries, Inc., 1986.

Woody Biomass Analysis for 13 Southeastern States, Technical Note B52, TVA/ONRED/LER-84/6, Division of Land and Economic Resources, Tennessee Valley Authority, December 1984.

## GLOSSARY

**ANAEROBIC DIGESTION** -- degradation of organic matter by microbes in the absence of air (oxygen) to produce methane and carbon dioxide.

**ASH** -- inorganic residue remaining after ignition of combustible substances, determined by definite prescribed methods.

**ATTAINMENT AREA** -- a geographic region where the concentration of a specific air pollutant does not exceed federal standards.

**AVOIDED COSTS** -- the incremental costs to an electric utility of electric energy or capacity or both, which, but for the purchase from the qualifying facility or facilities, such utility would incur itself.

**BACK-PRESSURE STEAM TURBINE** -- Steam, generated in a boiler, is used in a turbine/generator to produce electricity. Steam is discharged from the last stage of the turbine at pressures needed for industrial process use.

**BACKUP ELECTRICITY (backup services)** -- power and/or services that are only occasionally needed, e.g., when on-site generation equipment fails.

**BAGASSE** -- plant residue remaining after extraction of a juice, e.g., sugar cane, sugar beets, grapes, olives, guayule.

**BASELOAD** -- The minimum amount of electric power that is generated or supplied continuously.

**BASELOAD CAPACITY** -- a reference to electricity production: the power output that can be continuously produced. Usually computed by considering equipment that the operator/utility intends to run at least 70% of the time.

**BIOCONVERSION** -- a general term describing the conversion of energy by use of biological mechanisms, microorganisms, or plants. Examples are digestion of organic wastes or sewage by microorganisms to produce methane and the synthesis of organic compounds by plants.

**BIOGAS** -- a gaseous mixture of carbon dioxide and methane produced by the anaerobic digestion of organic matter.

**BIOMASS** -- any organic matter which is available on a renewable basis including forest residues, agricultural crops and wastes, wood and wood wastes, animal wastes, livestock operation residue, aquatic plants, and municipal wastes.

**BOTTOMING CYCLE** -- the use of low-temperature waste heat from an industrial process to generate electricity. Steam or an organic fluid can be used as the working fluid.

BRITISH THERMAL UNIT (Btu) -- the amount of heat required to raise the temperature of 1 pound of water 1 Fahrenheit degree (from 39° to 40° Fahrenheit) under stated conditions of pressure and temperature.

CAPACITY FACTOR -- the ratio of the average load on a machine or piece of equipment for a given period of time to the maximum capacity of the machine or equipment.

CAPITAL COST -- installed cost of additions, improvements, and replacements or expenditures for the acquisition of existing facilities.

CHIPS -- small fragments of wood chopped or broken by cuts such as by a planer, chipper, mechanical hog, hammermill.

COGENERATION -- the sequential production of electricity, or shaft power, and useful thermal energy from the same fuel source.

COMBINED CYCLE -- waste heat from a gas-turbine topping cycle is used to produce steam in a waste-heat boiler. The steam is used to generate electricity in a steam turbine/generator.

CONDENSING STEAM TURBINE -- steam, generated in a boiler, is used in a turbine/generator to produce electricity. Steam exhausted from the last stage of the turbine is condensed and recycled to the boiler.

CONVENTIONAL FOREST PRODUCTS -- any commercial roundwood products (boards, dimension lumber, pulp and paper products) except fuelwood.

DEMAND CHARGES -- part of the utility service charge determined on the basis of possible maximum demand as distinguished from actual energy consumption.

DENSIFIED BIOMASS FUELS -- fuel made by compressing biomass to increase the density and to form the fuel into a specific shape such as cubes, pressed logs, pellets, or briquettes.

DIESEL ENGINE -- a compression ignition type piston engine, as opposed to a spark ignition engine, in which the fuel is ignited by injecting it into air that has been heated.

DOWNDRAFT GASIFIER -- a gasifier in which the product gases pass through a combustion zone at the bottom of the gasifier.

DRY FUEL -- biomass materials with low moisture content, generally 8-10%. The allowable moisture content for dry fuel varies with requirements of the combustion system.

EFFICIENCY -- fuel utilization may be expressed several different ways:  
1.) Fuel to steam efficiency is the ratio of boiler output to energy in fuel consumed. Combustion efficiency by common usage is calculated from flue gas temperature and excess air. Burning efficiency indicates the ability to completely burn the fuel without excess air. The true measure of a combustion efficiency

is in inverse proportions to excess air required. Excess air may range from 1% modern utility boilers firing dry fuel to 50% on well-operated boilers and up to 400 percent on poorly operated boilers firing wet fuel.

- 2.) Boiler efficiency sometimes means combustion efficiency less radiation. Boiler efficiency with fiber fuels may range from less than 40% with wet fuel to over 80% with dry fuel.

**ENERGY PLANTATIONS** -- the growing of plant material for its rich fuel value; a renewable source of energy-rich, fixed carbon produced by photosynthesis.

**EXTRACTION STEAM TURBINE** -- steam, generated in a boiler, is used in a turbine/generator to produce electricity. Steam is extracted at different pressures from intermediate stages of the turbine for use in industrial processes. The steam from the final stage is condensed and returned to the boiler.

**FEEDSTOCK** -- any material which is used as a fuel directly or converted to another form of fuel or energy product.

**FLUIDIZED BED** -- a gasifier design in which feedstock is kept in suspension by a bed of solids kept in motion by a rising column of gas.

**GASIFICATION** -- any chemical or heating process used to convert a feedstock to a gaseous fuel.

**GAS TURBINE** -- sometimes called combustion turbines, a gas turbine converts energy of hot compressed gases (produced by burning fuel in compressed air) into mechanical power that can be used to generate electricity and compress more air.

**GREEN FUEL** -- freshly harvested biomass not substantially dehydrated.

**GRID** -- a utility's power generation, transmission and distribution system, including transmission lines, transformer stations, etc.

**HAMMERMILL** -- a hammermill consists of a rotating head with free swinging hammers which the particle size of biomass feedstocks by impact of the hammers and by grinding between the hammers and the discharge grate. Moisture content of material to be ground should not exceed 20%.

**HEAT FLOW** -- the amount of heat generated in a unit of time.

**HEAT RATE** -- a measure of generating station thermal efficiency, generally expressed in Btu per net kilowatt-hour. It is computed by dividing the total Btu content of the fuel burned for electric generation by the resulting kilowatt-hour generation.

**HEATING VALUE, HIGHER** -- a measure of heat energy of wood at any specified moisture content (figures for energy content in this guidebook are higher heating values).

HEATING VALUE, LOWER -- The higher heating values less the heat energy required to vaporize the moisture in the fuel.

HOG -- a size reduction device to reduce large pieces by impinging against a serrated breaker plate. A coarse, roughly uniform size can be obtained by a square grid after the breaker plate. Can be used with wet or dry material.

HOGGED FUEL -- coarse ground wood fuel.

HORSEPOWER -- this measurement for energy has several different values:

1. Boiler HP = 33,480 Btu per hour or 3413 KW thermal.
2. Mechanical (shaft) HP = 550 Foot Pounds per second.
3. Electric HP = 0.746 kilowatts per hour

INTERRUPTABLE POWER -- power made available under agreements that permit curtailment or cessation of delivery by the supplier. Advance notice of 1 to 1-1/2 hours is usually given prior to the interruption.

INVESTMENT TAX CREDIT -- a specified percentage of the dollar amount of new investment in each of certain categories of assets that a firm can deduct as a credit against its income tax.

IRR (internal rate of return) -- the discount rate that equates the present value of expected future receipts to the cost of the investment outlay.

LANDFILL GAS -- biogas produced from the natural degradation of the organic materials in landfills.

LIFE-CYCLE COSTING -- a method of comparing costs of equipment or buildings based on original costs plus all operating and maintenance costs over the useful life of the equipment. The future costs are usually discounted.

LOAD -- the amount of energy delivered or required at any specified point or points on a system.

LOAD DURATION CURVE -- energy use as a function of time.

METHANE (CH<sub>4</sub>) -- is the major component of natural gas. It can also be formed by anaerobic digestion of biomass or gasification of coal or biomass.

MOISTURE CONTENT, DRY BASIS -- fraction of a biomass sample equal to the weight of the water in the sample divided by the weight of the sample when bone dry.

MOISTURE CONTENT, WET BASIS -- fraction of a biomass sample equal to the weight of the water in the sample divided by the total weight of the sample. (All moisture contents cited in this guidebook are wet basis.)

MUNICIPAL SOLID WASTES (MSW) -- the refuse materials collected from urban areas in the form of organic matter, glass, plastics, waste paper, etc., not including human wastes or wastewater.

NAAQS -- National Ambient Air Quality Standards.

NEA -- National Energy Act of 1978.

NO<sub>x</sub> (nitrogen oxide) -- a series of air pollutants formed during combustion.

NPV (net present value) -- a capital-budgeting method that accounts for the time value of money through discounted cash flow analysis. The method determines the present value of the expected net revenue from an investment minus the cost outlay, discounted at the cost of capital.

NSPS -- New Source Performance Standards.

O&M -- Operation and maintenance.

PARALLEL GENERATION -- industrial power generation facilities whose AC frequencies are exactly equal to and are synchronized with the utility service grid.

PARTICULATES -- minute solid or liquid particles in the air or in an emission. Particulates include dust, smoke, fumes, mist, and fog.

PAYBACK PERIOD -- the number of years required for a firm to recover its original investment from net cash inflows.

PEAK LOAD -- the maximum load demand during a specified period of time.

PEAK LOAD MANAGEMENT -- an attempt to reduce the system peak load by leveling the load curve.

PELLET -- a densified fuel form, usually produced by extrusion and cylindrical in shape with random lengths and open broken ends. Generally of high density, size ranges from 1 mm to 3/8 inch.

POWER FACTOR -- the ratio of real power to apparent power for any given load and time. Generally it is expressed as a ratio.

PRIME MOVER -- equipment that transforms pressure or thermal energy to useful mechanical energy.

PROCESS HEAT -- heat, usually in the form of hot air or steam, used for an industrial process in a plant rather than for space heating.

PROCESS STEAM LOAD -- number of pounds of steam per hour required for a specified industrial process.

PSD -- Prevention of Significant Deterioration.

PURPA -- Public Utility Regulatory Policies Act of 1978.

PV (present value) -- the amount of money that, if invested today at a certain rate of return, would be equivalent to a fixed amount to be received at a specified future time.

RANKINE CYCLE -- a reversible thermodynamic cycle that describes the heat-to-work conversion process in a steam power plant.

RATE BASE -- the value of assets, established by a regulatory authority, on which a utility is permitted to earn a specified rate of return. Generally, this represents the amount of property used in public service.

RENEWABLE RESOURCES -- sources of energy that are regenerative or virtually inexhaustible, such as solar, wind, ocean, biomass, municipal wastes, hydropower and geothermal energy.

RESOURCE RECOVERY -- the process of obtaining materials or energy from wastes, particularly from solid wastes.

SCRUBBER -- an air pollution control device that uses a solid or liquid reagent to remove pollutants from a gas stream by absorption or chemical reaction. (Scrubbers also reduce the temperature of the emission.)

SHAFT POWER -- mechanical energy in the form of a rotating shaft.

SO<sub>2</sub> (sulfur dioxide) -- a precursor to the pollutant sulfuric acid, a component of "acid rain" formed by combustion of oil or coal.

SPINNING RESERVE -- generating capacity that is on-line and ready to take load, but in excess of the current load on the system.

SPREADER STOKER FURNACE -- fuel is automatically or mechanically spread across the furnace. A portion is suspension burned, but large pieces fall on the grate where combustion is completed.

STANDBY SERVICE (also STANDBY POWER or STANDBY RESERVE) -- service that is not normally used but that is available through a permanent connection in lieu of, or as a supplement to, the usual source of power supply.

STEAM TURBINE -- a prime mover that converts the heat energy of steam, generated in a boiler, to mechanical energy.

SUNK COSTS -- Costs that have already been committed and, thus, are irrelevant to future investment decisions.

SURPLUS ELECTRICITY -- Electricity generated beyond the immediate needs of the producing system, frequently obtained from spinning reserve and sold on an interruptible basis.

THERMOCHEMICAL CONVERSION -- the use of heat to chemically change substances from one state to another to produce energy products.



TON -- a short ton or 2000 pounds.

TONNE -- a metric ton or 2205 pounds.

TOPPING CYCLE -- energy is first used to generate electricity, then used in an industrial process.

TOTAL ENERGY SYSTEM -- onsite generation of electricity with beneficial use of waste heat.

TRAVELLING GRATE -- has assembled links; grates are key joined together in a perpetual belt arrangement. Fuel is fed at one end, and ash is discharged at the other.

TURNDOWN RATIO -- maximum to minimum operating range of a parameter.

TURBINE -- an enclosed rotary type of prime mover in which the heat energy in steam or gas is converted into mechanical energy by the force of a high velocity flow directed against successive rows of radial blades fastened to a central shaft.

WASTE HEAT -- unused thermal energy that is exhausted to the environment from an electric generation system or an industrial process.

WASTE-HEAT BOILER -- hot exhaust gases from turbines, incinerators, furnace exhausts, and so on are used to generate useful energy (steam).

WHEELING -- the process in which electrical energy is transferred between buyer and seller by way of an intermediate utility or utilities.

WHOLE-TREE HARVESTING -- a harvesting method in which the whole tree is removed for utilization except for the stump and root system.

