

# **GAS TO LIQUIDS TECHNOLOGY (GTL)**



**Prepared by**  
**Wisam Al-Shalchi**  
**Petroleum Expert**

**Baghdad – 2006**

# Contents

<b>Introduction</b>		<b>3</b>
<b>Chapter One</b>		
<b>The Development of the GTL Technology</b>		
<b>1 -</b>	<b>Introduction</b>	<b>6</b>
<b>2 -</b>	<b>Definition of the GTL Process</b>	<b>9</b>
<b>3 -</b>	<b>The Synthesis Gas</b>	<b>10</b>
<b>4 -</b>	<b>Methods of Producing Synthesis Gas</b>	<b>12</b>
<b>5 -</b>	<b>Fischer–Tropsch Method to Produce Synthetic Fuels</b>	<b>19</b>
<b>6 -</b>	<b>Mechanism of Fischer-Tropsch Reaction</b>	<b>22</b>
<b>7 -</b>	<b>Kinds of Fischer-Tropsch Operations</b>	<b>25</b>
<b>8 -</b>	<b>Upgrading Fischer–Tropsch Products</b>	<b>26</b>
<b>9 -</b>	<b>Specifications of the GTL Products</b>	<b>27</b>
<b>Chapter Two</b>		
<b>Kinds of GTL Technologies</b>		
<b>1 -</b>	<b>Introduction</b>	<b>32</b>
<b>2 -</b>	<b>Sasol's GTL Technology</b>	<b>33</b>
<b>3 -</b>	<b>Shell's GTL Technology</b>	<b>40</b>
<b>4 -</b>	<b>ExxonMobile's GTL Technology</b>	<b>43</b>
<b>5 -</b>	<b>Syntroleum's GTL Technology</b>	<b>44</b>
<b>6 -</b>	<b>Other GTL Technology</b>	<b>47</b>
<b>7 -</b>	<b>GTL Plants</b>	<b>53</b>
<b>Chapter Three</b>		
<b>Gas to Liquids (GTL) Economics</b>		
<b>1 -</b>	<b>Introduction</b>	<b>57</b>
<b>2 -</b>	<b>Process Challenges and Drivers of a GTL Plant</b>	<b>58</b>
<b>3 -</b>	<b>Factors Affecting the GTL Economics</b>	<b>62</b>
<b>4 -</b>	<b>The Future of the GTL Industry from the Economic Outlook</b>	<b>69</b>

<b>Chapter Four</b>		
<b>Potential Impacts of the GTL Industry</b>		
<b>1 -</b>	<b>Introduction</b>	<b>72</b>
<b>2 -</b>	<b>The GTL Industry and the Environment</b>	<b>73</b>
<b>3 -</b>	<b>The Impacts of GTL Industry on Refiners</b>	<b>78</b>
<b>4 -</b>	<b>The Impacts of the GTL Industry on the LNG Production Industry</b>	<b>85</b>
<b>5 -</b>	<b>The Impacts of the GTL Industry on the Utilization of the Clean Fuels</b>	<b>88</b>
<b>6 -</b>	<b>The Future of the GTL Industry from the Industrial Outlook</b>	<b>91</b>
<b>Chapter Five</b>		
<b>The Gas to Liquids (GTL) Projects</b>		
<b>1 -</b>	<b>Introduction</b>	<b>95</b>
<b>2 -</b>	<b>The GTL Projects Around the World</b>	<b>97</b>
<b>3 -</b>	<b>The GTL Projects in the Arab Countries</b>	<b>99</b>
<b>Chapter Six</b>		
<b>The Possibility of Using The GTL Technology in Iraq</b>		
<b>1 -</b>	<b>The Iraqi Natural Gas Reserves and Production</b>	<b>107</b>
<b>2 -</b>	<b>The Iraqi Natural Gas Fields</b>	<b>109</b>
<b>3 -</b>	<b>Natural Gas Processing in Iraq</b>	<b>110</b>
<b>4 -</b>	<b>Development of the Iraqi Natural Gas Fields</b>	<b>111</b>
<b>5 -</b>	<b>The Possibility of Building a GTL Project in Iraq</b>	<b>118</b>
<b>Chapter Seven</b>		
<b>Conclusions and Recommendations</b>		
<b>1 -</b>	<b>Conclusions Concerning The GTL Technologies</b>	<b>122</b>
<b>2 -</b>	<b>Conclusions Concerning the Economy of the GTL Technology</b>	<b>122</b>
<b>3 -</b>	<b>Conclusions Concerning the Effects of the GTL Technology on Oil Refining Industry</b>	<b>124</b>
<b>4 -</b>	<b>Conclusions Concerning The Utilization of the GTL Technology in Iraq</b>	<b>125</b>
<b>5 -</b>	<b>General Conclusions</b>	<b>126</b>
<b>6 -</b>	<b>Recommendations</b>	<b>127</b>
<b>References</b>		<b>129</b>

## Introduction

It is a truism to observe that the world's hydrocarbon resources like oil and natural gas are not evenly distributed, and in particular that a substantial proportion of known reserves are situated in locations remote from areas of high consumption. Transportation of liquid hydrocarbons from source to consumer is a task for which a large and flexible infrastructure exists. However, where natural gas deposits in remote locations are to be exploited, the transportation task becomes a major challenge - particularly if geography, economics or a combination of both precludes the possibility of a pipeline. Countries in the Middle East, for example, have huge reserves of natural gas but little local market for it and no pipeline infrastructure to ship it to larger economies. This challenge can be met by conversion of natural gas into a transportable and saleable form or product. Historically this has implied LNG, ammonia or methanol as the medium of bringing remote natural gas to the market place. Each of these has its limitations - the heavy investment and, relatively speaking, small number of receiving terminals limits the marketing flexibility for LNG. Neither the ammonia nor the methanol market is large enough to accept the potential volumes available from exploitable natural gas reserves. Current prices for both products would indicate that we are close to these marketing limits - unless of course legislation drives motor fuels in the direction of methanol. An alternative which is gaining increasing attention is the conversion of natural gas to liquids - ranging from gasoline to middle distillates (GTL fuels) by the GTL Technology. This approach avoids the infrastructural limitations of LNG and at the same time provides a market large enough to accept the potential volumes.

Basic GTL technology was invented in 1923, when two German scientists, Franz Fischer and Hans Tropsch, discovered the catalytic conversion of carbon monoxide and hydrogen (synthesis gas) into synthetic hydrocarbons. The GTL process involves feeding pipeline-quality natural gas (methane) into a reformer or generator where it is converted into synthesis gas (a combination of carbon monoxide and hydrogen). This technology is similar to processes used for years to make methanol and ammonia. Then the synthesis gas is processed through a Fischer-Tropsch reactor where it is converted into GTL fuels (synthetic crude). Fischer-Tropsch chemical reaction process is therefore the core of this technology.

In general, GTL fuels are fuels that can be produced from natural gas using a Fischer-Tropsch process. It can also be produced by the same process from coal, biomass, or any carbon-containing material. The liquids produced include naphtha, kerosene, diesel, and chemical feedstocks. GTL fuel has virtually no sulfur, aromatics, or toxics. The resulting GTL diesel for example can be used neat in existing diesel engines and infrastructure, or blended with today's non-complying diesel fuel to make the fuel cleaner so it will comply with new diesel fuel standards. These fuels provide an opportunity to reduce dependence on petroleum-based fuels and reduce tailpipe emissions.

For over 70 years, interest in commercial gas to liquids (GTL) technology was limited to countries with political rather than economic drivers. Technical advances in GTL development has surged substantially in the last decade, and it have allowed GTL technology to be competitive at current oil and natural gas prices. Since the late 1990s, major oil companies with commercial GTL histories such as Sasol, Shell, ExxonMobil, ConocoPhillips, have announced plans to build GTL plants to produce GTL fuels. As a result, a significant number of commercial-scale GTL facilities will probably begin operation by 2010. After 2010, GTL expansion could begin to surge, and GTL would become a growing market for "stranded" gas. Certain governments such as those of Qatar, Iran and Egypt have taken leading positions in implementing GTL as a component of long-term strategy.

This research concerns about the progress of the GTL technology, starting from its first origin in the twenties of the previous century, and ending with today's giant GTL projects which are being built in some countries like Qatar, Iran, and Nigeria. It also analyses the economic value of this technology according to the current oil and natural gas prices. The impacts of this technology on other petroleum industries like the oil refining, LNG production industry, and the utilization of other clean fuels, are also considered. Finally, the possibility of using the GTL technology in Iraq is also discussed in details throughout this research.

The Author\*

# **Chapter One**

## **The Development of the GTL Technology**

## 1- Introduction:

The world consumes energy from different sources. Some of the energy comes from the fossil fuels like coal, crude oil, and natural gas, which are called sustainable energy sources. Some others come from industrial sources like the nuclear energy. Also, energy obtained from natural sources like solar energy, wind, and waterfalls, is called renewable energy sources. Natural gas provided about 22% of the total world energy consumption in 2004, and it is believed that this percentage will rise to 24% in 2020, as shown in the following diagram<sup>(1)</sup>.

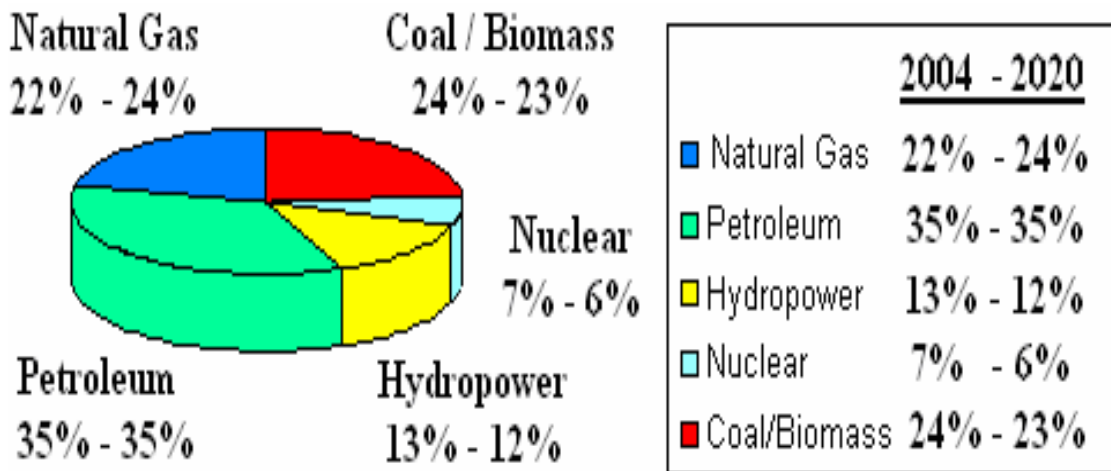

**Figure (1-1): The world consumption of energy from different sources in the years 2004 and 2020.**

The world's proved and potential natural gas reserves are estimated to be more than 6040 trillion cubic feet (Tcf)<sup>(2)</sup>. These reserves are enough by their own, with the current production capacities, to cover the world's need for more than 60 years. Most of the known big gas resources are stranded or remote because they are too far from the consumers, like the fields of Alaska and Siberia. These gas reserves are also very difficult to transport because they need either to be pumped through very long pipelines, or must be liquefied and transported by tankers as Liquefied Natural Gas (LNG). The world consumption of natural gas equal to about 2.5 Tcm, most of it is consumed by the big industrial countries.

The main sources of this fuel comes from the Middle East, East Europe, and former Soviet Union countries as shown in Figure (1-2)<sup>(1)</sup>.

## Proven Global Gas Reserves

156 TCM , 6040 TCF

---

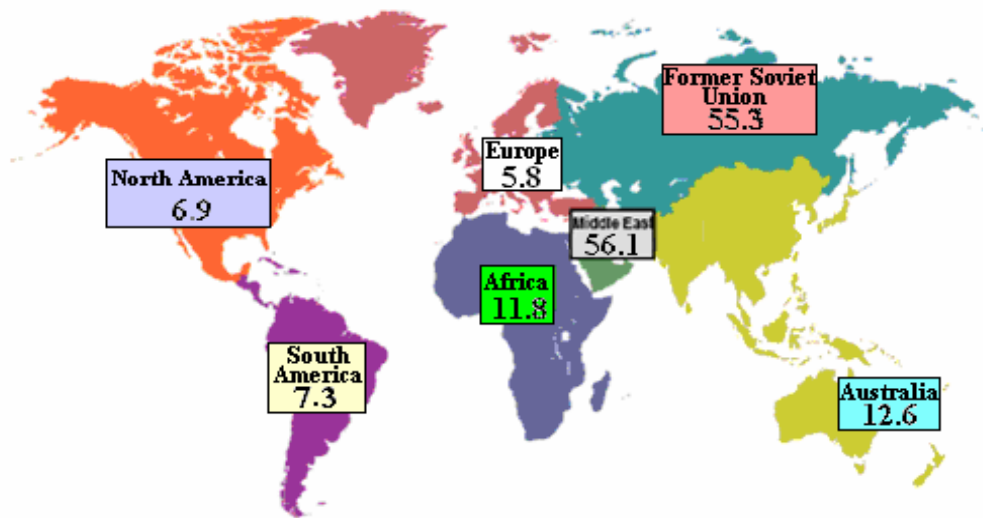

**Annual world gas consumption is only about 2.5 TCM.**

**Figure (1-2): Natural gas reserves in different world regions.**

Natural gas is four times more expensive to transport than oil. On the other hand, converting natural gas into liquid to ease its transportation is even more expensive. For a small remote natural gas field, the transportation by either pumping the gas through very long pipelines, or by liquefying the gas and transporting it by LNG tankers is uneconomic, because both ways are very expensive, leaving these fields undeveloped.

GTL has the potential to convert a significant percentage of this gas into several hundred billion barrels of liquid petroleum - enough to supply the world's energy needs for the next 25-30 years. GTL offers tremendous economic value to the countries and/or companies that control these reserves. GTL will permit the economic development of these remote natural gas discoveries that currently are deemed too far from market to be of economic value. GTL also will help to eliminate the need for flaring natural gas, associated with oil production, which will permit earlier development and production of oil fields shut in by the inability to dispose of the associated natural gas, and reducing the negative environmental impact of flaring. The expenses consumed in these industrial operations can be invested toward the production of valuable liquids from the flared gases by the GTL process. GTL technology in general provides many kinds of benefits and advantages which can be summarized into <sup>(3,4)</sup>:



- (a) Monetizing standard natural gas reserves and providing a solution to Alaska gas fields.
- (b) Eliminating costly and / or environmentally disadvantageous practices.
- (c) Creating environmentally-superior clean liquid fuels.
- (d) Investing the waste gas.
- (e) It can be used as integrating projects with LNG industry.
- (f) The possibility of constructing GTL units for the offshore gas fields.
- (g) The possibility to monetize small stranded gas fields by using the new small mobile GTL plants.

GTL will yield synthetic hydrocarbons of the highest quality that can be used directly as fuels or blended with lower quality crude oil derived fuels to bring them up to compliance with increasingly stringent environmental and performance specifications. The diesel produced by GTL process is crystal clear in color, of high combustion quality, and virtually sulfur free and. The sulfur content of the GTL diesel is less than 1 ppm (wt.) compared with 50 ppm of the conventional diesel. The (EPA) organization considers the diesel to be clean if its sulfur content does not exceed 15 ppm (wt.). The aromatics in the synthesis diesel are less than 1% (vol.) compared with 35% (vol.) in the conventional diesel. The cetane number of the GTL diesel is more than 70 while that of the ordinary diesel is less than 45<sup>(5)</sup>. Finally, the GTL products can be used as good fuels directly, or can be blended with other bad conventional fuels to improve their properties to comply with the tight specifications put by most governments to protect the environment, and the public health.

The world consumption of petroleum products is increasing steadily, while the production of crude oil and the refining capacities are not increasing in the same rate. Table (1-1) shows the European Union (EU) consumption of the light petroleum products for the period 2000 – 2020<sup>(6)</sup>.

<b>Total Demand (MOTE)</b>	<b>1971</b>	<b>1995</b>	<b>2010</b>	<b>2020</b>
Total Oil Primary Consumption	2448	3324	4468	5264
Consumption by Transport Sector	836	1520	2223	3698
Share of Transport (%)	34%	46%	50%	51%
Middle Distillates	610	1200	1700	2000
Middle Distillates from GTL	-	-	5	150

**Table (1-1): The expected world demand for transport fuels till 2020.**

Therefore a shortage of petroleum products supply is likely to happen in the future, and the main new source which is expected to cover this shortage is by the gas to liquids technology (GTL)<sup>(7)</sup>. The GTL industry is expected to grow rapidly throughout the present century because of the sharp ascending of oil prices. These expensive prices will make the chance suitable to invest in this field. Many countries are paying great attention toward their natural gas resources, and instead of flaring this valuable material it is intending to change it to valuable liquids through the GTL industry. Huge contracts are being signed by these countries and by the specialist companies and billions of dollars will be invested. The coming decade will be the true beginning of the GTL industry after about one century of its discovery.

## **2- Definition of the GTL Process:**

Gas to Liquids (GTL)<sup>(8)</sup> is a loosely defined term that is generally used to describe the chemical conversion of natural gas to some type of liquid products. As such, it excludes the production of liquefied natural gas (LNG), but includes the conversion of gas to methanol, liquid fuels, and petrochemicals, being the most common applications. In other words, GTL is a process for converting natural gas into synthetic fuel<sup>(3)</sup>, which can be further processed into fuels and other hydrocarbon – based products. In the simplest of terms, the GTL process tears natural gas molecules apart and reassembles them into longer chain molecules like those that comprise crude oil. GTL, like polymerization, is the building up of larger molecules from smaller ones.

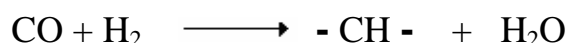
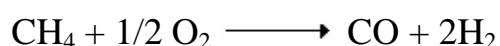

However, with this particular conversion process, the result is virtually free of contaminants such as sulfur, aromatics and metals. This synthetic crude can then be refined into products such as Diesel fuel, Naphtha, Wax and other liquid petroleum or specialty products. The GTL technology provides huge income to the countries which develop their natural gas reserves through this industry, as well as to the companies which invest through these projects.

Natural gas can be converted into synthesis gas (a mixture of predominantly CO and H<sub>2</sub>) by several complicated chemical steps. The Gas to Liquids process is based on the following primary steps:

- (a) The desulphurization of natural gas (natural gas treatment).
- (b) The conversion of dry natural gas into synthesis gas.
- (c) The conversion of synthesis gas into synthetic crude.
- (d) Products upgrading.

Figure (1-3) shows the route of obtaining liquid fuels from coal and natural gas via Fischer – Tropsch (F-T) process <sup>(9)</sup>.

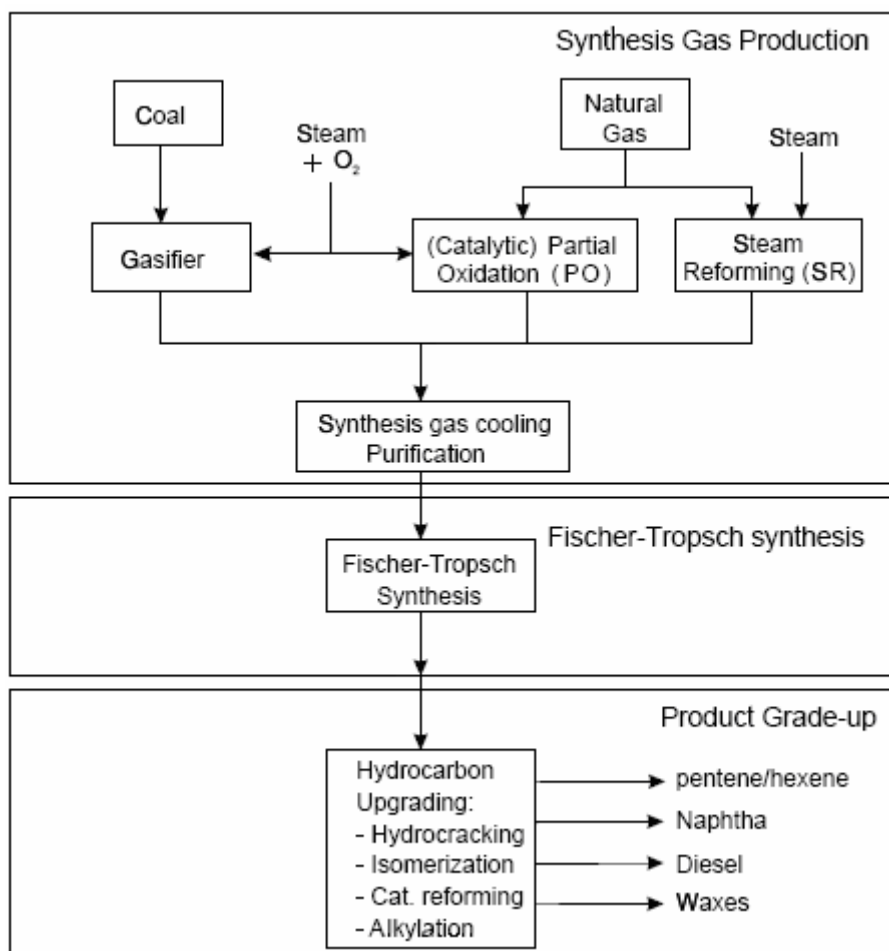
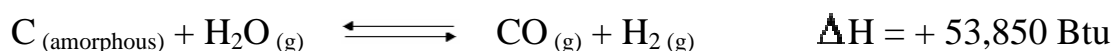

**Figure (1-3): Overall process scheme Fischer-Tropsch.**

### **3- The Synthesis Gas:**

In the latter half of the nineteenth century, complete gasification of coke was achieved commercially by means of cyclic gas generator in which the coke was alternately blasted with air to provide heat and steam to generate "**Blue Water Gas**", a name given to the gas because it formed from steam and burned with blue flame <sup>(10)</sup>. The discovery of blue gas is attributed to Fontana in 1780, who proposed making it by passing steam over incandescent carbon. The blue gas was composed of about 50% H<sub>2</sub>

and 40% CO, with remainder about equal parts CO<sub>2</sub> and N<sub>2</sub>. It had a calorific value of about 11 MJ/m<sup>3</sup>. In the nineteenth century, gas distribution networks were rapidly built up in most large- and medium-size cities, particularly in the industrialized European countries, along with gasworks for the manufacture of the blue gas. The production is carried out by the reaction of steam on incandescent coke (or coal) at temperatures around 1000°C and higher, where the rate and equilibrium are favorable, according to the principle equation:



Another reaction also occurs, apparently at several hundred degrees lower temperature:

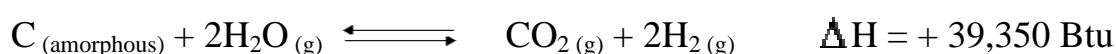

These hydrolysis reactions (reaction with water) are endothermic and therefore tend to cool the coke (or coal) bed rather rapidly, thus necessitating alternate "run" and "blow" periods. During the run period, the foregoing blue-gas reactions take place, and salable, or make, gas results; during the blow period, air is introduced and ordinary combustion ensues, thus reheating the coke to incandescence and supplying the Btu's required by the endothermic useful gas-making reactions plus the various heat losses of the system. The oxygenolysis reactions (reaction with oxygen) are:

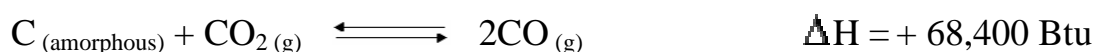
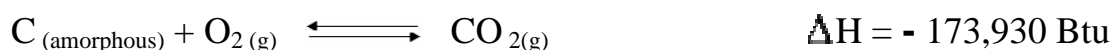

The name "**Blue Water Gas**" of the mixture CO and H<sub>2</sub> was changed to "**Synthesis Gas**" or "**Syngas**", a name which is given to mixtures of gases in suitable properties for the production of synthesis products without adding further reactants. Synthesis gas is composed primarily of carbon monoxide and hydrogen, and it is an odorless, colorless and toxic gas. Its specific gravity depends to percent of hydrogen and carbon monoxide content, and will burn flameless when introduced to air and temperature of 574°C. Synthesis gas can be used as a fuel to generate electricity or steam or used as a basic chemical building block for a large number of uses in the petrochemical and refining industries. It is also utilized as a source of hydrogen for production of methanol, ammonia and hydrogen delivery in gas treating operations and even as fuel.

## 4- Methods of Producing Synthesis Gas:

Synthesis gas can be formed by the following methods according to the starting material used in producing it:

### **a- Gasification<sup>(11)</sup>:**

The process which converts any non-gaseous carbon-containing material into a synthesis gas is called **"Gasification"**. Gasification<sup>(3)</sup> consists of converting a fuel that is often "dirty" (such as coal, petroleum coke, refinery residues, and biomass) and cannot be directly used in an engine or a fuel cell, to a clean gaseous fuel which meets the engine or fuel cell specifications as well as the environmental emissions standards. Thus gasification adds value to low- or negative-value feedstocks by converting them to marketable fuels and products. The conversion of non gaseous carbon materials and natural gas to liquid hydrocarbons is currently one of the most promising topics in the energy industry due to large reserves of coal and natural gas resources. This technology could be used as an interim transportation fuel if conventional oil were to become more expensive or during oil depletion. The resources of coal and natural gas are very large as shown in Table (1-2)<sup>(2, 12, 13)</sup>.

<b>Fuel</b>	<b>Reserves</b>
<b>Coal</b>	984 453 million tones
<b>Crude oil</b>	1,277.702 (Billion Barrels)
<b>Natural gas</b>	6,040.208 (Trillion Cubic Feet)

**Table (1-2): World fossil fuel reserves and consumption.**

Recently many researches were conducted for the conversion (liquefaction) of waste polymers such as used plastics and tires by the Fischer – Tropsch process into transportation fuels. The machine which is used to run the gasification process is called **"Gasifiers"**. There are three major types of gasifiers<sup>(14)</sup>:

- **The fixed bed gasifier.**
- **The fluidized bed gasifier.**
- **The entrained bed gasifier**

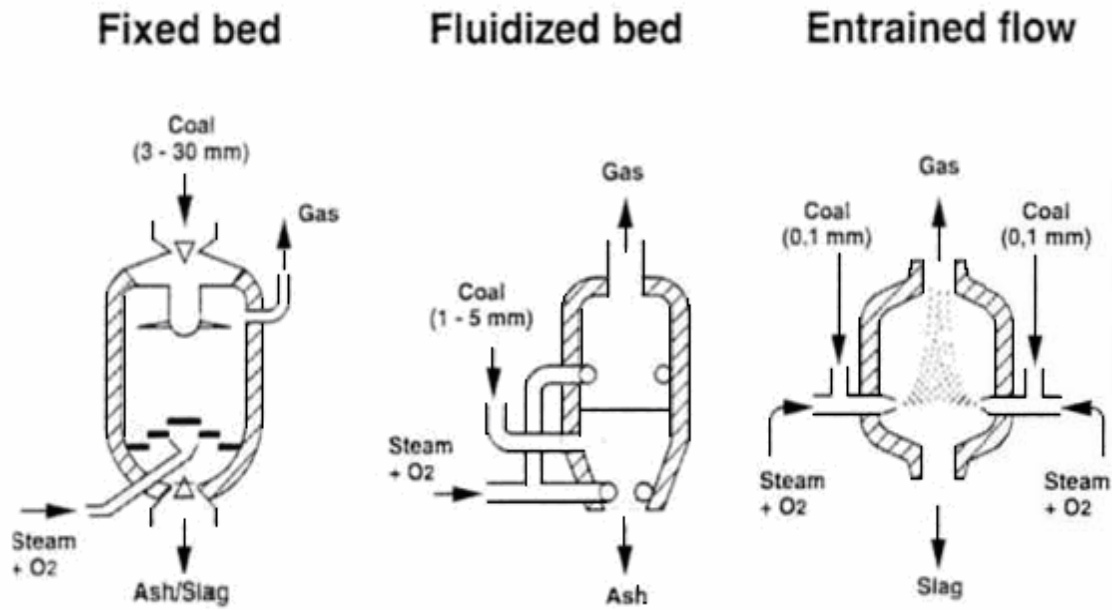

**Figure (1-4): The three major types of gasifiers.**

An example of the fixed bed gasifiers is the **Lurgi dry ash gasifier** which is shown in Figure (1-5)<sup>(14)</sup>.

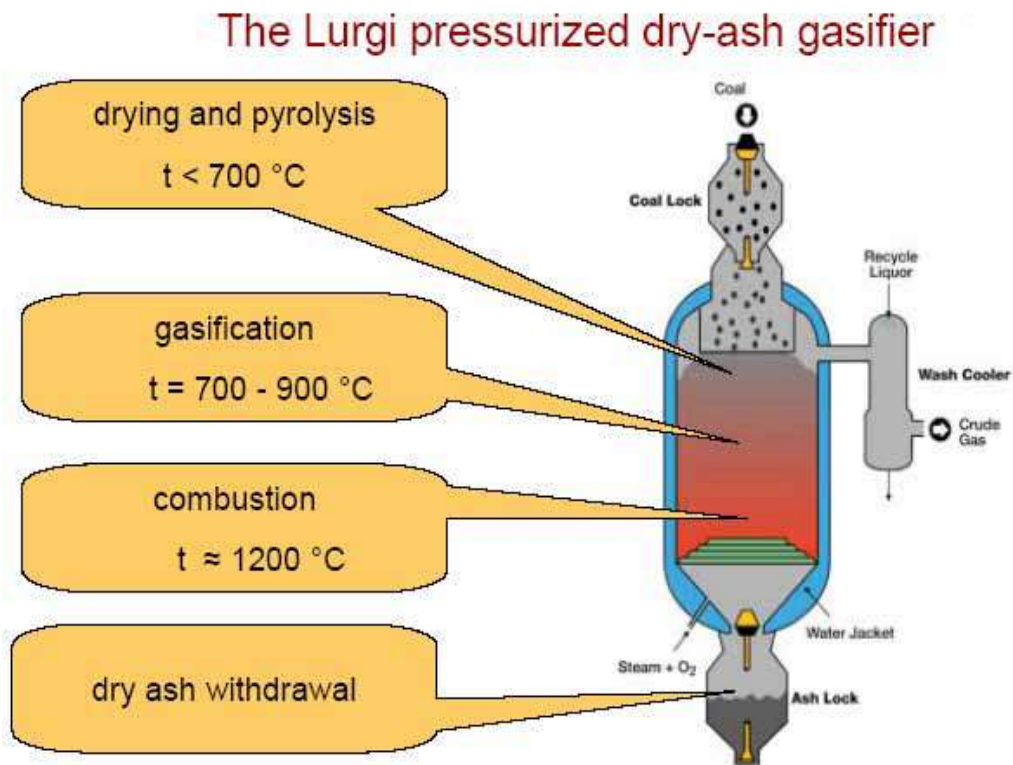
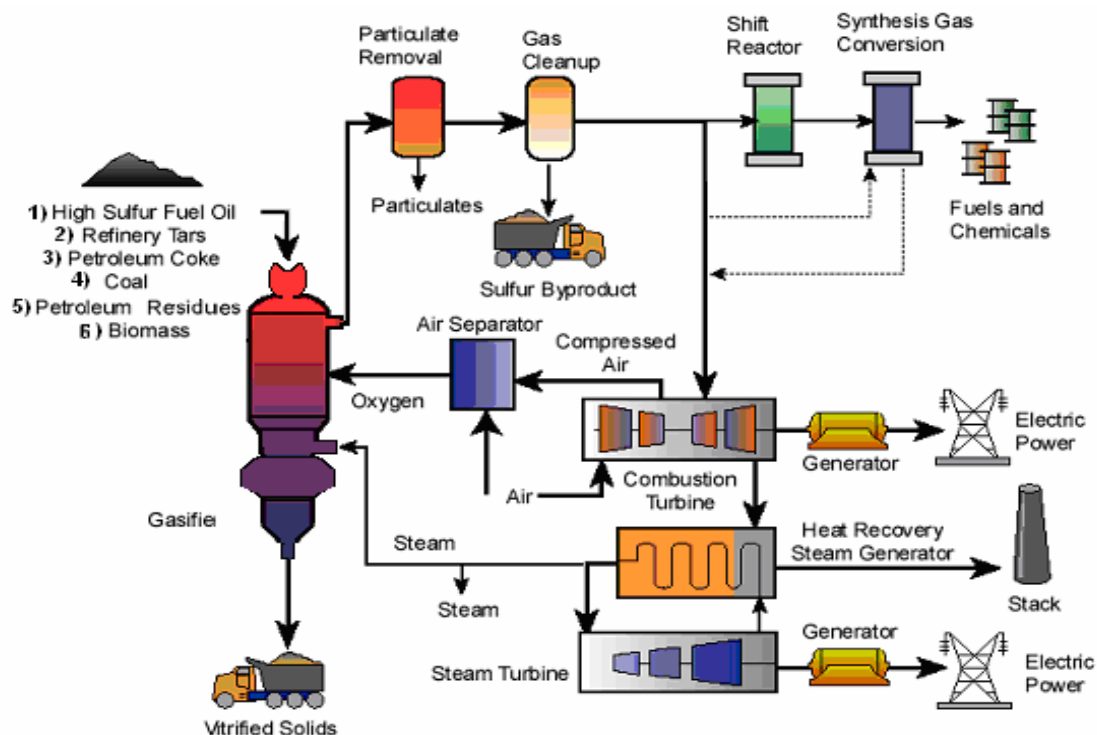

**Figure (1-5): The Lurgi Dry Ash Gasifier.**

The Lurgi gasifier is divided into four distinct zones:

- The top being the drying/preheating (pyrolysis) zone.
- The devolatilization zone.
- The gasification zone.
- The combustion zone.

The gases that leave at the top of the gasifier contain synthesis gas ( $H_2+CO$ ),  $CO_2$ ,  $H_2O$ ,  $CH_4$  and other hydrocarbons including oils and tars as well as other organic compounds, sulfur compounds such as  $H_2S$ ,  $COS$ , some  $CS_2$  and mercaptans, nitrogen compounds such as  $NH_3$  and  $HCN$ . The tars also contain some sulfur and nitrogen. Synthesis gas produced in modern coal gasifiers and from heavy oil residues has a high  $CO$  content in comparison to synthesis gas from natural gas. If synthesis gas with a ( $H_2/CO$ ) ratio below 2 is used, the composition is not stoichiometric for the Fischer-Tropsch reactions. The following picture shows the process of converting petroleum coke (or any non- gaseous carbon-containing material) to synthesis gas (blue water gas), as well as the other usages <sup>(15)</sup>.



**Figure (1-6): Production of synthesis gas from non- gaseous carbon-containing materials.**

### **b- Production of Synthesis Gas from Natural Gas:**

In the first half of the twentieth century the availability and the cheap price of natural gas displaced the use of coke in manufacturing the

synthesis gas. Like the production of the blue gas, the process can be carried out without the use of any catalyst, but it was found that the use of a catalyst like Nickel or Cobalt can improve the production. Synthesis gas is generally produced from natural gas by one of the following processes <sup>(16)</sup>.

### (1) Partial Oxidation (PO):

In partial oxidation process (PO), natural gas reacts with pure oxygen in an open flame at temperature of 1200-1500°C.



The process can be carried out without the use of any catalyst, but it was found that the use of a catalyst like Nickel or Cobalt can improve the production, and the process is called in this case **Catalytic partial oxidation (CPO)**. The gas-phase partial oxidation produces synthesis gas with an H<sub>2</sub> to CO ratio (H<sub>2</sub>/CO) of typically less than 2:1, on a molar base.

### (2) Steam Reforming (SR):

The steam reforming (SR) process converts natural gas (methane) with steam on a nickel catalyst at 800-1000°C and 30 atm to a hydrogen rich synthesis gas.



A large steam surplus is required to suppress carbon formation in the catalyst. The typical (H<sub>2</sub>/CO) ratio is greater than 3:1. The natural gas must be desulfurized (treated) to prevent catalyst deactivation. The catalyst used (which is normally based on nickel), is packed in externally heated tubes suspended in furnace box.

### (3) Autothermal Reforming (ATR):

This process is a combination of the above two processes (PO and SR) in a single step. The benefits are a lower reaction temperature, lower oxygen assumption, and an (H<sub>2</sub>/CO) ratio of 2:1 that is ideally suited for the Fischer-Tropsch synthesis. The main reactions occurring in the autothermal reforming process are defined for methane in the following equations:



Another reaction which takes place in this process and in the above steam reforming reaction and called **"Water gas shift reaction"** is:



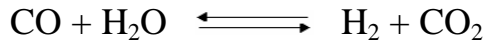

$$\Delta H = -41 \text{ kJ/mole}$$

If hydrogen production is to be maximized, the water gas shift reaction can be performed, generating only carbon dioxide and hydrogen and leaving no hydrocarbons in the product stream. The produced Carbon dioxide (CO<sub>2</sub>) from the water gas shift reaction is reconsumed according to the following reactions, for the formation of more synthesis gas.

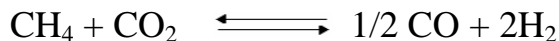

These reactions are called "**CO<sub>2</sub> steam reforming reaction**", and can be accelerated by applying high pressure which helps in absorbing it in water. The Combined Autothermal Reforming involves the reaction between a treated natural gas and steam at elevated temperature and pressure over a catalyst. The reaction conditions range up to 850°C and 30 atm. The catalyst used normally based on nickel, is packed in externally heated tubes suspended in furnace box. The reaction products are H<sub>2</sub>, CO, CO<sub>2</sub>, and methane, together with undecomposed steam. These gases then are passed to a second reforming stage, in a secondary reactor which is normally a refractory-lined vessel containing a slightly less active catalyst than that in the primary reformer. The flowchart of this process is shown in Figure (1-7)<sup>(17)</sup>.

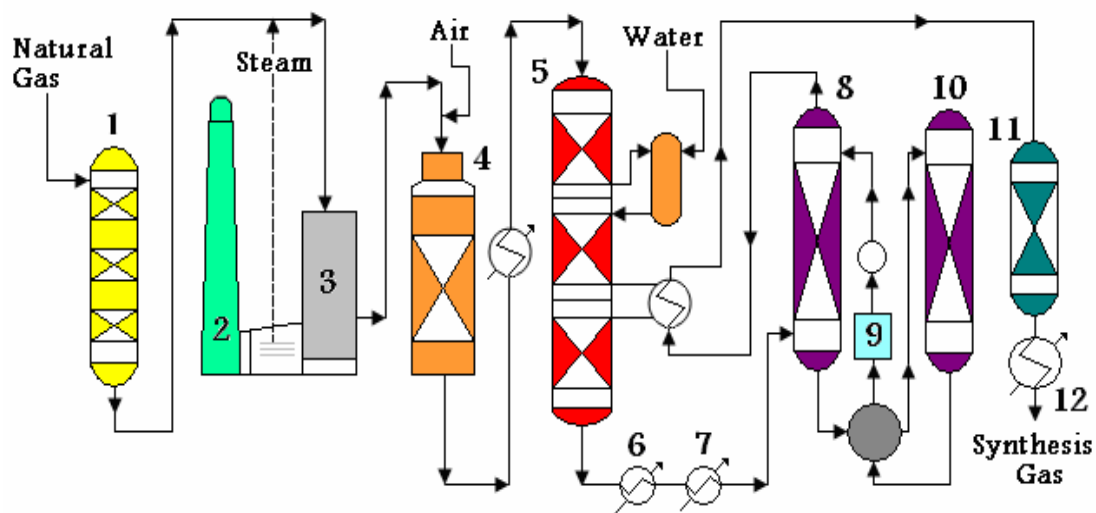

1- Desulfurizer 2-Stack 3- Primary Reformer 4-Secondary Reformer 5- Carbon Monoxide Conversion 6-Feedwater Heater 7-Reboiler 8- Carbon Dioxide Absorber 9- Air Cooler 10- Reactivator 11- Methanator 12- Feedwater Heater

**Figure (1-7): The catalytic production of synthesis gas.**

#### (4) Shell's Gasification Process (SGP) <sup>(18)</sup>:

Shell's gasification process (SGP) is a much older process, the basic development having been made in the 1950's and some 150 units having been built in the meantime. With natural gas feed it produces a synthesis gas with an  $H_2/CO$  ratio of typically (1.7 - 1.8) and a  $CO_2$  content of (1.7 - 3) depending on the steam addition rate. A simplified flow diagram of a gas based (SGP) unit is shown in Figure (1-8) <sup>(16)</sup>.

The gas feed is preheated with the raw gas to a temperature of about  $380^\circ C$  for desulphurization prior to being fed to the (SGP) reactor with the oxygen. The partial oxidation reaction takes place at about  $1300 - 1400^\circ C$  in the refractory lined reactor. The sensible heat of the hot gas is used to generate high-pressure steam, with or without superheat as required. As mentioned previously the non-catalytic partial oxidation reactor produces small amounts of soot which are washed out in a scrubber. The carbon is concentrated in the reaction water which is discharged to the waste water treatment. The gas - now free of soot - is ready for use in the synthesis with an  $H_2/CO$  ratio of 1.86. If we compare the synthesis gas quality with that produced by Combined Reforming we see a considerably lower  $H_2/CO$  ratio of 1.86 compared with 3.14 for Combined Reforming making (SGP) a better match for, for instance, the (SMDS) process. The amount of natural gas required to produce the synthesis gas is some 3.5% lower than for the Combined Reforming case. These advantages are bought at the cost of higher oxygen consumption.

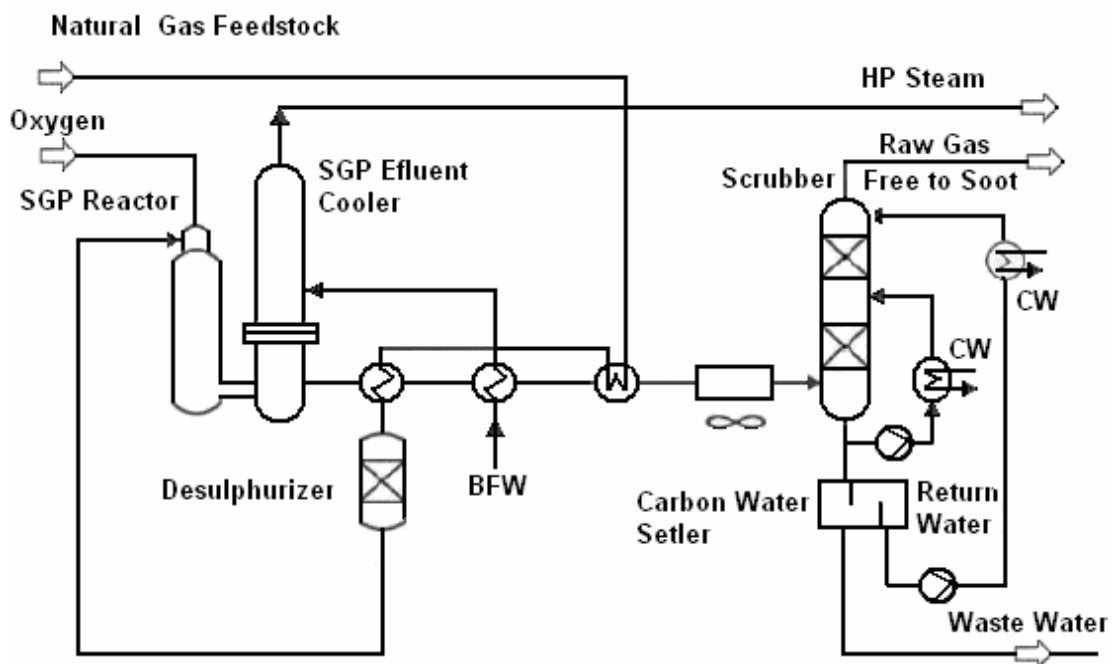
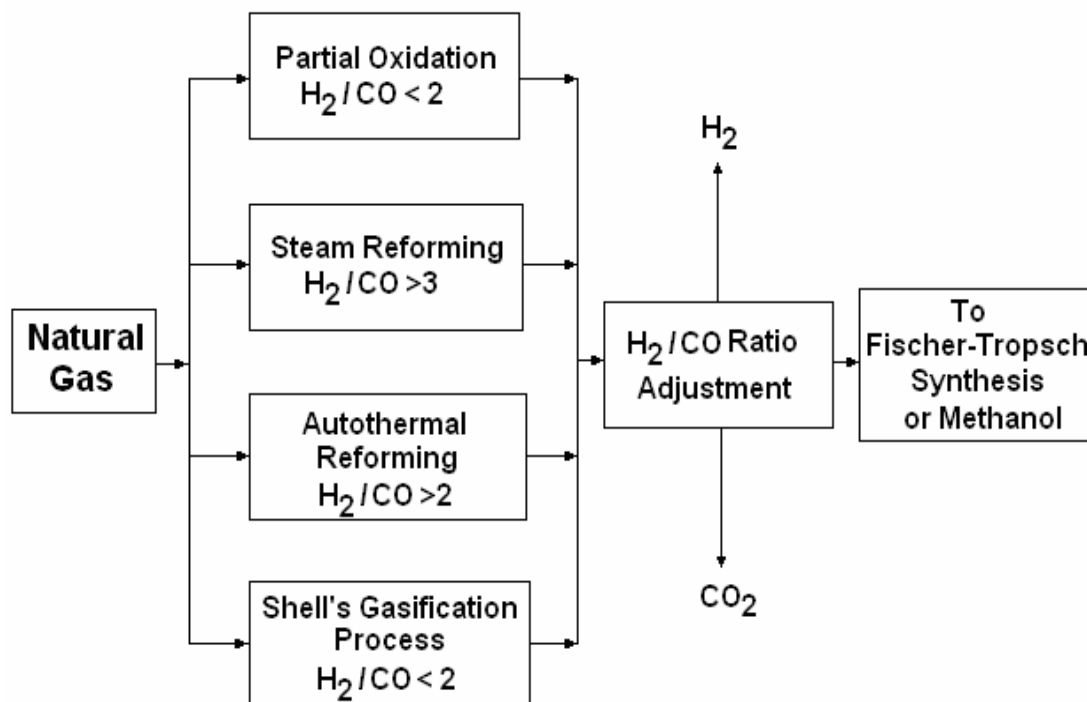

**Figure (1-8): Shell Gasification Process (SGP).**

### (5) New Ceramic Membrane Method <sup>(19)</sup>:

The U.S. Department of Energy's National Energy Technology Laboratory (NETL) has partnered with Eltron Research Corporation in Boulder, Colo., to develop a new class of dense ceramic membrane material to help streamline the process of converting natural gas to synthesis gas. The newly patented material is the key to a revolutionary gas-to-liquids technology that can combine two processes: (1) Separating oxygen from air, and (2) Reacting this oxygen with natural gas to produce synthesis gas. Synthesis gas is the reactive precursor to hydrogen and other premium liquid transportation fuels. Since the new material allows these processes to be performed in a single unit, synthesis gas production costs are lowered. Conventional processes, for producing synthesis gas use two or more energy-intensive steps and require expensive cryogenic air-separation plants. By contrast, the new catalytic ceramic membrane reactor technology eliminates the oxygen plant, combines the entire process in one unit, and does not require external energy to support the methane partial oxidation reaction. This new technology may be helpful in converting North Slope gas reserves to valuable liquid fuels at low cost.

The following diagram shows the different operations which are used to produce the synthesis gas <sup>(20)</sup>.



**Figure (1-9): Methods of producing the synthesis gas.**

The compositions by volume of the components produced by the above different synthetic processes used in forming the synthesis gas are shown in the following table <sup>(18, 21)</sup>:

Process Component	Gasification	Partial Oxidation (PO)	Steam Reforming (SR)	Autothermal Reforming (ATR)	Shell's Gasification Process (SGP)
H <sub>2</sub>	67.8	61	73 - 76	68	65.1
CO	28.7	35	17 - 12	21	34.9
CO <sub>2</sub>	2.9	3	5 - 11	10	1.7 - 3
CH <sub>4</sub>	0.6	-	1-4	0.5	1.27
H <sub>2</sub> / CO ratio	> 2.0	2.0	3.0	2.0	1.86

**Table (1-3): Synthesis Gas compositions (H<sub>2</sub>/CO ratio % by volume).**

## **5- Fischer–Tropsch Method to Produce Synthetic Fuels:**

In 1902<sup>(22)</sup> Paul Sabatier and Jean Sanderens discovered a way of converting Carbon Monoxide (CO) and Hydrogen (H<sub>2</sub>) to Methanol (CH<sub>3</sub>OH). Franz Fischer and Hans Tropsch developed this synthesis to mainly oxygenated products and hydrocarbons in 1923 using alkali-iron as a catalyst <sup>(23)</sup>.



*Dr. Franz Fischer*



*Dr. Hans Tropsch*

### *Developers of the Fischer -Tropsch Synthesis Process*

In 1925 the two German scientists further developed this reaction by converting the mixture of (CO) and (H<sub>2</sub>) which is called **Synthesis Gas** or "**Syngas**" in a laboratory to oxygenated products and liquid hydrocarbons

using Cobalt and Nickel catalysts at atmospheric pressures. They also found (which became latter as an assumption) that low pressures produced mainly hydrocarbons while high pressures produced oxygenates. In 1930 the Fischer – Tropsch reaction to make chemicals commercialized and became a process known as (F-T) process. The produced raw hydrocarbons can be refined and upgraded to different fuels like gasoline, diesel, and other products. In the mid 1930s a number of Fischer-Tropsch plants were constructed, and by 1938 over 590,000 tons of oil and gasoline were being produced annually in Germany from synthesis gas manufactured from coal. During 1930s plants were also constructed in Japan, Britain, and France. During World War II Germany operated nine F-T plants that produced 12,000 bbl/d of fuel. Those plants that were not destroyed during the war were shut down subsequently as cheap petroleum crude and natural gas became available. One country which has continued to pursue the development of indirect coal liquefaction by Fischer-Tropsch process is South Africa.

In the following years many companies like Mobile, Sasol, Shell, Rentech, ConocoPhillips, Syntroleum, and BP, have started technology developments of the Fischer-Tropsch process either in response to oil crises, or due to high crude oil price. The main purpose of these developments is to make any industrial plant use this technology to become commercially successful.

Fischer-Tropsch Synthesis (F-T) converts synthesis gas ( $\text{CO}$  and  $\text{H}_2$ ) which can be made from coal, natural gas, petroleum residues, biomass, and any carbonaceous materials to long chain hydrocarbons. If liquid petroleum-like fuel, lubricant, or wax is required, then the Fischer-Tropsch process is the right process which can be applied. This is an alternative route to obtain fuels and chemicals rather than the current dominant petroleum resources. Fischer-Tropsch synthesis now is becoming competitive to petroleum due to its improved catalysts and processes.

Currently, Gas to Liquids (GTL) is the major focus on the (F-T); however, coal to oil is still a vital solution for countries with abundant coal resources. Chemically the (GTL) in Fischer-Tropsch process is a series of catalyzed chemical reactions in which carbon monoxide and hydrogen are converted into liquid hydrocarbons of various forms. Typical catalysts used are based on iron and cobalt. The principal purpose of this process as mentioned above is to produce a synthetic petroleum substitute. The original basic Fischer-Tropsch process is as follows:

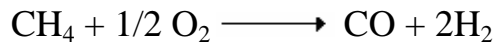

The resulting hydrocarbon products are refined to produce the desired synthetic fuel.

A chemical process generally not practiced in refining, but that is the basis indirect liquefaction of natural gas, is synthesis. Synthesis, like polymerization, is the building up of larger molecules from smaller ones. It is distinguished from polymerization in that the reacting molecules need not be similar. Fischer-Tropsch synthesis, for example, produces gasoline from synthesis gas according to the reactions<sup>(9)</sup>:

#### a- n-Paraffins:

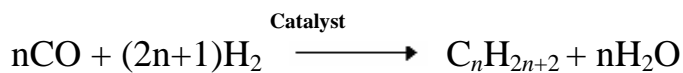

#### b- Olefins:

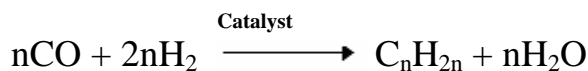

#### c- Alcohols and other oxygenated compounds:

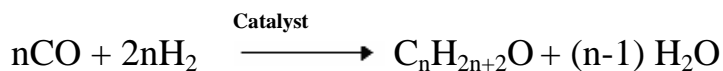

#### d- Aromatics:

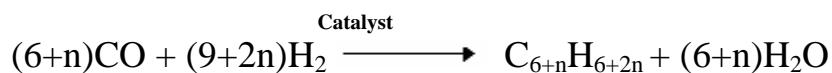

About 75 to 80 % of the useful product is **Olefinic**, with the remainder being **Paraffinic**. **Oxygenated** compounds are formed, but they usually represent a relatively small fraction of the products and are neglected in simplified schemes. **Aromatic** and cyclic compounds are formed only at temperatures appreciably greater than 300°C. Thus, by a process of complete thermal decomposition followed by a reconstruction process, an aliphatic liquid fuel having good antiknock properties can be produced.

As mentioned above most of the produced fuel is olefinic, the following simplified version of the olefin producing reaction can be considered:

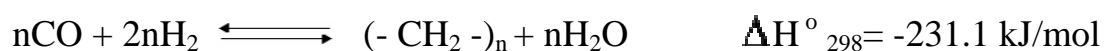

The heat of reaction is calculated assuming the hypothetical product  $(-\text{CH}_2-)$  is one-eighth of a 1-Octene ( $\text{C}_8\text{H}_{16}$ ) molecule. Oxygen is

normally rejected as steam in Fischer-Tropsch synthesis. The reaction with CO<sub>2</sub> rejection, sometimes called Kolbel reaction, is:

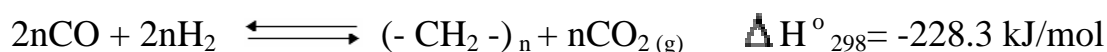

## **6- Mechanism of Fischer-Tropsch Reaction.**

The exact mechanism <sup>(93,94,95)</sup> of Fischer - Tropsch reaction is very complicated, not well defined, and subject of much debate. In order to establish a possible mechanism of the reaction, we define the reaction starting materials to be CO, H<sub>2</sub>, a catalyst site denoted as M, and dual catalyst sites denoted by MM. The observed C<sub>1</sub> products are defined as CO<sub>2</sub>, CH<sub>4</sub>, CH<sub>3</sub>OH, and H<sub>2</sub>O. The mechanism maybe divided into at least 3 major steps:

### **a- Initiation or C<sub>1</sub> compound formation by:**

- CO adsorption on metal catalyst surface (M).
- C-O bond breakage.
- Sequential hydrogenation of the carbon species to form C<sub>1</sub>.

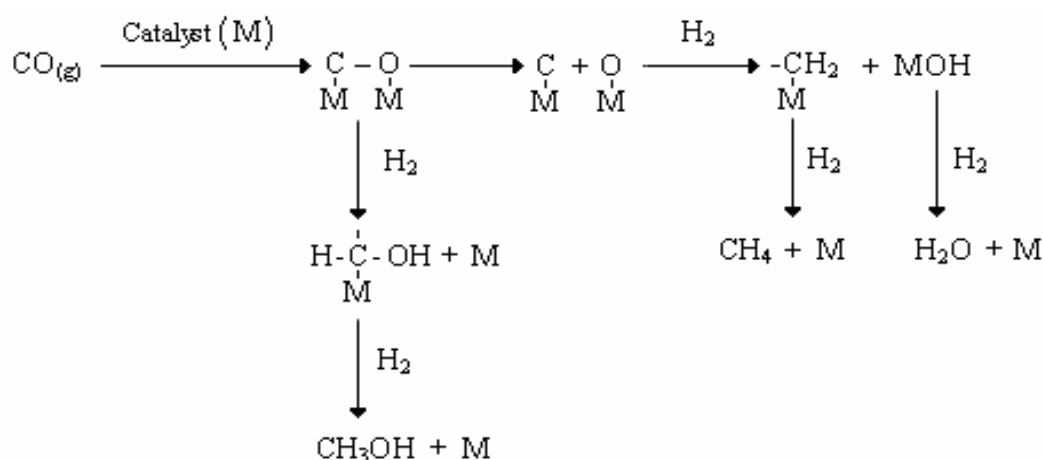

### **b- Hydrocarbon chain growth by:**

- Successive insertion of the C<sub>1</sub> building blocks to form high molecular hydrocarbons.

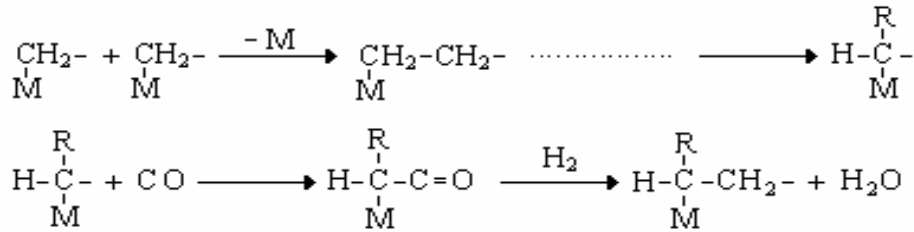

### c- Chain termination by:

- Hydrogenation and desorption of saturated species.
- Desorption of unsaturated surface species.
- Hydrogenation, hydrolysis, and desorption of oxygenated species.

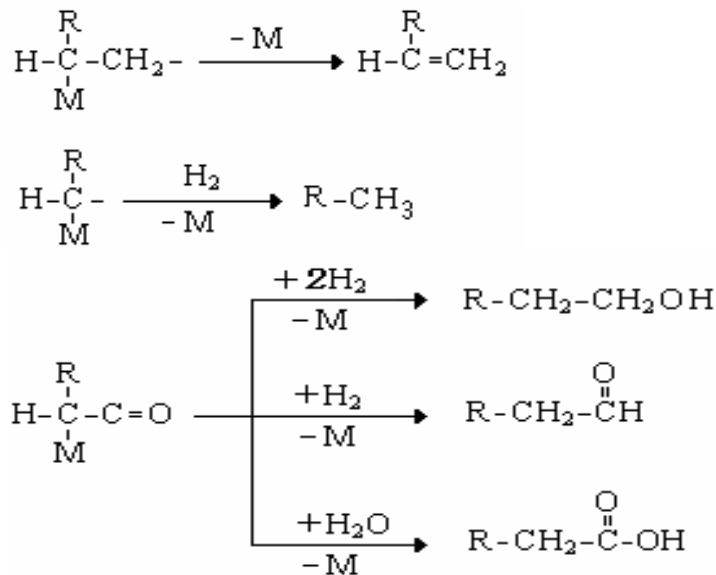

The Fischer-Tropsch reaction in which carbon dioxide is rejected (Kolbel reaction) are stated to occur as a combination of the usual reaction with steam rejection, followed by steam consumption by gas shift. The mechanism is as follows:

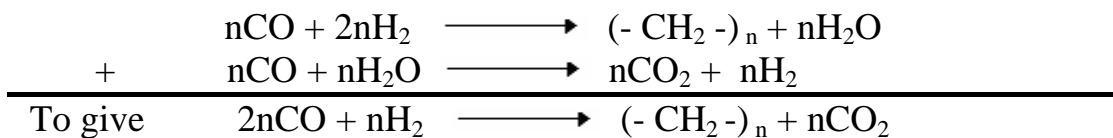

According to the Kolbel reaction, a synthesis gas with an H<sub>2</sub>/CO ratio as low as 0.5, could be used directly to produce a liquid fuel. Such a process is of considerable interest in view of its greater hydrogen economy, but problems associated with carbon deposition and catalyst deactivation have yet to be resolved. The Fischer-Tropsch reactions produce a wide spectrum of oxygenated compounds in particular, alcohols and aliphatic



hydrocarbons ranging in carbon numbers from C<sub>1</sub>-C<sub>3</sub> (gases) to C<sub>35+</sub> (solid waxes). Much work has been directed towards determining reaction conditions and developing catalysts to improve the specificity of the synthesis within the desired product spectrum. In synthetic fuel production the desired products are olefinic hydrocarbons in the C<sub>3</sub> to C<sub>10</sub> range. On the other hand, if the objective is to replace petroleum-derived chemicals with petrochemicals derived from coal, then the lower- and higher-boiling hydrocarbons, and alcohols, ketones, and acids that are co-produced with the gasoline may, after some refining, be considered essential products.

Fischer-Tropsch reactors operate within a temperature range of 225 to 365°C and at pressure from 0.5 to 4 MPa (1 MPa = 9.8692303 atm). Low temperature favor high-molar compounds, while temperatures towards the upper end of the range are used for gasoline production. Further control over selectivity is obtained by choice of synthesis gas composition, reactor residence time, and catalyst formulation. Iron, cobalt and nickel-based catalysts have been used commercially, Key factors which control the selectivity of iron catalysts are type of iron-sintered, fused, or precipitated- the basicity or amount of alkali present, and the amount of other promoters/impurities present. Potassium, aluminum, and silicon oxides are common promoters. When the process and catalyst are aimed at gasoline production, neither the H<sub>2</sub>/CO ratio of the feed gas nor temperature within the upper range appears to have a significant effect on product selectivity. A strong correlation was found, however, between the carbon dioxide partial pressure and product selectivity, with distillate fuel yields increasing with increasing carbon dioxide may be introduced with the feed gas, but is also formed within the reactors by the gas shift reaction which is in equilibrium in the high temperature reactors using iron catalyst.

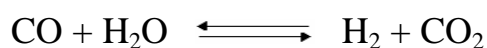

Carbon dioxide production and associated carbon deposition-by the Boudouard reaction ( $\text{C} + \text{CO}_2 \longrightarrow 2\text{CO}$ ) is not thought to be significant. Also the reaction of carbon dioxide to form a useful product,

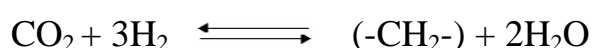

is not presented as contributing to Fischer-Tropsch synthesis.

Carbon deposition is a problem, particularly in higher temperature synthesis, and leads to swelling and attrition of catalyst. The rate of carbon deposition has been found to increase linearly with the ratio

$P_{CO}/P_{H_2}^3$ . Increasing the hydrogen content of the feed gas consequently reduces carbon deposition. Increasing the reactor pressure decreases the  $P_{CO}/P_{H_2}^3$  ratio for fixed feed gas consumption, and so reduces carbon deposition. Increasing the pressure also increases the carbon dioxide partial pressure, thus improving product selectivity and increasing reactor throughput. When the main objective is to produce distillate fuels, the feed gas  $H_2/CO$  ratio is close to 3, which is achieved by blending a high-hydrogen-content reformed tail gas with purified gasifier synthesis gas. A specific shift step is not required when using gasifiers producing a synthesis gas with a  $H_2/CO$  ratio of about 2. Product selectivity in Fischer-Tropsch processes is controlled by kinetics rather than equilibrium. At conditions prevailing in the reactors, olefins and oxygenated compounds are in fact thermodynamically unstable relative to paraffins. Primary products appear to be olefins and alcohols; increasing the residence time with further conversion to paraffins reduces alcohols but also reduces desirable olefins.

## **7- Kinds of Fischer-Tropsch Operations.**

There are two kinds of reactors used in Fischer – Tropsch units, these are:

- **Moving Bed Reactor.**
- **Fixed Bed Reactor.**

The modern Fischer-Tropsch technology <sup>(16)</sup> as applied at the present time has developed these two kinds of reactors, and they can be divided now into two operating regimes <sup>(24, 25, 26)</sup>:

### **a) High Temperature Fischer-Tropsch (HTFT):**

The High Temperature technology is using a fluidized catalyst at 300 - 330°C. Originally circulating fluidized bed units were used by Sasol. These have been called (SAS) reactors, and the operation is called Synthol Process. Since 1989 a commercial scale classical fluidized bed unit has been implemented and improved upon. The high temperature reactors produce predominantly gasoline and light olefins. A range of oxygenate chemicals (such as alcohols and ketones) are also produced and are either recovered for chemical value or are processed to become fuel components. Of the olefins ethylene, propylene, pentene-1 and hexene-1 are recovered at polymer grade purity and sold into the polymer industry. Surplus olefins are converted into diesel to maintain a gasoline-diesel ratio to match.

### **b) Low Temperature Fischer – Tropsch (LTFT):**

The low temperature technology has originally been used in tubular fixed bed reactors at 200 - 230 °C. These reactors, known as Arge reactors produce a more paraffinic and waxy product spectrum than the Synthol (SAS) units. A new type of reactor called the (SSPD) reactor has been developed and has been in commercial operation since 1993 at more than 98 % availability. The (SSPD) technology is the favored technology for the commercial conversion of natural gas to synfuels. It produces a less complex product stream than the (SAS) technology and products can readily be worked up to predominantly high quality diesel. The following table shows the percentages of different hydrocarbons produced by the above two methods <sup>(27)</sup>.

<b>Product</b>	<b>Low Temperature F-T (200 – 250 °C)</b>	<b>High Temperature F-T (300 – 350 °C)</b>
CH <sub>4</sub>	4	7
C <sub>2-4</sub> Olefins	4	24
C <sub>2-4</sub> Paraffins	4	6
Gasoline	18	36
Distillate	19	12
Oils and waxes	48	9
Oxygenates	3	6

**Table (1-4): Typical Fischer-Tropsch synthesis products distribution (% by weight)**

## **8- Upgrading Fischer-Tropsch Products.**

The products of Fischer-Tropsch synthetic operations whether they are produced from high temperature reaction (HTFT), or those of low temperature reaction (LTFT) need upgrading operations to make them suitable for using as fuels like gasoline, kerosene and diesel. The upgrading operations needed here are similar to those carried on in refineries like Hydrocracking, Reforming, Hydrogenation, Isomerization, Polymerization, and Alkylation. For hydrocarbons of less than C<sub>4</sub> atoms, Isomerization is needed to produce gasoline, while for heavy hydrocarbons of more than C<sub>20</sub> Hydrocracking is necessary to produce kerosene and diesel. For middle products, Reforming is only needed to produce high grade fuels. The following diagram shows the different upgrading operations necessary to produce good GTL fuels from Fischer-Tropsch reactions <sup>(21)</sup>.

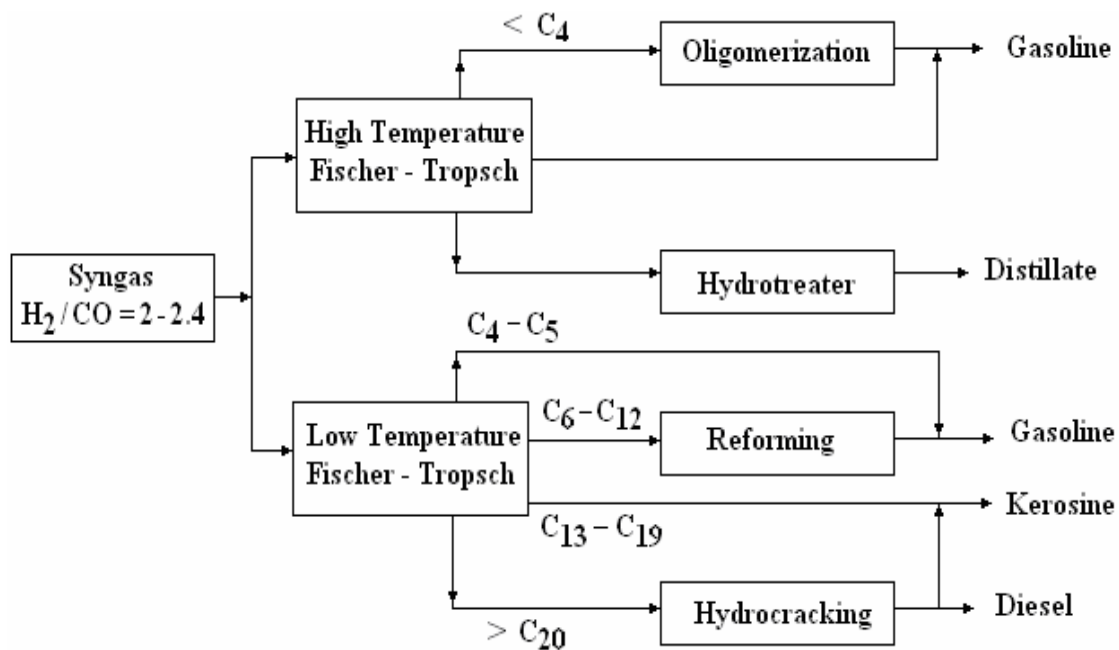

**Figure (1-10): Upgrading operations used with Fischer-Tropsch reactions.**

Fischer-Tropsch units are energy producing facilities for they produce three kinds of energy <sup>(20)</sup>, these are:

- a- Energy on a form of low energy content gas.**
- b- High pressure steam produced from the synthesis process.**
- c- Mid pressure steam produced from the Fischer-Tropsch reaction.**

The energy produced for example from a GTL unit of an 180,000 bbl/day capacity is around 1.2 GW/h <sup>(29)</sup>. GTL units also consume energy in many steps like the synthesis gas producing, air separation, and many other steps.

GTL Plants form from the biological treatment of water many side products such as Water and Bio-sludge, which can be used as fertilizers. The quantity of the water (Agricultural – Grade Water) as a side product from the GTL factories is in the proportion 1.25 bbl water/bbl products, which means that these factories produce 220,000 bbl/day of water daily. The extra thermal energy produced from the synthesis process can be used to produce electrical energy.

## **9- Specifications of the GTL Products:**

The GTL products consist manly from the following components:

- 5% Synthetic LPG.
- 20% Synthetic Naphtha.
- 20% Synthetic Kerosene.
- 55% Synthetic Diesel.

The percentages of these products increase or decrease according to the kind of technology employed, nature of the catalyst, the conditions of the reactions used, and other factors.

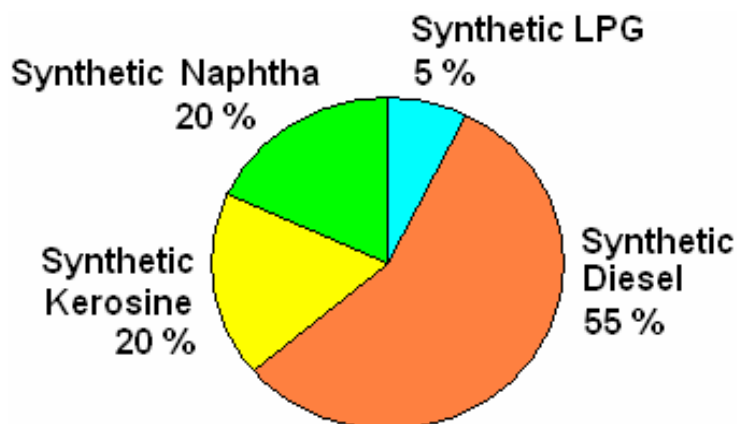

**Figure (1-11): Percentages of the GTL products.**

The properties of the GTL products are typical with regard of its combustion or its environmental affects. Since the light and mid synthetic products are the main and the most important products of the GTL industry. Therefore the significant care of the properties of these products play a great role in the promotion of the GTL industry. In general these products are free of sulfur and nitrogen compounds. Table (1-6) shows the properties of the (SMDS) light and mid products <sup>(30)</sup>.

	<b>Naphtha</b>	<b>Kerosene</b>	<b>Diesel</b>
Density (Kg/l)	0.690	0.738	0.780
IBP (°C)	43	155	200
FBP (°C)	166	190	360
Sulphur content	N/D	N/D	N/D
Aromatics (vol %)	0	<1	<1
Flash Point (°C)	N/A	42	88
Catane No.	N/A	58	75
GTL Product Quality Specifics vs. Standard	High Paraffins ~100 vs. 50%	High Smokept. ~110 vs. 25C	High Cetane 75 vs. ~48

**Table (1-6): Properties of light and mid GTL products.**

The GTL products consist mainly of paraffins with a very small quantity of aromatic hydrocarbons (< 1% by wt.). Moreover, the density of the GTL fuels is less than the density of the corresponding conventional fuels. This decline in density is due to the very low content of aromatics hydrocarbons, compared with that of the petroleum products which reach (15-30%)<sup>(31)</sup>.

The high content of paraffins and the low content of aromatics make the octane number of the GTL naphtha low, and therefore have very bad combustion properties. Nevertheless this naphtha is very good feedstock to hydrocracking unit to produce ethylene, which can be used then in polymerization unit to produce high octane gasoline. In contrary the high paraffin content makes the combustion properties of the GTL diesel very good, and gives it a high cetane number. But these properties, as well as the low density of the GTL diesel make it unsuitable to be used directly in vehicle engines without modification. Therefore the best usage of this diesel is by blending it with the conventional diesel to improve its specification<sup>(32)</sup>.

The energy content of the GTL fuel is around (47.1 MJ/kg), and this is more than the energy content of the same mass of corresponding conventional fuel by (4% - 5%). If the comparison is made by volume the result will be contrast due to the low density of the GTL fuel<sup>(32)</sup>. The advantageous properties of the GTL light and mid fuels are summarized in the following table<sup>(30, 32)</sup>.

<b>Naphtha</b>	<b>Kerosine</b>	<b>Diesel</b>
Highly paraffinic which make it excellent feedstock for Ethylene Crackers with high yield.	Superior combustion.	Reduced emission of Hydrocarbons, CO, and Particulates.
Due to its paraffinicity and purity it yields more ethylene than does refinery naphtha	Excellent Stability.	High quality blending component.
Nearly 0% sulfur content	Water Shedding Quality	Candidate for low emission standard fuel.

**Table (1-7): GTL products qualities.**

The benefits of Fischer-Tropsch reactions is not restricted to producing valuable light and mid petroleum derivatives, but it also used to produce many valuable chemicals by only altering the operation conditions to change the growth of the hydrocarbon chains.

Table (1-8) shows the different products which can be obtained from (F-T) units and their associated upgrading units <sup>(28)</sup>.

<b>Product group</b>	<b>Typical uses and applications</b>
Normal Paraffin's	Production of intermediates (LAB, SAS, alcohols). Production of intermediates for plasticizers, Auxiliary chemicals, Additives, Cutting Fluids, Sealants, Manufacturing of Film and special Catalyst Carrier and low polar odor- free all purposes Solvents and Diluents.
Mixed Paraffin's	Special low polar and odor-free solvent for paints, coating, dry cleaning, cleaners, insecticide and pesticide formulation, and drilling fluids.
Synthetic Lubricants	Industrial and automotive lubricant applications including motor oils, compressor oils, hydraulic fluids, and grease.
Paraffin Wax	Manufacturing of candies, crayons, printing inks, potting and cable compounds, cosmetics, pharmaceuticals, coatings, and packaging.

**Table (1-8): Different usages of other GTL products**

# Chapter Two

## Kinds of (GTL) Technologies



## **1- Introduction:**

It is known for a long time that the gas to liquids technology (GTL) is one of the major available routes to produce clean middle distillates from natural gas. Use of (GTL) technology for chemicals and energy production is forecast to advance rapidly with increasing pressure on the energy industry from governments, environmental organizations and the public to reduce pollution, including the gaseous and particulate emissions traditionally associated with conventional petroleum-fuelled and diesel-fuelled vehicles. In response there are initiatives by many companies worldwide to carry out R&D on the conversion of natural gas to green fuel, leading to the development of catalysts and a commercial F-T system. The technological development of GTL has advanced remarkably since the beginning of the 1990s, with its economic viability being greatly improved. One well regarded recent study from Business Communications Co., Inc. estimates total production of GTL to reach \$120 billion by 2004, growing 5.5% per year from 1999 to 2004<sup>(22)</sup>. However, it is also clear that the commercial success of GTL technology has not yet been fully established, and returns from GTL projects will depend on projections of market prices for petroleum products and presumed price premiums for the environmental advantages of GTL-produced fuels. Unit production costs will reflect the cost of the feedstock gas; the capital cost of the plants; marketability of by-products such as heat, water, and other chemicals (e.g., excess hydrogen, nitrogen, or carbon dioxide); the availability of infrastructure; and the quality of the local workforce.

The main industrial Fischer –Tropsch companies worldwide are **Sasol**, **Shell**, **ExxonMobile**, and **Syntroleum**. Sasol and Shell have existing working GTL plants in South Africa and Malaysia, while ExxonMobil and Syntroleum still have only pilot plants for research purposes. These companies have developed different kinds of F-T technologies based on different kinds of reactors and catalysts. Figure (2-1) shows the capacities of these companies GTL working and research plants worldwide (up to 2003)<sup>(33)</sup>.

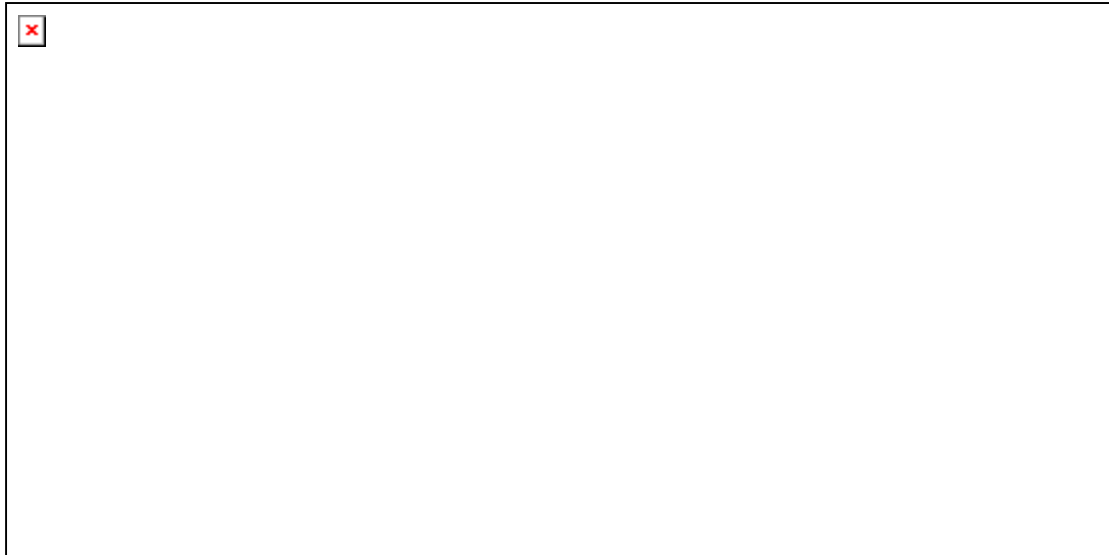

**Figure (2-1): The capacities of the existing GTL plants worldwide.**

There are other companies which are still conducting researches in GTL technology such as **Chevron**, **Rentech**, **ConocoPhillips**, **Mossgas**, **FosterWheeler**, and **Ivanho Energy**.

## **2- Sasol's GTL Technology:**

Sasol is one of the largest industrial companies in South Africa <sup>(34)</sup>. The company has an annual turnover of more than 3 billion dollars. It was founded in 1950 by the South African government, then called South African Coal, Oil and Gas Corporation Limited. The name Sasol is derived from **South African Synthetic Oil Limited**. Sasol is a synfuel technology supplier established to provide petroleum products in coal-rich but oil-poor South Africa. The firm has built a series of Fischer-Tropsch coal-to-liquids (CTL) plants, and is one of the world's most experienced synthetic fuel organizations, and now marketing a natural gas-to-liquids (GTL) technology.

In 1951 the construction of the first production facility, **(Sasol I)**, began in Sasolburg. The first plant started production in 1955. It produced fuels, waxes and gases from low-grade coal, using German Fischer-Tropsch technology. 5600 bbl/day of liquid fuels are manufactured by Sasol I <sup>(1,40)</sup>. After the 1973 oil crisis, Sasol decided to build a second coal-to-liquids plant almost 100 km east of Sasolburg, in Secunda. The construction of the **(Sasol II)** facility started in 1976, and took 4 years. In 1982 **(Sasol III)** was built in Secunda next to Sasol two. The new two plants have an output of approximately a 50,000 bbl/day each <sup>(10)</sup>.

Sasol has also developed the world's largest synthetic fuel project, the Moss gas complex <sup>(34)</sup> at Mossel Bay in South Africa that was commissioned in 1993 and produces a small volume of 23000 barrels per day <sup>(35)</sup>. In June 1999, Chevron and Sasol agreed to an alliance to create ventures using Sasol's GTL technology. The two companies have conducted a feasibility study to build a GTL plant in Nigeria that would begin operating in 2003. Sasol reportedly also has been in discussions with Norway's Statoil, but no definitive announcements have been made.

Sasol has developed several types of Fischer-Tropsch technology to convert natural gas into synthesis gas using an autothermal process. It has commercialized four reactor types to convert synthesis gas into hydrocarbons, with the slurry phase distillate process being the most recent. These four reactors are divided into two categories according to the temperature of the reaction <sup>(35)</sup>.

### a- High Temperature Fischer-Tropsch (HTFT) reactors:

#### 1) Synthol-Circulating Fluidized Bed (SCFB) reactor (Synthol) <sup>(10)</sup>:

The fluid bed system (Synthol system) operates at temperature between 330 -350°C, and is useful for the production of lighter hydrocarbons. It uses a promoted iron catalyst powder in circulating entrained flow design, as shown in Figure (2-2).

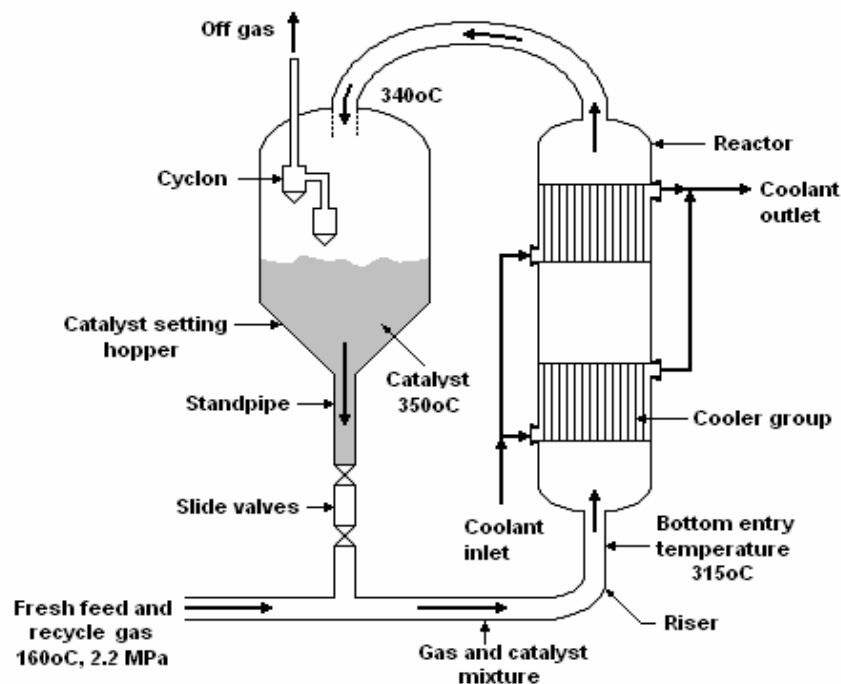

**Figure (2-2): Synthol circulating fluidized bed (SCFB) reactor**

Fresh feed gas mixed with 2 to 3 volumes of recycle gas enters at 160 to 200°C and about 2.2 MPa. The gas entrains the catalyst which is added through slide valves at 340 to 350°C. The suspension enters the fluidized bed reaction section where the Fischer-Tropsch and the gas shift reactions proceed at a temperature from 315 to 330°C. Heat released by the exothermic reactions is removed by circulating coolant within tubes inside the reactor. In the Synthol system, oil is used as a circulating coolant, and is subsequently used to raise steam. The mixture of products, reactants, and catalyst enters the catalyst hopper where the decreased gas velocity causes most of the catalyst to settle out. The gas then passes through two banks of internal cyclones in series which separate out remaining catalyst from the off gas. The off gas is scrubbed with cooled recycle oil to condense out the heavier hydrocarbons products.

The Synthol reactor was complex and needed a complex support system to cope with the circulating catalyst loads and temperature difference especially during start up. This made it expensive. The large tonnages of catalyst circulated, caused relatively high pressure drops across the reactor system. At any time only a small fraction of the catalyst in the system was used for conversion purposes. The reactor systems were prone to erosion due to the high gas velocities in the reactor which operated in the transport bed mode. These and other disadvantages pushed Sasol to develop new generation of reactors.

A wide spectrum of hydrocarbons is produced from Synthol system, of which olefins and alcohols are the primary products. These products are unstable relative to paraffins. The extent to which the products initially formed exit the reactor depends on their residence time within the catalyst particles and other reactor characteristics. Table (2-1) shows a typical Synthol reactor product slate for the general range of operating conditions discussed <sup>(10)</sup>.

Constituent	Molar formula	Mass %
<b><u>Gases</u></b>		
Methane	CH <sub>4</sub>	11
Ethene	C <sub>2</sub> H <sub>4</sub>	4
Ethane	C <sub>2</sub> H <sub>6</sub>	6
Propene	C <sub>3</sub> H <sub>6</sub>	11
Propane	C <sub>3</sub> H <sub>8</sub>	2
Butene	C <sub>4</sub> H <sub>8</sub>	8
<b><u>Liquids</u></b>		
C <sub>5</sub> - C <sub>7</sub>	C <sub>5-7</sub> H <sub>12-16</sub>	8
Light oils	C <sub>8</sub> H <sub>16</sub>	33
Heavy oils	C <sub>20</sub> H <sub>42</sub>	6
Alcohols	C <sub>2-4</sub> H <sub>6-8</sub> O	9
Acids	C <sub>2-4</sub> H <sub>4-8</sub> O <sub>2</sub>	2
Total		100

**Table (2-1): Representative selectivities for Fischer-Tropsch reactions in Synthol entrained reactor.**

The capacity of the Synthol-Circulating Fluidized Bed (SCFB) reactor is 6500 bbl/day, and nineteenth Synthol reactors were used commercially by Sasol in the period from 1955 to 2000.

## **2) The Sasol Advanced Synthol (SAS) reactor<sup>(36)</sup>:**

The Synthol system disadvantages are eliminated when using (SAS) reactor that makes use of conventional solid-gas fluidization. . For that reason between 1998 and 2000 the 16 Synthol (CFB) reactors with capacities of 6,500 bbl/day, still in use, were replaced by eight (SAS) reactors, four 8 m diameter reactors with capacities of 11,000 bbl/day each and four 10.5 m diameter reactors with capacities of 20,000 bbl/day. Two different capacity reactors were used to fit in with the train configuration used with the then existing (CFB) reactors. The capital cost of these reactors is about 40% of that of equivalent (CFB) reactor system. The (SAS) reactor, as shown in Figure (2-3), is a vessel containing a fluidized bed consisting of reduced, fused iron oxide catalyst. Synthesis gas is bubbled through the bed where it is catalytically converted to hydrocarbons that are in the vapor phase at the process conditions of about 340°C and 25 bar.

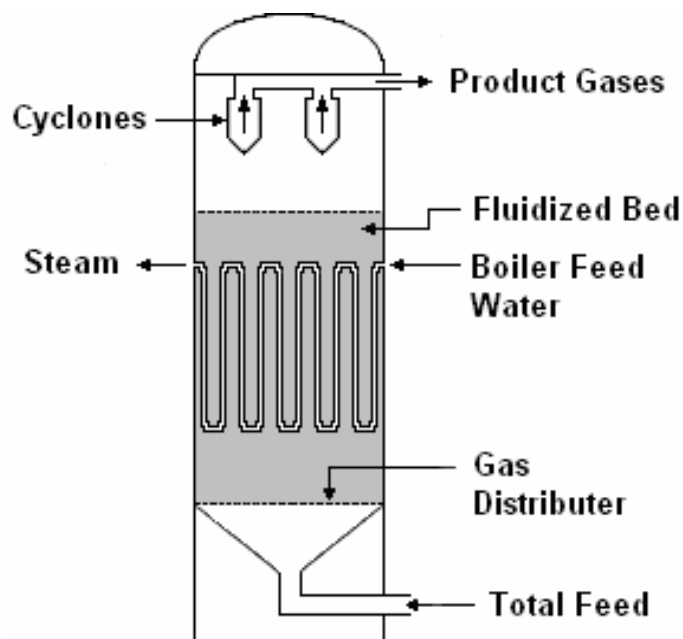

**Figure (2-3): Sasol's Advanced Synthol (SAS) Reactor.**

The heat produced from the exothermic conversion reaction is removed by passing water through tube coil installed inside the reactor, which also produces heated steam needed for the reaction. The major advantages of the (SAS) reactor over the (CFB) reactor are its simplicity, ease of operation and low operating cost due to elimination of the catalyst recycle. Catalyst consumption is reduced to about 40% and maintenance costs to about 15% of that of the (CFB) system. In general, higher conversions are obtained at higher gas loads.

## **b- Low Temperature Fischer-Tropsch (LTFT) Reactors:**

### **1) Multi-Tubular Fixed Bed (MTFB) reactor <sup>(36)</sup>:**

The multi tubular fixed bed reactor which have been used since world war II are still used by Sasol in their Arge process, and by Shell in the Shell middle distillate synthesis process. The (F-T) reaction takes place over an iron based catalyst (Sasol) in a reactor which resembles a tubular heat exchanger, as shown in Figure (2-4), with the catalyst packed in the tubes. The heat is removed through the tube walls to generate steam on the shell side of the reactor. The interaction between the generation of heat and heat removal through the walls gives rise to axial and radial temperature profile.

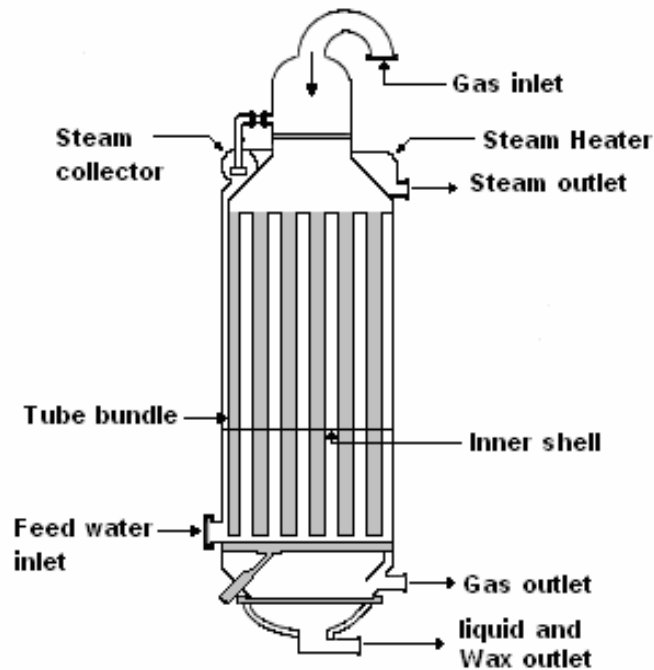

**Figure (2-4): The tubular fixed bed reactor (Arge).**

The axial temperature peaks are associated with the highest conversion rates. In effect this means that in the first meters of the 10 to 12 meters long bed, most of the reaction takes place and that after the peak relatively little conversion is achieved and catalyst is under utilized. It is also possible to distribute the conversion more evenly over the tube length by either reducing the activity of the catalyst or by reducing the average temperature or by combination of the two. In order to obtain good conversion, a high average temperature is required but this is subject to a maximum temperature for the peaks above which selectivities are negatively affected and the catalyst may be damaged especially in the extreme case of temperature run-aways. Efficient heat removal and effective temperature control at higher levels of temperature is therefore very important. Heat transfer in the bed and through the walls is much improved by increasing the gas and liquid flows in the bed. In the case where this is achieved by gas recycle, the conversion per pass is decreased but the overall conversion benefits in a large way by the recycle of the reagents and the higher reaction rates possible at higher average tube temperature. This comes at the cost of recompression of the recycle gas.

This reactor is complex and expensive. The scale up of the reactor is mechanically difficult and is complicated by the fact the iron-based catalyst has to be replaced periodically and the design of the reactor has to provide for this. This replacement is cumbersome and maintenance

and labor intensive. Cobalt-based catalyst has a long life and replacement is a less important factor.

## 2) Slurry Phase (SP) reactor <sup>(36)</sup>:

The Slurry Phase (SP) reactor as shown in Figure (2-5), consists of a vessel containing slurry consisting of process derived wax with catalyst dispersed in it. Synthesis gas is bubbled through this slurry bed and is converted to hydrocarbons. The heat generated is passed from the slurry to the cooling coil inside the reactor to generate steam. The light hydrocarbon in the vapour phase are removed from the freeboard in the top of the (SP) reactor with the unconverted reactants and condensed in the downstream condensing train. The heavier liquid hydrocarbons are mixed into the slurry from which they must be removed by means of a Solid Separation Process. In the case of Sasol this is achieved by internal devices, in a proprietary separation process developed by Sasol. The successful development of an effective and relatively cheap liquid-solid separation step was crucial to the development of the (SP) reactor.

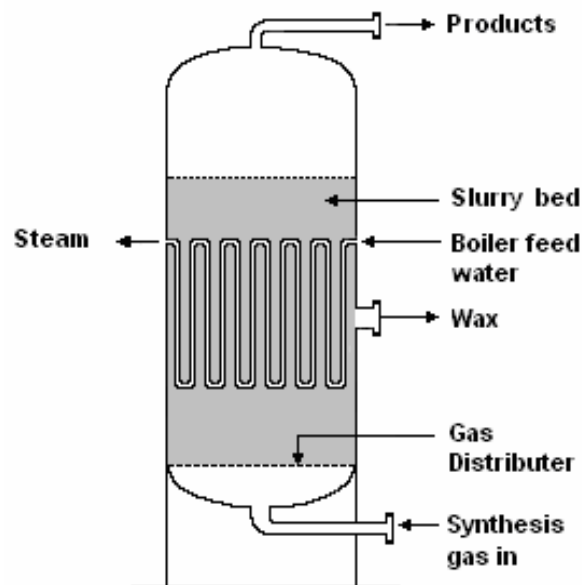

**Figure (2-5): The Slurry Phase Reactor.**

Precipitated catalyst, especially iron-based catalyst, tends to be weak. It is important that the catalyst is strong enough to prevent break up which would make the liquid-solid separation more difficult and in the extreme, impossible. A most significant process characteristic of the (SP) reactor is that it is well mixed and can operate virtually isothermally. The absence of axial and radial temperature gradients as in (MTFB) reactor, allows for much higher average operating temperature in the (SP) reactor and therefore higher reaction rates. As all the catalyst is at more optimal process conditions, the yields per



reactor volume are high even through the catalyst concentration in the (SP) reactor is lower than that for the (MTFB) reactor. Because the reactor is well mixed, the catalyst tends to see outlet gas concentrations. This has a disadvantage in terms of conversions in a once through system. Through staging inside the reactor and operating reactors in series, the disadvantages of well mixed reactor behaviour can be reduced to large extent. The pressure drop across the (SP) reactor is less than 1 bar. The (SP) reactor allows for on-line catalyst withdrawal and addition which is not feasible with (MTFB) reactor. This is especially important for Fischer-Tropsch reactors that use iron based catalyst which must be replaced periodically. On line catalyst renewal also reduces maintenance costs. Where use of cobalt catalyst, which has a longer life, this is obviously less important, but in principle the addition and withdrawal features can also be used for reactivation of cobalt catalyst if required. Because of the isothermal nature of the reactor and the much smaller pressure drops across the reactor, the control of the reactor is much simpler and operating costs are much reduced. The easier control of average catalyst life through regular catalyst renewal, allows for easier control of the process selectivities and hence the quality of the products. This is especially important for iron based catalyst.

### **3- Shell's GTL Technology:**

The Royal Dutch Shell has carried out R&D since the late 1940s on the conversion of natural gas to liquids. The group Gas & Power business processes is in the forefront of the development of the gas to liquids (GTL) industry. In 1973 it started research on a modified low-temperature Fischer-Tropsch (F-T) process, leading to the development of the Shell Middle Distillate Synthesis (SMDS) route<sup>(35)</sup>. In 1983 the first pilot plant of the (SMDS) process was built. Unlike other (F-T) synthesis routes aimed at gasoline as the principal product, (SMDS) focuses on maximizing yields of middle distillates, notably naphtha, kerosene, and gas oil. This has come about not just as a result of the abundant supply of economically priced gas but because of the global development of fuel supplies and the need to improve local air quality in many cities around the world. At the same time, increased efficiencies in the process, the ability to build bigger plants to capture economies of scale based on operational experience, have combined to make Gas to Liquids (GTL) commercially viable. The economics of (GTL) hinge on the availability of low cost gas and the cost to manufacture and distribute (GTL) products. Shell's (GTL) process, the Shell Middle Distillates Synthesis (SMDS), is currently used in Shell's Bintulu plant in Malaysia with

12,000 bbl/day capacity <sup>(37)</sup>. This is the world's first and only integrated low-temperature (F-T) plant.

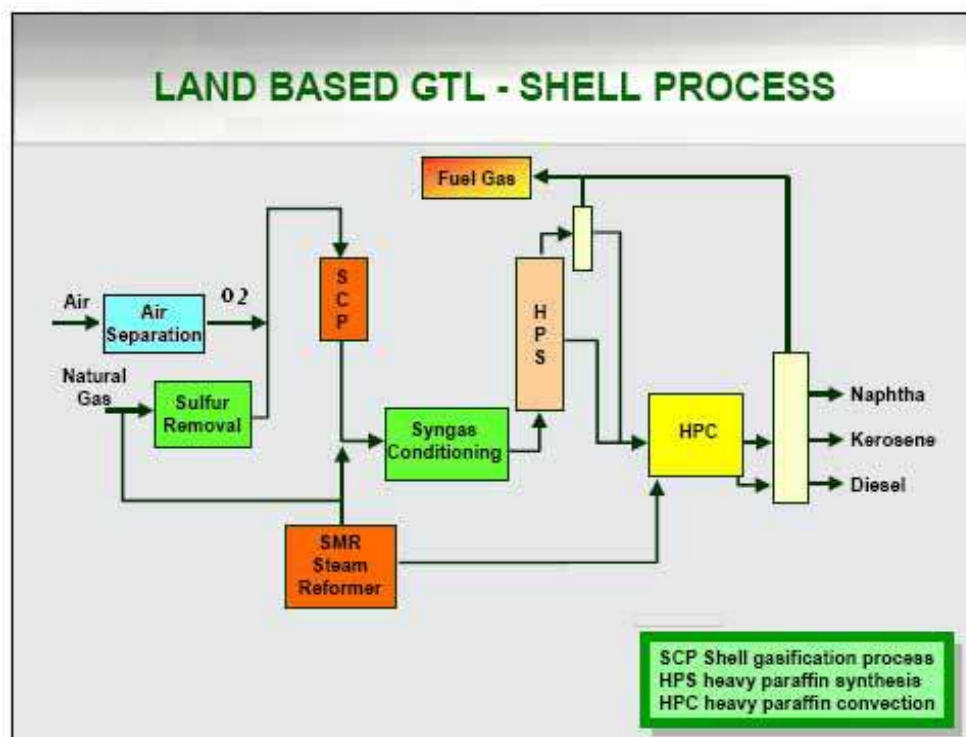

**Figure (2-6): Diagram of the (SMDS) Technology.**

The three main process stages used in (SMDS) are common to most (GTL) technologies. The process consists of three steps <sup>(35)</sup>:

- The production of synthesis gas with a H<sub>2</sub>/CO ratio of 2.
- Synthesis gas conversion to high molecular weight hydrocarbons via (F-T) using a high performance catalyst.
- Products Upgrading by Hydrocracking and Hydroisomerisation to maximize the middle distillate yield.

The products are highly paraffinic and free of nitrogen and sulfur. Synthesis gas can be produced from natural gas in several ways. The most suitable way for (SMDS) was using the Shell Gasification Process (SGP) with oxygen taken from an adjacent air separation unit. Used in commercial plants since 1956, the process has several advantages. It is a direct process without the need for a catalyst; it has very high process efficiency and is highly reliable as well as cost effective. The synthesis stage is the key to the commercial success of the (GTL) process. Here the synthesis gas reacts on an (F-T) catalyst to produce paraffinic hydrocarbons and water. High yields of desirable middle distillates products are essential for low unit cost. Traditional high-temperature (F-

T) catalysts based on iron and cobalt are best suited for production of motor gasoline and other light products. The way the catalyst is deployed in the synthesis stage is also very important. The (SMDS) process offers several distinct advantages. First, the design is comparatively simple to scale up, a crucial factor for large-scale commercial plant applications and, second, the catalyst can be regenerated in-situ. Another advantage is the ability to operate at lower temperatures with maintained reactor productivity, which results in better levels of production of higher paraffins and lower synthesis gas consumption<sup>(38)</sup>.

Building on research and development work and the operational experience of using a new catalyst at Bintulu, Shell has developed a new second-generation catalyst, which when used in the (SMDS) process produces yields of more than 90% C<sub>5</sub> selectivity. In the final stage of the (SMDS) process the raw synthesis product is hydrocracked over a proprietary catalyst and the output fractionated. In this stage, oxygenated compounds are removed and the long chain paraffins are cracked and isomerised to produce middle distillates with a small proportion of gaseous products. (SMDS) products are crystal clear and odorless liquids of a high quality and with some unique properties. (SMDS) kerosene has excellent combustion properties, stability and water shedding qualities. (SMDS) gas oil has properties that exceed all anticipated future gas oil requirements anywhere in the world. It has a high cetane, low density and negligible sulphur and polyaromatics content. In automotive applications, (SMDS) gasoil can be used either as a blend or as a neat product. As a blending component, it can bring fuels which are below specification up to the required standard and grade. (SMDS) technology can also produce specialty chemicals, such as waxes, solvents and lubricant feedstock. The Bintulu plant, in fact, produces wax so pure that the US Food and Drug Administration have approved it for use in the international food packaging industry.

Five years of operational experience with the Bintulu plant has confirmed the (SMDS) process on a commercial scale. Experience gained during ramp-up and ongoing operations provide a sound basis for the scale-up from 12,000 to 70,000, and then to 110,000 bbl/day for the second-generation (SMDS) plants. The Bintulu plant suffered an explosion in the air separation unit, which was caused by forest fires which brought about prolonged local hazy air conditions. This was unrelated to the (SMDS) technology. Lessons learned from this event were shared industrywide to avoid re-occurrence in air separation units elsewhere. The Bintulu plant was subsequently rebuilt, and the improved performance during the second start-up validated the value of prior experience. There are other

driving forces behind the current interest in (GTL). Major gas reserves are in many cases not located in the same places as major crude oil reserves. So the increased use of gas as a liquid fuel has tended to diversify energy supply sources. A recent Shell-sponsored study by PricewaterhouseCoopers shows that, compared to a crude oil refinery system, an (SMDS) system has 50% less impact on air acidification, far lower impact on smog formation and no greater impact on global warming. To ensure that the total environmental impact was assessed, the study utilized a comprehensive wells-to-wheels methodology in accordance with ISO standards. So, being both economically viable and meeting the growing market for clean fuels, the time for commercial applications of low-temperature (F-T) synthesis has now arrived. Shell is investing now US\$6 billion in (GTL) technologies over 10 years with four plants. It announced in October 2000, agreement with the Egyptian government for a 75,000 bbl/day facility and a similar plant for Trinidad & Tobago. In April 2001, it announced interest for plants in Australia, Argentina and Malaysia at 75,000 bbl/day costing US\$1.6 billion. Shell is investing now US\$6 billion in (GTL) technologies over 10 years with four plants <sup>(39)</sup>. It announced in October 2000, agreement with the Egyptian government for a 75,000 bbl/day facility and a similar plant for Trinidad & Tobago. In April 2001, it announced interest for plants in Australia, Argentina and Malaysia at 75,000 bbl/day costing US\$1.6 billion.

#### **4- ExxonMobil's GTL Technology:**

ExxonMobil was created by Exxon's 1999 acquisition of Mobil <sup>(40)</sup>. The company is involved in the exploration, production, manufacture, transportation, and sale of crude oil, natural gas and petroleum products, as well as the manufacture petrochemicals, packaging films, and specialty chemicals. The company has significant oil exploration and drilling operations in the United States, Canada, Europe, Asia, Australia, Africa, South America, and the Middle East. Exxon Mobil is looking forward to extracting hydrocarbon resources from Alaska's North Slope.

Exxon has invested more than \$600 million and 20 years in research to develop its "**Advanced Gas Conversion for the 21st Century (AGC-21)**" <sup>(41)</sup>. It has a 200 bbl/day GTL pilot plant in Baton-Rouge, USA, that has been operating until 1996. Exxon employs a three-step process <sup>(42)</sup>: synthesis gas generation by catalytic partial oxidation (PO) using Fluidized bed reactor; conversion of synthesis gas by slurry phase (F-T) reactor; and product upgrade by hydroisomerization using fixed bed reactor. Exxon claims its and proprietary catalyst systems result in high

productivity and along with significant economy of scale benefits. The process can be adjusted to produce a range of products. More recently, Exxon has developed a new chemical method based on the Fischer-Tropsch process, to synthesized diesel fuel from natural gas. Exxon claims better catalysts and improved oxygen-extraction technologies have reduced the capital cost of the process, and are actively marketing the process internationally.

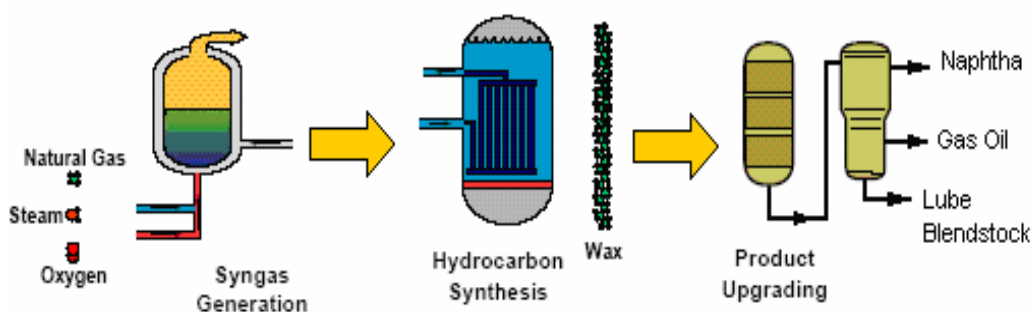

## **ExxonMobil** GTL Process

---

**Figure (2-7): ExxonMobil's GTL Technology** <sup>(43)</sup>.

The products of Exxon's GTL process are clear, colorless, biodegradable, very-clean burning liquids with low odour. Free of Sulphur, Nitrogen, Aromatics and other impurities, they are ideal feeds for petrochemical and refining applications.

ExxonMobil has aggressively defended their exclusive rights to their patents on more than one occasion. On December 20th, 2004, however, this changed. Syntroleum executed an agreement with ExxonMobil that grants it a worldwide license under "**ExxonMobil's GTL**" patents to produce and sell fuels from natural gas, coal or other carbonaceous substances. Syntroleum can now operate under their patents without fear of lawsuit. The agreement extends to Syntroleum's licensees, as well, the agreement does not include catalyst formulation, nor does it require ExxonMobil to teach Syntroleum how to use their process technology. The agreement only covers the processes and how the catalysts are managed <sup>(44)</sup>.

## **5- Syntroleum's GTL Technology:**

The Syntroleum Corporation of the USA is marketing an alternative natural-gas-to-liquids technology based on the F-T process <sup>(45)</sup>. The Syntroleum Process is a process for converting natural gas into synthetic

oil which can then be further processed into fuels and other hydrocarbon-based products<sup>(45)</sup>. The process is based on two primary steps:

**a) The conversion of natural gas into synthesis gas.**

In the first step in the process, natural gas is reacted with air in a proprietary auto-thermal-reformer reactor to produce a nitrogen-diluted synthesis gas, consisting primarily of carbon monoxide and hydrogen.

**b) The conversion of synthesis gas into synthetic crude.**

In a reaction based on Fischer-Tropsch chemistry, the synthesis gas flows into a reactor containing a proprietary catalyst developed by Syntroleum, converting it into synthetic hydrocarbons commonly referred to as "Synthetic Crude Oil".

This process is claimed to be competitive as it has a lower capital cost due to the redesign of the reactor; using an air-based autothermal reforming process instead of oxygen for synthesis gas preparation to eliminate the significant capital expense of an air separation plant; and high yields using their catalyst. It claims to be able to produce synthetic crude at around \$20 per bbl.

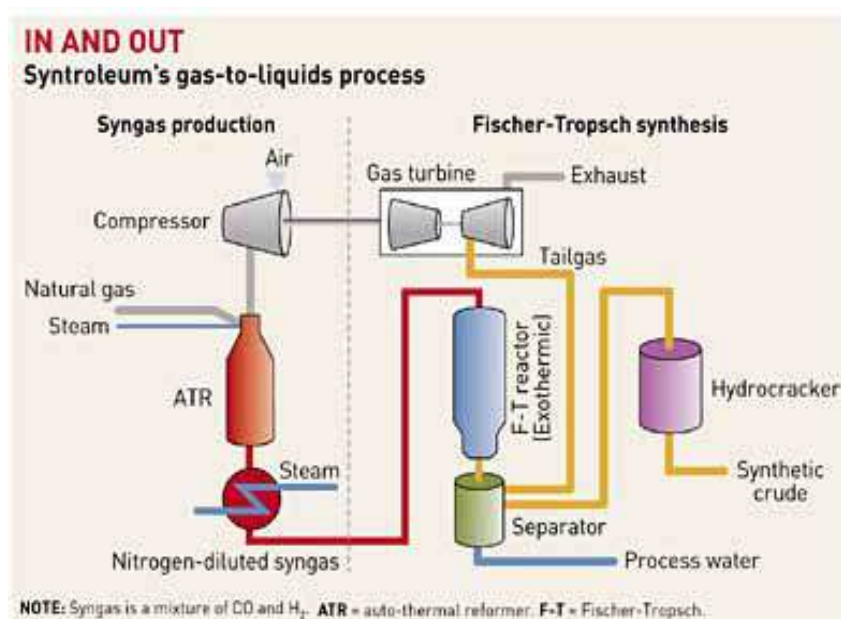

**Figure (2-8): Syntroleum GTL process<sup>(46)</sup>.**

The syncrude can be further subjected to hydro-cracking and fractionation to produce a diesel/naphtha/kerosene range at the user's discretion. Syntroleum Corporation now also licenses its proprietary process for converting natural gas into other synthetic crude oils and

transportation fuels. In February 2000, Syntroleum Corporation announced its intention to construct a 10000 bbl/day (requiring 800000 tonnes per year of gas) natural gas-to-liquids plant for the state of Western Australia to become the first location in the world to acquire full access to Syntroleum technology. The small scale of the proposed plant is because the autothermal partial oxidation with air and a once-through reactor design has not yet been proven. The project plans to produce synthetic specialty hydrocarbons (polyalphaolefins lubricating oils), naphtha, normal paraffins and drilling fluids. It is estimated to cost US\$500 million generating sales of around US\$200 million per year at constant prices. The process is designed for application in plant sizes ranging from 2000 bbl/day to more than 100000 bbl/day. Current licensees include ARCO, Enron, Kerr-McGee, Marathon, Texaco, Repsol-YPF and Australia. The company has advised that it is "working on development plans" for gas-to-liquids specialty chemicals plant and is working with DaimlerChrysler to develop super-clean synthetic transportation fuels. The project is helped by \$60 million of Australian government funding. The small scale of the proposed plant is because the autothermal partial oxidation with air and a once-through reactor design has not yet been proven. The smaller scale also avoids the marketing risk of placing large volumes of specialty chemicals and waxes in the marketplace dominated by large suppliers such as Sasol and Shell. The appeal of the liquid products, which would be straight chain hydrocarbons, is that they would be free from sulfur, aromatics and metals that can help refiners to meet new guidelines for very low sulfur fuels and general environmental standards. The naphtha however would be low in octane and requires isomerising or reforming if used as a fuel but represents a good petrochemical feedstock. The diesel will have a very high cetane number and be a premium blending product. For reasons of their purity, these synthetic fuels could also be used for fuel cells instead of methanol. As an alternative to fuels, the waxy portion can be converted to lubricants, drilling fluids, waxes and other high value specialty products.

Since Syntroleum GTL technology does not need free Oxygen as an oxidizing agent and uses air instead, the road become accessible to reduce the size and the capacity of the GTL plants. Syntroleum managed to build small GTL plants of production capacity between 2,000-10,000 bbl/day. Some of these plants are portable and can be installed on floating barges to be used with small or far see natural gas fields<sup>(28)</sup>.



**Figure (2-9): The design of the Syntroleum GTL floating barge** <sup>(48)</sup>

## **6- Other GTL Technologies:**

In addition to the above companies, there are other companies which are researching in the field of GTL technology to achieve an economical and competitive way to synthesis oil fuels from natural gas. These companies briefly are:

### **a) Chevron GTL Technology:**

Chevron is the fifth-largest integrated energy company in the world, and the second largest integrated petroleum company in the United States. It is headquartered in San Francisco, and conducting business in approximately 180 countries. The company is engaged in every aspect of the oil and natural gas industry, including exploration and production; refining, marketing and transportation; chemicals manufacturing and sales; and power generation <sup>(49)</sup>. **Isocracking** is a Chevron proprietary process used to upgrade waxy syncrudes, by separating heavier molecules, which are usually solid at room temperature, then rearranging them so they become liquid. This process yields a lighter, premium fuel, such as synthetic fuels and naphtha, that contain virtually no sulfur, little nitrogen or carbon monoxide.

Chevron and Nigeria National Petroleum Corporation (NNPC) have announced they plan to build a GTL products plant adjacent to Chevron's Escravos Gas Plant (EGP) in Nigeria. The Escravos Gas Plant (EGP) is Nigeria's first commissioned plant dedicated to utilizing natural gas produced in association with crude oil. Preliminary design and engineering have been completed on the Nigeria GTL facility, which will



be capable of converting natural gas into synthetic crude oil for further processing into commercial products - principally high-quality naphtha products and premium fuels. The capacity of the project will be 30000 bbl/day diesel & naphtha from two trains, and is planned to startup in 2004.

In June 9 1999, an MOU was signed between Chevron and Sasol to form a global joint venture to implement GTL ventures <sup>(50)</sup>. Sasol's F/T technology and Chevron's Isocracking technology offer a unique combination of world class technologies to establish GTL as a successful, global business; The Global Joint Venture is called Sasol Chevron Holdings and is a 50/50 joint venture. Chevron's international upstream and downstream technologies, experience and resources, combined with Sasol's F/T technologies and experience, opens up new options and markets for dealing with uneconomic gas and potentially enables the exploration and development of gas reserves world-wide, especially in areas with no gas infrastructure or markets. The first venture will be in Nigeria.

### **b) Rentech GTL Technology:**

Rentech of the Colorado USA has been developing (F-T) process using molten wax slurry reactor and precipitated iron catalyst to convert synthesis gas produced from natural gas, coal, refinery bottoms, industrial off-gas and other hydrocarbon feedstocks into clean, sulfur-free, and aromatic-free alternative fuels, naphthas and waxes <sup>(51)</sup>. In their process, long straight chain hydrocarbons are drawn off as a liquid heavy wax while the shorter chain hydrocarbons are withdrawn as overhead vapors and condensed to soft wax, diesel fuel and naphtha. The ability of Rentech GTL Technology to convert this broad range of materials is one important advantage of its technology compared to other GTL technologies. Rentech technology is based on the original Fischer-Tropsch technology, with several developments that make it unique. Special unique aspects of its technology are the formulation of its catalyst, the method of deployment of the catalyst in the synthesis gas reactor, design of the reactor and configuration of the process. These features are proprietary to it, and some of them are patented by Rentech. Rentech's patented, iron-based catalyst provides several advantages that reduce the costs of its technology.

The ability of the Rentech GTL Technology to convert carbon-bearing gases into valuable liquid hydrocarbons was first established in its original pilot plant. This was a small, skid-mounted system operated periodically between 1982 and 1985. This capability was again demonstrated in a second and larger pilot plant operated during 1989.

Additional confirmation of several significant aspects of the Rentech GTL Technology was obtained from tests conducted between 1991 and 1998 in a third pilot plant. They continue to use their third pilot plant at their F-T testing laboratory to further advance development of the Rentech GTL Technology and to develop F-T data in response to inquiries from their licensees and prospective licensees. Perhaps the most important feature of any gas-to-liquids technology is the cost of each barrel of liquid hydrocarbons produced by plants using the technology. The cost per barrel includes the cost of the feedstock, the amortized cost of the plant that uses Rentech GTL Technology, and the operating cost of the plant.

For widespread acceptance of any GTL technology, Rentech anticipates that the cost per barrel probably must be not much more than the cost of similar, conventionally refined oil and gas products. While Rentech believes that its GTL Technology can be cost-effective, the costs of their products will not be reliably established until a commercial-scale plant using Rentech technology is in production. Use of the Rentech GTL Technology in a commercial-scale GTL plant was successfully demonstrated in 1992 and 1993. Based on successful demonstrations of its technology, Rentech believes it is ready for use on a commercial basis in the proper circumstances. It is promoted as suitable for remote and associated gas fields as well as sub-pipeline quality gas. During 2000, the company acquired a 75000 tone per year methanol plant in Colorado, USA for conversion into a GTL facility producing an 800 to 1000 bbl/day of aromatic free diesel, naphtha and petroleum waxes. The facility, the first in the US will cost about \$20m to convert. Significantly, it will cost around 50 per cent less than a greenfield site because the methanol plant includes a synthesis gas generation unit. Start-up was scheduled for mid-2001.

### **c) ConocoPhillips:**

From their beginnings in the early days of the oil industry, Conoco Inc. and Phillips Petroleum Company grew and prospered, becoming leaders in the global energy industry <sup>(52)</sup>. On August 30, 2002, they combined their complementary strengths and shared values to create ConocoPhillips. ConocoPhillips is headquartered now in Houston, Texas, and operates in more than 40 countries. It is the third largest integrated energy company in the United States, based on market capitalization, oil and gas proved reserves and production; and the second largest refiner in the United States. Worldwide, of non-government controlled companies, ConocoPhillips has the eighth largest total of proved reserves and is the fifth largest refiner in the world.

ConocoPhillips initiated a GTL research and development program in 1997 that has shown encouraging results in the synthesis gas, Fischer-Tropsch and hydroprocessing technology areas. ConocoPhillips began operation of a 400 bbl/day GTL demonstration plant in Ponca City, Oklahoma, in July 2003. The demonstration plant is designed and operated to assure successful technology scale-up and reliable commercial plant operation. Since 1997, Conoco Inc. has designed, manufactured and tested over 5,000 catalysts. A diverse team of more than 100 scientists, engineers and technicians has been recruited from industry and academic institutions around the world (18 different countries) to develop cost-effective solutions for converting natural gas into commercial sources of high-value, ultra-clean hydrocarbon products... the fuels of the future. Conoco's GTL process uses feedstock oxygen and natural gas to produce premium diesel and naphtha. It is superior in a number of ways, the most fundamental being productivity. The Conoco process creates more products and less waste. Its proprietary catalysts in the synthesis and Fischer - Tropsch processes are the key. By using more efficient catalysts, Conoco GTL achieves a higher methane conversion and reduces the amount of recycle. Conoco has the most efficient and the least expensive gas conversion technologies available among the major companies developing GTL technologies. The following two pictures show how cost-effective the Conoco's GTL technology compared with other GTL technologies<sup>(53)</sup>.

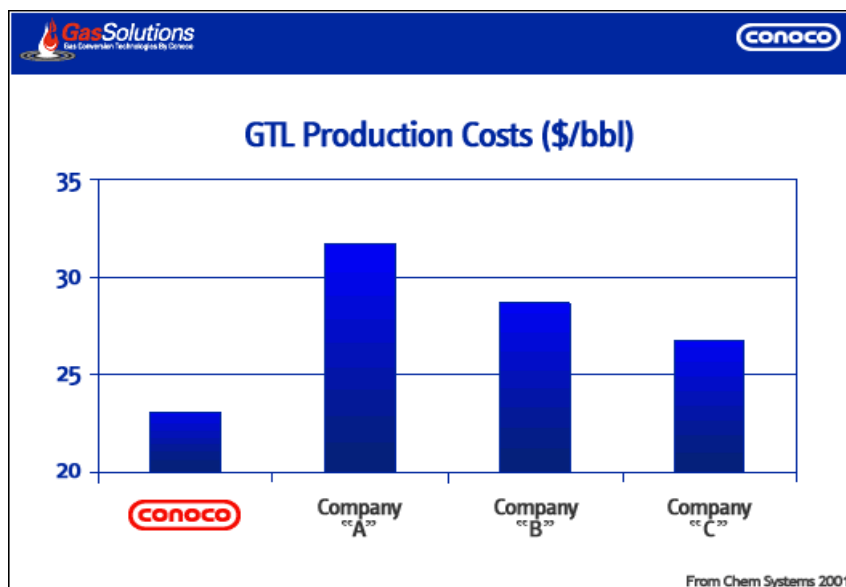

**Figure (2-10): The cost of Conoco's GTL barrel of liquids compared with other technologies**

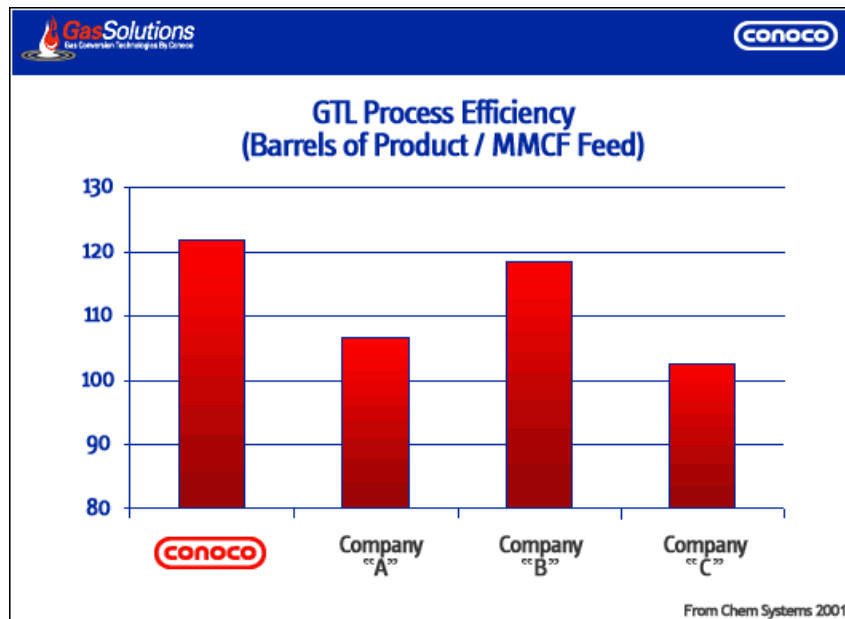

**Figure (2-11): The productivity of the Conoc's GTL technology compared with other companies productivities**

In December 2003, Qatar Petroleum and ConocoPhillips signed a Statement of Intent (SOI) regarding the construction of a gas-to-liquids (GTL) plant in Ras Laffan, Qatar. The SOI initiates detailed technical and commercial pre-FEED (front-end engineering and design) studies and establishes principles for negotiating a Heads of Agreement for an integrated reservoir-to-market GTL project. This project represents another important step towards the optimal utilization of Qatar's hydrocarbon resources by setting up oil and gas-related projects and diversifying sources of national income while creating development opportunities for the welfare and prosperity of Qatar<sup>(54)</sup>.

#### **d) Ivanhoe Energy:**

Ivanhoe Energy of Canada holds a master license for the use of a proprietary GTL process from Syntroleum Corporation, securing rights to use its process to convert natural gas into transportation fuels on an unlimited number of projects around the world. This cost-effective process uses compressed air instead of pure oxygen to facilitate the conversion reaction, which substantially reduces the capital costs and vastly improves the safety of the process plants<sup>(55)</sup>.

Ivanhoe Energy incorporated a new subsidiary company in Japan to facilitate the participation of Japanese companies in the Gas-to-Liquids (GTL) project. GTL Japan Corporation (GTLJ) is currently 100% owned by Ivanhoe Energy of Canada<sup>(56)</sup>. (GTLJ) is negotiating in Qatar to build joint GTL projects. (GTLJ) will be assigned up to 5% of the Qatar project once a contract for the project is signed. The proceeds from the

investment by Ivanhoe and participating Japanese companies will be used to fund approximately US\$150 million required for front-end engineering and other pre-development studies prior to beginning the construction phase of the project. Several major Japanese companies have already expressed preliminary interest in such participation in (GTLJ). The GTL project that Ivanhoe is negotiating will include the development of natural gas reserves in Qatar's huge offshore North Field; the construction of a NGL plant to produce 78,000 barrels per day (bbl/day) of condensate, 24,000 bbl/day of propane and 16,000 bbl/day of butane; and the construction of a modular GTL plant to produce 180,000 bbl/day of ultra-clean naphtha and diesel fuel. The total cost of the project will be approximately US\$5 billion. After signing the contract (GTLJ) will invite Japanese companies from refining and distribution, exploration and production, trading and manufacturing segments to acquire equity positions in (GTLJ).

In March 2004, a technical delegation from Ivanhoe Energy Company visited the Iraqi Ministry of Oil (MOO) to discuss ways of cooperation in the field of GTL technology. The delegation has made several presentations to show their progress in developing the GTL technology<sup>(29)</sup>. The company has clarified that since 1995 they worked with the cooperation of Syntroleum Company to economize the GTL technology, and eventually great results were achieved with regard to this issue. The cost of a barrel of GTL products produced by the company in a unit of 20,000 bbl/day capacity at the time of the presentation does not exceed 10.45 \$/bbl, compared with 29 \$/bbl of that produced from petroleum refineries. The specifications of the products also comply with the European standards and Kyoto convention. The following table shows different kinds of GTL technologies, and the catalysts used with them<sup>(9)</sup>.

<b>Company</b>	<b>Synthesis Gas Preparation</b>	<b>F-T Reactor</b>	<b>Catalyst</b>
Sasol	Coal Gasification	Fluidized	
	PO with O <sub>2</sub> , SR	Slurry	Fe, Co
Shell	PO with O <sub>2</sub>	Fixed	Co
Exxon	CPO with O <sub>2</sub>	Slurry	Co
Syntroleum	ATR with air	Fixed	Co
Rentech	PO with O <sub>2</sub> , SR, ATR	Slurry	Fe
IvanhoeEnergy	ATR with air	Fixed	Co

**SR = Steam Reforming, PO = Partial Oxidation, CPO = Catalytic Partial Oxidation, ATR = Autothermal Reforming**

**Table (2-2): Different kinds of GTL technologies**

## **7- GTL Plants:**

There are many kinds of Gas to Liquids units which differ according to their production capacity, the task of installing, the region of installing, fixed or mobile ... etc.

### **a- Large Gas to Liquids (GTL) plants:**

These are large plants which have a production capacity greater than 30,000 bbl/day. This category of plants includes the second generation of Sasol's plants (Sasol II and Sasol III) which have a capacity >50,000 bbl/day, as well as the new plant installed by Sasol-Chevron in Escravos in Nigeria which have a production capacity of 34,000 bbl/day. There are many GTL plants belong to this category which are under construction in many countries around the world especially those plants which are built now in Qatar. These plants are distinguished by its low capital cost which is reflected positively on the prices of their products.

### **b- Mid size Gas to Liquids (GTL) plants:**

This category of GTL plants has a production capacity between 5,000 - 30,000 bbl/day. It includes the first generation of Sasol's plant (Sasol I), and the Mossgas plant in South Africa. It includes also Shell's plant in Bintulu in Malaysia which has a production capacity of 12,500 bbl/day.

### **c- Small Gas to Liquids (GTL) plants:**

These are GTL plants which have a production capacity <5,000 bbl/day. They are subdivided into two categories:

#### **(1) Small GTL production units:**

They are small GTL units which are designed to deal with small or remote gas fields. They can be used also with associated gas where the direction of the natural gas pipeline is changed from the flare to the GTL unit. They have a capacity of 1,000 – 5,000 bbl/day, and they are of two kinds fixed or mobile units. Recently a new generation of mobile GTL units are designed which can be transported by big trucks from one field to another according to the production plans, for instance the unit invented by Alchem which is shown in Figure (2-12)<sup>(43)</sup>. These units can be hired for a certain period, especially when the capacity of the field is not big enough to install a fixed unit.

The continuous development of the GTL plants has decreased their capital cost to the minimum, as it does not exceed now 22,000 \$/bbl/day for this kind of units<sup>(57)</sup>. This development reflects

positively on the price of the GTL products. The main factor which makes this progress possible is the substitution of air as an oxidizing agent instead of free oxygen in the synthesis gas production reaction, which helps also in dimensioning the unit size.



**Figure (2-12): Small mobile GTL unit designed by Alchem**

### **(2) GTL pilot plants:**

These are small GTL plants designed to implement scientific researches. The production capacity of these units does not exceed 1000 bbl/day. The companies also use these units to implement demonstrations to show their GTL technologies, and the progresses which they have achieved in this field<sup>(44)</sup>, especially when they intend to sign contracts with other parties.

### **d- Offshore GTL Plants:**

Recently new generations of GTL plants, which can be used with offshore natural gas fields are constructed. Usually the production capacity of these plants are categorized between the mid and the small GTL plants, i.e. of capacity between 2,000 – 10,000 bbl/day. These kinds of GTL plants are divided into two parts:

#### **(1) Fixed offshore GTL plants:**

They are GTL plants which are installed in fixed platforms similar to those used in the production of oil in the north sea. They are feedstocked directly from the offshore free or associated natural gas. The GTL products then can be transported by pipelines or ships to the onshore markets.



**Figure (2-13): Offshore GTL plant <sup>(58)</sup>.**

**(2) GTL Ships and Barges.**

There are some small offshore gas fields that do not worth investment through installing GTL plants on fixed platforms, because this will not be economical. Therefore small GTL units of capacity between 2,000 – 10,000 bbl/day are built on ships or barges, in order to be moved to these fields. Examples of these units are those built by STATOIL and Syntroleum companies.

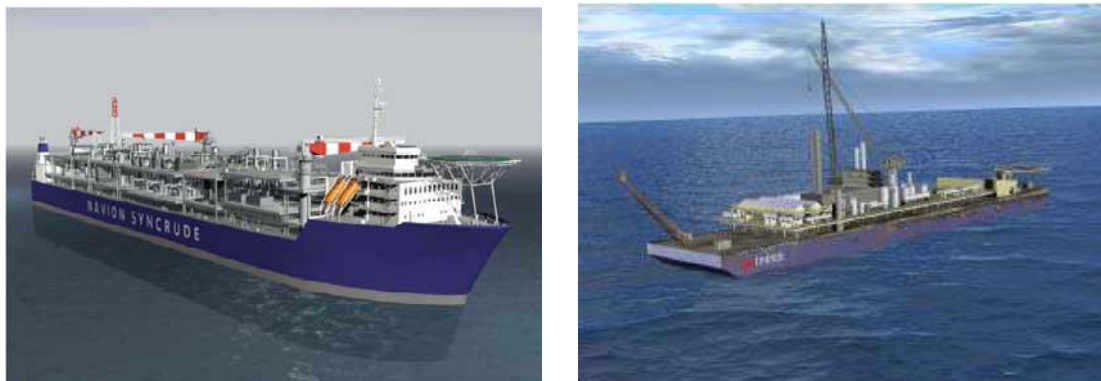

**Figure (2-14): Small GTL units carried by ships and barges <sup>(59, 60)</sup>**

The following table shows the properties of the different GTL plants <sup>(35)</sup>.

	<b>Small Plant</b>	<b>Mid Size Plant</b>	<b>Large Plant</b>
<b>Capacity (bbl / day)</b>	<5,000	5,000 – 30,000	>30,000
<b>Gas conversion rate (Mcft / bbl) &gt;13</b>	11	<10	
<b>Gas required (Tj/day)</b>	70	350	500
<b>Min reserve for 20 years (Tcft)</b>	0.5	3	5
<b>Typical cost (A\$)</b>	400 m	1700 m	2600 m

**Table (2-3): Properties of the GTL plants of different capacities**



# **Chapter Three**

## **Gas to Liquids (GTL) Economics**

## **1- Introduction:**

The operating costs of Gas to Liquids (GTL) technology are coming down steadily, and every year there seems to be one company or two that has patented a new and cheaper process. Since its foundation, it was clear to all specialists that any GTL project is economic only when the cost of its barrel of products is not more than the cost of that produced from crude oil refining. This fact was much far to achieve during the twentieth century, in spite of all the developments of the GTL technologies. Moreover, the volatile nature of oil prices makes the matter understandable why investors have been so slow to act. This uncertainty about world oil prices, rather than the technology has served to limit GTL investment till the end of the previous century, where the situation started to change since then. In addition to that, the changes in cost components of GTL project from one country to another according to different local conditions could also influence the GTL products prices. The initial gas to liquids complexes implemented in the 1980s and early 1990s were not commercially successful for a number of reasons, the main one was that they were far too expensive to construct. Recent strides in processing, catalyses, and plant operations are eventually making the technology commercially viable, nearly after 75 years after the development of the original Fischer-Tropsch process. Also by the beginning of the new century the oil prices started to rise sharply especially after the year 2003. The price has exceeded \$70 per barrel by the mid of 2005, and it settled near \$60 by November of the same year and stayed at that level till now. The reasons of this sharp ascending in oil price are not clearly understood, but the high demands of crude oil, and the decline in productions in some fields could be some of the reasons. These changes in oil prices made the GTL technology not only economic but also very much profitable. Therefore, the investment in this field becomes attractive to many countries and companies to cover some of the fuel demands, and to reduce the gas flaring.

GTL fuels used for transport should attract in theory a premium price as they have been shown to reduce vehicle exhaust emissions. The extent of that premium will be dependent on the outlook of environmental legislation in key markets. Billions of dollars were allocated, and huge contracts were signed during the first five years of the present century in many countries to build GTL projects, especially in countries of giant gas resources like Qatar. The increases in crude oil prices have changed the picture of the GTL industry as an unprofitable industry. The history is repeating itself, for as happened in the seventies when the increases in the oil prices made the opportunity suitable for the North Sea' crude oil

investment, it is possible now that a similar occasion would make the same opportunity for GTL investment. Many countries like Qatar, Iran, Egypt ...etc, are aware of this new situation, and they start to look carefully toward their natural gas resources. GTL technology has opposers as well as supporters, and the excuse of its opposers is that crude oil is more economic. Definitely, any investor in the field of GTL will look directly toward its profits, rather than an "environmental" project to reduce flaring, whose economics are somewhat different. And now after the price of the crude oil exceeding 70\$ per barrel there is no serious excuse in the hand of the GTL opposers.

## **2- Process Challenges and Drivers of a GTL Plant:**

In any process optimization exercise the question of capital versus operating costs always arises. For conventional projects like refineries, gas plants or LNG plants, the optimal point is reasonably well understood. For GTL, this is not necessarily the case, due largely to the nature of the process itself. The 'conventional' plants consume energy whereas F-T plants are energy producers whilst also consuming very large quantities of energy, mainly for air separation. Figure (3-1) shows the portioning of negative cash flow for a GTL plant<sup>(61)</sup>.

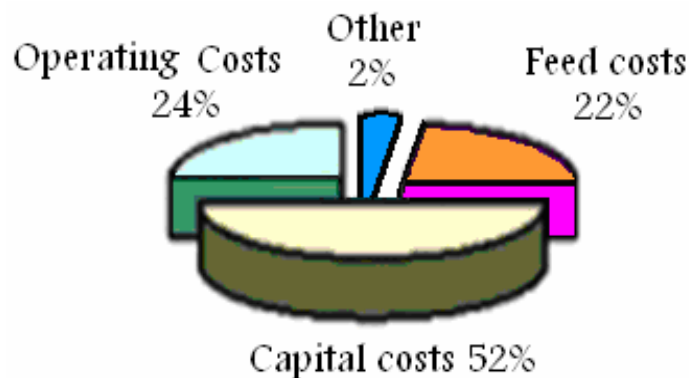

**Figure (3-1): Cash flow breakdown of a typical F-T GTL project**

It was found from studies conducted by different companies that the capital cost is clearly the dominant factor. However, the feed and operating costs also constitute a significant portion of the cash flow, so capital cost reduction can only be driven down so far; otherwise, that reduction will affect feedstock consumption adversely. What results from this analysis is a "self integrated" GTL plant, one which uses its produced energy to meet its own demands yet does not invest capital to make energy available for export. This configuration has proven to be an optimal model for F-T plants. The model also fits in with the standalone

application that many of the plants will have for remote gas utilization. This however dose not preclude energy exports when favorable economic conditions exist, but it dose show that the GTL plant viewed as an abundant source of free energy is a myth.

### **a- Capital costs of a GTL plant:**

In the eighty's of the previous century the capital costs for a GTL project of 30000 bbl/day capacity was around 70000 \$/bbl/day, and then dropped to 30000-20000 \$/bbl/day in the early nineteen's. This range of capital costs for GTL projects were in a range of double that of refineries (refinery costs of 12000-14000 \$/bbl/day). The following picture shows the descending of the GTL capital costs according to the developments accomplished by Sasol company<sup>(33)</sup>.

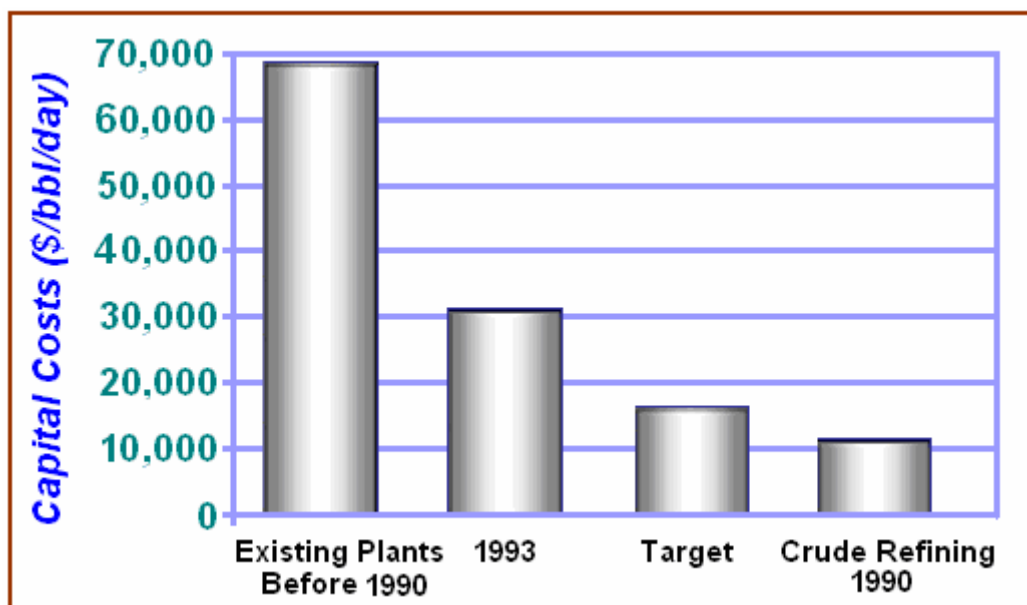

**Figure (3-2): The declining of the capital costs of the GTL projects.**

The cost of GTL produced fuel could vary by approximately \$1.50 per barrel with a shift of \$5000 in capital cost. Estimates of the crude oil prices necessary to allow positive economic returns from a GTL project varied widely at that time, with optimistic estimates ranging as low as \$16 to \$18 per barrel. More typical estimates indicated that expected oil prices would have to average over \$20 per barrel on a sustained basis to lead to commitments for large-scale projects. The following figure shows the capital costs breakdown of a GTL plant.

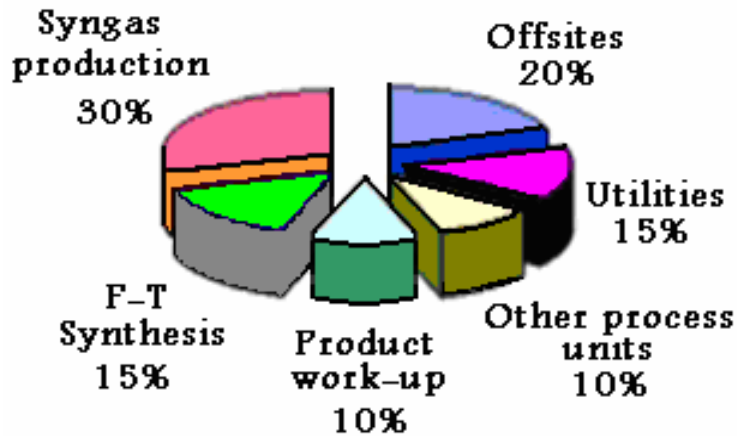

**Figure 3-2: Typical capital cost breakdown of a GTL plant**

This distribution shows that the costs within the GTL process are widely spread across the entire plant, with the largest portion of the plant's capital costs going toward synthesis gas production. This is also a sign of the integrated nature and complexity of the plant, with systems and services widely distributed, as shown in this diagram<sup>(6)</sup>.

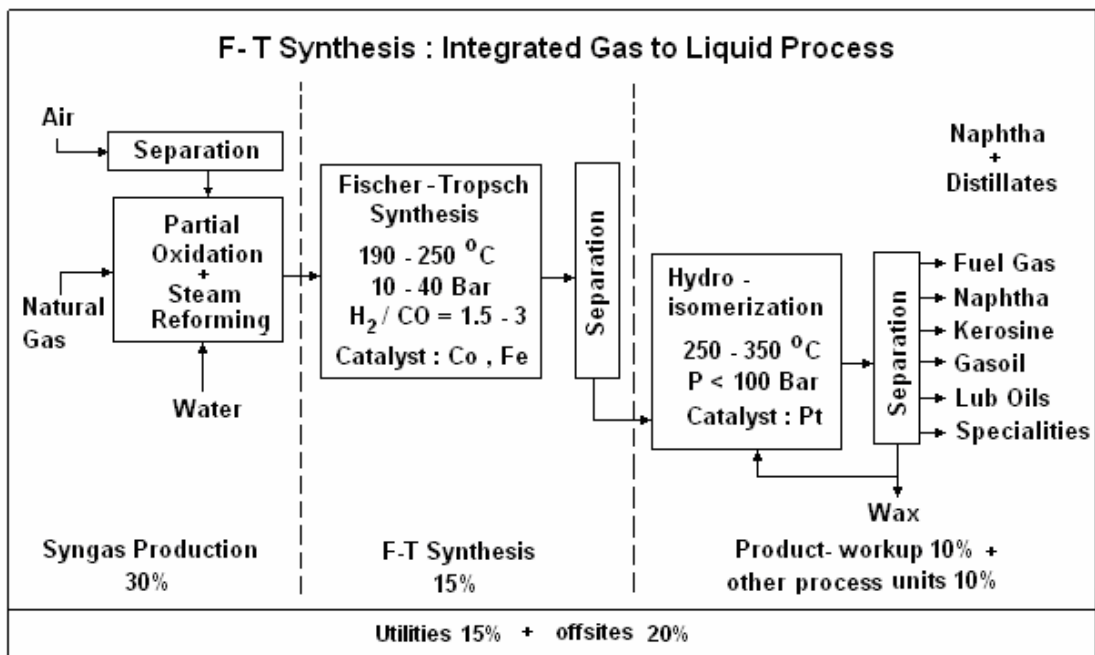

**Figure (3-4): The integrated nature of the GTL projects**

In the 1990s there were only three GTL facilities operated to produce synthetic petroleum liquids at more than a demonstration level: the Moss gas Plant (South Africa) with output capacity of 23000 bbl/day, Shell Bintulu (Malaysia) of 12000 bbl/day, and the subsidized methanol to gasoline project in New Zealand. None of these GTL pioneers fared

well. The plant at New Zealand, designed to produce gasoline via methanol was soon turned into a methanol plant. The other two projects were not commercially successful for a number of reasons; the main one was that they were far too expensive. Figure (3-5) presents the trend in capital investment per daily barrel of capacity<sup>(63)</sup>.

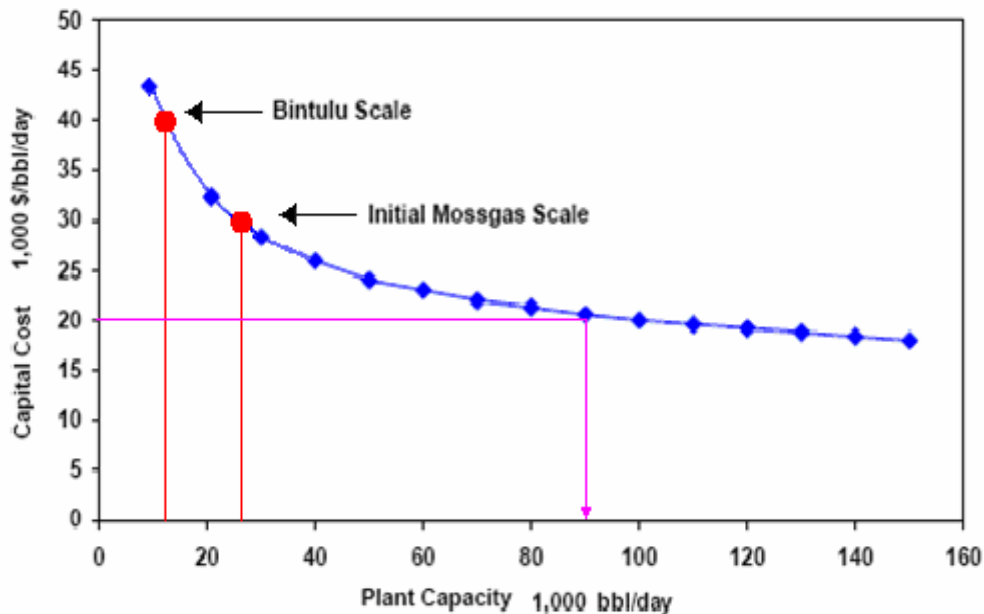

**Figure (3-5): Gas-to-Liquids Economies of Scale**

Commercial scale GTL plants are expected to have capacities in the 50000-100000 bbl/day range, substantially larger than the two currently operating non-pilot scale plants in South Africa and Malaysia. Because of economies of scale, capital costs for commercial-scale plants are expected to be on the order of 20000-25000 \$/bbl/day of capacity, substantially less than capital costs for plants with the capacity of the two currently operating non-pilot scale plants. While a substantial reduction in capital costs is expected, no commercial-scale (>50000 bbl/day) plants have been built to date. As a result, the capital intensity for commercial-scale plants should be seen as design targets. Plants at the scale of the Bintulu facility (12000 bbl/day) have a capital cost on the order of 40000 \$/bbl/day of capacity, for a total cost of \$400 million. For a plant with this capital cost intensity, gas would have to be in the 0.50-0.75 \$/MMBtu range to be competitive with crude-based products.

Industry expectations are that a facility of 100000 bbl/day would have a capital cost of \$2 billion or 20000 \$/bbl/day capacity. The substantial reduction in capital costs for commercial-scale facilities will allow GTL plants to be competitive at gas prices above the often-cited. Many

companies that work in the field of GTL put the capital cost 15000 \$/bbl/day as a target that should be reached to make their GTL projects competitive.

### **b- Operating costs:**

It would be worth drawing some further assessment from Figure (3-1) before examining in greater detail what it means for process configuration. In order to study the GTL economy many bases are taken into account such as considering what is called the Middle East Generic Project. This is clearly obvious, because the biggest natural gas resources are located in the Middle East, thus it would be logic to expect that most of the future GTL projects will be built in this region. Therefore a price of 0.5 \$/MMBtu for natural gas was used in determining the economics. The volume of natural gas required to produce one barrel of a GTL fuel varies according to different factors such as location, scale, quality of output, technology used, and the efficiency of conversion. Shell estimated this quantity to be around 9000 cft (about 9 MMBtu) when its technology (SMDS) is used. A gas price of 0.5 \$/MMBtu on an oil-equivalent basis, this translates into about 4.5 \$/bbl of products produced. Since operating costs are roughly equal to feed stocks costs, they are also roughly 4.5 \$/bbl of products produced. Capital cost cash flow is about double the feed stock cost or 9.0 \$/bbl. Table (3-1) shows the attraction of GTL economics: production of oil-based products using gas-based economics.

<b>Cost</b>	<b>\$/bbl</b>
Feedstock cost	4.5
Operating cost	4.5
Capital repayment	9
<b>Total production cost</b>	<b>18</b>

**Table (3-1): GTL cost analysis**

It also reveals the challenge the fact that oil prices have to be around \$18 for a GTL to be economically attractive as an oil producer. Some similar studies estimate the oil price should be around 20 \$/bbl to make the GTL project cost effective.

### **3- Factors Affecting the GTL Economics:**

There are many factors which affect the economy of a GTL project. These factors can be summarized as follows:

### a- The oil prices:

The increasing of oil prices has an impact on most of the other materials prices, as well as the services costs, transport costs, and other activities. The products of GTL technology are similar to those produced from oil refining, thus the price of a barrel of crude oil has a direct influence on the prices of the GTL products. Under conditions that may be considered reasonable, various reports say a GTL project with present technology could be cost competitive and profitable with crude oil prices around \$20 per barrel, but any shifts in the key cost factors could significantly raise the competitive price.

Oil prices have risen sharply throughout the past two years. Benchmark Brent crude oil prices have averaged \$53/bbl in 2005 through 31 August. Prices climbed toward the \$70 level in late August, or nearly three quarters as high again as at the beginning of 2005 Figure (3-6). No fall in prices seems imminent: oil price futures for end-December 2005 and end-December 2006 delivery are about \$60/bbl<sup>(66)</sup>.

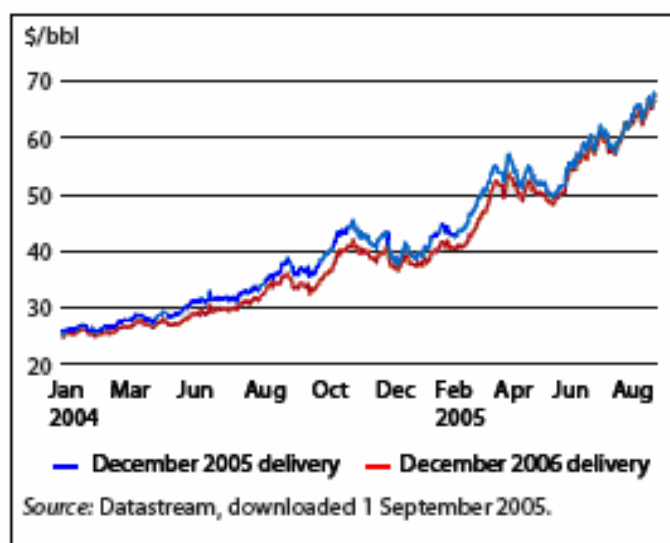

**Figure 3-6: Brent crude oil prices January 2004 – August 2005.**

These developments were not expected. The "**Asian Development Outlook 2005**", released in April this year, assumed an average \$41/bbl for 2005 and \$39 for 2006. Any economical monitor can easily concludes that the oil prices will settle for a period of time at 60 \$/bbl, and it will not exceed 75 \$/bbl at the end of this decade. In the coming decade the oil prices will definitely very much exceed this barrier, but this will happen gradually unless an unexpected political or military events happen.



### **b- The natural gas prices:**

One material which is affected strongly with this increasing is the natural gas, for its production is directly dependant on crude oil production. Therefore it is normally to note that the gas prices are increased whenever the prices of the crude oil are increased. Figure (3-7) views the natural gas prices for the period December 2004 to December 2005. If we go back, we will notice that the gas prices have increased nearly 7 folds since the beginning of this century<sup>(67)</sup>.

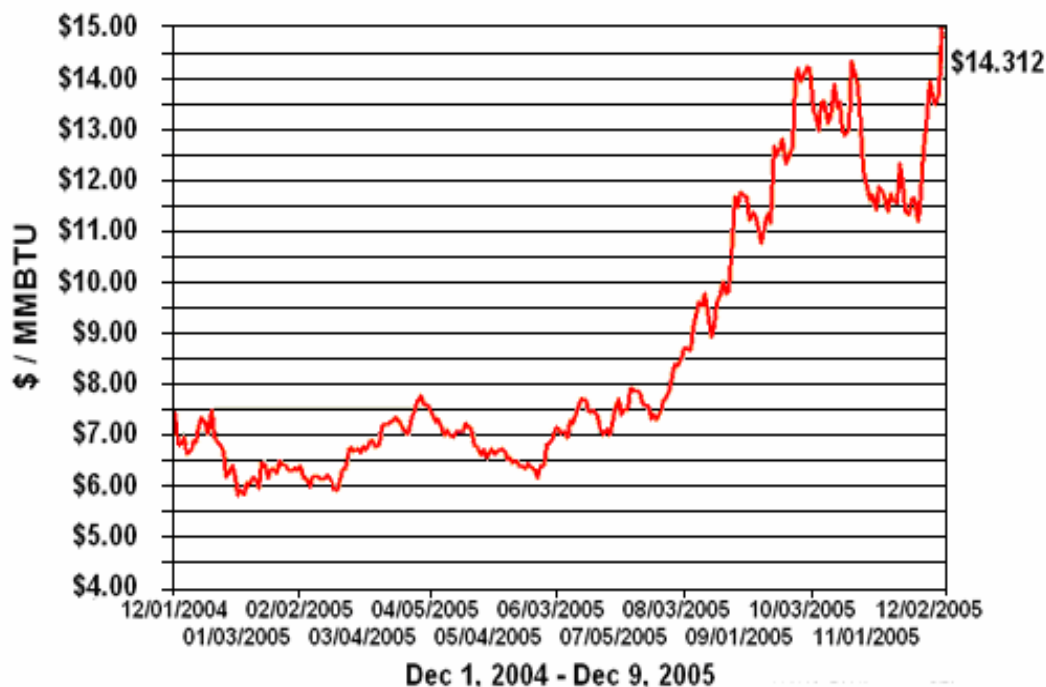
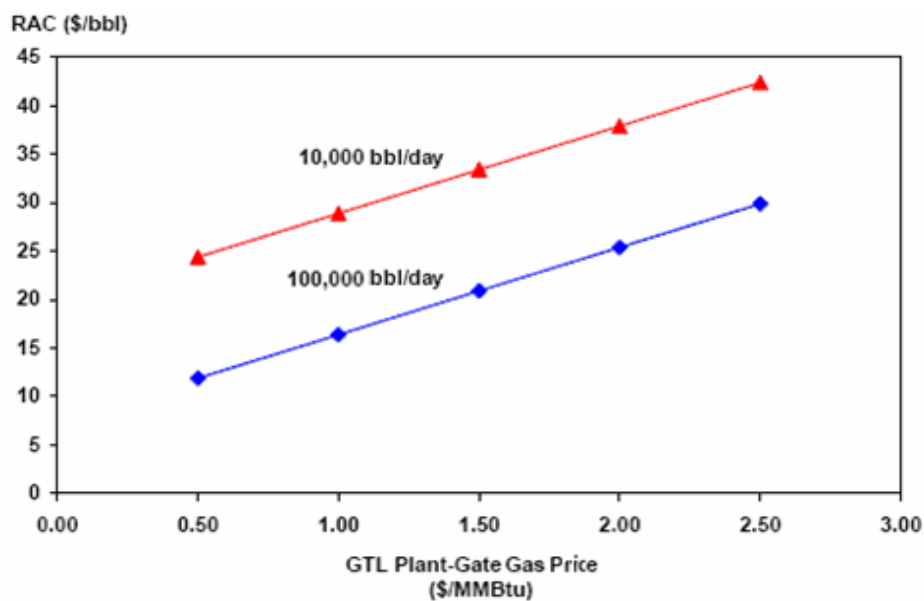

**Figure (3-7): The natural gas prices for the period 12/ 2004 - 12/ 2005**

The feedstock gas cost will have an influence as it may vary widely depending on alternative applications. Using gas that otherwise would be flared with zero (or even negative costs by avoiding penalties for violations of environmental regulations or increased costs related to compliance with environmental restrictions) would help the production economics. Shell has stated that a stand-alone SMDS (Shell's Middle Distillate Synthesis) project in the Middle East would be financially attractive with crude prices at about \$15/bbl. To get closer to the \$15/bbl mark, it is important that the gas supply is nearly free, or at least below \$0.50/MMBtu. As one indication, based on current efficiencies, a change in the cost of gas feedstock of \$0.50 per thousand cubic feet would shift the synthetic crude oil price around \$5 per barrel.

There are several factors which affect the natural gas prices in the international markets like the production cost, transportation cost, the mechanism of offer and demand ...etc. When an associated or free natural gas is produced, then it must be transported for long distances where it can be treated or marketed. The marketing price of the natural gas will be the wellhead prices plus all the costs spent in order to bring the gas to the market. This means that the wellhead price is very much different than the market price. For instance the price of the natural gas in Alaska field is 2.66 \$/MMBtu<sup>(68)</sup> which is different than the international price of 14.312 \$/MMBtu<sup>(67)</sup>.

The GTL technology is basically founded to treat the natural gas produced from the remote gas fields. Therefore it is natural to find the GTL plants near these fields, and not near the natural gas markets. Thus the wellhead prices will be the price of the feedstock of these plants, and not the market prices. Although the wellhead price and the market price are influenced by each other, but the fact that the wellhead prices must be used in calculating the GTL products prices, must be considered.

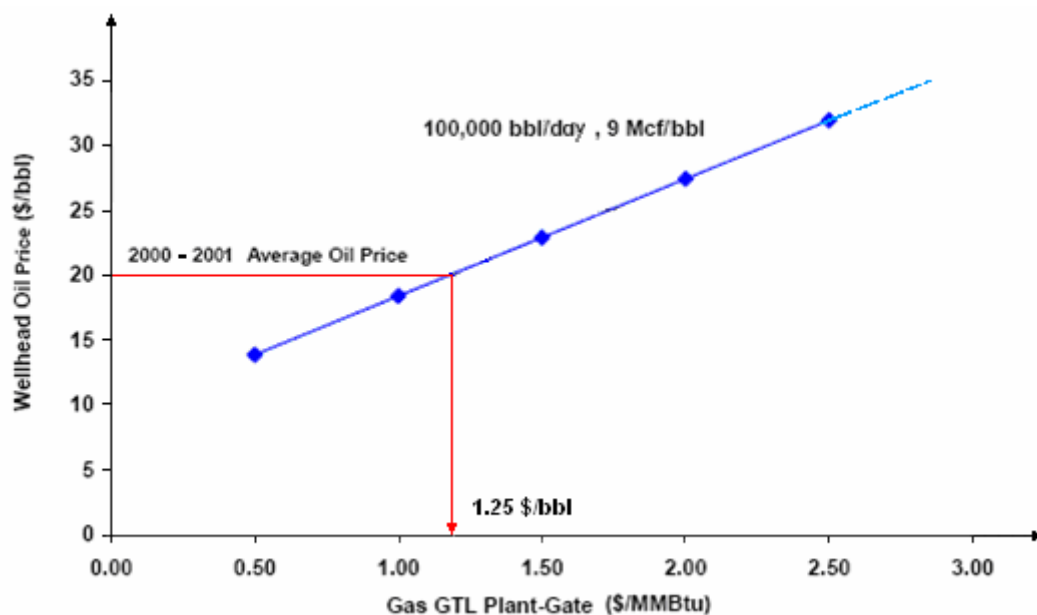

**Figure (3-8): GTL Gas Prices vs. RAC Oil Prices**

Figure (3-8) presents the minimum crude oil refinery acquisition price (RAC) at which a GTL plant-gate gas price would be competitive for distillate production. Capital costs are based on a 12% discount rate and a gas conversion efficiency of 9000 cft per barrel of distillate, about the current efficiency of the Shell Bintulu plant. Distillate prices are taken to be 5.60 \$/bbl above RAC, the long-term average in the United States since 1980. Because plant-gate gas prices include gathering and some

processing expenses, wellhead gas prices would be less than plant-gate gas prices. Gas price versus RAC is calculated for a 10000 bbl/day and a 100000 bbl/day facility. At current U.S. RAC, gas would have to be delivered to a 10,000 bbl/day GTL plant-gate at about 0.5-0.75 \$/MMBtu. If the capital intensity design targets for a 100,000 bbl/day GTL facility can be achieved, GTL plant-gate gas prices could approach \$2/MMBtu.

The direct relation between the oil prices and the feedstock natural gas prices of a 100,000 bbl/day GTL plant is shown in Figure (3-9) <sup>(63)</sup>. If long-term RAC prices were to decline to their 2000 and 2001 average of less than about \$20/bbl, then plant-gate gas prices could not exceed \$1.25/MMBtu.



**Figure (3-9): GTL Gas Price versus Oil Price**

This relation can be used to evaluate the natural gas price (Wellhead Price) which must be used in a GTL plant versus the present oil prices (around 60 \$/bbl), and to keep at the same time the prices of the GTL products within the economic rate. When the proper calculation is made, the natural gas prices will be between 5.0 and 6.0 \$/MMBtu.

### **c- The sort and efficiency of the GTL technology used:**

There are different of technologies used in GTL industry. These technologies differ significantly especially in their efficiency, and therefore they have different impacts on costs. Although most of these technologies have been improved progressively to make them competitive, the results still have not been proved practically because

most of them are either used in projects which are not finished yet, or they are still only used in pilot plants.

It has already been established that a GTL plant needs a high level of cost-effective efficiency. This is to say, efficiency gains are required at relatively low cost and need to be targeted in the right places. The efficiency of a GTL plant can be determined from:

$$\text{Efficiency} = \frac{\text{Heating value of products}}{\text{Heating value of (feed + fuel)}}$$

Therefore to increase efficiency, we must make more products, decrease fuel consumption, and decrease feedstock consumption<sup>(61)</sup>.

From an economic point of view, products should be addressed before the feed is addressed because a 1% change in products demand has a greater impact on the plant's economics than a 1% change in feedstock consumption. This economic argument has influenced the GTL plant's design in the following ways:

- **Maximum recovery of hydrocarbon products.**
- **Minimal use of natural gas for fuel.**

Driving the proposed GTL plant to use its own energy efficiently can significantly reduce supplementary fuel-burning. The energy produced by a GTL plant is of three main grades:

- **Fuel produced by the process.**
- **High-pressure steam from synthesis gas production.**
- **Medium-pressure steam from F-T synthesis.**

The GTL plant consumes energy in the following ways:

- **Fuel for synthesis gas production.**
- **Motive force for air separation.**
- **Power generation for plant use.**

A successful GTL plant's design, therefore, will enable it to balance its energy consumption with its production in a cost-effective manner. This can be achieved through control of steam generation pressures, and the configuration of turbines and heat sinks that use the energy. Whilst this resolves the issue of an optimized GTL plant, it does mean that there is no spare energy available for export in normal circumstances. An

efficiency between 8.2 to 10.2 MMBtu/bbl has been recorded for the existing GTL plants (Sasol , Shell , Syntroleum).

#### **d- Kind of the catalyst used:**

The cost of most catalysts used in many GTL technologies is expensive. The catalyst is also consumed in big quantities, especially when there is no regeneration way used. Thus it is obvious that the kind of catalyst used, its price, and the way of using it have a direct impact on the economy of the GTL technologies. Most modern GTL plants use cobalt as a catalyst. Although this catalyst is very effective, but it is poisoned when even less than 1 ppm sulphur is present in the natural gas. This means that a desulphurization unit must be built beside the GTL plant to treat the natural gas, and this will add extra expenses to the already high costs.

#### **e- Temperature used in synthesis gas production:**

High temperature of any process means high consumption of energy, and consequently high cost of production. All developments of GTL process conducted by most companies were aimed to reduce the temperature of reaction and therefore reducing costs.

#### **f- The source of the Oxygen used:**

The production of the synthesis gas which is the main raw material in the GTL industry needs oxygen in large quantities. The source of this oxygen, or the way of its production is very important because it affects indirectly the prices of the final products. It is known that the separation of oxygen from air in the conventional way is a very expensive process. Thus any technology that can eliminate this step, and succeed in finding another source of oxygen will be consequently a cost competitive technology.

#### **g- The presence of other projects infrastructure:**

The GTL project is very complicated and too expensive. The building of such a project near other projects could reduce its capital cost because of the sharing in the infrastructure. For example the joint development of GTL and LNG projects would allow for shared labor and infrastructure, reducing the costs to both projects and accelerating their development.

## **4- The Future of the GTL Industry from the Economic Outlook.**

Many political and military events have passed worldwide during the past 25 years. Most of these events have upset and stagnated the motion of the international economic activities. These events were behind many of the fluctuations that happened in the oil and natural gas prices, and for sure they are the main causes of the sharp increasing in their prices during the past few years. All the present indicators do not presage that the situation will be relieved in any way within the near future. One of the main results of these economic events is the wave of inflation which the world is suffering from. All the available factors point out that the inflation will continue to rise, or at least will stay at its present levels as time passes.

Another consequence of these events is the weakness in the courage of the businessmen to invest in big projects, especially the projects which are not profitability guaranteed. The capability to make strategic planning in the long term is also nearly vanished, because of the fear from unexpected events, which could turn these planning at any time upside-down. One of the reflections to this is the decreasing in the number of the investors who can invest in large projects. Thus, we find most big industrial projects at the present time are funded by the benefited countries and not by the investors. Moreover, these large projects are located in the rich countries, and it is usually directed toward investing the natural recourses of these countries. This is naturally because the enthusiasm of the countries to invest their natural resources is stronger than that of the businessmen, which usually seek for quick and guaranteed profits.

More than 15 GTL projects are being built in many countries, and more than 40 other projects are being studied or planned to be built. The total capacity of these projects could reach a 3.4 MMbbl/day. If these projects succeed and prove in the future that they are economic and profitable, this will supply the world fuel markets with new sources to cover some of the fuel shortages. This success will assure the investors about the profitability of this industry, and could drive them to invest in the countries which have natural gas reserves but can't afford to invest them. In addition to that the inventing of the new small and mobile GTL units which can even be hired will make the situation very easy to monetize any gas field however small or remote it is.

As far as the crude oil and natural gas prices developments are concerned, it was seen that as long as the wellhead gas prices are used, the GTL products prices stay cost effective compared to the oil products. And as long as the difference ratio between the oil prices and the natural gas prices remain fixed, the GTL industry remains economic, no matter how high these prices become. On the other hand, the successes that some GTL companies like Sybroleum, IvanhoeEnergy, and Alchem have achieved in reducing the capital cost of this technology have decreased the cost of its products. These accomplishments have been shown clearly to the specialists from the demonstrations which these companies implemented. Thus it is easy to conclude that the days of uneconomic GTL technology have ended for ever, and the days of economic GTL technology have just started.

# **Chapter Four**

## **Potential Impacts of the GTL Industry**



## **1- Introduction:**

In the recent decades, man has paid lots of attention to the issue of the environment pollution, especially when the results of this pollution started to affect seriously the medium where he lives. Environment pollution has started on the planet earth since the beginning of life, and it is continuing to happen because CO<sub>2</sub> which results from the respiration of the living organisms is one of the environment pollutants. Nevertheless, the balance between the produced CO<sub>2</sub> and its consumption in the plants photosynthesis prevents the increasing of its concentration in the ambient air. The development of the human being activities and the deforesting phenomenon has let the CO<sub>2</sub> concentration in the ambient air to increase gradually. In the 20<sup>th</sup> century, and because of the industrial development, together with the increasing in the use of the auto transportations, the concentration of the CO<sub>2</sub> gas has increased by 30% of its natural level. A phenomenon known as the "**Greenhouse Effect**" has resulted from the increasing of CO<sub>2</sub> concentration, which makes the climate temperature of the planet rise over its normal levels.

In addition to CO<sub>2</sub>, there are other pollutants emitted from the vehicles like carbon monoxide, nitrogen oxides, sulfur oxides, hydrocarbons, particulate matters...etc. These pollutants have caused many bad influences on earth and on the public health which are as dangerous as the greenhouse effect and the climate change. The concentrations of these pollutants have reached levels that cannot be ignored, which made the international environment organizations press on the governments in order to legalize new laws to decrease the emissions of these pollutants. One of the ways to reach this purpose is to use alternative fuels, therefore the governments have spent huge amounts of money on implementing researches to find clean fuels, and eventually many kinds of new fuels are discovered.

Gas to liquids industry produces clean environmentally-superior fuels. These green fuels are of the highest quality liquids that are complained with increasingly stringent environment and performance specifications. Green Fuels include natural gas products (LNG, CNG, and LPG), Alcohols, Biodiesel, Hydrogen...etc., and they are named green because:

- **They are non-toxic.**
- **Less pollutant.**
- **Low corrosive products.**

The promotion of the GTL industry has both positive and negative impacts on other parts of the oil industry. In the following sections the impact of GTL on other activities will be discussed in details.

## **2- The GTL Industry and the Environment.**

Since the Industrial Revolution, we began altering our climate and environment through changing agricultural and industrial practices. Before the Industrial Revolution, human activity released very few gases into the atmosphere, but now through population growth, fossil fuel burning, and deforestation, we are affecting the mixture of gases in the atmosphere. According to the United Nation Organization of Health, man has polluted the planet Earth in the 20<sup>th</sup> century only by a degree which exceeded the entire pollution in the planet lifetime. Most of this pollution came from using the on-road fuels such as gasoline and diesel. If things remain as it is, the Earth will be unsuitable for human living in a few centuries and perhaps in a few decades.

The pollutants produced from the petroleum products are divided into the following categories<sup>(70)</sup>:

- **Carbon oxides like CO and CO<sub>2</sub>.**
- **Hydrocarbons like the aromatics.**
- **Sulfur compounds especially sulfur oxides (SO<sub>x</sub>) like SO<sub>2</sub>, SO<sub>3</sub>.**
- **Nitrogen oxides (NO<sub>x</sub>) like NO and NO<sub>2</sub>**
- **Particulate matters (PM).**

These pollutants cause serious problems to the environment and the public health, which can be summarized into<sup>(71)</sup>:

- **Global warming and climate change:** The Earth's surface temperature has risen in the past century, with accelerated warming during the past two decades. There is new and stronger evidence that most of the warming over the last 50 years is attributable to human activities. Human activities have altered the chemical composition of the atmosphere through the buildup of greenhouse gases – primarily carbon dioxide, methane, and nitrous oxide. The heat-trapping property of these gases tends to warm the planet.
- **Ozone layer depleting:** In the past two decades, holes in the ozone layer which surround the planet earth were observed especially above the South Pole. The ozone layer protects the planet from the

ultraviolet radiation emitted from the sun. The formation of these holes is due to the decomposition of the ozone gas caused by the presence of nitric oxide gas (NO). Nitric oxide is one of the pollutants produced by the combustion of the conventional petroleum fuels like gasoline and diesel. The areas of these holes are found to increase with time, and this would cause dangerous influences on the environment and the public health, if left to go on without any dealing.

- **Acid rains:** This phenomenon is happened due to the increasing of the concentrations of some oxide gases in the atmosphere such as  $\text{NO}_2$ ,  $\text{SO}_2$ , and  $\text{SO}_3$ . These oxides are produced from the combustion of the petroleum fuels in vehicles engines. They dissolve in the water droplets of the rain to form acids like sulfuric, nitric, carbonic acids. These acids will fall with rains forming what is known as the acid rains that cause corrosion to the matters which they fall on.
- **Spreading dangerous diseases:** There are many compounds produced from the combustion of conventional fuels which can harm the health seriously. These compounds are parafinic, olefinic, and aromatic hydrocarbons as well as the particulate matters (PM). When these compounds are inhaled they may cause very dangerous diseases like cancer.

These bad influences have been increased sharply during the past two decades, due to enormous increase in consuming the petroleum products especially the light products. Therefore, the international NGOs, which concern about the environment and the public health, have imposed pressures on the local governments to issue new laws which can protect the environment. Voices have also risen to call for the use of alternative clean fuels which do not harm the environment or the public health. They demand also for the stop of natural gas flaring, and to decrease the emissions from the industrial factories, and the power plants.

One of the best solutions to the problem of environment pollution is to extend the gas to liquids (GTL) industry. The GTL technology stops the flaring of the associated natural gas, because it can simply industrialize this gas and change it into valuable liquid fuels, or products used as feedstock to other industries. The other option is that the products of the GTL technology can be used to blend the refineries products to improve their specifications. These options satisfy the hard constrains which most governments impose to protect the environment and the human health.

### a- Comparing the GTL products with the conventional fuels:

The differences between the GTL and the petroleum products can be clarified by comparing the specifications of these two kinds of fuels. For instance, the GTL diesel is a clear crystalline liquid, free of sulfur and the aromatic compounds or any other poisonous metals, and has a high combustion quality.

In general, the differences between the GTL and the petroleum products are listed in Table (4-1) <sup>(71)</sup>.

Description	ASTM	GTL Diesel Fuel	Typical Conventional Diesel Fuel
Density at 15°C (kg/l)		0.78	0.82 - 0.86
API Gravity	D 4052	50	33-39
Distillation (°C)			
IBP		190	171 - 216
10 % evap (v/v)	D 86	210	204 - 254
50 % evap (v/v)		255	243 - 293
90 % evap (v/v)		330	288 - 321
Final boiling point		355	204 - 349
Kinematic viscosity at 40 °C	D 445	2.0	2.0-4.1
Flash point (°C)	D 92	>55	>55
Cetane Number	D 613	>70	45 - 50
Total Sulphur (ppm)	D 4294	<1	>50
Cloud point (°C)		-23	0
SFC Aromatics (vol. %)	D 5186	<1	>10
Saturations , vol		>99	70.3
HPLC Aromatics (mass %)			
Monocyclic		0,436	
Bicyclic		0,026	1.4 (max)
Polycyclic		< 0.01	
Olefins (vol %)		-	1.4

**Table (4-1): Comparing the GTL and the petroleum products**

### b- Comparing the emissions from the GTL products and the petroleum fuels.

Although the Compression Ignition Engines (CI) emit a range of pollutants, the two most important emissions associated with (CI) engines are Nitrogen Oxides (NO<sub>x</sub>) and Particulate Matter (PM), and this is where most of the environmental focus lies. Aromatic hydrocarbons and particularly poly-aromatic hydrocarbons (PAH), are gaining an

importance due to concerns about their carcinogenic effects, and Sulfur Oxides (SO<sub>x</sub>) are important in regions where acid rain is a problem. Unburned Hydrocarbons (HC) and Carbon Monoxide (CO), while legislated in some countries, are not generally regarded as a "diesel problem" as they are low relative to other sources. GTL Fuel has been tested in a number of programmes to evaluate emissions performance in compression ignition engines.

Many experiments have been conducted to determine the extent of emission of the above pollutants both from the GTL and the conventional fuels. In general the emissions of the harmful pollutants from the GTL fuels are found to be less than their emissions from the conventional fuels, as seen from the following table.

<b>Emission</b>	<b>GTL Diesel Fuel g/kw-hr</b>	<b>Conventional Diesel Fuel g/kw-hr</b>
Hydrocarbons (HC)	0.21	0.25
Carbon Monoxide (CO)	0.67	0.94
Nitrogen Oxides (NO <sub>x</sub> )	6.03	7.03
Particulate Matters (PM)	0.08	0.15

**Table (4-2): Emissions from the GTL and the conventional fuels**

It can be seen from the above table that the emission of the Particulate Matters (PM) (suspected carcinogenic material) from the GTL diesel is less than their emission from normal diesel by 46%.

Two different experiments were conducted to measure the pollutants emitted from GTL and normal diesels and gasolines. In the first experiment a Heavy-Duty Diesel engine was used, while in the second a Light-Duty Gasoline engine was used. The following results were obtained.

- In the Heavy-Duty Diesel engine the emissions of CO, (HC), NO<sub>x</sub>, and (PM) were found to decrease by 10 – 20 % as shown in the following diagram<sup>(72)</sup>.

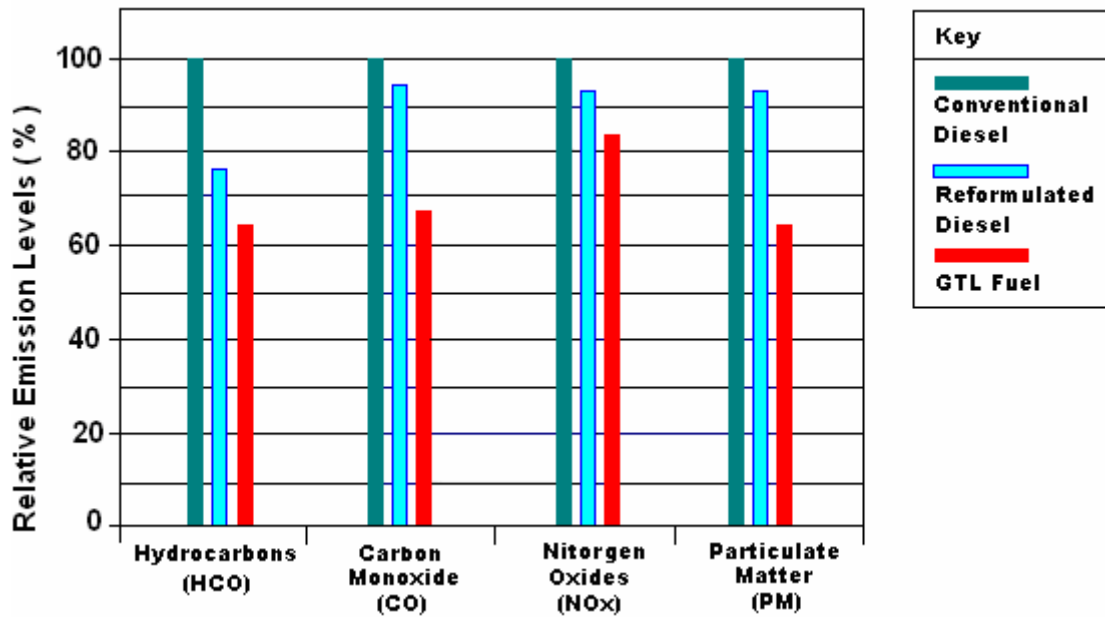

**Figure (4-1): Emissions of pollutants from the GTL and normal diesels.**

- In the Light-Duty Gasoline engine the emissions of CO, (HC), NO<sub>x</sub>, and (PM) from the GTL gasoline was found to decrease by 10 – 50 % as seen in Figure (4-2) <sup>(72)</sup>.

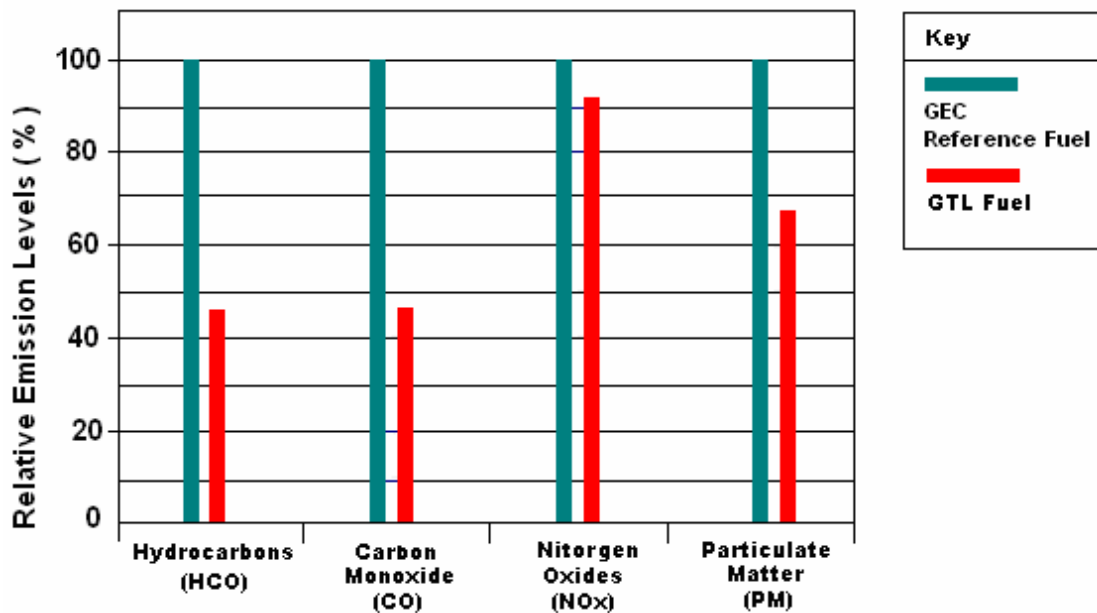

**Figure (4-2): Emissions from the light vehicles when the GTL and the normal gasolines are used**

It is interesting to notice that the emission of CO<sub>2</sub> from the GTL fuels exceed that from the normal fuels, as shown in Table (4-3) <sup>(73)</sup>.

Energy	Origin	Engine	CO <sub>2</sub> g/kw-hr	CO <sub>2</sub> g/km	CO <sub>2</sub> g/km relative
Diesel	Petroleum	CI	308	166	1.00
Diesel (F-T)	Natural Gas	CI	376	203	1.22
Gasoline	Petroleum	SI	278	216	1.30
Natural Gas	Natural Gas	SI	224	148	0.89
EtOH	Sugar	SI	169	111	0.70

CI = Compression Ignition, SI = Spark Ignition

**Table (4-3) : Emission of CO<sub>2</sub> for conventional and alternative Engine-Fuel technologies**

Although carbon dioxide is neither a poisonous gas, nor a dangerous pollutant to the environment, it is the main cause of the climate change phenomenon. However, the emission of this gas from the GTL industry can not be considered as a retarding factor to the promotion of this industry, because the contribution of its emission of CO<sub>2</sub> gas to the total emission in the world is only a small portion<sup>(74)</sup>. Therefore, the emission of CO<sub>2</sub> from the GTL fuels will not in general increase its total emission to the atmosphere.

## **2- The Impact of GTL Industry on Refiners.**

The main duty of the oil refiners is to distill the crude oil which consists of hundreds of hydrocarbons to produce petroleum derivatives, which can then be used for different purposes. The oil refiners produce wide spectrum of petroleum products like the gas products, light products such as gasoline, middle products like gas oil, and heavy products like lubricating oils and waxes. Despite all the advantageous of these products, they are also very harmful to the environment and the human health.

The oil refining industry has to make adjustments to face several challenges in the 21<sup>st</sup> century<sup>(75)</sup>. Among these challenges are:

- Tightening specifications for gasoline, diesel, jet fuel, and fuel oil.
- Pressure to reduce emissions of greenhouse gases and air toxins from refineries.
- Dealing with the surplus of heavy fuel oil, and the deficit in the light and middle distillates as a result of:
  - Increase demand for light and middle distillates.
  - Decrease in demand for heavy fuel oils.

- Very low refining margins, resulting from slowing of growth in demand for refined products and a steady increase in the refining capacity through capacity creep and construction of grassroots refineries.
- Expanded use of natural gas as a substitute for some petroleum products.

The refiners have to intensify the use of conversion processes together with new processing technologies to go on in the production of the petroleum products, and to comply with the above challenges.

### **a- Improving the specifications of petroleum products:**

The pollution of the world environment has become a subject of primary concern. The governments of most countries especially the big industrial countries have imposed very tight regulations to be applied by the refineries to reduce the emission produced from the combustion of the petroleum products. These regulations are:

- **Production of high quality leadless and sulfur free gasoline.**
- **Production of high quality and sulfur free diesel.**
- **Production of high quality lubricating oils.**

The stricter specifications of the petroleum products will require extensive improvement in the performance of the refining processes, as well as introducing new processes to the refining schemes. These constraints have increased the prices of the high quality fuels sharply, especially in the developed countries where the laws of environment protection are highly respected.

To focus on the sorts and percentages of pollutants emitted from the combustion of petroleum fuels especially the light fuels it is necessary to know the specifications of these products. The specifications differ from one country to another due to different refining technology used, and different environment laws employed. Recently the EU specifications were employed in many countries, especially in those which concern seriously about the environment protection.

Reflecting back to the late 1990s, when the EU refining industry was facing more stringent 2000 specifications with the knowledge that tighter 2005 specifications would follow, dramatic claims were made about the impact on the European refining industry e.g. mass closures, unemployment, not enough time to implement, large scale hydrogen plant requirements and a bill for around \$33bn. In practice, the refining



industry has demonstrated a commendable approach to this problem, avoiding in many cases new investment in plant and stretching the capability/performance of existing assets. The only reaction which has been taken by the refineries is to expand the capacity of the already available treatment units to comply with the hard specifications of the produced petroleum fuels. No other serious actions that can improve the performance of the petroleum refining industry or to introduce a new technology were discussed. The large scale use of gas-to-liquids (GTL) technology, refinery-based or by importing from distant large scale plant has not materialized

In 1998 the governments of the European Union decided to impose a stricter specifications list which had to be implemented by 2005. After a while from that the governments have issued a harder list, and decided to put it in use in 2008 or 2010. The respond of the refining companies to the list of 2005, and to the list which will become active in 2008 was very serious, and they started for the first time to search for any escaping from the bottleneck position which they were in <sup>(76)</sup>.

### **Gasoline**

	<b>2000</b>	<b>2005</b>	<b>Possible 2008/2010</b>
<b>Sulfur (wtppm), max</b>	150	50	10
<b>Benzene (vol %), max</b>	1.0	1.0	< 1.0
<b>Aromatics (vol %), max</b>	42	35	< 30
<b>Olefins (vol %), max</b>	18	18	< 10
<b>E100 (°C)</b>		46	
<b>Oxygen (wt %)</b>		<2.7	
<b>RONC, min</b>		95	95

**Table (4-4): EU Gasoline specifications for 2000/and beyond**

### **Diesel**

	<b>2000</b>	<b>2005</b>	<b>Possible 2008/2010</b>
<b>Sulphur (wtppm), max</b>	350	50	10
<b>Density (kg/m<sup>3</sup>)</b>	845	820-845	< 840
<b>Cetane Number, min</b>	51	51	53 - 55
<b>Poly Aromatics, (wt %) max</b>	11	11-2	1-2
<b>Aromatics, (vol%) max</b>		N/A	
<b>Distillation, T95 (°C) max</b>	370	340-360	< 340

**Table (4-5): EU Diesel specifications for 2000/and beyond**

In recent years, there have been many papers published reviewing the impact of tightening product specifications on refinery operations. Scenarios have been presented where the refiner is faced with the dilemma that existing technology may be at the practical limit. Many have questioned whether Fischer-Tropsch technology could help resolve this dilemma. The differences between the specifications of the diesel produced from the GTL industry and that produced from the petroleum refineries after employing the tight specifications of the European and American governments can be seen from the following table.

<b>Specifications</b>	<b>EU Diesel</b>	<b>US Diesel</b>	<b>GTL Diesel</b>
<b>Sulphur (ppm), max</b>	50	15	0
<b>Density (kg/m<sup>3</sup>)</b>	820 - 845	876	790
<b>Cetane Number</b>	51	40	> 70
<b>Poly Aromatics, (wt %) max</b>	11-2	N/A	0
<b>Aromatics, (vol%) max</b>	N/A	35	0
<b>Distillation, T95 (°C) max</b>	340 - 360	338	340

**Table (4-6): Comparing the specifications of the GTL diesel and specifications employed by the Europeans and the Americans**

**b- Increasing the demand for light and middle distillates, and its impact on refining and GTL industries.**

In the past few years the global demand for the petroleum products has increased sharply, especially the demand for the light and middle products because they are the fuels used by vehicles. The main source for these fuels is from the refining of crude oil. The supply consists of premium grade gasoline for spark ignition engines, and diesel for diesel engines. At global level petroleum based fuels constitute 98% of energy used by road transport <sup>(73)</sup> in the year 2000 as shown in the following picture.

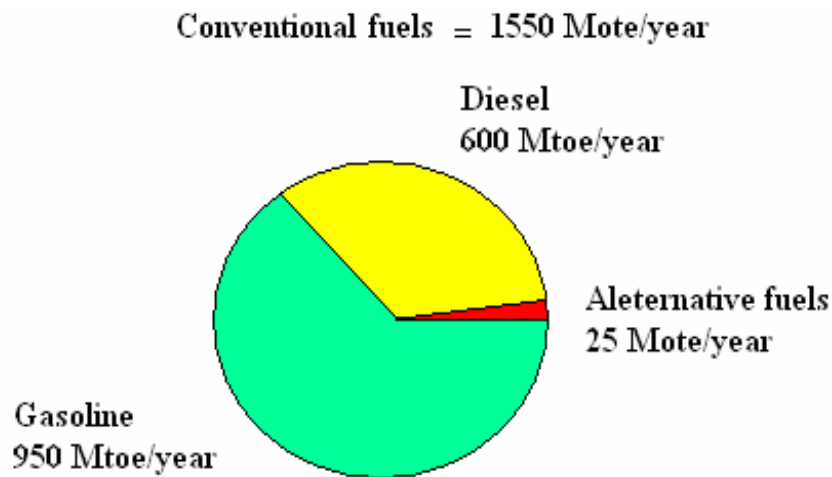

**Figure (4-3): Global energy consumption for road transport during 2000**

The above picture shows that the world consumption of conventional transport fuels produced from the refining of crude oil was in the year 2000 about 1550 Mtoe. This quantity of fuel is composed of about (40%) of diesel, and (60%) of gasoline. The annual world consumption of the alternate fuels for transport was about 25 Mtoe, which represent only about 2% of the total energy consumption. This figure clarifies clearly how small the part of the alternate fuels consumed, compared with the conventional fuels.

The global demand for light (gasoline) and middle (kerosene and diesel) products is steadily increasing for a simple reason that is the increasing in number of vehicles. The biggest rates of increasing are in China and India due to the accelerating development of the number of vehicles in these two countries. On contrary to this is the decreasing in demand for the heavy petroleum products. The following picture shows the percents of demand for the petroleum products from 1973 till the present time <sup>(4)</sup>, together with the expected demands for every sort of products until 2020.

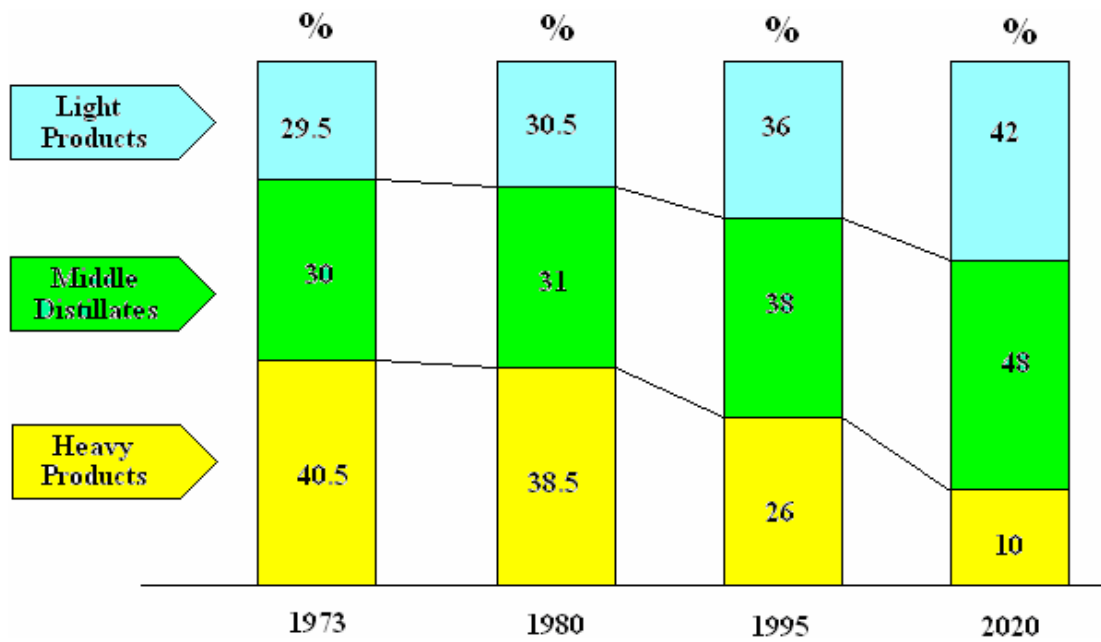

**Figure (4-4): The world demands for petroleum products for the period 1973 – 2020**

The existing refineries have limited capabilities to satisfy such high demands for the light products, while at the same time facing the problem of descending in demand for the heavy products. On the other hand, the capacities of the existing cracking units to treat the unwanted heavy products to change them into light products are limited also. Therefore, any increasing in the capacities of the petroleum refineries to satisfy the high demands for the light fuels will create a problem of stacking large quantities of the unwanted heavy products.

The percentages of the different petroleum products obtained from the refineries are fixed. It is not easy to increase one of these percentages on the account of the others no matter what kind of development is implemented, or what new technologies are introduced. Figure (4-5) shows the percents of the products extracted from the petroleum refining as well as the upgrading units in one of the modern refineries in the European Union <sup>(74)</sup>. The diagram clarify that any thinking of finding a solution for the problem of high demands to the light products in the traditional way will definitely reach a closed way. The diagram also shows the percents of the synthesis crude produced from the GTL technology <sup>(74)</sup>.

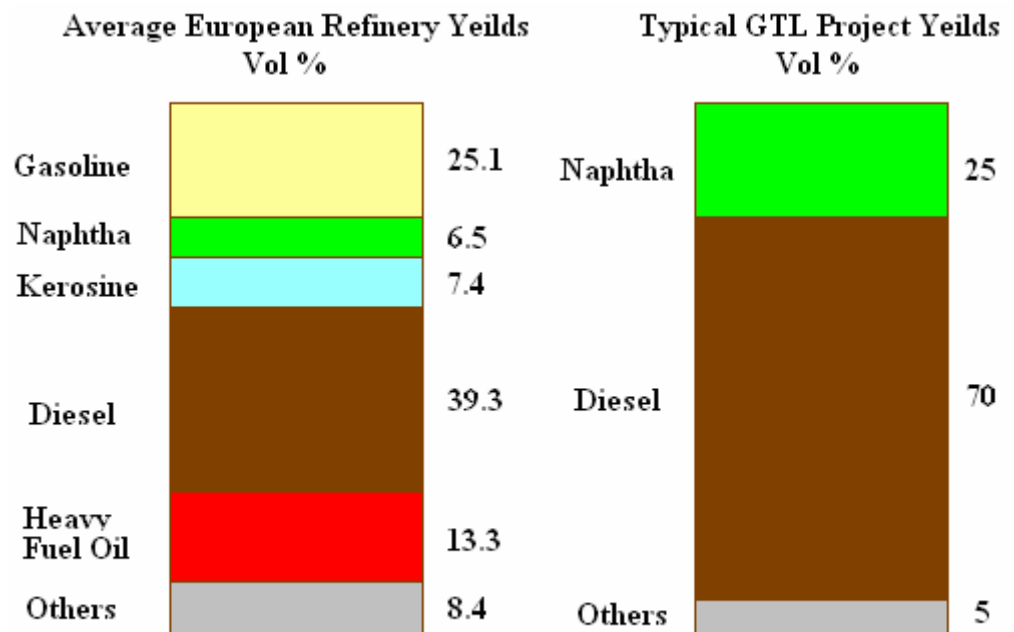

39,300 bbl/day GTL diesel = 100,000 bbl/day Crude Oil

**Figure (4-5): Petroleum products from one of the European petroleum refineries and the GTL industry**

It can be observed from the above picture that the dominant product of the GTL technology is diesel. If we go back to Figure (4-4), we can find that the demand for diesel (one of the middle products) is increasing continuously, and will keep like this in the coming years. Therefore it is easy to conclude that the GTL technology is one of the best solutions for the problem of high demands for the light and middle products in the future.

**c- The Impact of the GTL technology on developing the performance of the petroleum refineries.**

The GTL industry will provide opportunities to meet changes in fuel specifications. GTL cannot be seen as threat to refiners. Rather, it represents an opportunity for refiners to meet the challenge of producing cleaner diesel. F-T based GTL processes have the potential to bring about a paradigm shift in the oil industry for two key reasons:

- (1) Once F-T diesel becomes readily available from word-scale GTL plants, the fuel will give some refiners the option to buy clean diesel components, thus limiting the investment in capital-intensive product upgrading and hydrotreating that would otherwise be required to produce the cleaner diesel. The GTL diesel is one of the best fuels used in the internal ignition engines. This fuel can be used either

directly, or by blending it with the ordinary diesel to improve its specifications.

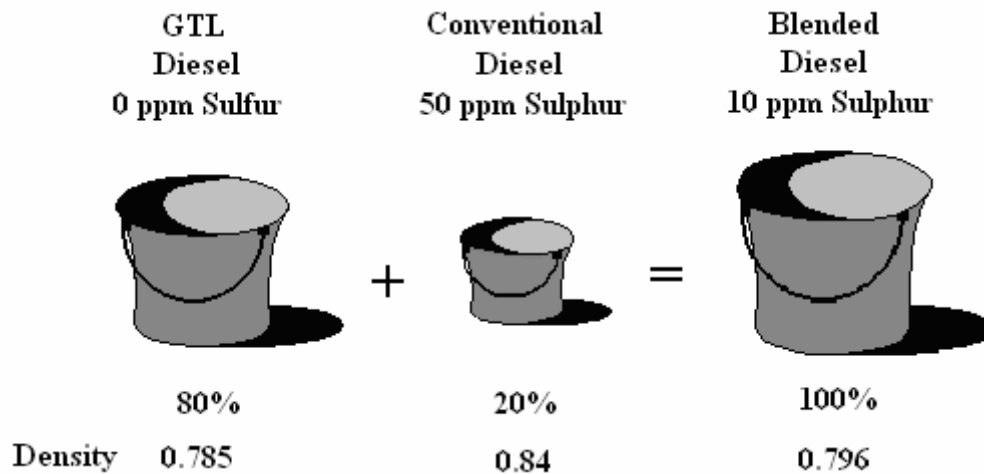

**Figure (4-6): Specifications of the diesel produced from conventional diesel with GTL diesel.**

(2) Refiners could install F-T based GTL plants within the refinery fence and feed them synthesis gas made from gasifying low-value, heavy liquids. By integrating a GTL plant into a refinery, refiners would have the potential to gain synergies through integration of the product work-up section with the existing processing units in refinery. In time, it is possible that ever-increasing proportions of the "bottom of the barrel" could be processed in this manner.

(3) The GTL products could cover some of the increasing demands for the light and middle products. This matter will reduce some of the imposed pressures on the refiners to increase the production of these products in order to fulfill the high demands for them.

#### **4- The Impacts of the GTL Industry on the LNG Production Industry:**

The liquefied natural gas (LNG) is simply a dry natural gas which is composed mainly of Methane and a little of Ethane but cryogenically chilled and changed into liquid by cooling to  $-161^{\circ}\text{C}$  under the ordinary pressure. The natural gas liquefaction is known since a long time, but only became important during the last two decades due to the needs to liquefy the gas to make it suitable for exporting by vessels. The natural gas is transported as a liquid from its fields to the treatment places by big or small thermally isolated cylinders. These cylinders are fixed on trucks,

railway cars, and they are also built in specialized tankers used only for exporting natural gas. The liquefied natural gas (LNG) is used mainly as a fuel for the power stations and the houses, and also as a fuel for vehicles.

Worldwide LNG supply has more than doubled during the last 20 years, to nearly 6 Tcf/yr. The liquefied gas accounts for 4% of world gas consumption and 23% of world gas exports <sup>(77)</sup>. With new LNG export facilities in Trinidad, Qatar and Nigeria, plus proposed or developing projects in Australia, Norway, Angola, Egypt, Peru, Venezuela, Iran and Russia <sup>(78)</sup>, LNG production could again double within a decade. Floating LNG plants have been proposed to produce stranded offshore reserves. LNG will likely play an increasing role in development of giant gas fields, since most countries - especially net oil importers - are keen on developing their gas reserves, however stranded, for greater energy independence and extending domestic oil reserves where applicable, as well as for environmental reasons.

Establishing a conventional LNG production industry in any place around the world, and exporting its product to the world markets requires the followings <sup>(39)</sup>:

- The presence of minimum reserves of several Tcf (at least 1 Tcf).
- Investment of more than \$1 billion.
- Long-term (15 year+) contracts.
- Availability of insulated LNG supertankers.
- The presence of specialized offloading terminals.

Nevertheless, LNG will figure prominently in monetizing stranded gas. Costs to liquefy gas and construct LNG tankers fell 30% over the past two decades. One report cites a 60% cost reduction since 1989 <sup>(79)</sup> for constructing the liquefaction plant alone, and incremental increases in efficiency and capital-cost reduction will undoubtedly continue. The following picture shows the declining of the capital cost of this industry as time goes on <sup>(33)</sup>.

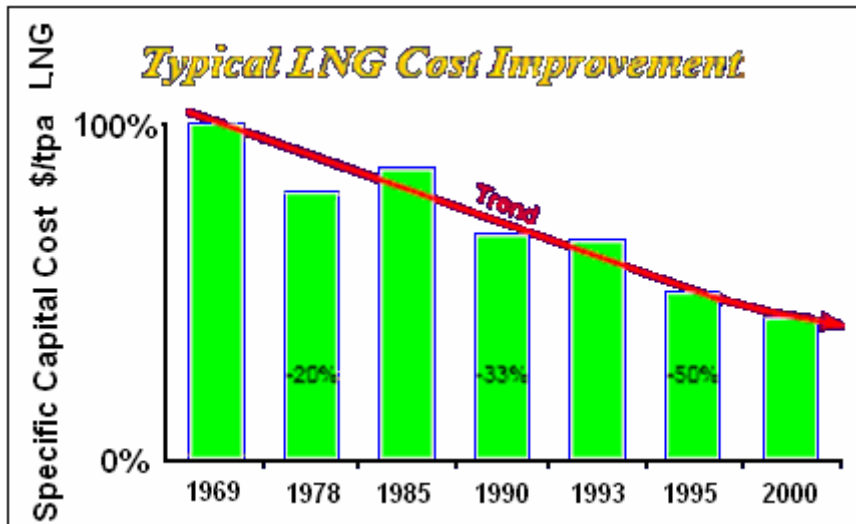

**Figure (4-7): Declining of the capital cost of the LNG industry**

Further cost savings can be achieved by combining LNG with GTL facilities, and there are several plans / studies underway to do just that in Nigeria, Egypt, Qatar, Australia and Iran. Small-scale LNG plants are under development and could have considerable impact on smaller volumes of stranded gas, which, cumulatively, are enormous. These units are increasingly being used for peak shaving at power plants and at LNG-vehicle fueling stations.

The biggest problem that the LNG industry suffers from is the costs of cooling the natural gas to the temperature of liquefaction. Thus any combination between this industry and any other industry in which the cooling is one of its products, or any energy producing industry will help in reducing the LNG operating cost. One of the available options in this direction is to combine the LNG industry with the Gas to Liquids (GTL) industry. Both of these two industries are expensive and needs huge investments. Therefore any thinking of combining them together will reflect positively on them, because it will diminish the capitals needed to invest on them. Some specialists have estimated the reduction in the capital costs when these tow industries are combined together to be around 20% <sup>(80)</sup>. Combining the two industries in one factory will simply means that they will share the same infrastructure. Moreover the LNG industry will be benefited from the energy produced from the GTL industry especially in the cooling field. These issues will definitely help in reducing the capital costs of both industries. On the other hand, the presence of a joint terminal will help in exporting the products of the two industries. It will be also possible to maneuver between the products of the two industries according to the state of the markets, i.e. it will be



possible to increase the products of one industry on the account of the other according to the products needed by the markets. These benefits pushed the investors to plan for build combined GTL and LNG factories in Nigeria, Qatar, Egypt, Iran, and Australia.

The GTL industry dose not compete the LNG industry for a very simple reason which is the difference between their products. While the LNG industry produces only a single product, we find the GTL industry produces a wide spectrum of products. The only single factor which the two industries share is the raw material, and this is the natural gas. However, the earth content of this material is so large that can cover the needs of both industries. Therefore, it is not expecting that the spreading of the GTL industry in the future will have a big impact on the LNG industry. Nevertheless, it is expecting that the GTL industry will attract the investments more likely than the LNG industry because the former produces many products, while the later produces only one single product. Moreover, the GTL products are easy to transport, while the transportation of the LNG is very difficult and expensive. In addition to that, the exportation of the GTL products does not need special terminals or tankers as the LNG does. From the cost point of view, both industries are very expensive, but in general the GTL industry needs less investment than the LNG industry <sup>(81)</sup>.

## **5- The Impacts of the GTL Industry on the Utilization of the Clean Fuels:**

Substituting alternative fuels (clean fuels) is being promoted as a way to combat urban air pollution. These fuels which are also called **Green Fuels** have little pollution impacts on the environment. Each of these suggested fuels has one or more of the following general features:

- **Non Toxic.**
- **Non Pollutant.**
- **Non Corrosive.**
- **High octane number.**
- **Wide flammability limits.**

The primary suggested alternative fuels include:

- **Alcohols, like Methanol and Ethanol.**
- **Compressed Natural Gas (CNG).**
- **Liquefied Natural Gas (LNG).**
- **Liquefied Petroleum Gas (LPG).**

- **Hydrogen.**
- **Biodiesel.**
- **Electricity.**

As far as the emission is concerned, the emissions from the clean fuels which have bad effects on the environment are reduced by the following ratios compared to the conventional fuels:

- **No emission of VOCs.**
- **85- 90% less emissions of Hydrocarbons (HC).**
- **25% less emission of CO<sub>2</sub> gas.**
- **80% less emissions of NO<sub>x</sub> gases.**
- **97% less emission of the particulate matters (PM).**
- **85-90% less emissions of the hydrocarbons which produce the ground ozone.**

These ratios of emissions resemble so much the emissions from the GTL fuels with only some exceptions. This fact makes some technicians to categorize the GTL fuels as parts of the clean fuels, while some others put them as a different category.

Most of the clean fuels (except biodiesel) have high octane numbers (>105), and are used as alternatives to gasoline. In spite of the good specifications of these fuels and their positive impacts on the environment, they still have some technical problems especially because they need to modify the normal engines to be capable to use them. The production of new engines which are designed to use the clean fuels directly is very expensive. Moreover, the production of some clean fuels like the Methanol and the Ethanol is very expensive. Other than fuel cost, the major barrier that most clean fuels must overcome is the need to compete with the highly developed technology and massive infrastructure that exists to support the production, distribution, and use of gasoline as the primary fleet fuel. Any new fuel must compete with the ready availability of gasoline throughout any country. Therefore the using of the alternative fuels is not expected to spread in the near future in any way.

The most used clean fuels at the present time are the natural gas products, especially the liquefied petroleum gas (LPG). This fuel is cheap, easy to produce, available, and has been used as a fuel for a long time. Despite these good characters, the LPG is a dangerous fuel because it is heavier than the air and accumulates in the low places. For this reason, the using of the LPG started to diminish in the past ten years in favor of the LNG

and the CNG fuels. Although these two fuels are safe to use, and have good combustion features because of their high octane number (>120), but they still have some disadvantageous like the high production costs, and the high engine modification costs.

For Alcohols, the major barriers are potentially high fuel costs and the lack of pipelines, filling stations, and other pieces of a supply infrastructure; some nagging problems with vehicle performance need to be solved, but these seem likely to be of lesser importance than the cost and infrastructure problems. The other two clean fuels (biodiesel and hydrogen) are still under developments, and haven't been commercially used yet.

It may sound that the promotion of the GTL industry and the spreading of its light and middle products compete with the production and using of the clean fuels, especially with those derived from the natural gas since both kinds are used for powering highway vehicles. Although these two kinds of fuels are similar in many specifications, they are still different in many other things like the costs and methods of production, and this makes the competition between them not so tight. The GTL naphtha for instance is bad because of its low octane number, and it is not good for the production of high quality gasoline. This naphtha is suitable to produce ethylene through the cracking units, which then can be transferred to good gasoline by the polymerization units. This complicated method of producing the GTL gasoline does not compete easily with many clean fuels which can be used as alternatives to the ordinary gasoline directly. The GTL diesel also does not compete with most of the clean fuels (except the biodiesel) because it is used by the Compression Ignition Engines (CI) and not by the Spark Ignition Engines (SI) where the clean fuels are used.

The following figure shows a comparison among the conventional fuels, the GTL fuels, and some of the clean fuels. The chosen fields of comparison are the Energy Efficiency, Fuel Economy, and the Air Quality. It can be seen clearly from the picture that the best fuel among all the compared fuels is the GTL diesel.

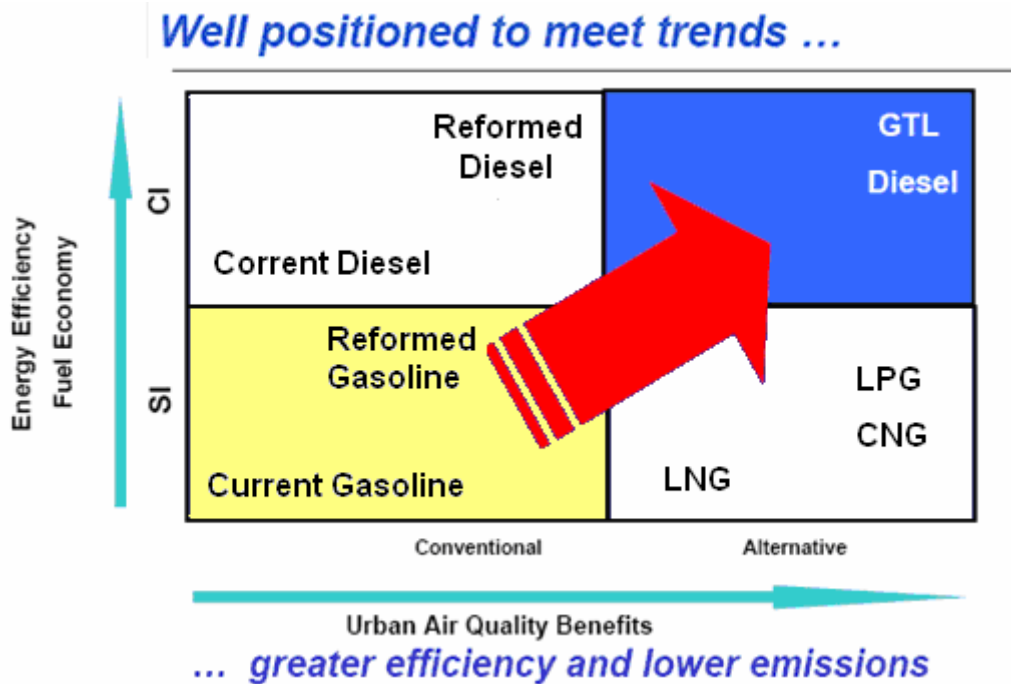

**Figure (4-8): Comparing the most known fuels**

## **6- The Future of the GTL Industry from the Industrial Outlook.**

The future of the GTL industry depends mainly on the success of the projects under construction, especially the giant projects which are being built in Qatar. The startup operation of these projects which is expected to take place in 2010 will prove definitely whether this industry is economically competitive or not. Since these projects are based on different technologies, the startup operation will also prove which one of these is the best in the production, economy, and the quality of the products.

In general there are three expected options for the future of the GTL industry, these are:

- a- The optimistic path:** In this path, it is considered that the new under construction GTL projects will extremely succeed, and at least 3 new projects will be built yearly around the world. According to this, the total production of the GTL industry is expected to reach 3.5 MMbbl/day in 2020.
- b- The moderate path:** In this option, a moderate success of the GTL projects will occur, and therefore the investors will not be

encouraged enough toward the investments in this field. Only 1-2 new GTL projects are expected to be built yearly making the total daily production of the GTL industry about 2 MMbbl in 2020.

**c- The pessimistic path:** In this scenario, it is assumed that the new GTL projects will not gain the expected success, and the investors will lose the intention to invest in this field. This event will keep the GTL total production around 500,000 bbl/day.

Figure (4-9) shows the development of the production capacity of the GTL projects since 1990 until 2020 <sup>(82)</sup>.

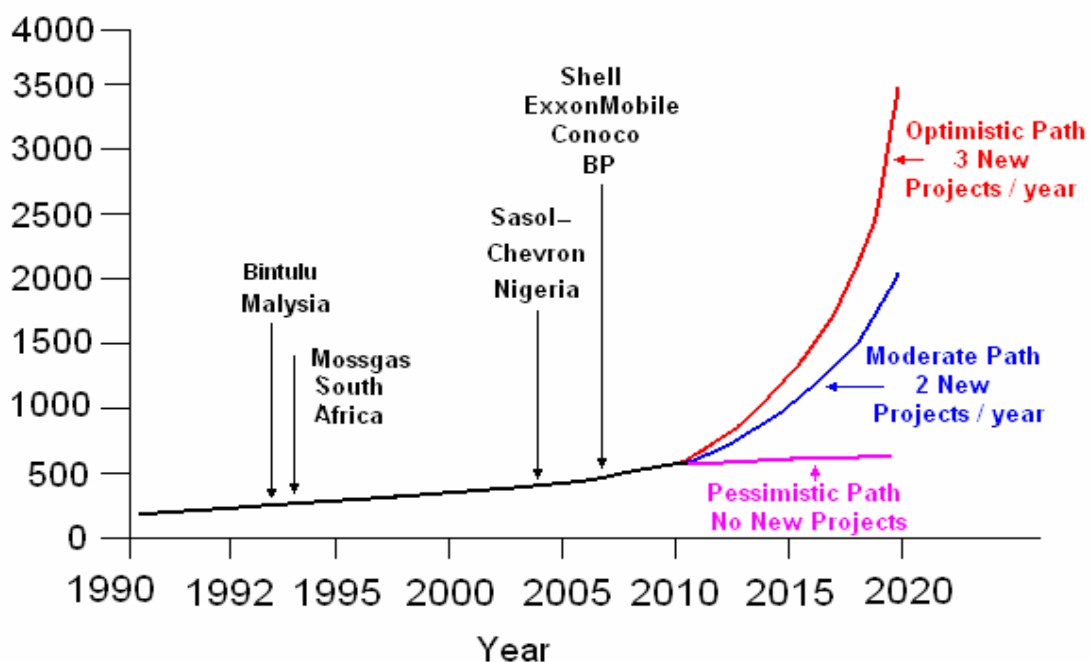

**Figure (4-9): The production capacity of the GTL projects since 1990 until 2020**

Most of the available signs expect that the under construction GTL projects will achieve big successes, because all the developments implemented during the past 20 years have proved this fact. This has been shown clearly from the demonstrations carried out by the GTL specialized companies. Therefore, it is not strange to expect that the number of such projects will steadily increase in the future.

The big problem which the world will suffer during the coming 20 years is not the shortage in the fossil fuels, but the shortage in the light and middle petroleum products. Presently, the total production capacity of the working GTL plants is a 35,000 bbl/day (Mossgas and Bintulu plants),

added to this a 30,000 bbl/day, which is the capacity of the new GTL plant in Nigeria. The total capacity of the new GTL projects that have been announced to be constructed in several countries reaches 1.1 MMbbl/day, which means that in 2010 the whole GTL production will be around 1.2 MMbbl/day <sup>(60)</sup>.

The United States and the European Union are seeking to replace a considerable portion of the road fuels with alternative fuels, to reduce their dependence on the exported oil, and to protect their environments. For example, the European Union countries are planning to replace 23% of their consumed road fuels in 2020 by clean fuels like natural gas based fuels (LPG, CNG, and LNG), alcohols, biodiesel, hydrogen ...etc. In general, these countries are aiming to change at least 10% of their total consumed fuels in 2020 by alternative fuels, whether they are clean fuels or GTL fuels <sup>(73)</sup>. The following table elucidates clearly that in 2020, Europe will need a 325 MTOE of road fuels of which 175 MTOE is diesel only.

<b>Fuel (MTOE / Year)</b>	<b>2000</b>	<b>2005</b>	<b>2010</b>	<b>2020</b>
<b>Gasoline</b>	132	142	144	150
<b>Diesel</b>	140	155	170	175
<b>OIL Based Fuel</b>	272	297	314	325
<b>Biodiesel</b>	-	2%	6%	8%
<b>Natural Gas Based Fuel</b>	-	-	2%	10%
<b>Hydrogen</b>	-	-	-	5%
<b>Total Percentage</b>	0%	2%	8%	23%

**Table (4-7): The European Union plans to use alternative fuels for the years 2000 – 2030.**

This means that the European countries will need in 2020 around 17.5 MTOE of clean based diesel, and they expect that the GTL industry could cover at least half of this quantity, i.e. about 10 MTOE.

Table (1-1) in Chapter one, shows that the world demand in 2020, for road fuels will be 3698 MTOE, of which 2000 MTOE are middle products (diesel). The GTL industry is not expected to cover then more than 150 MTOE. In fact these quantities of GTL products are very much higher than the capacities of the planned GTL projects during the coming fifteen years. This difference between the product and demand will encourage in the future the investing in this line of industry, and therefore, the future of this industry is very much expected to be prosperous.

# Chapter Five

## The Gas to Liquids (GTL) Projects

## 1- Introduction.

The world proven and potential gas reserves are about 6040 Tcf <sup>(2)</sup>, most of them occur in the middle east and the former soviet union countries, while the rest are distributed around the world.

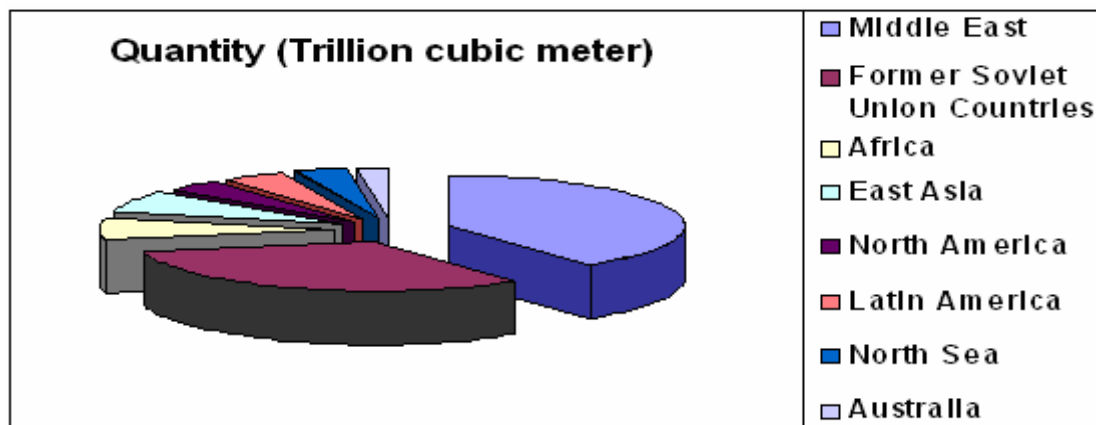

**Figure (5-1): The distribution of the oil reserves around the world**

The sizes of these reserves of natural gas vary from one country to another. While some countries have huge reserves of this fuel, others do not have it at all. The presence of oil reserves in a country does not mean definitely that it should have a natural gas fortune as well. There are some countries which have big oil resources, but do not have enough natural gas to cover their needs, like Kuwait. In contradiction to this we find some countries that have moderate oil fortune, but have giant natural gas reserves, like Egypt. The following table shows the distribution of natural gas reserves among the different countries around the world.

Country	Reserves (Tcf)	Percent of World Total (%)
Russia	1,680	27.8
Iran	940	15.6
<i>Qatar</i>	<i>910</i>	<i>15.1</i>
<i>Saudi Arabia</i>	<i>235</i>	<i>3.9</i>
<i>United Arab Emirates</i>	<i>212</i>	<i>3.5</i>
United States	189	3.1
Nigeria	176	2.9
<i>Algeria</i>	<i>161</i>	<i>2.7</i>
Venezuela	151	2.5
<i>Iraq</i>	<i>110</i>	<i>1.8</i>
Indonesia	90	1.5
Malaysia	29	0.5



Norway	75	1.2
Turkmenistan	74	1.2
Uzbekistan	71	1.2
Kazakhstan	66	1.1
Netherlands	65	1.1
Canada	62	1.0
<i>Egypt</i>	<b>57</b>	<b>0.9</b>
Ukraine	40	0.7
Rest of World	649	10.7
<b>Total of Arab World</b>	<b>1685</b>	<b>27.9</b>
<b>Total of World</b>	<b>6,040</b>	<b>100.0</b>

**Table (5-1): The natural gas reserves around the world**

Many of the above countries, like the countries in the Middle East, for example, have huge reserves of natural gas but little local market for it and no pipeline infrastructure to ship it to larger economies. GTL can convert it into liquid form that is easier to export. This is the same reason why such countries convert natural gas into methanol and liquefied natural gas (LNG). To build a successful GTL project in any country, there are some conditions and requirements that must be present<sup>(83)</sup>. The factors affecting a GTL project are similar to those for LNG projects. The most important factor is the availability of large, low-cost gas reserves that need a market. A list of important factors follows:

- Large gas reserves are required: 4 - 5 Tcf minimum are required to provide a 500 - 600 MMscf/day supply for 25+ years.
- Expansion opportunities are desired: Beyond the minimum reserves, ideally 10 - 20 Tcf should be available to allow future expansion opportunities (similar to LNG).
- Low gas price is necessary: Just like LNG, GTL projects are very capital intensive and require low-cost feedstock gas that is isolated from high-priced gas markets.
- Rich gas is better: The higher the Btu content of the feedstock gas, the better. Again, like LNG, natural gas liquids can provide additional revenue to support the capital-intensive project.
- The gas field must be remote or stranded, and difficult and expensive to transport to markets.
- There should be no other possibility to invest the gas field with any other conventional project.
- Integration opportunities are helpful: If a GTL project can be integrated with other industrial facilities and share common infrastructure, the project will be enhanced.

- The gas field should be located in a place not far from an exporting point like a port, pipeline, highways...etc.

Most major oil companies have plans to build GTL commercial or pilot plants. Counting ongoing and future GTL projects is difficult, partly because their status and number changes (usually upward) so often. If one includes all pilots, projects, proposals, feasibility and Front End Engineering Design (FEED) studies, there are roughly 40 projects worldwide of a total production capacity around 3.4 MMbbl/day. Within these projects about 10-15 GTL plants planned for construction within the next 10 - 15 years.

## **2- The GTL Projects around the World.**

The main GTL projects worldwide can be divided into two categories:

### **a- Current GTL Projects:**

These are the projects which already exist, and have worked for some time.

- Although the Sasol's units: Sasol I, Sasol II, and Sasol III are CTL (Coal to Liquids) and not GTL units, but they still can be considered as some kind of GTL plants since at the end they use the (F-T) technology to convert synthesis gas into synthesis liquid products. Sasol I in Sasolburg started production in 1955. It produced fuels, waxes and gases from low-grade coal. 5,600 bbl/day of liquid fuels are manufactured by Sasol I, together with about  $1.7 \times 10^6$  m<sup>3</sup>/day of gas <sup>(1,40)</sup>. Sasol II facility in Secunda started production in 1980. In 1982 Sasol III was built next to Sasol two. The new two plants have an output of approximately 50,000 bbl/day <sup>(10)</sup> each. After several improvements during the past 25 years, the total productions of the three units have reached about 150,000 bbl/day.
- The Mossgas plant at Mossel Bay, South Africa was completed in 1992 and is the world's largest GTL plant. It produces 23,000 barrels per day (750,000 tons per year) of liquid petroleum products.
- Shell's plant at Bintulu, Malaysia was completed in 1993. It produces approximately 12,500 barrels per day (500,000 tons per year) <sup>(37)</sup> of liquid petroleum products and high valued specialty products.

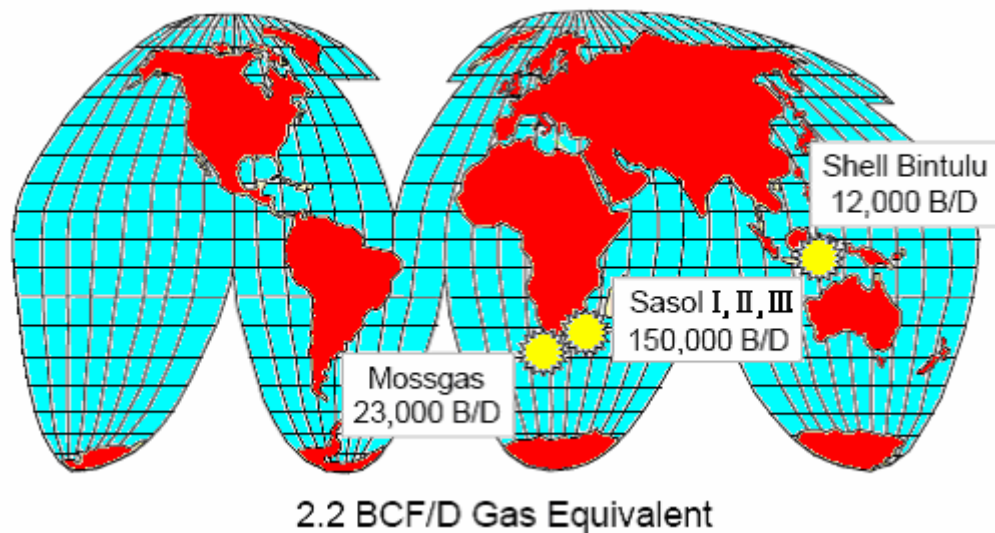

**Figure (5-2): The GTL projects around the world until 2000**

### **a- Potential GTL projects:**

These are GTL projects which are under construction or planning.

- **Nigeria:** To eliminate 300 MMscf/day of flared gas in Nigeria, Chevron, NNPC and Sasol intend to build a 33,000 bbl/day GTL/naphtha plant in Escravos, Nigeria. It appears that this project will proceed since joint venture and FEED contracts have been signed. This is part of a larger three-phase project that already processes 200 MMscf/day conventionally. Completion is slated for 2005<sup>(84)</sup>.
- **Australia:** With an estimated 130 Tcf of uncommitted gas off its northern coast, Australia has seen several proposed GTL projects. These include Sasol Chevron's specialty fuels and Shell's specialty fuels plants, and Japan DME Ltd.'s dimethyl ether/methanol plant. Syntroleum's Sweetwater plant at Burrup Peninsula has a \$500 million engineering, procurement and construction contract with German-based Tessag. The plant's operating capacity will be about 10,000 bbl/day of specialty products. The project is now seeking financing<sup>(78)</sup>.
- **Chile:** Syntroleum, Chile's ENAP and Advantage Resources Int'l. will conduct a project assessment for a 10,000 bbl/day synthetic fuels plant. The project will be built using Syntroleum technology<sup>(78)</sup>.
- **South Africa:** Mossgas will build a new GTL plant for the production of a 70,000 t/yr of specialty fuels and distillates. The facility will be located at Mossel Bay, South Africa, and is scheduled for completion by late 2002.
- **South Africa:** There is an intension to develop Ibhubesi gas field in South Africa by building a 10,000 bbl/day GTL project by Forest Oil Company using Rentech technology<sup>(39)</sup>.

- **Iran:** Sasol is conducting a feasibility study for building a big GTL project in Iran which will be its third outside South Africa after Nigeria and Qatar <sup>(85)</sup>.
- **Iran:** Shell is discussing the construction of a GTL project together with an LNG project similar to that which the company is intending to build in Egypt. The production capacity of this project will be 75,000 bbl/day of GTL fuels.
- **Indonesia, Malaysia, Argentina and Trinidad:** Shell is also surveying the feasibility of GTL plants in Indonesia, Malaysia, Iran, Argentina and Trinidad. The company has said that it intends to build at least four 75,000 bbl/day plants (requiring 600 MMscf/day supply each) at a combined cost of \$6 billion.
- **Indonesia, Brazil, Sweden, and South Africa:** Rentech Company is implementing many studies for building GTL projects in these countries either by direct investments or by sharing with local companies.
- **Bolivia:** A memorandum of understanding (MOU) has been signed between Rentech Company and Bolivia GTL Company to plan and build a GTL project in Bolivia. After signing the MOU the company will build a 10,000 bbl/day GTL project which can be extended in the future to a 50,000 bbl/day.
- **Alaska:** ExxonMobile is planning to build a GTL project in Alaska to produce 100,000 bbl/day of GTL fuels.
- **Alaska:** The British company (BP) is building a GTL pilot plant in the territory of Nikiski in Alaska, to convert 3 MMscf/day of natural gas into a 300 bbl/day of GTL fuels.
- **Angola:** ExxonMobile Company is intending to build a 50,000 bbl/day GTL factory in Angola <sup>(39)</sup>.
- **Ethiopia:** There is a plan to construct a 20,000 bbl/day GTL factory in Ethiopia. This factory will be implemented by Sicor Inc.Houston and Gazoil Ethiopia companies <sup>(39)</sup>.
- **Bangladesh:** Shell is conducting a study to build a 50,000 bbl/day GTL plant in Bangladesh.

### **3- The GTL Projects in the Arab Countries.**

The GTL projects are expected to spread in the Arab Countries similar to its spreading around the world. This issue is natural, since many Arab Countries have huge natural gas reserves. In fact the Arab Countries only have more than a quarter of the total world natural gas reserves, as shown in Table (5-1).

In the past this fortune was wasted because of the burning of the associated natural gas which was produced with the oil. After long time of burning, the Arabic countries have realized how they are damaging their environment, as well as the importance of this material as a fuel. Eventually, these countries have decided to pay a big deal of attention to this fortune and to stop wasting it for nothing. Starting from the early eighties projects were constructed in many Arab countries to export the natural gas to the outside world either by installing long pipelines, or by transferring it to LNG. By the end of the previous century, serious thinking of building Gas to Liquids (GTL) projects immersed in some Arabic countries, especially those which own giants natural gas fortune, and here are some of projects.

### **a- The GTL projects in Qatar:**

Qatar is preparing the ground to become the world's leading producer of clean fuels using gas-to-liquid (GTL) technology. With its huge reserves of natural gas in the offshore North Field (**Ras Laffan**), Qatar is setting the pace for what looks like being a major growth area in the global hydrocarbon industry.

The following is a list of the various GTL projects under way or under discussion in Qatar <sup>(56, 86)</sup>:

- Qatar's first GTL project entered the front-end engineering and design (FEED) stage in July 2001, coinciding with the signature of a joint-venture agreement between Qatar Petroleum (QP with a 51% stake) and South Africa's Sasol – Chevron to develop a GTL project at Ras Laffan Industrial City which will convert natural gas into 34,000 bbl/day of high grade fuels from two trains. The plant, scheduled for start-up in 2010 and using Sasol's Slurry Phase Distillate (SPD) technology, will produce around 24,000 bbl/day of transport fuel (diesel), 9,000 bbl/day of naphtha and 1,000 bbl/day of LPG. – meaning that 75% of the products will be high quality transport fuel and 25% naphtha. The liquid fuels produced will contain virtually no sulfur and have a high cetane number and very low aromatic content in the diesel.
- ExxonMobil GTL project is for the production of synthetic GTL products in excess of 102,000 bbl/day. Feedstock for the GTL Plant will be provided from two wellhead platforms; approximately 1.8 BSCFD will be required to yield the target GTL production. The project will produce base oil stocks in addition to the synthetic fuels. Onshore gas treatment and NGL recovery plants will benefit, to the maximum extent possible, from the existing RasGas infrastructure to

reduce the overall project cost. LPG, condensate and sulphur storage/loading will most likely be shared with other ongoing projects at Ras Laffan. The HOA signed in July 2004 specifies the principal terms for the project that will be defined in a Development and Production Sharing Agreement (DPSA). The term of the DPSA will be 25 years from the start of production, which is expected to commence in 2011.

- Canada's Ivanhoe Energy has completed a feasibility study for a 180,000 bbl/day GTL project (to be brought on-stream in two 90,000 bbl/day phases) with technical aspects of the project now under discussion. QP decided to by-pass the letter of intent stage and go straight to the detailed terms of reference. In October 2000, Ivanhoe upgraded its Syntroleum Process volume license to a full master license status, enabling the company to pursue GTL projects around the world. The project is expected to start production in 2007.
- ConocoPhillips is planning to build the biggest GTL two phases project in the world, each producing approximately 300,000 bbl/day of GTL products - naphtha and diesel using Conoco technology. The project also includes a Methanol production plant of 1 million tones/year capacity. Two wellhead platforms with adequate number of wells will provide the required feedstock for the GTL plant. The company completed a feasibility study that was submitted to QP mid 2003. A Statement of Intent to proceed with the project was signed with QP in December 2003. The company intends to proceed with pre-FEED work during 2004. Startup of the first phase of the plant is scheduled for 2010. The project is structured on the basis of a Production Sharing Agreement, as with all other large-scale GTL projects.
- Shell's GTL is an integrated project which will develop about 1.6 BSCFD of North Field gas to produce approximately a 140,000 bbl/day of synthetic fuels and base oils. The project will be developed in two phases with the first phase operational in 2009, producing around 70,000 bbl/day of GTL products with the second phase to be completed less than two years later.
- The Marathon GTL project company is intending to build a GTL project in Qatar to produce approximately 80,000 bbl/day of naphtha and diesel. The project will consist of two trains of equal capacity. Phase I first commercial production is planned for 2010.



**Figure (5-3): The GTL projects in the north gas fields of Qatar**

**b- The GTL projects in Egypt:**

Egypt entered the world of natural gas investments since the mid nineties of the previous century, and it is preparing itself now to be one of the largest natural gas producers in the region. The biggest project ever Egypt is implementing at the present time is the Arab Natural Gas Pipeline. When this project is finished it will transport the Egyptian natural gas to Cyprus, Turkey, and the European countries. Egypt also has taken serious steps to the world of the clean fuels by starting to use the compressed natural gas (CNG) as road transports instead of gasoline and diesel. This step was very necessary due to the high percentages of pollution in the atmospheres of the big cities like Cairo.

In the field of gas to liquids technology, Egypt is aiming to build big GTL projects, and it has signed some agreements with experienced companies in this technology as shown below <sup>(87)</sup>:

- Shell Company and the Egyptian General Petroleum Corporation (EGPC) have signed, with the approval of Egypt's Petroleum Minister, a Development Protocol for a 75,000 bbl/day Gas to Liquid (GTL) conversion plant using Shell's Middle Distillate Synthesis (SMDS) process and at least one LNG train, to convert Egypt's natural gas to environmentally friendly synthetic fuels. Presently, West Demiatta on the Mediterranean coast is the proposed location.

- Ivanhoe Energy and the Egyptian Gas Company (EGAS) have signed an MOU to conduct a Feasibility Study about building and operating a GTL project in Egypt. If they prove that the project will be cost effective, then the Egyptian company will take care to provide it with a 4.2 Tcf of natural gas for twenty years in daily rate of 600 MMscf/day. The production capacity of the project is expected to be 45,000 - 90,000 bbl/day.

### **c- The GTL projects in the other Arab Countries:**

There are some other Arabic countries which are planning or at least thinking to invest their natural gas fortunes by building GTL projects, and here are some of these countries:

- **Algeria:** The Algerian Ministry of Mines & Energy and Sonatrach, the Algerian national oil company, are soliciting bids for a 34,000 bbl/day GTL project at Arzew using potential gas reserves in the Tinrhert <sup>(88)</sup> area. Sasol-Chevron, the joint venture between Sasol and Chevron Corporation submitted a non-binding technical proposal at the end of September 2005. The Algerian authorities have set the middle of 2006 as the date for commercial submissions.
- **Saudi Arabia:** Saudi Arabia, looking at 235 tcf of largely unexploited natural gas reserves, could become the site of one or more gas-to-liquids (GTL) conversion projects, according to industry sources. Saudi Arabian officials are showing increasing interest in GTL technologies for natural gas field development and conversion projects. The Fischer-Tropsch-based GTL process converts gas into middle distillates such as diesel, jet fuel, gas oil and kerosene as well as naphtha. The Saudis are not interested in LNG at this time, because margins for grassroots projects are too low to make those facilities economically viable. The sources also said neither Saudi Aramco nor the kingdom's Ministry of Petroleum and Minerals is interested in partnerships for oil production ventures. With 8 million bpd of production and another 2 mm bpd of spare capacity, Saudi Arabia doesn't need help in producing more oil. Saudi Arabian Crown Prince Abdullah and Ali Naimi, who is both minister of petroleum and minerals and chairman of Saudi Aramco, recently met with a group of major U.S. oil companies included Arco, Conoco, Exxon and Texaco. Each of these has GTL efforts in varying stages of development, using either their own or licensed technology. Saudi officials also have contacted Syntroleum, the Tulsa-based GTL technology developer, regarding its process. Mid-level and technical representatives from Saudi Aramco also have attended several GTL conferences in the past year.



- **Oman:** Oman, which relies on oil for about 40 % of its gross domestic product, is considering building a plant that converts natural gas to liquid (GTL) products using supplies from Qatar, an Omani oil ministry official said. Oman may build the gas-to-liquids plant at Sohar, about 260 km (160 miles) northwest of the capital, Muscat, after the country starts taking supplies of Qatari gas via the UAE, Khalifa Mubarak Al Hinai, technical adviser at the oil ministry, said. "The Dolphin project is coming up in the near future, so we should be able to import some of the gas from Qatar," Hinai said. Dolphin Energy, a joint venture of Occidental Petroleum, Total and Abu Dhabi, is a \$ 3.5 bn project to pipe 2 Bcf/day of gas from Qatar to the UAE in 2006 and, later, to Oman.

The following table lists the main present and future GTL projects around the world <sup>(46)</sup>.

<b>Company</b>	<b>Country</b>	<b>Capacity (Real or Proposed)</b>	<b>Startup Target (Real or Planned)</b>
Mossgas	Mossel Bay, South Africa	23,000 bbl/day	1992.
Mossgas	Mossel Bay, South Africa	70,000 bbl/day	Unknown
Sasol	South Africa	150,000 bbl/day	1982
Sasol - Chevron	Nigeria	33,000 bbl/day	2005
		30,000 bbl/day	2006
Sasol - Chevron	Australia	90,000 bbl/day	2008
		90,000 bbl/day	2013
Sasol - Chevron	Qatar	34,000 bbl/day	2005
Shell	Malaysia	12,500 bbl/day	1993
Shell / EGPC	Egypt	75,000 bbl/day	2005
Shell	Trinidad	75,000 bbl/day	2005-2006
Shell / NIOC	Iran	70,000 bbl/day	2005
Shell	Indonesia	70,000 bbl/day	Unknown
Shell	Australia	70,000 bbl/day	Unknown
Shell	Argentina	70,000 bbl/day	Unknown
Shell	Qatar	160,000 bbl/day	2009
		80,000 bbl/day	2011
Shell	Bangladesh	50,000 bbl/day	Unknown
ExxonMobil	Alaska	100,000 bbl/day	Unknown
ExxonMobile	Qatar	102,000 bbl/day	Unknown
ExxonMobile	Angola	50,000 bbl/day	Unknown
ExxonMobile	Baton-Rouge	200 bbl/day Pilot Plant	1996

Ivanhoe Energy	Qatar	180,000 bbl/day	2007
Rentech	USA	800 – 1000 bbl/day	2001
BP Amoco	Alaska	300 bbl/day Pilot Plant	2002
BP Amoco	Alaska	85,000 bbl/day	2007
ANGTL	Alaska	50,000 bbl/day	2006
Syntroleum	Australia	10,000 bbl/day	2003
Syntroleum	Shili	10,000 bbl/day	Unknown
Syntroleum	Australia	100,000 bbl/day	2004
Rentech / Forest Oil	South Africa	10,000 bbl/day	Unknown
Rentech / GTL Bolivia	Bolivia	10,000 bbl/day	Unknown
Petroleos de Venezuela	Venezuela	15,000 to 50,000 bbl/day Plant	2004
Conoco	Ponka city, US	400 bbl/day Pilot Plant	2002
Conoco	Qatar	300,000 bbl/day	2010
Reema Int. Corp	Trinidad	10,000 bbl/day	Unknown
Marathon	Qatar	80,000 bbl/day	Unknown
Sicor Inc. / Gazoil Ethiopia	Ethiopia	20,000 bbl/day	2002

**Table (5-2): The GTL projects around the world**

Some of the above listed projects are shown in the following picture <sup>(92)</sup>.

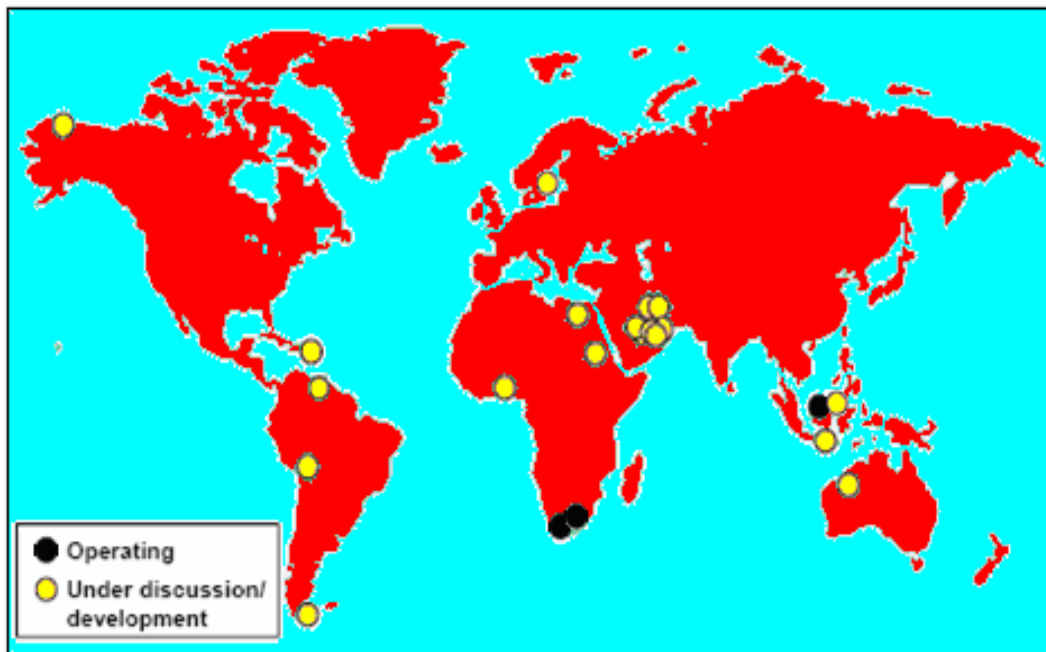

**Figure (5-4): Potential GTL Plants**

# **Chapter Six**

## **The Possibility of Using the GTL Technology in Iraq**

## **1- The Iraqi Natural Gas Reserves and Production.**

Iraq is one of the Arab countries that own a huge fortune of natural gas. The Iraqi natural gas reserves consist of 3090 Bcm (110 Tcf) of proven natural gas, and 9250 Bcm (350 Tcf) of potential natural gas. About 70% of Iraq's gas reserves (2200 Bcm) are associated gas (gas produced in conjunction with oil), with the rest (890 Bcm) made up of non-associated gas (20%) and dome gas (10%), as elucidated in the following...

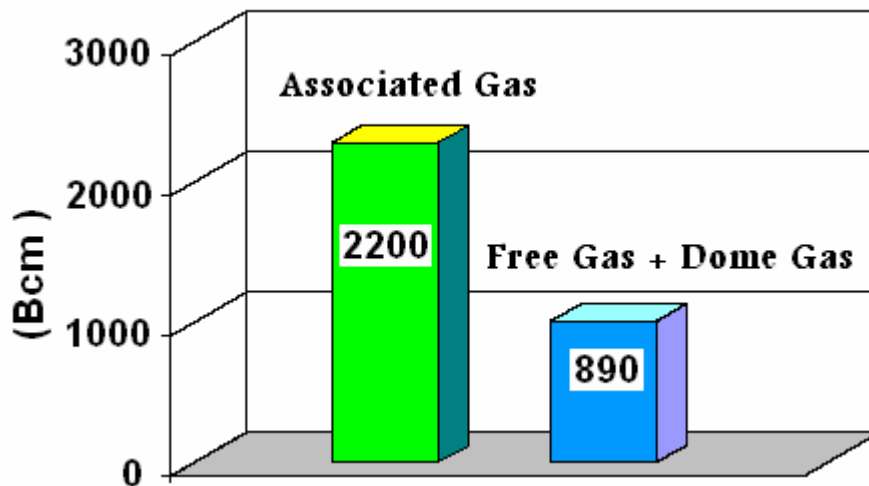
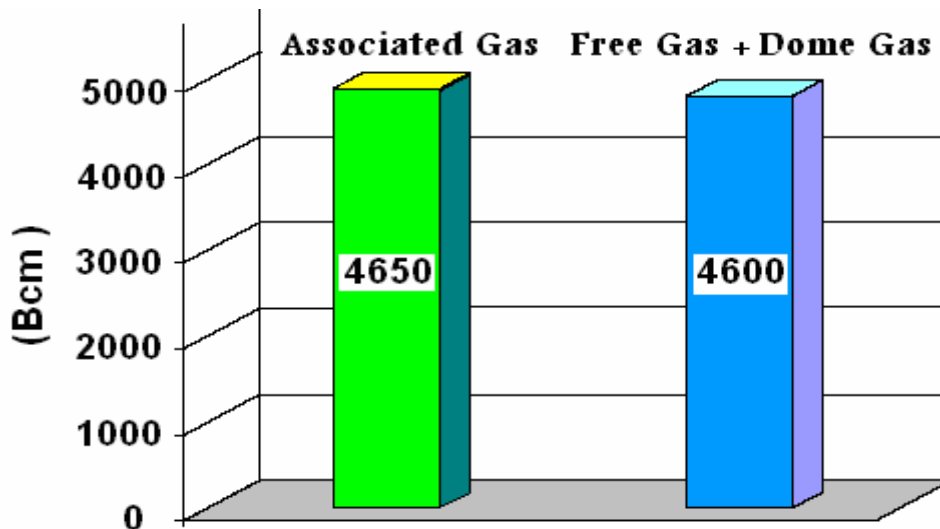

**Figure (6-1): The Iraqi proven natural gas reserves**

According to the evaluation studies conducted in 1993, the Iraqi potential (undiscovered) natural gas reserves are divided into:

- **4650 Bcm associated gas.**
- **4600 Bcm free gas and dome gas.**

It is also thought that most of these reserves are located in the western territories of Iraq. Although, many new studies have pointed out that this region has many geological structures which may have high hydrocarbon contents, it still has not been explored enough, except Saladin (Akas) natural gas field.



**Figure (6-2): The potential reserves of natural gas in Iraq**

The production of natural gas in Iraq started in 1927 with the beginning of oil production. In 1970 the natural gas production reached 6.1 Bcm, then increased in 1979 to 20.1 Bcm (equal to a daily rate of 1900 MMscf/day). After the flare up of the first gulf war (Iraq-Iran war), the production of natural gas decreased because of the diminishing of the oil production, but it started to increase again gradually after the end of the war in 1988 until it reached 16.3 Bcm in 1989. In 1990-1991 a sharp decline in the natural gas production occurred again because of the international embargo which was imposed by the UN organization after the second gulf war. In 1996 the production started to increase after the implementation of the **"Oil for Food and Medicine"** agreement between the Iraqi Government and the UN organization, and it reached 6.5 Bcm (equal to daily rate of 300 MMscf/day) at that year. The production of the natural gas continued to increase gradually due to the continuous increase in the oil production, and it reached about 13.8 Bcm in 2000.

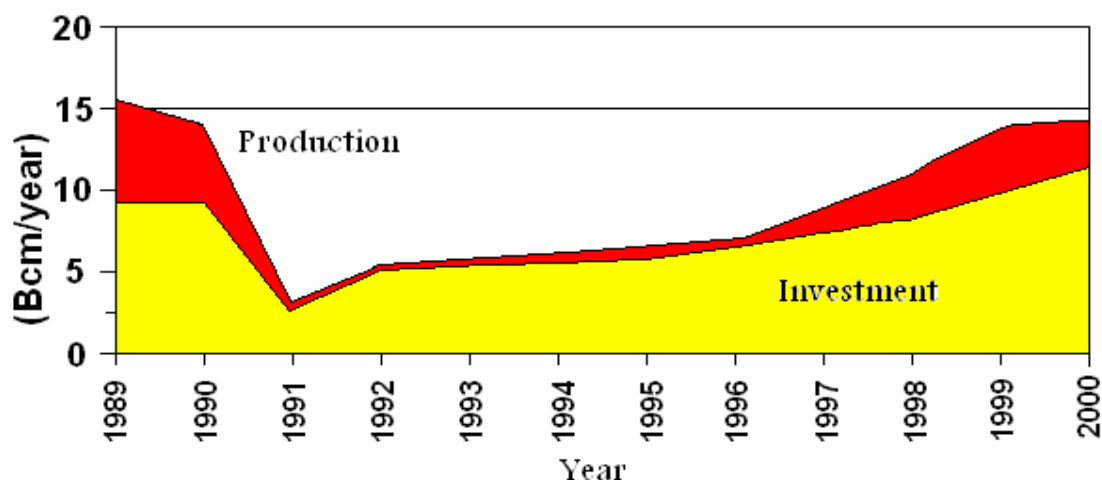
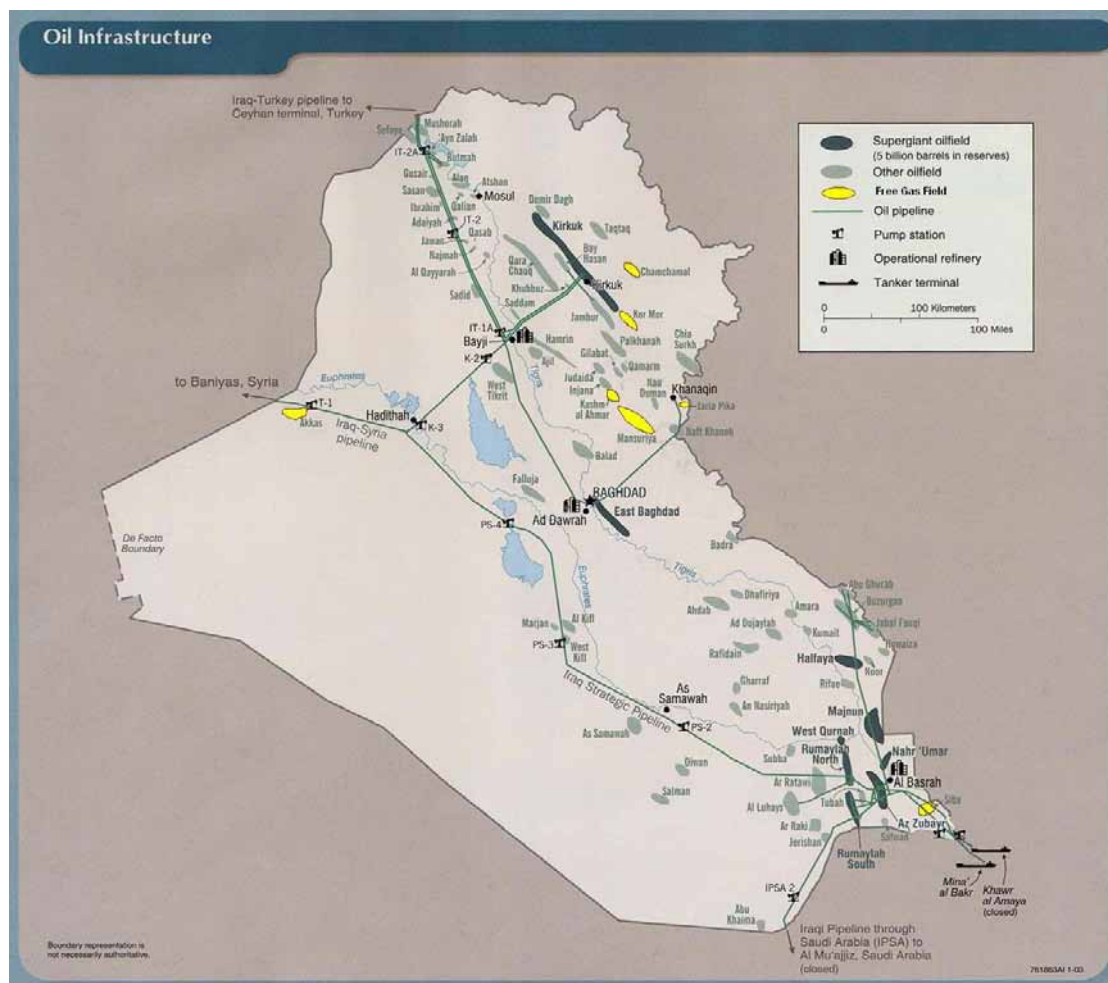

**Figure (6-3): Diagram of the Natural Gas production and investment in Iraq for the period 1989-2000**

Till 1990, all of Iraq's natural gas production was an associated gas. Iraq has hoped to produce 550 Bcf of natural gas annually within two years after the lifting of UN sanctions, and to reach about 4.2 Tcf after a decade of that. In October 1997, Iraq invited international partners to invest in natural gas projects worth \$4.2 billion. Generally, Iraq's policy then was to award gas and oil concessions to companies from countries supporting the easing or lifting of UN sanctions (i.e. France, China, Russia, and Turkey). However, the flare-up of the third Gulf war in 2003 changed all plans and calculations put for the oil and natural gas production.

## 2- The Iraqi Natural Gas Fields

Iraq's primary sources of associated gas in the north are the **Kirkuk**, **Ain-Zalah**, **Butma**, and **Bai-Hassan**. The oil fields in the south which produce associated natural gas are the **North** and **South Rumaila**, as well as **Zubair** fields. About 70% of Iraq's associated gas production capacity is located in the southern part of the country.



**Figure (6-4): The non-associated (free) natural gas fields in Iraq**

The Iraqi non-associated (free) natural gas fields occur mainly in the north region, with an estimated total content of about 300 Bcm (9.5 Tcf). The fields of this region comprise **Al-Anfal** (1.8 Tcf), **Chemchemal** (2.1 Tcf), **Jeria Pika** (0.9 Tcf), **Khashim al-Ahmar** (1.4 Tcf), and **Mansuriyah** (3.3 Tcf). The only free natural gas field that occurs in the south territories is **Siba** (60 Bcm) gas field, located in Shat al-Arab coasts near the Iraqi-Iranian border. In the north-western region of Iraq near the Iraqi-Syrian border, there is a free natural gas field called **Saladin (Akas)** field. This field is considered as one of the huge free natural gas fields in Iraq because of its proven reserve estimated by 70 Bcm (4.55 Tcf).

### **3- Processing of Natural Gas in Iraq**

Gas flaring in Iraq was reduced from roughly 50% in 1989 to fewer than 5% in 1994. This was accomplished mainly through increased use of Iraq's two gas gathering systems, which were built in the 1980s. The Northern Area Gas Project started operation in 1983. It is able to recover and process up to 550 MMscf/day of sour gas, with a resulting maximum output capacity of 300 MMscf/day of dry gas as well as a mix of propane, butane, natural gasoline, and pure sulfur. The Southern Area Gas Project was completed in 1985, but was not brought online until February 1990. It has nine gathering stations and a larger processing capacity of 1.5 billion cubic feet per day. Gas gathered from the North and South Rumaila and Zubair fields is carried via pipeline to a 575-MMscf/day natural gas liquids (NGL) fractionation plant in Zubair and a 100-MMscf/day processing plant in Basrah. At Khor Az-Zubair, a 17.5 million cubic foot LPG storage tank farm and loading terminals were added to the southern gas system in 1990. LPG export capacity was 4 million tons per year in 1990. In addition, Iraq built another system in 1985 to recover up to 200 MMscf/day of gas from the Jambur field.

Iraq's only non-associated gas production is from the Al-Anfal field in northern Iraq. Al-Anfal's gas resources are estimated at 4.5 Tcf, of which 1.8 Tcf is proven. This field was brought online in 1990 with an output of 200 MMscf/day. Al-Anfal gas production is piped to the Jambur gas processing station near the Kirkuk field, which is 20 miles away, then sent to The Northern Area Gas Project to fractionate it to dry natural gas and LPG. No other free natural gas field is developed yet in Iraq.

## **4- Development of the Iraqi Natural Gas Fields**

The development of the natural gas fields in Iraq depends on several factors like the location of the field, size of the reserve, and the specification of the natural gas.

### **a- Development of the north natural gas fields:**

In March 1996, Iraq and Turkey signed an initial memorandum of understanding (MOU) regarding a gas supply deal between the two countries. Their commitment towards this deal was reaffirmed publicly in December 1996 and May 1997. The \$2.7 billion project will involve the building of an 855-mile, 350 Bcf annual capacity gas export pipeline linking northern Iraq to Turkey's Anatolia region. The proposed pipeline will have two compressor stations. Gas will be supplied from five non-associated gas fields in northern Iraq with combined reserves of 9.5 Tcf. These fields comprise al-Anfal, Chemchemical, Jeria Pika, Khashim al-Ahmar, and Mansuriyah. Plans call for development work at al-Anfal and Mansuriyah to tap first, followed by other fields where more limited exploration work has occurred.

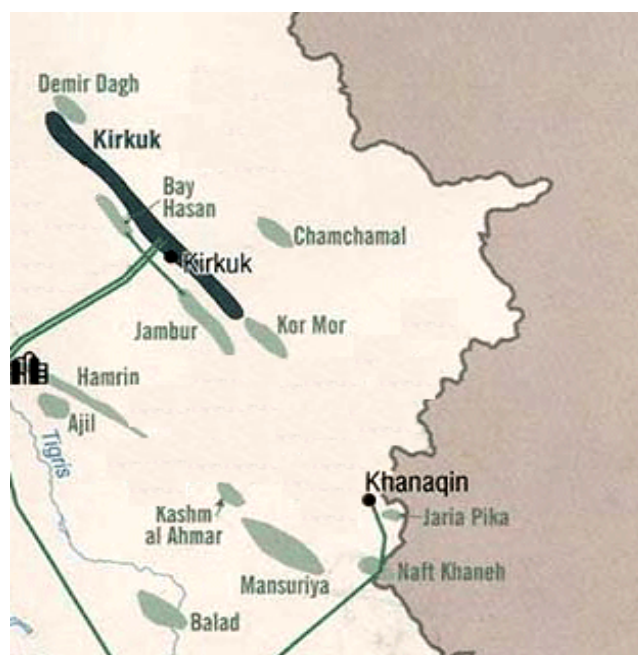

**Figure (6-5): The Iraqi north natural gas fields**

During the first three years following start-up, targeted gas export levels will be 200 MMscf/day, 345 MMscf/day, and 1 Bscf/day, respectively. Of the project's anticipated \$2.8 billion cost, \$1.8 billion will be for field development and pipeline construction work inside Iraq. Iraq is seeking foreign participation in the project and interest reportedly has been shown by Gas de France, BHP, TransCanada Pipelines, and other companies.



The \$1-billion Turkish side of the project will involve Botas, TPAO, and Tekfen, which will be responsible for pipeline construction in Turkey.

In February 2000, Iraq's Oil Ministry named Agip and Gaz de France as leaders on a \$2.3 billion PSA (Production Sharing Agreement) project to develop these fields, which reportedly have total recoverable reserves of more than 10 Tcf. Unfortunately, these agreements have never come to real implementation due to the UN sanctions, followed by the third Gulf War in 2003. After the war, the new Iraqi government reconsidered all the Oil & Gas agreements signed by the previous government, and intended to make new deals especially with the countries which participated in forming the coalition forces.

### **b- Development of the south natural gas fields:**

The only non-associated gas field in the southern part of Iraq is the Siba field. This field is located at Shat Al-Arab River bank near the Iraq - Iran borders. In 2004 Iraq and Kuwait have discussed joint development of the Siba natural gas field. The natural gas of this field is supposed to be exported either to Kuwait, or to other countries.



**Figure (6-6): Siba Gas field in the south of Iraq**

In December 2003, Iraq renewed a natural gas supply agreement with Kuwait that dates back to the 1980s, under which Iraq was to supply natural gas to Kuwait via an overland pipeline. Natural gas used to be pumped from Rumaila into northern Kuwait via a 40-inch, 105-mile pipeline. The gas was used to supply Kuwaiti power stations. Current plans call for Iraqi gas exports to Kuwait of 50 MMscf/day initially, possibly rising to 250 MMscf/day.

Prior to the war, Iraq had even been developing plans to build a liquefied natural gas (LNG) terminal. In late September 2004, Iraq reportedly agreed to join the Arab Gas Pipeline project linking Egypt, Jordan, Syria and Lebanon.

### **c- Development of the west natural gas fields:**

In November 2001, a large non-associated natural gas field reportedly was discovered in the North West region of Iraq (Akas region), near the border with Syria. The field which is named the Saladin (Akas) gas field, placed at a distance of 52 km far away from (T1) pump station of the old Iraq-Syria oil pipeline, and 285 km from (K3) pump station near Hadithah city. The distance between the field and Baji town, where the entire Iraqi gas network passes, is around 300 km. The nearest industrial complex to the field is Al-Qaim fertilizer plant which occurs at a distance of less than 40 km from it.



**Figure (6-7): The location of Saladin (Akas) gas field**

The Saladin gas field is considered as one of the giant fields in Iraq. It contains around 4.5 Tcf proved reserve of natural gas. The first exploring well (SA1) was vertically drilled in this field in August 1992. The drilling was supposed to reach a depth of 5000 m, but this was not achieved due to technical difficulties. The drilling operations in this well confirmed the presence of natural gas with a flow out of around 6-8 MMscf/day.

In 2001 the development of Saladin gas field was referred to the Syrian Petroleum Company (SPI), according to the "**Combined Cooperation Deal**" signed between Iraq and Syria. The company started its operations in field region in mid 2001. The operations consist of drilling 5 bent wells, as well as the workover of the previously drilled well (SA1) by drilling it again Bentley. The explorations made by the company were

ended in mid 2002 after completing the drilling of the following exploratory wells:

- Workover of (SA1) well which was finished in April 2002
- Drilling of (SA2) well which was completed in April 2002
- Drilling of (SA3) well which was completed in March 2002
- Drilling of (SA4) well which was completed in March 2002
- Drilling of (SA5) well which was completed in June 2002
- Drilling of (SA6) well which was completed in June 2002

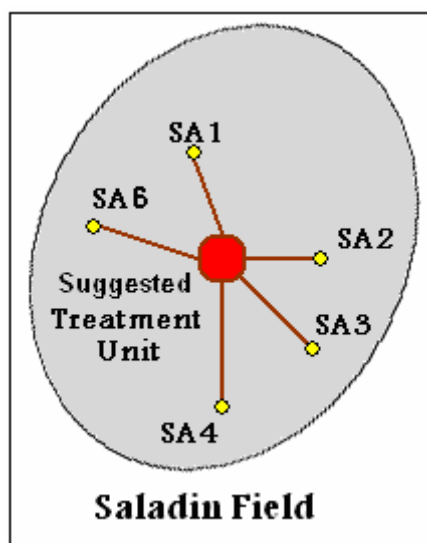

**Figure (6-8): The gas producing wells in Saladin Field, and the suggested treatment unit**

The results obtained from these drilled wells proved that natural gas accumulations exist in regions between 2332-2360 m deep. It also showed that a proven 4.5 Tcf gas reserves already exist, as well as, 6 Tcf potential reserves are expected. The appraisal well number 5 (SA5) has produced water only, while the other wells produced natural gas at a rate of 5-6 MMscf/day.

There are many possible scenarios to develop Saladin (Akas) natural gas field. Any development plan will depend on the production capacity of the field. The expected production goals of the field are as follows:

- (1) Producing a 50 MMscf/day of natural gas by completing and developing the already five drilled exploration wells, and changing them into production wells.
- (2) Increasing the production capacity of the field to 100 MMscf/day by drilling more 5 wells.
- (3) Producing a 300 MMscf/day of natural gas by increasing the number of the gas producing wells to 15-20.

As mentioned above, the plans of investing the natural gas of Saladin field depend on the goal of production which will be adopted. In general, the following plans are some of the options proposed with regard to this issue:

**(1) Producing a 50 MMscf/day of natural gas:**

This production capacity means that only the existing five drilled wells will be considered. The best plan of developing Saladin gas field with this production capacity is by building a power generation plant. Such a plant and its supplements (the switchyard, transmission interconnection ...etc) can be built in the field site, and then be connected with the country grid by high voltage lines to the transforming station near T1 place. The potential power generation of this power plant could be around 225 MW. A slug catcher and small treatment plant are also needed to separate the water and the condensates from the gas.

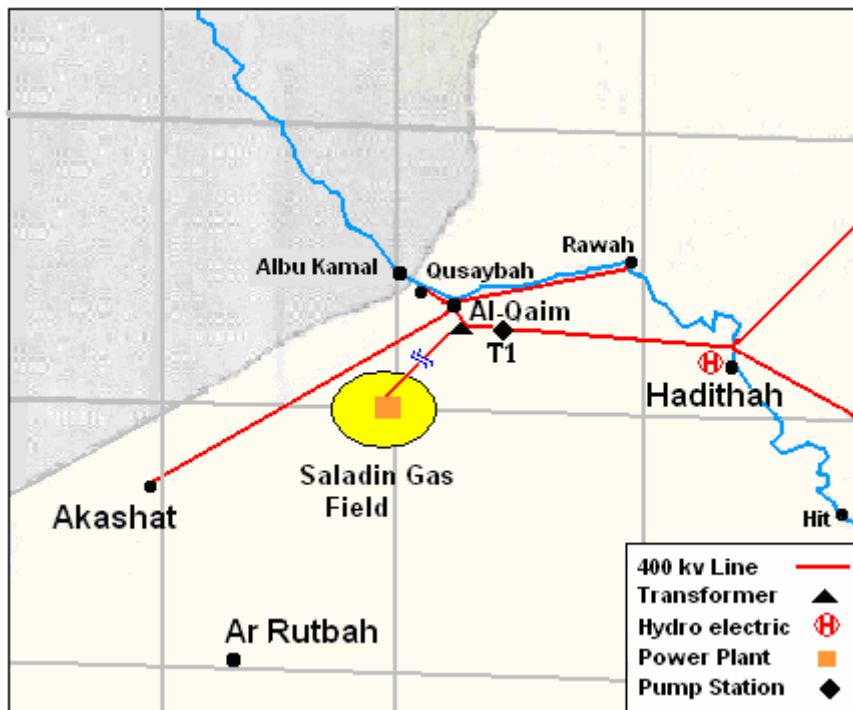

**Figure (6-9): Development of Saladin gas field by building a power plant in the field site**

**(2) Producing a 100 MMscf/day of natural gas <sup>(96)</sup>:**

For this production capacity, it is possible to develop Saladin gas field by two plans:

- Building a big treatment plant in the field consisting of a gas dryer, gas distilling plant, and cooling system. The dry natural gas can then be transported by a 52 km pipeline to (T1) pump station, and then to Haditha (K3), where the country gas pipelines

network passes. The LPG can be transported from the plant to the local markets either by trucks, or by building a 285 km pipeline from the treatment unit to the country LPG network in (K2) pump station. The NGL products can be exported by the old Iraq-Syria oil pipeline, or by constructing a new pipeline for this purpose.

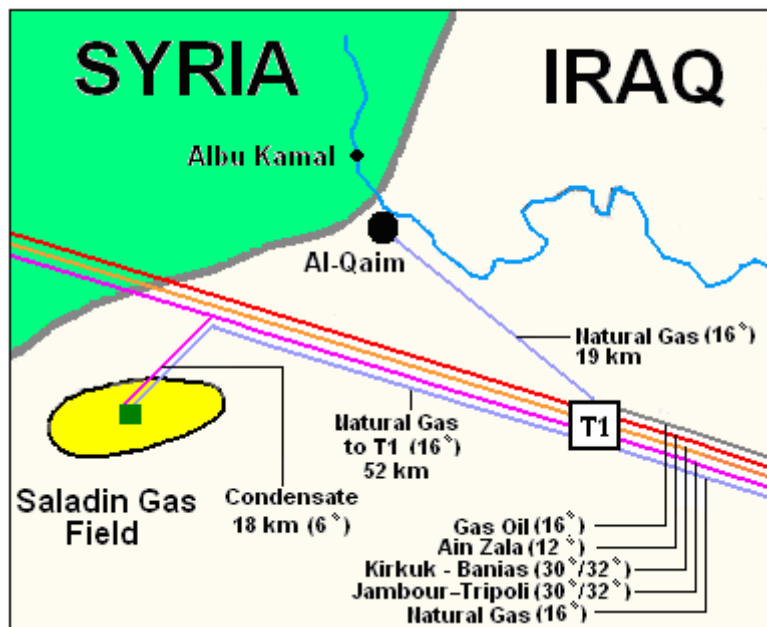
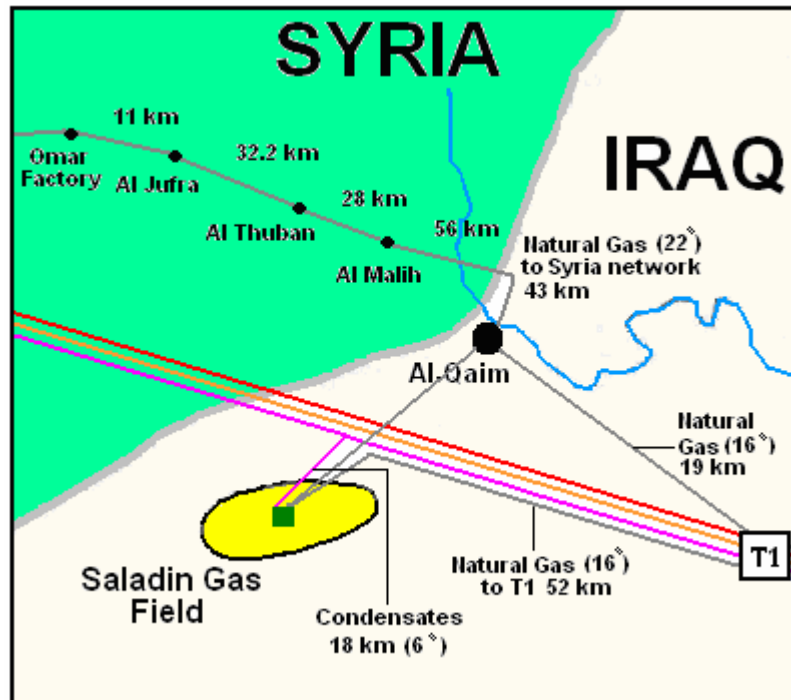

**Figure (6-10): Development of Saladin gas field by building a treatment unit in the field site**

- Collecting the natural gas from the producing wells in the field, and sending it to a high pressure heater to separate the water and the natural gas liquids. The collected natural gas can then be transported by a new 52 km pipeline to (T1) site, where a big treatment unit can be built there to treat the gas.

### **(3) Producing a 300 MMscf/day of natural gas:**

For such a big amount of natural gas, field-site-treatment is better, followed by transporting the products by new pipelines to different directions. A 100 MMscf/day of dry natural gas can be sent to (T1) site by a new 52 km pipeline to support the local gas network. The rest which will be around 200 MMscf/day of dry natural gas can be exported to Syria (Al Malih site) by a 99 km pipeline, where the Syrian gas network ends.



**Figure (6-11): Exporting Saladin's Natural Gas to Syria**

The exported dry natural gas can then be transported throughout the Syrian gas network to the Arab gas pipeline to export it to Europe. The condensates (C5+) can also be exported either by mixing it with the exported natural gas, or separately by the old Iraq-Syria oil pipeline.

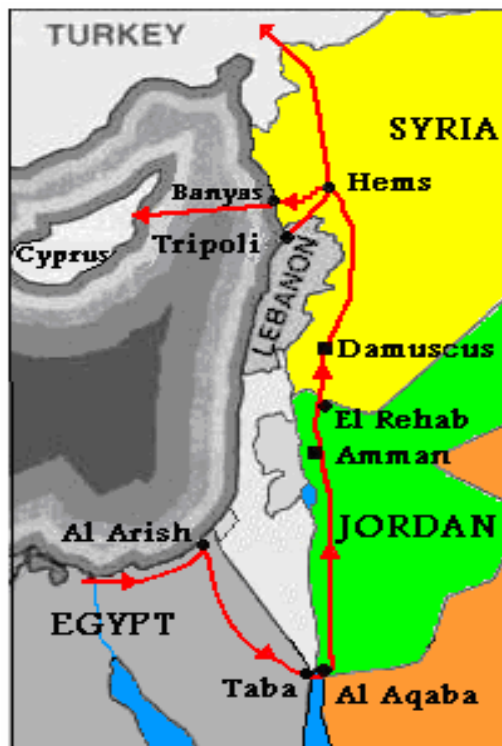

**Figure (6-8): The Arab Gas Pipeline**

## **5- The Possibility of Building a GTL Project in Iraq**

Presently, Iraq is suffering from shortages of the treated natural gas. The reason of this shortage is due to low production of natural gas on one hand, and low production capacities of the north and south treatment projects on the other. Iraq is also suffering at the present time from very big shortages in the electrical power generation and delivery. This shortage is referred to several reasons, political and technical. A considerable percentage of electrical power currently generated in Iraq is produced by burning various liquid fuels including diesel oils, heavy and residual oil. This reliance on liquid fuels results in loss of oil sales revenue in addition to shortages and delivery problems throughout the country. The rising electrical demand in Iraq will create pressure on the electric production, transmission capacity, and fuel production and delivery infrastructure. For this reason natural gas is being considered for use in new electric power generation. Therefore, the electricity generation sector is expected to absorb any rising in the production of natural gas in the future. This situation will continue until the mid of the coming decade, but things may change after 2020, especially if serious developments of the free natural gas fields take place.

Iraq also suffers from huge shortages in the production of petroleum products, especially the light and middle distillates. These shortages are due to the low production capacity of the old fashioned Iraqi petroleum refiners. These shortages are expected to continue until 2025. For example, in 2020 Iraq will need at least 110,000 m<sup>3</sup>/day (695,000 bbl/day) of light and middle distillates, while the local refiners are not expected to produce at that time more than a 60,000 m<sup>3</sup>/day (380,000 bbl/day). The difference (50,000 m<sup>3</sup>/day or 315,000 bbl/day) could be covered in several ways like importing, building at least two new big oil refiners, or investing some of the natural gas by building a Gas to liquid (GTL) project.

The building of a GTL project in Iraq is practicably possible, but this is not expected to take place in the near future due to the shortage in the natural gas production. The quantity of the produced associated and free natural gas at the present time and in the seen future will be used mainly to feedstock the existing power plants, and to produce the LPG which the country also needs most. By the end of the coming decade, things will be changed, and an excess in the availability of natural gas is expected to take place. Nevertheless, the expected extra quantity of the natural gas will be also used to feed new power stations which will be built in the future. Even if an unused quantity of natural gas will be available then, no

intension to invest this quantity of gas in a GTL project is anticipated. The thought of investing in the Gas to Liquids technology needs lots of thinking and studying, because such an investment is not beneficial with all of the Iraqi natural gas fields.

Iraq is now burning huge quantities of associated natural gas due to the lack of the treatment facilities, and this behavior is expected to continue for the next ten years. Despite that this action is a wasting of a fortune; it also damages the environment very badly. But, after the invention of small and mobile GTL plants, installed in any place easily, it becomes possible to buy or even hire such plants and industrialize the flared gas by the GTL technology. This development will save a big fortune to Iraq, as well as protecting the local and the global environment from the harms which the flaring of the gas causes. It will also provide the country during the coming years with millions of barrels of high quality light and middle petroleum products.

As stated previously, to build a GTL project in any place, there are requirements and conditions which must be available. One of the most important conditions in this direction is that the natural gas field must be remote or stranded. Most of the Iraqi natural gas fields, whether they produce associated or non-associated natural gas, are not remote fields because they are located not far from the treatment factories, or the country gas pipeline network. This situation makes things more likely to invest the natural gas in the traditional ways rather than building a GTL projects. The only exception from this is the Saladin natural gas field, and perhaps it is the only Iraqi gas field which can be invested by a GTL technology. In addition to the conventional development plans for this field, it is possible to develop it by building a GTL project. To build a reasonable GTL plant in this field, its production capacity must be at least 300 MMscf/day. This production capacity will be suitable to build a 35,000 bbl/day GTL plant. It means also that the production wells must be increased to about 15 – 20 wells, i.e. the already five drilled wells must be completed, as well as drilling more 10-15 wells. The project will also need a complete gas treatment unit to produce dry natural gas, which is then feedstocked to the GTL plant. The place of the treatment unit must be near the place of which the GTL plant will be built on. As mentioned above, it could be possible to build the treatment unit either in the field site or in (T1) pump station site. Either places are also appropriate to build a GTL plant, but it is better to build an industrial complex combining both the treatment units and the GTL plant in (T1) site for the following reasons:



- (1) The old Iraq-Syria oil pipeline passes through the same place.
- (2) The high voltage electrical line (400 kv) which feeds Al-Qaim industrial complex with power passes through the same place.
- (3) The two facilities can share many of the infrastructures they both need.
- (4) The same industrial complex can be used for the same purposes, if other natural gas fields are discovered in the west region of Iraq.

The creation of a GTL project in Saladin gas field is profitable to Iraq for the following reasons:

- The GTL project will produce petroleum products, which the country needs most for the coming twenty years.
- The high quality petroleum products produced by this project will help in protecting Iraq's environment which is extremely suffering from pollution.
- It will be possible to export some of the produced petroleum products either by using the old Iraqi-Syrian oil pipeline after rehabilitating it, or by building a new pipeline. This action will provide Iraq with much-needed extra income to fund the reconstruction projects.
- In case of applying the federal governing system in Iraq, a GTL project could be the base of establishing a petroleum and natural gas industry in the north-western region, which might form a federation government. It will provide the local governorates of this federation with their needs of petroleum products, as well as employing the workers of the region. Such a policy will bring, from the economic point of view, some stability for this kind of governing system.

# Chapter Seven

## Conclusions and Recommendations

## **1- Conclusions Concerning The GTL Technologies**

- a-** The continuous developments of the GTL technologies have had its big and active effects in improving the performance of the GTL projects, decreasing their costs, and increasing their profitability. These effects helped in promoting the GTL industry because it became more economic. Most of the GTL specialized companies have succeeded as a result of their researches to overcome all the difficulties which were making this technology non-economic. As a result of this, the barrel of the GTL products becomes economically competitive to that produced from petroleum refiners.
- b-** The successes in finding and using cheap catalysts, as well as using air instead of free Oxygen as an oxidizing agent in Fischer-Tropsch synthesis process have helped in promoting this industry, and making it more economic.
- c-** The inventing and using of the Moving Slurry Phase reactor (SP) by Sasol, and the Shell Middle Distillate Synthesis (SMDS) by Shell, were turning points in the development of the GTL technology. These two technologies have practically proved their effectiveness, and all the other technologies created by other companies are in fact only developments of these two technologies.
- d-** The success which has been achieved by some companies like Alchem and Syntroleum in inventing small land and marine, fixed and mobile GTL units of low capital cost, is a great accomplishment which will have its direct impact in promoting this technology in the future. This development will enable the investment of the remote and stranded gas fields however their reserves are small. The possibility of renting such small units will also enable the countries which cannot afford the establishment of big GTL plants to invest their natural gas fields.
- e-** Despite of all the progresses which the GTL technology has achieved, it still needs more developments and improvements in order to make its products more competitive, and to occupy a confident place among the other industries.

## **2- Conclusions Concerning the Economy of the GTL Technology**

- a-** The economic studies which were disclosed in the nineties of the previous century showed that any GTL project would not be economic

if its production capacity is below 50,000 bbl/day. The continuous development of the GTL technology enable by the beginning of this century to reach a capital cost of 20,000 \$/bbl/day. This value has made the GTL plants economic even when their production capacity is much less than the above mentioned value.

- b-** The increasing of the oil prices increases also the cost of the refined barrel of petroleum products, and consequently decreases the profitability of the refining process. These increases in the oil prices discourage the investors from building more oil refineries, and this industry will get stagnated. On the other hand this matter will encourage the investors to search for cheaper sources of petroleum products. One of the available options in this direction is the GTL technology.
- c-** The promotion of the GTL technology will decrease some of the pressures on the oil demands, and thus making its prices more stable. And vice versa, the stability in the oil prices will encourage establishing more GTL factories.
- d-** There are more than 15 GTL plants under construction in the present time, and most of them are expected to start production before 2010. The total production capacities of these plants exceed 1.2 MMbbl/day. There are also plans to build more GTL factories, and the total number of these factories in 2020 is expected to reach 40 of about 3.4 MMbbl/day production capacities. The successful performance of these projects in the future will defiantly promote this industry more and more.
- e-** It was thought in the past that any increase in the natural gas prices (wellhead prices) will ascend the cost of the barrel of GTL products, and thus will make this industry less profitable. The modern calculations showed that this factor is less affective as long as the oil prices are also increasing in the same ratio.
- f-** The increasing of the natural gas prices perhaps sounds that it would be more economic to liquefy the gas and sale it as an LNG, rather than investing it by GTL industry. The building of an LNG plant is not cheaper than building a GTL plant. The best choice in such a case is to join these two technologies in a single industrial factory. This option is unique and very effective because the two industries will share the infrastructure which they both need. Secondly, it would be possible to maneuver on the kinds of products according to the needs of the markets.

- g-** According to the recent calculations, it is found that within the existing oil prices (which are around 60 \$/bbl), the wellhead prices of the natural gas that can keep the GTL technology economic and profitable are around 5-6 \$/MMBtu.
- h-** The new GTL technologies work hard to benefit from the energy produced from the Fischer-Tropsch synthesis reaction, and to use it in the other facilities of the GTL factory. Any success with regard to this point will increase the profitability of the GTL plants. If this aim gets enough concern and development, the GTL factories could turn in the future to energy exporter plants, or at least will be energy self-sufficient.
- i-** In the nineties of the previous century, the economic studies showed that any increasing in the production capacity of the GTL factories will decrease their capital costs. As a result of this, the price of the barrel of GTL products will diminish, and the industry will become more economic. Although this fact is correct and must be considered whenever a GTL project is planned, the modern developments have broken out this hypothesis, and the new GTL plants become economic and profitable even when they are very small.

### **3- Conclusions Concerning the Effects of the GTL Technology on Oil Refining Industry**

- a-** Presently, the oil refining industry is the main source of the petroleum products which the whole wide world needs most. Therefore, the promotion of the GTL industry will not threaten in any way the oil refining industry, because the later is so important it can never be dispensed. On contrary to this, the establishment of a GTL industry will help in resolving some of the problems which the refineries suffer from, like the shortages in supplying the petroleum products.
- b-** It is clear that the ascending in the demands for the light and middle petroleum products, like the gasoline and diesel, is due to the extreme increasing in the number of the road vehicles. This ascending will reach one day a level that the oil refiners could never supply, because it exceeds their production capacities. This situation has encouraged the investors to find other sources of petroleum products rather than sticking to the oil sources, because the oil prices are increasing continuously. Obviously, natural gas can be one of the cheaper sources of petroleum products if invested by the GTL technology.

- c-** The oil refiners can buy the high quality GTL products to blend it with its products to improve their specifications. For instance, the GTL diesel has very good specifications compared with the petroleum diesel. Therefore, the mixing of the GTL diesel with the petroleum diesel can be a cheap and easy way to improve its specifications, instead of spending a big deal of money to improve it by the upgrading units.
- d-** The joining of the oil refining industry and the GTL industry in a single factory could benefit both industries. For example, synthesis gas can be produced, if a synthesis unit is installed within the refinery. This unit can be feedstocked by gasifying the unwanted heavy products of the refinery like the fuel oil. On the other hand, the two industries could share the infrastructure which both need, as well as using the extra power produced from the GTL industry by the refining industry.
- e-** The ratio of producing diesel by the GTL industry is about 70%, while its production by the oil refining is not more than 40%. This means that the promotion of the GTL factories will greatly help to cover most of the increasing demands for diesel in the future.

#### **4- Conclusions concerning the utilization of the GTL Technology in Iraq**

- a-** The flared associated natural gas can be industrialized by the GTL technology and changed into valuable light and middle petroleum products which Iraq needs most. This action will provide the country with extra incomes instead of wasting this fortune, as well as polluting the environment. The investing of this gas by this way has become easy after the invention of the small mobile GTL plants which can even be hired if necessary.
- b-** It is not profitable to use the GTL technology with the north or south free natural Gas fields in Iraq, because these fields can be invested by the conventional ways.
- c-** The GTL technology can be used successfully with Saladin gas field because most of the necessary conditions and requirements to build a GTL project are available and applicable with this field.
- d-** An Industrial complex can be built in (T1) site consisting of a gas treatment plant, as well as a 35,000 bbl/day GTL project. The

capacities of these two plants can be extended in the future depending on the amounts of the natural gas which will reach the site.

- e- The created industrial complex can be used to treat and industrialize the natural gas of other fields which are expected to be discovered in the west region of Iraq.

## **5- General Conclusions**

- a- The specifications of the GTL products comply with the present and future tight standards which are legalized by most of the governments to protect the environment, and the public health.
- b- The declining in the emissions of the pollutants from the GTL products ranges between 10 – 50% less than those of the conventional petroleum products.
- c- The emission of the CO<sub>2</sub> gas from the GTL fuels is not less than that from the normal fuels, but anyway this should not be regarded as a serious problem when using these kind of fuels, because this emission is not very much higher than the emission from the conventional fuels. On the other hand, the CO<sub>2</sub> gas is not considered as one of the dangerous air pollutants.
- d- The GTL industry does not affect the LNG industry, because the GTL products are of many kinds, easier to handle or to export, and finally more widely used.
- e- The specifications of the GTL products and the clean fuels are very similar, especially with the regard to the emissions of the harm pollutants. Therefore these two kinds of fuels can help in covering some of the world demands for road fuels.
- f- The promotion of the GTL products, especially the light and middle distillates will not have any impact on the production and using of the clean fuels, specifically those derived from the natural gas (except the LPG). This is due to the differences between the two kinds of fuels.
- g- The joining of the GTL industry with any other industry, Like the LNG industry and the clean fuels production industries will create some kind of integration among them. Moreover, this joining will create also a maneuver in their product marketing.

## **5- Recommendations**

- a-** It is very important to pay more attention to the Gas to Liquids (GTL) technology especially by the natural gas producing countries, because this industry can provide additional incomes to these countries, as well as creating more job opportunities.
- b-** It is also important to encourage establishing joint factories between the GTL industry and other kinds of industries. For instance, when plans are put to establish a new petroleum refinery, it is useful to plan also to install a gasifying plant among its units. This plant will help to get rid of the unwanted heavy products by gasifying them and turn them into valuable light products.
- c-** The countries which suffer from big environmental problems must pay special attention for environmental pollution protection. These countries must concentrate on using the GTL products, because these products are clean and less pollutant than the normal fuels.
- d-** Since the consumption of the normal petroleum products is very harmful to the environment and the public health, the blending of these products with the clean GTL products must be encouraged, especially, in the countries with large number of road vehicles. This will improve the quality and specifications of the normal products.
- e-** The researches conducted to develop the GTL technology must continue and funding these researches by the governments or by the specialized companies must also go on.
- f-** At least a single GTL pilot plant must be installed in each gas producing country. Such a plant can be used to conduct researches to develop this industry, and to train the employees in this technology. When this plant succeeds, it can easily be turned into a large GTL plant.
- g-** Continual GTL training programmes and courses for engineers and technicians must be performed, specifically in the gas producing countries. High education opportunities in this field must also be made available to the specialists in these countries.
- h-** The GTL industry is expected to occupy a considerable place among the petroleum industries during the coming 50 years. Therefore this technology must be educated in the universities and the technical institutes.



- i-** Some of the Arab countries have large reserves of natural gas, as well as other fortunes like oil and minerals. These wealthy countries can be leaders in constructing GTL plants, as Qatar did, and provide the world with considerable quantities of clean harmless fuels. With regard to this point, establishing a large joint Arab GTL company may be useful in developing this technology, and constructing GTL projects in or outside the Arab world.
- j-** The Arab petroleum and gas producing countries must pay more attention to the environment pollution issues. As the European Union governments did, these countries must legalize strong Acts, and issue tight lists of petroleum product specifications, in order to protect the environment and the public health.
- k-** Creating an Arab specialized environmental board is highly recommended. This board can help in protecting the environment in the Arab countries by promoting the production and using the clean fuels, of which the GTL products is among them.

## References

- (1) The Role of GTL in Meeting Future Product Demand – Prepared for Petrotech 2006 Bahrain/by H.G. Nebeker, Jr. Purvin & Certz, Inc.
- (2) Oil & Gas Journal, January 1, 2005.
- (3) <http://www.gassolutions.conoco.com/tech/why.asp>
- (4) Study yields generic, coastal-based GTL plant, from OIL & Gas Journal / March 12, 2001.
- (5) Oil & Gas Journal, July 31, 2000.
- (6) Refining Clean Fuels for the Future/ Phillipe Courty & Jean-Francois Gruson. Institute Francais Du Petrole, France.
- (7) Gas to Liquids (Fischer Tropsch Diesel) Supply and Economics. By Roger Davies, Shell Gas and Power. Alternative Diesel Fuels Symposium. August 19-20, 2003.
- (8) Oil & Gas Journal – 13 December, 1999.
- (9) <http://www.ub.rug.nl/eldoc/dis/science/g.p.van.der.lean/c1.pdf>
- (10) Chemical Process Industries by R. Norris Shreve
- (11) [http://www.nfcruc.uci.edu/Energy\\_Tutorial/](http://www.nfcruc.uci.edu/Energy_Tutorial/)
- (12) Oil & Gas Journal, Vol. 102, No. 47 (December 20, 2004).
- (13) J. Chem. Inf. Comput. Sci. 2000, 40, 833-838.
- (14) Thermo chemical conversion – technologies for solid fuels by Dr. Dmitry Korobov and Prof. Dr. brend Meyer / TU Bergakademie Freiberg – Moscow, 2004.
- (15) <http://www.gasification.org/story/>
- (16) Synthesis Gas Processes for Synfuels Production /Christopher Higman presented at EUROGAS '90 Trondheim, June 1990
- (17) Chemical and process technology encyclopedia/ by Douglas M. Considine.
- (18) <http://www.hugman.de/gasification/eurogas.pdf>
- (19) <http://www.ntel.doe.gov/>
- (20) Chemical Conversion of Natural Gas to Gasoline and Diesel Fuels / Directorate of Studies & Planning & Follow-up/Iraqi Ministry of Oil
- (21) Development in Natural Gas Conversion to Transport Fuel – a Review / by P. Leprince – C. Raimbault / Institute Francais Du Petrole.
- (22) Synthetic Fuels / International Student Edition – copyright 1982 by McGraw-Hill, Inc., 2<sup>nd</sup> printing 1985.
- (23) Fischer-Tropsch Synthesis, the Caer Prospective by Burt Davis, Caer. From Energia, Vol 8, No 3, 1997.
- (24) <http://www.worldenergy.org/wec-gis/publications-1999>
- (25) Jager, B., "Sasol's Advanced Fischer-Tropsch Processes", AIChE Spring Meeting, 9 - 13 March 1997, Houston, Texas.

- (26) Couvaras, G., "Sasol's Slurry Phase Distillate Process and Future Applications", Monetizing Stranded Gas Reserves Conference, Houston, December 1997.
- (27) Fischer-Tropsch Reactors, Ben Jager, Sasol Process Development Twente (SPDT), University of Twente: Chemical Technology.
- (28) Development Progress for GTL Fuels, Speciality Products. By Paul Schubert, Carles Bayens, & Larry Weick/Syntroleum Corp., Tulsa. From Oil & Gas Journal - March 12, 2001.
- (29) IvanhoeEnergy- GTL Seminar / Baghdad, March, 2004.
- (30) Shell Gas & Power / Gas Seminar – Baghdad April 2002.
- (31) Oil & Gas Journal – March 14, 2005.
- (32) The Performance of (SMDS) Diesel Fuel Manufactured by Shell's GTL Technology/By Richard H. Clark–Shell Global Solutions (US).
- (33) Gas to Liquids – Global Prospects / Pat Davies, Executive Director, Sasol Limited, from the website:  
[http://www.sasol.com/sasol\\_internet/downloads/DeutscheBankSep03\\_1064304691262.pdf](http://www.sasol.com/sasol_internet/downloads/DeutscheBankSep03_1064304691262.pdf)
- (34) <http://www.tg.tudelft.nl/>
- (35) <http://www.chemlink.com.au/cv.htm>
- (36) Development of Fischer Tropsch Reactors By B.Jager – Sasol Technology Netherlands BV
- (37) New Developments in Gas to Liquids Technology / Presented by Ronald M. Smith Senior Consultant Process Economics Program SRI Consulting Menlo Park, California CERI 2004 Petrochemical Conference Delta Lodge at Kananaskis, Alberta, Canada.
- (38) Gas-to-Liquids: A New Source of High-Quality Clean Fuels. Roger Davies, Shell Gas and Power.
- (39) A Growing Focus on Unconventional Oil. A major oil company's view of prospects and potential. Andrew Slaughter Shell –Global Business Environment. EIA Midterm Energy Outlook and Modeling Conference April 12<sup>th</sup> 2005.
- (40) <http://www.wetfeet.com/research/companies.asp>
- (41) <http://www.exxon.mobil.com/>
- (42) Fischer-Tropsch conversion of gas to liquid, by Davis, B.H., Appl. Catal A. 1997, 155, N4-N7.
- (43) Next Generation of Base Oils from GTL Processes - Outlook for The East of Suez Lubricants and Baseoils Conference / April 6 - 7, 2005 Dubai, UAE
- (44) Syngas Refiner, Vol. 1, No. 1, January 2005.
- (45) <http://www.syntroleum.com/process-schematic.asp>
- (46) <http://pubs.acs.org/cen/coverstory/8129/final/#top>
- (47) <http://syntroleum.com/>

- (48) Syntroleum GTL Barge, from the website:  
<http://www.syntroleum.com/gtlbarge>
- (49) Company Profile from the website: <http://www.chevron.com/>
- (50) Chevron Press Release from the website: <http://www.chevron.com/>
- (51) <http://www.rentechinc.com/home.htm>
- (52) Company History, from the website: <http://www.conocophilips.com/>
- (53) [http://www.gassolutions.com/tech/conoco\\_process.asp](http://www.gassolutions.com/tech/conoco_process.asp)
- (54) [http://www.qatarembassy.net/major\\_projects](http://www.qatarembassy.net/major_projects).
- (55) <http://www.ivanhoe-energy.com/s/home.asp>
- (56) Ivanhoe Energy forms gas-to-liquids Company to facilitate Japanese Participation, from the website: <http://studio.financialcontent.com/>
- (57) <http://www.alchemltd.com/>
- (58) The Qatar Shell Gas to Liquids Project. Niels Fabricius, Technical Director, Qatar-Shell GTL Project. Shell Gas & Power. Finance and Investment in Qatar Conference London, March 2004
- (59) Offshore Gas to Liquids, Dr. OlaOlsvik Chief Researcher, Oil and Gas Refining, Statoil R&T Offshore Gas Solutions, OG21 & Demo2000 Seminar, Oslo, Norway, February 17-18, 2005.
- (60) Gas-T0-Liquids and Hydrogen Production Applicable To Offshore Environments Presented by: Arthur M. Hartstein, Ph.D. Office of Fossil Energy, U.S. Department of Energy, Presented to: U.S. Department of the Interior, Minerals Management Service "Futuristic Energy Production Schemes in the OCS" May 21-22, 2002.
- (61) Design and engineering of a GTL plant, from HYDROCARBON ASIA, MAY/JUNE 2003 from the website:  
<http://www.hcasia.safan.com>
- (62) "2001 world LNG/GTL review," Zeus Development Corp., 2001.
- (63) Meeting the Gas Supply Challenge of the Next 20 Years Non-Traditional Gas Sources, Prepared for National Renewable Energy Laboratory, by American Gas Foundation Thomas J. Woods Ziff Energy Group Houston, Texas Paul Wilkinson Christopher McGill American Gas Association August 2002
- (64) <http://www.naturalgas.org/overviw/background.asp>
- (65) Conoc\_Houston\_GPA/ January 9, 2002.
- (66) Asian Development Outlook 2005 Update - The Challenge of Higher Oil Prices.
- (67) <http://www.wtrg.com/energyeconomics.html>
- (68) <http://www.eia.doe.gov/>
- (69) Research on Marketability of GTL (Liquid Fuel from Natural Gas) Yoshiki Ogawa-Chief Economist, Kazuhisa Hasenaka-Senior Economist, Yasunari Kawasaki-Staff Economist, Oil Industry Group, General Research Department.

- (70) Oil and Gas Technology- by Wisam Al-Shalchi, & Abdul Satar Shakir – Baghdad 1992.
- (71) GTL Fuel quality comparison from the website:  
[http://www.sasolchevron.com/GTL\\_fuel\\_comparision.htm](http://www.sasolchevron.com/GTL_fuel_comparision.htm)
- (72) GTL Fuel performance and emissions from the website:  
[http://www.sasolchevron.com/fuel\\_performance.htm](http://www.sasolchevron.com/fuel_performance.htm)
- (73) The Future of Alternative Fuels for Transport Well to Wheel Performance and Economics- by Andre Douaud / the Seventh Arab Energy Conference – Cairo 11-14 May 2002.
- (74) Potential Impact of GTL on Refiners/ TECHNIP ITALY.
- (75) GTL A Paradigm Shift for the Oil Industry. From Oil & Gas Journal, December 13, 1999.
- (76) The Impact of Gas-to-Liquids on Refinery Strategies for Clean Fuels by Simon C. Clarke, Graham Phillips / Foster Wheeler Energy Limited.
- (77) Energies, No. 44, p. 25, TotalFinaElf, Spring 2001.
- (78) How operators will bring 'worthless' gas to market from the website:  
<http://www.worldoil.com/>
- (79) Beale, Jeff, "In depth," at: [www.onlinemariner.com](http://www.onlinemariner.com), September 28, 2001.
- (80) Alexander's Gas & Oil - volume 6, issue #17/ 11-09-2001
- (81) <http://www.greencarcongress.com/2005/10/>
- (82) The Role of GTL in Meeting Future Product Demand – By H.G. Nebeker, Jr. Purvin & Gertz, Inc.
- (83) Frequently Asked Questions, from the website:  
<http://www.conocophilips.com/index.asp>
- (84) An Overview of Sasol's Gas to Liquids Technology, by Cavan Hill, Business Developments Manager, Sasol Synfuels International. December 1999.
- (85) Iran GTL project very much on track, Sasol tells OGME, ITP Business, July 28, 2005.
- (86) Seventh Arab Energy Conference / Paper of state of Qatar – 2004.
- (87) <http://www.oilegypt.com/>
- (88) Sasol Examining Coal- and Gas-to-Liquids Projects in Algeria and US, from the website:  
[http://www.greencarcongress.com/2005/10/sasol\\_examining.html](http://www.greencarcongress.com/2005/10/sasol_examining.html)
- (89) Alexander's Gas & Oil - volume 3, issue #28 / 24-12-1998.
- (90) <http://www.oxfordbusinessgroup.com/>
- (91) Alexander's Gas & Oil - volume 9, issue #6 / Thursday, March 25, 2004.
- (92) Prospectus Stranded Gas Utilization: Steps to Commercialization December 2003 – Nexant.
- (93) Dry, M. E. Practical and theoretical aspects of the catalytic

- Fischer-Tropsch process. Appl. Catal. A 1996, 138, 319.
- (94) 3<sup>rd</sup> Annual World GTL Summit – Executive Briefing / May 20, 2003 – London / Rachid Qukaci.
- (95) Van der Laan G P, Beenackers A A C M. Catal. Rev.-Sci. Eng., 1999, 41 (3-4): 255 and the literature herein.
- (96) The comprehensive development of Saladin gas field/ directorate of fields and reservoirs development/ Iraqi Ministry of Oil - 2003/ By Ban Jaafar, Hamid Habib, Yasmin Abdul Aziz, Insaf Faydhi.

## General Reference

- (1) Seventh Arab Energy Conference / Paper of state of Qatar – 2004.
- (2) [http://www.sasolchevron.com/physical\\_chemical\\_properties.htm](http://www.sasolchevron.com/physical_chemical_properties.htm)
- (3) <http://www.greencarcongress.com/>
- (4) Fuel Tax Inquiry - Industry Submissions - 29 September, 2001.  
From <http://fueltaxinquiry.treasury.gov.au/>
- (5) Alexander's Gas & Oil - volume 3, issue #28 / 24-12-1998
- (6) <http://www.oxfordbusinessgroup.com/>
- (7) Alexander's Gas & Oil - volume 9, issue #6 / Thursday, March 25, 2004.
- (8) The Institute of Energy Economics, Japan.
- (9) Frequently Asked Questions from:  
<http://www.conocophilips.com/index.asp>
- (10) GTL Progress and Prospects: Financial Commitments Brighten,  
From Oil & Gas Journal – March 12, 2001.
- (11) New JV markets one-stop GTL package. From Oil & Gas Journal  
December 18, 2000.
- (12) Shell to take GTL to the next commercial level. Petroleum  
Intelligence Weekly, October 16, 2000.
- (13) Positive Signs for GTL. ECN-Process Technology, July 2000.
- (14) Conoco Says Economies of Scales Key. From Oil & Gas Journal  
July 31, 2000.
- (15) International Firms Eyeing East for Major GTL Projects as  
Technology comes of age. Middle East Economic Survey,  
July 24, 2000.
- (16) GTL-An Expanding Market. European Chemical News,  
April 17-23, 2000.
- (17) European Commission, directive proposal to promote biofuels for  
Transport / November 7, 2001.
- (18) Hydrocarbon Processing/ November 2002.
- (19) Overview of the Oil Downstream Industry in Iraq / Nabil N.  
Lammoza / Ministry of Oil - Iraq

- (20) The Real Image of the Gas Industry in Iraq/Ministry of Oil - Iraq
- (21) The Economic Prospects of Using the Natural Gas in the Arab Countries/ Thamer Abas Ghdhban, Ghazi Mahdi Hayder, Sabah Hadi Al- Jawhar.

## **The Author**

**Name:** Wisam Al-Shalchi

**Date and Place of Birth:** Baghdad / Iraq - 1956

**Nationality:** Iraqi

**Place of Residence:** Amman – Jordan

**Telephone No.:** 00962-6-5621049,

**Mobile:** 00962-785200764

**E-mail:** [wisamalshalchi@yahoo.com](mailto:wisamalshalchi@yahoo.com)

**Level of Education:**

- 1) M.Sc. in Petroleum Chemistry - University of Essex / UK
- 2) B.Sc. in Chemistry- University of Baghdad



**Experience:**

- 1) Working as Process Engineer at Shwaikhat Oil Refinery which belongs to OMV Petroleum Company/ Vienna – Austria.
- 2) Working as Process Engineer at Dora Oil Refinery/ Baghdad – Iraq
- 3) Working as Technical Lecturer in the Iraqi Oil Institute.
- 4) Working as Head of Oil & Gas Technologies in the Iraqi Oil Institute.
- 5) Working as Senior Technical Observer in the United Nations Development Programme (UNDP).
- 6) Working as Petroleum Expert in the Directorate of Studies & Planning & Follow-up – Ministry of Oil / Iraq.

**Publications:**

- 1) Petroleum Environment Directory – Iraq, 2007
- 2) Industrial Safety – Iraq, 2007
- 3) Environment Protection – Iraq, 2006.
- 4) Instrumental Chemical Analysis – Iraq, 1994.
- 5) Oil and Gas Technology – Iraq, 1992

**Published Researches and Studies:**

- 1) Carbon Capture & Storage - 2008
- 2) Gas To Liquids Technology (GTL) – 2006 / Won the international annual prize of the Oapec Organization for the year 2006.
- 3) Traces analysis in Natural Gas. – 2005
- 4) Using Natural Gas Derivatives as Fuels for Vehicles – 2005 / Won appreciation prize from UNEP.
- 5) Compressed Natural Gas (CNG). – 2004
- 6) Comprehensive Petroleum Education and Training in Iraq - 1996
- 7) Development of the Phenolic Plastics prepared in acidic medium. – 1990
- 8) Mechanism of the acid catalysed hydrolysis of esters. - 1988