

# **An Introduction to Biomass Thermochemical Conversion**

**Richard L. Bain**  
**Group Manager, Thermochemical Conversion**  
**National Bioenergy Center**

**DOE/NASLUGC Biomass and Solar Energy Workshops**  
**August 3-4, 2004**

# Presentation Outline

- **Objective & Definitions**
- **Biomass Properties**
- **Combustion**
- **Gasification**
- **Pyrolysis**
- **Other**
- **Research Areas**

# Fuels, Chemicals, Materials, Heat and Power from Biomass



## Biomass Feedstock

- Trees
- Forest Residues
- Grasses
- Agricultural Crops
- Agricultural Residues
- Animal Wastes
- Municipal Solid Waste

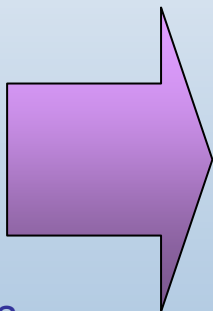

## Conversion Processes

- Gasification
- Combustion and Cofiring
- Pyrolysis
- Enzymatic Fermentation
- Gas/liquid Fermentation
- Acid Hydrolysis/Fermentation
- Other

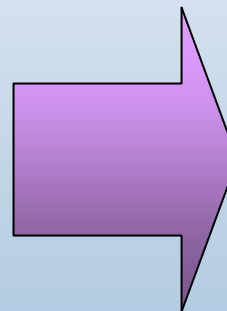

## USES

### Fuels:

- Ethanol
- Renewable Diesel

### Electricity

### Heat

### Chemicals

- Plastics
- Solvents
- Pharmaceuticals
- Chemical Intermediates
- Phenolics
- Adhesives
- Furfural
- Fatty acids
- Acetic Acid
- Carbon black
- Paints
- Dyes, Pigments, and Ink
- Detergents
- Etc.

### Food and Feed

# Basic Definitions

**Biomass** is plant matter such as trees, grasses, agricultural crops or other biological material. It can be used as a solid fuel, or converted into liquid or gaseous forms for the production of electric power, heat, chemicals, or fuels.

**Black Liquor** is the lignin-rich by-product of fiber extraction from wood in Kraft (or sulfite) pulping. The industry burns black liquor in Tomlinson boilers that 1) feed back-pressure steam turbines supplying process steam and electricity to mills, 2) recover pulping chemicals (sodium and sulfur compounds) for reuse.

# Basic Definitions

## Combustion

- Thermal conversion of organic matter with an oxidant (normally oxygen) to produce primarily carbon dioxide and water
- The oxidant is in stoichiometric excess, i.e., complete oxidation

## Pyrolysis

- Thermal conversion (destruction) of organics in the absence of oxygen
- In the biomass community, this commonly refers to lower temperature thermal processes producing liquids as the primary product
- Possibility of chemical and food byproducts

## Gasification

- Thermal conversion of organic materials at elevated temperature and reducing conditions to produce primarily permanent gases, with char, water, and condensibles as minor products
- Primary categories are partial oxidation and indirect heating

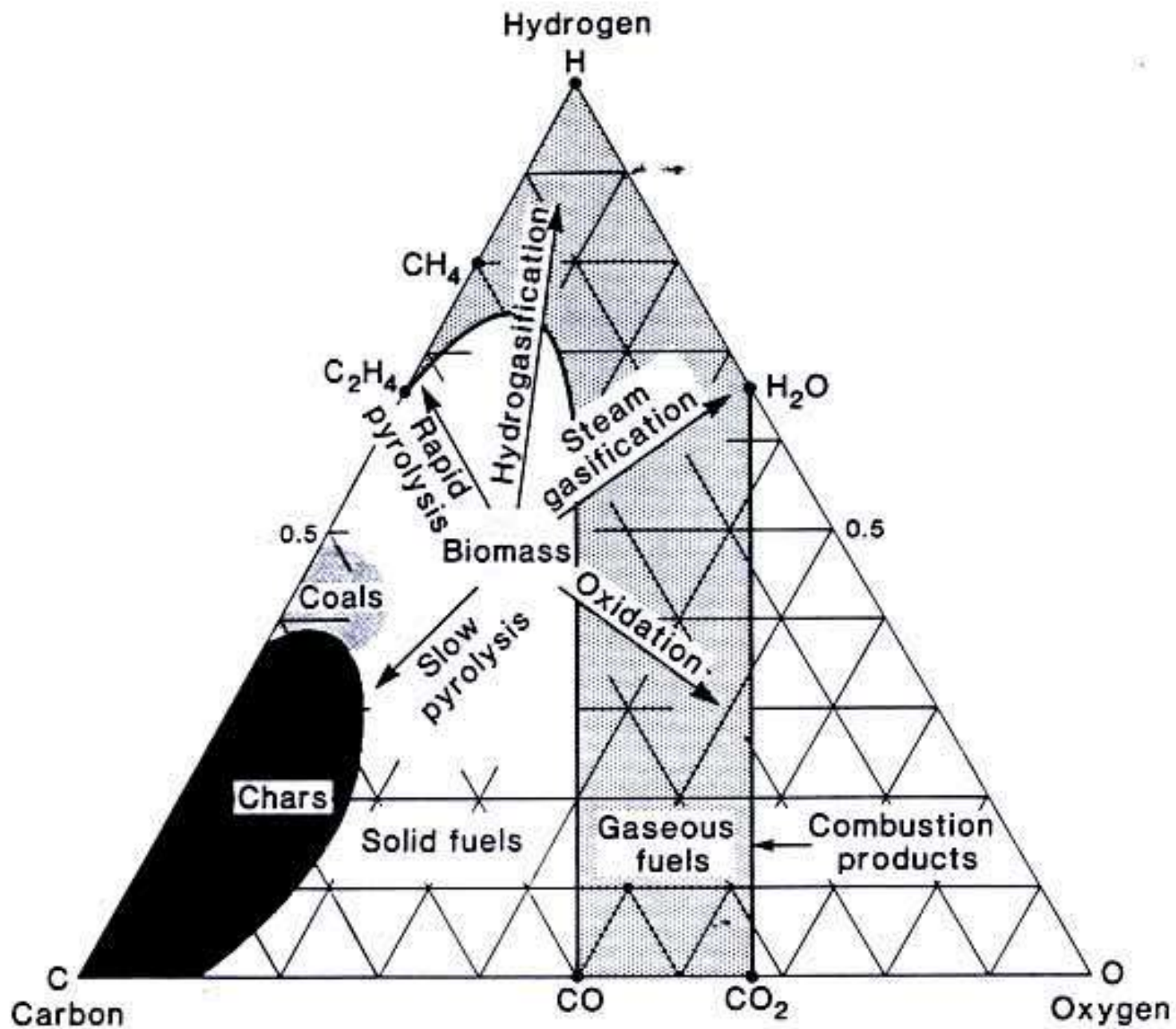

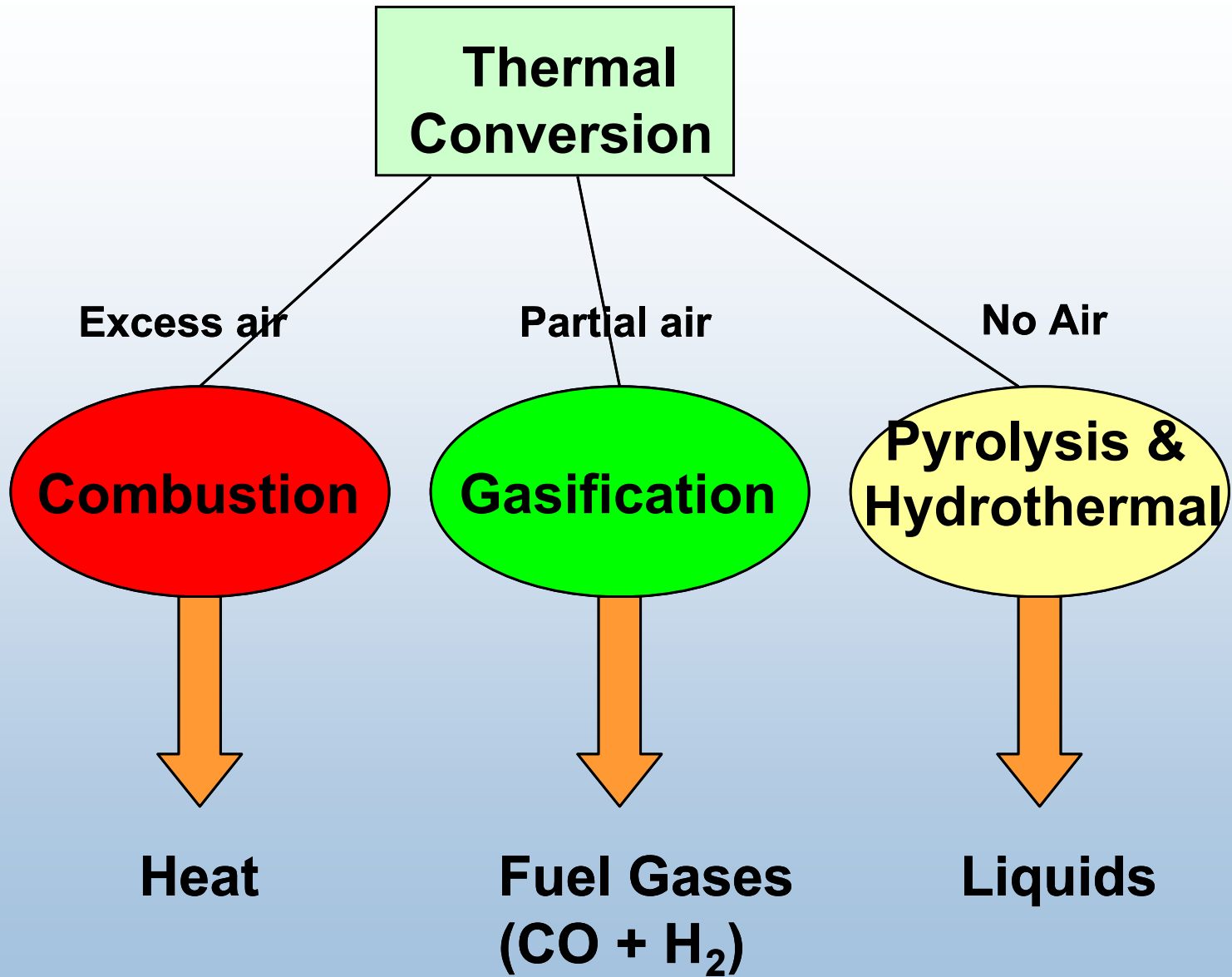

# POTENTIAL BIOMASS PRODUCTS

- Potential Biomass Products
  - Biomass
  - Syngas
  - Hydrogen
  - Pyrolysis Oil – Whole or Fractionated
  - Hydrothermal Treatment Oils
- Biomass
  - Solid
  - $\text{CH}_{1.4}\text{O}_{0.6}$
  - HHV = 16 – 17 MBTU/ton (MAF)
- Syngas
  - Major components –  $\text{CO}$ ,  $\text{H}_2$ ,  $\text{CO}_2$
  - $\text{CO}/\text{H}_2$  ratio set by steam rate in conditioning step, typical range 0.5 – 2
  - HHV: 450-500 BTU/scf
- Pyrolysis Oil
  - $\text{CH}_{1.4}\text{O}_{0.5}$
  - Chemical composition: water (20-30%), lignin fragments (15-30%), aldehydes (10-20%), carboxylic acids (10-15%), carbohydrates (5-10%), phenols (2-5%), furfurals (2-5%), ketones (1-5%)
  - Other (ca.): pH - 2.5, sp.g. - 1.20, viscosity (40°C, 25% water) – 40 to 100 cp, vacuum distillation residue – up to 50%
- Hydrothermal Treatment Oils
  - Water plus alkali at  $T = 300\text{-}350^\circ\text{C}$ ,  $P$  high enough to keep water liquid. Use of  $\text{CO}$  is option
  - Yield > 95%
  - Distillate (-500°C): 40 – 50%
  - Distillate Composition: Hardwood (300°C) –  $\text{CH}_{1.2}\text{O}_{0.2}$ , Manure (350°C) –  $\text{CH}_{1.4}\text{O}_{0.1}$
  - Qualitative: long aliphatic chains, some cyclic compounds containing carbonyl groups, and a few hydroxy groups, ether linkages, and carboxylic acid groups
  - HHV = 28 – 34 MBTU/ton



# Biomass Properties Relevant to Thermal Conversion

## Representative Biomass & Black Liquor Compositions

	Poplar	Corn Stover	Chicken Litter	Black Liquor
<b>Proximate (wt% as received)</b>				
<b>Ash</b>	<b>1.16</b>	<b>4.75</b>	<b>18.65</b>	<b>52.01</b>
Volatile Matter	81.99	75.96	58.21	35.26
Fixed Carbon	13.05	13.23	11.53	6.11
Moisture	4.80	6.06	11.61	9.61
<b>HHV, Dry (Btu/lb)</b>	<b>8382</b>	<b>7782</b>	<b>6310</b>	<b>4971</b>
<b>Ultimate, wt% as received</b>				
Carbon	47.05	43.98	32.00	32.12
Hydrogen	5.71	5.39	5.48	2.85
Nitrogen	0.22	0.62	<b>6.64</b>	0.24
<b>Sulfur</b>	<b>0.05</b>	<b>0.10</b>	<b>0.96</b>	<b>4.79</b>
Oxygen (by diff)	41.01	39.10	34.45	0.71
Chlorine	<0.01	0.25	1.14	0.07
Ash	1.16	4.75	19.33	51.91
<b>Elemental Ash Analysis, wt% of fuel as received</b>				
Si	0.05	1.20	0.82	<0.01
Fe	---	---	0.25	0.05
Al	0.02	0.05	0.14	<0.01
<b>Na</b>	<b>0.02</b>	<b>0.01</b>	<b>0.77</b>	<b>8.65</b>
K	0.04	1.08	2.72	0.82
Ca	0.39	0.29	2.79	0.05
Mg	0.08	0.18	0.87	<0.01
P	0.08	0.18	1.59	<0.01
As (ppm)			14	

# Representative Biomass and Coal Properties

	<b>Biomass 1</b>	<b>Biomass 2</b>	<b>Coal 1</b>	<b>Coal 2</b>	<b>Tar Sands</b>
<b>Name</b>	<b>Wood</b>	<b>Red Corn Cob</b>	<b>Grundy, IL. No 4</b>	<b>Rosebud, MT</b>	<b>Athabasca</b>
<b>Classification</b>			<b>HvBb</b>	<b>sub B</b>	<b>Bitumen</b>
<b>Proximate Analysis, wt% Dry</b>					
Moisture	25-60	16	8.16	19.84	
Volatile Matter	77-87	ca. 80	40.6	39.02	
Fixed Carbon	13-21	--	45.47	49.08	
Ash	0.1-2	4	13.93	9.16	
<b>Ultimate Analysis, wt % Dry</b>					
C	50-53	45	68.58	68.39	83.6
H	5.8-7.0	5.8	4.61	4.64	10.3
N	0-0.3	2.4	1.18	0.99	0.4
Cl	.001-0.1	--	0.12	0.02	--
O	38-44	42.5	6.79	16.01	0.2
S	0-0.1	0	4.76	0.79	5.5
Ash	0.1-2	4	13.93	9.16	
<b>H/C Atomic Ratio</b>	<b>1.4-1.6</b>	<b>1.5</b>	<b>0.8</b>	<b>0.81</b>	<b>1.47</b>
<b>HHV, Dry, Btu/lb</b>	<b>8,530- 9,050</b>	<b>7,340</b>	<b>12,400</b>	<b>11,684</b>	<b>17,900</b>

# Biomass Higher Heating Value

(with 95% confidence interval)

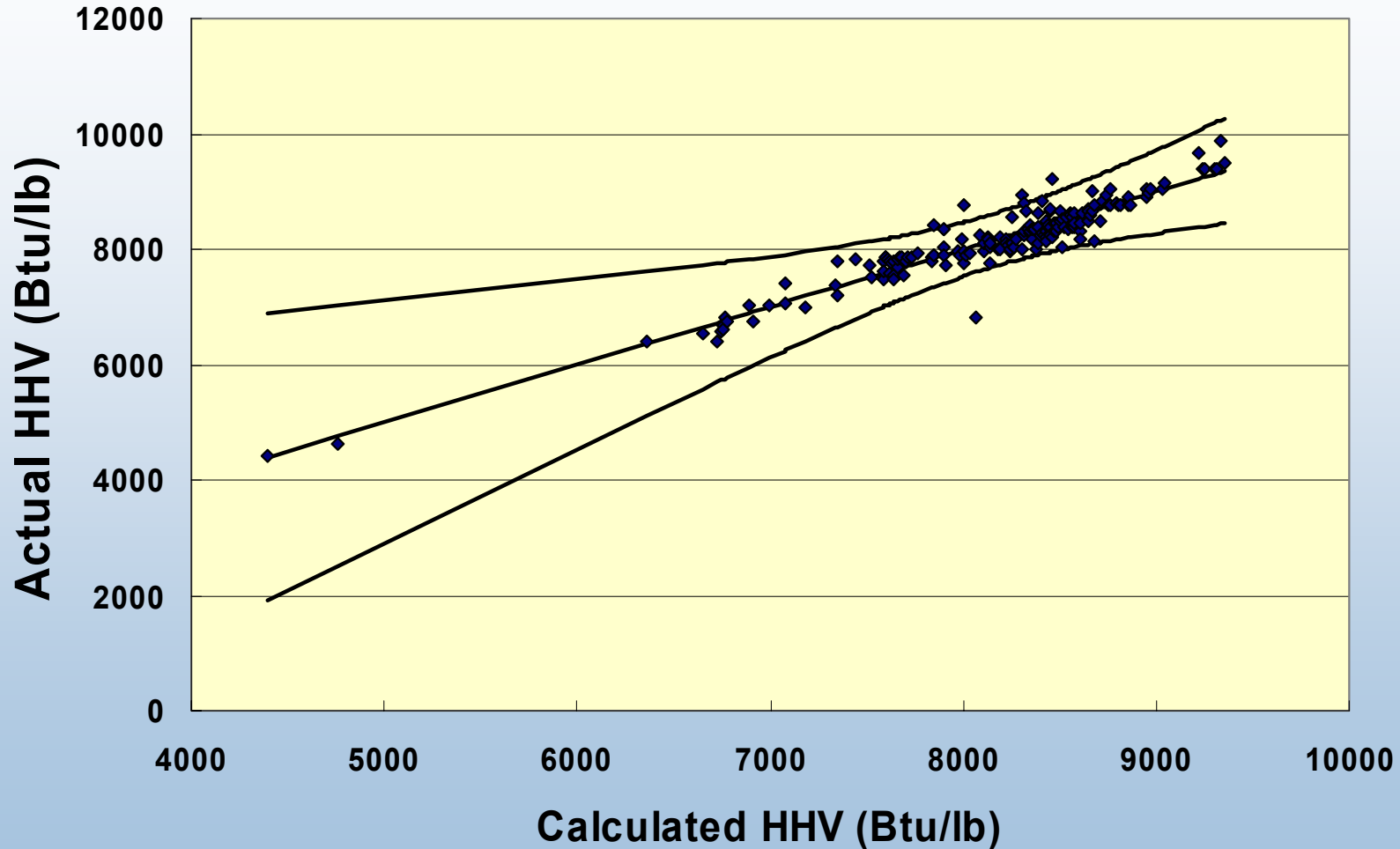

$$\text{HHV (Btu/lb)} = 85.65 + 137.04 \text{ C} + 217.55 \text{ H} + 62.56 \text{ N} + 107.73 \text{ S} + 8.04 \text{ O} - 12.94 \text{ A} \quad (\text{Eq 3-15}) \quad \text{N} = 175$$

## Potassium Content of Biomass

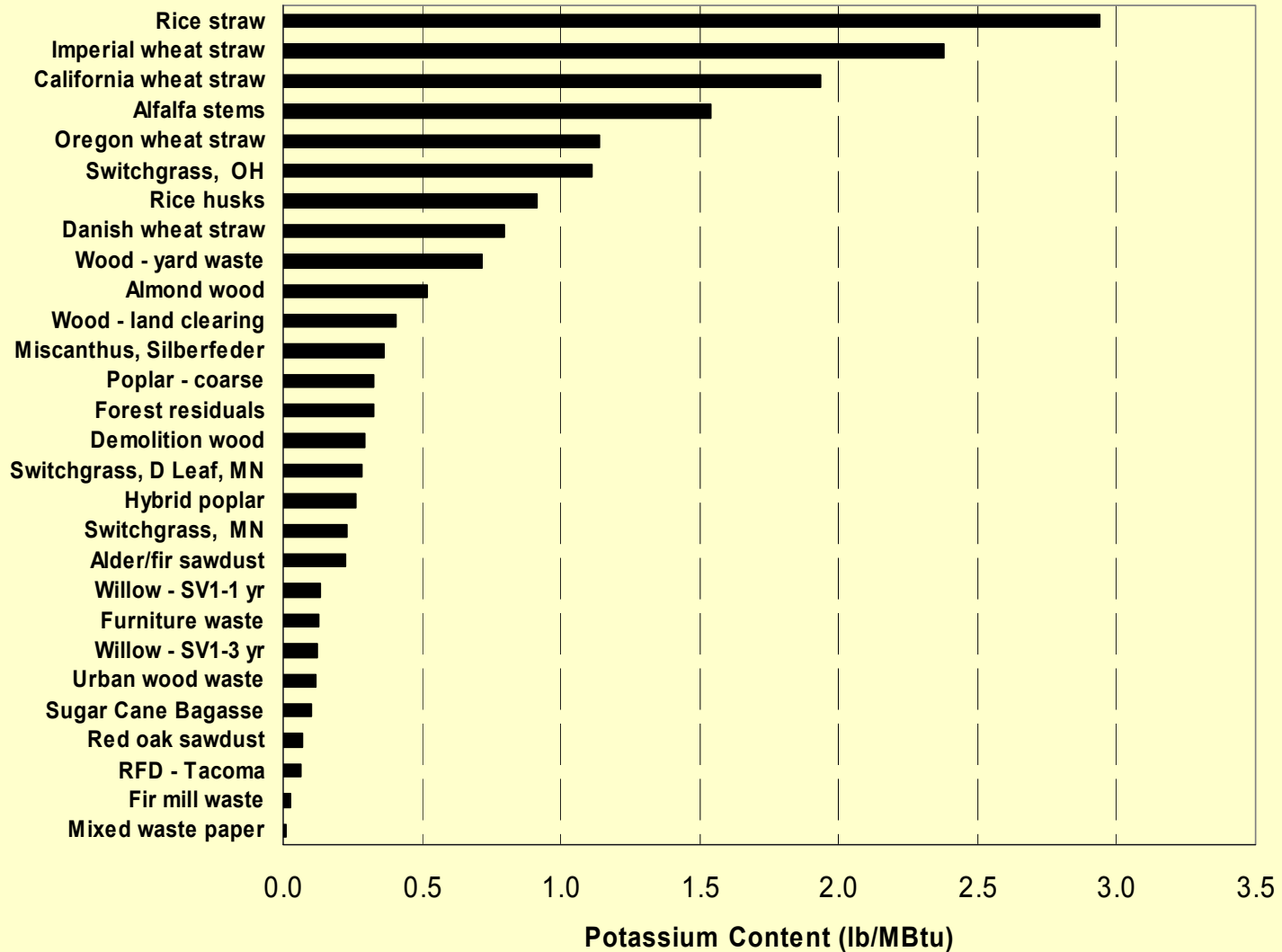

# Nitrogen Content of Biomass

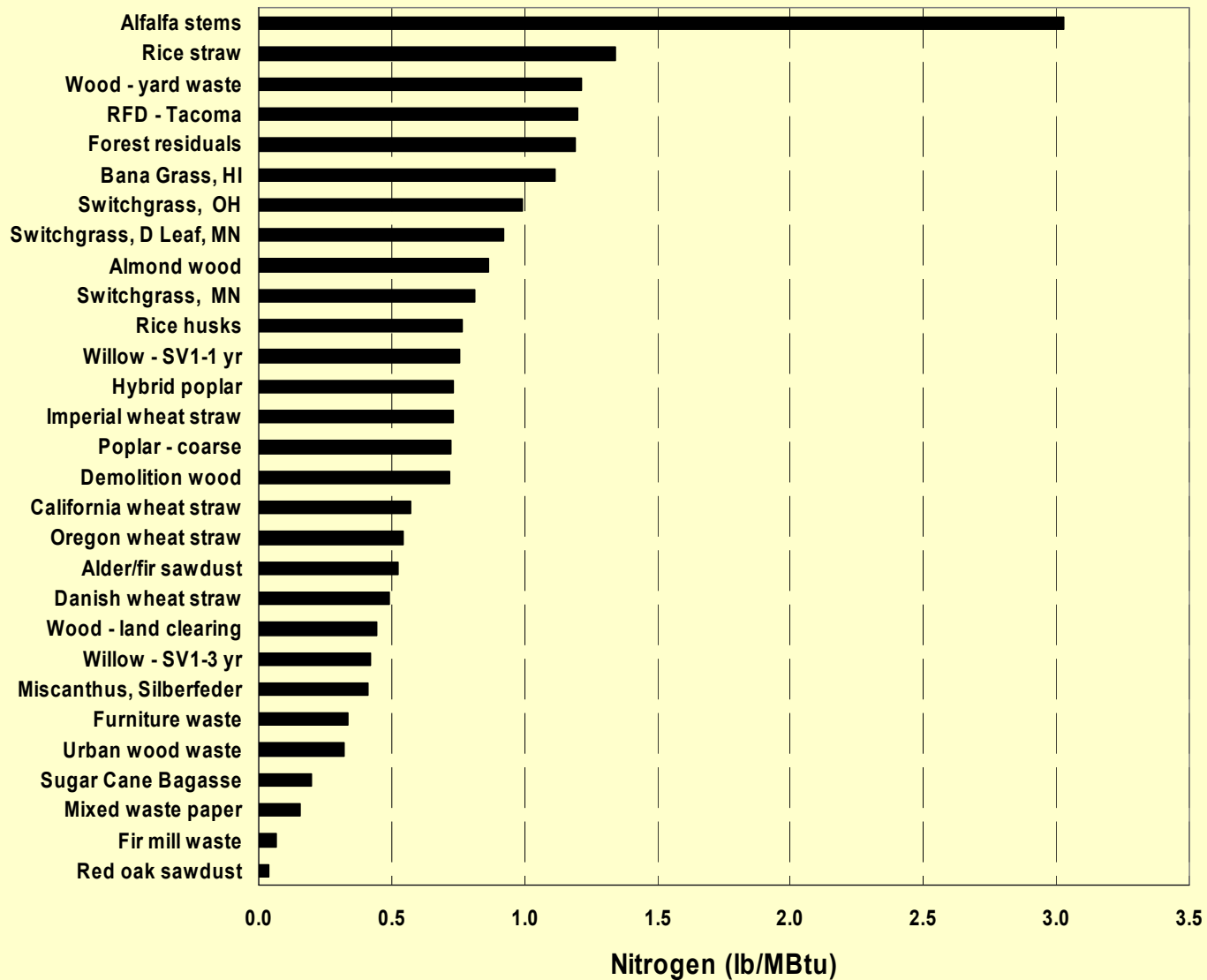

# Combustion

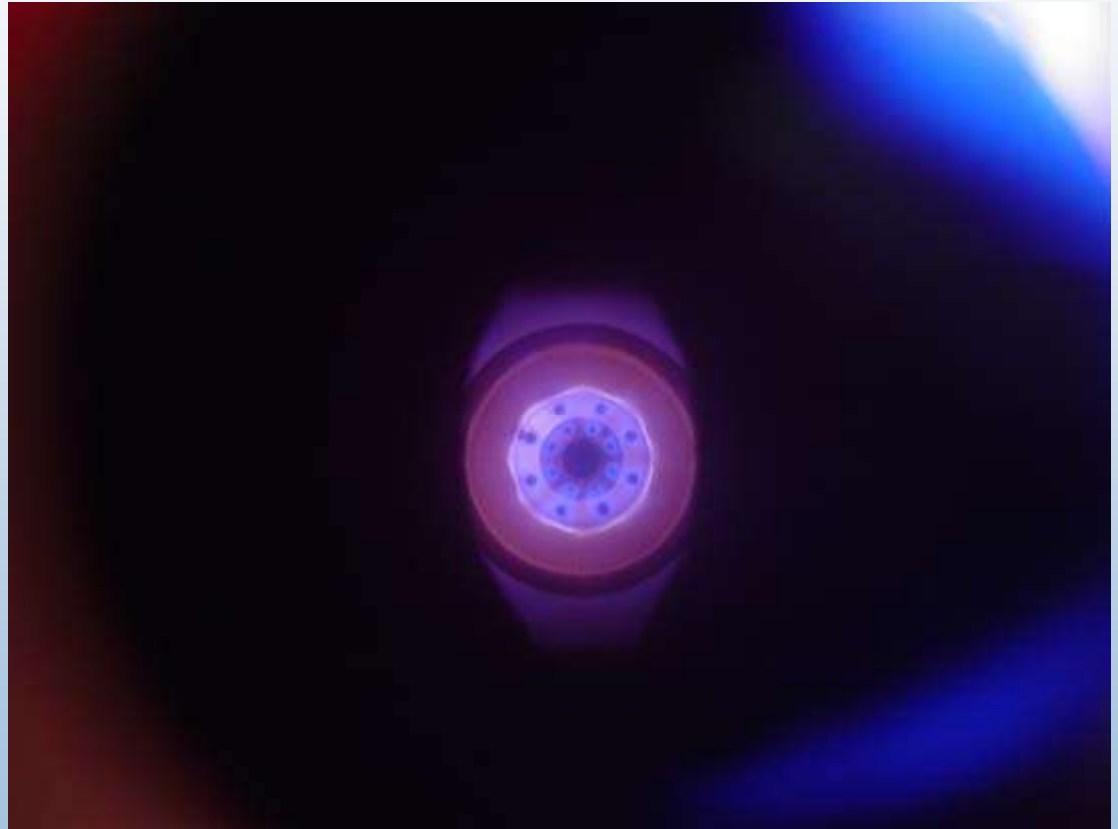

# Stages of Combustion of Solids

- Drying
- Devolatilization
  - ✓ Pyrolysis
  - ✓ Gasification
- Flaming Combustion
- Residual Char Combustion



# Combustion Reactions

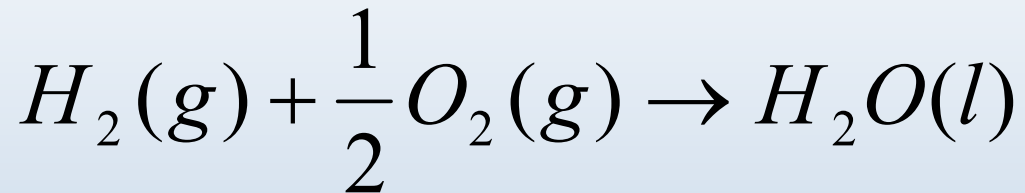

HHV = water as liquid

LHV = water as gas

# Combustor Types

- **Stoker Grate**
- **Fluid Bed**
- **Circulating Fluid Bed**
- **Entrained Flow**

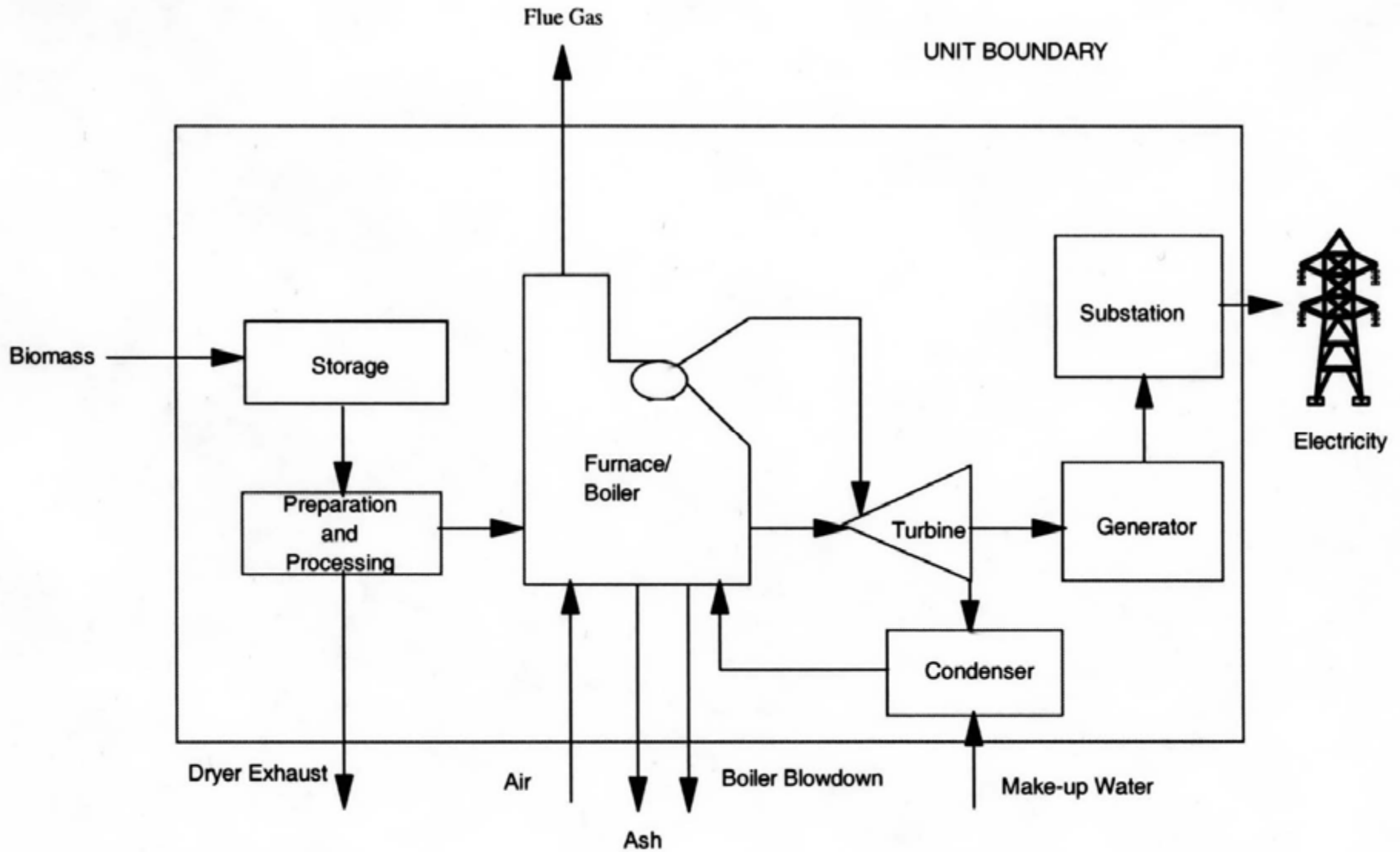

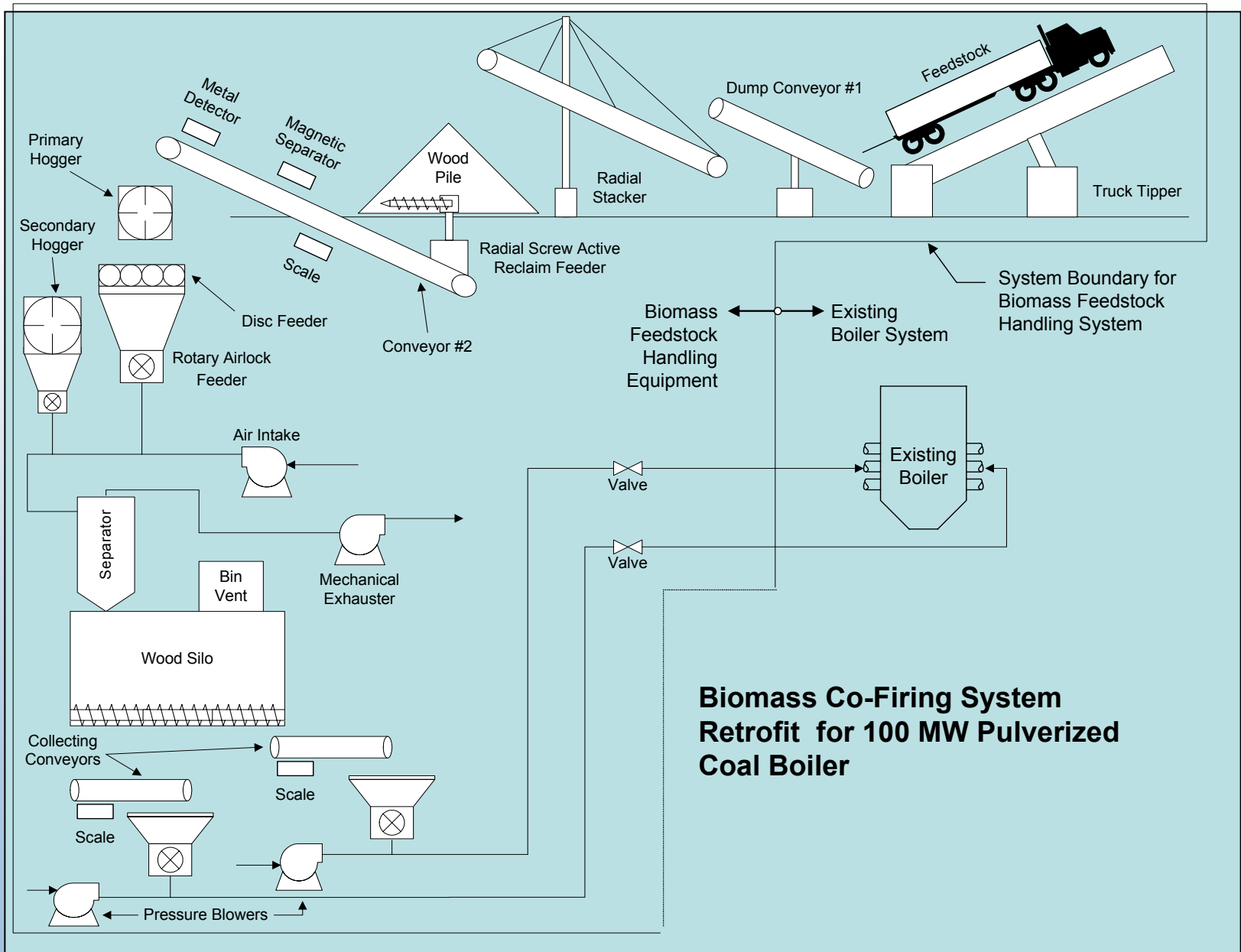

## Biomass Co-Firing System Retrofit for 100 MW Pulverized Coal Boiler

**Direct Air Emissions from Wood Residue Facilities by Boiler Type  
(lb/MWh)**

	SO <sub>x</sub>	NO <sub>x</sub>	CO	PM-10 <sup>1</sup>	Comments
<b>Biomass Technology</b>					
Stoker Boiler, Wood Residues (1,4)	0.08	2.1 (biomass type not specified)	12.2 (biomass type not specified)	0.50 (total particulates) (biomass type not specified)	Based on 23 California grate boilers, except for SO <sub>2</sub> (uncontrolled)
Fluidized Bed, Biomass (4)	0.08 (biomass type not specified)	0.9 (biomass type not specified)	0.17 (biomass type not specified)	0.3 (total particulates) (biomass type not specified)	Based on 11 California fluid bed boilers.
Energy Crops (Poplar) Gasification (a,b)	0.05 ( <b>suggested</b> value based on SO <sub>x</sub> numbers for Stoker and FBC, adjusted by a factor of 9,180/13,800 to account for heat rate improvement)	1.10 to 2.2 (0.66 to 1.32 w /SNCR; 0.22 to 0.44 w ith SCR)	0.23	0.01 (total particulates)	Combustor flue gas goes through cyclone and baghouse. Syngas goes through scrubber and baghouse before gas turbine. No controls on gas turbine.
<b>Coal Technology</b>					
Bituminous Coal, Stoker Boiler (f)	20.2 1 wt% S coal	5.8	2.7	0.62	PM Control only (baghouse)
Pulverized Coal Boiler (d)	14.3	6.89	0.35	0.32 (total particulates)	Average US PC boiler (typically:baghouse, limestone FGC)
Cofiring 15% Biomass (d2)	12.2	6.17	0.35	0.32 (total particulates)	?
Fluidized Bed, Coal (f)	3.7 (1 wt% S coal Ca/S = 2.5)	2.7	9.6	0.30	Baghouse for PM Control, Ca sorbents used for SO <sub>x</sub>
<b>Natural Gas Technology</b>					
4-Stroke NG Reciprocating Engine (g)	0.006	7.96-38.3 (depends on load and air:fuel ratio)	2.98-35.0 (depends on load and air:fuel ratio)	0.09-0.18 (depends on load and air:fuel ratio)	No control except PCC at high-end of PM-10 range
Natural Gas Turbine (e)	0.009 (0.0007 w t% S)	1.72	0.4	.09 (total particulates)	Water-steam injection only
Natural Gas Combined Cycle (c,e)	0.004	0.91 (0.21 w / SCR)	0.06	0.14 (total particulates)	Water-steam injection only

## NOx Emissions - Life Cycle Total and Plant Operating Emissions

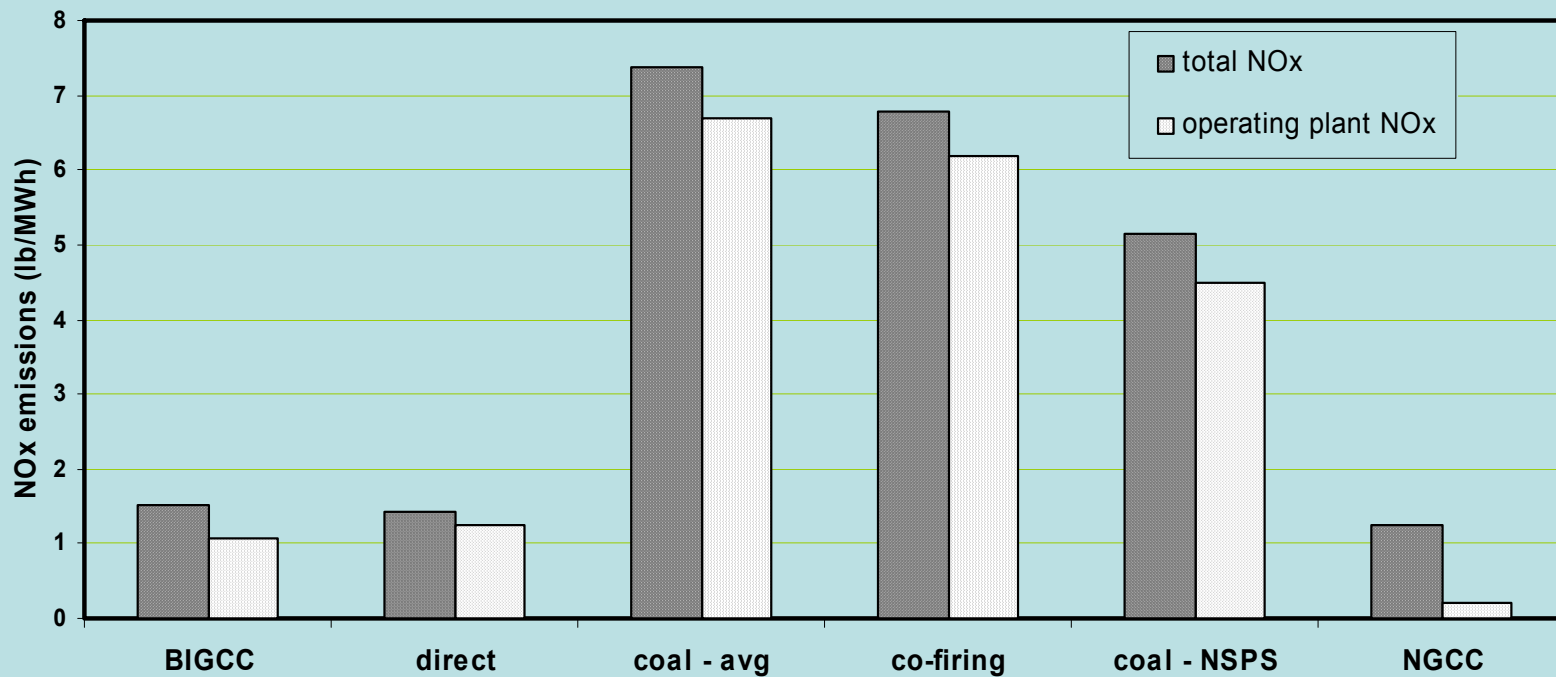

# Life Cycle CO<sub>2</sub> and Energy Balance for a Direct-Fired Biomass System

Current biomass power industry

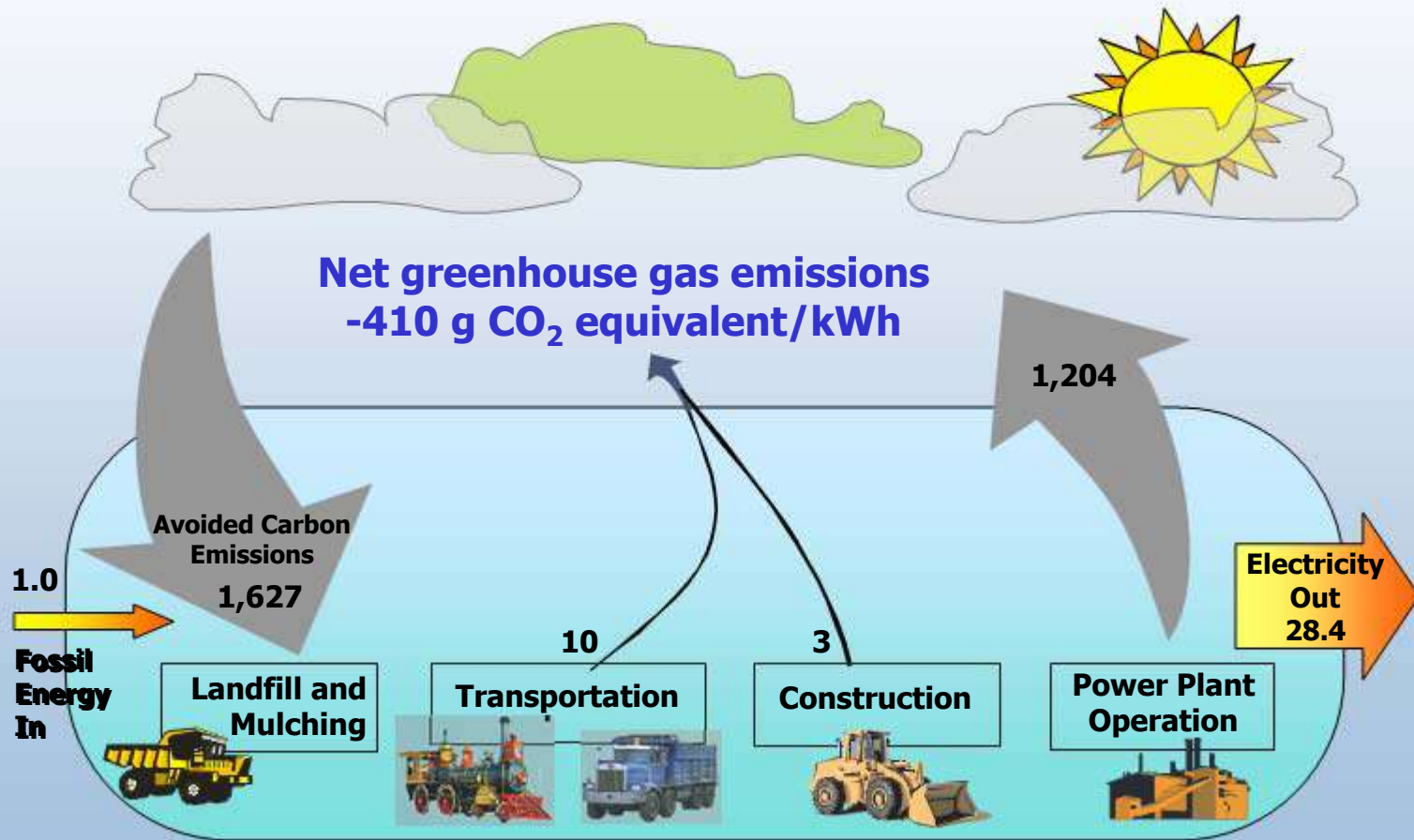

Direct-Fired Biomass Residue System  
134% carbon closure

**Figure 5.11: Biomass CHP - Effect of Plant Size on Cost of Electricity and Steam**

Feed Cost = \$2/MBtu

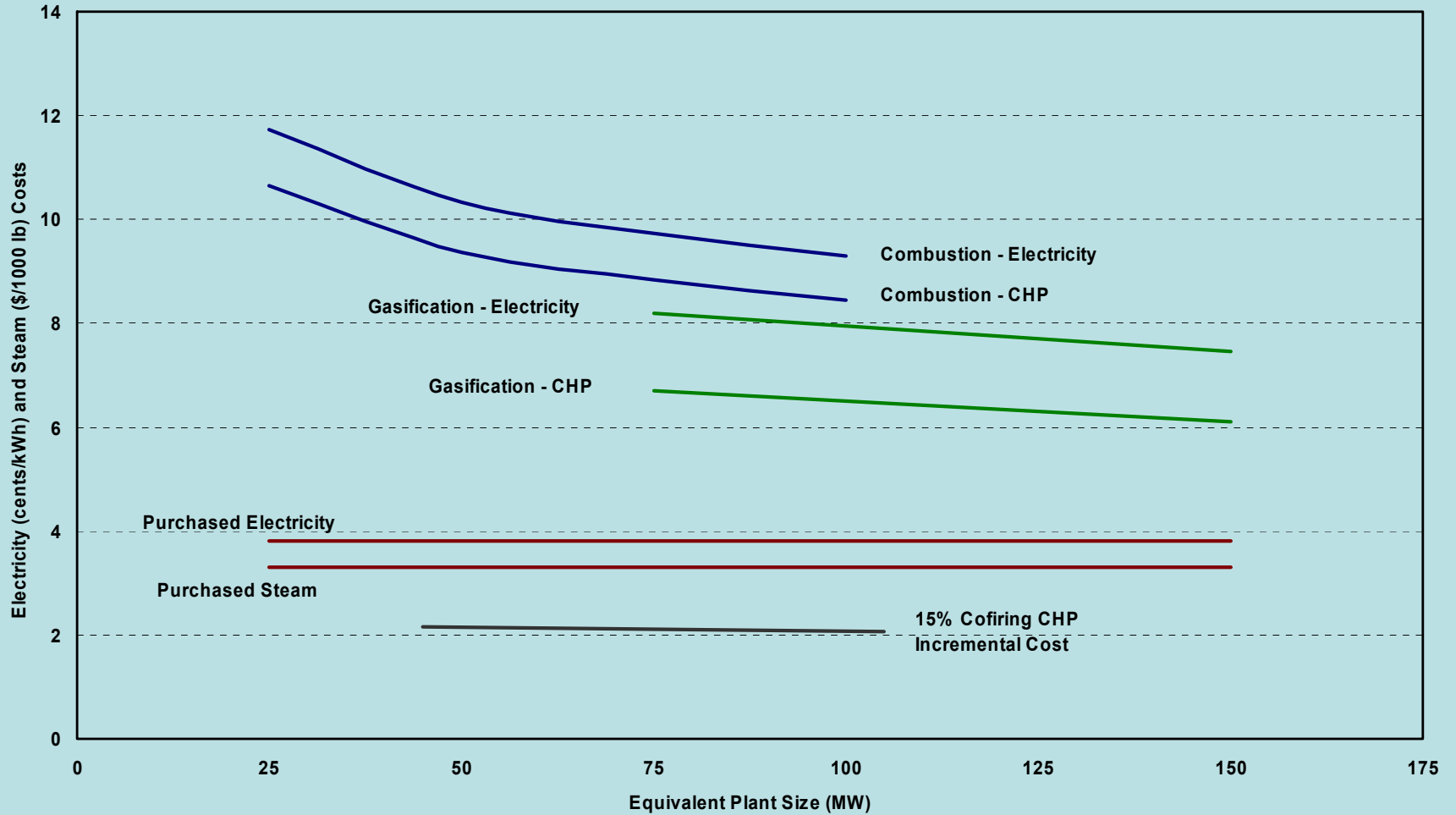



# Biomass CHP - Sensitivity to Feed Cost

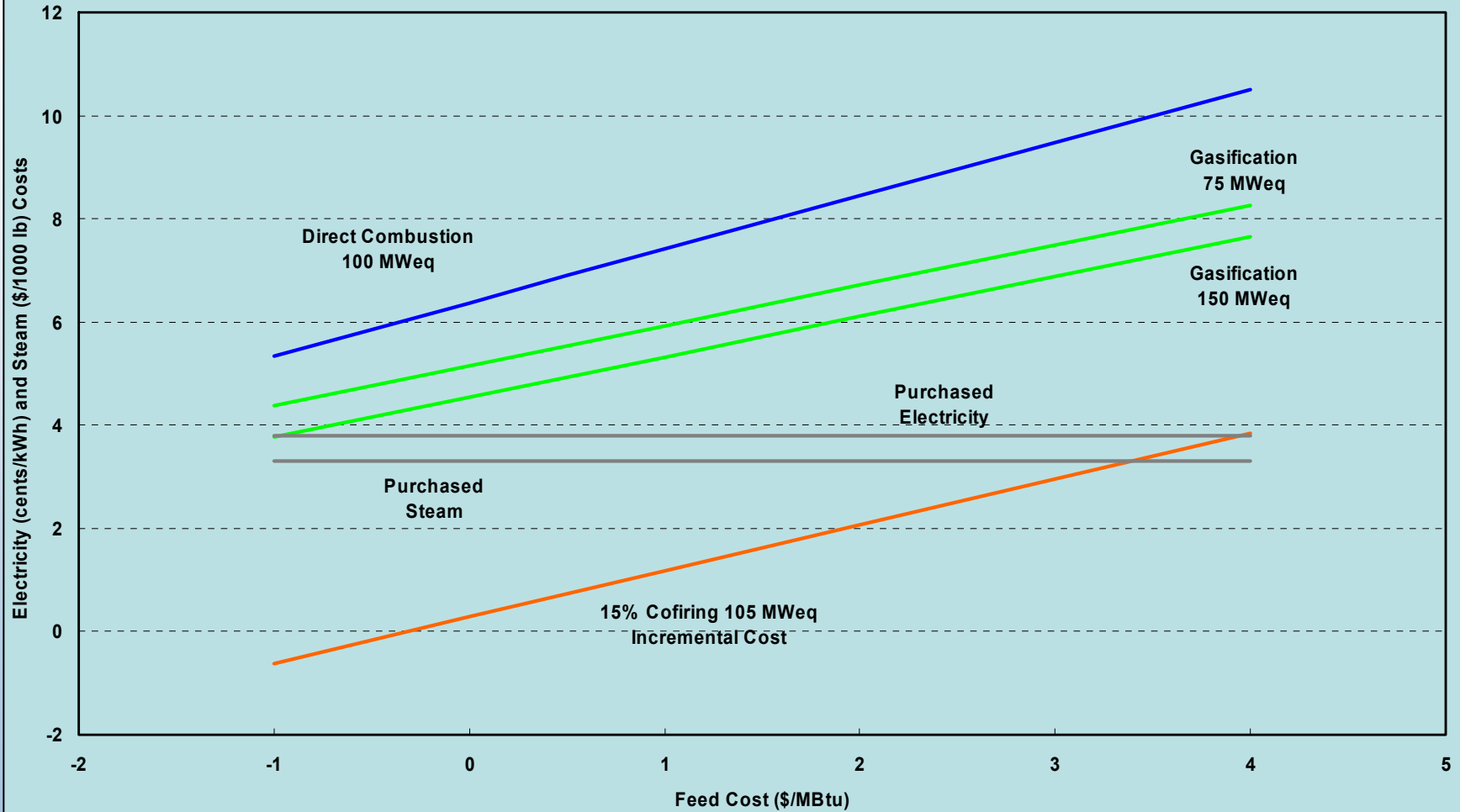

# Biomass Thermochemical Conversion For Fuels and Chemicals

## PRODUCTS

- Hydrogen
- Alcohols
- FT Gasoline
- FT Diesel
- Olefins
- Oxochemicals
- Ammonia
- SNG

- Hydrogen
- Olefins
- Oils
- Specialty Chem

- Hydrogen
- Methane
- Oils
- Other

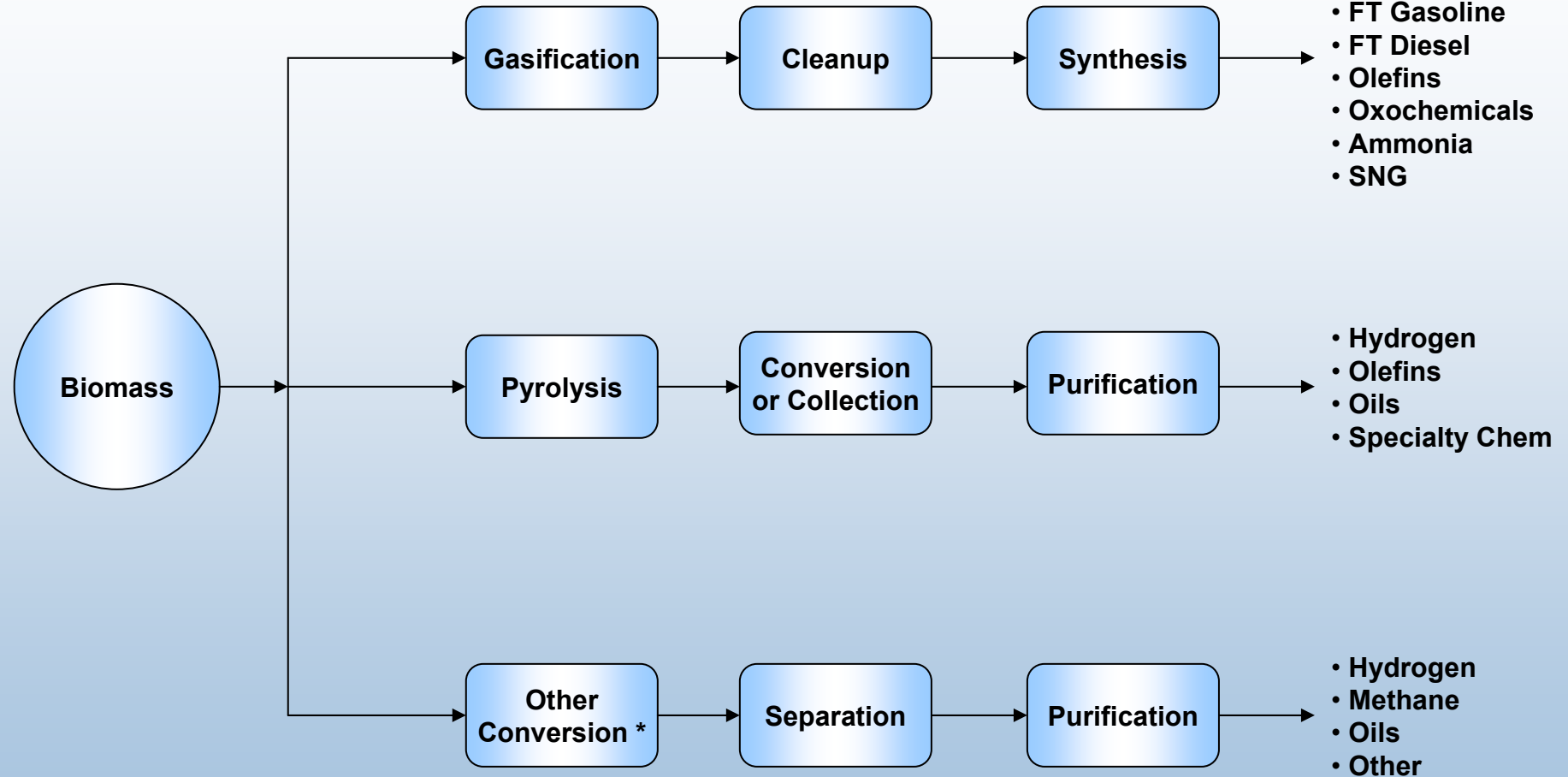

\* Examples: Hydrothermal Processing, Liquefaction, Wet Gasification

# Thermochemical Conversion Of Biomass and Black Liquor

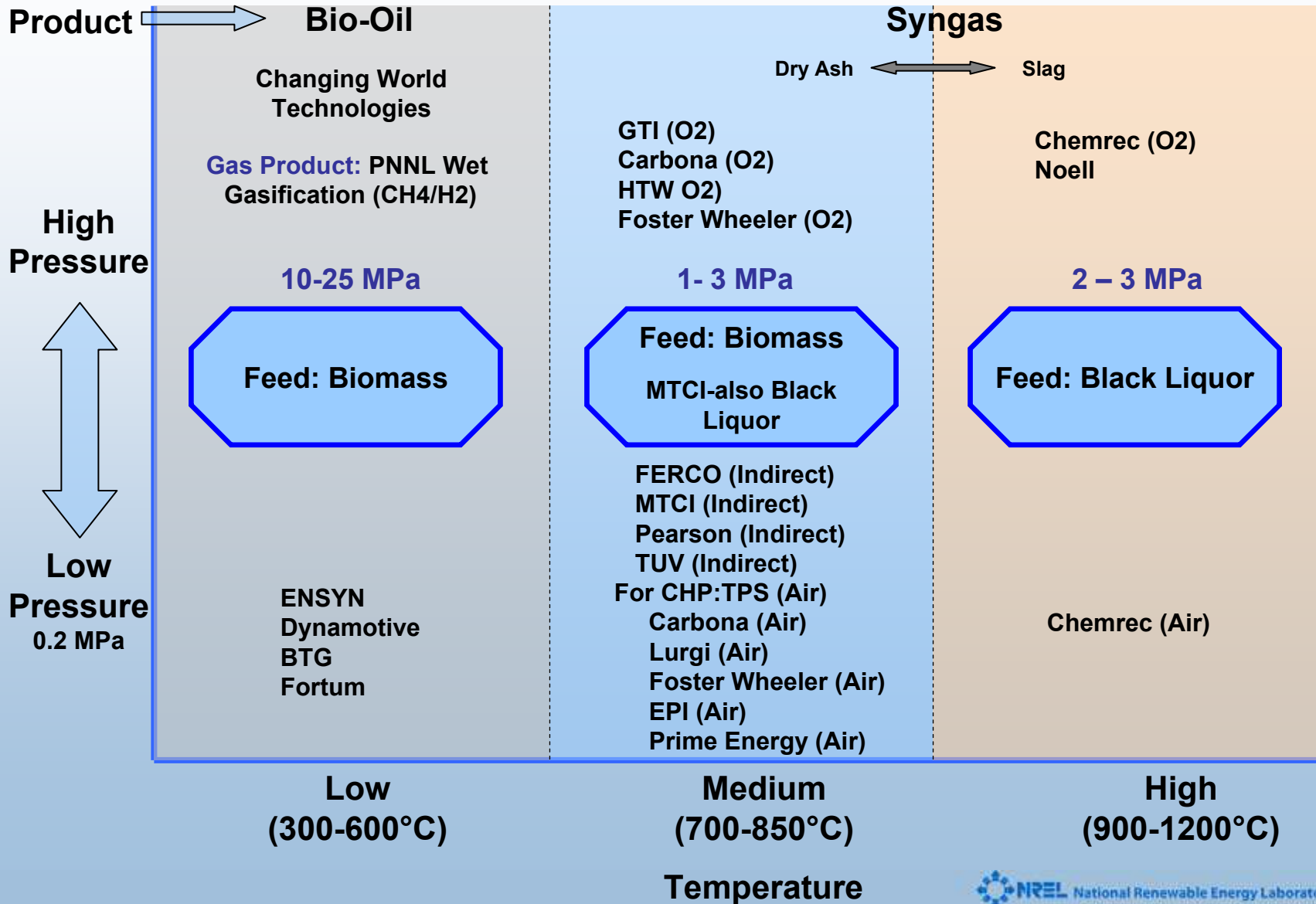

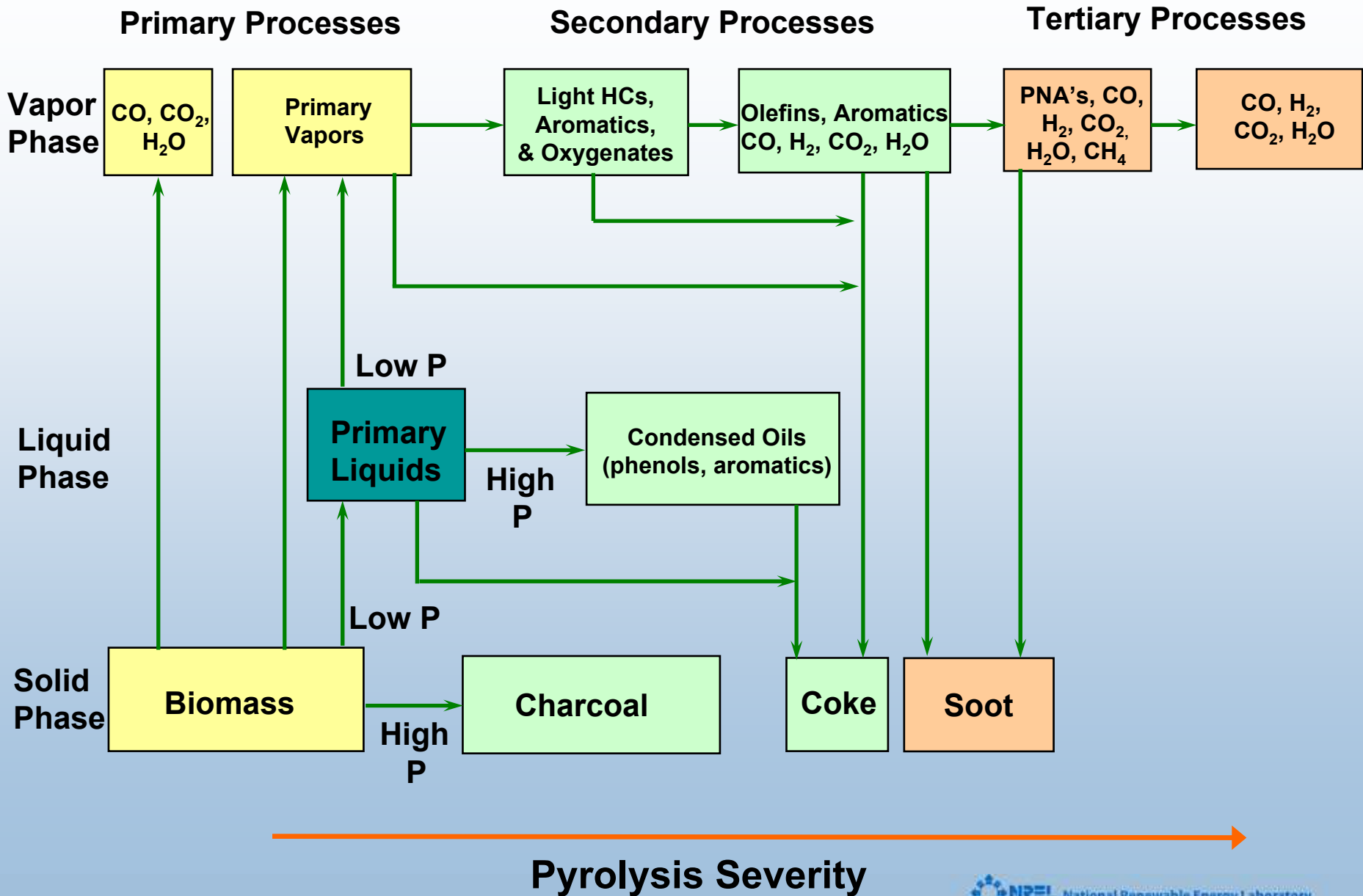

<u>Mixed Oxygenates</u> 400 °C	<u>Phenolic Ethers</u> 500 °C	<u>Alkyl Phenolics</u> 600 °C	<u>Heterocyclic Ethers</u> 700 °C	<u>PAH</u> 800 °C	<u>Larger PAH</u> 900 °C
Conventional Flash Pyrolysis (450 - 500°C)	Hi-Temperature Flash Pyrolysis (600 - 650°C)	Conventional Steam Gasification (700 - 800°C)	Hi-Temperature Steam Gasification (900 - 1000°C)		
Acids Aldehydes Ketones Furans Alcohols Complex Oxygenates Phenols Guaiacols Syringols Complex Phenols	Benzenes Phenols Catechols Naphthalenes Biphenyls Phenanthrenes Benzofurans Benzaldehydes	Naphthalenes Acenaphthylenes Fluorenes Phenanthrenes Benzaldehydes Phenols Naphthofurans Benzanthracenes	Naphthalene* Acenaphthylene Phenanthrene Fluoranthene Pyrene Acephanthrylene Benzanthracenes Benzopyrenes 226 MW PAHs 276 MW PAHs		
* At the highest severity, naphthalenes such as methyl naphthalene are stripped to simple naphthalene.					

**Chemical Components in biomass tars (Elliott, 1988)**

# Gasification

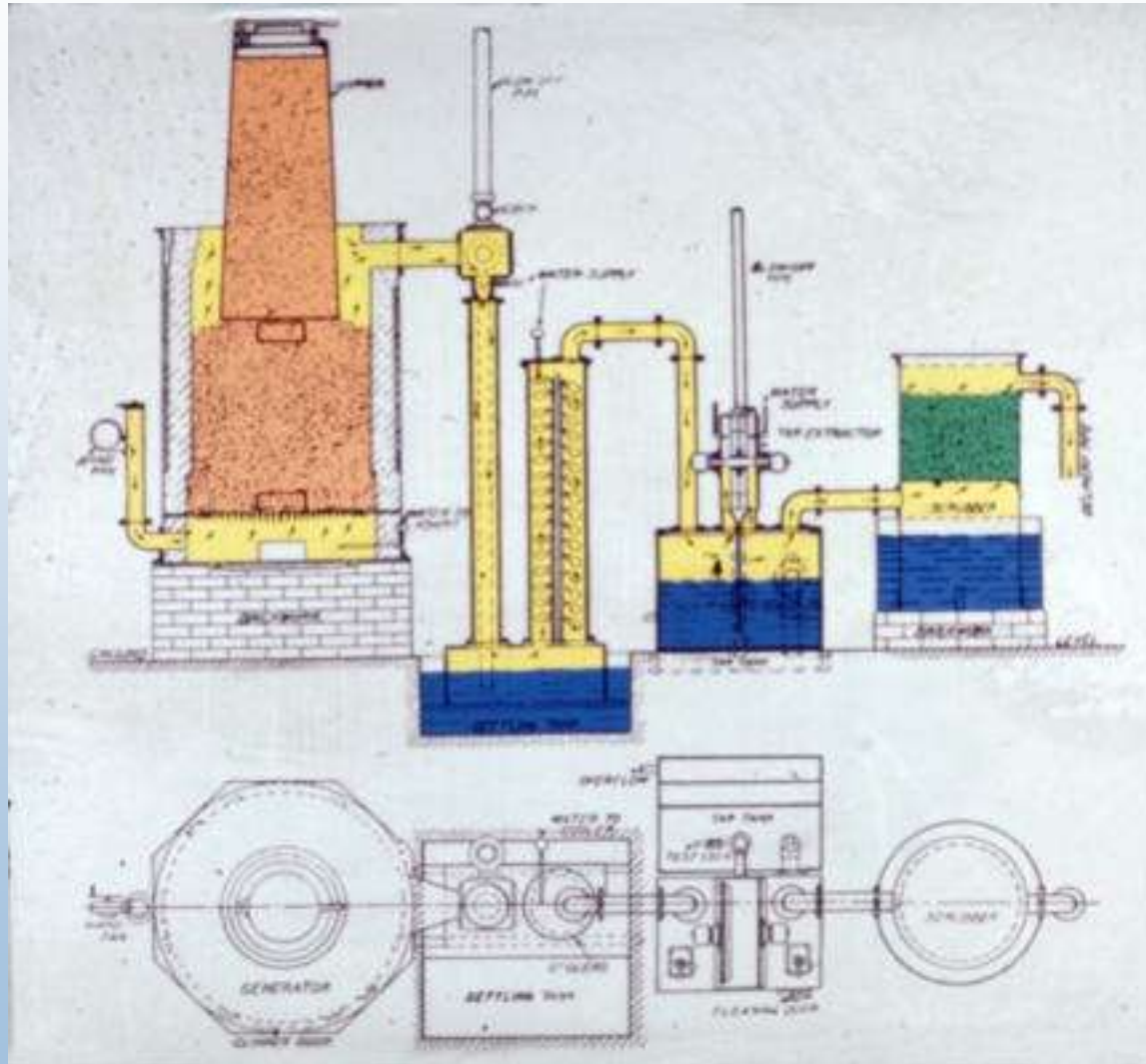

Circa 1898

# 1792 and all that

- **Murdoch (1792) coal distillation**
- **London gas lights 1802**
- **Blau gas – Fontana 1780**
- **1900s Colonial power**
- **MeOH 1913 BASF**
- **Fischer Tropsch 1920s**
- **Vehicle Gazogens WWII**
- **SASOL 1955 - Present**
- **GTL 1995 – Present**
- **Hydrogen – Future?**



# Representative Gasification Pathways

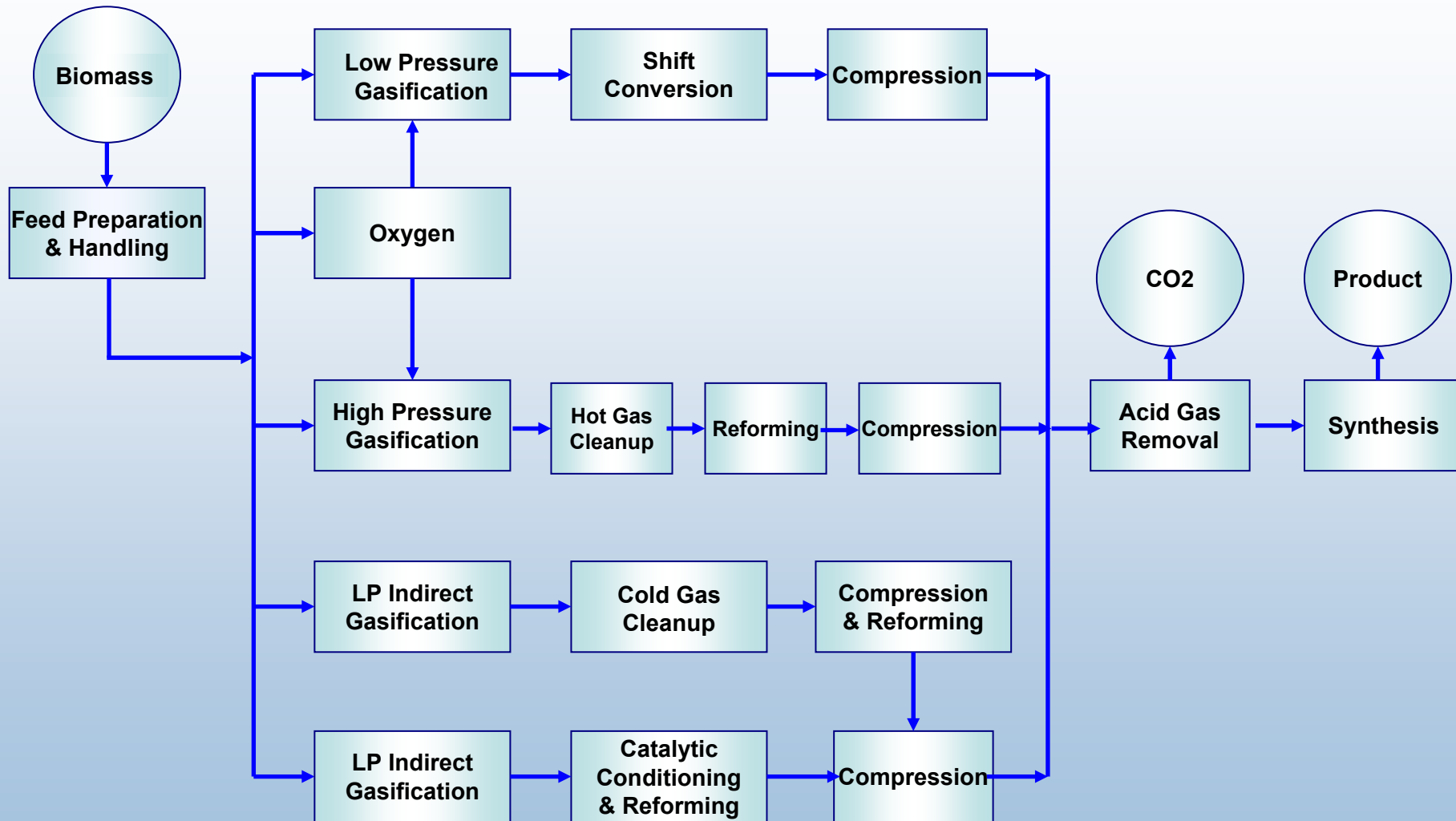



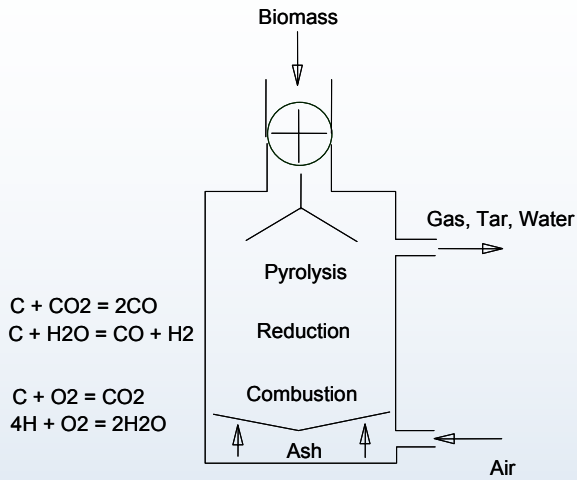

Updraft Gasifier

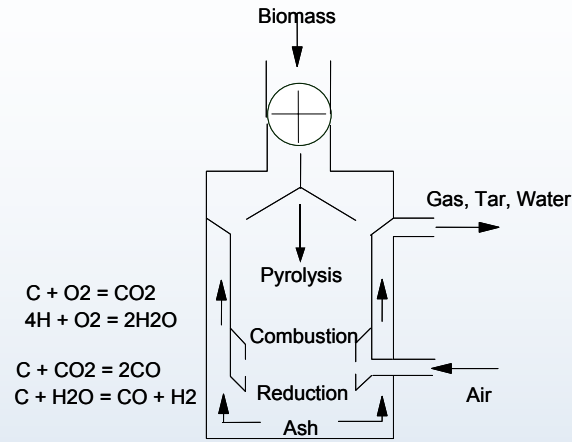

Downdraft Gasifier

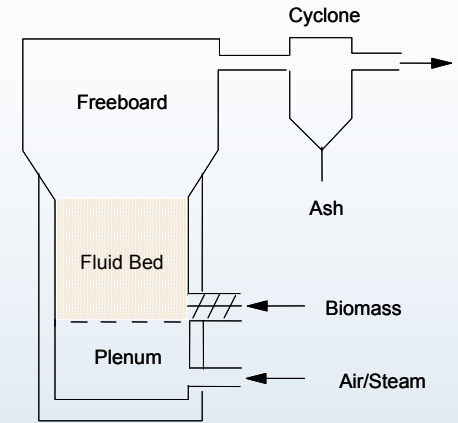

Fluid-Bed Gasifier

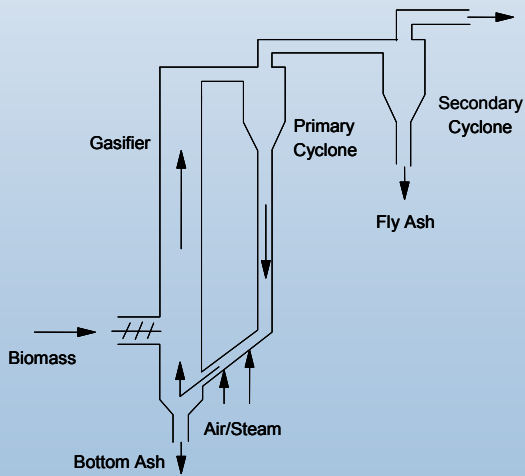

Circulating Fluid-Bed Gasifier

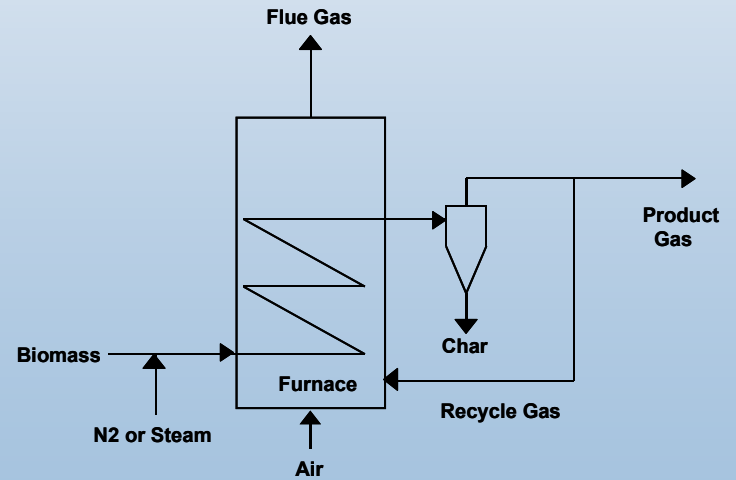

Entrained Flow Gasifier

# Gasifier Types-Advantages and Disadvantages

## Gasifier

## Advantages

## Disadvantages

Updraft

Mature for heat  
Small scale applications  
Can handle high moisture  
No carbon in ash

Feed size limits  
High tar yields  
Scale limitations  
Producer gas  
Slagging potential

Downdraft

Small scale applications  
Low particulates  
Low tar

Feed size limits  
Scale limitations  
Producer gas  
Moisture sensitive

Fluid Bed

Large scale applications  
Feed characteristics  
Direct/indirect heating  
Can produce syngas

Medium tar yield  
Higher particle loading

Circulating Fluid Bed

Large scale applications  
Feed characteristics  
Can produce syngas

Medium tar yield  
Higher particle loading

Entrained Flow

Can be scaled  
Potential for low tar  
Can produce syngas

Large amount of carrier gas  
Higher particle loading  
Potentially high S/C  
Particle size limits

**Table 2: Gas composition for fluid bed and circulating fluid bed gasifiers**

<b>Gasifier</b>	<b>FERCO</b>	<b>Carbona</b>	<b>Princeton Model</b>	<b>IGT</b>
<b>Type</b>	<b>Indirect CFB</b>	<b>Air FB</b>	<b>Indirect FB</b>	<b>PFB</b>
<b>Agent</b>	<b>steam</b>	<b>air</b>	<b>steam</b>	<b>O<sub>2</sub>/steam</b>
<b>Bed Material</b>	<b>olivine</b>	<b>sand</b>	<b>none</b>	<b>alumina</b>
<b>Feed</b>	<b>wood chips</b>	<b>wood pellets</b>	<b>black liquor</b>	<b>wood chips</b>
<b>Gas Composition</b>				
<b>H<sub>2</sub></b>	<b>26.2</b>	<b>21.70</b>	<b>29.4</b>	<b>19.1</b>
<b>CO</b>	<b>38.2</b>	<b>23.8</b>	<b>39.2</b>	<b>11.1</b>
<b>CO<sub>2</sub></b>	<b>15.1</b>	<b>9.4</b>	<b>13.1</b>	<b>28.9</b>
<b>N<sub>2</sub></b>	<b>2</b>	<b>41.6</b>	<b>0.2</b>	<b>27.8</b>
<b>CH<sub>4</sub></b>	<b>14.9</b>	<b>0.08</b>	<b>13.0</b>	<b>11.2</b>
<b>C<sub>2</sub>+</b>	<b>4</b>	<b>0.6</b>	<b>4.4</b>	<b>2.0</b>
<b>GCV, MJ/Nm<sup>3</sup></b>	<b>16.3</b>	<b>5.4</b>	<b>17.2</b>	<b>9.2</b>

# Typical Gas Heating Values

<b>Gasifier</b>	<b>Inlet Gas</b>	<b>Product Gas Type</b>	<b>Product Gas HHV MJ/Nm<sup>3</sup></b>
<b>Partial Oxidation</b>	<b>Air</b>	<b>Producer Gas</b>	<b>7</b>
<b>Partial Oxidation</b>	<b>Oxygen</b>	<b>Synthesis Gas</b>	<b>10</b>
<b>Indirect</b>	<b>Steam</b>	<b>Synthesis Gas</b>	<b>15</b>
		<b>Natural Gas</b>	<b>38</b>
		<b>Methane</b>	<b>41</b>

## Biomass



Oxygen

Sulfur

Ash

Alkali

H/C Ratio

Heating Value

Tar Reactivity

## Coal



- Use coal gasifier cleanup technology for biomass
  - Issues
    - Coal cleanup designed for large, integrated plants
    - Extensive sulfur removal not needed for biomass
    - Biomass tars very reactive
    - Wet/cold cleanup systems produce significant waste streams that require cleanup/recovery – large plant needed for economy of scale for cleanup/recovery
    - Biomass particulates high in alkali
- Feed biomass to coal gasifiers
  - Issues
    - Feeding biomass (not just wood) – many commercial coal gasifiers are entrained flow requiring small particles
    - Gasifier refractory life/ash properties – biomass high in alkali
    - Character/reactivity of biomass tars may have unknown impact on chemistry/cleanup
    - Volumetric energy density a potential issue
    - Biomass reactivity – may react in feeder

# FERCO GASIFIER- BURLINGTON, VT

350 TPD

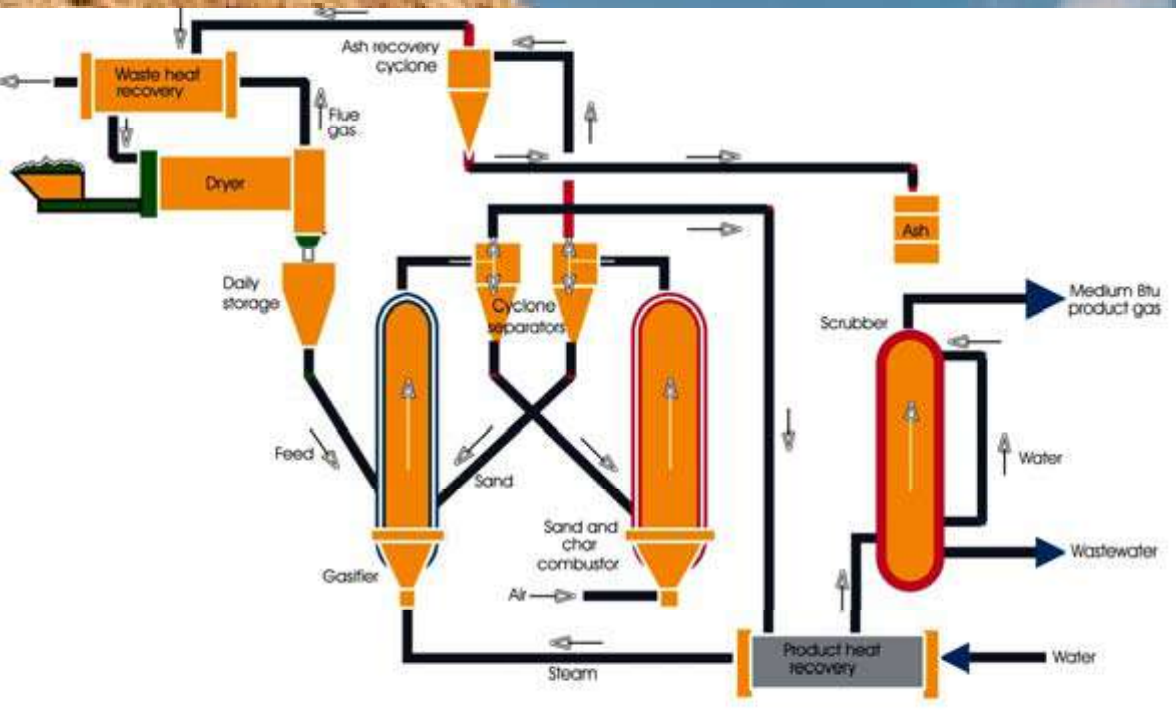

# Community Power Corporation's BioMax 15 Modular Biopower System

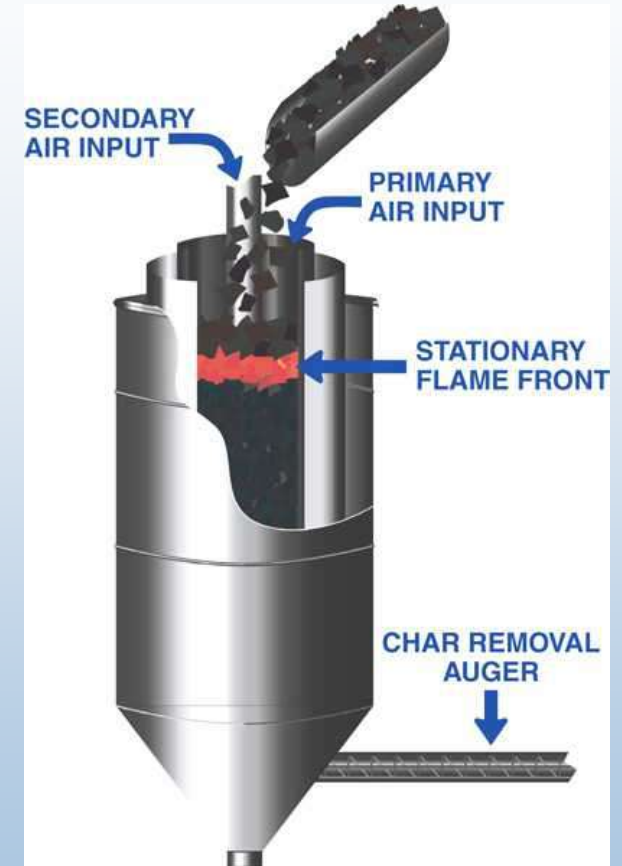

# Carbona Project: Skive, Denmark

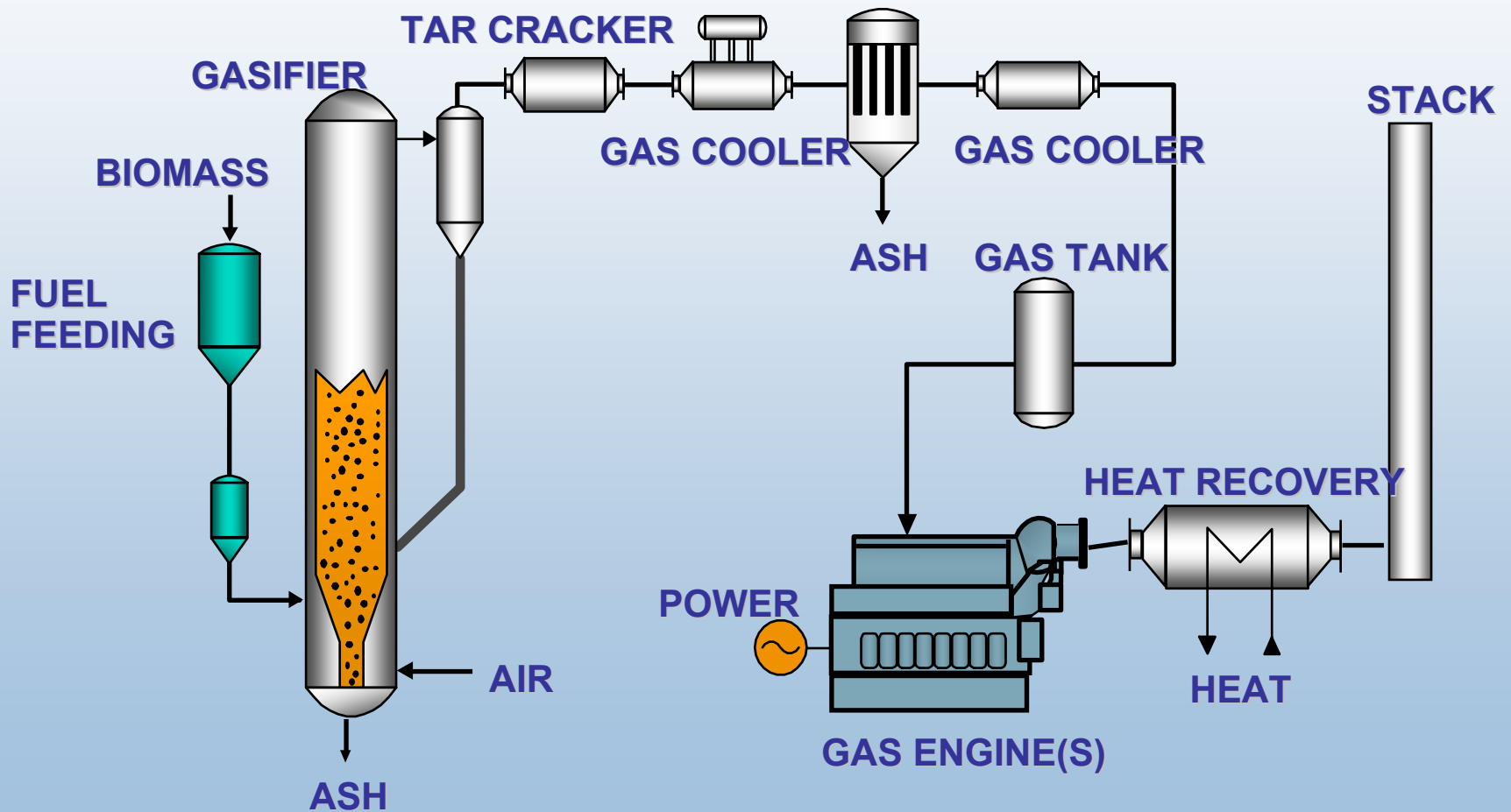



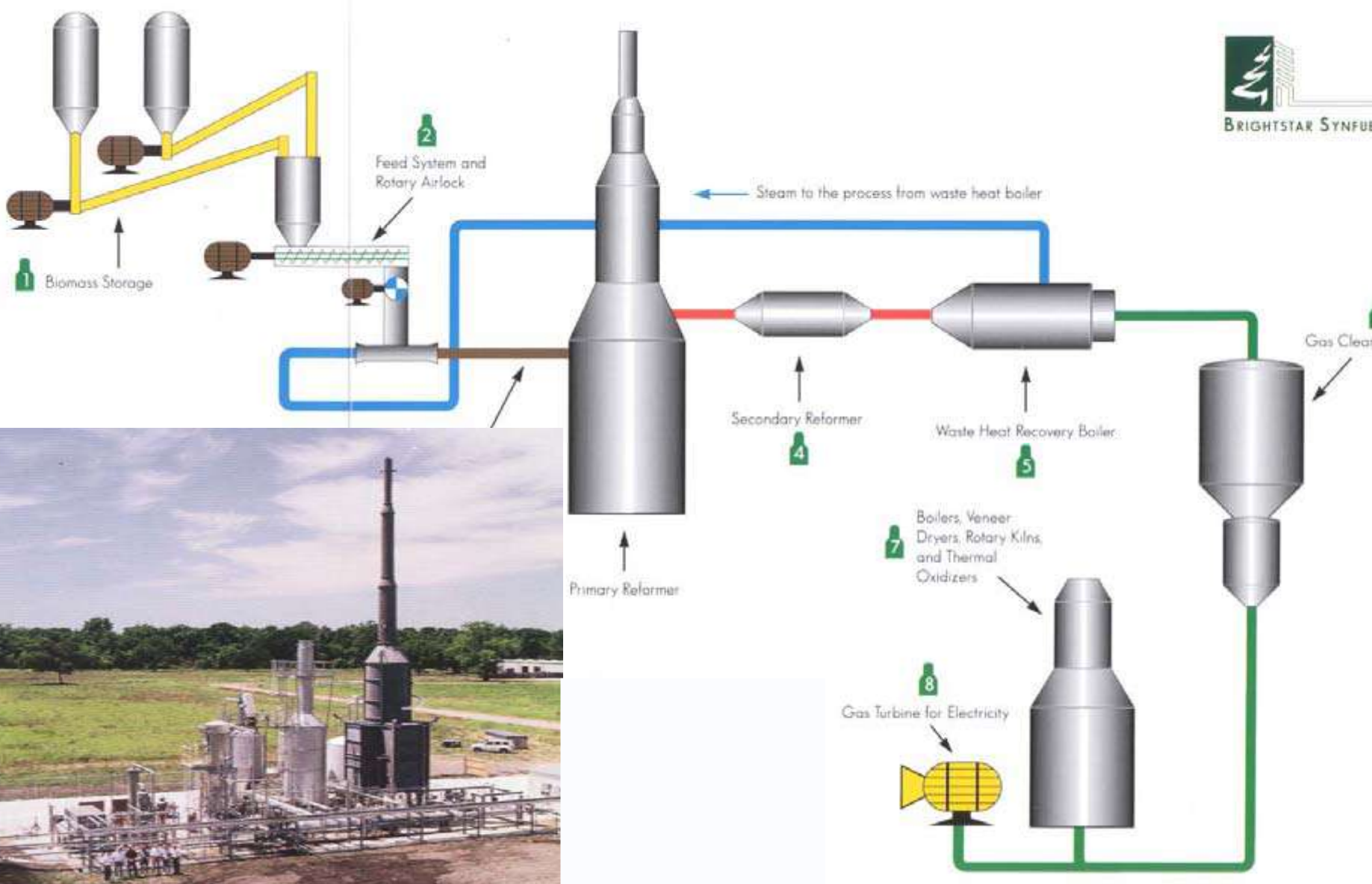

BSC Commercial Demonstration and Training Facility - St. Gabriel, LA

## Contribution to Hydrogen Price for BCL Low Pressure Indirectly-Heated Gasifier System (2,000 tonne/day plant; \$30/dry ton feedstock)

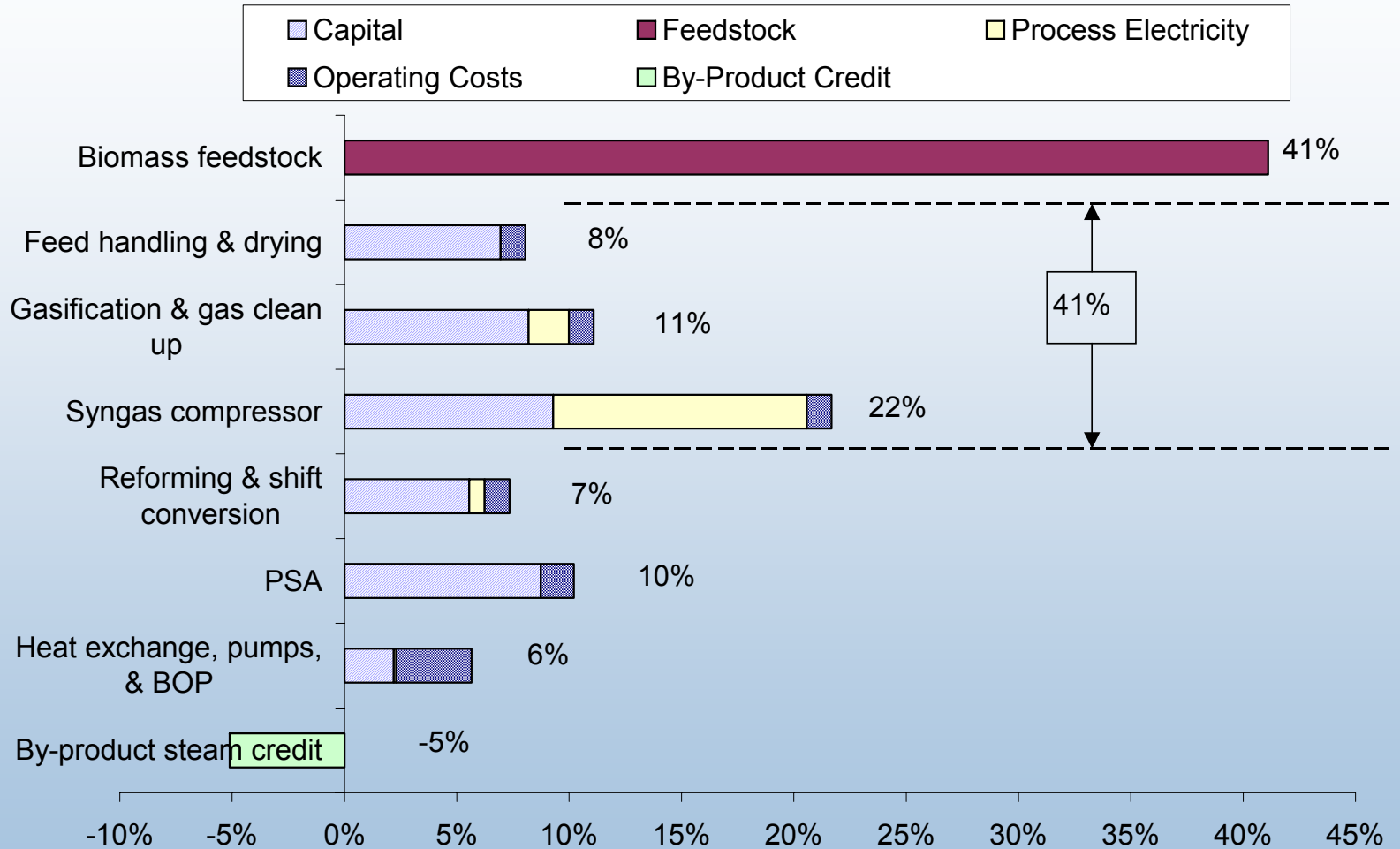

### Contribution to Hydrogen Price for BCL Low Pressure Indirectly-Heated Gasifier System (2,000 tonne/day plant; \$53/dry ton feedstock)

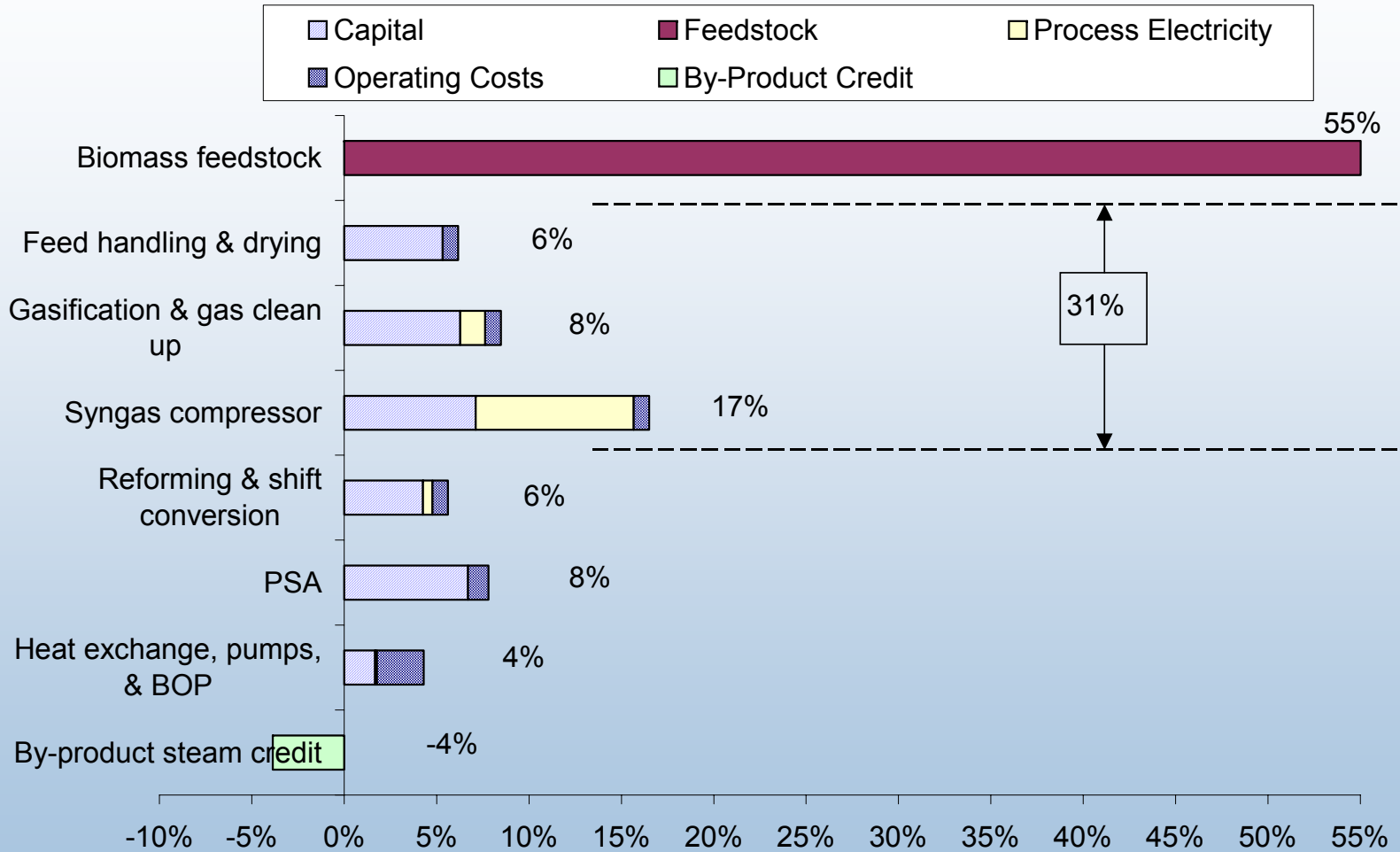

# Life Cycle GWP and Energy Balance for Advanced IGCC Technology using Energy Crop Biomass

Future, wide-spread potential

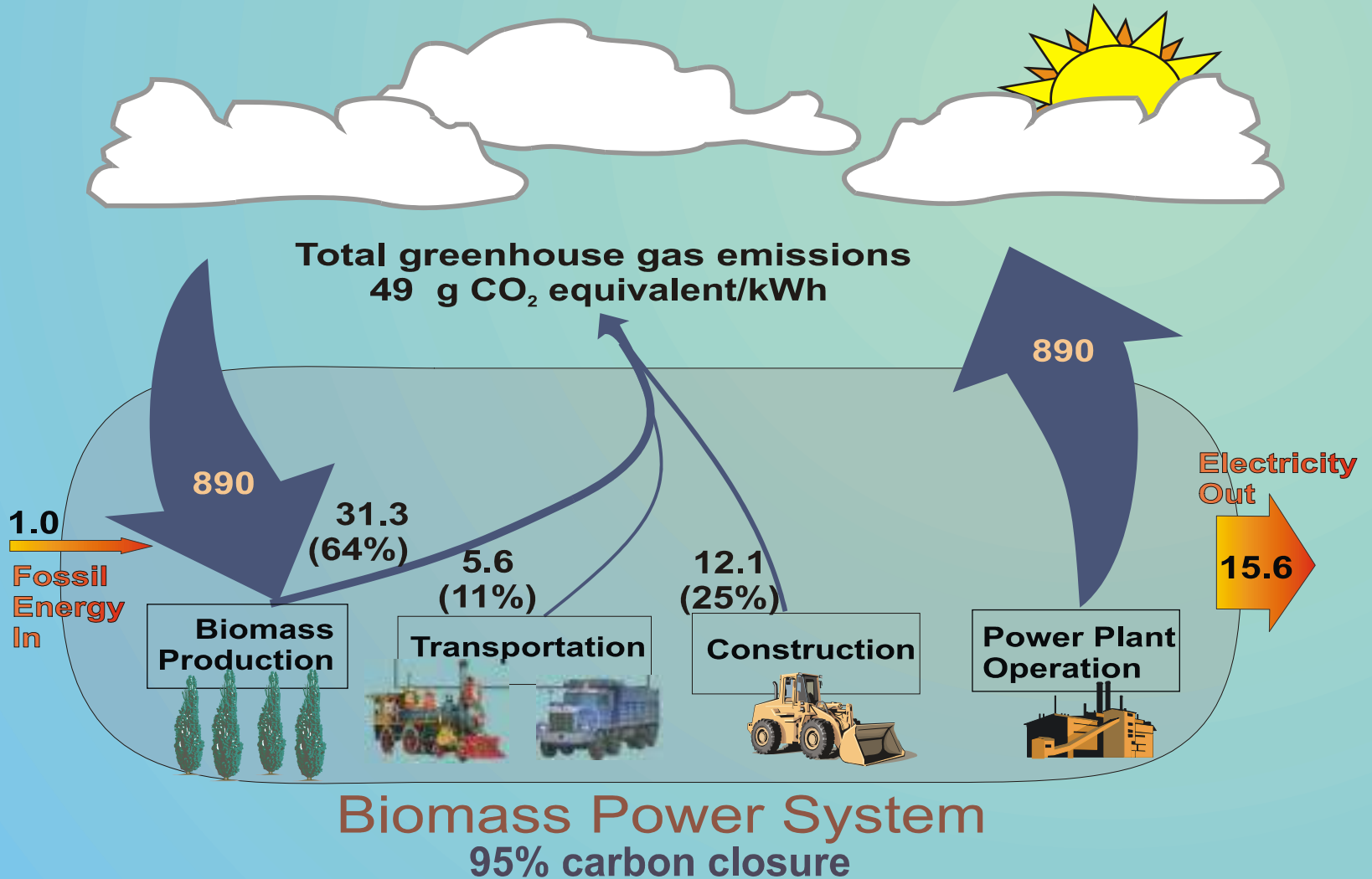

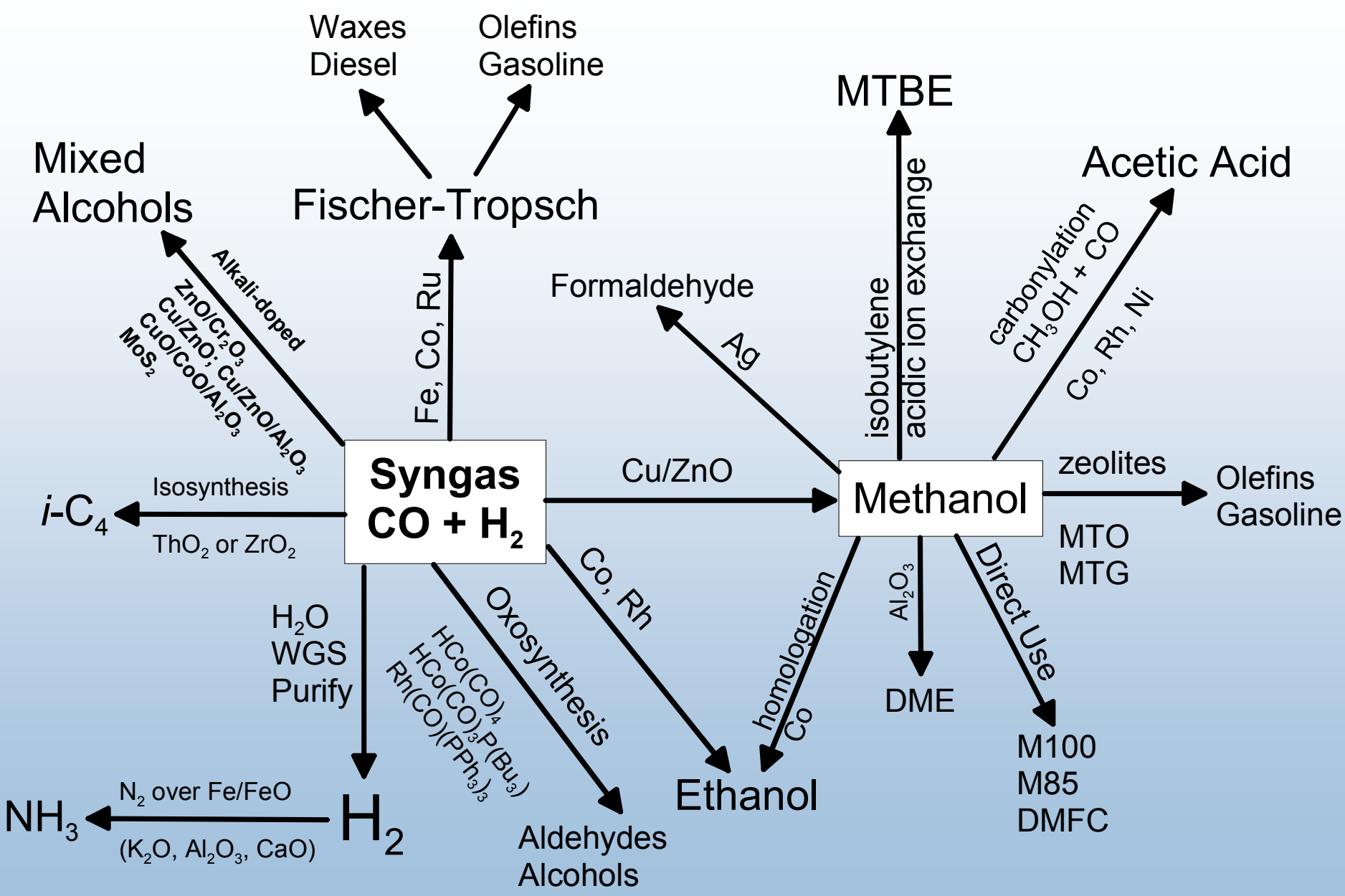

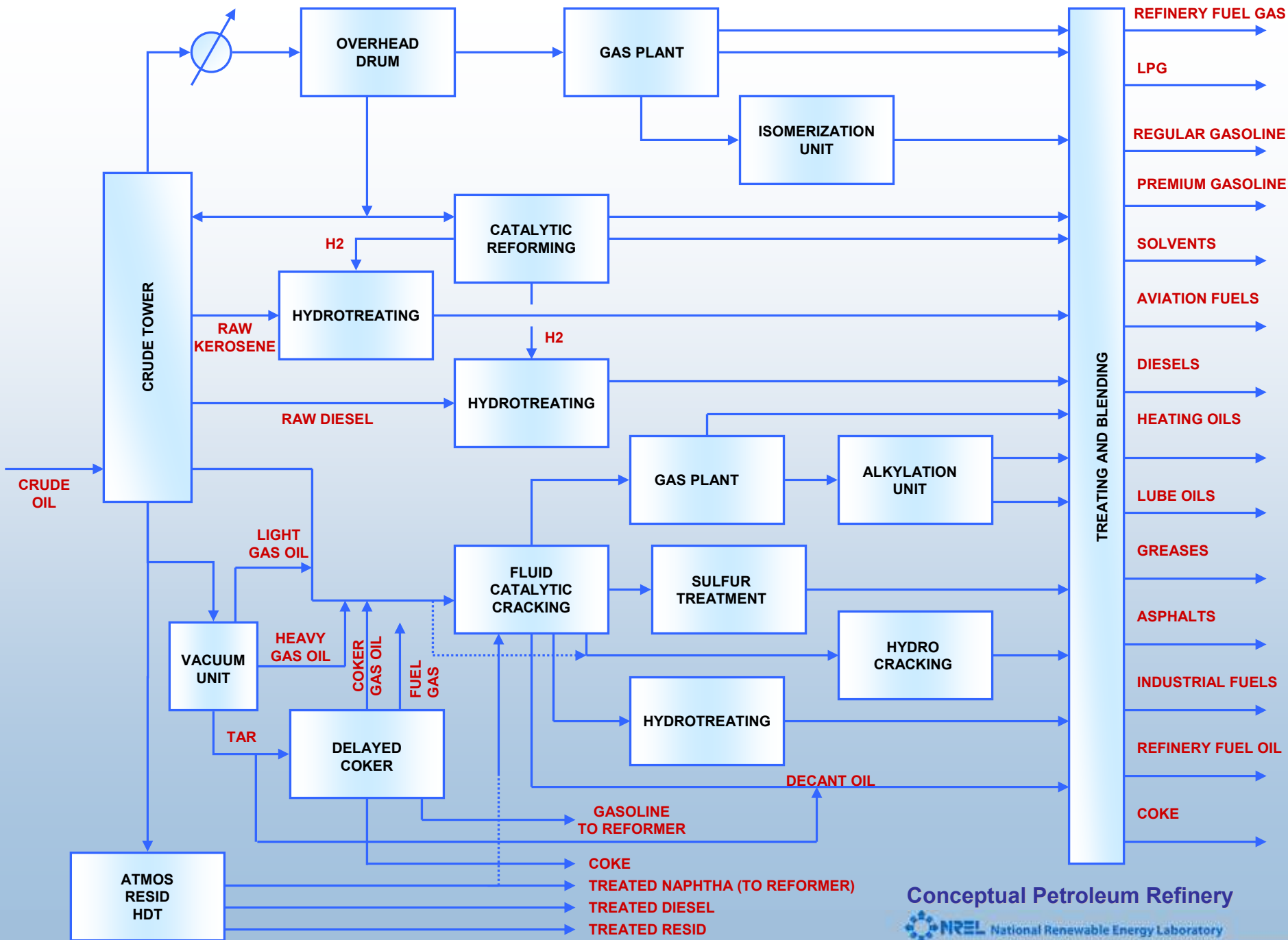

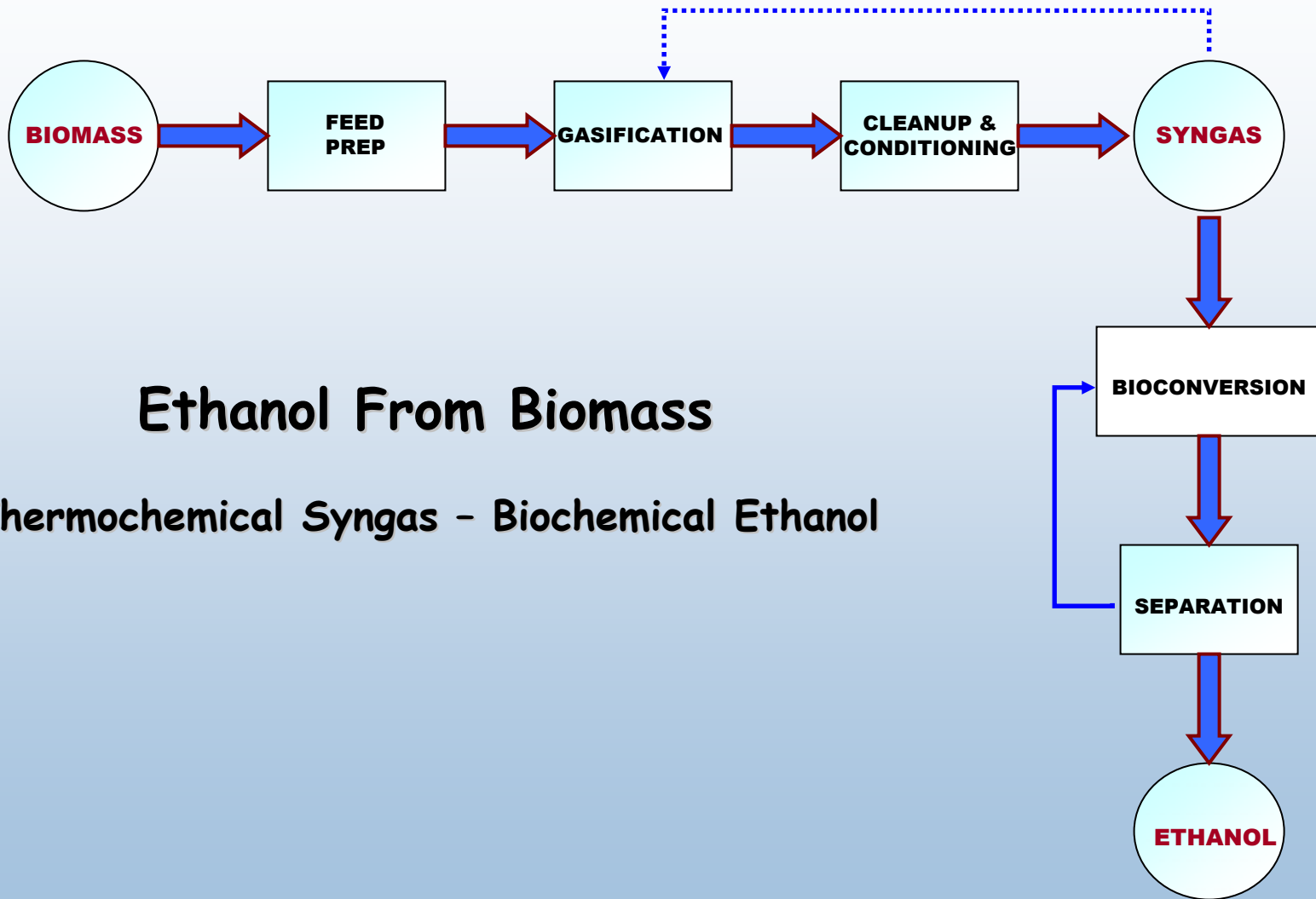

# Ethanol From Biomass

Thermochemical Syngas - Biochemical Ethanol

# Net Revenue Potential of Biorefinery on the U.S. Pulp Industry

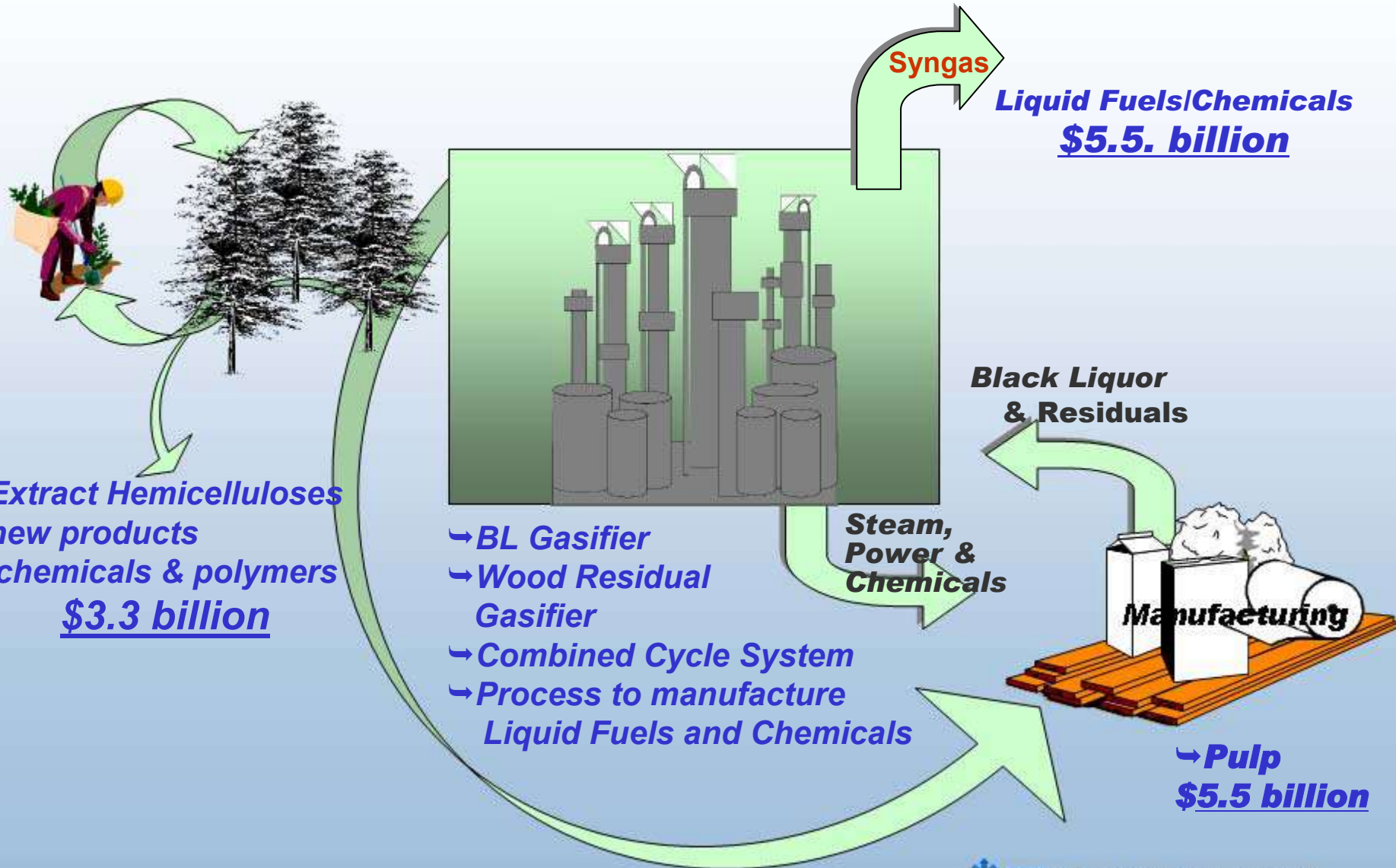



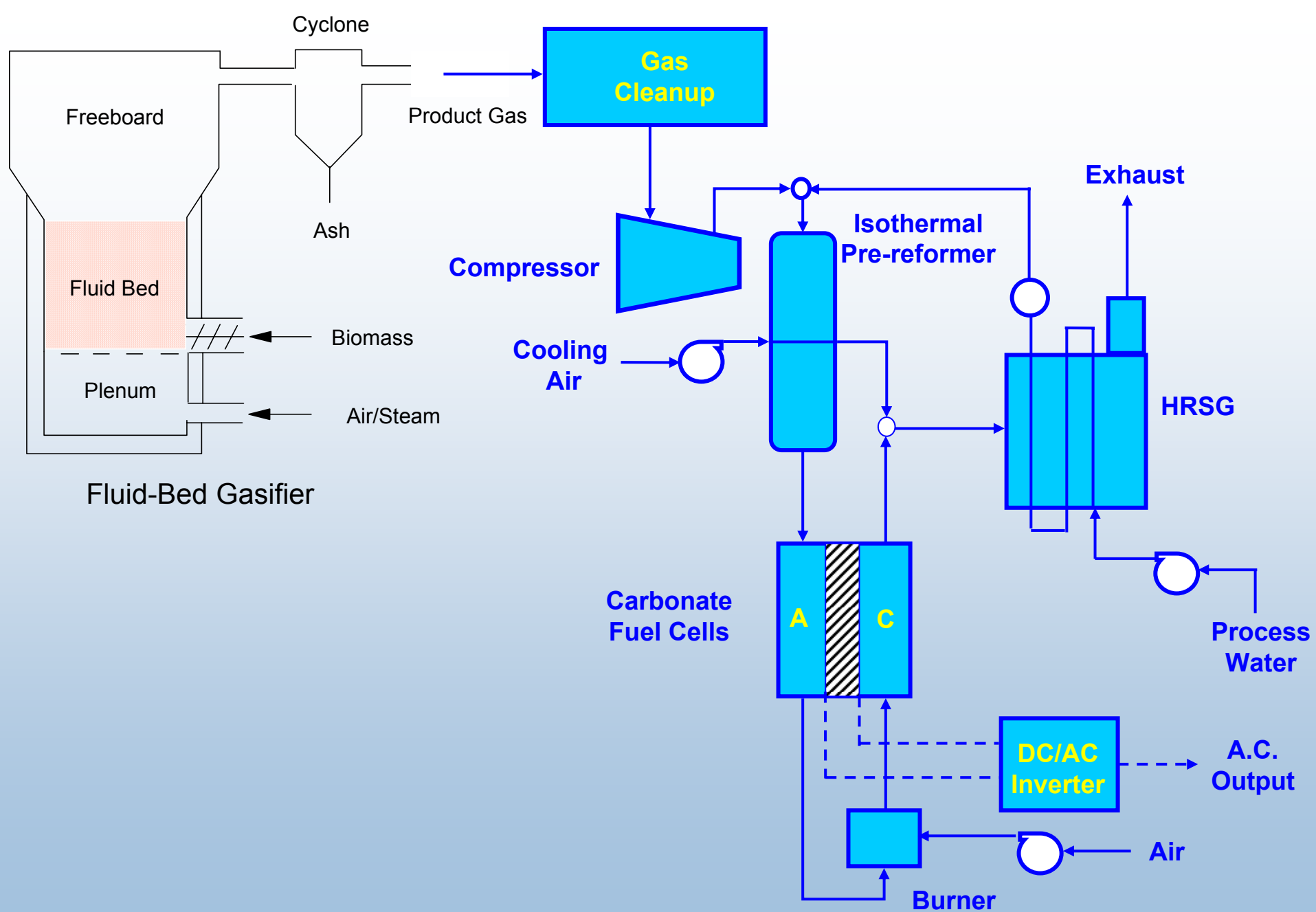



# Pyrolysis

# Pyrolysis

- **Thermal decomposition occurring in the absence of oxygen**
- **Is always the first step in combustion and gasification processes**
- **Known as a technology for producing charcoal and chemicals for thousands years**

# Mechanisms of Pyrolysis

- Many pathways and mechanisms proposed
- Broido-Shafizadeh model for cellulose shows typical complexity of pathways and possibilities for product maximization

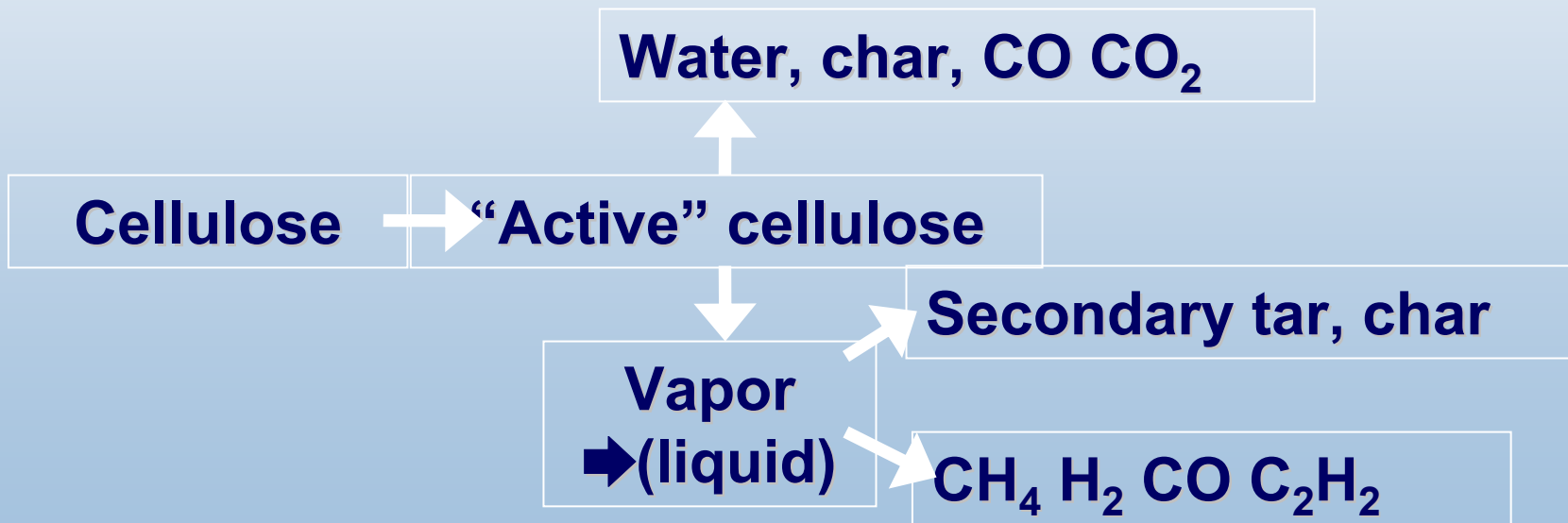

# Biomass Pyrolysis Products

	Liquid	Char	Gas
•FAST PYROLYSIS	75%	12%	13%
	•moderate temperature •short residence time		
•CARBONIZATION	30%	35%	35%
	•low temperature •long residence time		
•GASIFICATION	5%	10%	85%
	•high temperature •long residence time		

# Fast Pyrolysis of Biomass

- **Fast pyrolysis is a thermal process that rapidly heats biomass to a carefully controlled temperature (~500°C), then very quickly cools the volatile products (<2 sec) formed in the reactor**
- **Offers the unique advantage of producing a liquid that can be stored and transported**
- **Has been developed in many configurations**
- **At present is at relatively early stage of development**

# Process Requirements

Drying

**<10% moisture; feed and reaction water end up in bio-oil**

Comminution

**2mm (bubbling bed), 6 mm (CFB)**

Fast pyrolysis

**High heat rate, controlled T, short residence time**

Char separation

**Efficient char separation needed**

Liquid recovery

**By condensation and coalescence.**

# Operational Pyrolysis Units

<b>Fluid beds</b>	<b>400 kg/h at DynaMotive 20 kg/h at RTI Many research units</b>
<b>CFBs</b>	<b>1000 kg/h at Red Arrow (Ensyn) 20 kg/h at VTT (Ensyn) 350 kg/h (Fortum, Finland)</b>
<b>Rotating cone</b>	<b>200 kg/h at BTG (Netherlands)</b>
<b>Vacuum</b>	<b>3500 kg/h at Pyrovac</b>
<b>Auger</b>	<b>200 kg/h at ROI</b>



# Bubbling Fluid Bed Pyrolysis

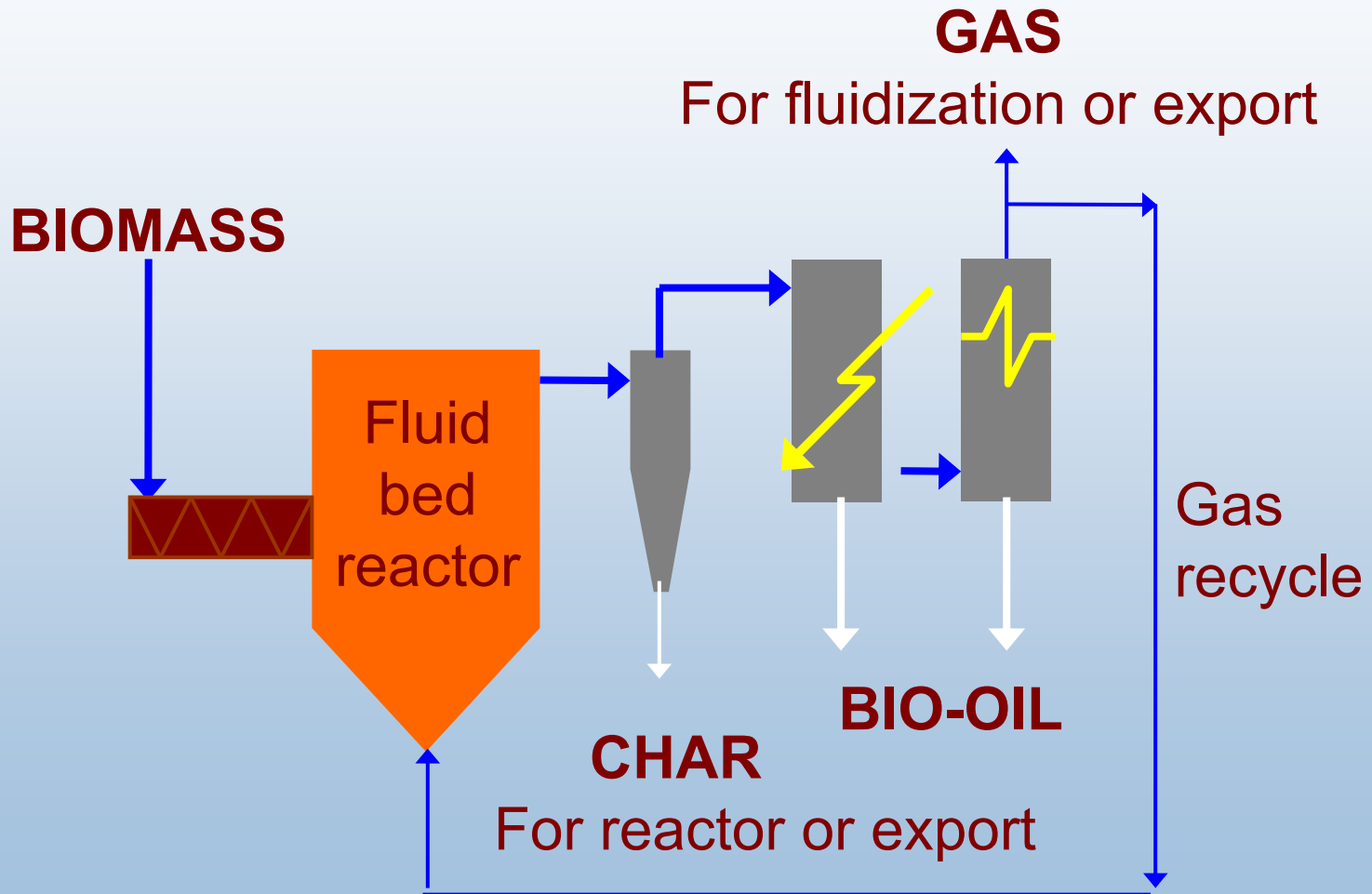

# Fluid Bed Heating Options

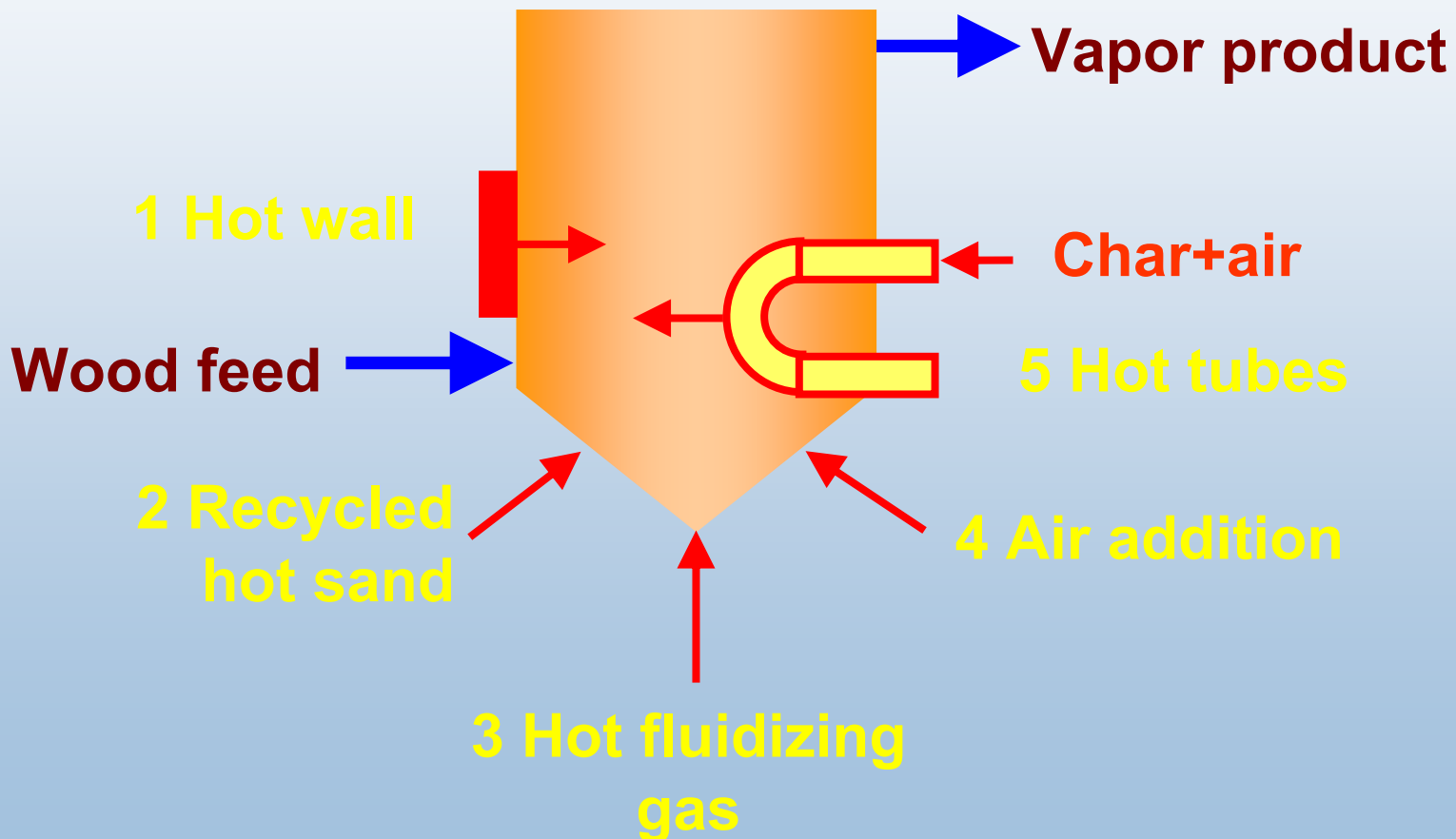

# Bubbling Fluid Bed



250 kg/h pilot plant at Wellman, UK

# Fluid Bed Reactors

- Good temperature control,
- Char removal is usually by ejection and entrainment; separation by cyclone,
- Easy scaling,
- Well understood technology since first experiments at University of Waterloo in 1980s
- Small particle sizes needed,
- Heat transfer to bed at large scale has to be proven.

# Circulating Fluid Beds

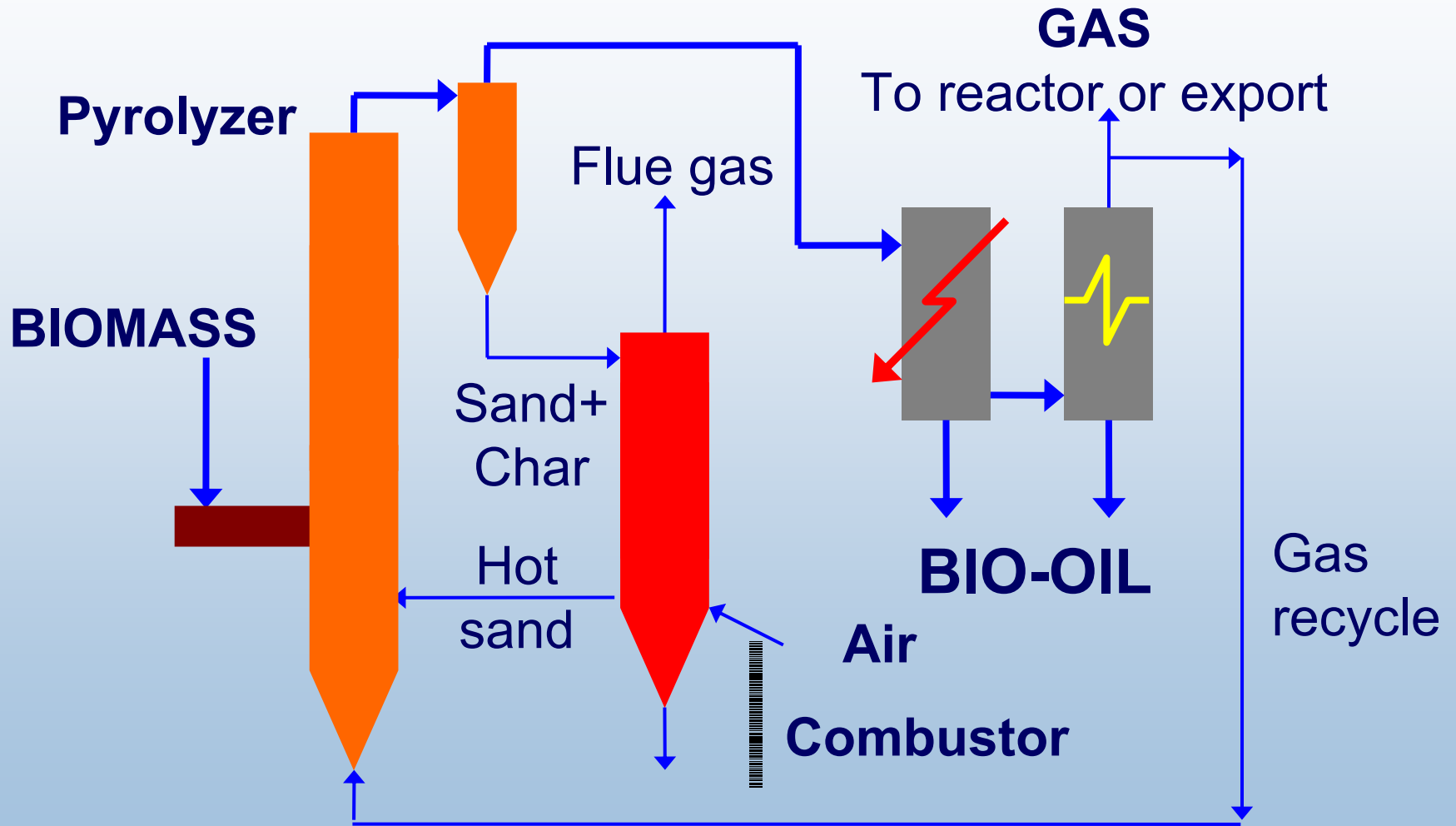

# CFB and Transported Beds

- **Good temperature control in reactor,**
- **Larger particle sizes possible,**
- **CFBs suitable for very large throughputs,**
- **Well understood technology,**
- **Hydrodynamics more complex, larger gas flows in the system,**
- **Char is finer due to more attrition at higher velocities; separation is by cyclone,**
- **Closely integrated char combustion requires careful control,**
- **Heat transfer to bed at large scale has to be proven.**

# Rotating Cone (BTG)

**Centrifugation drives hot sand and biomass up rotating heated cone;**  
**Vapors are condensed;**  
**Char is burned and hot sand is recirculated.**

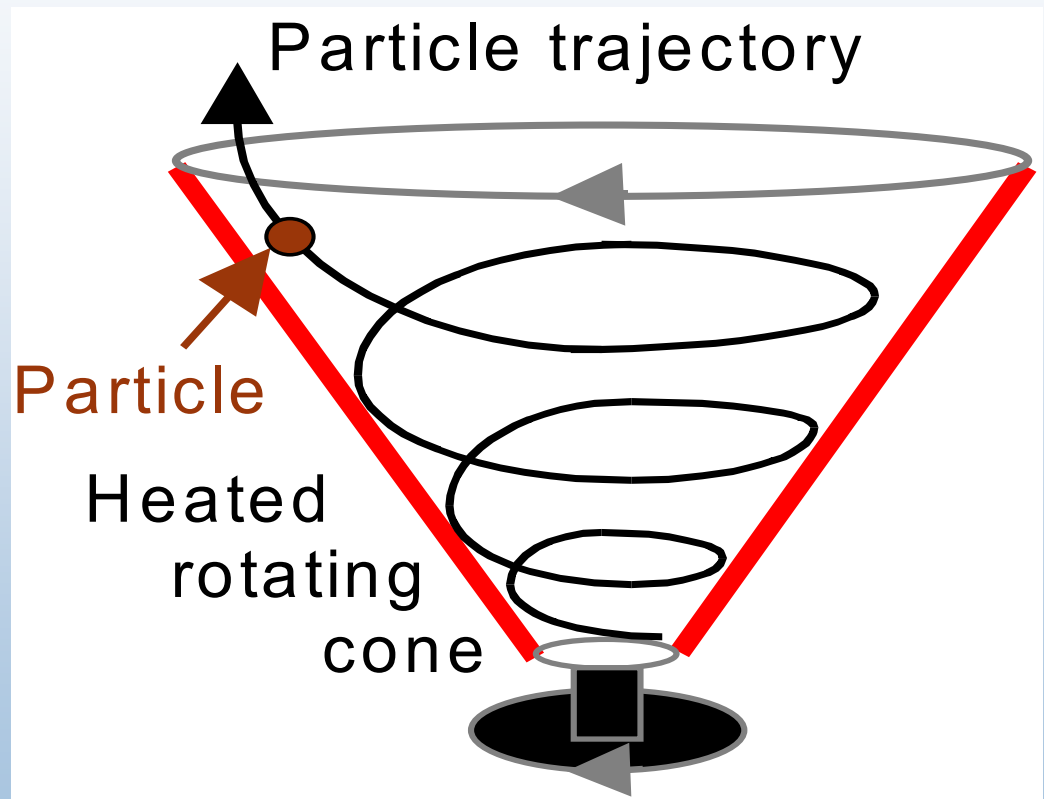

# Vacuum Moving Bed

- **Developed at Université Laval, Canada, scaled up by Pyrovac**
- **Pilot plant operating at 50 kg/h**
- **Demonstration unit at 3.5 t/h**
- **Analogous to fast pyrolysis as vapor residence time is similar.**
- **Lower bio-oil yield 35-50%**
- **Complicated mechanically (stirring wood bed to improve heat transfer)**



# Auger Reactor

- Developed for biomass pyrolysis by Sea Sweep, Inc (oil adsorbent) then ROI (bio-oil);
- 5 t/d (200 kg/h) mobile plant designed for pyrolysis of chicken litter;
- Compact, does not require carrier gas;
- Lower process temperature (400°C);
- **Lower bio-oil yields**
- **Moving parts in the hot zone**
- **Heat transfer at larger scale may be a problem**

# Char Removal

- **Char acts as a vapor cracking catalyst so rapid and effective removal is essential.**
- **Cyclones are usual method of char removal. Fines pass through and collect in liquid product.**
- **Hot vapor filtration gives high quality char free product. Char accumulation cracks vapors and reduces liquid yield (~20%). Limited experience is available.**
- **Liquid filtration is very difficult due to nature of char and pyrolytic lignin.**

# Liquid Collection

- **Primary pyrolysis products are vapors and aerosols from decomposition of cellulose, hemicellulose and lignin.**
- **Liquid collection requires cooling and agglomeration or coalescence of aerosols.**
- **Simple heat exchange can cause preferential deposition of heavier fractions leading to blockage.**
- **Quenching in product liquid or immiscible hydrocarbon followed by electrostatic precipitation is preferred method.**

# Fast Pyrolysis Bio-oil

Bio-oil is water miscible and is comprised of many oxygenated organic chemicals.

- Dark brown mobile liquid,
- Combustible,
- Not miscible with hydrocarbons,
- Heating value ~ 17 MJ/kg,
- Density ~ 1.2 kg/l,
- Acid, pH ~ 2.5,
- Pungent odour,
- “Ages” - viscosity increases with time

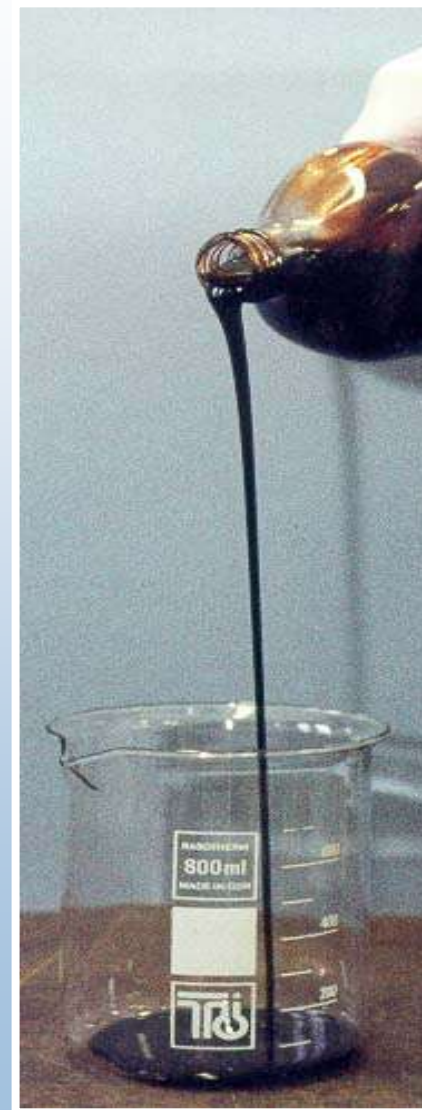

# Bio-oil Properties

The complexity and nature of the liquid results in some unusual properties.

Due to physical-chemical processes such as:

- ❖ Polymerization/condensation
- ❖ Esterification and etherification
- ❖ Agglomeration of oligomeric molecules

Properties of bio-oil change with time:

- ❖ Viscosity increases
- ❖ Volatility decreases
- ❖ Phase separation, deposits, gums

# Upgrading of Bio-oils

## Physical Methods

- Filtration for char removal,
- Emulsification with hydrocarbons,
- Solvent addition,

## Chemical Methods

- Reaction with alcohols,
- Catalytic deoxygenation:  
Hydrotreating,  
Catalytic (zeolite) vapor cracking.

# Applications of Bio-oils

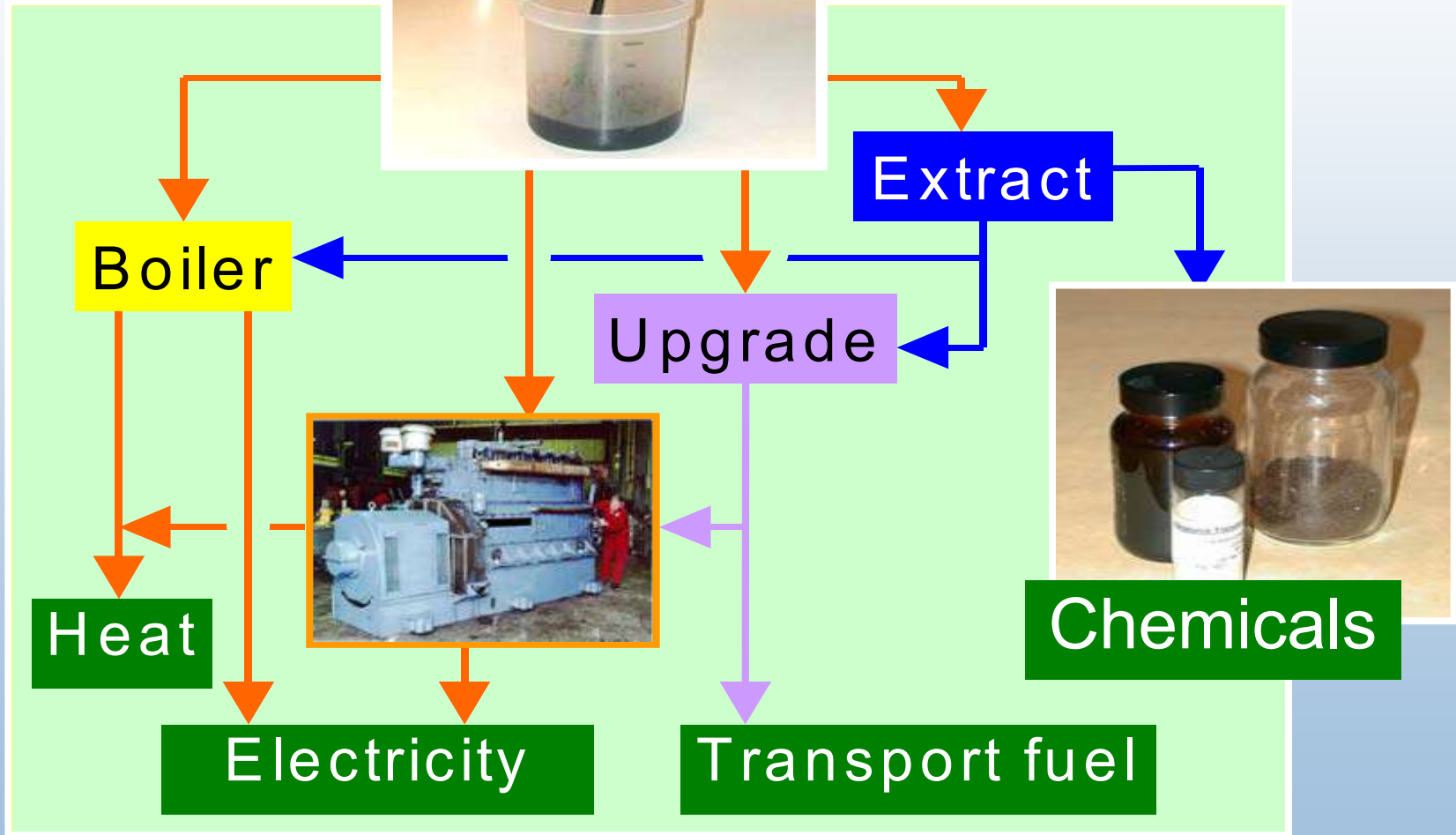

# Bio-oil Cost

## Different claims of the cost of production:

- **Ensyn**     **\$4-5/GJ (\$68-75/ton)**
- **BTG**        **\$6/GJ (\$100/ton)**

$$\text{Cost} = \text{Wood cost}/10 + 8.87 * (\text{Wood throughput})^{-0.347}$$

**\$/GJ**

**\$/dry ton**

**dry t/h**

A.V. Bridgwater, A Guide to Fast Pyrolysis of Biomass for Fuels and Chemicals, PyNe Guide 1, [www.pyne.co.uk](http://www.pyne.co.uk)



# Why Is Bio-oil Not Used More?

- ✓ **Cost : 10% – 100% more than fossil fuel,**
- ✓ **Availability: limited supplies for testing**
- ✓ **Standards; lack of standards and inconsistent quality inhibits wider usage,**
- ✓ **Incompatibility with conventional fuels,**
- ✓ **Unfamiliarity of users**
- ✓ **Dedicated fuel handling needed,**
- ✓ **Poor image.**

# Research Opportunities

# Technical Barrier Areas

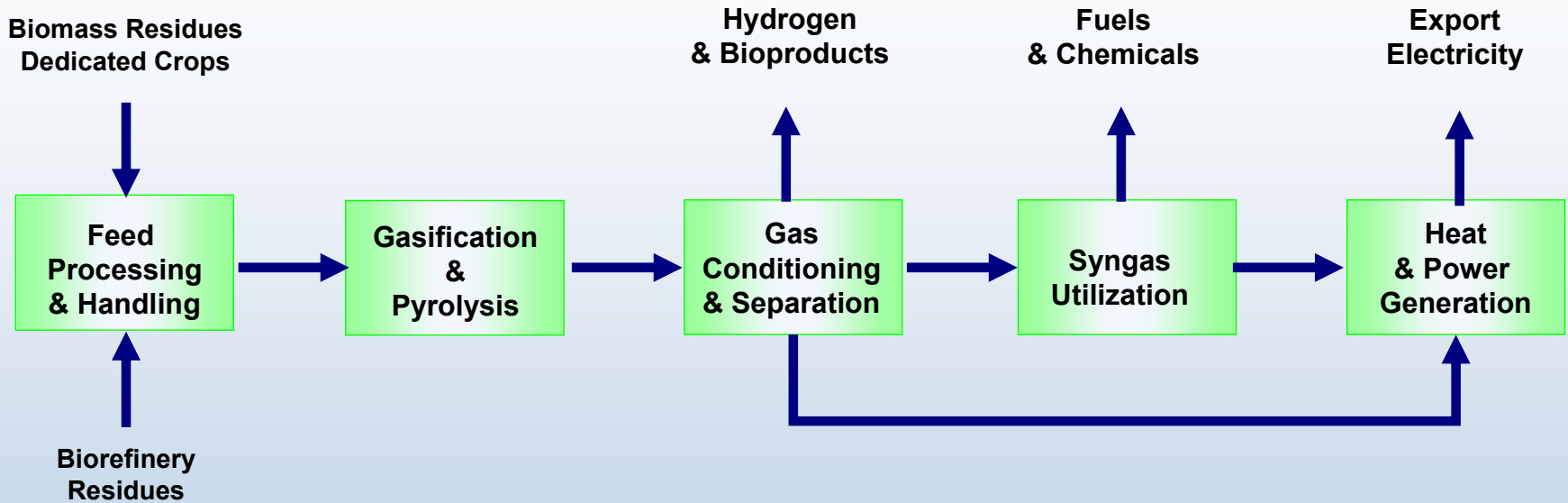

- ❖ Feed Processing and Handling
- ❖ Gasification / Conversion
- ❖ Gas Cleanup and Catalytic Conditioning
- ❖ Syngas Utilization
- ❖ Process Integration
- ❖ Process Control, Sensors, and Optimization

# Biomass Thermochemical Conversion

## Primary Technical Barriers

### Gasification

- Feed Pretreatment
  - Feeder reliability
  - Feed modification
- Gasification
  - Tar & Heteroatom chemistry
  - Gasifier Design
  - Catalysis
- Gas Cleanup & Conditioning
  - Catalytic Conversion
  - Condensing Cleanup
  - Non-condensing Cleanup
- Syngas Utilization
  - Cleanliness requirements
  - Gas composition
- Process Integration
- Sensors and Controls

### Pyrolysis

- Catalytic Pyrolysis
- Oil Handling
  - Toxicity
  - Stability
  - Storage
  - Transportation
- Oil Properties
  - Ash
  - Acidity
- Oil Commercial Properties
  - Commercial Specifications
  - Use in Petroleum Refineries

### Black Liquor Gasification

- Containment
  - Metals
  - Refractories
  - Vessel design
  - Bed behavior/agglomeration
- Mill Integration
  - Steam
  - Power
  - Causticizing
- Fuels Chemistry
  - Carbon management
  - Tars
  - Sulfur management
  - Alkali management
  - Halogen management
- Sensors and Controls

# Possible Reading

1. Bain, R. L.; Amos, W. P.; Downing, M.; Perlack, R. L. (2003). Biopower Technical Assessment: State of the Industry and the Technology. 277 pp.; NREL Report No. TP-510-33123.
2. Bridgewater, A.V. (2003). A Guide to Fast Pyrolysis of Biomass for Fuels and Chemicals, PyNe Guide 1, [www.pyne.co.uk](http://www.pyne.co.uk)
3. Brown, R. C. (2003). Biorenewable Resources: Engineering New Products From Agriculture, Iowa State Press, ISBN:0-8138-2263-7.
4. Higman, C. and M. van der Burgt (2003). Gasification, Elsevier Science (USA), ISBN 0-7506-7707-4.
5. Probst, R. F. and R. E. Hicks (1982). Synthetic Fuels, McGraw-Hill, Inc., ISBN 0-07-050908-5.
6. Van Loo, S. and J. Koppejan (eds.) (2002). Handbook of Biomass Combustion and Co-firing, Twente University Press, ISBN 9036517737.