

Review of applications of gases from biomass gasification

H. Boerrigter

R. Rauch^{*)}

^{*)} Vienna, University of Technology, Institute of Chemical Engineering

Published as Chapter 10, titled: "Syngas production and utilisation" in the *Handbook Biomass Gasification*, edited by H.A.M. Knoef and published by the Biomass Technology Group (BTG), The Netherlands in 2005

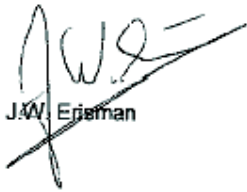
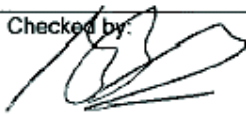
Revisions		
A		
B		
Made by:  H. Boerrigter	Approved/Issued by:  J.W. Erisman	ECN Biomass, Coal & Environmental Research
Checked by:  J. Beesteheerde		

Justification

The main body of this report was previously published as Chapter 10 (pp. 211-230), titled: “*Syngas production and utilisation*” in the *Handbook Biomass Gasification*, edited by H.A.M. Knoef and published by the Biomass Technology Group (BTG), The Netherlands in 2005.

In addition to the Handbook version, some sections have been included on gasification processes to make underlying report independently readable. Furthermore, the discussion on the utilisation of the different gases is more elaborated.

Abstract

Biomass will play an important role in the future global energy infrastructure for the generation of power and heat, but also for the production of chemicals and fuels. The dominant biomass conversion technology will be gasification, as the gases from biomass gasification are intermediates in the high-efficient power production or the synthesis from chemicals and fuels. In the discussion on the utilisation of gases from biomass gasification it is important to understand that the composition of the gasification gas is very dependent on the type of gasification process and especially the gasification temperature. In this report the two main types of gasification gas and their typical applications and specifications were discussed, *i.e.* **biosyngas** and **product gas**.

Keywords

Biomass, gasification, syngas, biosyngas, product gas, gas markets, gas cleaning, gas conditioning, synthetic natural gas (SNG), Fischer-Tropsch (FT), methanol, hydrogen, ammonia, power.

Contact

For more information, please contact:

Dr. Ir. Harold Boerrigter

Energy research Centre of the Netherlands (ECN)

ECN Biomass, Coal & Environmental research

P.O. Box 1

1755 ZG Petten

The Netherlands

Phone: +31-224-564591

Fax: +31-224-568487

Email: boerrigter@ecn.nl

Web: www.ecn.nl/biomass (*non-confidential ECN reports can be downloaded from this site*)

Contents

List of tables	5
List of figures	5
Summary	6
1 Introduction	7
1.1 Biomass	7
1.2 Energy, fuels, and products from biomass	7
1.3 Gases from biomass gasification	7
2 Gas Markets	9
2.1 Product gas	9
2.2 Biosyngas	9
3 Gasification processes	12
3.1 Product gas production	12
3.2 Biosyngas production	14
4 Utilisation of Product gas	17
4.1 Power generation	17
4.1.1 Co-firing	17
4.1.2 Combined heat and power (CHP)	17
4.1.3 Integrated gasification combined cycle (IGCC)	17
4.1.4 Fuel cells	18
4.2 Synthetic Natural Gas (SNG)	18
5 Utilisation of Biosyngas	20
5.1 Power generation	20
5.2 Transportation fuels	20
5.2.1 Tropsch synthesis	20
5.2.2 Methanol	21
5.3 Chemical synthesis	22
5.3.1 Ammonia for fertiliser production	22
5.3.2 Hydroformylation of olefins	22
5.3.3 Hydrogen in refineries	23
5.3.4 Synthetic Natural Gas (SNG)	23
5.3.5 Other applications	23
6 Gas Specifications	24
6.1 Product gas	24
6.1.1 Heat	24
6.1.2 Power	24
6.1.3 Synthetic Natural Gas (SNG)	25
6.2 Biosyngas	25
6.2.1 Impurities	25
6.2.2 Main gas compositions	26
7 Gas Treatment	27
7.1 Particulates	27
7.2 Organic impurities	27
7.3 Inorganic impurities	28
7.4 Gas conditioning	29
7.4.1 Water-gas-shift	29
7.4.2 CO ₂ removal	29
8 Concluding Remarks	30
9 References	31

List of tables

Table 1.	Typical gas compositions of three indirect gasification processes (wood as fuel)..	13
Table 2.	Typical biosyngas compositions of entrained flow (EF) gasification of woody biomass (7% moisture) compared to product gas compositions from a direct circulating fluidised bed (CFB) gasifier at 850°C and various conditions [].	14
Table 3.	Process conditions for Fischer–Tropsch synthesis.	21
Table 4.	Purification level of main biosyngas impurities [23].	26
Table 5.	Overview of main gas composition specifications for selected applications [12].	26

List of figures

Figure 1.	Difference between ‘biosyngas’ and ‘product gas’ and their typical applications....	8
Figure 2.	Present world syngas market.	9
Figure 3.	Predicted world syngas market in 2040.	10
Figure 4.	FICFB gasification process.	13
Figure 5.	Schematic representation of the entrained flow reactor of Future Energy [15].	16
Figure 6.	Schematic representation of general industrial approach towards cleaning of syngas from partial oxidation of natural gas based on commercially available technologies [32].	28

Summary

At present, syngas is mainly produced from fossil fuels, with the main applications being the production of ammonia, hydrogen for refineries, methanol, Fischer-Tropsch products, and electricity. In the view of decreasing reserves of fossil fuels and also because of the aim of the EC to reduce the dependency from imported fossil fuels, there is a growing interest in producing syngas from the renewable source biomass, *i.e.* "biosyngas". Biomass will play an important role in the future global energy infrastructure for the generation of power and heat, but mainly for the production of chemicals and fuels. The predicted 2004 world biosyngas market is approx. 10% of the total energy consumption, with main application for biomass-to-liquid processes.

The dominant biomass conversion technology will be gasification, as the gases from biomass gasification are intermediates in the high-efficient power production or the synthesis from chemicals and fuels. Oxygen-blown or indirect gasification is required to produce a gas with low inert content (*e.g.* nitrogen).

In the utilisation of gases from biomass gasification it is important to understand that depending on the gasification temperature a ***biosyngas*** (>1200°C) or a ***product gas*** (<1000°C) is generated, of which the latter can be converted into biosyngas by catalytic or thermal cracking. Slagging entrained flow gasification is the most suitable technology for high temperature gasification. Product gas is preferred for utilisation for power generation and synthetic natural gas synthesis. Biosyngas is the feedstock for the more advanced applications like Fischer-Tropsch synthesis, ammonia and hydrogen production, and in processes like olefin hydroformylation and mixed alcohol synthesis.

The removal of inorganic impurities that are catalyst poisons (*e.g.* Na, K, P, S, and Cl) is the main challenge is gas cleaning of biosyngas, however, the existing natural gas based processes offer potential solutions. The same applies for application of the gas conditioning processes (*i.e.* water-gas-shift and CO₂ removal).

1 Introduction

1.1 Biomass

Biomass is a general term to describe all organic carbon-containing material produced by photosynthesis in plants. Biomass is available in many forms, comprising products as well as residues from agriculture, forestry, and the agro-industry. Although biomass is the oldest energy source known to mankind, its current contribution to the primary energy consumption in the Western world is small. Biomass was gradually substituted after the discovery of huge amounts of cheap fossil fuels. Coal, crude oil, and natural gas were not only cheaper, but also more convenient to use. Furthermore, the 'new' fuels allowed applications that were not possible with biomass: liquid transportation fuels from crude oil and gas for cooking. Biomass appeared to have no future as energy source.

The insight that the fossil fuel reserves are limited, together with concerns over security of supply (*i.e.* the oil crises), initiated the first upraise of interest in biomass (and all other renewable energy forms) in the 1970s. However, continuously low fossil energy prices and the discovery of new fossil fuel reserves impeded the development of biomass technologies. In the 1980s the concern grew that global warming and the resulting climate change were enhanced (if not caused) by CO₂ emissions resulting from fossil fuel consumption. This concern resulted in the Kyoto protocol in which objectives to reduce the anthropogenic CO₂ emissions are documented. To achieve the Kyoto objectives, the share of renewable energy in the primary energy consumption has to increase significantly. The interest in biomass was renewed, as biomass is considered to be one of the most important renewable energy sources for this century [1,2].

1.2 Energy, fuels, and products from biomass

By definition, biomass is a renewable material, as during growth of the plants, crops, and trees, CO₂ is withdrawn from the atmosphere (the carbon source) and stored in the biomass as chemical energy. The CO₂ cycle is closed again when the CO₂ is released during conversion of the biomass and the use of derived products. The renewable and CO₂-neutral nature of biomass is the major motivation to use the material for the energy generation (*e.g.* green electricity and heat).

The same consideration applies for the use of biomass for the production of fuels and products. To date, nearly all transportation fuels and most materials and chemicals are produced from crude oil or natural gas. At a certain moment in the future, the decreasing reserves of these fossil materials will give rise to increasing prices. Therefore, an additional motivation is that to maintain the same production levels, an alternative carbon source is required and biomass is the only carbon source that is renewable. Biomass will be the future feedstock for the production of transportation fuels and chemicals.

1.3 Gases from biomass gasification

Gasification is the key conversion technology in all processes for the production of energy, fuels, and/or products from biomass. In electricity production biomass is thermally converted by gasification into a combustible gas that can be used in a gas engine or turbine with electricity as well as heat as products. The advantage of the gasification route is the higher overall electric efficiency compared to the alternative of direct biomass combustion. In the production of fuels

and chemicals the combustible gasification gas is used in a catalytic process to synthesise the desired product.

In the discussion on the utilisation of gases from biomass gasification it is important to understand that gas specifications are different for the various gas applications. Furthermore, the composition of the gasification gas is very dependent on the type of gasification process, gasification agent and the gasification temperature. Based on the general composition and the typical applications, two main types of gasification gas can be distinguished, *i.e.* ‘biosyngas’ and ‘product gas’ (Figure 1):

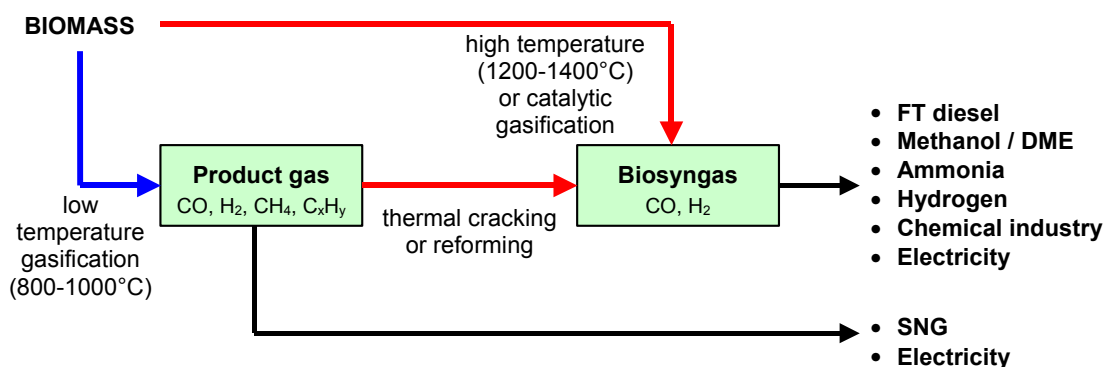

Figure 1. Difference between ‘biosyngas’ and ‘product gas’ and their typical applications.

- **Product gas**; produced by low temperature gasification (below 1000°C) and containing CO, H₂, CH₄, C_xH_y aliphatic hydrocarbons, benzene, toluene, and tars (besides CO₂ and H₂O). The syngas components H₂ and CO typically contain only ~50% of the energy in the gas, while the remainder is contained in CH₄ and higher (aromatic) hydrocarbons.
- **Biosyngas**; produced by high temperature (above 1200°C) or catalytic gasification. Under these conditions the biomass is completely converted into H₂ and CO (besides CO₂ and H₂O). Biosyngas is chemically similar to syngas derived from fossil sources and can replace its fossil equivalent in all applications. Biosyngas can also be made from product gas by heating the thermal cracking or catalytic reforming.

Both gases need additional gas cleaning and conditioning to afford a gas with the correct composition and specifications for the final application, *e.g.* synthesis. In this report the major utilisations of both types of gases will be assessed, *i.e.* product gas and biosyngas. However, the focus will be on biosyngas applications, as biosyngas utilisation is expected to be dominant on the long term. Whereas for electricity production other renewable options exist (*i.e.* solar PV and wind turbines), biomass is the only renewable carbon-source.

2 Gas Markets

2.1 Product gas

The major application of product gas will be the direct use for the generation of power (and heat). This can be either in stand-alone combined heat and power (CHP) plants or by co-firing of the product gas in large-scale power plants. The installed power production capacity in the EU-25 countries is approx. 700 GWe (2004) [3], which is expected to increase to 1040 GWe in 2020 (based on an assumed growth rate of the power consumption of 2% per year). A target can be set to implement 10% of the growth of power production in the period between 2000 and 2020 with biomass-gasification plants, i.e. 34 GWe or 1,000 PJ. The second major application of product gas is the production of synthetic natural gas (SNG). The volume of the European market for SNG is more difficult to predict.

2.2 Biosyngas

Syngas is a versatile building block in chemical industry [4,5]. The total global annual use of fossil-derived syngas is approximately 6,000 PJ_{th}, which corresponds to 2% of the total primary energy consumption. The largest part of the syngas is used for the synthesis of ammonia for fertiliser production (~55%), the second largest share is the amount of hydrogen from syngas consumed in oil refining processes (~24%), and smaller amounts are used for methanol production (12%). Figure 2 shows the present syngas market distribution [6]. Today's, global use of syngas for the production of transportation fuels in the so-called "gas-to-liquids" processes (GTL) correspond to approx. 500 PJ per year, i.e. from the Fischer-Tropsch processes of Sasol in South Africa and of Shell in Bintulu, Malaysia.

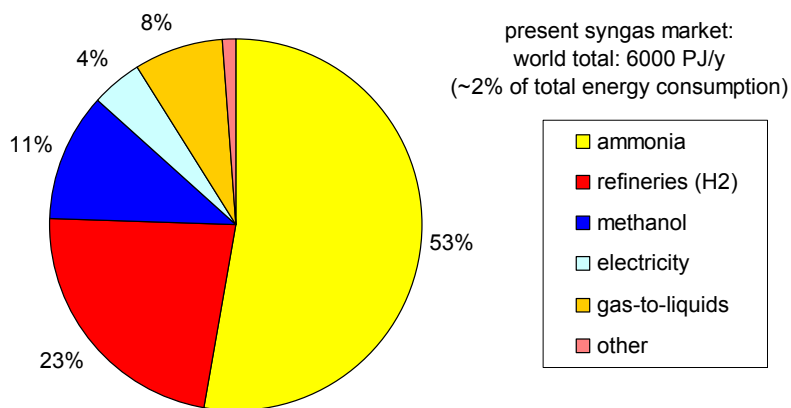

Figure 2. Present world syngas market.

In the future, syngas will become increasingly important for the production of cleaner fuels to comply with the stringent emission standards, e.g. methanol/DME, ethanol, and/or Fischer-Tropsch diesel. Also the future bio-fuels will be ultra-clean designer fuels from GTL processes; transportation fuels directly produced from biomass (e.g. biodiesel, pyrolysis oils are expected to have only very limited application, as was the conclusion from the Wolfsburg (Germany) Congress on Synthetic Biofuels - Technologies, Potentials, Prospects that was held from 3-4 November 2004.

The huge potential market for syngas is illustrated by the fact that approximately 30% of the world primary energy consumption is for the transportation fuels and chemicals [7]. With biomass being the only sustainable carbon-containing source, it is expected that biosyngas will be the key-intermediate in the future production of renewable fuels and chemicals. When an average of 30% substitution of fossil fuels by biosyngas is assumed, based on extrapolation of current EU Directives, and this is translated to the world energy consumption, the total annual syngas market will be increased to approx. 50,000 PJ in 2040. The world (bio) syngas market will then look as shown in Figure 3 (assuming no changes for the other applications). The major share of the syngas will be used for production of fuels (biomass-to-liquids; BTL) and another major part for the production of renewable chemicals (biomass-to-chemicals) [6].

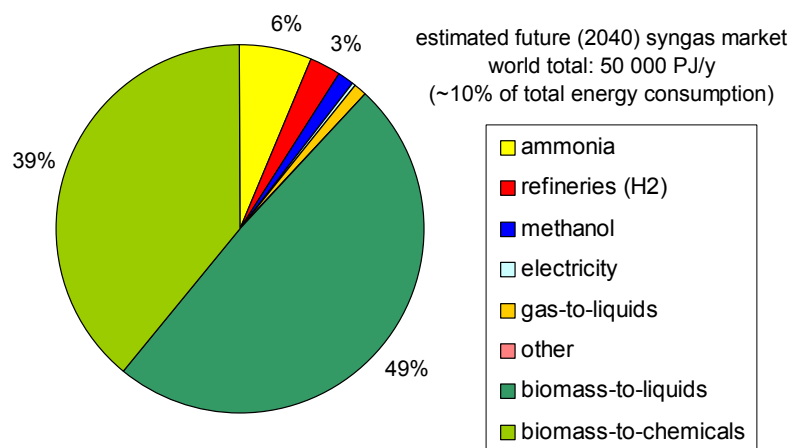

Figure 3. Predicted world syngas market in 2040.

The future biosyngas demand exceeds the present syngas consumption by a factor of eight. Therefore, it is clear that large biosyngas production capacities are needed to meet the European and national renewable energy and CO₂-emission reduction targets. Not only are large installed capacities necessary, also the individual plants, compared to typical biomass plants, have to be large considering the typical plant scales for the two main applications, *i.e.*:

- Transportation fuels in BTL plants: few 100 MW to several 1,000 MW;
- Chemical sector: 50-200 MW.

Syngas demands for liquid fuel synthesis will typically be >1,000 MW for plants, where the whole chain from biomass to the final product is realised (to benefit from economy of scale, which is necessary to reduce costs). For illustration, the Shell GTL plant in Malaysia of 12,500 bbpd (*i.e.* ~1,000 MW) is considered as a demonstration plant, while the new plant in Qatar will have a six times higher capacity (75,000 bbpd or ~6,000 MW). Another possibility is, that there are several smaller plants in the size of ~500 MW, which produce only intermediate products, *e.g.* raw liquid products, where the final work-up is done in a central facility.

The typical syngas demands for chemical processes correspond to 50-200 MW_{th}. Even though the scale of an individual biosyngas plant may be relatively small, in most cases the plant will be part of a larger centralised chemical infrastructure with several other processes and plants to optimise energy and product integration (*i.e.* the syngas consumer). There is only a limited market for stand-alone small-scale biosyngas production for distributed chemical plants (although there will always be exceptions).

To ensure cost-effective biomass supply (*i.e.* avoid land transport) biosyngas production plants will be constructed close to ports or larger waterways. For the selection of the location the same

considerations apply as for current coal-fired power plants and their coal logistics. Also the main large concentrations of chemical industry are located on locations easy accessible from water, *e.g.* the Dutch Maasvlakte near Rotterdam and the German Ruhrgebiet.

3 Gasification processes

Gasification is the complete thermal breakdown of biomass into a combustible gas, volatiles, char, and ash in an enclosed reactor or gasifier. Gasification is a two-step, endothermic (*i.e.* heat absorbing) process. In the first reaction, pyrolysis, the volatile components of the fuel are vaporized at temperatures below 600°C by a set of complex reactions. Included in the volatile vapours are hydrocarbon gases, hydrogen, carbon monoxide, carbon dioxide, tar, and water vapour. As biomass fuels tend to have more volatile components (70-86% on a dry basis) than coal (30%), pyrolysis plays a larger role in biomass gasification than in coal gasification. Char (fixed carbon) and ash are the pyrolysis by-products, which are not vaporized. In the second step, the char is gasified through reactions with oxygen, steam, carbon monoxide and hydrogen. The heat needed for the endothermic gasification reactions is generated by combustion of part of the fuel, char, or gases, depending on the reactor technology.

Depending on the temperature of the second and actual gasification step, the process yields a biosyngas or a product gas (*cf.* Figure 1). The choice for air or oxygen as gasification medium determines whether the product gas or biosyngas contains nitrogen. There is a large number of gasification processes in development. Within the scope of this report some main types are briefly discussed with the focus on the gas generation.

3.1 Product gas production

Product gas is generated by low-temperature (<1000°C) gasification. Gasification processes can be differentiated in direct (autothermal) and indirect (or allothermal) processes. For biomass applications the direct processes are typically operated with air as gasification medium. The main direct and indirect processes are:

- Fixed-bed updraft;
- Fixed-bed downdraft;
- Fluidised bed (bubbling and circulating, *i.e.* BFB and CFB); and
- Indirect fluidised bed (steam-blown).

In most biomass applications the gasifiers are operated with air as gasification medium affording a product gas diluted with nitrogen. For the more advanced applications, a nitrogen-free product gas is required (*cf.* Chapter 6). A nitrogen-free product gas can be produced by oxygen-blown gasification or alternative by indirect processes. The indirect gasification process is very attractive for N₂-free product gas generation as no oxygen is required for the gasification. Furthermore, the conversion is generally complete, whereas, direct gasification processes afford carbon-containing ashes due to incomplete conversion (*i.e.* typically 90-95%). Indirect processes can be divided into two groups:

- Transport of heat by inert material
- Transport of heat by heat exchangers

Examples of indirect gasification processes, where the heat is transported by inert material, are the Fast Internal Circulation Fluidised Bed (FICFB) process developed by the Vienna University of Technology (TUW) [8], the SilvaGas process based on the Batelle development [9], and the MILENA gasifier developed at the Energy research Centre of the Netherlands (ECN) [10]. Typical gas compositions for these three processes are summarised in Table 1

Table 1. Typical gas compositions of three indirect gasification processes (wood as fuel).

Gas component, dry basis		FICFB (Güssing)	SilvaGas	MILENA (ECN)
Hydrogen	vol%	30-45	20-22	15-20
Carbon monoxide	vol%	20-30	41-44	40-43
Carbon dioxide	vol%	15-25	11-14	10-12
Methane	vol%	8-12	12-16	15-17
C ₂ + hydrocarbons	vol%	1-3	4-6	5-6
Benzene	vol%		1	1
Nitrogen	vol%	1-3	2-10	1-4
Ammonia	ppmV	500-1000		500-1000
H ₂ S	ppmV	50-120		40-100
Tar	g/m _n ³	0.5-1.5	40	40
Particles	g/m _n ³	10-20		~

The principle of an indirect gasifier is discussed from the FICFB concept (Figure 4). The reactor consists of two zones, a gasification zone and a combustion zone. Inert, heat carrying bed material is circulated between these two zones to transfer heat from the combustion zone to the gasification zone, while separating the flue gases in the combustion zone from the product gas produced in the gasification zone. Biomass is fed into the gasification zone and gasified with steam at 850-900°C and the thermal energy provided by the circulating solids. As a result the gas produced in this zone is nearly free of nitrogen. The bed material, together with the char left over from steam gasification, is circulated to the combustion zone. This zone is fluidised with air to burn the char and any carryover product gas.

Following the initial development of the FICFB Process in a laboratory test unit at Technical University of Vienna (TUV), a demonstration plant was erected. This plant is an 8MWth feed capacity plant situated in Güssing (Austria) with an electric output of 2 MW. The plant went into operation in autumn 2001.

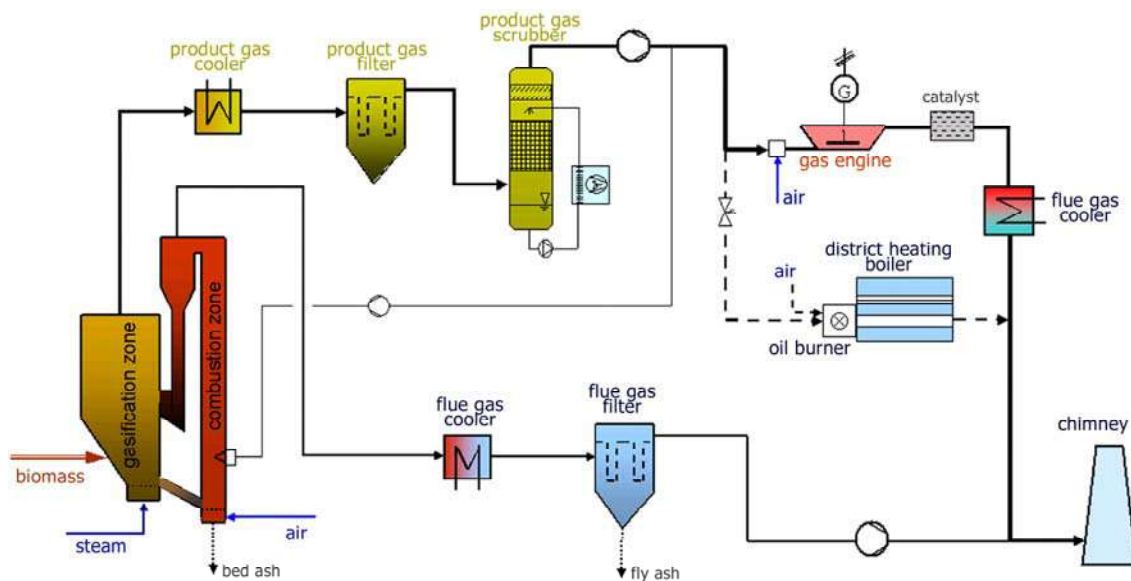

Figure 4. FICFB gasification process.

3.2 Biosyngas production

Biosyngas is produced by high-temperature (>1200°C) gasification. In principal, the (oxygen-blown) downdraft and the entrained flow gasification processes are suitable for this. However, downdraft fixed-bed gasifiers are limited in scale and require a well-defined fuel, making them not fuel-flexible. Therefore, the preferred process to produce biosyngas is entrained flow gasification [11]. There are two different types of EF:

- Slagging, for ash containing feedstock (*e.g.* biomass);
- Non-slagging, for essentially ash-free feedstock.

Entrained flow (EF) gasifiers typically operate at high temperatures (1200-1500°C) at which the feed is completely converted into syngas, even at the short residence time of only a few seconds. In a slagging gasifier, the ash forming components melt in the gasifier. The molten particles condense on the relatively cold walls and ultimately form a layer being solid close to the wall and liquid on the inner side. This slag layer serves as a protective layer for the wall. The liquid slag is removed from the bottom of the gasifier. In order to generate a liquid slag with the right viscosity at the given temperature, generally so-called fluxing material must be added. For coal-fired plants, this often is limestone or another Ca-rich material. Slagging entrained flow gasifier manufacturers are Shell, Texaco, Krupp-Uhde, Future-Energy (formerly: Noell and Babcock Borsig Power), E-gas (formerly Destec and Dow), MHI (Mitsubishi Heavy Industries), Hitachi and Choren (formerly UET).

In Table 2 typical biosyngas compositions are shown that are produced by slagging EF gasification. For comparison, also product gas compositions are included from the most common type direct gasifier (*i.e.* the circulating fluidised bed gasifier). The effect of the higher gasification temperatures on the yield of the syngas components hydrogen and carbon monoxide is evident.

Table 2. Typical biosyngas compositions of entrained flow (EF) gasification of woody biomass (7% moisture) compared to product gas compositions from a direct circulating fluidised bed (CFB) gasifier at 850°C and various conditions [12].

Gasification process:		CFB	CFB	CFB	EF	EF
Pressure [bar]:		1	1	20	1	20
Gasification medium:		air	O ₂ /steam	O ₂ /steam	oxygen	oxygen
Hydrogen	vol%	14	32	19	33	27
Carbon monoxide	vol%	21	27	20	53	53
Carbon dioxide	vol%	14	29	40 ^a	13	19 ^a
Methane	vol%	5	8	15	0	0
C ₂ + hydrocarbons	vol%	2	3	5	0	0
Benzene (<i>i.e.</i> C ₆ H ₆)	vol%	0.4	1	1	0	0
Nitrogen	vol%	44	0	0	0	0
Tar (wet gas)	g/m _n ³	8	8	11	0	0
H ₂ O	vol% _{wet}	11	28	30	19	22
LHV (dry gas)	MJ/m _n ³	7.7	12.4	14.9	10.3	9.6

a. In pressurised gasification carbon dioxide is used for inertisation of the feed to prevent nitrogen dilution of the gas.

In most cases, EF gasifiers are operated under pressure (typically 20-50 bar) and with pure oxygen and with capacities in the order of several hundreds of MW_{th}. Biosyngas production based on slagging entrained flow gasification has the following technical advantages [11]:

- **Large-scale high-efficiency biosyngas production.** Several commercial EF gasifiers exist and have proven availability at large-scale (700 MW_{th}). EF gasifiers are operated at sufficient high temperatures (1200-1500°C) to ensure complete conversion of the biomass is completely (>99.5% carbon conversion) and has a high biomass-to-biosyngas efficiency.
- **Fuel-flexibility.** The slagging entrained-flow gasifier can convert all type biomass materials and the fuel-flexibility is extended as well to the fossil fuels coal and oil residues. EF is suitable for wood, alkaline rich biomass like straw and grasses, high ash streams like sludges and manure, wastes like RDF and plastics, as well as the back-up option to use coal.
- **Simple gas cleaning.** Due to the high temperature in the gasifier, the biosyngas is absolutely free of organic impurities (*i.e.* tars) and can easily be cleaned from small traces of inorganic impurities with conventional proven technologies.
- **Minimum waste & mineral recycling.** The minerals from the biomass are recovered in the slag and the fly ash. The slag can be used as construction material; this in contrast to other (low temperature gasification) processes that yield a carbon-containing ash that has to be disposed of as chemical waste. The carbon-free fly ash can be used for mineral recycling and fertilisation of biomass production areas.

One example of a large-scale entrained flow gasifier is the 600 MW_{th} coal-fired Shell gasifier in Buggenum, the Netherlands [13]. It is owned by the utility company NUON and produces electricity with a net efficiency of 43%. Tests have been performed with different kinds of biomass like wood, sewage sludge and chicken manure up to approximately 10% on energy basis (corresponding to 18% on weight basis). It is planned to co-fire 25% biomass on energy basis in 2005 [14]. Shell has signed several contracts to make similar coal gasifiers for fertilizer industries in China. Another example is a 130 MW_{th} gasifier (25 bar) made by Future Energy, operating on waste oil and sludges on the premises of the Schwarze Pumpe in Germany [15]. As example, Figure 5 shows the Future Energy gasifier.

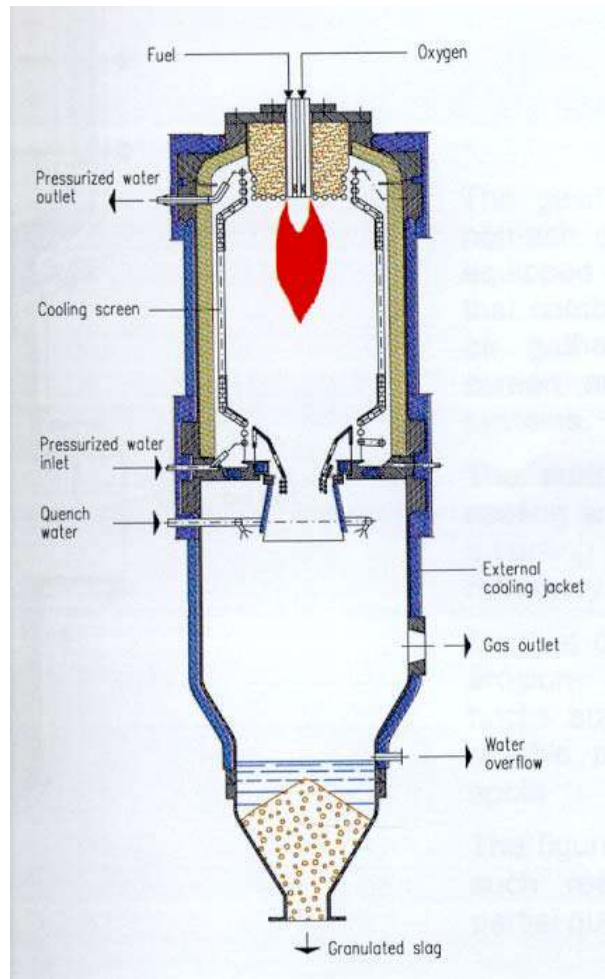

Figure 5. Schematic representation of the entrained flow reactor of Future Energy [15].

4 Utilisation of Product gas

The main application at presence of product gas from gasification is found in direct or indirect combustion to generate power with co-production of heat. Due to the typical complex composition of product gases (*cf.* Table 1), more advanced applications are not first choice, as the syngas components H₂ and CO represent only approx. 50% of the energetic value of a product gas. The only exception is the production of synthetic natural gas (SNG), as in that case the presence of (as much as possible) CH₄ is beneficial to achieve high overall yields (see Section 4.2). Therefore, in the context of SNG production, product gas is sometimes referred to as “methane-rich synthesis gas”.

4.1 Power generation

4.1.1 Co-firing

The most straightforward application of product gas is co-firing in existing coal power plants by injecting the product gas in the combustion zone of the coal boiler. Co-firing percentages up to 10% (on energy basis) are feasible without the need for substantial modifications of the coal boiler. Critical issue in co-firing is the impact of the biomass ash on the quality of the boiler fly and bottom ash. The application of the fly and bottom ash in construction and cement production often sets the specifications for the amount and type of biomass that can be co-fired. Examples of biomass co-firing plants are the AMER 85 MW_{th} circulating fluidised bed (CFB) gasifier in the Essent power plant in Geertruidenberg (the Netherlands) and the Foster Wheeler CFB gasifiers in Lahti (Finland) and Ruien (Electrabel power plant, Belgium).

4.1.2 Combined heat and power (CHP)

In combined heat and power (CHP) plants the product gas is fired on a gas engine. Modified gas engines can run without problems on most product gases even those from air-blown gasification that have calorific values of approx. 5-6 MJ/m_n³. Typically, the energetic output is one-third electricity and two-third heat. The main technical challenge in the implementation of integrated biomass gasification CHP plants has been, and still is, the removal of “tar” from the product gas. Regarding the presence of tar in product gas, it may be stated that “tar” is equivalent to a major economic penalty in biomass gasification. Tar aerosols and deposits lead to more frequent maintenance and repair of especially gas cleaning equipment and resultantly lower plant capacity factors. This leads to a decrease of revenues or to higher investments, as some equipment will be installed in duplicate to overcome standstills. Furthermore, removal of tar components from the process wastewater requires considerable investments that can even be dramatic as some tar components show poisoning behaviour in biologic wastewater treatment systems (*e.g.* phenol) [16]. The few technological successful biomass gasification plants, *e.g.* the plants in Güssing (Austria; see also Section 3.1 and Figure 4) [17] and Harboøre (Denmark) [18], have in common that they result from long development trajectories and that the technologies are neither simple nor cheap.

4.1.3 Integrated gasification combined cycle (IGCC)

In practice, the scale of integrated biomass gasification CHP plants will be limited by the local heat demand (*i.e.* up to approx. 20 MW_{th}). For electricity production on larger scales, integrated gasification combined cycles (IGCC) are preferred in which the gas is fired on a gas turbine. As a gas turbine requires a pressurised feed gas the biomass gasification should be carried out at the

pressure of the turbine (typically 5-20 bar) or the atmospherically generated product gas must be pressurised. The first route is preferred as in that case only dedusting of the gas and cooling to the turbine inlet temperature (400-500°C) is required, whereas in the alternative route the product gas must be completely cleaned and cooled down to allow compression. The first route has been demonstrated in the Värnamo (Sweden) plant, *i.e.* an 8 MW_{th} pressurised air-blown circulating fluidised bed biomass gasifier [19]. However, in general the operational costs related to the inert gas consumption and electricity consumption for pressurisation of the inert gas for solids feeding and the gasification air are a major drawback for pressurised gasification.

4.1.4 Fuel cells

The application of product gas in fuel cells for the production of electricity is still in its early development. In theory, fuel cells have the potential to achieve higher electrical efficiencies compared to simple combustion systems and gas engines [20]. However, in practice this is only relevant on small-scale where combustion/steam-cycles suffer from relatively high losses. A combination that is often mentioned for its extremely high electric efficiency, is the fuel cell downstream a gasifier functioning as the combustion chamber for a (micro) gas turbine. This implies that the fuel cell must operate under pressure. In a simpler system, the fuel cell can be connected to a gasifier to both have a high electric efficiency and a high overall efficiency in a CHP (combined heat and power) system.

A fuel cell burns H₂ and produces electricity directly through electrochemical reactions. Depending on the type of fuel cell, also CO, CH₄ and other fuels can be converted. An SOFC can handle all these molecules and therefore is generally considered a good match with product gases from low temperature biomass gasification. Furthermore, methane (and other hydrocarbons) in *product gas* can increase the performance of an SOFC because it is reformed into H₂ in the anode of the fuel cell. Since reforming is an endothermic reaction, it provides effective cooling of the fuel cell, which should otherwise be done in a way that generally increases complexity and costs and decreases overall efficiency.

4.2 Synthetic Natural Gas (SNG)

Whereas high-temperature gasification processes yield *biosyngases* with high concentrations of carbon monoxide and little methane, interest in Synthetic Natural Gas (SNG) production is concentrated on gasification processes that yield *product gases* with high methane contents. SNG is a gas with similar properties as natural gas but produced by methanation of H₂ and CO in gasification product gas. Methanation is the catalytic reaction of carbon monoxide and/or carbon dioxide with hydrogen, forming methane and water:



Consecutive and side reactions (shift conversion, Boudouard equilibrium, hydrogenation of carbon) make the calculation of equilibrium conditions very complex. The methanation reactions of both carbon monoxide and carbon dioxide are highly exothermic. Such high heat releases strongly affect the process design of the methanation plant since it is necessary to prevent excessively high temperatures in order to avoid catalyst deactivation and carbon deposition. The highly exothermic reaction generally creates a problem for the design of methane synthesis plants: either the temperature increase must be limited by recycling of reacted gas or steam dilution, or special techniques such as isothermal reactors or fluidised beds, each with indirect cooling by evaporating water, must be used.

The methanation process is a very well known and technically important as a catalytic purification step for the removal of trace carbon monoxide (typically below a few vol%) from process gases, especially for hydrogen production. Methanation of gases with a high CO

content, like gasification product gas is not well established and there are no commercial catalysts available (*i.e.* the Dakota coal-to-SNG plant uses a non-commercial catalyst).

For the removal of carbon monoxide from synthesis gases, catalysts with usually <15 wt% nickel are used predominantly. For SNG production, catalysts with high nickel content are preferred, similar to those used in reforming naphtha to a methane-rich gas. Catalysts based on ruthenium have been tried repeatedly for methanation but have not found the broad application of nickel-based catalysts. Catalytic activity is affected seriously even by very low concentrations of catalyst poisons in gases to be reformed. Such catalyst poisons are sulphur, arsenic, copper, vanadium, lead, and chlorine or halogens in general. Precaution must be taken with nickel-containing catalysts to prevent formation of highly poisonous nickel carbonyl $[\text{Ni}(\text{CO})_4]$. In practical operation of methanation plants, temperatures below 200°C at the nickel catalyst must be avoided.

5 Utilisation of Biosyngas

5.1 Power generation

Biosyngas is a combustible gas and can be used for the production of electricity in all prime movers from steam cycles, to gas engines, turbines (combined cycle), as well as fuel cells. Based on energetic considerations, however, this is not an attractive utilisation of the syngas. It is more sensible to use *product gas* instead of *biosyngas* for power production. This originates in the lower net energetic efficiency of biosyngas compared to product gas production due to the higher gasification temperature and electricity consumption for oxygen production. Therefore, a general statement can be made that for gas utilisations, in which both biosyngas and product gas can be applied the latter is preferred.

A motivation, however, to operate a gas turbine with a combined cycle on biosyngas would be the possibility to use large-scale technologies that are available from coal gasification. In this way it is possible to reach relatively large-scale implementation of biomass-based electricity production without the requirement to go through the complete development of the existing small-scale biomass gasification technologies. For example, in the Buggenum (the Netherlands) 253 MW_e coal-fired entrained flow IGCC already today up to 18 wt% biomass is co-fired. The basic technology is also suitable for dedicated biomass firing. By converting a coal plant into a biomass plant on relatively short term a large green electricity production capacity can be realised. Considering the ambitious green energy targets of the EU and national governments, the possibility for short term implementation may be more important today than smaller production capacities but with higher energetic efficiencies [21].

5.2 Transportation fuels

In the future, biosyngas will become increasingly important for the production of ultra-clean designer fuels from GTL processes, with the main examples being Fischer-Tropsch diesel and methanol/DME.

5.2.1 Fischer-Tropsch synthesis

In the non-selective catalytic Fischer-Tropsch (FT) synthesis one mole of CO reacts with two moles of H₂ to form mainly paraffin straight-chain hydrocarbons (C_xH_{2x}) with minor amounts of branched and unsaturated hydrocarbons (*i.e.* 2-methyl paraffins and α -olefins), and primary alcohols. Undesirable side reactions include methanation, the Boudouard reaction, coke deposition, oxidation of the catalyst, or carbide formation. Typical operation conditions for FT synthesis are temperatures of 200-350°C and pressures between 25 and 60 bar [22]. In the exothermic FT reaction about 20% of the chemical energy is released as heat:

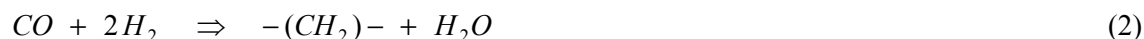

Fischer-Tropsch processes can be used to produce either a light synthetic crude oil (syncrude) and light olefins or heavy waxy hydrocarbons. The syncrude can be refined to a high quality sulphur and aromatic liquid product and specialty waxes or, if hydrocracked and/or isomerised, to produce excellent diesel fuel, lube oils, and naphtha, which is an ideal feedstock for cracking to olefins. For direct production of gasoline and light olefins, the FT process is operated at high temperature (330–350°C), for production of waxes and/or diesel fuel, at low temperatures (220–250°C), *cf.* Table 3.

Table 3. Process conditions for Fischer–Tropsch synthesis.

Parameter	Low-temperature FT	High-temperature FT
Products	Waxes and/or diesel fuels	Gasoline, light olefins
Temperature [°C]	220 - 250	330 - 350
Pressure [bar]	25 - 60	25
CO + H ₂ conversion [%]	60 - 93	85

Several types of catalysts can be used for the Fischer-Tropsch synthesis - the most important are based on iron (Fe) or cobalt (Co). Cobalt catalysts have the advantage of a higher conversion rate and a longer life (over five years). The Co catalysts are in general more reactive for hydrogenation and produce therefore less unsaturated hydrocarbons (olefins) and alcohols compared to iron catalysts. Iron catalysts have a higher tolerance for sulphur, are cheaper, and produce more olefin products and alcohols. The lifetime of the Fe catalysts is short and in commercial installations generally limited to eight weeks [23].

Catalysts for Fischer-Tropsch synthesis can be damaged with impurities as NH₃, HCN, H₂S, and COS. These impurities poison the catalysts. HCl causes corrosion of catalysts. Alkaline metals are deposited on the catalyst. Tars are deposited, cause poisoning of catalyst and contaminate the products. And particles (dust, soot, ash) cause fouling of the reactor. The removal limit is based on an economic optimum determined by catalyst stand-time and investment in gas cleaning. But generally, all these impurities should be removed to a concentration below 1 ppmV [24].

5.2.2 Methanol

Methanol can be produced by means of the catalytic reaction of carbon monoxide and some carbon dioxide with hydrogen. The presence of a certain amount of carbon dioxide in the percentage range is necessary to optimise the reaction. Both reactions are exothermic and proceed with volume contraction; a low temperature and high pressure consequently favours them [25]:



Side reactions, also strongly exothermic, can lead to formation of by-products such as methane, higher alcohols, or dimethyl ether (DME). The oldest process for the industrial production of methanol is the dry distillation of wood. Methanol is currently produced on an industrial scale exclusively by catalytic conversion of synthesis gas. Processes are classified according to the pressure used:

1. High-pressure process: 250-300 bar;
2. Medium-pressure process: 100-250 bar;
3. Low-pressure process: 50–100 bar.

Both high- and low-pressure processes are available to hydrogenate carbon monoxide. The high-pressure method was commercialised by BASF. These processes used zinc-chromium oxide catalysts at or above 340°C and required a pressure of 300-500 bar to obtain methanol concentrations of about 5-6 vol% in the effluent gases from the reactor, together with significant amounts of methane, dimethyl ether (DME), ethanol, and higher alcohols. In 1966 ICI introduced a low-pressure methanol synthesis that used a copper-zinc-chromium catalyst at 50 bar. The low-pressure processes differ primarily in operating pressure, catalyst, and reactor design, especially with respect to heat recovery and temperature control. The low-pressure processes are dominant currently and their main advantages are lower investment and

production costs, improved operational reliability, and greater flexibility in the choice of plant size [25].

5.3 Chemical synthesis

5.3.1 Ammonia for fertiliser production

The major share (*i.e.* 85%) of the ammonia is used for the production of fertilisers [25], while the other 15% is used for a broad variety of applications. Each nitrogen atom in industrially produced chemicals is directly or indirectly derived from ammonia (or its derivative nitric acid), *e.g.* it is used for the production of plastics and fibres like polyurethane, polyamides, and polyacrylonitril. Furthermore, ammonia is used for the production of explosives and animal feed. The ammonia synthesis is a catalytic reaction carried out at pressures between 100 and 250 bar and temperatures of 350-550°C, according to the reaction:



Typically, iron-based catalysts are used for the ammonia synthesis. The reaction is thermodynamically limited and the conversion per cycle is limited to approx. 20-30%. To achieve higher conversions the unconverted gas is partly circulated, while the other part is bled to prevent accumulation of inert gases and impurities. The ammonia is recovered from the gas as a liquid by cooling and condensation. In comparison with other syngas-based processes, the ammonia synthesis has two significant characteristics. Firstly, a high concentration of the inert gas nitrogen is acceptable and even required. Secondly, the specifications for oxygen-containing gases (*e.g.* CO₂, and CO) that typically are present in syngas are very strict, *i.e.* the sum of the concentrations should be lower than 20 ppmV [25].

5.3.2 Hydroformylation of olefins

Olefins react with synthesis gas (carbon monoxide and hydrogen) in the presence of homogeneous catalysts to form aldehydes containing an additional carbon atom. This hydroformylation, also called oxo-synthesis or Roelen reaction, is a commercial-scale process for the production of aldehydes. By catalytic addition of hydrogen and carbon monoxide to an olefin an aldehyde is obtained under chain elongation:

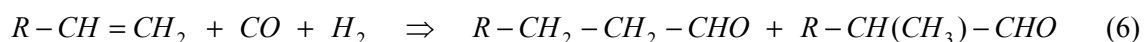

Hydroformylation is generally an exothermic, homogeneously catalysed liquid-phase reaction of the olefin with hydrogen and carbon monoxide. The hydroformylation reaction is used on an industrial scale to produce aldehydes and alcohols. The most important oxo products are in the range C₃-C₁₉; with a share of roughly 75 %, butanal is by far the most significant. Propene is the olefin mostly used. The oxo-products are converted to alcohols, carboxylic acids, aldol-condensation products, and primary amines. About 20 commercial processes are state-of-the-art [25].

Up until the mid 1970s only the cobalt-based catalysts were important industrially. The situation changed when Union Carbide and Celanese, independently of one another, introduced rhodium-based catalysts on an industrial scale. Since then, cobalt catalysts for the hydroformylation of propene have been replaced in nearly all major plants by the more advantageous rhodium catalysts despite the higher price of the noble metal. The catalyst lifetime can be severely diminished by "extrinsic poisons" such as strong acids, hydrogen cyanide, sulphur, hydrogen sulphide, COS, oxygen, and dienes. The feedstock must therefore be very pure. Next to the efficiency, activity, and selectivity of the catalyst, the catalyst lifetime is the most industrially important reaction parameter.

5.3.3 Hydrogen in refineries

Syngas is one of the main sources for hydrogen used in refineries. The syngas is generally produced by steam reforming of natural gas or in some cases by gasification of heavy oil fractions (“bottom-of-the-barrel”). In refineries, hydrogen is used for the hydro-treating and hydro-processing operations. Hydro treating is used to remove impurities (desulphurisation and nitrogen) and for the hydrogenation of olefins. In each refinery several hydro-treating units are present to treat the various product fractions (*i.e.* gasoline, kerosene, diesel, and heating oil). Furthermore, the process is used to pretreat the feedstock of catalytic cracking processes. Hydro processing is used to upgrade the heavy oil fractions to lighter products that can be used for the production of transportation fuels. The specifications for hydrogen in the process industry are relatively mild, typical demands for a hydro-cracker are [25]: H₂ content ≥ 98 vol%, sum CO and CO₂ ≤ 10 -50 ppmV, O₂ ≤ 100 ppmV, and inert gases (*i.e.* N₂, Ar, and CH₄) below 2 vol%.

5.3.4 Synthetic Natural Gas (SNG)

In Section 4.2 the production of SNG from product gas was discussed. SNG can also be produced from syngas, however, in that case the biomass to SNG yield is significantly lower, as no advantage is taken from already present amounts of methane [26].

5.3.5 Other applications

Other applications of syngas have a relatively small market or the processes are still in development phase. Some examples are:

Mixed alcohols

Similar to Fischer-Tropsch synthesis in which a mixture of straight chain hydrocarbons is produced with varying chain lengths, a similar mixture of alcohols can be produced in a catalytic syngas process. Various activities on this subject have not yet resulted in industrial developments. However, probably resulting from the large interest in bio-ethanol, the mixed-alcohol synthesis has received renewed attention in the United States. Power Energy Fuels, Inc. in Denver, Colorado plans to commercialise a process that produces mixed alcohols. Their product with the trade name Ecalene™ consists of a mixture of 75 wt% ethanol and the remainder being higher alcohols [27].

Carbon monoxide

The production volume of carbon monoxide (CO) from syngas is very small compared to other syngas applications. The main consumers of CO are acetic acid and phosgene production processes. With the increasing demand of alternative carbon sources (other than crude oil) it is expected that the demand of CO will increase in the future, *i.e.* the so-called C1-chemistry.

Olefins and aromatics

To date, the most important classes of base chemicals are olefins and aromatics. Already for several decennia research is ongoing to produce these compounds directly from syngas [28]. So far, these attempts have not been successful; processes in which the chemicals are produced from methanol, *i.e.* a syngas product, are more promising. Mobil has developed several processes in which methanol is converted using zeolite catalysts. In the methanol-to-gasoline (MTG) process gasoline is produced from methanol. The product contains approx. 15 wt% of aromatics. By applying conventional separation techniques, the aromatics can be recovered and in this way aromatics can be produced from biomass (when the methanol was produced from biosyngas). In a variant of the MTG process, the methanol-to-olefins (MTO) process, olefins are produced from methanol. The processes have been in operation on 14,500 and 100 bbl/day for the MTG and MTO processes, respectively [29].

6 Gas Specifications

Specifications for biosyngas and product gas are defined by the final gas application and comprise acceptable levels for the concentration of impurities and the required main gas composition. In addition, for certain applications specifically a (cleaned) biosyngas and product gas feed is preferred or required, *e.g.*:

Heat	:	product gas
Power - Combined cycle	:	product gas
Power - CHP gas engine	:	product gas, low tar content
Power - CHP fuel cell (SOFC)	:	product gas, low hydrocarbon & organic content
SNG	:	product gas, nitrogen-free, high methane content
Liquid fuel synthesis	:	biosyngas, nitrogen-free
Chemical synthesis	:	biosyngas, nitrogen-free
Hydrogen production	:	biosyngas, nitrogen-free
Ammonia production	:	biosyngas, containing nitrogen

For the heat and power applications also a biosyngas can be used, however, a product gas is preferred because the energy efficiency from biomass to product gas is higher than the efficiency to biosyngas. In the next two sections the general specifications for biosyngas and product gas are discussed.

6.1 Product gas

The applications of product gas are found in the production of power and/or heat and the synthesis of SNG. The utilisation of biomass-based product gas is not (yet) completely established and for the more advanced applications the technologies are still in development. Resultantly, also the *technical* gas specifications have not yet been defined. More important for heat and power production, however, are the applicable emission regulations that in most cases will result in more stringent gas specifications than required for technical reasons. Typical limits standards apply for emissions of dust, CO and/or CH₄ (indicators for incomplete conversion), NO_x (from fuel-NH₃ and thermal NO_x), SO₂ (from fuel-S), volatile metals, and dioxins.

6.1.1 Heat

For heat production by direct firing of the gas there are in principle no technical specifications for the main gas composition and the impurities (for corrosion reasons the chloride content should not be too high, which for biomass is hardly ever an issue). The product gas must be combustible, *i.e.* a lower heating value of >5 MJ/m_n³. Limitations for the dust content of the gas may apply depending on the type of boiler and the burner. Emission limits can be met with standard and commercially available flue gas cleaning. Gasification gives the advantage of separating the noxious substances from the fuel gas prior to combustion, therefore, alternatively product gas cleaning might be applied. The choice of either approach will be made case-specific and in most cases based on economic considerations.

6.1.2 Power

For power production in a combined cycle (CC) there is only the requirement of a gas free of dust and volatile metals (*i.e.* potassium and sodium). A pressurised feed gas is required,

therefore, the product gas must be generated by pressurised gasification. In case of atmospheric gasification, intermediate product gas compression is an option, however, to allow compression to typical CC pressures (15-40 bar) the gas must be completely clean, making this route much less attractive.

Firing of the product gas in a gas engine requires a dust-free gas with a tar dewpoint below the engine inlet temperature (or even lower in case of a turbo-charged engine) to prevent tar condensation and fouling, *i.e.* typically, up to 2 g/m_n³ of tars and a few vol% of benzene and toluene may be present in the gas. Similar to the heat production case, it is an economic consideration to choose either product gas or flue gas cleaning to meet the emission regulations. The use of fuel cells for power is in theory an attractive alternative for the use of gas engines due to the potential higher electrical efficiencies. As a fuel cell (SOFC) is in principal catalytic process, the gas specifications are much stricter. Sulphur must be completely removed, as it is a poison to the fuel cell, while the content of aliphatic and aromatic hydrocarbons and tars must be not too high to prevent soot formation and coking (*i.e.* quantitative specifications are not yet available from experimental work). A nitrogen-free gas is not required.

6.1.3 Synthetic Natural Gas (SNG)

The production of methane from product gas is a catalytic synthesis for which several processes and catalysts are in development. For all processes sulphur is a serious catalyst poison. Evidently, the use of product gases with high methane concentrations is preferred, while the product gas must be essentially nitrogen-free to be able to meet the final SNG specifications.

6.2 Biosyngas

6.2.1 Impurities

The main application of biosyngas is found in catalytic synthesis processes and catalysts are intrinsically very sensitive to small amounts of impurities. In general, the required gas purity specifications depend on economic considerations, *i.e.* additional investments in gas cleaning versus accepting decreasing production due to poisoning of catalysts or higher maintenance intervals due to fouling of the system. Therefore, there are no “hard” data on maximum levels for impurities in gas. For each plant the acceptable levels may be different. However, rule-of-thumb levels may be used for indication based on data derived for Fischer-Tropsch synthesis [23].

A maximum value of less than 1 ppmV is defined for both the sum of the nitrogen-containing and sulphur-containing compounds. Although for low-pressure methanol process a level as low as 0.1 ppmV of total sulphur is required. For the halides and alkaline metals a lower level of less than 10 ppbV is assumed (see Table 4). Solids must be removed essentially completely, as they foul the system and may obstruct fixed-bed reactors. A number of other possible impurities, such as organic acids (*e.g.* formic and acetic acid) and unsaturated and higher boiling hydrocarbons, are normally not included in purity specifications for synthesis processes because they are already undesirable in upstream process stages of biosyngas production (*e.g.* compression steps). However, organic compounds present must be below their dewpoint at pressure of the gas application to prevent condensation and fouling in the system [23,30]. For organic compounds with S or N hetero atoms (*e.g.* thiophene and pyridine) the additional specification applies that they need to be removed below ppmV level, as they are intrinsically poisonous for the catalyst.

Table 4. Purification level of main biosyngas impurities [23].

Impurity	Removal level
Sum of sulphur compounds (H ₂ S + COS + CS ₂)	< 1 ppmV
Sum of nitrogen compounds (NH ₃ + HCN)	< 1 ppmV
HCl + HBr + HF	< 10 ppbV
Alkaline metals	< 10 ppbV
Solids (soot, dust, ash)	essentially completely
Organic compounds (hydrocarbons, tars)	below dewpoint

6.2.2 Main gas compositions

When gasification is followed by downstream synthesis the stoichiometry of that synthesis reaction requires in most cases a very specific gas composition. In addition, economic aspects must be considered concerning the inerts contained in the gas, which unnecessarily reduce the partial pressure of reactants and tend to concentrate in recycle processes so that a considerable amount of purge gas must be branched off [25]. In Table 5 an overview is presented of main gas specifications for the major biosyngas applications.

Table 5. Overview of main gas composition specifications for selected applications [12].

Synthesis	H ₂ for refinery	Ammonia	Methanol	Fischer-Tropsch	Oxo alcohols
H ₂	>98%	75%	71	60	60
CO	<10-50 ppmv	CO+CO ₂	19	30	40
CO ₂	<10-50 ppmv	<20 ppmv	4-8%		
N ₂		25%			
Inert	N ₂ , Ar, CH ₄ Balance	Ar, CH ₄ as low as possible	N ₂ , Ar, CH ₄ as low as possible	CO ₂ , N ₂ , Ar, CH ₄ low	
H ₂ /N ₂		~3			
H ₂ /CO				0.6-2	1-1.5
H ₂ /(2*CO+3*CO ₂)			1.3-1.4		
Process temperature		350-550°C	300-400°C	200-350°C	85-200°C
Process pressure	>50 bar	100-250 bar	50-300 bar	25-60 bar	15-350 bar

Each application has its own specifications, therefore, it is not possible to define one set of biosyngas specifications. However, a general specification is a hydrogen content of >60%. In methanol and Fischer-Tropsch synthesis 19 and 30% of CO is required, respectively, while for hydrogen production and ammonia synthesis the CO must be completely removed. The total content of inerts (*e.g.* N₂, Ar, and CH₄), which in most cases are not dangerous to synthesis but undesirable for economic reasons, must often be <2% (*i.e.* as low as possible). The exception is ammonia synthesis, in which 25% of nitrogen is required. In general the required ratio of hydrogen to carbon monoxide offers a simple characterization as the main biosyngas characteristic.

7 Gas treatment

Each synthesis gas production plant requires gas treatment facilities to purify product gases and also, in many cases, to condition them. Whereas the gas purification system eliminates the components that would affect downstream processing or utilization of these gases, the purpose of a conditioning system is to remove undesired main gas compounds and to adjust gas components to the appropriate ratio. Especially, the ratio of hydrogen to carbon monoxide must be matched to the requirements of downstream synthesis units or gas consumers [25]. Depending on the type and composition of feedstock and the type of gasification process used, the gas purification and conditioning must handle the following impurities and undesired compounds:

- Particulates.
- Sulphur compounds, *e.g.* hydrogen sulphide, carbonyl sulphide, organic sulphur.
- Nitrogen compounds, *i.e.* mainly ammonia.
- Halogens, *e.g.* chloride.
- Volatile metals, *e.g.* alkali and earth alkali compounds.
- Tars.
- Hydrocarbons (if removal is necessary for usage), *e.g.* CH₄, C₂+ aliphatic hydrocarbons and aromatics like benzene and toluene.
- Carbon dioxide (if removal is necessary for usage).

For discussion the gas treatment is divided in removal of particulates, organic impurities (*i.e.* tars and hydrocarbons), and inorganic impurities (*i.e.* metals, halides, and nitrogen and sulphur containing compounds), and gas conditioning. A good overview about gas cleaning is given in reference 31, therefore, no detailed description of gas treatment system to remove particulates is given here.

7.1 Particulates

Particulate removal is required for both product gas and biosyngas. Particulates originate from the ash of the feedstock, dust, unconverted carbon (in product gas from low temperature gasification, soot (typically for high temperature oxygen-blown gasification), and carry-over bed material in the case of fluidised bed gasifiers. There are many different technologies to remove particulates from gases that can be applied to both biosyngas and product gas. To remove particulates from the synthesis gas the following systems can be used: cyclones, barrier filters, electrostatic filters (ESP), and solvent scrubbers.

7.2 Organic impurities

Organic compounds can only be present in product gas generated in gasification processes operated at temperatures below 1000°C, such as the indirect and CFB gasification processes. The main organic compound is methane. Other organic compounds are the aliphatic C₂+ hydrocarbon higher than methane, with the most important representative being ethylene (C₂H₄), the mono aromatic compounds benzene and toluene, and “tars”. At the high temperatures of entrained flow gasification all organic material is completely destructed and converted into H₂ and CO (with CO₂ and H₂). Therefore, removal of organic impurities, especially the tars, is only of importance for product gas applications.

The C₂+ hydrocarbons and benzene are not considered as impurities in most product gas applications (*cf.* Chapter 4). Complete removal of the tars or at least the larger part of them, however, is necessary. A lot of research and development is ongoing on tar removal and a good overview is given in reference 31, therefore, only the main concepts are discussed here:

- High temperature destruction. Upon increasing the temperature of the raw product gas by oxygen injection all organic compounds are ‘cracked’ and destroyed. The effect is similar to direct gasification at a high temperature (*i.e.* an entrained flow gasifier can be used as tar cracker). As the methane, C₂+ hydrocarbons, and benzene are destroyed, which is unnecessary or even undesired, this approach is not preferred.
- Catalytic destruction. Catalytic tar reduction is typically performed in the raw gas after the gasifier at elevated temperatures (400-850°C) in most cases with nickel-based catalysts. With this method a large part of the tars can be destroyed, while the methane and benzene remain intact for the major part. Major disadvantage of this concept is the sensitivity of the catalysts for (inorganic) impurities in the raw product gas.
- Physical removal. The most promising tar removal concepts are based on physical removal with organic washing liquids. In the FICFB plant in Güssing biodiesel is used to clean the product gas to meet gas engine specifications (tar dewpoint of ~40°C) [8]. ECN has developed the OLGA process that is capable of removing all aromatic organic components to very low levels (*i.e.* tar dewpoints below -15°C). Additional advantage of the OLGA process is that the tars are removed prior to water condensation to prevent pollution of process water and related costs for wastewater treatment [32].

7.3 Inorganic impurities

Removal of inorganic impurities is required for both product gas and biosyngas applications. In this section a general cleaning approach is discussed that is applicable to all types of gases (assuming all possible organic impurities in a product gas have been removed upstream). The cleaning of the raw syngas, produced from fossil fuels, is a well-known and commercially available process (Figure 6), *i.e.* reference is made to processes applied for fossil syngas [33].

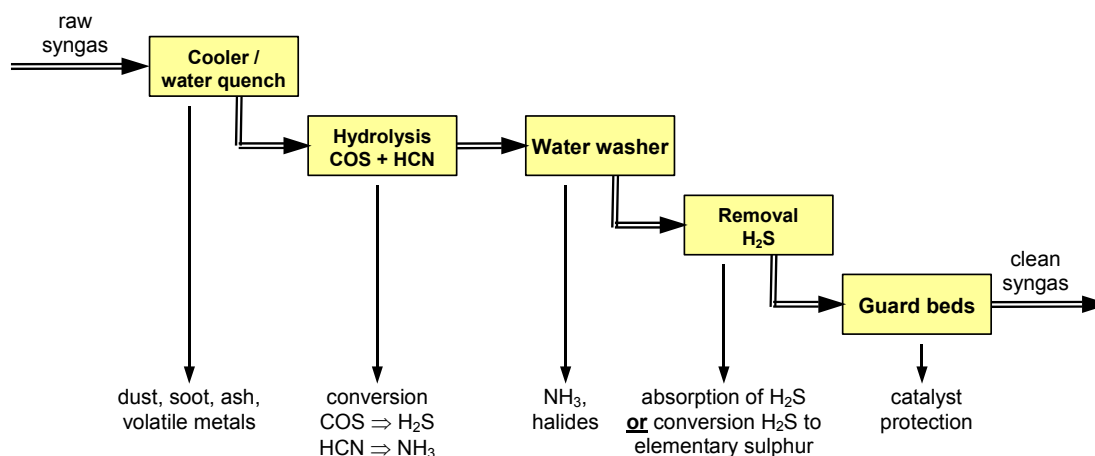

Figure 6. Schematic representation of general industrial approach towards cleaning of syngas from partial oxidation of natural gas based on commercially available technologies [33].

The general approach is to quench the raw hot syngas with water to cool the gas and remove solid particles (*viz.* dust, soot, and ash) and the volatile alkaline metals. Upon syngas production, H₂S, NH₃, COS (and CS₂), and HCN are formed from sulphur and nitrogen in the fuel. The NH₃ is removed downstream together with the halides (*viz.* HCl, HBr, and HF) with a

water washer and H₂S is removed either by absorption or after conversion to elementary sulphur (*i.e.* the Claus process) - the adsorption removal is preferred (cheaper) when relatively small amounts of H₂S are present. Similar is valid for the presence of COS and HCN. These impurities are hardly removed in the gas cleaning and are captured in the guard beds. When a syngas contains higher loads of these compounds it is economically more attractive to install a hydrolysis step to convert the compounds to H₂S and NH₃, respectively, that are readily removed in the gas cleaning. With this cleaning process the syngas specifications are met (*cf.* Section 6.2.1) [24].

7.4 Gas conditioning

Gas conditioning comprises all gas treatment steps to adjust the main gas composition of the biosyngas (or product gas) to meet the specifications of the gas application (*cf.* Table 5). The main issues in gas conditioning are adjustment of the H₂/CO ratio and CO₂ removal. Typically, processes for the manufacturing of syngas from hydrocarbon feedstocks produce mixtures of hydrogen, carbon dioxide, methane, and varying amounts of carbon monoxide. For the majority of industrial processes, the carbon monoxide content is higher than that required for synthesis. The presence of CO₂ is undesired in most processes and this compound should be removed.

7.4.1 Water-gas-shift

To increase the H₂/CO ratio or to (essentially completely) convert CO (and H₂O) into H₂ (and CO₂) the water-gas-shift reaction is used:



The water gas shift equilibrium among carbon monoxide, carbon dioxide, hydrogen, and steam depends on temperature but is almost independent of pressure in the industrial range (elevated pressures up to 70 bar). Above 950-1000°C, the equilibrium is established rapidly enough without a catalyst, but typically the shift is carried out at lower temperatures with a catalyst. Temperature ranges used in commercial carbon monoxide shift conversions are:

1. High-temperature shift (HTS) at about 300 to 510°C with copper-promoted catalysts
2. Low-temperature shift (LTS) at about 180 to 270°C with copper-zinc-aluminium oxide-based catalysts.

Depending on the required H₂/CO ratio the shift is carried out in two steps. In the first high temperature (HTS) step the bulk of the CO is converted; the remaining CO concentration is minimum 1-2 vol%. If hydrogen production is aimed at, a second shift LTS step is carried out to reduce the CO content to 0.2-0.5 vol%.

7.4.2 CO₂ removal

Carbon dioxide can be removed from syngas by chemical and physical absorption with a washing liquid or by adsorption with solid absorbentia. The choice for chemical or physical absorption (or a combination of both) depends on the partial pressure in the gas. For chemical absorption in commercial processes substituted amines are used, while solvents like methanol, polyethylene glycol, and dimethyl ether are used for physical absorption. The CO₂ concentration can be removed to approx. 0.1 vol% by these processes. When the syngas contains significant concentrations of other gases besides H₂ and CO₂, adsorption on solid absorbentia is preferred. Examples of these materials comprise silica gel, active carbon, zeolites, and molecular sieves. The adsorption takes place at low temperatures and high pressures and the regeneration takes place either by higher temperature (TSA; Thermal Swing Adsorption) or lower pressure (PSA; Pressure Swing Adsorption).

8 Concluding Remarks

Biomass will play an important role in the future global energy infrastructure for the generation of power and heat, but also for the production of chemicals and fuels. The dominant biomass conversion technology will be gasification, as the gases from biomass gasification are intermediates in the high-efficient power production or the synthesis from chemicals and fuels. In the discussion on the utilisation of gases from biomass gasification it is important to understand that the composition of the gasification gas is very dependent on the type of gasification process and especially the gasification temperature. In this report the two main types of gasification gas and their typical applications and specifications were discussed, *i.e.* **biosyngas** and **product gas**.

In the past several definitions for gasification gases were used without making this distinction. However, clear understanding of the relation between gasification technologies, the generated gas, its typical applications, and the corresponding specifications is crucial in today's decision-making processes. Incorrect perceptions resulting from confusing terminologies may result in delayed developments, too high expectations, disappointments, and in the worst-case into loss of support because promises are not made true.

9 References

- [1] Shell International (2001) Energy Needs, *Choices and Possibilities – Scenarios to 2050*.
- [2] Johansson, T.B.; Kelly, H.; Reddy, A.K.N.; Williams, R.H. (June 1992) *Renewables for fuels and electricity*, UNCED.
- [3] Energy: Yearly Statistics, EC 2004.
- [4] Boerrigter, H.; Drift, A. van der; Ree, R. van, *Biosyngas; markets, production technologies, and production concepts for biomass-based syngas*, Energy research Centre of the Netherlands (ECN), Petten, The Netherlands, report CX--04-013, February 2004, 37 pp.
- [5] Veringa, H.J.; Boerrigter, H., *De syngas-route... van duurzame productie tot toepassing*, presented at Transitie workshop “Duurzaam Synthesegas”, 10 February 2004, Utrecht, the Netherlands. Published in: Energy research Centre of the Netherlands (ECN), Petten, The Netherlands, report RX--04-014.
- [6] (a) Drift, A. van der; Ree, R. van, Boerrigter, H.; Hemmes, K., *Bio-syngas: key intermediate for large scale production of green fuels and chemicals*, proceedings of 2nd World Conference and Technology Exhibition on Biomass for Energy, Industry and Climate Protection, 10-14 May 2004, Rome, Italy, Vol. II, pp. 2155-2157. (b) Also published in: Energy research Centre of the Netherlands (ECN), Petten, The Netherlands, report RX--04-048, May 2004, 4 pp.
- [7] International Energy Agency (IEA): *World energy outlook*, ISBN 92-64-17140-1 (1999) pp. 225.
- [8] Hofbauer, H.; Rauch, R.; Bosch, K.; Koch, R.; Aichernig, C.; *Biomass CHP Plant Güssing – A Success Story*, Expert Meeting on Pyrolysis and Gasification of Biomass and Waste; October 2002, Strasbourg, France.
- [9] Paisley, M.A.; Overend, R.P., *The Silvagas Process from Future Energy Resources – a commercialisation success*; 12th European Conference and Technology Exhibition on Biomass for Energy, Industry and Climate Protection; Amsterdam, June 2002.
- [10] Drift, A. van der; Boerrigter, H.; Meijden, C.M. van der, *MILENA: lab-scale facility to produce a low-N₂ gas from biomass*, proceedings of 2nd World Conference and Technology Exhibition on Biomass for Energy, Industry and Climate Protection, 10-14 May 2004, Rome, Italy, Vol. II, pp. 887.
- [11] Drift, A. van der; Boerrigter, H.; Coda, B.; Cieplik, M.K.; Hemmes, K., Energy research Centre of the Netherlands (ECN), Petten, The Netherlands, report C--04-039, April 2004, 58 pp. - *Entrained flow gasification of biomass; Ash behaviour, feeding issues, system analyses*.
- [12] Uil, H. den; Ree, R. van; Drift, A. van der; Boerrigter, H., *Duurzaam synthesegas: Een brug naar een duurzame energie- en grondstoffenvoorziening*, Energy research Centre of the Netherlands (ECN), Petten, The Netherlands, report C--04-015 (in Dutch), April 2004, 70 pp.
- [13] Zuideveld, P.L.; Graaf, J. de, *Overview of Shell global solutions' worldwide gasification developments*. In: Gasification Technologies, San Fransisco, October 12-15, 2003.
- [14] (a) Hanneman, F.; Schiffers, U.; Karg, J.; Kanaar, M., *V94.2 Buggenum Experience and improved concepts for syngas application*. In: Gasification Technology Conference, 27-30 October 2002, San Fransisco. (b) Pastoors, H., *Materials behavior in the NUON power IGCC plant in Buggenum*. *Materials at High Temperatures* 20 (1) 61-65 (2003).
- [15] Future Energy GmbH: *Gasification technology, the entrained flow gasification technology of Future Energy GmbH, information brochure*. (2003).

- [16] Boerrigter, H.; Paasen, S.V.B. van, Bergman, P.C.A.; Könemann, J.W.; Emmen, R.; Wijnands, A., *“OLGA” Tar Removal Technology; Proof-of-Concept (POC) for application in integrated biomass gasification combined heat and power (CHP) systems*, Energy research Centre of the Netherlands (ECN), Petten, the Netherlands, report C-05-009, January 2005.
- [17] Rauch, R.; Hofbauer, H.; Bosch, K.; Siefert, I.; Aichernig, C.; Tremmel, H.; Voigtlaender, Koch, R.; Lehner, R., *Steam gasification of biomass at CHP plant Güssing - status of the demonstration plant*, proceedings of 2nd World Conference and Technology Exhibition on Biomass for Energy, Industry and Climate Protection, 10-14 May 2004, Rome, Italy, Vol. II, pp. 1687-1690.
- [18] Teislev, B., *Wood-chips updraft gasifier based combined heat and power*, proceedings of 2nd World Conference and Technology Exhibition on Biomass for Energy, Industry and Climate Protection, 10-14 May 2004, Rome, Italy, Vol. II, pp. 1772-1774.
- [19] (a) Ståhl, K.; Neergaard, M.; Nieminen, J., *Värnamo demonstration programme - final report*, proceedings of 1st World Conference and Exhibition on Biomass for Energy and Industry, Sevilla, Spain, 5-9-June 2000. (b) Sydkraft AB, *Värnamo Demonstration Plant - A demonstration plant for biofuel-fired combined heat and power generation based on pressurized gasification* (2001).
- [20] Babu, S.P.; Hofbauer, H., *Status of and Prospects for Biomass Gasification*, presented at Science in Thermal and Chemical Biomass Conversion (STCBC) conference, 30 August - 2 September 2004, Victoria, Canada.
- [21] Boerrigter, H.; Drift, A. van der; *Biosyngas: Description of R&D trajectory necessary to reach large-scale implementation of renewable syngas from biomass*, Energy research Centre of the Netherlands (ECN), Petten, The Netherlands, report C--04-112, December 2004, 29 pp.
- [22] Dry, M.E. (1981) *The Fischer-Tropsch Synthesis* in Anderson, J.R.; M. Boudart, M. (eds.), *Catalysis-Science and Technology*, Vol. 1, Springer-Verlag, New York, pp 159-255.
- [23] Boerrigter, H.; Uil, H. den; Calis, H.-P. *Green diesel from biomass via Fischer-Tropsch synthesis: new insights in gas cleaning and process design*, in: *Pyrolysis and Gasification of Biomass and Waste*, Bridgewater, A.V. (ed.), CPL press, Newbury, United Kingdom, 2003, pp. 371-383.
- [24] Boerrigter, H.; Calis, H.P.; Slort, D.J.; Bodenstaff, H.; Kaandorp, A.J.; Uil, H. den; Rabou, L.P.L.M., *Gas cleaning for integrated Biomass Gasification (BG) and Fischer-Tropsch (FT) systems*, Energy research Centre of the Netherlands (ECN), Petten, The Netherlands, report C--04-056, December 2004.
- [25] Ullmann's Encyclopaedia of Industrial Chemistry, 2002.
- [26] (a) Deurwaarder, E.P.; Boerrigter, H.; Mozaffarian, M.; Rabou, L.P.L.M.; Drift, A. van der, *Methanation of Milena product gas for the production of bio-SNG*, ECN report RX-05-194, November 2005, 7 pp. (b) Drift, A. van der; Rabou, L.P.L.M.; Boerrigter, H., *Heat from biomass via synthetic natural gas*, ECN report RX--05-187, November 2005, 5 pp. (c) Drift, A. van der; Meijden, C.M. van der; Boerrigter, H., *Milena gasification technology for high efficient SNG production from biomass*, ECN report RX--05-183, November 2005, 6 pp.
- [27] Power Energy Fuels (2004), www.powerenergy.com.
- [28] Wender, I., *Reactions of synthesis gas*, *Fuel Processing Technology*, 48 (1996) 189-297.
- [29] Tabak, S.A.; Yurchak, S., *Conversion of methanol over ZSM-5 to fuels and chemicals*, *Catalysis Today*, 6(3) (1990) 307-327.
- [30] Boerrigter, H.; Uil, H. den, *Green diesel from biomass by Fischer-Tropsch synthesis: new insights in gas cleaning and process design*, presented at PGBW Expert Meeting,

1 October 2002, Strasbourg, France. Published in: Energy research Centre of the Netherlands (ECN), Petten, The Netherlands, report RX--03-047, July 2003, 15 pp.

- [31] Stevens, D.J., *Hot Gas conditioning: Recent Progress with Larger-Scale Biomass Gasification Systems*, 2001, Report by IEA Biomass Task 33 Thermal Gasification of Biomass.
- [32] Boerrigter, H.; Paasen, S.V.B. van, Bergman, P.C.A.; Könemann, J.W.; Emmen, R.; Wijnands, A., "*OLGA*" *Tar Removal Technology; Proof-of-Concept (POC) for application in integrated biomass gasification combined heat and power (CHP) systems*, Energy research Centre of the Netherlands (ECN), Petten, the Netherlands, report C-05-009, January 2005.
- [33] Higman, C.; Burgt, M. van der, *Gasification*, Elsevier Science (USA), 2003.