

**AT** MICROFICHE  
REFERENCE  
LIBRARY

A project of Volunteers in Asia

Local Experience with Micro Hydro Technology  
HWPSS SKAT Publication No. 11, Vol. 1

by: Ueli Meier

Published by:  
Swiss Center for Appropriate Technology  
Varnbuelstrasse 14  
CH-9000 St. Gallen  
Switzerland

Paper copies are 32 Swiss francs.

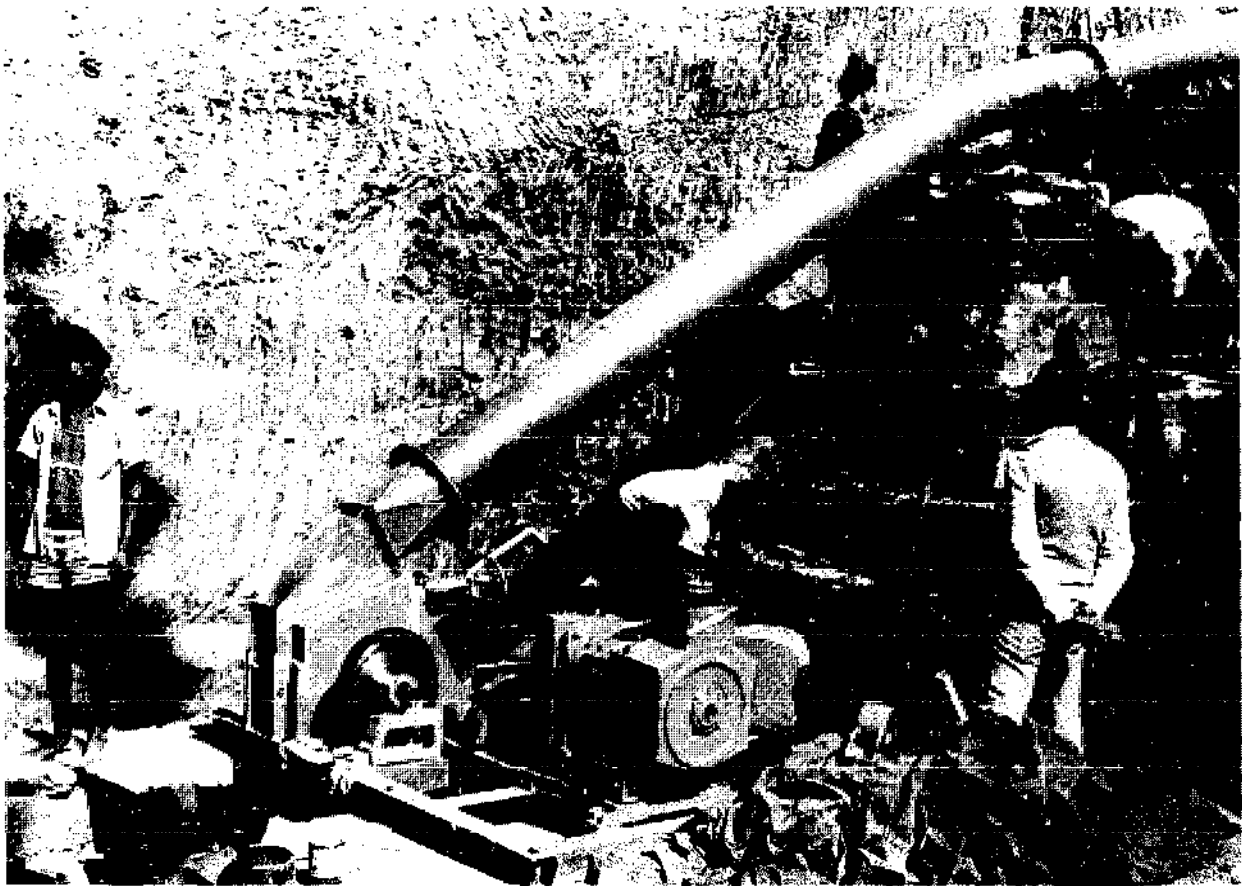
Available from:  
Swiss Center for Appropriate Technology  
Varnbuelstrasse 14  
CH-9000 St. Gallen  
Switzerland

Reproduced by permission of the Swiss Center for  
Appropriate Technology.

Reproduction of this microfiche document in any  
form is subject to the same restrictions as those  
of the original document.

# LOCAL EXPERIENCE WITH MICRO-HYDRO TECHNOLOGY

Author: Ueli Meier, St.Gall, 1981



## SKAT

SKAT  
Schweizerische Kontaktstelle für Angepaßte Technik am ILE,  
Institut für Lateinamerikaforschung und Entwicklungs-  
zusammenarbeit an der Hochschule St.Gallen

SKAT  
Swiss Center for Appropriate Technology at ILE,  
Institute for Latin-American Research and for Development  
Co-operation, University of Saint-Gall

Varnbühlstraße 14, CH-9000 St.Gallen,  
Switzerland, Tel. 071 23 34 81

SKAT  
Centre Suisse pour la Technologie Appropriée à l'ILE,  
Institut de Recherche sur l'Amérique Latine et de  
Coopération au Développement, Université de Saint-Gall

SKAT  
Centro Suizo de Tecnología Apropriada en el ILE,  
Instituto de Investigación sobre América Latina y  
de Cooperación al Desarrollo, Universidad de Saankt-Gallen

Errata sheet Publ. No. 11, Vol. 1

PAGE	LINE	READS	SHOULD READ
9	5 b	scare	scarce
17	8 t	unsensitive	insensitive
50	foot-note*	$Q = 0.15 \cdot 160 \cdot 30$	$Q = 0.15 \cdot 160 \cdot \sqrt{30}$
53	1 t	chosing	choosing
54	3 b	is	if
60	3 t	inductiongenerator	asynchronous generator
	4 t	Du	Due
63	10 t	mass of intertie	moment of inertia
71	2 t	loses	looses
76	fig. 51 para. 2	an keep	and keep
84	10 b	postitive drive	positive drive
95	8 t	Sala	Shala
99	16 t	multiplred	multiplied
103	8 b	incharge	in charge
105	5 t	ANSOLDO	ANSALDO
111	19 t	to high or to low	too high or too low
112	13 t	reamin	remain
115	6 t	chosing	choosing
118	12 b	made	gained
122	2 b	made	gained
126	6,7 t	US \$	US ₤
131	3 t	a costly trick of	costly tricks on
137	3 t	(evitating	(anticipating
	11 t	heads	head
	14 t	labour extensive	low labour intensive
	8 b	where	were
141	16 t	preceding	preceeding
146	12 t	on	of
149	12 b	which a manufacturer could make	which could make a manufacturer
162	1 t	Turbomeccanica Düsoi SA have ceased to exist	

b means from the bottom  
t means from the top of the page

# HARNESSING WATER POWER ON A SMALL SCALE

Publication No. 11, Vol. 1, St.Gall, 1981

## LOCAL EXPERIENCE WITH MICRO-HYDRO TECHNOLOGY

---

- Author:** Ueli Meier, SKAT,  
with the collaboration of Jean-Max Baumer, ILE
- Photographs:** B. Antener, A. Arter, M. Eisenring, J. Litscher,  
U. Meier
- Published by:** SKAT, Swiss Center for Appropriate Technology at  
ILE, Institute for Latin-American Research and for  
Development Cooperation, St. Gall University
- Comments,  
enquiries:** All questions and comments concerning this publica-  
tion and its contents are welcome at SKAT. Please  
use the postcard-questionnaire enclosed.
- Copyright:** Material of this publication may be freely quoted,  
translated or otherwise used. Acknowledgement is  
requested.
- Price:** SFr. 32.--

→ AIRMAIL →

AFFIX  
POSTAGE  
HERE

Sender's address:

.....  
.....  
.....  
.....  
.....  
.....  
.....  
.....

**SKAT**

Swiss Center for Appropriate Technology at ILE,  
Institute for Latin-American Research and for Development  
Co-operation, University of Saint-Gall

Varnbuelstrasse 14  
CH-9000 St.Gall

S W I T Z E R L A N D

Please return this card to SKAT for feedback information - improving  
our cooperation and the future research -  
and/or acknowledgment of receipt of document No.

What is your opinion about this material?

- excellent
- insufficient details
- lacks essential data
- useful, but
- too complicated
- is beside the point
- of no use, because:
- outdated

Your other comments: .....

.....  
.....  
.....  
.....  
.....  
.....  
.....

Name:

Date:

## Preface and Acknowledgment

In the discussion of the energy situation in developing countries and specifically in the rural areas, it is widely recognised that small hydropower may play a significant role in development. What is less clear, is the question what hydropower can realistically achieve and also the question of which specific technologies are technically and economically feasible and socially acceptable.

The paper presented here is an attempt to give some specific answers, based on actual field experience. No claim is made that the technology and the approach discussed are valid in all situations. No doubt, different approaches are possible and different situations may require other technological solutions.

Transfer of know-how of the specific technologies shall be possible with further volumes in the form of design and construction manuals in the same series of publications.

Realising the importance of energy in rural development, the Swiss Directorate for Development Cooperation and Humanitarian Aid (DEH) has financed the work on this paper on the occasion of the UN-conference on New and Renewable Energies, Nairobi 1981. Actual development work in the field, on which most of the contents are based, has been initiated and sponsored by the Nepal Industrial Development Corporation (NIDC) in cooperation with the Swiss Association for Technical Assistance (SATA/HELVETAS) and less formally with the United Mission to Nepal (UMN). Work was carried out by the local engineering firms Balaju Yantra Shala (BYS) and Butwal Engineering Works (BEW), with the cooperation of many other organisations such as ADB/N, CEDT, ETHZ, EPFL, HTL Brugg-Windisch, SHDB and SKAT.\*

In addition, material was used from ATDO, ESCAP, NEA, NRECA, OLADE, UNIDO, the World Bank and many other sources, and the Bibliographisches Institut, Mannheim, gave specific permission to use material from one of their publications.

Grateful thanks are acknowledged to all institutions and individuals who helped directly or indirectly in providing support and information. Special thanks to Jean-Max Baumer who has written the chapter on economics and to Vreny Knöpfler who has done all the typing work.

St. Gall, June 1981

SKAT, Swiss Center for  
Appropriate Technology

---

\* refer to annexe II for abbreviations used

# HARNESSING WATER POWER ON A SMALL SCALE

## **CONTENTS**

	page
<u>ABSTRACT</u>	1
<u>A. INTRODUCTION</u>	7
1. The Need to Expand Domestic Energy Production	
2. Traditional Energy Resources in Rural Areas	8
3. New Solutions are Necessary	9
a) Liquid Fuel from Biomass	
b) Gaseous Fuel from Biomass	
c) Direct use of Sun and Windpower	
d) Water-Power Resources	
<u>B. DEVELOPMENT OF HYDROPOWER RESOURCES</u>	12
1. The Unused Hydropower Potential	13
2. Distribution of Resource-Availability over Time and Geographical Area	14
3. Characteristics of Hydropower Resources	16
4. Big or Small Hydro?	17
a) Big Hydropower	
b) Small Hydropower	
c) Summary of Conclusions	
<u>C. SMALL HYDROPOWER IN THE RURAL SITUATION</u>	22
1. Past and Recent History	
a) Switzerland	
b) China	25
2. Rural Electrification in Developing Countries	27
<u>D. A PRACTICABLE APPROACH</u>	31
1. Constraints and Problems	
2. Technology	32
a) Water Turbines	33
b) Other Equipment	50
c) Survey and Civil Engineering	74
<u>E. PROJECT EXAMPLES</u>	82
1. Salleri/Chialsa Micro-Hydel Project, Nepal	
a) Scheme Details	

b) Power Transmission and Use	
c) Implementation and Present State	
d) Investment Cost	
2. Bhorletar Turbine-Irrigation Project, Nepal	92
a) Organisation and Management	
b) Benefits	
c) Project Execution	
d) Technical Details	
e) Investment Cost	
3. Nam Dang Hydro-Electric Project, Thailand	103
a) Technical Details	
b) Investment Cost	

**F. ECONOMIC CONSIDERATIONS** 109

1. Basic Approach	
a) Cost-Benefit-Approach for Socio-Economic Selection	
b) Constraints on the Selection of Energy-Sources	
c) Concluding Remarks on Decision-Criteria	
2. Micro-Hydropower and larger Hydropower Plants	118
a) Experience with Tangible Internal Costs	
b) Experience with Tangible Internal Benefits	
c) Experience with Tangible External Costs and Benefits	
d) Experience with Intangible Costs and Benefits	
3. Micro-Hydro Plants and other Alternatives	132
a) General Remarks	
b) Oil Fuels	
c) Wood an Dung	
d) Biogas	
e) Liquefied Biomass	
f) Solar and Wind Power	

**G. ASPECTS OF TECHNOLOGY TRANSFER AND DISSEMINATION** 140

1. Policies and Institutions	141
a) Tasks and Responsibilities	
b) Which Institutional Arrangement is Best?	
c) A Country Example	
d) The Need for Training	
2. Finance	148



**ANNEXES**

<b><u>ANNEXE I:</u></b>	Alphabetical Index of Bibliography	152
<b><u>ANNEXE II:</u></b>	Glossary of Abbreviations used	157
<b><u>ANNEXE III:</u></b>	Alphabetical Manufacturer's List	159
<b><u>ANNEXE IV:</u></b>	Alphabetical List of Institutions and Organisations involved in Hydro Development	163
<b><u>ANNEXE V:</u></b>	Standard Energy & Power Conversions	168

## ABSTRACT

Introduction Most developing countries that do not possess their own fossil fuel resources depend heavily on imports of primary energy. Since there is a parallel between energy consumption and economic development and because prices for imported energy (mainly oil) are always increasing, the yearly energy bills and consequently the balance of payment deficits of such countries are growing.

fuel cost

hydro potential

large hydro costly transmission

Often the very same countries that find themselves in such a worsening situation possess major natural resources in the form of water power, that have to a large extent remained untapped. Some big and medium scale hydropower schemes (a few to hundreds of MW capacity) exist in all of these countries. A small portion of the existing potential is used thus, and high grade energy in the form of electricity is produced in such installations. The large quantities of electricity produced require complex transmission and distribution networks. Bringing electricity to the consumers is therefore a costly affair and economically only possible where large load centres exist. These are usually to be found in urban areas where population density is high, thus creating a high domestic demand in a relatively small area. In addition, most large-scale and energy-intensive industries are near urban areas. This too, represents a large demand.

rural situation

In rural areas, where a majority of the people in developing countries live, the population density is very often low, settlements are frequently far apart and the prevalent simple life style requires less high-grade energy per capita compared to city dwellers. Industrial energy demand is generally confined to small-scale activities such as agroprocessing and cottage industry. Thus, electricity demand per unit of area is low and the reason why supply from large generating sites - often over long distances and difficult terrain- and distribution to many low-demand consumers scattered over a large area, is not economically feasible.

The consequence of this unfavourable situation regarding electricity supply to rural areas is that a great proportion of the population of these areas has so far not benefitted from the amenities of electricity.

energy  
consumption

Up to and sometimes more than 90 %<sup>1)</sup> of energy consumed is in the form of biomass (wood, agro-waste etc.) which is used mainly for thermal energy requirements such as cooking and heating in households and in agro-processing (drying, curing). In absolute terms, for cooking alone, a requirement from 1000 to 4000 kWh per capita and year in conventional fuel is quoted in literature.<sup>2)</sup> If electricity is supposed to provide these requirements, a family of five would then need at least 8 kWh of electric energy per day. Or, for cooking alone, 584 kWh per capita and year. Compared with the 1976 consumption figures of 143 kWh/c.y. for India - which possesses large industries - or of 11 kWh/c.y. for Nepal<sup>3)</sup>, one may conclude that such a scale of development would be unrealistic.

not suitable  
for cooking

Moreover, scientifically speaking, it is bad practice to use high grade energy such as electricity for such low-grade thermal applications as cooking. Lastly, besides high generating costs, electric cooking also involves high costs on the part of the consumer for necessary equipment (hot-plates, good quality pots + pans). In another energy sector - rural transportation - electricity is also not an economic or even practical proposition. This includes the transport of people and goods by road, agricultural draft power and river transport but excludes perhaps railways passing through rural areas and possibly ropeway systems.

unsuitability  
for transportation

domain of  
small hydro

The domain where small hydropower can potentially have an important impact on development is in domestic lighting and in providing sta-

1) see gate, Biomasse 11, p 11, + Reddy, Rural Energy Centres, p 110 ff.

2) see Palmedo, Energy Needs ... p 74 ff.

3) Data from ESCAP, Electric Power in Asia ... 1976, p 15

mechanical  
use

tionary motive power for such diverse productive uses as water-pumping, wood and metal working, grain milling, textile fibre spinning and weaving. While much of the discussion is concerned with the generation of electricity, it must be recognised that the same source of power can perform mechanical tasks directly via gears and belt drives, very often more economically. This is illustrated by a look at the history of early industrialisation in Switzerland and the role of small hydropower during that time.

diesel sets

In regions where no grid system for the transmission of electricity exists for the reasons explained, many oil-derivate fuelled prime movers (typically diesel engines) have been installed over the last few decades. These provide electricity for rural communities and individual plantations and farms or perhaps more often, motive power for all kinds of machinery. Operators have found it more and more difficult in recent years to maintain economics, mainly due to the sharp rises in the cost of fuel.

small hydro

Small and very small hydropower schemes combine the advantages of large hydro on the one hand an decentralised power supply, as with diesel sets, on the other. They do not have many of the disadvantages, such as costly transmissions and environmental issues in the case of large hydro, and dependence on imported fuel and the need for highly skilled maintenance in the case of diesel plants. Moreover, the harnessing of small hydro-resources, being of a decentralised nature, lends itself to decentralised utilisation, local implementation and management, making rural development possible mainly based on self-reliance and the use of natural, local resources.

conventional  
technology

There are in fact many thousands of small hydro plants in operation today all over the world. Modern hydraulic turbine technology is very highly developed and the hardware is highly dependable. Its development has a history of more than 150 years.<sup>4)</sup> Sophisticated design and manufacturing technology have evolved in industrialised countries over

---

4) Invention of Fourneyron in 1827, see also Wilson, Engineering Heritage Vol. 1, p 32

scaled down  
large hydro

the last 40 years. The aim is to achieve higher and higher conversion efficiencies, which makes sense in large schemes where 1 percent more or less may mean several MW of capacity. As far as costs are concerned, such sophisticated technology tends to be very expensive. Again, it is in the big schemes where economic viability is possible. Small installations for which the sophisticated technology of large hydro is often scaled down indiscriminately, have a much higher capital cost per unit of installed capacity, without either the advantage of economics of scale or a significant increase in capacity compared to simpler technology. For these reasons a different approach is necessary.

issue of the  
paper

The prime issue of this paper is to show what can be achieved with the development of hydropower at the lower end of the scale (e.g. micro-hydro up to approx. 100 kW), which technology is relatively well developed for this purpose, and how its implementation should make the utmost use of local resources.

available  
know-how

Emphasis is on the use of currently available know-how, using simple equipment that can be made locally, and the use of local construction materials and techniques. The aim is to reduce capital costs as far as possible. Rather than scaling down large-scale technology, this may lead to a more appropriate upgrading of local technology for larger schemes at a later stage.

Cross-Flow  
turbines

Cross-Flow turbines (Michell-Banki), developed in Nepal with Swiss technical cooperation, and almost simultaneous activities with the same turbine type in other countries, are the basis of this effort at further dissemination. The state of the art of turbine and accessory design, possibilities of using ready-made components, problems encountered, and experience in planning and installation are described and documented. In addition, the basics of all parts of civil construction required are explained. For better understanding of the principles of hydraulic machines, the most important types in current use are explained and differences pointed out. Also, in order to see where the Cross-Flow turbine propagated stands in relation to output

difference  
with other  
turbines

capacity and efficiency, compared to commercially-available small turbines, respective graphs are given.

local  
potential

At first sight there is a simple answer to the question as to where the potential may exist for developing small hydro resources: obviously in all those countries with a great deal of rain resulting in substantial runoff, and with a suitable topography (hills, mountains). In reality, however, it may prove difficult to identify sites, establish the generating potential and compare costs for the development of alternative sites. River-flow is, roughly speaking, a function of rainfall and the size of the catchment area, but evaporation, infiltration and the speed of surface runoff are other important factors. The main criterion is the river discharge and its fluctuation over a period of time. For most, if not all small rivers, discharge data over an extended period do not exist, nor are good topographical maps available for all regions of interest. Careful investigation must therefore precede all projects. In most cases there is no choice but to take a non-scientific approach whereby the risk involved should be understood. It can be shown that even under such circumstances the implementation of projects is feasible.

lack of  
data

non-scientific  
approach

necessary  
infra-  
structure

The existence of small metal workshops and/or a local tradition in surface water irrigation are indicators that the harnessing of water power can be initiated with mostly local technological resources.

economics

comparison  
with other  
sources

The economics of small-scale hydropower are naturally a central issue. Of prime interest is a comparison with other sources of renewable and conventional energy and the end-use to which various energies are put. Initial investment is relatively high for hydropower compared to other resources. Capital interest and depreciation therefore result in relatively high fixed costs independent of the quantity of energy produced, making the degree of plant utilisation a critical factor. It is shown how investment cost, operation cost and plant factor interrelate to determine economic viability. In addition, social factors and others that cannot be expressed in monetary terms are briefly analysed.

social  
factors

measures for  
development  
+ dissemin.

institutions  
and training

technology  
transfer

The identification of measures for promoting the development and dissemination of hydropower technology is the first step towards implementation. Issues on different levels, such as policies governing the use of water licences and tariffs, institutional questions concerning the involvement of government, local authorities, cooperatives and private enterprise as well as the local community, are dealt with and examples quoted. The importance of training at all levels of manufacture, planning, construction, operation and maintenance is stressed here as an essential part of the activities. In the area of transfer of technology and specific information networks, it appears that documentation of existing know-how is necessary. In addition, international and regional information networks and specific symposia will help to coordinate development efforts, to solve common problems and to avoid duplication of mistakes.

financing

institutional

project  
financing

On matters of financing different aspects again are considered: Institutional financing for fomenting local know-how and capacity in the areas of the manufacturing of equipment, surveying, the planning and construction of projects, operation and maintenance; the financing of items related to transfer of technology and information flow, training and problem-solving missions; and last but not least, the financing of individual hydropower installations or regional packages of a number of projects. Grant components, lending policies, local participation in financing, the tariff system or the structure applied, are a number of factors that affect project financing one way or the other. Individual project situations tend to be diverse, calling for specific methods of financing.

## A. INTRODUCTION

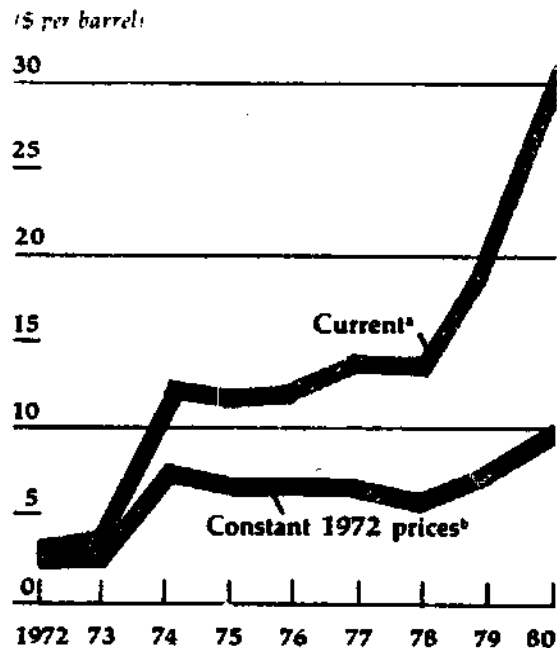
### 1. THE NEED TO EXPAND DOMESTIC ENERGY PRODUCTION

Countries that depend on imports of energy are compelled to step up domestic energy production due to the sharp rise (see fig. 1) in the cost of imported energy (mainly oil). This is particularly so for developing countries, where the oil import bill adds every year to the problem of financing an already large external deficit.

**Fig. 1:**

#### **Petroleum Prices 1972-80**

Source: World Bank 1980, Energy in the developing countries



- a. OPEC government sales prices weighted by OPEC output.
- b. Deflated by manufactured export prices.

Today, energy should rank in importance with the classical factors of production - land, labour and capital - in economic activities and general development efforts. This not only applies for imported energy but also for energy produced domestically. Now and in the future, questions of energy supply can no longer be treated as a second priority because conventional resources are depletable and the switch away from such resources is inevitable.

There is no single resource or technology that could replace oil in the near future. Conservation of energy and the development of all new and renewable resources are necessary to reduce dependence on oil. Many developing countries possess considerable potentials that have remained unexploited while oil was cheap. Their development is quickly becoming economically viable now, but not



all resources lend themselves to quick and easy exploitation. A number of relevant technologies are in the research or experimental stage, others have long gestation times due to their size and sophistication, on still others, environmental constraints limit political acceptability.

## 2. TRADITIONAL ENERGY RESOURCES IN RURAL AREAS

A second energy crisis, coming from diminishing supplies of biomass energy, traditionally used in most rural areas (wood, dung, agricultural residues), is emerging simultaneously. Population growth, deforestation and diversion of fuel-wood and charcoal to cities, where more expensive kerosene is replaced, endanger the ecosystem which supported village life.<sup>5)</sup> The system of traditional energy supply always was and remains very much an integral part of village life. Any change in energy use (e.g. increased consumption) has far reaching consequences on other aspects of life and the rural environment. Energy consumption levels of the majority of the rural population in developing countries are sufficient only to satisfy subsistence requirements according to a study commissioned by U.S. A.I.D.<sup>6)</sup> An approximate figure of the amount of energy consumed is 300 to 400 kilograms of coal equivalent per capita per year (kg ce/cy). This figure seems appropriate for reference purposes although conditions in different countries and areas vary widely and data are available only from a few specific cases.

Most of the rural requirements are met with traditional energy resources. Percentage points of traditional energy use in relation to total energy vary in different environments and can be summarised as follows:

- 800 Million people use 50 %
- 160 Million people use 70 %
- 270 Million people use 90 %
- The remaining people in developing countries use around or less than 40 %.<sup>7)</sup>

The figures given are based on national averages, and for rural areas the share of traditional energy is even higher.

---

5) cited from Palmedo, p XIV

6) the study referred to is: Palmedo ...

7) see Palmedo, p 68

Commercial energy used in rural areas is mainly in the form of oil-derivates such as petrol, high speed diesel and kerosene. Much of it goes to the transport and agricultural traction sector. Other important uses are lighting (kerosene lamps), cooking (kerosene, LNG, LPG)\* and provision of motive power to produce electricity for isolated rural communities and individual farms and plantations, small agro-based industries and cottage industry. Very often such motive power is used directly in its mechanical form, to run all kinds of machinery, typically water pumps, grain- and saw-mills.

Attempts to substitute petroleum products for traditional forms of energy have been dramatically undermined by today's cost of oil. Transport and traction by animal and human energy, for which petroleum products had been substituted to a much greater extent, are suffering a reversal in many regions, and rural electrification - if based on oil-derivate fuel - also has to deal with increasing costs of supply.

### 3. NEW SOLUTIONS ARE NECESSARY

Energy problems are manifold indeed, and a unique solution - consisting of a variable mix of resources and technologies for each case - seems to be called for. There is scope for improving the balance of rural ecosystems through conservation, reforestation and effective wood lot management, and the use of traditional energy may be enhanced with better devices such as more efficient cooking-stoves and charcoal-kilns. Various new technologies have emerged in the past that can meet a number of needs and it is perhaps worthwhile to give a short summary of the state of the art of the major possibilities:

#### a) Liquid fuel from biomass:

The conversion of biomass to liquid fuel is not new. It was used during the Second World-War as a substitute for scarce fuel. It holds considerable promise for application in the developing countries. The production of alcohol, particularly ethanol (ethyl-alcohol), from certain types of biomass, is a commercially well established technology. Ethanol is produced by fermentation and distillation of carbohydrate materials such as sugar cane, sugar beet, molasses

---

\* LNG = Liquid Natural Gas, LPG = Liquid Petroleum Gas

and cassava. It can be used to power vehicles either by itself or blended with petrol. Within limits, ethanol can substitute for an equal volume of petrol with only minor engine modifications. It could thus help to reduce the consumption of petroleum in the transport sector. Methyl alcohol, produced from wood, is more difficult to use as a vehicle fuel, and does not hold promise for the near future.

The economics of alcohol production are not very well established and depend greatly on the cost of biomass material. R + D is being done to improve the efficiency of production and to reduce costs, but it is still too early to assess the prospects for a breakthrough. The biggest constraint of using biomass-derived alcohol on a large scale is the direct competition with food production for arable land. Great care must be taken not to upset an already precarious balance.

#### b) Gaseous fuel from biomass:

Biogas, a mixture containing 55 - 65 % methane ( $CH_4$ ), can be produced from the anaerobic (in the absence of oxygen) decomposition of animal, plant and human wastes. It can be used directly in cooking, reducing the demand for firewood. Also, combustion engines may be run on biogas with little adaptation of the engine only. Moreover, the material from which biogas is produced retains its value as a fertilizer and can be returned to the soil. Millions of small plants exist worldwide (China, India, South Korea, Nepal). Their operation has met with varying levels of success. In cold climates, prospects for the application are reduced since economics are best in the temperature range 25 - 35° C. The poorer part of a population often has no access to the necessary feedstock. Although there is a big potential in aquatic weeds (water hyacinth) and other vegetable waste, its use as a "free" feedstock is not developed to any extent. More research and funds are required to make biogas a viable alternative in many more situations.

Partial combustion of wood or materials such as straw, nutshells, bark or rice hulls, produces a gaseous mixture (wood-gas, producer-gas) with a low calorific value. It can be burned for thermal energy applications, or if filtered, for use in combustion engines. The production and use of both biogas and producer gas could be viable much more widely in rural areas, given funds for research

and development, incentives for experimentation and effective dissemination mechanisms.

### c) Direct use of sun and windpower

Solar and windpower technologies are a third source of renewable energy for developing countries. A firm technical basis exists for windpower projects. Particularly water pumping is a simple and effective technology for rural areas. Machines that produce electricity are highly optimised for small outputs (up to 5 kW) and may be the best alternative for remote and isolated small consumers. Windpower tends to be an erratic resource and care must be taken to assess the wind regime properly and to choose a suitable machine that has been designed for the kind of existing wind regime.

Water heating by flat plate collectors is the solar technology most ready - technically, economically and commercially - for widespread application. Some developing countries have begun to manufacture their own solar water heaters and many others could do so. Solar water heaters are often an economical source of hot water for domestic and industrial purposes. Solar dryers that basically heat air, can provide heat for drying crops in agriculture and are already in use in a number of countries.

Photovoltaic cells, which convert solar energy directly into electricity, appear well suited to many applications in developing countries because they promise long life and trouble-free operation. Solar electricity is still at price levels on the order of \$ 2 per kWh. Costs of photovoltaic cells are falling but it is still difficult to say when the big cost breakthrough will happen. For its high costs it has good prospects only in applications where relatively low power needs exist in remote locations. The use of photovoltaic electricity for water pumping (drinking water, irrigation) appears - at prices of early 1981 - to be viable only where no other alternative exists.<sup>8)</sup>

### d) Water power resources:

For many developing countries, unused water power resources constitute a very considerable potential. The technology is well developed and plays an important

---

8) Material used from: World Bank, Energy in the Developing Countries, New York 1980

role worldwide. Geographically it is limited to suitable sites along rivers and other sources of flowing water.

"The historical approach to energy planning stresses the expansion of conventional energy sources and, generally, large-scale centralised systems. Thus, many countries face the problem of unequal internal growth, and also, a disintegration of the rural and non-commercial sectors."<sup>9)</sup> On the other hand, small potentials may be a very useful resource mainly in the field of providing motive power to stationary users - either direct or through electricity - and lighting. Considerable recent experience exists from a number of developing countries. The rest of this paper is devoted to this and to the elaboration of a practicable approach to harness water power on a small scale (in relation to installation size), but widely applied wherever potential exists and where it appears to be a viable or often superior alternative to other energy sources.

## B. DEVELOPMENT OF HYDROPOWER RESOURCES

Simple water-wheels have been used already in ancient times to relieve man of some forms of hard manual labour. Much later, but long before the advent of the steam engine, the art of building large water-wheels and the use of considerable power capacities was highly developed. The use of this natural energy resource became even easier and more widespread with the invention of the **water-turbine** in the early 1800's. The first small industries emerged soon after in many regions of Europe and North America, powered by water turbines. In Switzerland, a country with abundant hydropower resources, industrialisation began in the first half of the nineteenth century, entirely based on hydropower. In the canton of Zurich alone, comprising an area of less than 2000 km<sup>2</sup>, more than 450 installations were operating by the year 1500, with capacities from less than one to 450 HP and also about 40 turbines with capacities greater than 450 HP.<sup>10)</sup>

In later years, when cheap oil became available worldwide, interest in hydro-

---

9) Cited from: UNCNRSE Conference News 5, 1981

10) Information from Abteilung für Landeshydrographie, Berne 1914

power was lost to a great extent in many areas, but today the situation is different again. Governments, policy-makers, funding and lending agencies and sundry institutions and individuals take a growing interest. This led - and still does - to the reassessment of many projects once found not feasible; the identification of new sites and potentials, and a number of other activities related to hydro development.

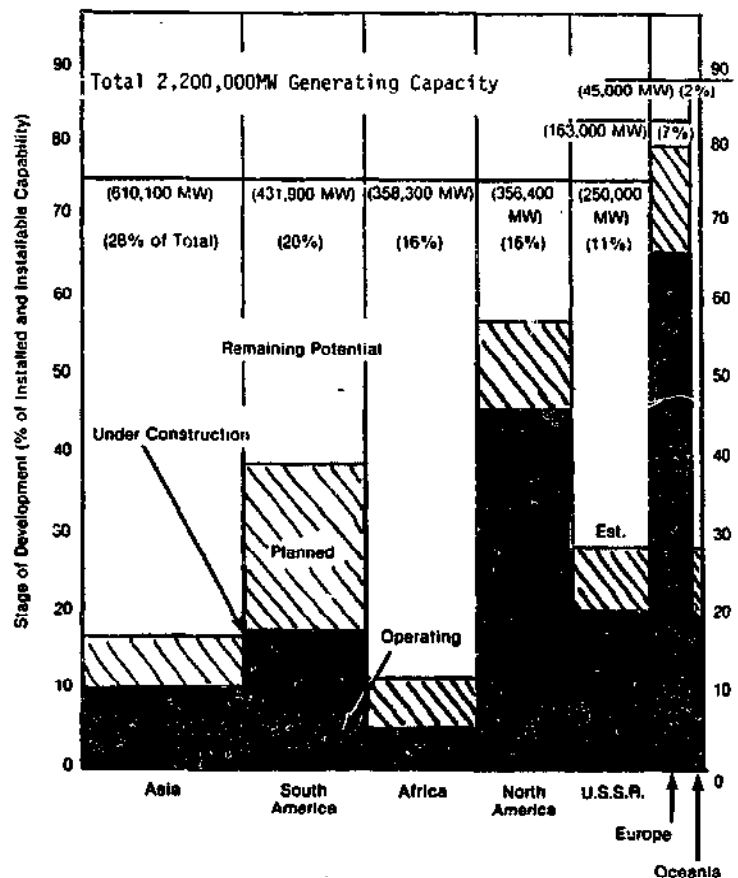
### 1. THE UNUSED HYDROPOWER POTENTIAL

An international commission established by the World Energy Conference in 1974, worked out, inter alia, an objective analysis of the world hydraulic resources.

**Fig. 2:**

#### World Total Installed and Installable Capability

Source: NRECA, Small hydroelectric powerplants, Washington 1980



The results of these studies show that hydropower developed so far is around 17 % of the potential considered reasonably developable (the theoretical energy in global runoff is more than eight-fold). Figure 2 illustrates the **hydropo-**  
**tential** in various regions of the world and the amounts developed, under construction or planned, and the amount remaining. The total developable capacity amounts to 2,2 million MW and has - at a 50 % plant factor - a theoretical yearly production potential of nearly 10 million GWh of electrical energy. The same amount of electrical energy in thermal plants with oil as fuel would

require approximately 40 million barrels of oil per day.<sup>11)</sup>

If this is compared to the world consumption of petroleum products, which amounted to around 70 million barrels per day in 1980,<sup>12)</sup> it becomes evident that hydropower resources are very substantial indeed. For developing countries, who together possess almost 60 %\* of the installable potential, e.g. the equivalent of about 24 million barrels of oil per day, the magnitude is striking. All these countries together consumed 2,54 million barrels of oil equivalent per day, to produce electricity from carbonic fuels (oil, gas and coal) during 1980.<sup>13)</sup>

## 2. DISTRIBUTION OF RESOURCE AVAILABILITY OVER TIME AND GEOGRAPHICAL AREA

The graphical presentation of continent-wise potentials in fig. 2 does of course not show how distribution is within the regions and over time. There are two main factors that determine the generating potential at any specific site: the amount of water flow per time unit and the vertical height that water can be made to fall (head). Head may be natural due to the topographical situation or may be created artificially by means of dams. Once developed, it remains fairly constant. Water flow on the other hand is a direct result of the intensity, distribution and duration of rainfall, but is also a function of direct evaporation, transpiration, infiltration into the ground, the area of the particular drainage basin, and the field-moisture capacity of the soil. Runoff in rivers is a part of the hydrologic cycle in which - powered by the sun - water evaporates from the sea and moves through the atmosphere to land where it precipitates, and thence returns back to the sea by overland and subterranean routes.

Area-wise distribution of river runoff (in mm/year) in fig. 3 gives an indication of the geographical situation of hydro resources in the various parts of the world. It appears that regions around the equator, Central America and

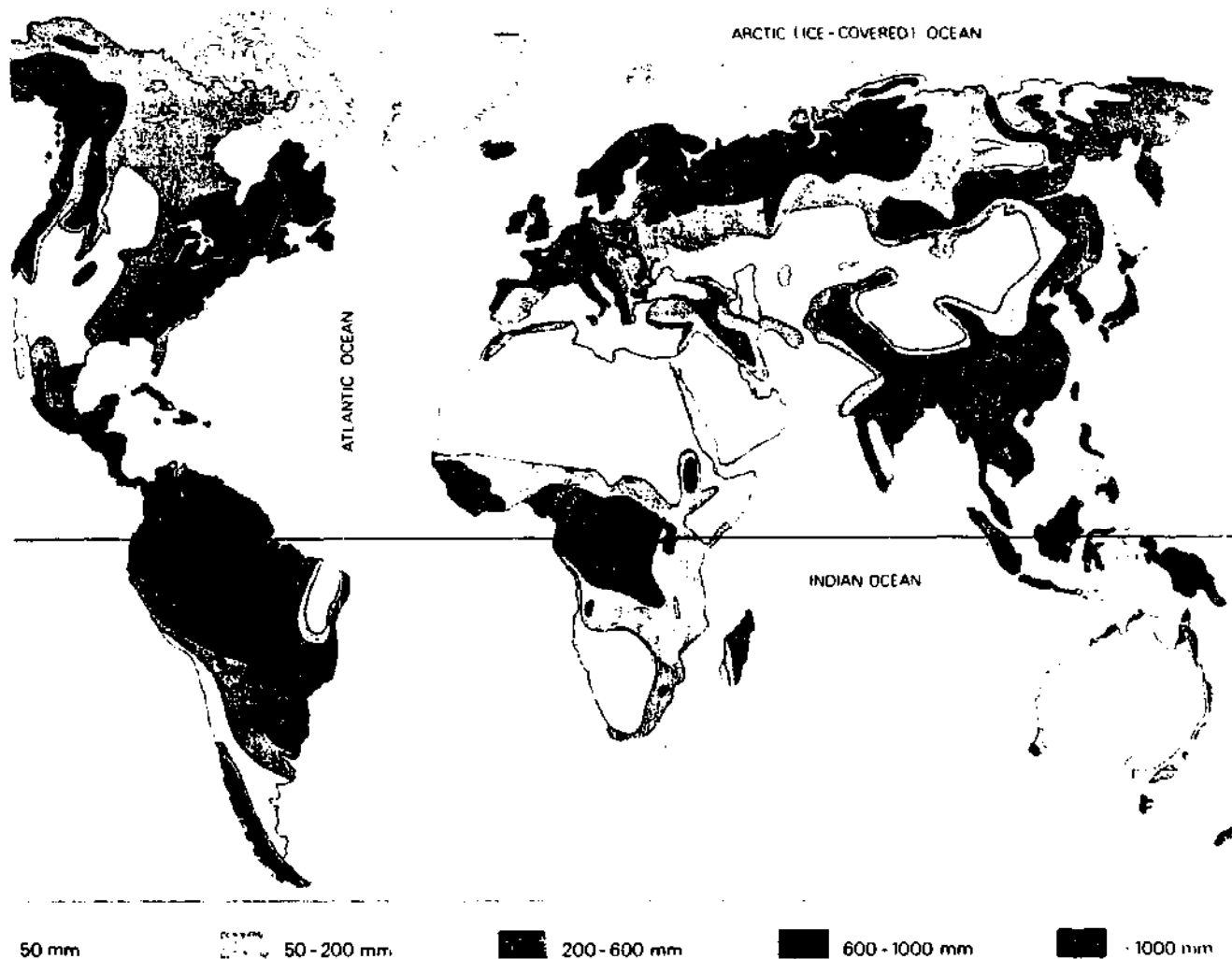
---

11) Calculated at an "oil-to-electricity" conversion efficiency of approx. 38 %, see also NRECA, p 17 .

12) Data from Grainger, A Digest of ... p 23, World Energy Conference, Istanbul 1977

13) From World Bank, Energy in the ... p 63, Washington 1980

\* Calculated from fig. 2



**Fig. 3:**

**World Distribution of River Runoff in mm/year**

Source: AMBIO, Vol. 3, No. 3-4, 1974: The Global Freshwater Circulation

parts of South-East Asia, northern Europe and North America have higher than average runoffs. In large parts of northern Africa (Sahel, Sahara), Arabia, Central Asia, Australia and western North America, as well as southern Africa and America, runoff is far below average. These areas are of little or no interest in the context of hydropower potential. For areas with average and higher runoff, the short-, medium- and long-term variations of flow are of prime interest. It is this local pattern that determines the availability of water to generate power in relation to time and duration. Such variations are subject to the weather regime, i.e. seasons, and a multitude of other factors such as those already mentioned. Generally speaking, perennial rivers with slight flow variations are the most suitable for hydropower development. High



runoff variations, on the other hand, make harnessing more difficult, and extremes such as only seasonal runoff and floods impose serious economic and technical constraints on possible utilisation.

### 3. CHARACTERISTICS OF HYDROPOWER RESOURCES

Perhaps the most particular characteristic is that no two potential sites are alike. Topography, flow regime and volume of the river concerned, together with the geological condition of the site are variables that make each installation unique. It is also true that hydro resources must be harnessed where the potential exists. In situations where likely consumers are far away from the generating site, transmission costs are considerable. Before electricity generation came into use, all activities relying on hydropower were situated adjacent to or near the generating site, because only **mechanical power** transmission was possible. Therefore it is obvious that the economic value of hydro potential varies considerably in different environments.

The lack of accurate long-term hydrological data and to some extent topographical maps of insufficient detail place a severe constraint on hydropower development, mainly in developing countries. It is a specific characteristic that reliable predictability of possible firm power capability is only possible with accurate runoff data over a very long period (>30 years).

Unlike the technologies associated with many new and other renewable energy sources, **equipment** associated with hydropower is well developed, relatively simple, and very reliable. Because no heat (as e.g. in combustion) is involved, equipment has a long life and malfunctioning is rare. Experience is considerable with the operation of hydropower plants in output ranges from less than one kW upto hundreds of MW for a single unit.

Hydro plants are **non-consuming** generators of power. Once water has passed through the turbine, it is available again (although at a lower elevation) for other uses. It is a **non-polluting** technology which, however, may have some negative environmental impacts. From the energy conversion point of view, it is a technology with very high efficiencies, in most cases more than double that of conventional thermal power plants. This is due to the fact that a volume of

water that can be made to fall a vertical distance, represents kinetic energy which can more easily be converted into the mechanical rotary power needed to generate electricity, than caloric energies.

The fact of high capital intensity in hydropower development has not favoured this resource during the time of cheap oil. Now this disadvantage is relatively smaller and outweighs in many instances variable (and probably rising) fuel costs of thermal plants, due to relatively low and stable operating costs, which are largely insensitive to outside inflation and other factors.

#### 4. BIG OR SMALL HYDRO?

- Definition\*:
- big:** all plants with a capacity of more than 1000 kW (1 MW)
  - small:** generic term for all plants with 1000 kW or less capacity and specific term for the range from 501 to 1000 kW.
  - mini:** plant capacity from 101 to 500 kW
  - micro:** all plants with a capacity of 100 kW or less

There is considerable argument about this question on different levels in government, in industry and among the general public. An answer can probably be found more easily, if a second question is asked: application in which context? Before an answer is attempted it is worthwhile looking at the specific characteristics of each and at basic differences between the two groups of plant size.

##### a) Big Hydropower

Big hydropower stations are of a nature that requires a good infrastructure such as roads (during construction) and access to a big market, resulting in long high-tension grid systems and an extensive distribution system. It serves a great number of individual consumers and supplies power to electricity-intensive large industry.

Big plants are usually owned and operated by big companies or state enterprises. The skill requirements in management, administration, operation and

\* Definitions giving several different ranges can be found in literature. In the context of this paper however, the border-line between big and small at 1 MW seems appropriate.

maintenance are considerable. Unit cost of energy generation is relatively low and there are pronounced **economies of scale** involved. This is due to a decrease in specific investment cost with rising plant size, and the probability of higher load factors with a larger number of consumers. A problem is peak demand; big numbers of consumers tend to have their maximum individual demand during the same time-interval, which results in a largely uncontrollable peak of demand that must be met with increased capacity, such as standby installations and high cost pumped-storage.

**Transmission and distribution** costs are considerable and may exceed 30 % of generating cost.<sup>14)</sup> The OECD average in 1975 was more than 7,5 % of generated energy lost in transmission and distribution. In the same year, 35 % of total investment in the electricity supply industry within OECD was for transmission and distribution.<sup>15)</sup> There is a direct relationship between relatively low losses and a high level of investment in transmission. In developing countries, where generally less sophisticated equipment is used, the share of investment is lower but losses are higher, e.g. from an average of 15,7 % in the ESCAP region to about 25 % in Indonesia and more than 28 % in Nepal.<sup>16)</sup> High tension transmission costs per unit are further a function of **line length** and **energy consumption per capita**. And, if a country is fully electrified, line length is a function of **population density** and the degree of urbanization. With this it becomes clear that high population density and high consumption per capita reduce the required transmission length, while low consumption and low population density result in considerably longer transmission lines and higher costs. Thus, a big load, concentrated on a small area, is the most economic to supply.

From the engineering point of view, big hydro power calls for **sophisticated technology** in manufacturing electro-mechanical equipment, and high standards of feasibility studies, planning and civil construction activities, because the risks involved are great. **Long-term flow data** are a necessity and gestation

---

14) In Uganda, where most of the power is generated at the Owen Falls and where the transmission system is very extensive, 44 % of the total operating costs accrue to transmission and distribution, see also Amann, Energy Supply and ... p 29

15) From OECD, The Electricity Supply ... p 12, 23, the figure is an average of all countries except Canada.

16) Data from ESCAP, Electric Power in Asia ... p 15

periods are long. It is possible to apply computer design technology and highly specialised fabrication technology to achieve very high performance efficiencies that may reach 96 % in the case of hydraulic turbines. Needless to say, this process brings about very high cost, which however may be justified because of the large scale, where equipment cost is generally a relatively small fraction of total cost.

Big-scale hydropower stations require careful environmental considerations. Artificial lakes may change an entire landscape and inundate sizeable areas of arable land. Positive aspects are **flood controlling capability** and the creation of new recreational sites (boating, fishing, camping) although it is obvious that the benefits for recreation do not rise in proportion with size. Another negative effect that should not be neglected in tropical areas is the possibility of **water-borne diseases** spreading by large storage reservoirs.

#### b) Small Hydropower

Small hydropower, on the other hand, implies **decentralisation**. Energy produced is usually supplied to relatively few consumers nearby, mostly with a **low-tension** distribution network only. Because of its size, supervision of consumption is possible. The potential exists to diversify consumption in a planned way, and peaking problems are relatively less severe. Small stations lend themselves to local individual or cooperative ownership, operation and administration.

Small hydro is very often mentioned in connection with **high unit-specific cost**. This is an argument which may be put in its proper place by the following statement: "Traditional economic reasoning against the development of very small hydro plants is beginning to weaken, not only because of the rising price of oil which affects the relative costs of all forms of hydropower, but also because of experience gained in the operation of very large enterprise. It is a common proposition that the larger the number of units, the smaller the unit cost. It is easy to understand how capital and running costs for a farm, a factory or a power station, do not rise in proportion to the output, and therefore the more units produced, the more the fixed and running costs can be shared. Nevertheless, against all the economic theories, many small factories and businesses can still operate successfully in competition with the giants for a number of reasons, which apply equally to small power stations. As unit

size falls, the involvement of operators with their work becomes more intimate, and therefore is likely to result in a higher efficiency and better maintenance. Additionally, labour costs for a large firm may be higher than for a small enterprise."<sup>17)</sup>

Apart from this, there is still another issue; small hydro has in the past usually been treated like big hydro. What can often be seen are elaborate construction works in reinforced concrete, an oversize "luxury" powerhouse and highly optimised electromechanical equipment, all carefully miniaturised and with a very high standard of safety, operational reliability and performance. All this was sometimes preceded by detailed and costly pre-feasibility, feasibility and planning stages. OLADE reports that in some projects in Latin America, costs for preparatory stages were running as high as 50 % of total project cost.<sup>18)</sup> It is clear that such a way of doing things - following the idiom "as good as possible" - runs contrary to all efforts at cost reduction.

The nature of small hydro installations usually needs none or little of all this. If an approach of "as good as necessary" is adopted and carried through consistently, things may very well look quite different. Generally, hydrological data for small hydro schemes are scarce or not available anyhow. Even the most elaborate of studies cannot disprove this fact. Experience shows that a station based on apparent **minimum-flow** for its maximum output - which may be established with relatively few measurements, the advice of local people and intelligent estimates - will be acceptably reliable. High safety standards in construction works are often not necessary, even the rupture of a small dam would not usually threaten human life, and money-wise the risks are smaller anyway if initial costs are kept down. This makes it possible to use mainly **local materials** and **local construction techniques**, with a high degree of **local labour** participation.

On the equipment side, standards of voltage and frequency fluctuations and of reliability of supply can usually be lowered - involving considerable savings - without reducing overall benefits of a scheme in proportion. A decrease

---

17) excerpt from Water Power and Dam construction, January 79, p 25

18) Personal communication with OLADE

in conversion efficiency brings about considerable savings, while the amount of reduced generating capacity remains small in absolute terms. The same is true to some extent for losses in the penstock. Higher losses may be accepted in exchange for a cheaper (smaller diameter) penstock. The aim of such considerations is a trade-off between available potential, required generating capacity, acceptable technical standards and cost. The result should be a fairly low-cost installation with simple construction works and equipment that has an acceptable reliability.

Environmental impacts due to small hydro stations are generally negligible or are controllable because of their size. Often they are non-existent. At the same time, flood controlling capability can not be credited to small hydro to a great extent. Road accessibility is a must only for sizes at the upper end of the scale, and schemes can be put into operation in a relatively short time. Many examples could be cited where construction time was a few months only.

A last characteristic attributable to small hydropower stations is that it is often possible to use mechanical power directly to operate all kinds of machinery. This does away with all the sophistication of electricity generation and constitutes the most economical and low-cost power use thinkable. At the other end of the scale of sophistication, small hydropower stations may well be suited to supply power into a big grid-system if one is nearby and if its cost can be attributed to big power stations. While the input is probably very small in relation to the overall system capacity, it still provides additional, saleable energy. Each 650 kWh of electricity supplied represents the equivalent of 1 barrel of oil.\*

After looking at the salient features of big and small hydropower, it is now possible to conclude this chapter with a summarised answer to the question asked before.

### c) Summary of Conclusions

#### **THE CONTEXT FOR BIG HYDROPOWER STATIONS:**

---

\* If oil is converted into electricity at an efficiency of 38 %

- large centralised power demand; large-scale industry, cities, urban areas
- international, national and regional grid-systems
- big corporations or state enterprises employing highly-skilled and well paid staff
- depends on long term assessment of potential, long planning and construction periods involving sophisticated technology
- depending on potential it can make a sizeable contribution to a nation's commercial energy requirements
- its share of total potential is perhaps 90 % based on the known, reasonably developable potential.

#### **THE CONTEXT FOR SMALL HYDROPOWER STATIONS:**

- decentralised, small power demand; small industry, individual farms and enterprises, rural communities
- low tension distribution networks and eventually sub-regional micro-grid systems
- individual, co-operative or communal ownership with semi-skilled labour requirements and co-operative administration
- short gestation period with local materials and skills applicable
- depending on potential, it can make a considerable impact on the quality of rural life, which is clearly over-proportional to the amount of energy supplied.
- its share of the total known potential is on the order of 10 %. Since very few hydrological data exist for small rivers and watersheds, there are good prospects that additional potentials can be identified, particularly in developing countries.

### C. SMALL HYDROPOWER IN THE RURAL SITUATION

#### 1. PAST AND RECENT HISTORY

##### a) Switzerland:

At the beginning of the 20th century, when still more than 65 % of the population lived in rural areas, small hydropower was used extensively in all parts of Switzerland. The statistics of 1914 show that the majority of installations had a size of less than 20 HP\*. All stations of 1000 HP and less together, made up 99,2 % of the total number and made up 31,7 % of the total hydro capacity

---

\* 1,36 HP = 1 kW

utilised. The average size of a station was 76 HP and by far the most served small industry, mills and other enterprises. Distribution of the stations was of course not even, but depended on the topographical and hydrological situation. Nonetheless, on average there was 1 plant on every 6 km<sup>2</sup>.

**Fig. 4:**

**Hydropower Installations in Switzerland 1914**

Source: Mitteilung der Abt. f. Landeshydrographie, Berne 1914

HPS size (HP)	number of stations	% of total	cumulated output (HP)	% of total
0-20	6005	88,3	38'425	7,4
21-100	523	7,7	35'049	6,8
101-1000	214	3,2	90'507	17,5
1001 and over	57	0,8	353'360	68,3
total	6799	100	517'341	100

By 1928 the picture had changed somewhat. While still 96 % of all stations were below 450 HP in output, all stations below 1000 HP together contributed about 29 % of total generating capacity. In the range up to 450 HP the average turbine (or water-wheel) size was as low as 18,8 HP, while it was 245,5 HP in stations from 450 to 999 HP. In some installations, as many as 10 individual turbine units were installed.

**Fig. 5:**

**Hydropower Installations in Switzerland 1928**

Source: Statistik der Wasserkraftanlagen der Schweiz, Berne 1928

HPS size (HP)	no of stations	no of turbines	no of waterwheels	cumulated output capacity (HP)
0-449	5'785	3'086	3'590	125'218
500-999	74	195	---	47'864
1000 and over	160	865	---	2'392'321
total	6'019	4'146	3'590	2'565'403

Small plants continued to supply small and very small enterprises. As fig. 6 shows, a major portion of power was utilised right at the generation site. Generation of electricity for power transmission was secondary. Thus, costs could be kept down and the technology applied was simple and reliable. The table



shows stations in different areas of the country with an exemplary (incomplete) list of successive stations along the river named.

Canton (area)	River used	installed capacity (HP)	use of power
<u>Aargau</u> total 373 stations with av. capacity of 21.7 HP	Hallwiler Aa	1 x 45	pin factory
	"	1 x 160	textile industry
	"	1 x 65	electricity
	"	1 x 25	cotton weaving
	"	1 x 140	electricity
	"	1 x 25	saw mill
	"	1 x 40	grain mill
Direct power use = 83 % of total capacity			
<u>Ticino</u> total 285 stations with av. capacity of 16 HP	Piromogna	1 x 115	electricity
	"	1 x 120	"
	"	1 x 9,5	workshop
	"	1 x 10	grain mill
	"	1 x 15	saw mill
Direct power use = 54 % of total			
<u>Glarus</u> total 99 stations with av. capacity of 69 HP	Linth	1 x 40	cotton printing, lighting
	"	1 x 15	woodworks
	"	1 x 6	mech. work shop
	"	1 x 20	grain mill
	"	1 x 78	cotton printing, heating, lighting
	"	1 x 80	weaving
	"	1 x 120	textile factory lighting
Direct power use = 64 % of total			
<u>Zürich</u> total 482 stations with av. capacity 38,5 HP	Töss	3 x 89	spinning works
	"	2 x 60	grain mill
	"	1 x 20	carpentry
	"	1 x 100	grain mill
	"	1 x 35	electricity
	"	1 x 80	"
	"	1 x 125	button factory
	"	1 x 117	cloth factory
	"	1 x 10	workshop
"	1 x 42	cotton weaving	
Direct power use = 84 % of total			

Fig. 6:

Examples of Small HP-Stations

Source: adapted from: Statistik der Wasserkraftanlagen der Schweiz 1928

Between 1920 and 1935 imports of petroleum products rose by a factor of 5,9 while total expenditure for these products fell by more than 31 %.<sup>19)</sup> This was the advent of cheap oil for Switzerland. In consequence, small hydropower was of less and less importance. It had been the sole basis for industrial development in many areas and it was clearly small hydropower that made large scale developments feasible.

#### b) China:

The construction of small hydropower stations has been a very meaningful application of the Chinese dictum "walking on two legs" in the past 25 years. Besides the development of large resources, much emphasis was given to small-scale developments resulting in an estimated 90'000 stations dotting the vast countryside in 1979.<sup>20)</sup>

The first large-scale campaign to establish many small waterworks started in 1956. An ambitious plan called for the construction of 1'000 small stations of a multi-purpose character, combining irrigation, flood control and power generation, in one year, reaching a total capacity of 30 MW. The campaign actually achieved far less, a mere one - fifth of stations with only 2,8 MW capacity. The program gained momentum again in 1957 and about 350 MW were added in the following two years. Revived during the Cultural Revolution the campaign continued, and even more so after 1969. Most small stations now in operation were built after this date. Capacity in 1973 reached around 1800 MW with an average size of 36 kW per installation. Up to 1975, a further 1100 MW were added with 10'000 new stations, increasing the average size of new installations to 110 kW.<sup>21)</sup> In 1979, finally, the total generating capacity of all small plants was 6300 MW,<sup>22)</sup> with 40'000 stations built in the period from 1975 to 1979, having an average size of 85 kW.

Although industrial capability permitted construction of large turbines, and the range under which small hydropower falls in China was extended to 12 MW,

---

19) Data from Economic Yearbook of Switzerland, 1950

20) SATA/UMN, Report on Study Tour ... p 35, Kathmandu 1981

21) See Smil, China's Energy, p 85 ff, New York 1976

22) See SATA/UMN, p 35

this indicates that construction of very small units continued. In fact, a range of miniature turbine-generators with outputs from 0,6 to 12 kW was developed, suitable for scattered mountain villages with small hydropower resources.

The development activities in this field were entirely relying on local resources - materials, skill and labour - and the results achieved are from this perspective even more impressive. Also, hydropower development in China faces some major natural obstacles. The regional distribution of resources is very uneven and concentrated in regions that are thinly populated. Flow variations in many rivers are considerable. The maximum recorded flood flow in the Huang Ho river was 88 times larger than the minimum discharge,<sup>23)</sup> and in smaller rivers this ratio is likely to be much higher. The silt load in many rivers is enormous and has a considerable effect on the life of storage reservoirs and hydraulic equipment, making the utilisation of hydraulic resources perhaps more difficult than in many other parts of the world. Still, the results are there and might encourage emphasis on such development activities in other countries.

It is also worthwhile to look at some other aspects: As earlier stated, the trend is in most cases one of multiple use of hydro resources. Flood control, irrigation, fish breeding and even recreation are listed. Often, these other uses seem to have higher priority than power generation. Economics tend naturally to be better with such an approach, since civil construction costs for intakes, dams, ponds and canals need not be attributed to a single activity. The specific situation in China seems to make this possible and sometimes imperative. In many other areas of the world, the potential for such a multidisciplinary approach is likely to be smaller, but this need not necessarily reduce the scope for small hydropower development.

Guidelines governing the development of small hydropower stations in China are identical all over the country; emphasis is on local resources, low costs and short construction time. Financing is done with funds accumulated by communes or production brigades with only small amounts of subsidies provided by the state, along with assistance in design, equipment and training of operators. Labour and materials for construction are exclusively local, only minimal quan-

---

23) See Smil, p 72

tities of cement, steel and timber are used. Even the hydroelectric equipment is made locally in small workshops.<sup>24)</sup>

Plans for a new hydraulic scheme originate from commune level. For the design, the county waterbureau is available for help, and decisions for stations below 500 kW are taken at county level, while bigger plants are approved by the province administration. Ownership is usually with the communes. Power use is to about 65 % in the agricultural sector for purposes such as water pumping and cereal processing. Small industry consumes 16 %, while domestic lighting amounts to less than 20 %. Cooking in rural households is mainly done with wood, coal or biogas. Tariffs applied depend on the use of energy. Water pumping is by far the cheapest, and industrial use has the highest tariff in one example while it is highest for domestic purposes in a second example. There seems to exist flexibility in fixing tariffs, depending on the local situation. The role of small-scale hydro-electricity is considerable in rural areas by any standard. In 1974 about 30 % out of 1100 counties had their electricity mainly from small stations.<sup>25)</sup>

## 2. RURAL ELECTRIFICATION IN DEVELOPING COUNTRIES

With the exception of China and a relatively small number of higher developed countries, the degree of rural electrification is far from satisfactory. It is difficult to find reliable data of individual countries but there is no doubt that the percentage of people who have electricity supply facilities varies widely within a given area. Numbers in fig. 7 are supra-regional estimates only and point out regional differences and the magnitude of populations concerned.

Generally speaking, there have been two approaches that were followed in rural electrification programs, namely extensions from grid systems, and to a lesser extent **autogeneration**, e.g. installation of isolated supply systems, typically with diesel sets. Problems with grid-extensions have been touched on in chapter B. The circumstance of high costs for transmission lines combined with a small

---

24) See Smil, p 86

25) The total number of counties is more than 2100, considerable hydropower potential however exists only in the 1100 counties referred to. See also SATA/UMN, p 4, 34 ff.

demand and resulting low financial returns, and the fact that, in expansive countries, not even an extensive grid-system is likely to connect the majority of the population, make this approach limited in scope.

It was for these reasons that the second approach - autogeneration - was chosen in many instances. If such generation is based on oil-fuelled plants, it is obvious that operation costs are seriously affected by the ten-fold increase in costs of oil of the recent past. While many existing plants try to cope with costs somehow, and continue operation, further extensions of rural electrification in this manner have come to an almost total halt.

**Fig. 7:**  
Extent of Rural Electrification, by Selected Region

Source: Estimate based on: World Bank, Rural Electrification, Washington 1975

Region	Rural population (millions)	% of total pop.	Rural population with electricity supply	
			%	(millions)
Africa*	200	80	7	14
Asia	800	70	19	152
Latin America	160	45	29	46
total	1160	--	18	212

\*excluding: Algeria, Egypt, Morocco, Tunisia

A third approach of more recent origin is electricity generation through the conversion of biomass, either by direct combustion and generation of steam used in steam engines or turbines, or by way of intermediary products such as biogas or woodgas, used in adapted internal combustion engines. The first option is technically mature but has perhaps limited scope in the long-term future due to generally very low conversion efficiencies. Technology involved for the second option is in the pilot stage of development, right now obtainable not without difficulty, and at still relatively high cost. Nevertheless, prospects for the future bear promise at least from the technical point of view. From the standpoint of ecology and the environment, serious constraints exist. If wood is used for power generation, this is in direct competition to needs of fuel for cooking, and the danger exists for accelerated depletion of forests, if it is not accompanied by afforestation and wood lot management programs. Growing energy crops on the other hand, for the generation of biogas (or ethanol, which is not discussed here), competes with food crops and must be subject to an optimum land-use planning.

This constraint naturally does not apply if dung, agricultural wastes and "useless" materials such as water hyacinths are used. Depending on livestock holdings and a favourable climate for vegetation growth, such "raw materials" for conversion into useful energy may be considerable. Reddy states in his article; "The design of rural energy centres",<sup>26)</sup> that: "... a biogas plant using cattle manure of the entire village can provide a surplus of 11 m<sup>3</sup>/day of biogas, after meeting all the cooking energy needs of all the households in the village." This statement - made in connection with the study and the optimisation of a specific situation - is perhaps over-optimistic but may serve here to show the importance of biomass-energy in the rural context.

Another point is this: Caloric fuels such as wood and biogas are relatively low-grade energies which can produce medium temperatures only (as compared to mechanical or electrical energy which corresponds to infinite temperatures). Such fuels are best used for thermal applications such as cooking, e.g. direct combustion. The thermodynamic principles applying in the conversion into mechanical power severely limit the efficiency which can be achieved. The theoretical limiting efficiency is given by the law of Carnot\* which applies for all processes converting heat into work.

Conversely, electricity, which is a high grade energy, is best used for high grade applications such as motive power for productive uses and lighting. If used for low grade thermal applications, electricity becomes relatively inefficient and such uses must be the exception rather than the rule: As a matter of fact, in rural areas already "electrified", the use of electricity is, very broadly speaking, limited to lighting and motor drive. In the Indian village studied by Reddy, only 1 % of all energy used is contributed by electricity. Thus, the consumption is small in absolute terms (e.g. 30 kWh/day for a population of 360).<sup>27)</sup> What this amount of energy can achieve on the other hand, is considerable: It pumps water for the irrigation of 4 to 8 hectares of land (depending on pumping height and crops grown), substitutes for about 1000 l of

26) Excerpt from Reddy, The design of ... p 121

27) See Reddy, p 111 ff.

\* Carnot-Efficiency =  $\frac{T_2 - T_1}{T_2}$ , Where: T<sub>2</sub> = temperature of input heat and T<sub>1</sub> = ambient or coolant temperature in units of degree Kelvin.

kerosene that would be required for lighting per year, and runs a small flour-mill occasionally. Such uses have the potential to improve the life of the people served by much more than would be expected from such a small electricity input.

A study and descriptive analysis of the energy situation of six villages on different continents<sup>28)</sup> shows no different picture and is corroborated also by various sources from other countries. In conclusion, it is possible to state that if such minimal needs for high grade energy can be met with a local hydro-power potential, the resulting station will be modest in size but can have a substantial impact.

For a first approximation, a total energy requirement of 600 kgce/cy\* - which is substantially above subsistence level, particularly if efficiently used - may be applied. With scope for growth, 2 % of the total requirement may be provided in the form of high-grade energy, resulting in an installed capacity of approx. 25 W/capita.\*\* This permits basic improvements of the living standards and, depending on the situation, agricultural development of a rudimentary nature. Subsequently, any existing productive power use may be added to arrive at the necessary station capacity. Such a procedure should of course be subjected to much refinement by analysing the given situation and its scope for development in detail.

The approach discussed here is one of supplying high grade energy for basic needs with scope for growth, small stations for initially small demands but multiplied on a large scale, to bring about rural development at a sustained rate. Community development, along with the gaining of experience in executing and operating small projects, and the local development of know-how and skill, would then be the basis for bigger scale developments, diversification of energy use, and more comprehensive, perhaps national, energy planning.

---

28) See Howe et al., Energy for developing countries,

\* kgce/cy = kilogram coal equivalent per capita per year

\*\* calculation:  $600 \cdot \frac{8 \text{ kWh}}{\text{kgce}} \cdot 0,02 = 96 \text{ kWh/capita, year}$

$96/8760\text{h}/0,4 \text{ load factor} = 27 \text{ W/capita}$

## D. A PRACTICABLE APPROACH

### 1. CONSTRAINTS AND PROBLEMS

A number of **energy-related** issues have been outlined in the preceding chapters relating to developing countries, specifically to rural areas. The aim was to identify the **relevance** of hydropower in the overall context and more specifically, small hydropower for rural areas. A number of constraints and problems are associated with the development of small hydropower stations, as with all technology. These must be overcome if the potential resources should become a useful tool in rural development. Summarised, the following points deserve consideration:

- The **lack of long-term hydrological data** has undermined and prevented many ambitious projects. In the mid- and long-term, therefore, it is necessary to establish a network of gauging stations and other hydrological data collection. For the immediate future, harnessing of water power is possible with relatively simple identification surveys, not based on criteria for optimum resource-utilisation but on a more modest scale of using **minimum-flow** to determine plant capacity.
- The **low load factor**, often met in existing stations associated with poor plant utilisation, is resulting in insufficient returns on the invested capital. A low load factor may have several reasons:
  - maximum development of the existing potential regardless of the energy demand in the vicinity, with the erroneous assumption that load would develop by itself.
  - too optimistic assessment of anticipated load growth.
  - the lack of identifying the true value of high-grade energy to the people concerned, and their ability and willingness to pay for such services
- Where the development of all forms of hydropower is the responsibility of a single government agency, small hydropower is often neglected in the face of large-scale projects, where often all manpower available is required. Also, where the same procedures in planning, procurement and licensing are applied as for big projects, small hydro is at a disadvantage. Administrative efforts required are often in no relation to the size of the project and may lead implementors to keep their hands from small scale developments. An answer to these problems could well come about by a policy decision at high levels of government, that provides for procedures specifically tailored for small hydro-development, and a separate government entity that deals exclusively with small hydropower, but with all aspects of it.
- The **fundamental issue** that a small power station is most effectively managed (and perhaps owned) by a small, local organisation, is sometimes forgotten. Experience shows that if stations are centrally managed and staffed by employees of a central government agency, such stations tend to run up high operating costs in terms of salaries, per diem and hardship allowances for operators brought in from outside. The establishment of a local organisation



and the training of its management and staff is no doubt more difficult. Nonetheless, it is a more promising approach and a decisive element for better chances of success.

- **High costs** of equipment and civil works, or, more generally, the capital-intensive nature of hydropower development, has long been a major constraint. Part of the problem has been lower overall costs for other sources of energy, but this applies much less today. However, in many situations it is necessary not only to achieve a better relation of costs compared to other energies, but to reduce them in absolute terms. This is possible to some degree by **standardising equipment**, but the scope for using such standardised equipment remains limited since no two sites are exactly the same. Efforts at cost reduction through **indigenous manufacture** are more promising, largely due to much lower labour costs. To make this possible, **standards** of design, performance and sometimes reliability must be lowered and all unnecessary sophistication avoided. The same is true in civil construction work, where local materials and techniques should be used to the largest possible extent.
- A problem here is that engineers involved are very often trained abroad, where little of direct relevance to rural situations is taught. Such people are very often unaware of local possibilities and skills, a situation that can only be changed "on the job" in active project implementation with local participation. It must be added here that local know-how in the field of hydropower technology does not exist per se in many countries, but needs to be built up. This, as substantial experience shows in a number of countries, is possible directly in the execution of small projects.

## 2. TECHNOLOGY

A discussion of implementation and operation-specific questions remains theoretical as long as no approach of a workable technology is developed that has scope for cost-reduction and self-reliance. Realising this, the Nepal Industrial Development Corporation, together with the Swiss Technical Cooperation program, undertook the development of locally made water turbines in their joint venture, a medium-sized metal workshop, Balaju Yantra Shala (BYS). In the initial stage, a number of **Propeller** (low-head) turbines were manufactured and installed, mainly for direct power drives. An assessment of the performance of these machines after some years, led to the conclusion that a more **versatile** turbine was needed in terms of output capacity and head range. Consequently, a **Cross-Flow** (Michell-Banki) turbine was developed that combined ease of manufacture with considerable adaptability to different situations. This turbine met with a growing interest and a few other workshops started manufacturing small numbers of turbines, adopting the Cross-Flow principle. Almost simultaneously a number of other countries began to concentrate on the Cross-Flow turbine for small projects, notably Thailand, Indonesia, Pakistan and Peru. Basic

principles and state of the art of the technology involved including other components that are required - as well as how it compares to existing conventional technology - shall be discussed here.

a) Water Turbines

In water turbines the kinetic energy of flowing or falling water is converted into mechanical rotary motion. As noted earlier, theoretical power is determined by head and mass flow rate. To calculate available power, head losses due to friction of flow in conduits and the conversion efficiency of machines employed must also be considered. The formula, thus, is the following:

$$P_{(kW)} = H_n \cdot Q \cdot g \cdot \rho \cdot \eta_{tot} = H_n \cdot Q \cdot \eta_{tot} \cdot 9.81$$

- where: P = Output power in kilo Watts ( $10^3$ W)  
 Hn = Net head = Gross head - losses (m)  
 Q = Flow in  $m^3$ /second  
 g = Specific gravity  $\approx 9.81$  m/s<sup>2</sup>  
 ρ = Density (for water  $\approx 1000$  kg/m<sup>3</sup>)  
 η<sub>tot</sub> = Overall efficiency =  $\eta_1 \cdot \eta_2 \dots \eta_n$

For small outputs of interest here, and as a first approximation, the formula can be simplified:

$$P_{(kW)} \approx \frac{H_n(m) \cdot Q(l/s.)}{200}$$

where Q is in liters per second and an overall efficiency of 51 % is implied. The "rule of thumb" calculation is therefore on the conservative side.

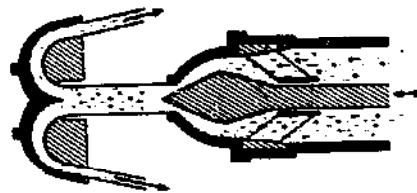
The oldest form of "water turbine" is the water-wheel. The natural head - difference in water level - of a stream is utilised to drive it. In its conventional form the water-wheel is made of wood and is provided with buckets or vanes round the periphery. The water thrusts against these, causing the wheel to rotate.

## PELTON TURBINE

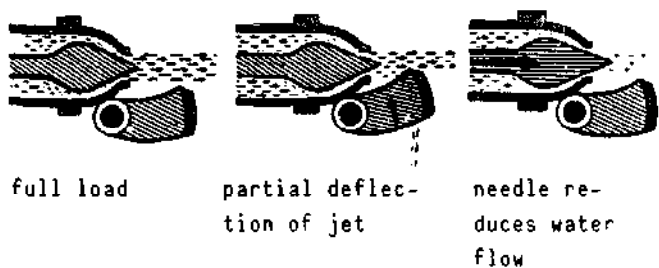
The principle of the old water-wheel is embodied in the modern Pelton wheel, which consists of a wheel provided with spoon-shaped buckets round the periphery (fig. 8). A high-velocity jet of water emerging from a nozzle impinges on the buckets and sets the wheel in motion (fig. 9). The speed of rotation is determined by the flow rate and the velocity of the water; it is controlled by means of a needle in the nozzle (the turbine operates most efficiently when the wheel rotates at half the velocity of the jet). If the load on the wheel suddenly decreases, the jet deflectors partially divert the jet issuing from the nozzle until the jet needle has appropriately reduced the flow (fig. 10). This arrangement is necessary because if in the event of sudden load decrease the jet needle were closed suddenly, the flow of water would be reduced too abruptly, causing harmful "water hammer" phenomena in the water system. In most cases the control of the deflector is linked to an electric generator. A Pelton wheel is used in cases where large heads of water are available.<sup>30)</sup>



**Fig. 8:** Pelton Wheel



**Fig. 9:** Jet Impinging on Bucket



**Fig. 10:** Operation of Jet Deflector and Needle

\* There are water-wheels working on different principles. The statement above applies only to the impingement-type of water-wheel.

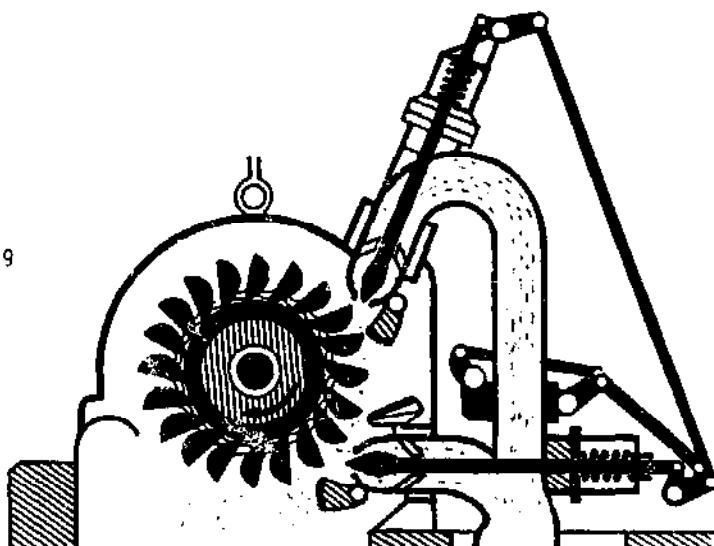
30) Section on Pelton turbines: From How Things Work, The Universal Encyclopedia of Machines, by arrangement with Bibliographisches Institut AG, Mannheim

Pelton turbines belong to the group of the **impulse** (or free-jet) turbines, where the available head is converted to kinetic energy at atmospheric pressure. Power is extracted from the high velocity jet of water when it strikes the cups of the rotor. This turbine type is normally applied in the high head range ( $>40$  m). From the design point of view, adaptability exists for different flow and head. Pelton turbines can be equipped with one, two, or more nozzles for higher output (see fig. 11). In manufacture, casting is commonly used for the rotor, materials being brass or steel. This necessitates an appropriate industrial infrastructure

**Fig. 11:**

Schematic of 2 Nozzle Pelton-Wheel

Source: (Fig. 9, 10, 11) How Things Work, p 49



### **FRANCIS and KAPLAN TURBINES**

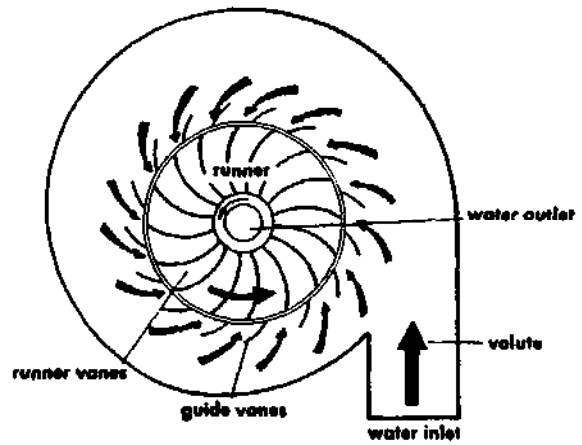
In the great majority of cases (large and small water flow rates and heads) the type of turbine employed is the Francis or **radialflow** turbine. The significant difference in relation to the Pelton wheel is that Francis (and Kaplan) turbines are of the **reaction** type, where the runner is completely submerged in water, and both the pressure and the velocity of water decrease from inlet to outlet. The water first enters the volute, which is an annular channel surrounding the runner, and then flows between the fixed **guide vanes**, which give the water the optimum direction of flow. It then enters the runner and flows radially through the latter, i.e., towards the centre. The runner is provided with curved vanes upon which the water impinges. The guide vanes are so arranged that the energy of the water is largely converted into rotary motion and is not consumed by eddies and other undesirable flow phenomena causing energy losses. The guide vanes are usually adjustable so as to provide a degree of adaptability to variations in the water flow rate and in the load of the turbine.

The guide vanes in the Francis turbine are the elements that direct the flow

of the water, just as the nozzle of the Pelton wheel does. The water is discharged through an outlet from the centre of the turbine. A typical Francis runner is shown in fig. 12. The volute, guide vanes and runner are shown schematically in fig. 13 and the diversion of the water at right-angles to its direction of entry is clearly indicated in fig. 14, which is a cross-section through the turbine.

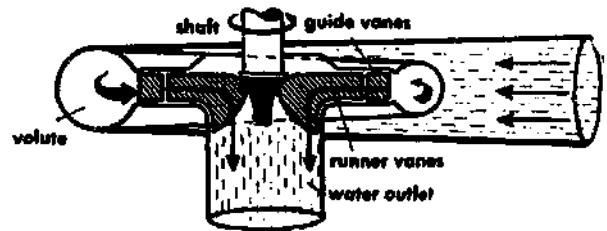


**Fig. 12:**  
Francis Runner



**Fig. 13:**  
Schematic of Flow in Francis Turbine

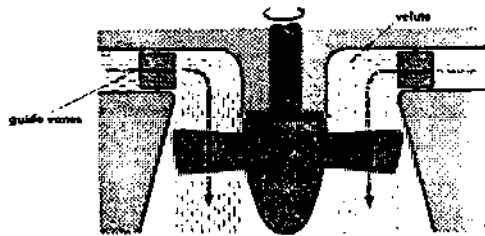
**Fig. 14:**  
Cross Section through Francis Turbine



In design and manufacture, Francis turbines are much more complex than Pelton turbines, requiring a specific design for each head/flow condition to obtain optimum efficiency. Runner and housing are usually cast, on large units welded housings, or cast in concrete at site, are common. With a big variety of designs, a large head range from about 30 m up to 700 m of head can be covered.

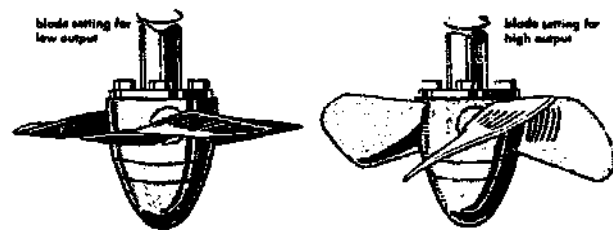
For very low heads and high flow rates - e.g. at barrages in rivers - a different type of turbine, the Kaplan or Propeller turbine is usually employed. In the Kaplan turbine the water flows through the propeller and sets the latter in rotation. The water enters the turbine laterally (fig. 15), is deflected by

the guide vanes, and flows axially through the propeller. For this reason, these machines are referred to as axial-flow turbines. The flow rate of the water through the turbine can be controlled by varying the distance between the guide vanes; the pitch of the propeller blades must then also be appropriately adjusted (fig. 16). Each setting of the guide vanes corresponds to one particular setting of the propeller blades in order to obtain high efficiency.<sup>31)</sup>



**Fig. 15:**  
Kaplan Turbine (schematic)

Source: (fig. 13, 14, 15+16) How Things Work, p 51



**Fig. 16:**  
Propeller of Kaplan Turbine

Specially in smaller units, either only vane adjustment or runner blade adjustment is common to reduce sophistication but this affects part load efficiency. Kaplan and Propeller turbines also come in a variety of designs. Their application is limited to heads from 1 m to about 30 m. Under such conditions, a relatively larger flow as compared to high head turbines is required for a given output. These turbines therefore are comparatively larger. Manufacture of small Propeller turbines is possible in welded construction without the need for casting facilities.

#### **CROSS-FLOW (BANKI) TURBINE**

The concept of the Cross-Flow turbine - although much less well-known than the three big names Pelton, Francis and Kaplan - is not new. It was invented by an engineer named **Mitchell** who obtained a patent for it in 1903. Quite independently, a Hungarian professor with the name **Donat Banki**, re-invented the turbine

31) Section on Francis and Kaplan turbines: From How Things Work ..., by arrangement with the publishers

again at the university of Budapest. By 1920 it was quite well known in Europe, through a series of publications. There is one single company who produces this turbine since decades, the firm Ossberger in Bavaria, Germany. More than 7'000 such turbines are installed worldwide, most of them made by Ossberger.

The main characteristic of the Cross-Flow turbine is the water jet of rectangular cross-section which passes twice through the rotor blades - arranged at the periphery of the cylindrical rotor - perpendicular to the rotor shaft. The water flows through the blading first from the periphery towards the centre (refer to fig. 17), and then, after crossing the open space inside the runner, from the inside outwards. Energy conversion takes place twice; first upon impingement of water on the blades upon entry, and then when water strikes the blades upon exit from the runner. The use of two working stages provides no particular advantage except that it is a very effective and simple means of discharging the water from the runner.



Fig. 17:

Flow in Cross-Flow Model at the Technical Museum, Munich

The machine is normally classified as an impulse turbine. This is not strictly correct and is probably based on the fact that the original design was a true constant-pressure turbine. A sufficiently large gap was left between the nozzle and the runner, so that the jet entered the runner without any static pressure. Modern designs are usually built with a nozzle that covers a bigger arc of the runner periphery. With this measure, unit flow is increased, permitting to keep turbine size smaller. These designs work as impulse turbines only with small gate opening, when the reduced flow does not completely fill the passages between blades and the pressure inside the runner therefore is atmospheric. With

increased flow completely filling the passages between the blades, there is a slight positive pressure; the turbine now works as a reaction machine.

Cross-Flow turbines may be applied over a head range from less than 2 m to more than 100 m (Ossberger has supplied turbines for heads up to 260 m). A large variety of flow rates may be accommodated with a constant diameter runner, by varying the inlet and runner width ( $x$  in fig. 18). This makes it possible to reduce the need for tooling, jigs and fixtures in manufacture considerably. Ratios of rotor width/diameter, from 0.2 to 4.5 have been made. For wide rotors, supporting discs welded to the shaft at equal intervals prevent the blades from bending.

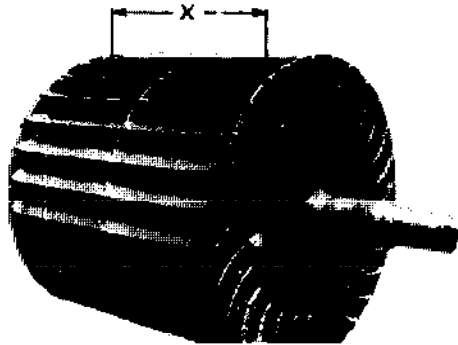


Fig. 18: Cross-Flow Runner

Photo by: U. Meier

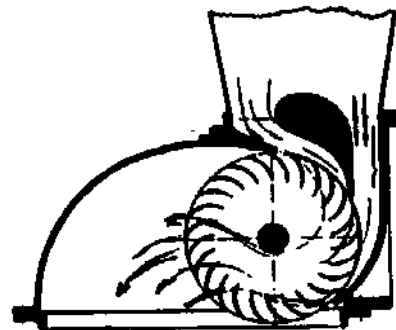


Fig. 19: Cross-Flow Schematic

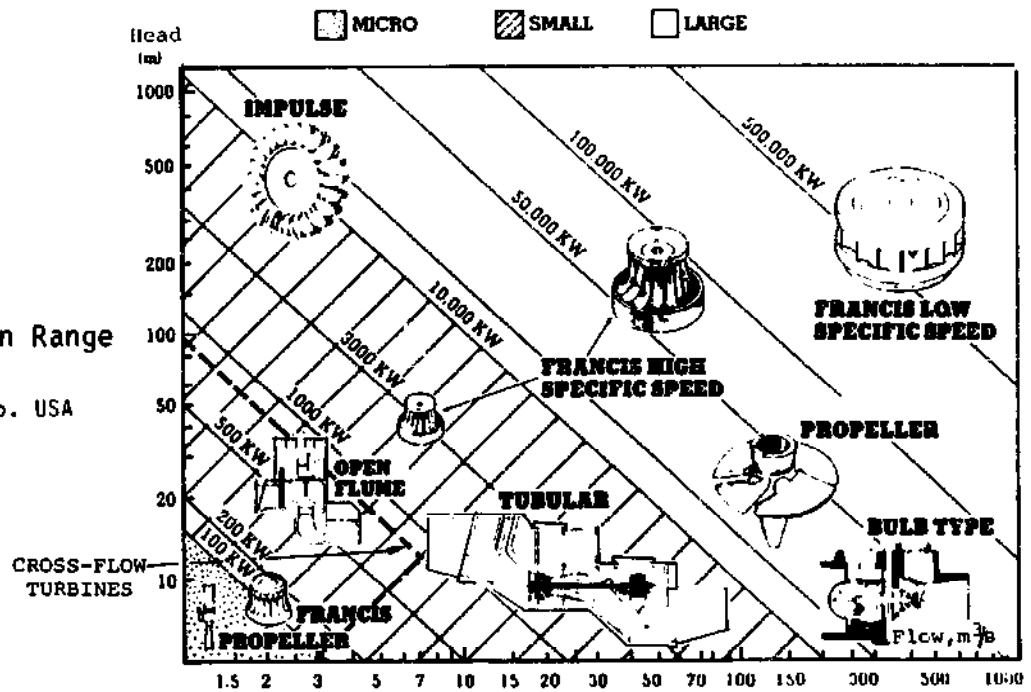
A valuable feature of the Cross-Flow turbine is its relatively flat efficiency curve, which Ossberger are further improving by using a divided gate. This means that at reduced flow, efficiency is still quite high, a consideration that may be more important than a higher optimum-point efficiency of other turbines.

It is easy to understand why Cross-Flow turbines are much easier to make than other types, by looking at fig. 18 and 19.

#### **COMPARISON OF DIFFERENT TURBINES**

Fig. 20 is a graphical presentation of a general turbine application range of conventional designs. The usual range for commercially available Cross-Flow turbines is shown in relation (dotted line). In the overall picture, it is clearly a small turbine.





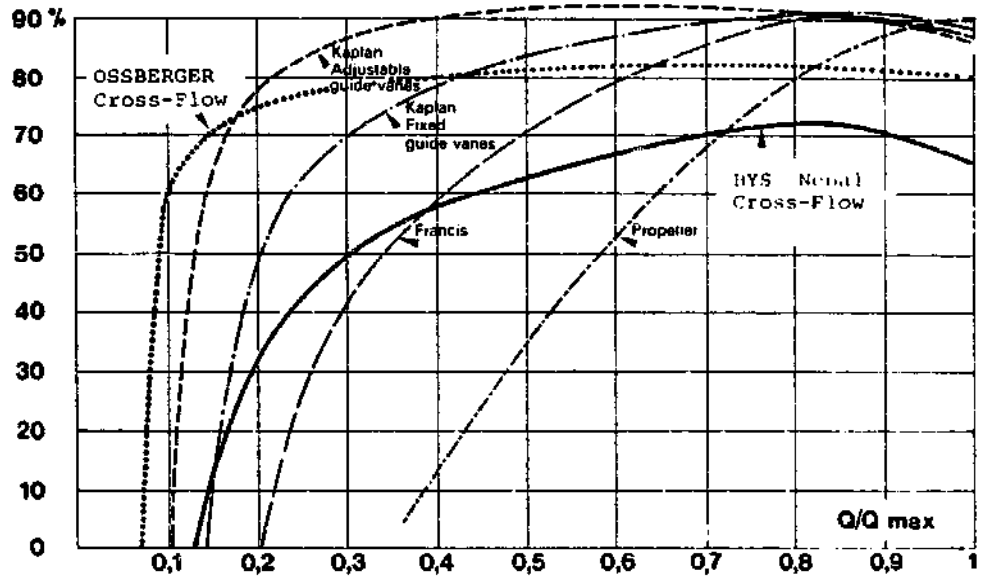
**Fig. 20:**  
Turbine Application Range

Source: James Leffel Co. USA

Fig. 21 shows efficiencies of some of the more important turbine types in relation to gate opening, e.g. flow rate. Conventional and highly optimised turbines (including the Pelton turbine which is not shown) achieve efficiencies of more than 90 % in large units. The Ossberger Cross-Flow has around 80 % for a wide range of flow, and the Cross-Flow turbines built in Nepal achieve over 70 %. On a small unit of, say, 40 kW capacity, the maximum difference in efficiency of the Nepal Cross-Flow, and an imported conventional type would be around 10 % at the optimal point. Given the same head and flow condition, this gives a reduced output for the Cross-Flow turbine of around 5 kW\*. Depending on turbine type, this difference is likely to be smaller or even reversed at reduced flow (e.g. Cross-Flow compared to Francis or Propeller) and also in cases where a standardised conventional turbine is installed in non-optimal conditions.

For more specific reference, the application range of the two designs of Cross-Flow turbines T1 + T3 built by BYS in Nepal are shown (fig. 22) in relation to a range of standardised conventional machines of BELL in Switzerland. Locally

\* Calculation:  $P = Q \cdot H \cdot g \cdot \eta$ ; conventional type:  $0,12 \cdot 40 \cdot 9,81 \cdot 0,85 = 40 \text{ kW}$   
Cross-Flow Nepal:  $0,12 \cdot 40 \cdot 9,81 \cdot 0,75 = 35,3 \text{ kW}$



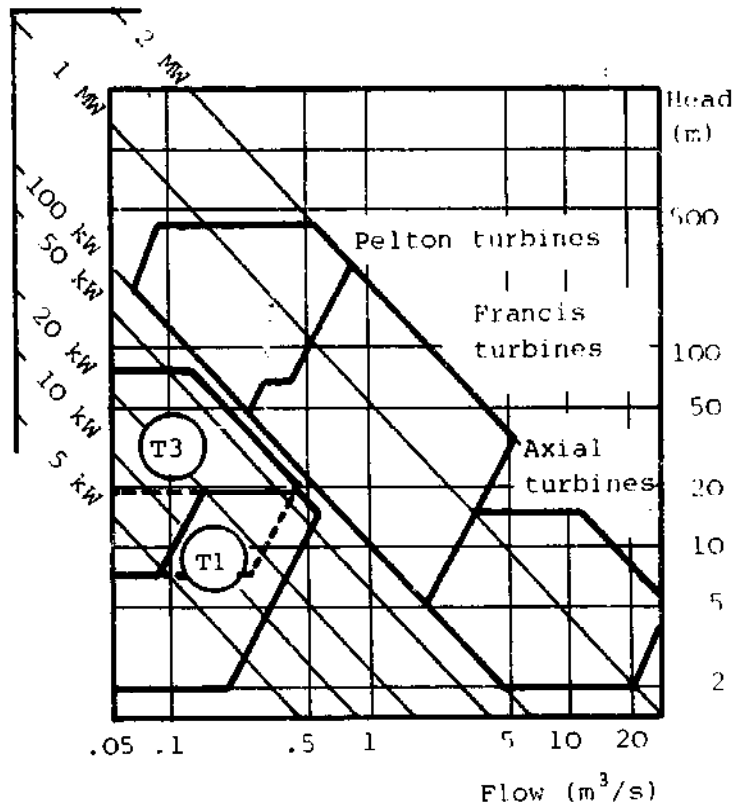
**Fig. 21:**  
Efficiency Curves of some Turbine Types

Source: Adapted from James Leffel Co.

built Cross-Flow turbines in other developing countries cover a similar range. Where need arises, it is possible to extend the application as regards head, flow and output. In Indonesia, for instance, the output range has been extended to 400 kW.

**Fig. 22:**  
Application Range of Nepal Cross-Flow Turbines and Small, Conventional Types

Source: Adapted from BELL, Switzerland



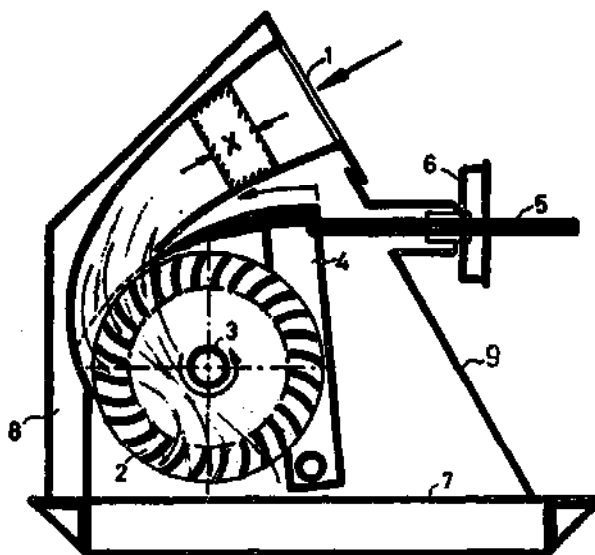
There are a number of manufacturers, mostly in industrialised countries, who offer equipment specifically for outputs below 100 kW. Turbine types range from Propeller and Cross-Flow to Francis and Pelton. For greater clarity, these are not shown in the diagram. Addresses, though, are given in the annexe for reference.

#### DETAILS OF LOCALLY BUILT CROSS-FLOW TURBINES

Turbine T1, the first Cross-flow turbine that was built in Nepal has been specifically designed for manufacturing facilities available at BYS, and is of fully-welded construction. Due to the lack of motorable roads to most installation sites, special consideration had to be given to transportation on the back of porters. Individual parts of the turbine are therefore bolted together and kept in position by taper pins. Thus, a turbine carried to the site in individual parts, can readily be assembled. This is also an advantage, if it should become necessary after some years of operation to repair or replace one of the parts.

**Fig. 23:**  
Schematic of Turbine T1

Source: BYS, Nepal



The inlet (1) consists of two curved sheets that form a logarithmical spiral, welded to two plane side panels to form a rectangular inlet section and nozzle. The width of the inlet is denoted  $x$  in fig. 23 and in the table fig. 31. The rotor (3) consists of 28 blade segments (2) that are cut from standard diameter five inch pipe of 5 mm wall thickness, which fit into slots of two side discs of 400 mm diameter, where they are welded in. The central shaft (3) is also

welded to the rotor discs and final machining of the rotor outside diameter, including the blade tips as well as the shaft diameter, is done after completed welding. The drum-like rotor is also provided with a central supporting disc for the blades, for sizes of  $x > 220$  mm. The shaft extends from both sides of the rotor and is usually symmetric. Depending on the application of the turbine, either both shaft ends can be provided with pulleys to drive two machines via belt-drive, or, if a generator is connected on one side, the other end may be used for operating a speed governor. Bearings used are of the self-aligning spherical double-roller type, which makes accurate machining of the bearing supports unnecessary.

Flow is controlled by the flow regulator (4). Its shaft is parallel to the rotor shaft, with two U-channel parts connecting the regulator shaft with the rectangular tongue at the top. The latter acts as the gate and fits neatly inside the nozzle to keep leaks at the sides in the closed condition within limits. The device is operated by a pushrod (5) which is either connected to a handwheel (6) - requiring a thread on the pushrod and a nut in the handwheel - or, for automatic operation, to the hydraulic cylinder of a speed governor. The housing is completed with the base part (8) and the rear part (9), all bolted to the foundation frame (7).

In addition, two side panels of thin sheet, stuffing boxes and rubber gaskets are required to seal up the turbine housing. The photograph of fig. 24 shows an almost complete turbine assembly on a foundation frame that also accommodates the stand for a small alternator.

In all cases, an adaptor is provided at the turbine inlet that connects the penstock with the turbine. This part is of square shape at one end, to fit to the square inlet, and of circular cross section at the other end to fit to the penstock pipe used.

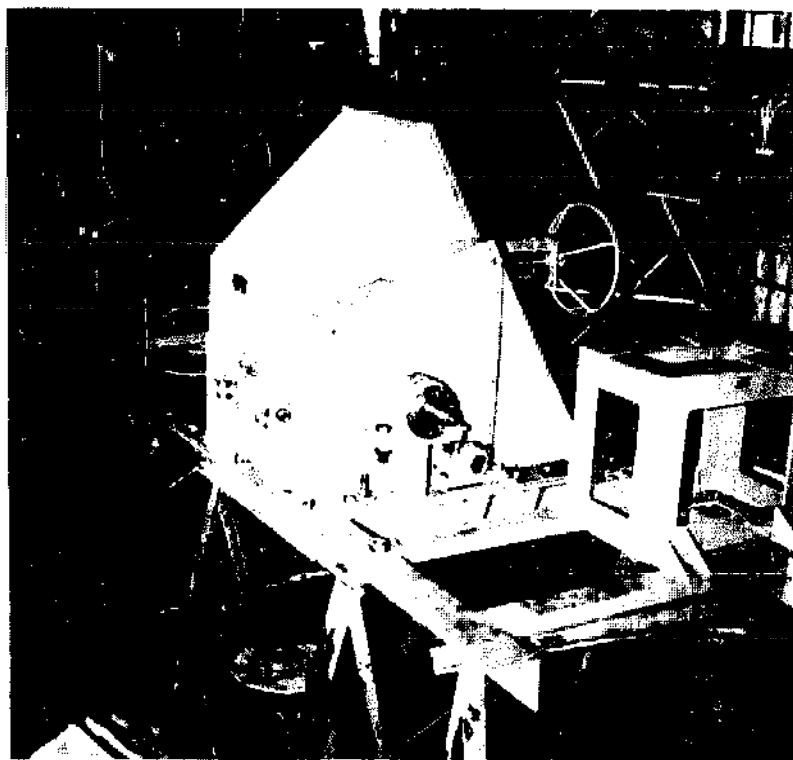
Depending on the setting above tailwater in an installation, a drafttube of square shape is also provided. For this, a flange made from sheet strips is welded to the foundation frame, so that the drafttube can be bolted on.

To cover the head and flow ranges as given in the table fig. 31 at the end of

**Fig. 24:**

Turbine T1 Assembly at BYS

Photo by: U. Meier



this section, the turbine is manufactured in 10 different nozzle widths  $x$ . The table in fig. 25 shows the standard sizes of  $x$  in millimeters and also corresponding other variable dimensions. The diagrams show measurements that remain constant.\*

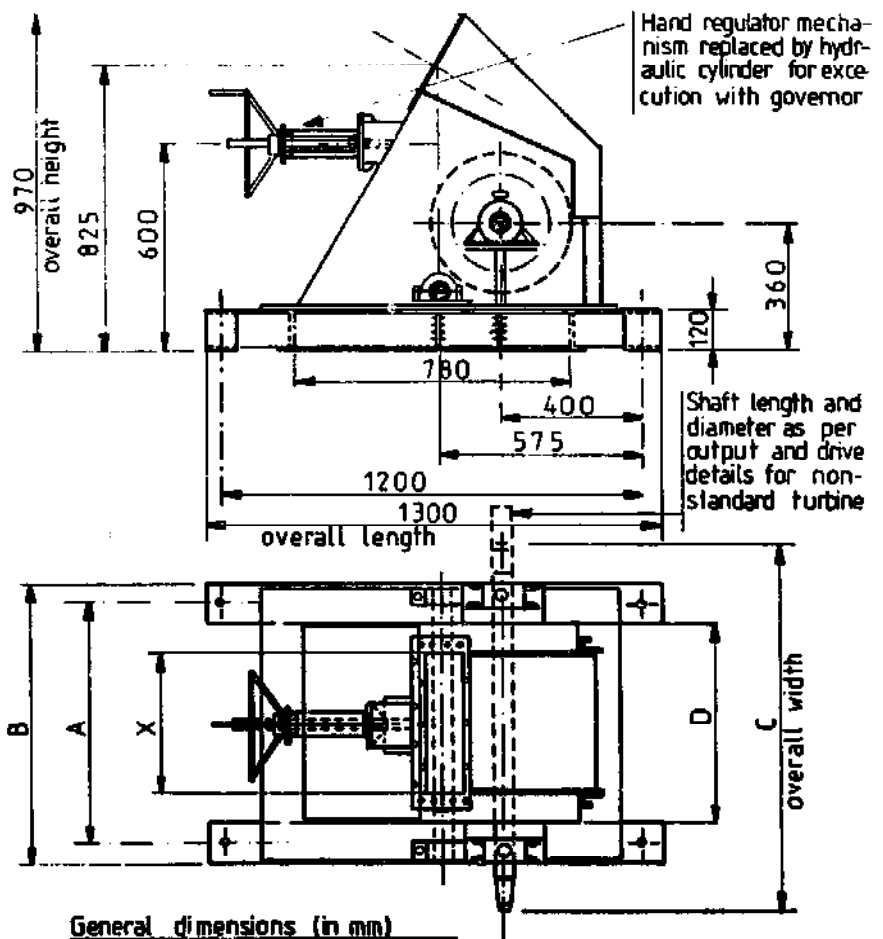
In conclusion it may be noted that turbine T1 is suitable for manufacture in a non-specialised metal workshop. Machine tools required are standard, such as:

- Turning lathe with a centre height  $> 200$  mm
- Drilling machine with a capacity up to  $\emptyset 25$  mm and boring attachment
- Milling machine or shaper
- Acetylene cutting torch, plate shear (optional)
- arc welding equipment
- a number of jigs and fixtures made for the purpose
- general hand tools

Manufacturing can be carried out by a team of three or four, consisting of a trained mechanic, a skilled worker trained on the job, and semi-skilled helpers.

---

\* A detailed construction manual of turbine T1 is available from SKAT upon request.



**Fig. 25:**

General Dimensions of  
BYS Cross-Flow Turbine  
T1

Source: BYS, Nepal

Table of variable dimensions						approx. weight of turbine(kg)
turbine type	A	B	C	X	D(≈)	
X 50	352	462	694	50	260	220
X 70	372	482	714	70	280	230
X100	402	512	744	100	310	245
X150	452	562	794	150	360	260
X180	482	592	824	180	390	275
X200	502	612	844	200	410	280
X220	522	632	864	220	430	290
X300	602	712	944	300	510	325
X360	662	772	1004	360	570	345
X400	702	812	1044	400	610	360

Photographs fig. 26, 27 show some stages of manufacture at BYS. Material used is all common mild steel.

In its application, generally speaking, the machine is clearly overdesigned for outputs of below 25 kW, giving it a long life. For higher output and depending on head and the width of the rotor (shaft bending load), engineering know-how is required to decide whether or not parts that give greater strength must be incorporated (such as bigger shaft diameter, supporting disc, strengthening ribs).



Fig. 26:  
Welding of Rotor T1



Fig. 27:  
T1 Assembly Work with Rotor, Flow-  
Regulator and Square Inlet (top)  
visible

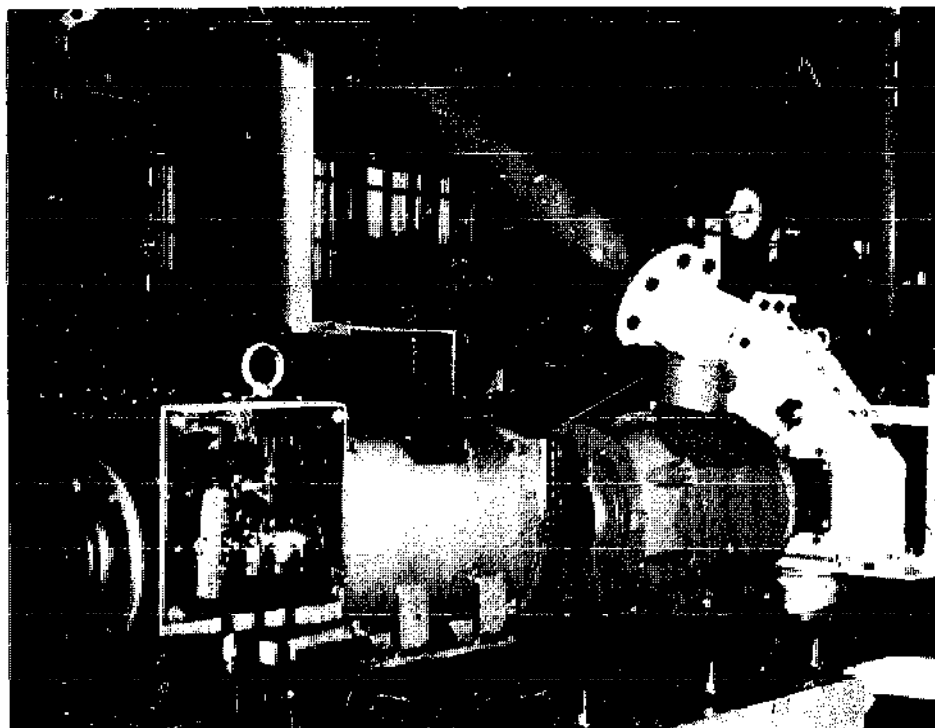
Photos by: U. Meier

Turbine T3 has a more recent history: its design and development is based on experience with T1, and also on the design of turbine type 205 of BEW (Butwal Engineering Works, Butwal, Nepal). Interestingly, the two major Cross-Flow turbine manufacturers in Nepal, BYS and BEW, closely cooperate in technical matters relating to water turbines, although they are competitors in a commercial sense. On the initiative of an engineering student in Switzerland, T3 was developed with information from Nepal fed in through SKAT, and subsequently a prototype was built with a number of rotors of different design, making a laboratory optimisation of the runner configuration possible. The test program was carried out within the frame of student thesis work at the Swiss Engineering College (HTL) of Brugg/Windisch. Photograph fig. 28 shows the prototype turbine with an output of 30 kW under a head of 70 meters installed in the laboratory at HTL Brugg.

**Fig. 28:**

T3 Prototype on the  
Test Bed

Photo by: U. Meier



Lastly, with the test results and some minor adaptations of the design, standardisation and a final design were done by BYS in Nepal. At the time of writing, several turbines T3 have already been built.\*

Turbine T3 has a runner diameter of 200 mm and is therefore much smaller than T1. It is not necessary to make the housing in several parts for transportation purposes. The smaller runner diameter gives it double the speed of T1 which may be an advantage for high-speed applications such as electricity generation. On the other hand, for low-head applications, where a higher speed runner is usually desirable, T3 would necessitate more than double the inlet width as compared to T1, due to its lower specific discharge which results from the smaller rotor diameter. The advantage of smaller general dimensions is therefore compensated for at a certain width of the turbine, so that the required speed and limits of material strength become determining factors to choose between the two designs.

The schematical presentation of the T3 design (fig. 29) shows no basic difference as compared to T1, except for the flow regulator arrangement. For T3, a

---

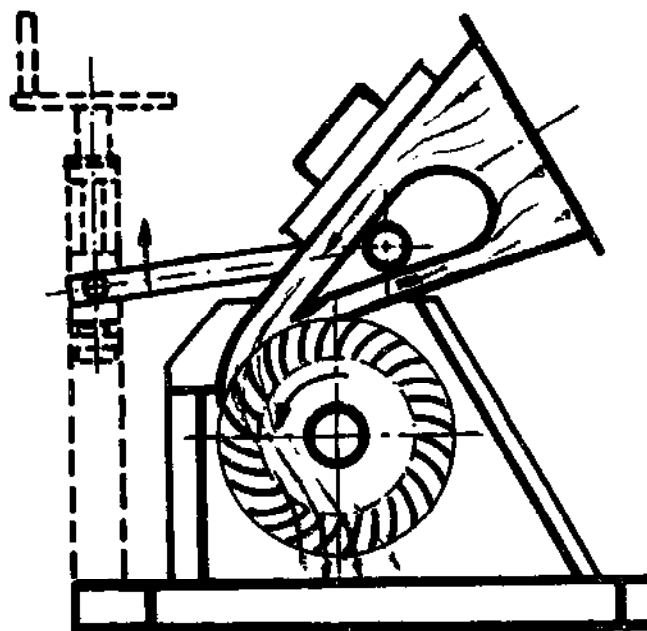
\* A set of workshop drawings T3 and other technical information is available from SKAT upon request.



**Fig. 29:**

Schematic of Turbine T3

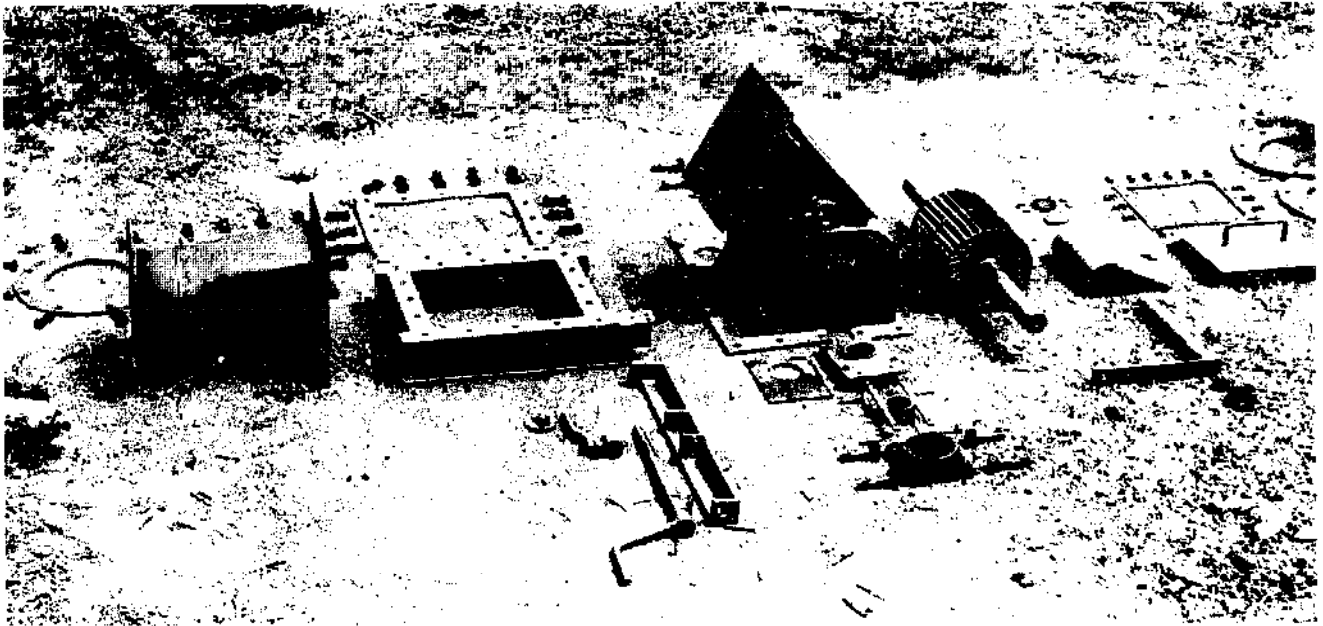
Source: Adapted from design A. Arter



wicket-gate (or butterfly) type was chosen which is situated directly in the inlet. The flow is divided into two sections in this design, which is of no obvious consequence in performance, but permits less material-intensive construction. The wicket-gate of relatively small mass and hydraulically balanced, requires smaller operating forces than the flow regulator of T1. This is an advantage if a hydraulic governor is applied. Another new feature is an access-hole at the top of the inlet. This permits removal of the gate with the turbine in place in the installation, and partial inspection of the rotor.

The design is also optimised to a degree regarding manufacture. The turbine is somewhat simpler to make, is more compact and has fewer parts than T1. Fabrication techniques used are essentially the same, except for the runner blades. These are stamped from 2.5 mm thick steel sheet strips with a hand-hydraulic press. For welding of all parts, a different set of jigs and fixtures is of course required. Turbine T3 has been standardised into inlet widths (denoted  $b_0$ ) 50, 70, 90, 120, 160, 220, 290, 390, 520, 690, 920 mm, to cover the range approximately shown in fig. 22. For large widths, up to 4 supporting discs (depending on head) in the rotor are required to give the blades the necessary strength. Bearings used are of standard self-aligning ball-type with flanges that are bolted to the turbine housing.

Fig. 30 shows a layout of turbine T3 with: (from left to right, pipe adaptor, base frame - both with rubber gaskets and nuts/bolts - turbine housing with gasket and stuffing box and bearing block in front, the rotor, wicket-gate with



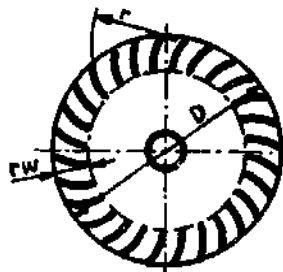
**Fig. 30:**

Layout of BYS Produced Turbine T3

Photo by: B. Antener, BYS

operating lever and bushing, and finally the access hole-lid with gasket. Parts of the manual gate operating mechanism are in front of the base frame.

For a comparison of the two turbines from the design and application point of view, the main specifications have been tabulated in fig. 31. It may be noted that the attempt at optimisation has resulted in a gain of 5 % efficiency for T3. Besides this, the speed range is more suitable for electricity generation - in some cases direct coupling to an alternator is possible without the need for a step-up transmission - and the head range covered is greater. T1 still has its place, specially for heads below 19 meters and for very low heads, for low-speed mechanical power transmission.



	T1	T3
Rotor $\varnothing$ D (mm)	400	200
Blades:		
Nos.	28	32
thickness (mm)	5	2,5
inside radius of curvature, r (mm)	65	31
radial rim width rw (mm)	61	32
Inlet width (mm)	x=50 to 400	bo=50 to 920
Speed: N (RPM) $= \frac{39,4}{D} \cdot \sqrt{H}$	$N=98,5 \cdot \sqrt{H}$	$N=197 \cdot \sqrt{H}$
Head range: (m)	H=2 to 19	H=7 to 80
Speed range (RPM)	140 to 430	520 to 1750
Specific discharge $Q_s$	0,35	0,15
*Absolute discharge (l/s)	$Q=Q_s \cdot x \cdot \sqrt{H}$	$Q=Q_s \cdot bo \cdot \sqrt{H}$
**Discharge limits (l/s)	at: H=2m x=50mm low: Q = 24 high: at: H=16m x=400mm Q = 560	at: H=7m bo=50mm Q = 20 at: H=22 m bo=690mm Q = 480
Output (kW)	$P_{max} = 60$	$P_{max} = 70$
Efficiency (max)	$\eta = 70 \%$	$\eta = 75 \%$

Fig. 31:

Technical Features of Cross-Flow Turbines T1 and T3

Source: Compiled from BYS-data

**b) Other equipment**

**PENSTOCK PIPES AND ACCESSORIES**

For turbine installations in Nepal, the penstock pipes - which deliver the water to the turbine - are usually made from rolled steel sheet welded longitudinally. Flanges at each end are required so that penstock sections can be bolted together in place. For sealing between flanges, flat rubber gaskets are used. Alternatively, it is also possible to use a sealing method developed by BEW, where an o-ring (a standard rubber ring with circular cross-section) is used. One of the flanges is provided with a groove in which the ring rests, so that nearly half of its section protrudes. This is then bolted to the flat face of the second flange, thereby compressing the seal.<sup>32)</sup> It is reported that this

\* where: Q in liters per second, x or bo in mm and H in metres  
Example: T3 : H = 30 m, bo = 160 mm; Q = 0,15 · 160 · 30 = 131 l/s

\*\* at full gate opening

32) See also Scheurer et al., Small Water Turbine, p 44, gate, Eschborn 1980

kind of seal is very effective and is cheaper to make than flat rubber gaskets. Another technique that should be promising where portable welding sets are available, is to weld penstock sections together at the site. While this eliminates flanges, bolts and gaskets, much depends naturally on the skill of welders.

For a safe design of penstock strength, general engineering practice applies. If water hammer - due to sudden closure of the turbine gate - is under control by appropriate governor design, it is usually sufficient to calculate the required sheet thickness with the **hoop-stress formula**.<sup>\*</sup> For considerations of corrosion during the life-time and for a welding factor of less than 1, it is the common BYS practice to add 1.5 to 2 mm to the calculated value and then take the nearest standard sheet thickness. Results with this procedure have been satisfactory. Often, however, permissible stress is not known. In such a case it would be sound to make a **pressure-test** using a water pressure testing-pump on a section of penstock to which end lids are bolted. This is also very suitable for checking welding seams for tiny leaks and for determining the performance of flanges and gaskets. If in such tests a pipe withstands the three-fold operating pressure, it may be considered safe.

It should be noted, that the procedure described does not consider other stresses that a penstock may be subjected to; notably stresses due to elongation, bending stress due to the weight of water and the pipe between supports, and collapsing strength in case of valve closure at the top of the penstock. As a rule, it is more economical to take measures avoiding such additional stresses to a great degree than to dimension the sheet thickness based on a combined-stress calculation. For one, it is relatively easy to provide a sufficient number of **supports**. Elongation should be taken up by **expansion joints** (usually one at the higher end between two anchor blocks) such as shown in fig. 32. The **packing-type** of expansion joint is quite simply made by making one section of the pipe larger in diameter so that the other section fits inside and overlaps for a length of approximately twice the diameter. A stuffing-box type of packing is provided, that acts as a seal and in which the inner pipe

---

<sup>\*</sup> Hoop-stress formula:  $S = \frac{p \cdot r}{\sigma_{perm}}$  (mm), where s = sheet thickness, p = pressure in the pipe, r = pipe inside radius and  $\sigma_{perm}$  = permissible stress with units N/cm<sup>2</sup> for p and  $\sigma_{perm}$ , and mm for r.

may move in case of elongation.



**Fig. 32:**

Expansion Joint in Penstock at Nam Dang, (Thailand)

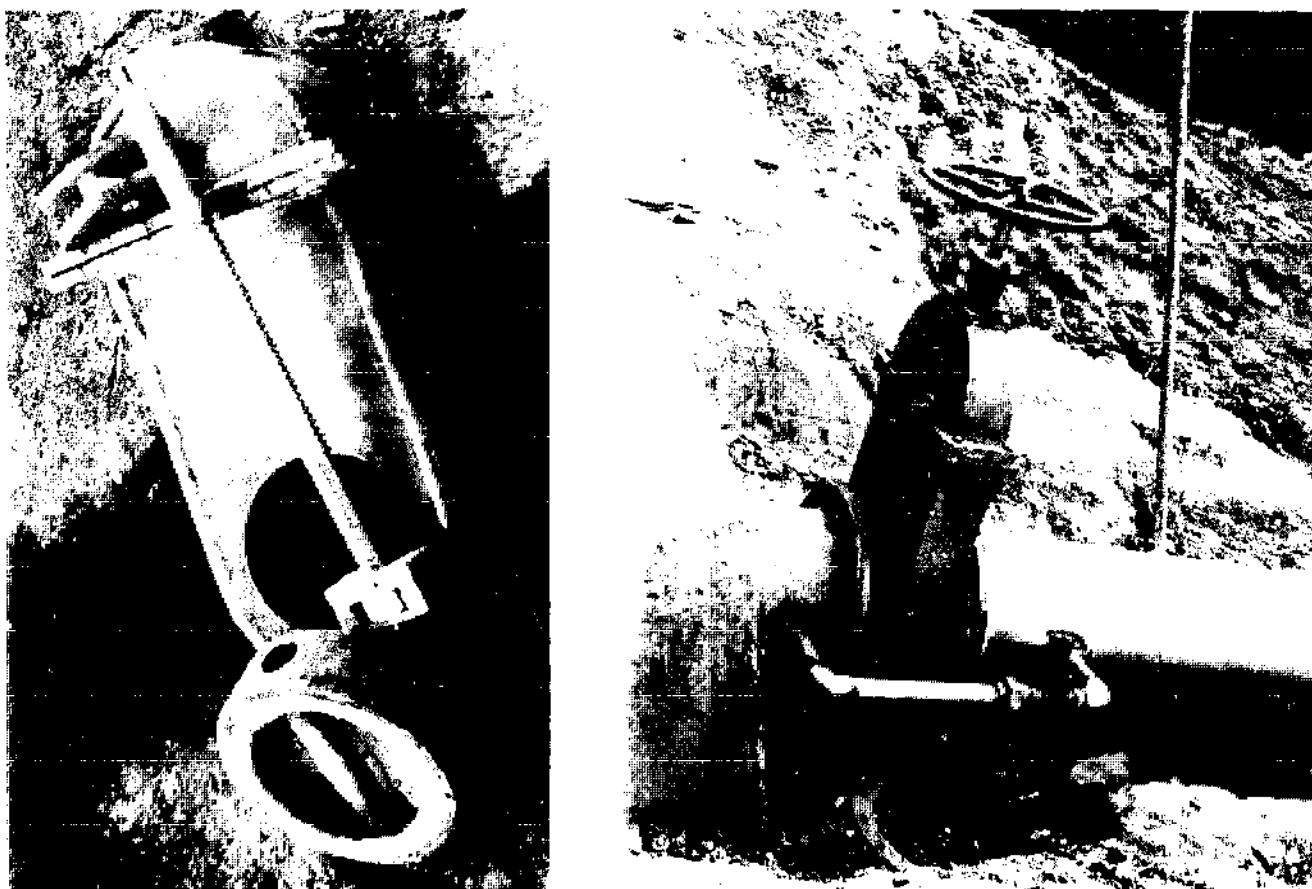
Photos by: U. Meier

To avoid other stresses, two simple parts may be incorporated at the penstock top. A vertical air inlet-pipe of slightly greater height than the head water level and a small bypass valve across the main valve. The former admits air to the penstock when the main valve is closed and the water rushes out and the latter is used to fill the empty penstock slowly, while the main valve is still closed. All three components are shown in fig. 33, the main valve being of the common gate type, also locally made and of welded construction, as can be seen on the left-hand side photograph.

Where alternative material to sheet-metal pipe is available, it is of course worthwhile to compare costs and suitability. It may often be found that PVC and/or PE\* pipes in diameters up to 200 mm cost much less than steel pipe. In Nepal, so far only a few installations are provided with PVC or PE penstocks, mainly because of very limited availability. The use of locally-made ferro-cement pipe is also reported from China.<sup>33)</sup>

\* PVC = Rigid Polyvinyl-Chloride, PE = High Density Polyethylene

33) See SATA/UMN, p 44 ff.



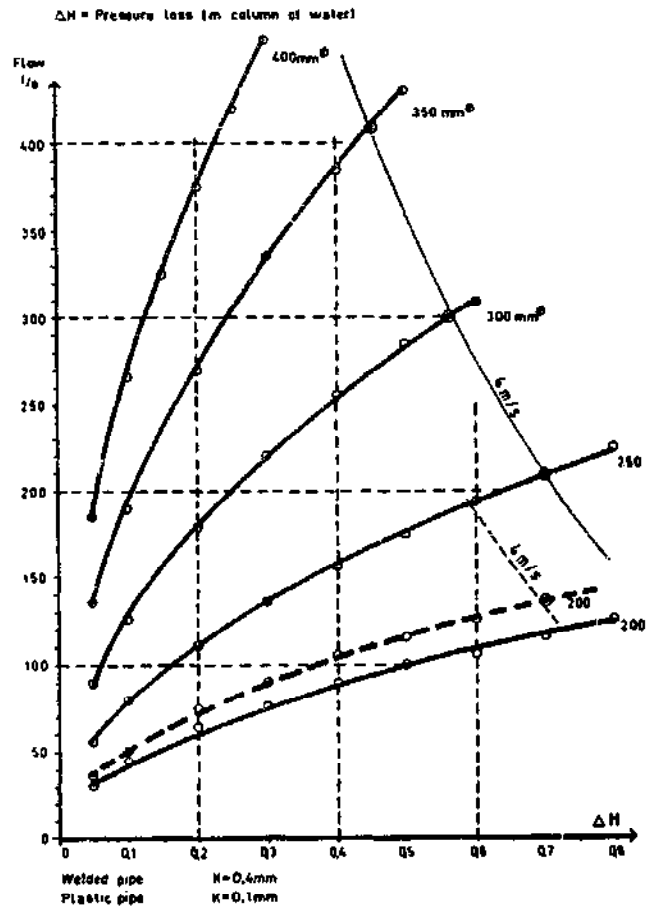
**Fig. 33:**

Air Inlet-Pipe, Main Gate Valve and Bypass-Valve (Nam Dang, Thailand)

Photos by: U. Meier

An important consideration in choosing the penstock diameter is the loss of head - due to friction of water flow - versus cost of the pipe. It is difficult to state a generally applicable rule. Power output required, head and flow available and costs of the pipe are factors that must be investigated in each case. Depending on these, an economic solution is a trade-off between cost and head loss, the latter representing a loss of energy. A general rule often applied is that the flow velocity in the pipe should be well below 4 m/s. The diagram fig. 34 shows the typical relationship between flow rate, the diameter of pipe used and the head-loss (in meters) in a pipe section of 10 m length, made from rolled steel sheet. Values for a  $\varnothing$  200 PE (plastic) pipe are also given, showing that a plastic pipe has smaller losses due to a smoother surface.

Friction in 10 m pipe



**Fig. 34:**

Typical Head Loss in Pipe

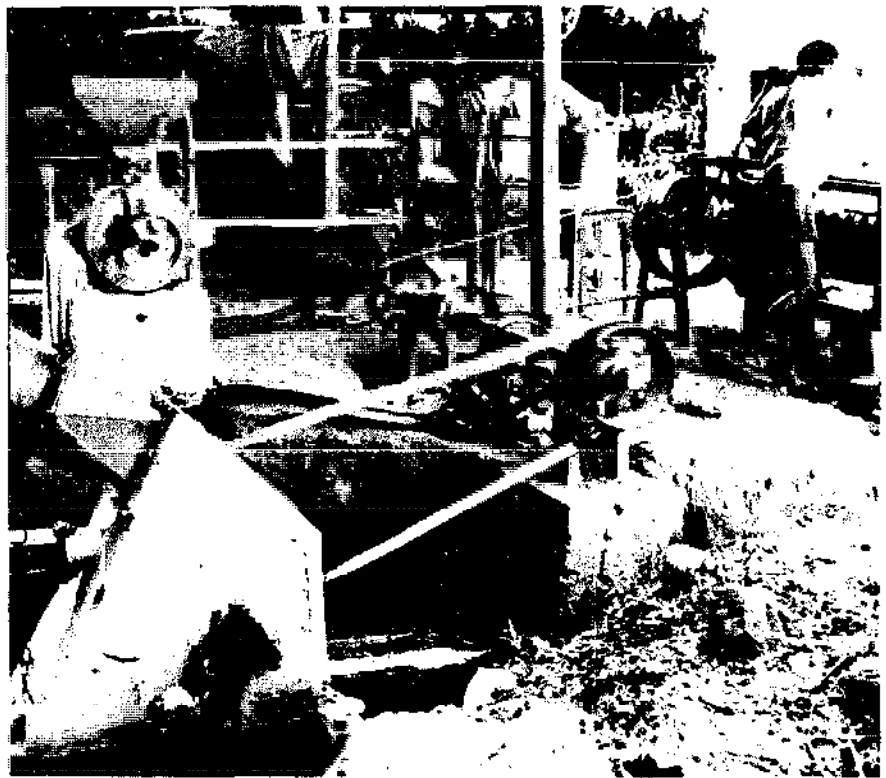
Source: BYS Cross-Flow turbine, Adams 1974

**SPEED TRANSMISSION**

Because of the use of a constant-diameter runner in the Cross-Flow turbines and its use for a big range of heads, it is usually necessary to provide a step-up speed transmission. In the case of mechanical power use, it may be that several machines should be operated. A first transmission step from the turbine to a line shaft is then done using either flat belts or vee-belts with pulleys that give the desired line shaft speed. Two, three or more machines may be operated again with belts with a set of pulleys, one for each machine on the line shaft and one on the machine shaft itself. This is a very simple and conventional technique that is used everywhere. It is fairly efficient if shaft alignment and belt tension is correct and without problems is safety measures - such as providing guard-rails - are taken. Fig. 35 shows a typical turbine-mill, where three machines are operated by flat belts.

**Fig. 35:**  
Sundar Bazaar Turbine-Mill

Photo by: U. Meier



With the heads under which T1 is used, step-up transmission is required in all cases for electricity generation using standard equipment. A step-up ratio of 5 in a single step is relatively simple with standard vee-belt drives. This would be needed for a head of about 9,5 m with T1 and a generator of 1500 RPM, where the largest size would generate over 25 kW. To transmit this power, a multiple belt arrangement is required, using belt-manufacturer's instructions for the design. For lower heads with turbine T1, a two-step transmission would be required with vee-belts, making it somewhat expensive. This may be a reason for selecting the faster speed T3-turbine or, alternatively, another step-up arrangement, such as a chain drive or gearbox.

The latter are quite sophisticated pieces of equipment and therefore costlier than most alternatives. In Nepal, no gear boxes have been used so far mainly for this reason. A chain drive, on the other hand, has been applied in a number of installations. Using Duplex or Triplex roller-chains of standard pitch, sprocket and pinion were made locally from mild steel. It may be considered a cost-effective solution even though a housing with oil-bath lubrication is required (see fig. 36). Initially, there was wear on the mild steel sprocket. This was later made from case-hardened steel.



**Fig. 36:**

20 kW Chain Drive with  
Step-Up Ratio of 4,8 at  
BYS Test-Site

Photo by: U. Meier



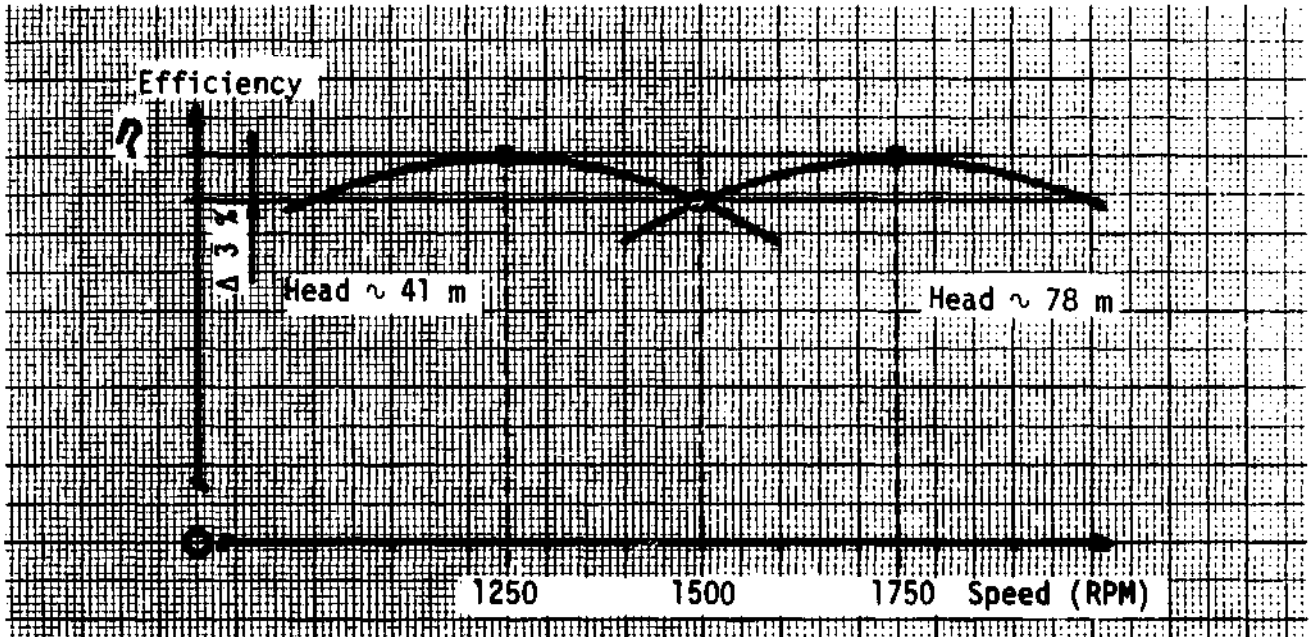
Except in a few cases, vee-belt drives may prove to be the best solution. Belts and multiple-groove pulleys are standardised and mass-produced, making them relatively cheap. In addition, a properly designed vee-belt drive requires little care and is quite efficient and durable. This view is also corroborated for Latin America by OLADE.\*

For turbine T3 it is possible in some cases to couple the turbine directly to the generator. At a head of 58 m, for instance, turbine speed is 1500 RPM, making it ideal for **direct coupling** to standard 1500 RPM (4 pole) generators. Due to a quite flat peak of the efficiency/speed curve of the Cross-Flow turbine, the head range for direct coupling may be extended above and below 58 meters without losing efficiency, since a step-up transmission would also incur losses on the order of 3 to 4 %. Speed of the turbine may be increased or de-

---

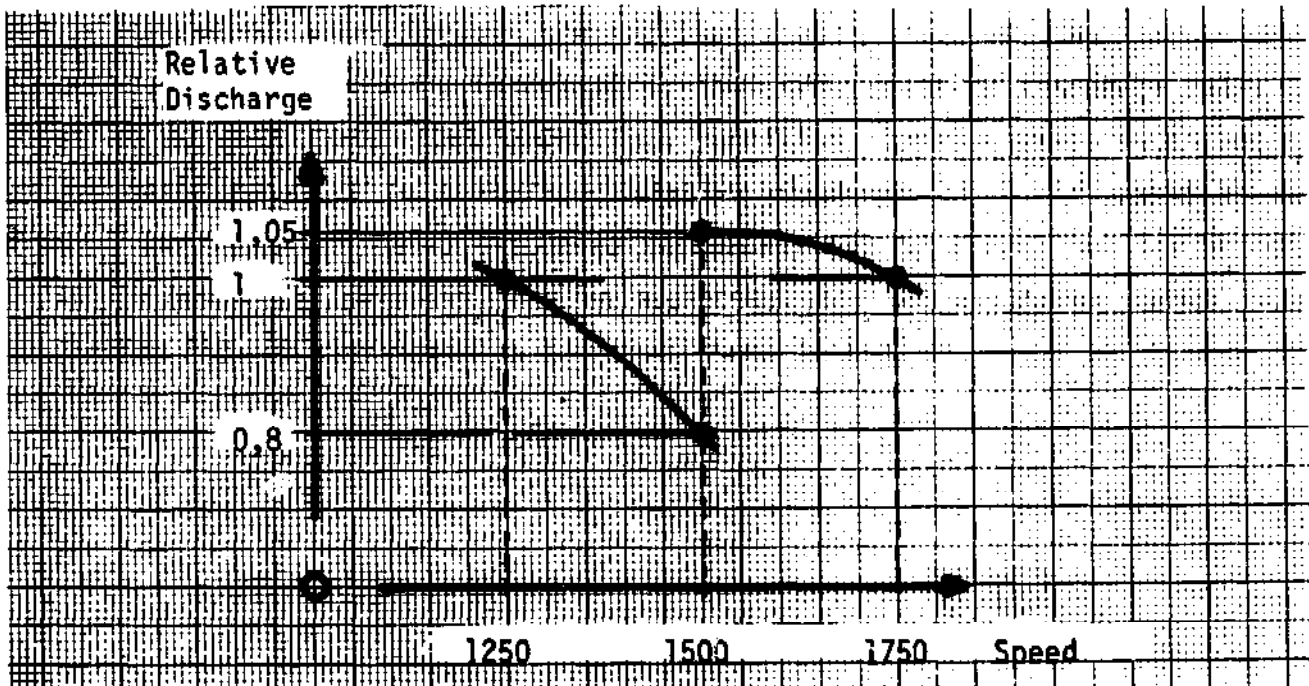
\* personal communication with OLADE

creased to match 1500 RPM in the range from 41 to 78 m head. As fig. 37 shows, this will result in a lower turbine efficiency by about three percent. Since in that case no transmission is required, costs are saved and overall efficiency remains the same.



**Fig. 37:**  
Turbine T3: Efficiency/Speed Curve

Source: adapted from Diploma work H7L Brugg

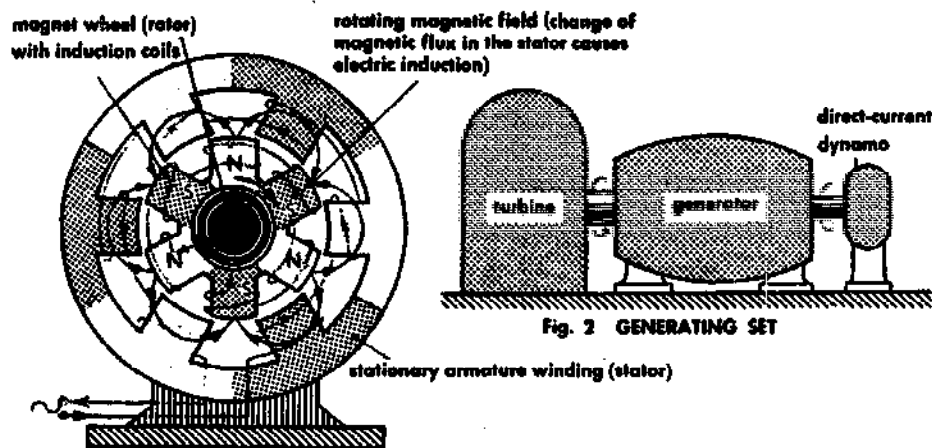


**Fig. 38:**  
Discharge/Speed Curves

The **discharge** of water through the turbine is also affected. The diagram fig. 38 shows that if **speed is increased** to 1500 RPM, **relative discharge falls** by about 20 %. This means that under this condition, turbine inlet width has to be increased by 20 % to achieve a relative discharge of 1. If **speed is decreased** on the other hand, **discharge increases**, but by a much smaller amount. This, for partical purposes, may be neglected. The two discharge curves shown in diagram fig. 38 correspond to the conditions in fig. 37.

### **ELECTRICITY GENERATORS**

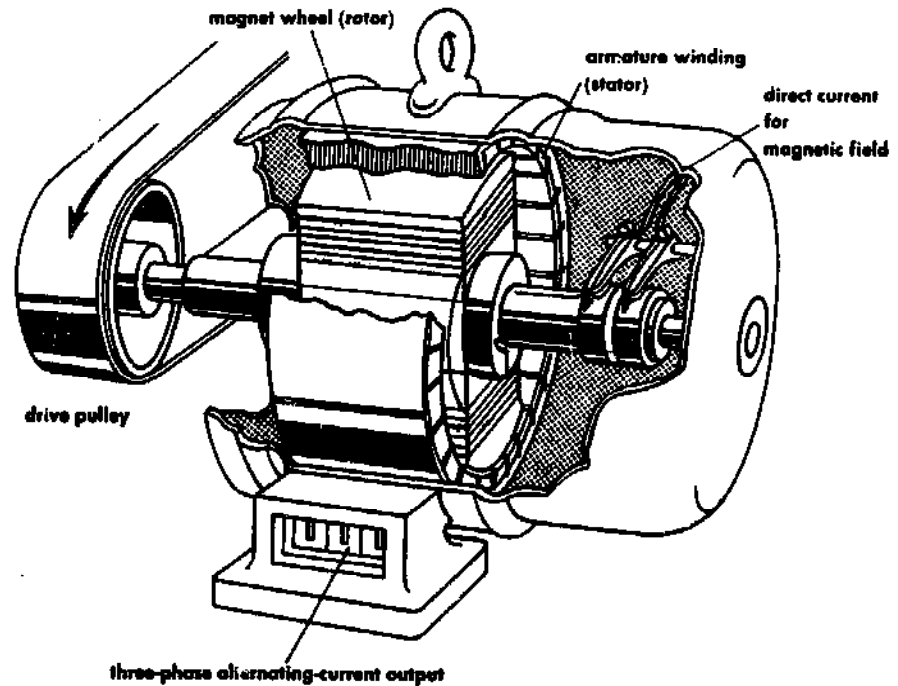
**Generators** are machines used for the production of electrical energy. Their operation is based on the principle of **electrical induction** whereby a periodic flow of electricity is produced in a loop-type conductor as a result of the periodic variation of the flux of the magnetic lines of force passing through this loop. To do this, one can either cause the loop to rotate in a constant magnetic field or, alternatively, the loop can be kept stationary and the magnetic field rotated. In the latter arrangement the **armature** is stationary, and the magnetic poles revolve instead; the stator consists of an iron ring with **induction coils** mounted on the inside; the magnetic poles on the rotor move past the ends of these coils at a very short distance from them (fig. 39 and 40). In this case the current produced by the generator is taken direct from the stator. The relatively low ouptput of direct current needed for producing the rotating magnetic field is fed to the rotor by means of slip-rings



**Fig. 39:**

**Alternating-Current Generator (schematic)**

and carbon or copper-mesh brushes (fig. 40). Fig. 40 shows a smaller generator which likewise operates on the principle described above (rotating magnetic field, stationary armature winding). In this case the magnet wheel is in the form of a two-part T-rotor.<sup>34)</sup>



**Fig. 40:**

Details of a Generator  
(internal pole machine)

Source: (fig. 39 + 40), How  
Things Work, p 65

There are generators that produce **direct current** (DC) but these are used for special applications and low outputs only. In the context of rural electrification they are of limited interest and are therefore not discussed here. Generators producing **alternating current** (AC) are very often called **alternators**. They may be **single phase**, supplying a voltage of 200 to 240 Volts (depending on standard) or more often, **three phase**. Single phase alternators are available in sizes commonly not exceeding 12 kW and may well be used in small installations.

Three-phase alternators are more versatile in relation to electricity end-use. Units in the micro-range produce a voltage of 380 to 440 Volts between phases and of 200 to 240 Volts between any phase and neutral, depending on the standard applied. The "four-wire-system" is required on the distribution side and the load on the three phases must be **balanced** within prescribed limits.

34) Section on Electricity Generators : From How Things Work ..., by arrangement with the publishers

For isolated small hydropower stations the most convenient machine to use is the **self-excited, synchronous 3-phase alternator**. The other type available is the **induction generator** which requires excitation from an existing grid or through batteries. Du to this, it is of limited interest, although it has no need for speed governing in certain cases, and is cheaper than synchronous alternators.

Two types of synchronous alternators are mass produced and therefore relatively cheap. The more conventional type has **slip-rings** and **brushes** trough which **exitation** is provided from a booster-transformer/rectifier, static excitation system. Many bigger developing countries produce this type and it may therefore be available on the regional market. A newer type of alternator is provided with rotating rectifiers directly mounted on the main shaft. Excitation current can be directly supplied to the rotor windings without the need for slip-rings and brushes. Such machines are therefore called **brushless** alternators. It is difficult to select one of the two types on the basis of technical criteria. A brushless alternator requires less maintenance than a slip-ring alternator where brushes need to be replaced periodically. Yet the former is a more sophisticated piece of equipment than the latter. Should any repair be required, it is in most cases easier to work on a slip-ring alternator. Notwithstanding this, the reason to select one or the other type is probably its price and availability.

**Fig. 41:**

Speed of Standard Alternators

No of poles	Speed (RPM)	
	at 50 HZ	at 60 HZ
2	3000	3600
4	1500	1800
6	1000	1200
8	750	900
10	600	720
12	500	600

**Fig. 42:**

Brushless Alternators (2-pole & 4-pole)

Source: Leroy-Somer, France

Output (kW)	alternator type		(kg) weight
	2 pole	4 pole	
4	X		82
"		X	84
12	X		135
"		X	150
20	X		165
"		X	180
40	X		320
"		X	400
56	X		390
"		X	460
100		X	735
160		X	920

There is still another technical aspect that needs looking at: Depending on the number of poles on the rotor, speed at which alternators are to be operated varies. For a given frequency, the higher the number of poles the lower the speed needs to be. More poles imply a greater weight and a larger size; the relationship of these parameters is shown in an exemplary table in fig. 41 and fig. 42.

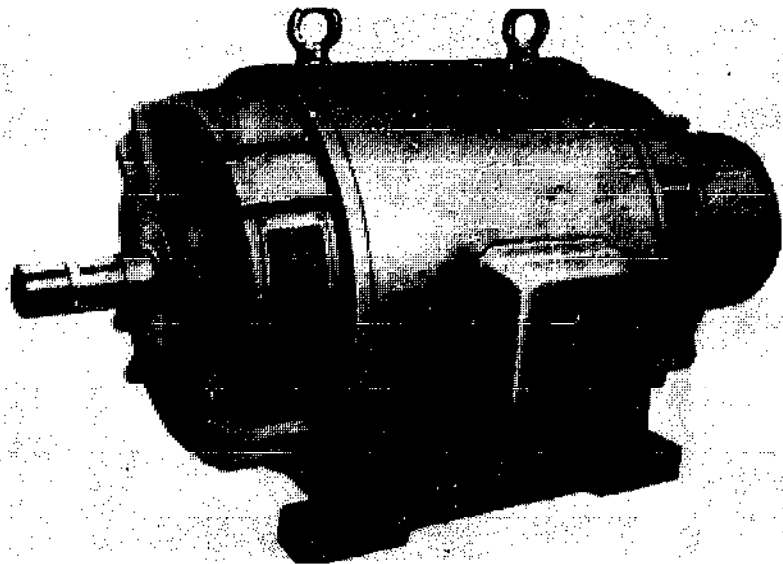
Lower speed alternators in the range up to 160 kW are produced less often, and are obtainable from many manufacturers upon request only, while 2 pole alternators are not available for outputs above 60 kW.

Several manufacturers in the People's Republic of China offer a large range of low-speed alternators in execution with or without brushes, such as shown in fig. 43. These are specially built for use with water turbines and are worth investigating. An address is given in the annexe.

**Fig. 43:**

Low Speed Synchronous  
Alternator

Source: CMEC, Beijing, China



Worldwide, by far the most easily available alternators are 4 pole, running at 1500 RPM for a frequency of 50 HZ. These machines - as most other types - are usually built for operation with thermal prime movers, e.g. diesel sets for small sizes. There is a fundamental difference in run-away speed as compared to water turbines in that a combustion engine for instance may have a runaway speed 20 to 40 % higher than its rated speed under load. For water turbines, this run-away speed is typically 80 % to 100 % higher than the rated speed. If now in a plant in operation the load is suddenly switched off and the speed governor does not react in case of failure, turbine speed and thus generator speed

go up to run-away speed within seconds. An alternator built for a lower permissible run-away speed may then not be able to withstand the higher centrifugal forces - which incidentally increase with the square of speed - and a coil loop on the rotor could be deflected outwards. If it touches the stator, the result would be disastrous and would wreck the machine. Even where this is not happening, increased load on the bearings will shorten the lifetime of the alternator. The only way out is to specifically ask manufacturers to guarantee for a permissible runaway speed above that of the turbine. In the experience of Nepal, most manufacturers seem to be in a position to meet such requirements, often at the same price as for the standard machine.

When selecting an alternator, two more points deserve attention. For one, **standard insulation** is not always suitable for tropical (humid) climate. To be on the safe side, users should specify in what relative humidity an alternator is to be installed. The other point concerns the **elevation above sea level** of an installation and **ambient temperature**. Both affect alternator maximum-output. Usually, manufacturer's output data relate to max. 1000 m elevation and to max. 40° C ambient temperature. Above these values, factors for **derating** must be applied, by multiplying them with the rated output to arrive at the situation specific output. The table fig. 44 shows typical factors which may of course vary with different products.

**Fig. 44:**  
Output Derating Factors

Source: Leroy-Somer, France

Elevation of machine	1000 m	1500 m	2000 m	2500 m	3000 m
factor $f_1$	1.	0.96	0.91	0.87	0.83
Ambient temp. °C	25	45	50	55	60
factor $f_2$	1.07	0.96	0.93	0.91	0.88

Electricity generators are complex machines that require numerous considerations prior to procurement, to make sure that a suitable type is selected. Manufacturers are usually quite ready to supply information either with standard brochures or when specifically asked about the various aspects. It is important to specify all relevant requirements and ask all the relevant questions to arrive at a satisfactory solution. A typical and detailed enquiry then, could look as follows:

- **Specifications:**
  - Type: 3-phase Alternator for use with hydraulic turbine
  - Speed: self-excited, synchronous, with built-in excitation and voltage regulation
  - Voltage: 1500 RPM at 50 cycles (Hz) with a permissible run-away speed of 1.8 rated speed
  - Output: 380/220 Volts, 3 phase
  - Operating situation: 40 kW at power factor 0.8 e.g. 50 KVA continuous operation
  - Mounting mode: 1200 m elevation, 30° C ambient temperature, high humidity
  - Wiring: horizontal shaft, foot mounted, with splash-water protection
  - connectors for 4-wire system
  
- **Manufacturers' information required on:**
  - Mass of inertia and total weight
  - General dimensions of the machine
  - Mounting plan
  - Derating factors applicable
  - Execution with or without brushes
  - Cooling mode
  - Efficiency/load curve
  - Permissible overload
  - Permissible imbalance in phase loading
  - Motor starting capacity
  - Limits of voltage regulation from no-load to full-load
  - Possibility of parallel operation with other generators
  - Maintenance requirements
  - Guarantee period
  - Delivery time
  - Price (CIF & FOB)

Since there are many potential suppliers, it is well worthwhile to send out a number of enquiries, at least initially. Prices and product quality may differ considerably but delivery time and after-sales services may also be important.



In summary, procuring alternators for small hydro-electric projects is not an easy but a time-consuming task and an effort is necessary for a satisfactory solution regarding costs and performance. **Local manufacture** - as for turbines - may seem an attractive possibility in some countries as a new venture in the long run. In the case of Nepal, an evaluation of this possibility was done at one point. The conclusion was - at that time - negative. The lack of necessary component material such as transformer sheets, copper wire and insulating materials, and mainly competition with outside suppliers on a relatively small market and the lack of trained personnel, were the reasons. Based on this, it may be acceptable to conclude that local manufacture of alternators need not be a priority for a new venture in those countries where no production facilities exist yet.

The same applies to **switchgear** and **control instruments**. Such components exist in large varieties and are easily available. To find the right types again requires investigation of the local market. Assembly and wiring in a locally made panel or box is according to electrical engineer's practice. Provided a skilled man is available who knows his job, there is no problem. Usually only basic components are required such as a **main switch** with **relay**, a set of appropriate **fuses**, a **volt-meter** with multi-stage switch to check voltage between different phases, three **ampère-meters** (one for each phase) and finally a **frequency-meter**. Meters for kW, kWh and power factor are convenient but not strictly necessary permanently, and whether or not an under-voltage/over-voltage drop relay is required, depends on the kind of governing applied. Electricity generation, switching, transmission and distribution is a very expansive subject and can hardly be discussed in sufficient detail here. There is a lot of specific and very practical literature available on the subject. Some handbooks have been written specially for the context of rural electrification and these are recommended.<sup>35)</sup>

---

35) 1. Lausselet, Low-Tension Installations  
2. VITA, Rural Electrification  
3. Jackson & Evans in NRECA, Small Hydroelectric Powerplants, p 214 ff. (Refer to alphabetical index for full bibliographical details)

## **SPEED GOVERNORS**

Electric motors and appliances require a stable voltage and frequency. An electric generator, on the other hand, produces such stable voltage and frequency only if it is run at constant speed. A water turbine delivers such constant speed at a given gate opening if the load on its shaft is kept constant. Changing the load, e.g. switching power on and off, results in speed variations which in turn cause variations in voltage and frequency of the electricity produced. To keep such variations within acceptable limits, it is necessary to incorporate a turbine controller, also called a governor. To achieve control, there are chiefly two possibilities that may be applied:

- **load-control**, where the flow of water through the turbine is kept constant and where therefore the load has to be kept constant within tolerable limits. This is achieved today mainly with electronic controllers that switch any part of the load not consumed by the regular circuit into a ballast circuit, thus keeping the total load on the turbine-alternator set constant.
- **flow-control**, where the volume of water flowing through the turbine is adjusted depending on the load on the turbine-generator set.

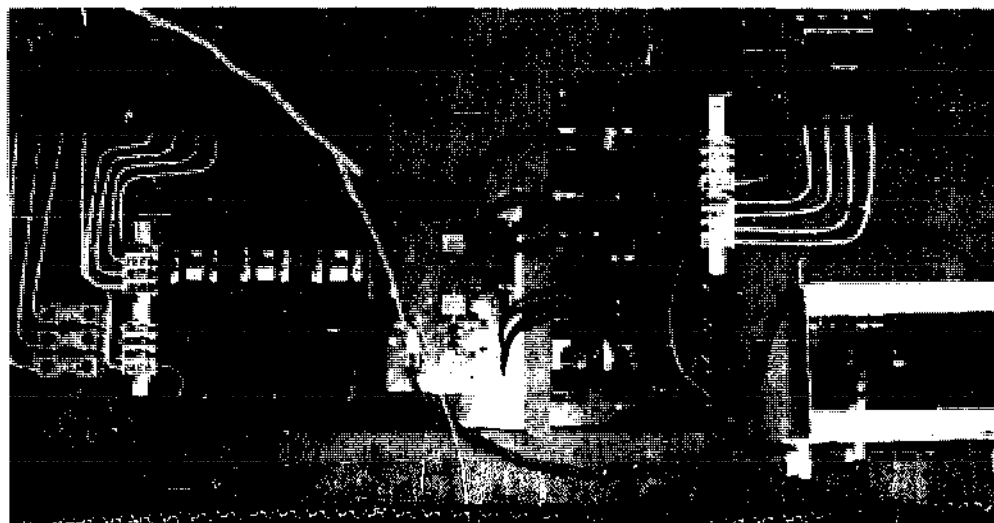
Both systems keep the speed of the turbine within tolerable limits which, in turn, results in a voltage and frequency that remains within a specified range.

In the development of Cross-Flow turbines in Nepal, the question of an appropriate governing device was raised at an early stage. While there exist virtually dozens of designs for flow-control governors, it is not easy to copy one of them. Most are complex and difficult to manufacture for a non-specialised workshop. If imported from one of the major suppliers, they tend to be very costly and more accurate in performance than would really be required in a rural situation. Keeping financial viability in mind, it was decided at an early stage to look for another solution. An electronic load-controller was procured at one stage for a 20 kW three-phase unit. While this type performed well in single-phase application, there was a problem with the three-phase configuration. When phases were not properly balanced, it aggravated the problem by overloading the phase that already had the highest load, on the ballast side.

**Fig. 45:**

Prototype-Assembly of  
Electronic Load-Con-  
troller

Photo by: U. Meier



This experience led to the development of a new type of load-controller based on the principle of **current-sensing** versus **voltage-sensing** that was used on the first device. Research work was carried out at the Swiss Federal Institute of Technology at Lausanne (EPFL) and a prototype was later successfully tested in Nepal. Based on this, efforts are now underway for simplifying the device and to assemble it locally using components from India. This work is being done by BEW with the help of an expert of the Centre for Electronics Design Technology (CEDT), Bangalore, India. Fig. 45 shows the full prototype assembly - for demonstrating purposes on a plane board - including full wiring with fuses and overload switches.\*

At the same time, development work on a simple, **water-hydraulic, mechanical flow-control governor** was undertaken. For this purpose a full-scale Cross-Flow turbine of type T1 was installed in the laboratory of the Swiss Federal Institute of Technology, Zurich (ETHZ), where the Institute for Fluid Technology carried out the work. To keep the device simple, a proportional type was developed and water pressure, under the head of the installation, was to be used as a **working fluid**. Since the water is drawn from the penstock and is discharged continuously through the control valve, there is no need for a pump, resulting in a really simple device which can be manufactured locally. The schematical diagram in fig. 46 shows the components of the governor. Its

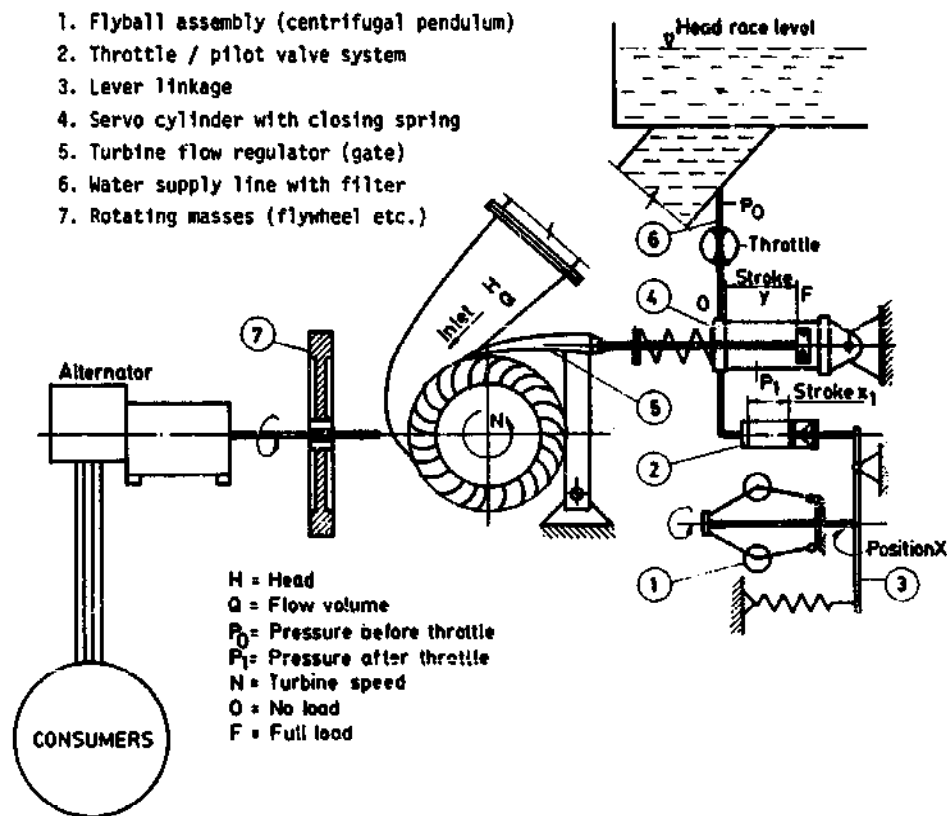
---

\* More information on the electronic load controller developed at EPFL will become available through SKAT.

working principle is chiefly based on a **two-throttle** system and on the principle of a **centrifugal pendulum**: Two throttles mounted in line, the first with a **constant-area orifice** and the second with a **variable discharge area**, create a variable pressure in the line between the two throttles, depending on the discharge area of the variable throttle. The discharge area may be varied by moving a **piston** in axial direction. The centrifugal pendulum (or flyweight) on the other hand, moves a **pushrod** to a certain position depending on speed, if counterbalanced by an appropriate **spring**. If now the flyweight is mounted on the turbine shaft, and is connected via a lever to the piston of the variable throttle (or pilot valve), the variable pressure can be made proportional to the speed of the turbine. A piston, connected to the turbine gate and counterbalanced by a spring, is subjected to the variable pressure and thus, a **turbine gate position is determined by speed**. Since a certain gate opening corresponds to a certain load, speed of the turbine is now determining its loading condition.

**Fig. 46:**  
Schematic of Generating-Set with Mechanical Water-Pressure Governor

Source: Meier, Manual for the Design of a Simple Mechanical Governor

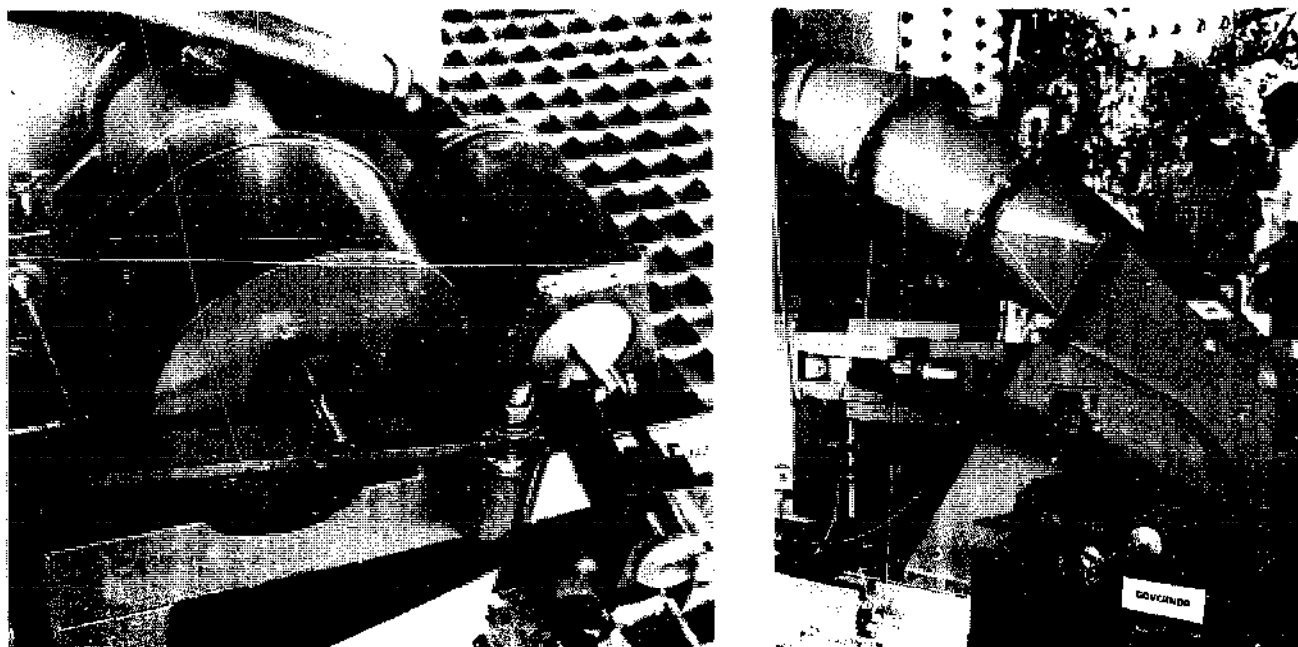


If load is switched off, speed increases, which results in a movement of the flyweight pushrod. This in turn moves the pilot valve piston, which results in a lower pressure on the servo-cylinder piston. The turbine gate in turn closes

until piston force and closing spring are in balance again, thus adjusting the turbine gate to the new situation. In case of switching load on, the reverse happens, and in case of pressure loss in the supply pipe, the gate of the turbine closes completely and shuts the plant down.\*

The system was initially designed for a maximum speed-deviation of  $\pm 10\%$ . After testing of the prototype in Nepal it was found that the governor was stable enough to permit speed regulation within  $\pm 5\%$ , a value that seems better than acceptable in most situations.

The photograph of fig. 47 on the left shows the rotating fly-weight mounted directly on the turbine shaft. The connecting lever with flyweight-spring on the left and connection to the pilot-piston on the right. The picture on the right-hand side shows the turbine with the governor unit in front and the servo-cylinder to the left. Connection between cylinder and pilot valve is by diameter 50 mm PE pipe.



**Fig. 47:**

Prototype of Mechanical Governor Installed at BYS Test-Site

Photo by: U. Meier

\* A more complete description of this governor and design manual is available from SKAT upon request

There are now two relatively cheap governing systems available for application and the question arises as to which should be used for what situation. The answer - as is often the case when there is a choice - is not simple. Both systems, though past the prototype stage, have no substantial performance records to date. The mechanical governor seems suitable for installations with a single turbine. It has the advantage of keeping water that is not strictly required for power generation from running through the turbine. This may be important where excess water from the head-race canal is used for irrigation. A mechanical governor may require much more frequent adjustments and maintenance than an electronic device although the skills required are fewer by far.

An electronic load-controller, on the other hand, is a sophisticated piece of equipment. Still, it is solid state, without moving and wearing parts, and if a breakdown occurs, repair could be attempted by semi-skilled personnel, with plug-in modules and according to a prescribed routine. In addition, it might prove cheaper to use one electronic load controller on a station where two turbine-alternator sets work in parallel, instead of two mechanical governors.

Transfer of technology for both devices described is in principle possible. In the case of the electronic load controller much depends, though, on the state of the local electronics industry. For the mechanical governor, the situation is clearer. Technology involved is simpler and can therefore more easily be documented and transferred. Although the actual design has been done for use on the T1-turbine design, it will be relatively easy to adapt for another design of turbine. For prototype testing purposes, though, some sort of testing-facility must be available. Refinements are possible only empirically, if comprehensive mathematical modelling of the dynamic behaviour is to be avoided.

There are still other solutions possible to the problem of governing: In cases where load fluctuations can be limited, e.g. where changes in load on a plant are small in relation to total output, and relatively infrequent, hand-regulation may be acceptable. An operator on duty would in this case make necessary adjustments on a hand-wheel, as soon as load changes become evident from instrument readings. This simple method is still quite widely used on small plants.

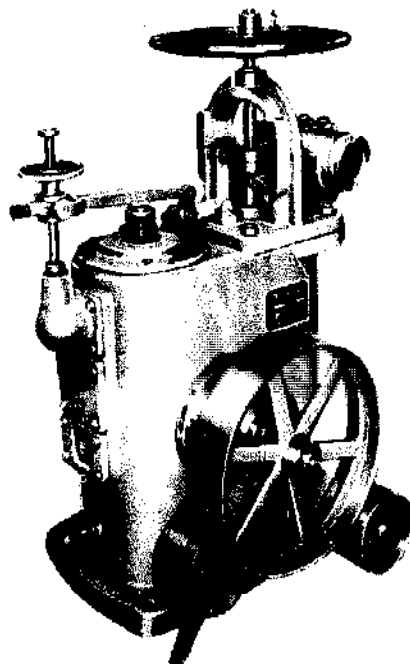
The second possibility is to use an imported governor. Usually, these are pro-

hibitively costly but there is information available of governor-manufacturing in the People's Republic of China. The National Export agency is offering various types of oil-hydraulic, mechanical governors such as shown in fig. 48. At the time of writing, firm prices were not available but costs are reportedly only a fraction of what a governor of this kind from the West would cost. This, may therefore be of interest.

**Fig. 48:**

Oil-Hydraulic, Mechanical Speed Governor from PR China

Source: CMEC Brochure

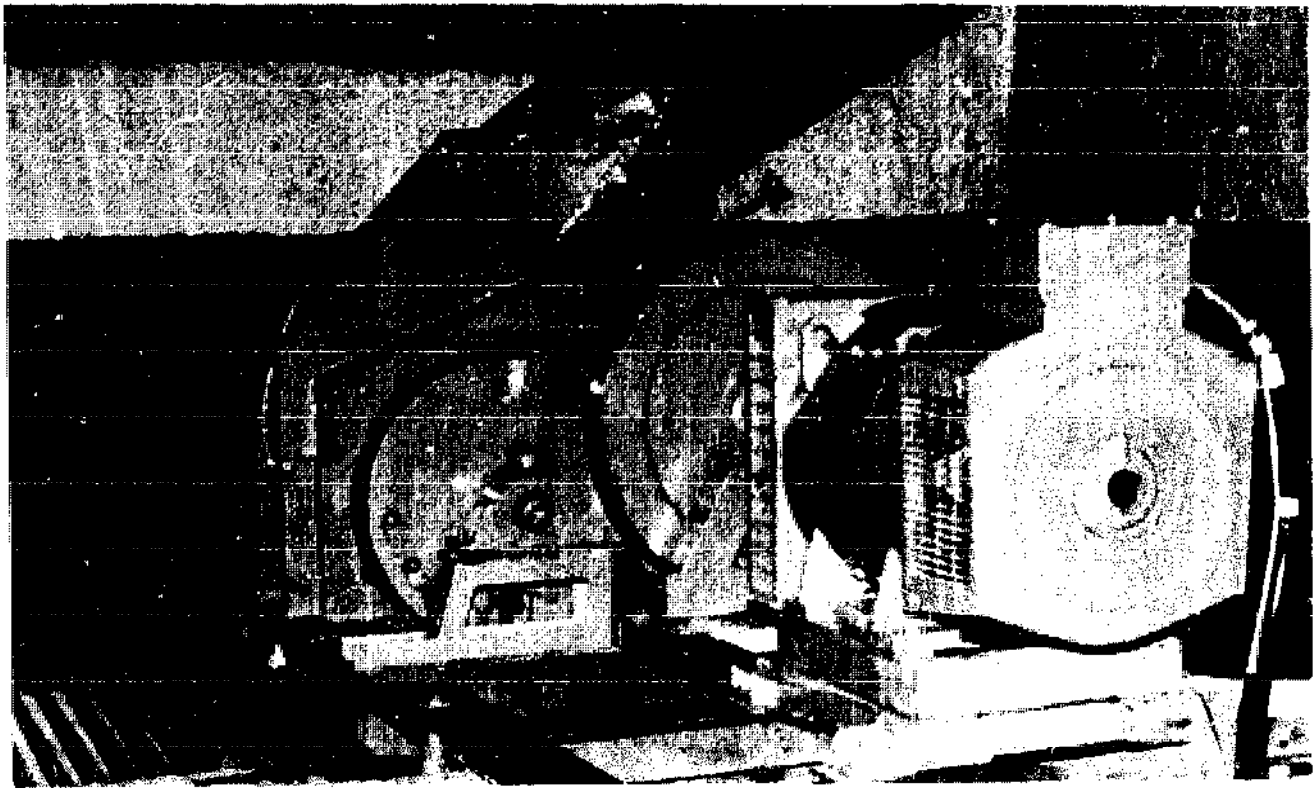


#### **COMPLETE HYDRO-ELECTRIC GENERATING SETS**

A Cross-Flow turbine with adapter and penstock, a step-up transmission, a mechanical governor with flywheel, a coupling, connecting the flywheel to the alternator, and finally the alternator itself, with switchboard and connecting terminals, comprise what is called the complete electro-mechanical generating equipment, necessary for a rural electrification project (refer fig. 49).

All items are bolted to a common base-frame for ease of alignment and the whole set in turn is bolted onto a solid foundation. The flywheel, which has not been discussed so far, may be considered a part of a flow-control governor. Because governor action in case of a load change does not follow instantly, but occurs

at a definite speed, a **transitory state** occurs, during which the turbine speeds up or loses speed depending on the load change. A flywheel, together with all other **rotating masses**, takes up energy in the process of being **accelerated** and so slows down the rate of speed increase. In the case of falling turbine speed, the rotating masses deliver energy due to **deceleration**, thereby trying to maintain speed. Thus, a flywheel serves to "smooth-out" speed deviations in the transitory period immediately following load changes, and gives the governor more time to do its job, while keeping speed deviations within limits.



**Fig. 49:**

**Typical Generating Set Using a BYS Cross-Flow Turbine**

Photo by: U. Meier

- |  |  |
|--|--|
| 1. Turbine                             | 2. Chain-Drive Transmission              |
| 3. Alternator, 20 kW 3 phase, 1500 RPM | 4. Governor (not visible) with Fly-Wheel |

It is easy to understand that the necessary flywheel size is determined by the governor characteristic, by the maximum permissible speed-deviation and by the size of other rotating masses already incorporated in the set. A flywheel has the biggest effect if mounted on the fastest turning shaft available. This will



usually mean mounting it in line with the alternator. From the design point of view, it is important that stresses due to centrifugal forces remain within safe limits. As all other components, the flywheel must withstand run-away speed. For a maximum speed of 2800 RPM, for instance, a max. safe diameter of 750 mm was determined in Nepal for flywheels welded up from mild steel plates. When using the electronic load-controller, it was found that a flywheel is not strictly necessary. Because an electronic device - without moving parts - acts immediately, existing rotating masses of turbine, speed transmission and alternator are sufficiently large to give the system stability.

Other steel-fabricated parts not shown are: A trashrack situated in the forebay in front of the penstock inlet. This serves to keep floating particles such as leaves and wooden sticks from entering. For easy cleaning, it is removable. It must be of strong construction so it can withstand water pressure even if fully covered by leaves. At the same time, spacing of rods must be small enough to retain floating parts (e.g. usually slightly smaller spacing than the distance between runner blades), while the total flow area must be large enough to admit sufficient flow.

For shutting down the plant, a gate-valve is incorporated in the penstock above the turbine inlet, and another valve at the bottom of the forebay is needed to empty it for maintenance work and to flush out sediment. Depending on the situation, another (coarse) trashrack may be required near the canal intake, to keep stones from entering the canal. A simple lifting gate may also permit to empty the canal for maintenance work. At less expense, though, the same can be achieved with simple stop-logs, e.g. a number of wooden planks that fit into slots on both sides of the canal to form a temporary barrier across it.

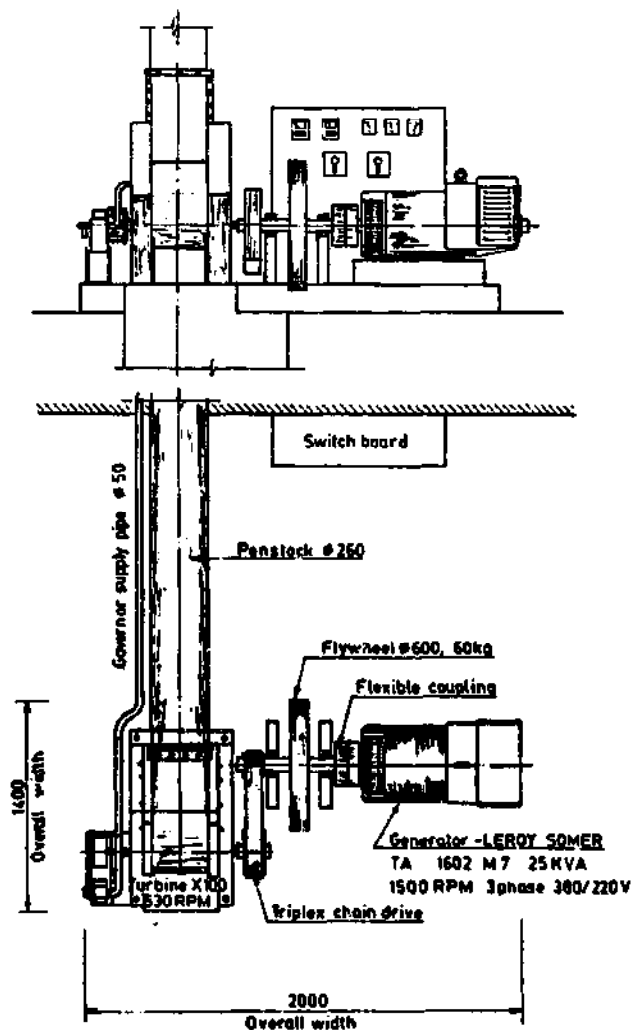
The arrangement of the electro-mechanical equipment is usually perpendicular to the direction of the penstock and will require fairly little space. As indicated in the schematic fig. 50, a 20 kW set would usually require less than  $5 \text{ m}^2$  of area. A power house with a floor area of  $20 \text{ m}^2$  could in fact accommodate two sets conveniently, with sufficient access space on all sides.

Not only the turbine but also all other components of the system incur losses in operation, e.g. their efficiency is smaller than 1 due to hydraulic losses,

mechanical friction, and electro-magnetic losses. Based on the technology described and specific to each situation, efficiencies and losses may realistically be assumed as follows:

**Fig. 50:**  
Schematic Layout of a 20 kW Hydro-Electric Generating Set

Source: BYS, Nepal



**20 KW Installation**  
Hn = 29 m, Q 120 l/s  
Power house floor area = 20m<sup>2</sup>

• **Efficiencies:**

- Turbine	0.65	to	0.75
- Step-up transmission	0.94	to	0.98
- Alternator	0.78	to	0.92
overall efficiency:	0.48	to	0.68

• **Additional losses:**

these occur in all hydraulic conduits, in the operation of a governor and in transmission and distribution of power. Depending on conduit-length and on the length of transmission and distribution networks as the main parameters, they may constitute between 10 to 25 %.

Power available to the user, expressed as a percentage of theoretical generating-potential, is therefore in the range from 36 to 61 %. A highly optimised (imported) turbine might achieve an efficiency of 88 % under ideal conditions, which would supply useful power amounting to a maximum of 71 % of the theoretical value.

### c) Survey and Civil Engineering

In the context of field-surveys and site-identification, it must be stressed that the first problem to be solved is not of a technical but of a social nature. Instead of doing a detailed and precise survey directly, as soon as a site that looks feasible is identified, it should be a priority to get in contact with the local population, village elders and community leaders. It should be made clear in detail, how a small hydropower project might affect their lives and what would be expected from them in terms of participation during all stages of a project, and also of what it would cost them in terms of monthly electricity bills. Only after people have understood the implications, and consider further activities their project, need more detailed investigation work be done.

#### **DETAIL SURVEYS**

To locate an optimal site is a question of the available potential related to the expected power requirements and, further, of how easily the potential may be developed, and also how far the site is away from the consumers to be supplied. In cases where mechanical power use is envisaged, it is also a question of easy accessibility since most likely some goods will have to be transported to and from the site, as for instance in the case of grain milling. A method to arrive at the best choice of site may be to evaluate first the parameters approximately of the site that looks most promising from a purely visual investigation. This serves as a basis for reference. Other sites are then surveyed superficially and the one or two that look best in a comparison are then surveyed in detail.

The type of development in the range of interest and with the equipment referred to will normally be run-of-river, in the low to medium head-range, e.g. an installation where water is supplied through a canal and penstock to a power house that is built near the river bank. On rivers with steep gradients, only

a short canal is required but still better is an abrupt fall in the river. Such conditions usually permit a medium-head development at relatively low cost. The practice adopted in Nepal is not to build permanent dams but only a sort of intake-structure that diverts water to a canal-intake low enough in relation to the water level of the river to guarantee sufficient inflow. One method is to go upstream from the previously identified installation site, up to a point that would give a sufficient head when a horizontal line is sighted along the hill slope towards the site. A team must then walk along this horizontal contour line and also at a higher elevation, along a line parallel to the lower one, to determine whether construction of a canal is possible, and whether head could also be increased from the point of view of canal alignment. The necessary slope of the canal must also be considered at this point and a suitable intake point is then looked for still further up-stream, to permit inclusion of the canal slope. During all stages of surveying, it is important to keep in mind the kind of structures and equipment that are going to be used.

Experience in Nepal shows that it is in fact of little use if a survey is done by a team of competent surveyors who otherwise know nothing of hydropower generation. Utmost accuracy is far less important for small projects than the knowledge of what structural components should best be built at which point. As a rule, a simple engineering-level will be good enough, although where a team does many projects, a theodolite may be justified for greater speed. In areas where local people have a tradition in constructing irrigation canals, it may be found that canal alignment can entirely be left to them. Leveling of head is then also possible without a surveying instrument, by using staffs, a tape, and a spirit level. This simple method is briefly explained in fig. 51. It will permit the establishment of head up to 30 to 40 meters within an error of a few centimeters. Also, it can quite easily be managed by semi-skilled personnel or local people who were trained on the job for a day or so.

The flow available is the other factor that determines theoretical power. A plant that produces energy all year round is desirable and therefore flow-measurements in the dry season are crucial. A few measurements alone of course will not give a meaningful result regarding minimal flow, because it is very often the case that variations in the long term are considerable. Many literature sources suggest that data from the nearest gauging stations, percipita-

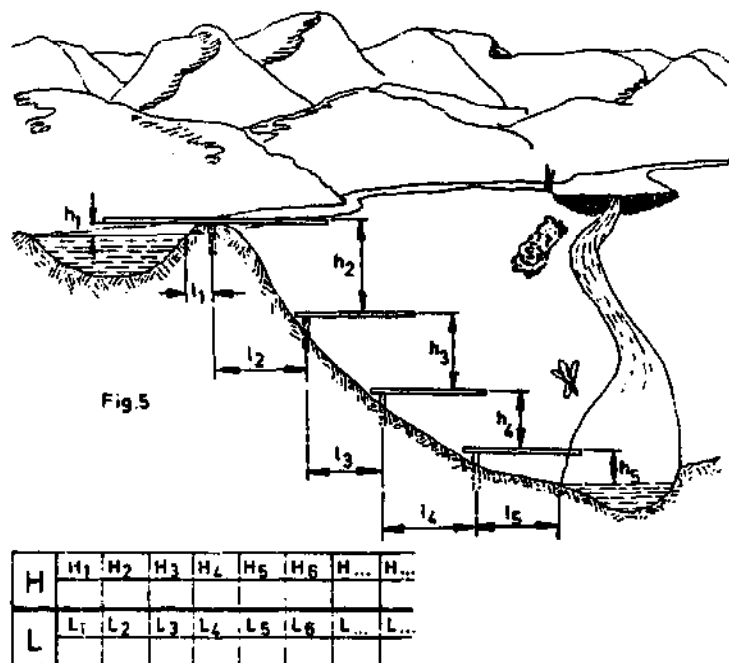
tion, size of drainage area and other climatological data should be correlated with the few data available from the site of interest. For practical purposes this seems not to bear promise in most situations. Data will definitely be lacking for small streams or be insufficiently reliable.

1. Drive in pegs approximately in intervals of the length of the measuring rod used (e.g. 3 metres) in a straight line, according to the planned course of the penstock. All pegs should stand out of the ground in equal heights, if possible.
2. Put on measuring rod and keep it horizontal with the help of a spirit level or plastic pipe filled with water. Now measure the distance from the peg to the measuring rod vertically. Enter values found into the table. Pay attention to signs (+ or -).
3. Measure horizontal distance between pegs while the measuring rod is still kept horizontal. Enter values found ( $l_1, l_2, l_3 \dots$ ) into the table.
4. Gross head  $H$  = Sum of all values  $H$  of plus sign (+) minus sum of all values with negative sign (-).

**Fig. 51:**

Method of leveling head without instrument

Source: BYS, Nepal



Better than doing specialised theoretical work in the office, is perhaps to visit the site several times, do **spot-measurements** and question local people extensively how the present flow relates to their long term experience. Specially people that are used to gravity irrigation - as is often the case - have considerable knowledge of "their" river. The point is to refrain from wishful thinking and to question also the lowest estimate whether it couldn't have been still less. Experience over the last few years in Nepal shows, that failures are unlikely to occur if such a pragmatic procedure is followed seriously. In investigating a site, it is within limits a good practice to develop **maximum head**. This will make the use of less voluminous equipment possible and output will be less affected by flow variations. If the conservatively assumed flow

in the next few years appears to be more favourable, project-expansion will be quite simply possible by adding another turbine and by using larger flow.

A second turbine may be of considerable interest already initially, where flow variations are certain to occur and minimum-discharge is likely to be much smaller during a short period, than average-discharge. If, from the consumption point of view, it is desirable to have more power available during the greater part of the year than the minimum-flow would provide, a single turbine unit may be inappropriate. Since part-load efficiency is lower than the optimum, such a plant would work least efficient at a time when generating potential is already badly affected by low discharge. Two turbines of unequal size - ideally of an output-ratio of 1 : 2 - would in fact provide three optimum efficiency points: one at low flow with only the small turbine in operation, the next at medium flow with only the bigger turbine working, and the last at high flow with both turbines at optimum gate opening and near maximum plant output.<sup>36)</sup>

For measuring river flow, there are various possibilities that are described elsewhere in detail.<sup>37)</sup> Using current-meters or even travel-speed of a float on a straight river section, multiplied with the cross-sectional area of the river, yields an approximate value. More accurate and relatively easily done for a discharge of less than 1 m<sup>3</sup>/s is the weir-method briefly described in fig. 52.

Besides all the worries concerning the minimum-discharge, it is finally also important to investigate the danger of high or even flood-flow, which may have a damaging effect on structures and equipment. It is in this case not necessary to know the discharge-rate but rather to know the highest possible level that the water will reach, in order to be able to place the equipment floor safely above this level. In the absence of statistical data, it is again local inhabitants who can be of help. It is necessary to question them as regards flood occurrences as far back in history as possible.

---

36) Explained in more detail by Gladwell in NRECA, Small Hydroelectric Powerplants, p 53

37) For instance in: - Alward et al., Micro-Hydropower, 1979

- Buchanan & Somers, Discharge Measurement at Gaging Stations, 1969

- Mother Earth News, Cross -Flow Turbine ... p 2 ff.

In case of small streams or channels a temporary measuring weir can be easily erected as indicated. It may be made of strong timber or metal sheet, with the bottom and sides of the rectangular notch bevelled, to a width of about 2 mm. The distance from the bottom of the notch to the downstream water level should be at least 75 mm (3 inches) and sufficient to allow for complete aeration. This weir is let into the stream and made watertight with clay or plastic sheet so that all the water will pass through the rectangular notch. For accurate measurements a stake should be driven into the stream bed about 2 metres upstream, the top of the stake being level with the crest of the weir. The depth of water flowing over the weir can be obtained by measuring the height (h) from the water surface to the top of the stake. The flow may then be calculated from the table below.

**Fig. 52:**

**Flow Measurement with Rectangular Weir**

Source: BYS, Nepal

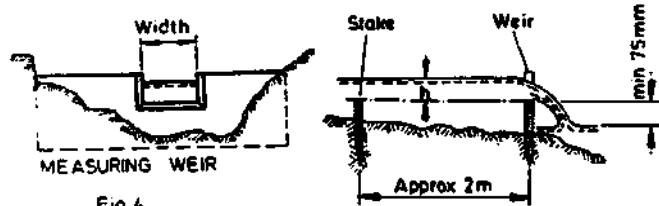


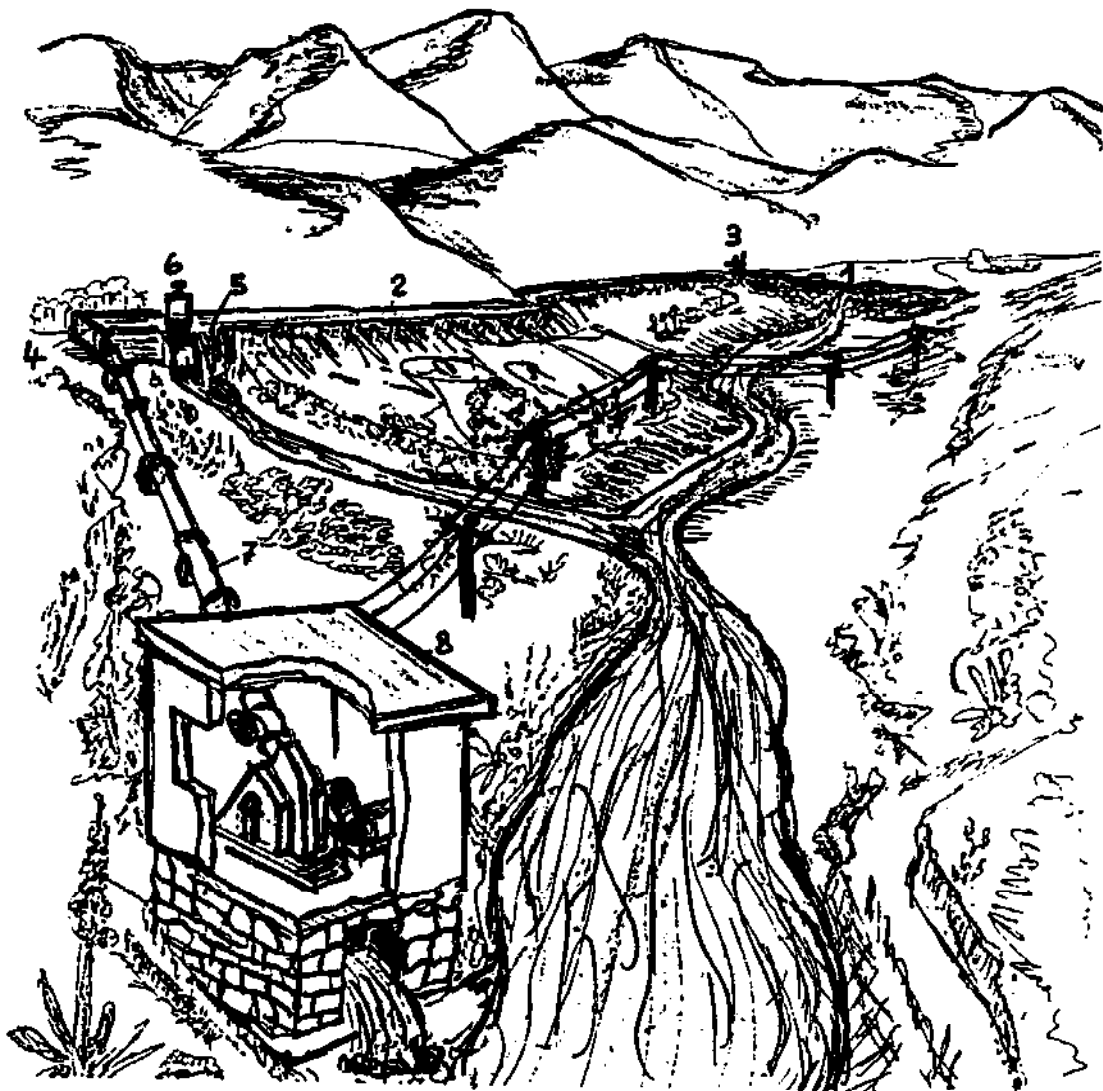
Fig 4

Discharge in liters per second per 10 cm (1dm) width of weir.							
DEPTH h in cm	l/sec	DEPTH h in cm	l/sec	DEPTH h in cm	l/sec	DEPTH h in cm	l/sec
1	0.2	15	10.4	29	27	43	47.4
2	0.5	16	11.4	30	28.4	44	49
3	1.0	17	12.4	31	29.8	45	50.5
4	1.4	18	13.5	32	31.2	46	52.1
5	2	19	14.7	33	32.6	47	53.7
6	2.7	20	15.8	34	34	48	55.3
7	3.4	21	17	35	35.4	49	56.9
8	4.1	22	18.1	36	36.9	50	58.5
9	4.9	23	19.4	37	38.3	51	60.2
10	5.7	24	20.6	38	39.8	52	61.8
11	6.6	25	21.9	39	41.3	53	63.5
12	7.5	26	23.1	40	42.8	54	65.1
13	8.4	27	24.4	41	44.3	55	66.8
14	9.4	28	25.7	42	45.9	56	68.5

**CIVIL ENGINEERING**

Structural works required are probably the greatest variable component of a hydropower project, since the situation of a particular site tends to be quite unique. While structural components may be of the same principle in different projects, their actual design needs to be site specific to make them cost effective, but still safe. For obvious reasons, structures should be kept simple and what is actually needed may be summarised as follows: A diversion dam (1 in fig. 53) - usually partial and of semi-permanent construction - is required to divert water from the river into the head-race canal (2). A simple lifting gate (3) or grooves to accommodate stop-logs is provided at this point to block off water inflow for canal maintenance. The canal may be an unlined earth canal where the amount of seepage and the danger of slides in unstable terrain are minimal. Lining will avoid such problems and it will give the canal a greater

capacity. Flow velocity may be higher in a lined canal as compared to an earth canal, where erosion may be a problem. Lining can be done with stone slabs or with a thin cement mortar. Of much interest would be hydraulically stabilised mud bricks, but there is no experience available that would prove this possible. Lining with plastic sheets, while cheap, has not met with success in



**Fig. 53:**

Structural Components of a Small Run-of-River Project

Source: Adapted from BYS, Nepal

Nepal. Cattle use to walk in the canals and this would puncture plastic sheets badly. A rather interesting technique is reported by Guerrero<sup>38)</sup> and is also used by Las Gaviotas in Colombia. It is to cover canals up to prevent them from damage. This is described in fig. 54.

38) Guerrero, Turbines ..., VITA, Mt. Rainier



Except where water is free from suspended particles, a **sedimentation chamber** should be included. This may be a section of canal near the intake where flow velocity is reduced to much less than 50 cm/s. (depending on the nature of suspended matter), by widening the cross-section and reducing the slope. Sediment can be flushed out periodically if a bottom **discharge-sluice** is provided or it can otherwise be removed manually.

Where the danger of **land-slides** exists, much care should be taken to follow the contour of the hill with the canal and to avoid excessive "shortcuts". This will minimise excavation necessary. Where a slope has to be cut-in considerably, it may be important to make measures at **slope protection** such as driving in stakes, or still better, bio-engineering methods.

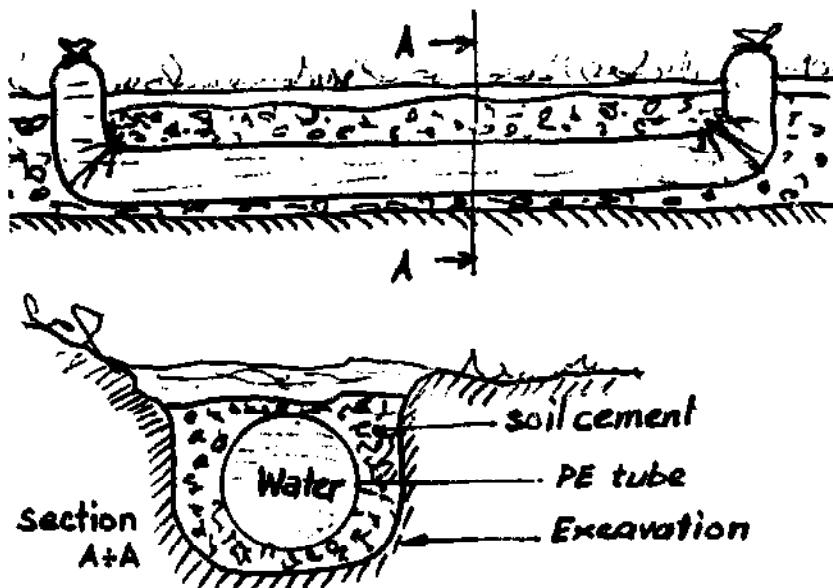
A **forebay** (4) in stone masonry or concrete, is the next structural component. It is situated at the end of the head-race canal and comprises a small basin with a **trash-rack** in front of the penstock inlet, and if necessary a **sandtrap** that has again the job of retaining sand and sediment. The penstock-inlet needs to be submerged 60 to 80 cm below the surface to avoid drawing in air in operation. A **lateral spillway** (5) along the last canal section serves to discharge excess water and keeps the head constant. A **gate** (6), similar in construction to the one in the intake, permits emptying the forebay for cleaning and maintenance. The **penstock** (7), which connects the forebay with the turbine, requires appropriate **anchor-blocks** and supports, for which stone-masonry is a suitable technique. The last item, the powerhouse, which accomodates the electro-mechanical equipment, completes the installation. Good foundations and a lined pit to take care of the **tail-race** water are essential here. Otherwise, the local style will be acceptable in most cases.

In all hydraulic structures where a solid foundation is required or where water pressure has to be retained, the use of **gabions** - wire mesh baskets which are filled with large stones - is a method that deserves attention. Except for the imported galvanized wire, which is commonly used, all material and labour can be entirely local. Complete river training and small dam projects are known to be based on gabion-technology, and their life may well exceed 60 years under normal conditions.<sup>39)</sup>

---

39) See also Stern et al., in *Appropriate Technology*, Vol. 7, No. 4, p 6 ff. and Hiller, B., *Manual Calculation of Check Dams*, p 55

A long thin walled polyethylene bag is filled with water to form a flexible sausage. This is done with the plastic already in place in a large enough excavation on a bed of very lean soil and stone-cement mixture (about 6:1). The pipe is then covered with the same mixture while adding water pressure by raising the ends of the "sausage". The mixture is "vibrated" by treading on the pipe near the place of filling. After completion of one section, and a short while of setting, the water is drained from the pipe and the plastic sheet pulled out while twisting it. An adjacent section may then be started and an inspection shaft be made between two sections. Thus, a "concrete-pipe" is cast in place.



**Fig. 54:**

"In-site" Casting of Head-Race Conduit Pipe

Source: Guerrero,

Appropriate hydraulic structures can by definition not be standardised if they are to be effective and low-cost. In most situations, the share of civil engineering in total project cost is somewhat above 50 % and therefore, effective cost reduction in civil engineering will have a greater impact on overall cost than any other single measure. On the development front today - in the field of small hydropower - there is still a tendency to over-design, and to use too much cement and concrete due to a lack of experience and, often, innovation. Small projects in the micro-range are a very suitable training ground, where experiments and the application of new technologies are possible without unbearable risks. In this sense, small hydropower projects can serve as a basis for local technology development, with a scope for up-scaling to larger pro-

jects.

In design, all structures in contact with water, such as conduits, intakes, spill-ways and basins, require the knowledge of basic hydraulic principles which cannot be explained here. The same is true for questions of soil stability and foundations, where the theory of soil mechanics and foundation technology apply. Some titles worth referring to are from: Jagdish Lal, Grummann, U.S. Bureau of reclamation, Peck\* and Mata.<sup>40)</sup>

## E. PROJECT EXAMPLES

To give the reader some more insight into technological solutions and to help in understanding the uniqueness of each project and the criteria that lead to the final configuration, a few actual small hydropower stations will be described here. None of them can be called "typical" in a strict sense, since all are very situation-specific. Still, there is no doubt that similar solutions - as regards technology involved - have been, and will be, possible in future under different circumstances. It should be noted that all the projects described are of a pilot-character. They are among the first of the kind for the region concerned and are surely not fully optimised regarding cost and technical details. Rather, while still being functional and hopefully economically viable, these projects are of great importance in terms of gaining experience and in building up institutional and individual skills.

### 1. SALLERI-CHIALSA MICRO HYDEL PROJECT, NEPAL

Salleri is a small but lively town and the district headquarters of the Solu Khumbu district in Eastern Nepal. Nearby there is a new village, inhabited by Tibetans who settled in Nepal in the early sixties, named Chialsa. While the people in Sallerie are occupied in government posts, agriculture and trade, the people from Chialsa derive their livelihood mainly from carpet making, because at the higher elevation of Chialsa, only marginal agriculture is possible. The wool used for carpet making has to be dyed prior to weaving. This is done in

\* Refer to Alphabetical Index of Bibliography, annexe I

40) Mata, in NRECA, p 145 ff.

large vats, where the wool-dye and water solution is boiled for hours. The energy source used for this purpose is firewood. Over the last 15 years, this practice resulted in partial deforestation of the area, because in addition to the use of firewood in domestic cooking, about 500 kg of wood were used daily for wool-dyeing. This precarious situation was the starting point to investigate the construction of a small hydropower station. A good project site lies in the steep valey of the Solu Khola, about three kilometers south-west of Chialsa, and 4 km south of Salleri. The Solu Khola is a beautiful snow-fed mountain river. Even in the dry season the minimum runoff exceeds  $2 \text{ m}^3/\text{s}$ . The river has almost no bed load; a rare exception for a Himalayan river of this size.

An almost natural intake exists, but the required canal of 450 m length needed to be cut along a very steep hill slope. Already in the feasibility stage it was realised that this would be the most difficult part. This was proved to be correct. In the monsoon season of 1980, land-slides occurred and major repairs were necessary. Another problem that had to be dealt with is the fact that there exists no road. A porter requires 12 days to reach the site from the nearest roadhead and otherwise only transportation by small aircraft is possible to a landing-strip about 5 km distant. The maximum load of the aircraft available is 540 kg. Porter loads of less than 50 kg and a maximum load around 500 kg for large items had to be considered.

During the feasibility study, several schemes were investigated: The first was a minimum cost scheme in which the same site would have been used but with lower head and flow, to give about 25 kW output. The dyeing operation in Chialsa would then have been moved to the site to avoid costs for electricity transmission. This scheme, while technically easy and economically viable, would have solved the problem of excessive use of firewood. Since it did not include other benefits such as lighting for the handicraft center and residential housing, it was rejected by the local people. A second scheme was to provide electricity to Chialsa, e.g. the village, handicraft center and dyeing section, with a single turbine unit of 40 kW output. People of Chialsa would have been quite happy with this solution but, naturally, people of Salleri and another village between the two, plus political leaders of the area were not very satisfied. They rejected the second scheme and instead strongly supported the third, which was then worked out in detail. The project envisaged finally to supply three villages with electricity, generated in a small hydropower

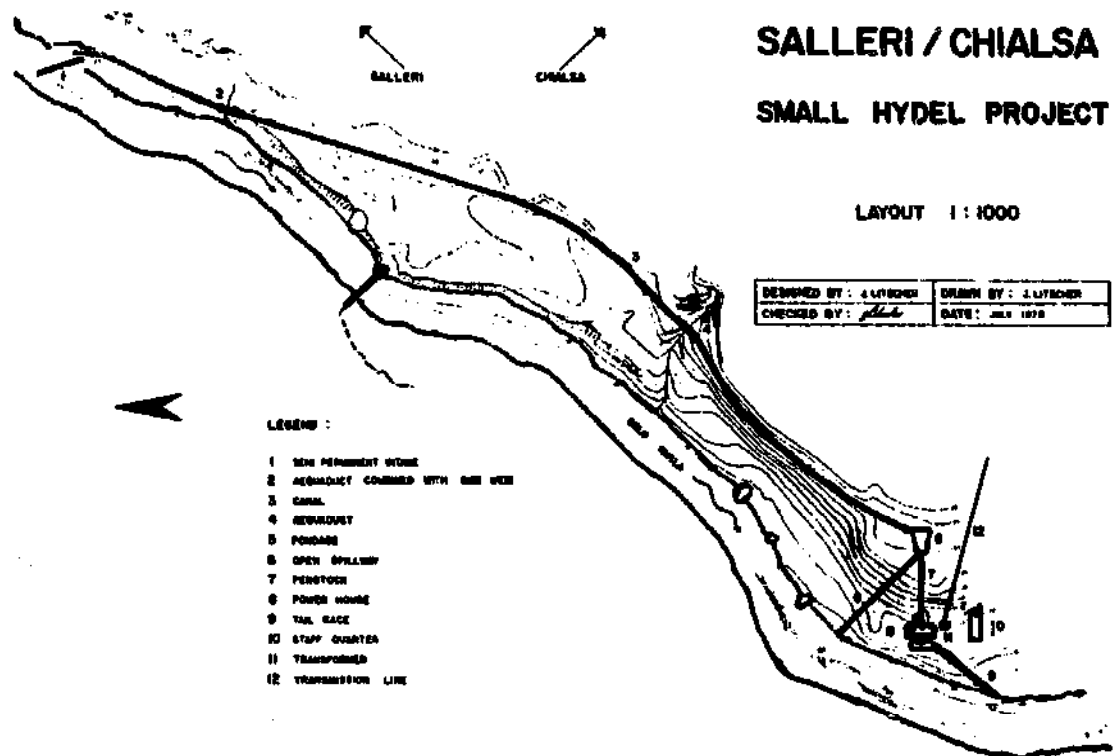
station with an output of 80 kW (electrical).

a) Scheme Details

**SPECIFICATIONS:**

- Installed capacity: (2 turbines) (+ 1 turbine)	1st stage	100 kVA
	2nd stage	150 kVA
- Design discharge:	1st stage	0.9 m <sup>3</sup> /s
	2nd stage	1.35 m <sup>3</sup> /s
- Net head:		15.5 m
- Canal:	length:	450 m
cross-section, trapezoidal		2.0 m <sup>2</sup>
	gradient:	1 ‰
- Penstock:	diameter:	800/600 mm
	length:	40 m
	sheet thickness:	3 mm
- Turbines: 2, Cross-Flow T1-X400 made by BYS, Nepal		47 kW/unit
- Step-up transmission: positive drive belt, UNIROYAL	ratio:	1 : 3.75
- Alternator: 1, 3-phase, 1500 RPM (50 Hz) self excited, synchronous, brushless, with 2 shaft extensions		115 kVA
	voltage:	380/220 V
	french-made:	Leroy Somer
- Speed control: Electronic 3-phase load-controller, EPFL Ballast: Hot water heater		
- H.T. transmission:	length:	7 km
	A.C.S.R. section	25 mm <sup>2</sup>
	voltage	6 kV

The layout in fig. 35 shows the situation at the site with the several structural components schematically. The intake (1) is almost natural and was improved by an arrangement of gabions and, in that way is of a semi-permanent nature. The canal (3), leads through difficult terrain (as mentioned before) and incorporates two aqueducts (2,4) that are needed to cross steep side gullies. Photographs in fig. 56 might give an idea of the difficulties in canal construction. The forebay (5) incorporates a trashrack and a spillway with discharge canal (6), and serves as the inlet to the penstock (7) of diameter 800 mm in the upper section, branching into two pipes of diameter 600 mm. These two branches incorporate one cast-iron gate valve each and lead to the two turbines in the powerhouse (8). Water discharged by the turbines exits through individual outlets and flows back to the river in the tail-race (9). A staff quarter (10) completes the list of structures. A step-up transformer (11) outside the power house is required to transport electricity via the 6 kV transmission line.



**Fig. 55:**  
Situation Plan of Powerplant

Source: Litscher, Small Hydel Development Board Nepal

dividual outlets and flows back to the river in the tail-race (9). A staff quarter (10) completes the list of structures. A step-up transformer (11) outside the power house is required to transport electricity via the 6 kV transmission line.

**Fig. 56:**

Construction of Head-Race Canal Salleri/Chialsa, Nepal

Photos by: J. Litscher



All hydraulic conduits were designed for a discharge of  $1,35 \text{ m}^3/\text{s}$  which will make later addition of another 40 kW possible, by adding another generating set. Towards this end, an extra turbine pit with outlet has also been included in the power-house structure. Connecting a third penstock branch is made possible by flanged/bolted execution of the penstock. For the second stage, one penstock section above the existing branch will have to be exchanged with another branching part. The length of each penstock section is, incidentally, limited to 2 meters to make transportation possible.

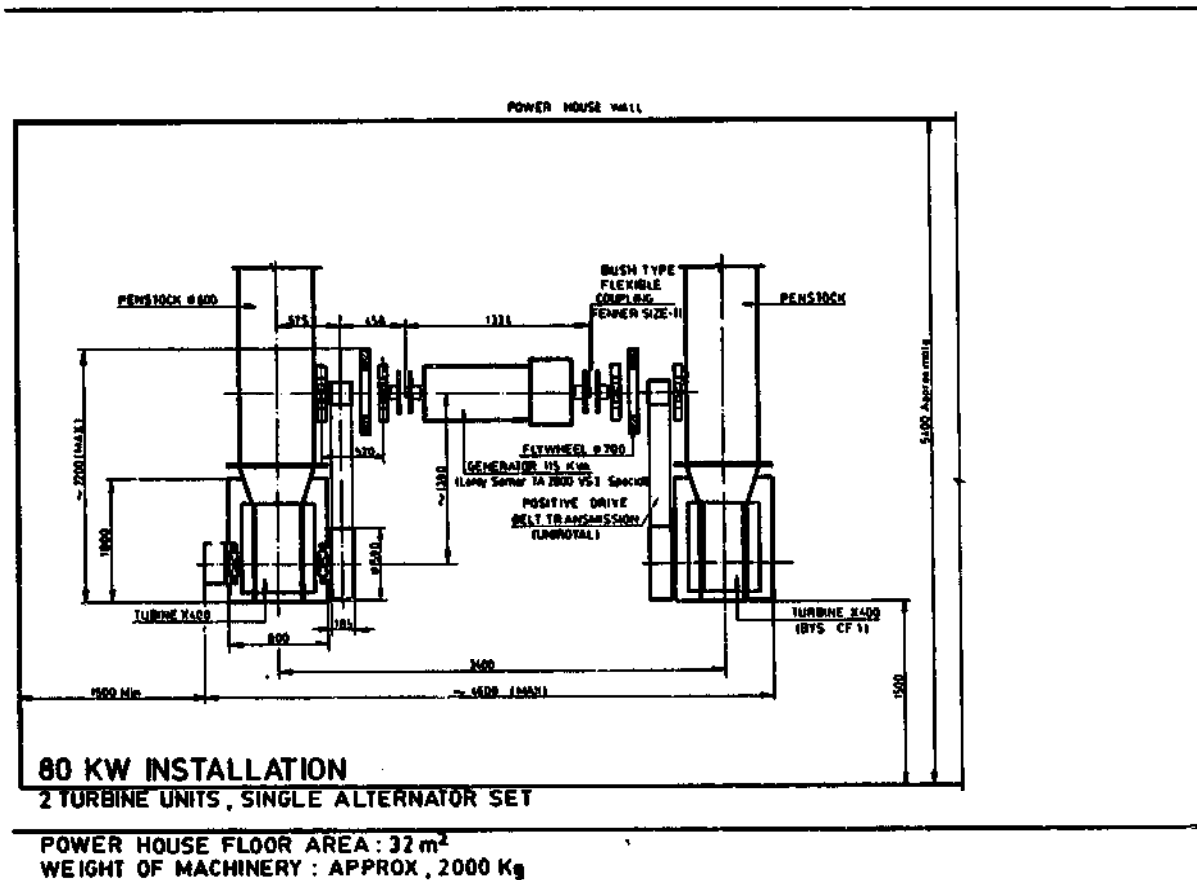
Bearing in mind the great problems and cost of transportation, the use of local construction material to the greatest possible extent was of paramount importance. Specific technologies applied, appropriate to the situation, were:

- semi-permanent intake built with gabions
- canal lining in mud mortar implying a large canal section and a small slope for low flow-velocities (only the most difficult parts of the canal were done in stone lining with cement mortar pointing)
- the power house and staff quarter were done in mud mortar-stone masonry with local slate roofing
- other supporting structures and retaining walls were done with gabions.

These measures made it possible to limit the quantity of cement to 700 bags.

Costs involved are still considerable, since one bag of cement costs NRs. 305.-\* at the site. This includes a transportation charge of NRs. 250.- per bag.<sup>41)</sup>

The generating equipment used comprises two locally made turbines (BYS, T1) that are installed under a net head of 15.5 meters. Both turbines are connected through a speed step-up transmission and a flywheel, shaft and semi-flexible coupling, to a single alternator, with a shaft extending on both ends. The transmission used is a positive-drive belt that needed to be imported. Fig. 57 shows the schematical equipment layout.



**Fig. 57:**  
Generating Equipment Layout Salleri/Chialsa, Nepal

Source: BYS, Nepal

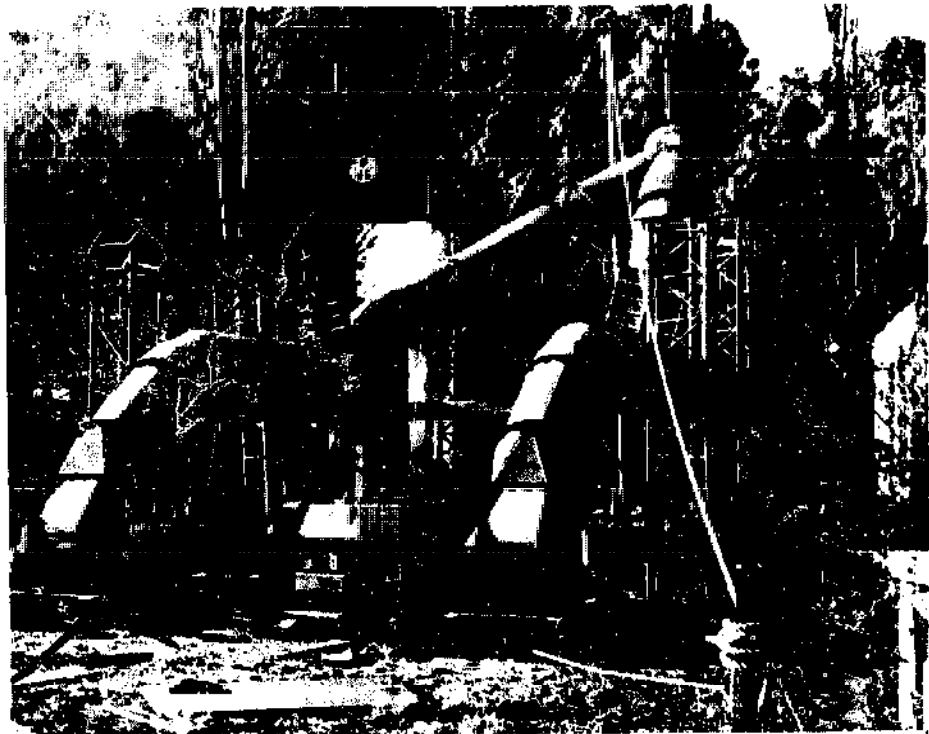
\* NRs. 12.- = U.S.\$ 1.-

41) Information used from Litscher, Salleri/Chialsa ... p 3



The single-generator configuration was chosen to avoid sophistication of parallel operation with two units. Costs were another factor, since 2 generators of 40 kW each, cost more than one piece with a rating of 80 kW. The elevation of the site (approx. 1800 m above sea level) had to be considered for the size of the alternator. With a derating factor of about 0.9, the selected machine of 115 kVA will be capable of producing an output of 80 kW (at a power factor of 0.8) on a continuous basis. For reasons of a minimal transportation weight it was necessary to import a brushless alternator from Europe. The one selected is more than 250 kg lighter compared to a slip-ring alternator offered by manufacturers in India.

Photograph fig. 58, gives an idea of what the equipment with the penstock branches looks like. The picture was taken during trial-assembly in the yard of BYS, Kathmandu.



**Fig. 58:**

Trial-Assembly of  
Generating Equipment  
for Salleri/Chialsa at  
BYS, Nepal

Photo by: A. Arter, BYS

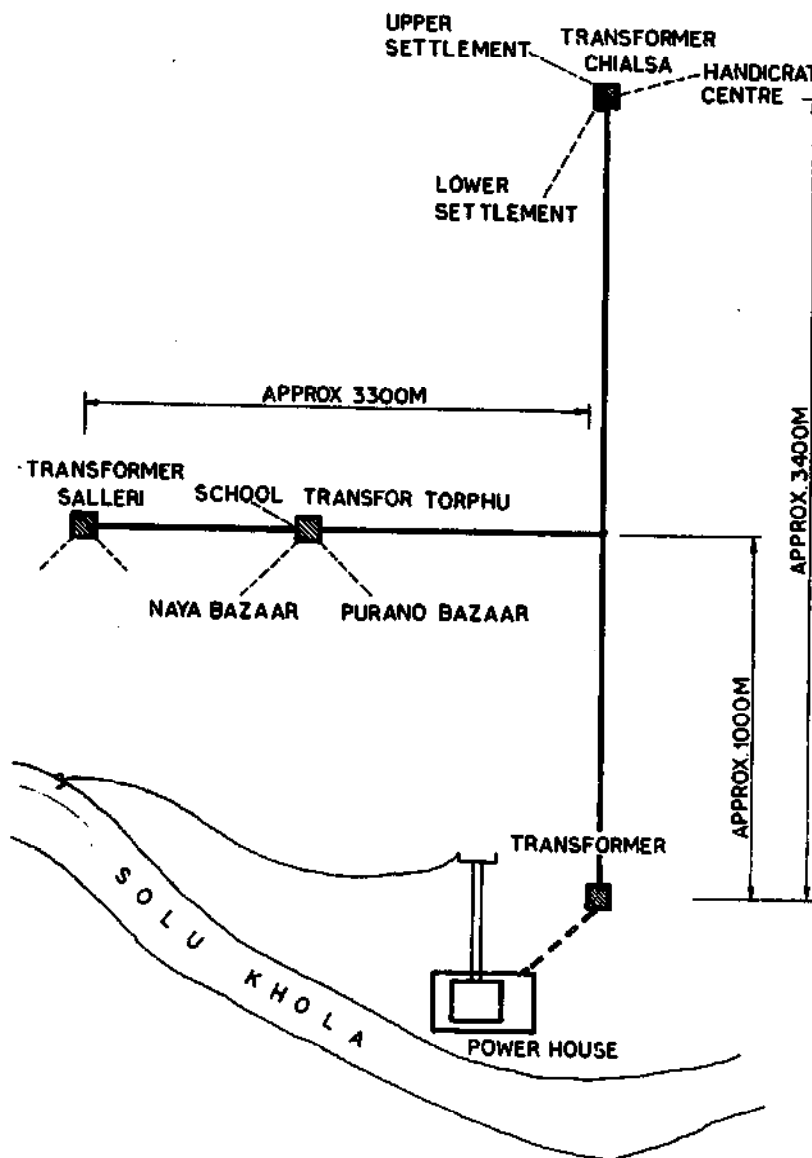
### b) Power Transmission and Use

To bring the electrical energy from the generation site to the consumers requires a high-tension transmission line due to distances involved. The system chosen is of 6 kV, with one step-up transformer outside the powerhouse and

several smaller step-down transformers in the load centers. The length of high-tension line is about 7 km, using local wooden poles of over ten meters length every 50 meters, and over 20 km of steel-reinforced aluminium cable of 25 mm<sup>2</sup> cross section. In addition, some 500 insulators, H.T. fuses, lightning arrestors, earthing sets and a metal cross-arm and top-cap for each pole, are required. The diagram in fig. 59 shows the arrangement of H.T. lines and the approximate position of transformers. The line goes straight up to Chialsa with a branch to the north connecting the two villages of Salleri and Torphu. Several main distribution lines of 3-phase, 380 Volt are required in the various villages that have approximately equal length, except for the Chialsa Handicraft-Center which is very close to the transformer because its load is by far

**Fig. 59:**  
Schematic of H.T. Transmission Salleri/Chialsa, Nepal

Source: Meier et al.,  
Project Proposal,  
Kathmandu 1976



the largest. In all, about 8000 meters of steel-reinforced conductors are needed for 3-phase (4-wire system) overhead distribution lines and over 4000 meters of insulated 2-core cable for single-phase lines, with which about 250 individual consumers are connected.

The largest single electricity consumer will be the dyeing section of the Chialsa Handicraft Center, where dyeing pots are to be equipped with electric heating elements amounting to 24 kW, which will be required during 10 to 12 hours daily. For the rest, at least initially, no other electricity use but for lighting in individual households, offices and main streets, will exist. With an average of 120 W installed for each individual consumer and 1 to 2 kW each for the various schools, other public houses and street lighting, the installed load will amount to approximately 40 kW, bringing the installed total to about 64 kW. Lighting, naturally, will be required for a few hours only every day, so that even with a good load on the part of the dyeing section, the average overall plant utilisation factor may be as low as 20 %. This is an unsatisfactory situation since the amount of saleable energy will be relatively small in relation to the investment costs. It will therefore be a very important task to promote power use in the initial phase of operation.

### c) Implementation and Present State

The implementation of the hydropower project at Salleri/Chialsa met with quite a number of problems. An initial survey was carried out by personnel of SATA\* and the turbine manufacturing company BYS. In the absence of a capable local organisation to implement the project, SATA could have done the job with expatriate experts. However, this would not have made local institution-building possible. The idea was to assist a local organisation in executing the project, so that this body would gain relevant experience and train their own personnel for future activities in this field. Some time later, the Electricity Department of HMG\*\* created an agency named SHDB\*\*\*, with the task of taking care of small hydro electric power development, and SATA chose this partner to work on the Salleri/Chialsa project, and also provided an expatriate engineer, assigned

---

\* Swiss Association for Technical Assistance

\*\* His Majesty's Government of Nepal

\*\*\* Small Hydel Development Board

to the project. It was a very difficult job for SHDB to establish itself, execute the first project, and get busy with the design of new projects, virtually all at the same time. Delays were inescapable and the far away site at Salleri caused additional problems of logistics. To cite but one example, cement ordered for the project, took one year to arrive at the site.

The state today is that the project is not operational yet. As earlier mentioned, major repairs are necessary on the most difficult section of the canal, which was damaged by land-slides during the last rainy season. The installation of the generating equipment and electrical equipment are in progress only now, and as of this writing (may 1981), a number of problems as regards ownership, staffing, operation and administration of the hydropower station remain to be solved. As a concluding remark, one may perhaps state that the project - while it may succeed finally, if due attention is paid to open questions - is a difficult one to start with, for reasons of its pilot character, remoteness, and technical difficulties. Still, if experience gained is fully used in the planning, designing, and executing of new projects, many of the problems can be avoided in future. It is perhaps useful to list some of the points to which, evidently, more very careful attention has to be paid:<sup>42)</sup>

- Size of the plant in relation to energy requirements and also technical feasibility on the construction side.
- The need for effective load promotion to achieve a higher load factor, while avoiding load peaks of short duration.
- Avoidance of over-staffing by outside personnel who are relatively highly paid, resulting in high operation costs.
- Obtaining more participation of the local people during the construction period and possibly in ownership and administration/operation.

#### d) Investment Costs

The total investment cost for the project is expected to reach NRs. 2.9 million\* including H.T. transmission, low tension distribution and house connections. This is relatively high and due largely to high transportation costs and difficult canal construction. Inflation during the construction period of more than 4 years has also played a role. For transportation alone some NRs. 400'000\*\*

42) Material used from Krayenbühl & Ledergerber, SHDB: Program Evaluation ...

\* adjusted for inflation in the last construction phase

\*\* estimate

will have been spent once construction is finished. This would amount to more than 13 % of total cost.

The rough breakdown of costs, itemised for the various components of the system, is as per fig. 60:

**Fig. 60:**

**Cost Breakdown of Salleri/  
Chialsa Project, Nepal**

Source: Updated from:  
- Litscher & Meier

Item:	% of total	U.S. \$
All civil engineering	36	87'000
Generating equipment and penstock	16	38'700
H.T. transmission	25	60'400
L.T. distribution	19	45'900
Supervision and Miscellaneous	4	9'700
<b>Total</b>	<b>100</b>	<b>241'700</b>
Cost w/o H.T. & L.T. network		\$ 1'640.--/kW
Cost all inclusive		\$ 3'021.--/kW

**2. BHORLETAR TURBINE IRRIGATION PROJECT, NEPAL**

This project, for which a feasibility study was done jointly by the Agricultural Development Bank, Nepal (ADB/N) and the turbine manufacturing company BYS, is of quite a different nature as compared to "standard" rural electrification projects. It was financed by ADB/N on commercial terms as one component in a package of measures, and executed jointly by the local people, ADB/N and BYS. As an introduction, passages from the project proposal report<sup>43)</sup> are printed here:

The project area is located at Bhorletar and Aarikosi village panchayat in Lamjung district in Western Nepal. The Midim Khola, with perennial water flow, separates the two villages. The area is roughly 20 km from the nearest road head e.g. only accessible on foot in a 4 to 5 hours walk. This, for Nepal, is

43) ADB/N, Lift Irrigation Project for the Development ...

a very favourable access situation.

At present irrigation facilities are limited to some areas in Karaputar permitting two or more crops a year, whereas a major part of the land at Borletar and Bhatbeshi has no access to irrigation facilities. As such, hardly a single crop is grown in these areas i.e., paddy under the coverage of monsoon rains. Crop productivity is presently very low.

Paddy and maize are the principal crops in the area followed by wheat, mustard and potato.

An increase in crop production and productivity of land is envisaged with the provision of irrigation and other supporting services under the proposed project.

Out of a total population of 3000, the project envisages to benefit about 100 households directly comprising 500 to 600 people. The project aims to provide a complete **technological package** of services and institutional support to the farming community of Borletar area for **intensive agricultural development**, mainly based on the development and installation of an effective irrigation system. Other activities which are identified feasible and therefore incorporated in this proposal include: crop-production, agro-processing facilities, credit and agri-inputs, distribution and marketing arrangements for farm produce. A second project stage envisages electricity supply to the nearby bazaar for lighting and electric power supply for running a small cottage industry.

The first project phase comprises the following integrated activities:

- Development and installation of lift irrigation facilities to cover a command area of about 50 hectares of land, 25 hectares each at Borletar and Bhatbeshitar areas. This will involve the following components:
  - The water of Midim'Khola will be diverted to a 4000 meter long 1.2 m x 0.5 m headrace canal to channel 570 to 630 l/s flow to two sets of water turbines via a 40 cm diameter penstock pipe.
  - Two sets of water turbines capable of generating a total of about 70 to 80 kilowatts of power output (35 to 40 kW output each) will be installed under the roof of a permanent power-house. Both the water turbines will be purely mechanical-power generating units, which will be used to lift water up to the head of 22 meters at Borletar and 42 meters at Bhatbeshitar.

The first turbine will be used to drive two units of water pumps (17 l/s capacity and consuming about 13 kW power each) which will lift up about 30 l/s of water to Bhatbeshitar area through a conveying canal, to irrigate about 25 hectares.

Similarly, the second turbine will be used to drive another two units of pumps in order to supply 30 l/s flow of water to Bhorletar to irrigate another 25 ha of land. The water supply pipes will be carried across from the power house to the newly constructed suspension bridge over Midim Khola to a height of 22 meters at Bhorletar irrigation command area.

Field channels will be constructed to convey irrigation water from the point of main supply to the farmers fields located both in the Bhorletar and Bhatbeshitar area.

- The establishment of an agro-processing unit is proposed to provide milling and processing facilities to the farmers of the project area in view of the expected increase in agricultural production. A paddy huller, a flour grinding unit and a small oil-expeller will be installed within the power house. The estimated power consumption will be about 10 kW when all three processing units are operated at a time. The mechanical power required for running these agro-processing units shall be directly supplied through either of the two sets of water turbines via belt drives.
- A storage building having a capacity of 100 metric tons will be constructed at a suitable site nearby the turbine and mill house. Locally available materials such as stones and river boulders will be used for most of the construction works.
- A Bank-guided co-operative society would be registered and established in the project area. A technical officer with a degree in Agriculture would be assigned by the Bank as a manager of the society. The cooperative would provide management and operational guidance to all project activities. It would also provide agricultural inputs, including production credit and other credit requirements for operating cottage industries. The co-operative will also arrange marketing of agricultural production of the farmers.

#### a) Organisation and Management

To execute the project, a Co-operative Society is proposed to be set up in the project area. The Co-operative Society will be governed by the Board of Directors. The manager will be assigned from the Bank and the management supervision of the Co-operative Society will be done by ADB/N up to the period of the loan. During this period, ADB/N would help the farmers to build up their own

management skill. When the loan amount is fully recovered and effective operation of the project is ensured, the Bank will hand-over the management of the project to the farmers.

Besides the Board of Directors, a project implementation committee is envisaged. The committee will function as an advisory unit to the Board on operations relating to project implementation. The committee will consist of 3 progressive farmers and 2 group leaders. The latter will be elected by/among the farmers.

Balaju Yantra Sala (BYS) will be responsible for manufacturing, fabricating and installation of the irrigation and agro-processing system. YYS will manufacture the water turbine and generating equipment and will install the complete system including the agro-processing unit and then hand-over to the Co-operative Society. Construction of canals, forebay basin and pump/turbine house will be completed by the joint effort of the Co-operative Society and the farmers under the technical supervision of YYS and ADB/N.

On the operational level an effective water-distribution system would ensure optimum utilization of irrigation water. For this purpose, within the two farmers groups to be organized, specific water-users groups comprising several sub-groups will be established. Their function will be:

- To ensure equitable supply and distribution of irrigation water to member farmers.
- To arrange distribution of water to its members as per water distribution schedule worked out in consultation with all farmers within the group.
- To initiate the member farmers to level and improve their land structure and construction of water distribution channels so as to have optimum water utilization and minimize water losses.
- To promote cooperation among members sharing irrigation water and other inputs and to encourage the farmers for the adoption of improved farming methods.
- To help the Co-operative Society realise its loan installments and irrigation water charge from the member farmers.
- To settle disputes among member farmers in the utilization and distribution of irrigation water.
- To promote other activities related with irrigation and agricultural development within the groups.

The main canal will be constructed through joint efforts of the farmers groups whereas sub-channels will be constructed by the participating farmers them-



selves. Proper operation and maintenance of the turbine, main canal, agro-processing machinery and pumps etc. will be carried out by the mechanical section of the Co-operative Society, aided by staff from BYS where necessary.

### b) Benefits

The project benefits envisaged may be summarised as follows:

- The project would benefit about 100 farm families of Bhorletar and Bhatbesitar by irrigating 50 hectares of "tar"\* areas.
- It will provide permanent employment for 11 persons and would generate additional employment to about 100 farm families at the full development of the project.
- It would provide easy access to processing of foodgrains by providing processing facilities to the farmers of Bhorletar, Bhatbesitar, Karaputar and other nearby villages.
- The project will help to utilise the water resource of Midim Kholā to generate power to render irrigation and processing facilities to adjoining areas.
- Provision of storage facilities would improve distribution of agri-inputs, minimize losses and facilitate marketing of farm outputs.
- The crop production would increase from the existing level of 456 metric tons to 752 metric tons at the full development stage (5th year onwards).
- Expected implementation of the project activities set for phase 2 would benefit the local community from the proposed supply of electric power to Karaputar Bazaar and the extension of irrigation facilities to Bhorletar and Kainbote areas.

So far the project proposal! What one may note that is different from other hydropower projects, are the following points:

- Rather than rural electrification per se, the project is based on other criteria, namely increased agricultural production.
- The development of hydropower is only a means to achieve a much broader goal, e.g. integrated rural development.
- Local participation has not been included as a theoretical requirement but is in fact a decisive factor in the implementation of the project.
- The project had to be viable from its inception in terms of qualifying for loans from a bank.
- The bank involved, on the other hand, realised after studying the local situation, what additional inputs would be required from their side and consequently included these in the proposal.
- By the development of a hydropower resource for a specific productive use, a second project stage that provides for the amenity of electric light must not be economically self-supporting, but can be done as a social measure.

---

\* tar = high plateau

### c) Project Execution

During project execution it became clear that many of the problems occurring elsewhere did not exist, largely due to the **integrated approach** and the **ultimate goal** of the project. The scheme was understood and supported by local people from its inception. A farmer naturally knows what access to irrigation water all through the year means in an area where even a single rainfed crop sometimes fails due to the lack of rain. In fact, it was the local people who pushed the project all along; even though at several stages they lost courage for a while, when technical and administrative problems came up. Local participation was strong. At one point, the womenfolk of the area declared that they would take care of all material transportation. And so they did without much fuss. Cement, equipment parts, penstock and irrigation pipes were all carried on womens' back to the project site.

The men, meanwhile, were working on canal excavation and power-house construction. There were delays and difficulties largely due to the fact that, for all parties involved, it was the first time that a project on this scale was taken up. Today, the project is in operation; still in an early phase though, with agricultural production slowly developing. This was anticipated in the requirements of loan repayment with a sufficiently long grace period.

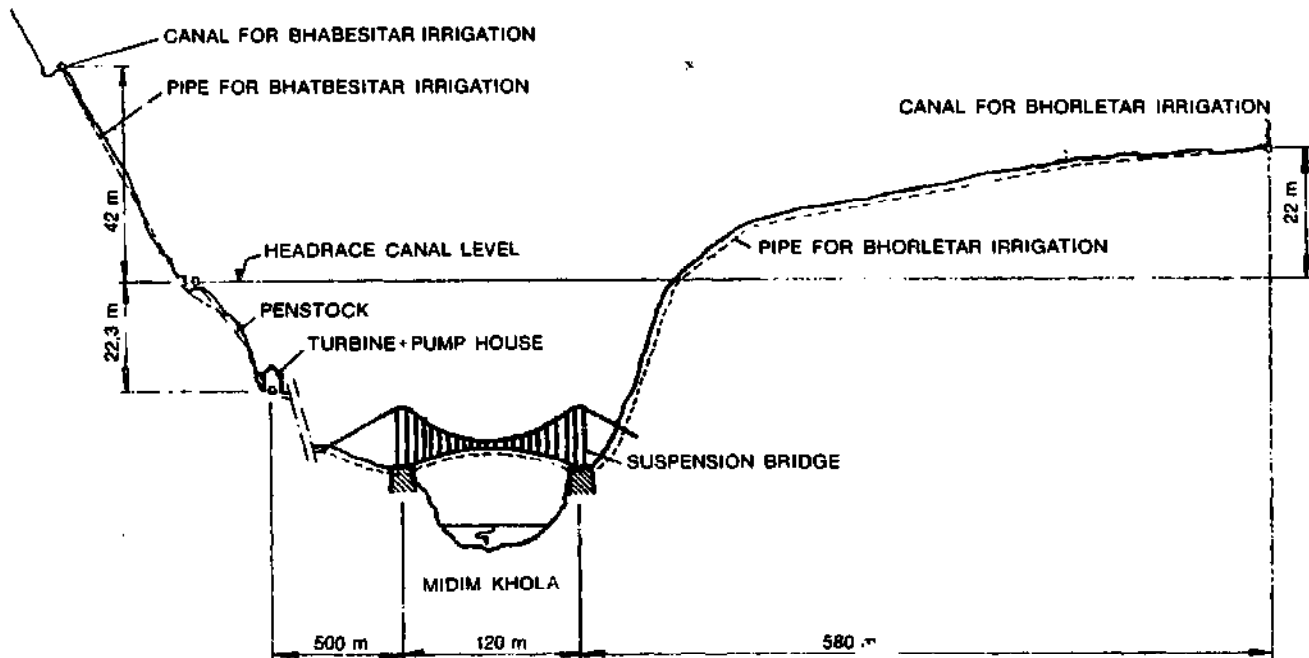
### d) Technical Details

Some remarks on the technical configuration of the project may be of interest. The original idea during project prefeasibility studies was to generate electrical power with the water turbines and to operate water pumps with electricity in a **pumping station** at the river side. This would have resulted in a geodetic head of about 53 meters to pump water up to Borletar. Also, an additional civil engineering structure would have been necessary on the river bank, with intake and sedimentation tank for the water to be pumped.

In the configuration finally adopted, water to be pumped is taken from the head-race canal with a separate sedimentation arrangement in the forebay so that there are still fewer suspended particles as compared to water supplied to the turbine. This necessitates a separate supply pipe parallel to the penstock, to bring water to the pump sets with positive pressure. With this arrangement, the **static pumping head** to pump water up to Borletar amounts to 22 meters only,

as can be seen from the schematical profile in fig. 61. On the other hand, a relatively long (about 1 km) delivery pipe is necessary, which involves considerable friction losses. Still, the dynamic head with the existing arrangement amounts to only 49 m as compared to 58 m with a pumping station on the river bank.

TOTAL PUMPING HEAD FOR BHATBESITAR 42.0 M. HEAD + 3.0 M. PIPELOSSES = 45 M.  
TOTAL PUMPING HEAD FOR BHORLETAR 26.4 M. HEAD + 22.6 M. PIPELOSSES = 49 M. (MAXIMUM)  
AT BHORLETAR WATER OUTLET AT LOWER LOWER HIGHTS WILL BE PROVIDED



**Fig. 61:**  
Schematical Profile of Bhoreletar Irrigation System

Source: BYS, Nepal

There were three criteria that helped in deciding which system to adopt, namely: technical feasibility, cost, and overall system-efficiency. The two possibilities studied were both considered technically feasible but the use of a mechanical power drive must be considered an advantage because it involves a considerably less sophisticated technology as compared to electricity generation. On the cost side, it was a comparison of cost of electricity generating equipment, including transmission and the construction of a pump-house with intake and sedimentation basin in the original configuration, versus a larger head-race canal section, a longer delivery pipe, and the cost of bringing the pipe across

the river, in the final configuration. It was here possible to use an existing suspension foot-bridge to which the water delivery pipe could be attached and this cost item was therefore minimal. Adding all cost up and comparing them, showed a slight but not decisive advantages for the second system. Really of major importance, and at first surprising, was the **comparison of efficiencies**: The mechanical system with the pumps in the turbine building showed roughly an efficiency that was better by a **factor of 2** as compared to the electric system, even though it involves a more than 600 meters longer delivery pipe.

To explain this requires perhaps some elaboration: In a comparison of the overall efficiency, all components that are usually required in both systems, need not be considered. These are: Turbines, step-up transmission, and water pumps. In the mechanical system, additional losses accrue from pipe friction only, while the electrical system involves losses in the generator, in electricity transmission, in electric motors and pipe friction. Input energy in both systems is equal, and what is of interest in terms of output is the amount of water pumped, e.g. if input energy is multiplied by all additional equipment efficiencies and divided by the dynamic head, the result will be mass flow rate of water at the irrigation outlet. A numerical comparison is thus very simple and may be presented as follows:

**Fig. 62:**  
**System-Efficiency Comparison**  
**Bhorletar, Nepal**

Parameters	Mechanical System	Electrical System
Input Energy	92	92
Generator efficiency	-	0,86
low tension transmission efficiency	-	0,90
motor efficiency	-	0,82
Net energy	92	58,4
dynamic pumping head	49 m	58 m
Water output	1,9	~ 1

The relatively long canal of 400 meters made a number of different sections necessary, depending on terrain. At two places, rectangular wooden flumes were made to cross gullies. Another seasonal rivulet with quite a broad bed had to be crossed also. This was done by covering the canal with stone-slabs to prevent

the bed-load being deposited in the canal. The photograph in fig. 63 gives an impression of canal construction that was all done manually and mostly in unlined execution.



**Fig. 63:**

Canal Construction at Bhorletar, Nepal

Photo by: M. Eisenring, BYS

The equipment in the power house comprises two turbine sets of type T1 to which water is fed through a common penstock, branching in two, above the turbines. The two turbines, working under a net head of more than 20 m may be operated independently of each other. Each set supplies power by chain-drive to an intermediary shaft from which two pumps (e.g. totally 4 pumps) are driven with vee-belts. A third intermediary shaft in front of the turbines may be connected to either turbine, to operate the agro-processing machinery. A 10 kW alternator, envisaged for the 2nd project stage, will be operated from this shaft alternatively. Fig. 64 shows the turbine sets installed, with construction of the power house - in local mud-mortar masonry - under progress.

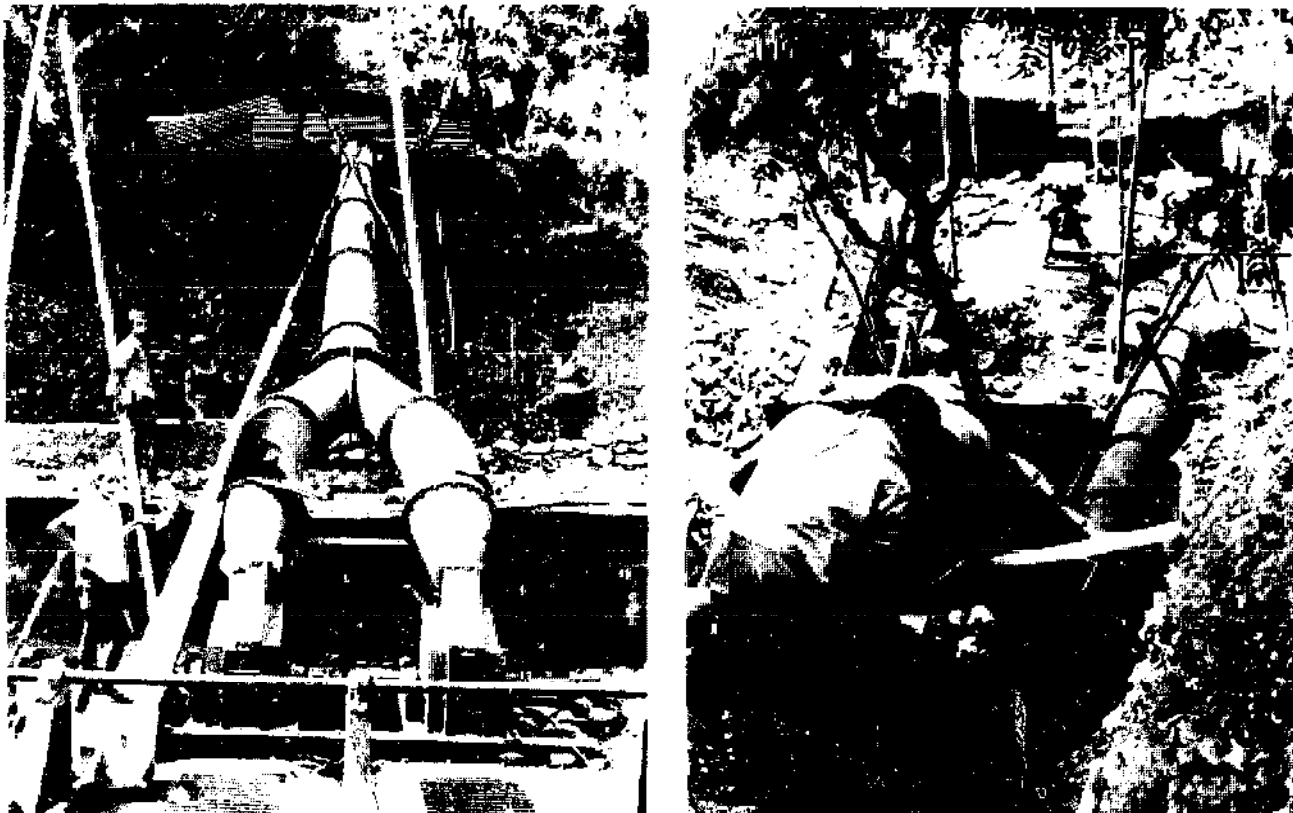


Fig. 64:  
Equipment at Borletar under Installation

Photos by: M. Eisenring

A **speed governor** is **not** required for the system, because the operation of water pumps constitutes a **constant load**. Instead, turbines are equipped with a mechanism for manual operation of the gate. With this, it is quite simple to operate the pumps. To start, the pump inlet valves are opened with the turbine still at a standstill. Because of positive pressure on the inlet side, the delivery pipe fills without operating the pumps up to the level of the head race. Then the turbine gate is opened and the pumps are run at reduced speed just sufficient to fill delivery pipes completely. Only thereafter is speed increased to develop full dynamic head and full flow. The optimal turbine speed can quite simply be read from a pressure gauge on the delivery pipe. This procedure prevents any water hammer in the pumping system from developing.

The pumps used are of centrifugal spiral-casing type. With the concept to use

local technology to the largest possible extent, a number of enquiries for pumps were made first in the region, since Nepal itself does not produce any. By comparing characteristics of pumps from the regional market with those of pumps from Europe, it was found that much more water could be pumped with machines imported from overseas, due to better matching of the latter with the actual flow/head conditions and generally higher efficiencies. Consequently, pumps were imported from Europe, although it was clear that getting spare parts would be more difficult.

#### e) Investment Costs

Total investment costs were initially estimated to be NRs. 540'000.-. Successively, due to inflation and not foreseen technical difficulties, the overall costs finally reached about NRs. 700'000.-\*. This is the amount for the integrated project including several other activities in addition to hydropower generation. It is not possible to separate the actual cost for hydropower development alone but on the higher side, an amount of NRs. 530'000.- seems reasonable. Fig. 65 gives a rough breakdown of cost into the systems components. Since the use of power is only possible with auxiliary equipment such as water pumps, piping, and milling machinery, this is also included.

It should be noted that costs as given here are not fully representative. Canal construction is relatively low due to involvement of partly voluntary labour. Also, supervising personnel of ADB/N and an expatriate expert of BYS have not been accounted for. From the side of power end use, it is of interest to note the cost of lift-irrigation on a unit of area basis, since in the existing situation, 50 hectares of land are irrigated, cost of development per hectare amounts to \$ 886. This, however, does not include such additionally possible irrigation from head race overflow and tail race water.

---

\* estimate at cost level of 1979, 12 NRs. = U.S.\$ 1.-

**Fig. 65:****Cost Breakdown of Borletar Project**

Source: ADB/N+BYS Project proposal, and own estimate based on project progress report 1979

Item:	% of total cost	U.S.\$
Turbines of 60 kW output under a head of 20 m incl. penstock & drive components	16	7100
4 pumping sets with a rating of 60 l/s total	16	7100
milling equipment: Rice huller, flour mill, oil expeller	2	900
irrigation pipe: Ø 160 mm, HDPE 300 m, PVC 800 m, steel 6", 30 m, incl. installation	36	15900
canal + power house construction incl. intake + forebay	23	10200
engineering design + supervision	7	3100
Total	100	\$ 44300
Total per kilo Watt mechanical power output		\$ 738

**3. NAM DANG HYDRO-ELECTRIC PROJECT, THAILAND**

The Nam Dang project, recently built and also owned by the Water Shed Management Division of the Forestry Department, is another scheme using local technology. The turbines used are of the Cross-Flow type, designed by the design section of NEA's\* technical division, and built on contract basis by a small workshop in the northern city of Chiang Mai. NEA was also in charge for the planning of the entire installation and for technical supervision during construction.

Nam Dang is a very remote hill station, at 1'400 m altitude, about 120 km north-west of Chiang Mai. The station is situated right in the heart of the water shed area and has a negligible impact on the environment, since it is integrated into the reforestation program. The 100 kW power plant, of which powerhouse and penstock are visible in fig. 66, will be supplying electricity to three forestry stations and to a village inhabited by resettled hilltribes. A high-tension

\* National Energy Administration of Thailand



transmission line of 11 kV will be necessary for this purpose and will also make supply to other villages possible.

**Fig. 66:**

Penstock and Power House of Nam Dang Project, Thailand

Photo by: U. Meier



There is a fundamental difference in this project, as compared to most hydro-power schemes in Nepal, in the existence of an access road. This, naturally, reduces transportation and other costs considerably. Earthwork, for instance, was done by bulldozer at marginal cost, since this machine was engaged nearby in the construction and maintenance of a service road for reforestation.

**a) Technical Details**

**SPECIFICATIONS:**

- |  |           |            |
|--|-----------|------------|
| - Installed capacity:                                      |           | 120 kVA    |
| - Design discharge:  |           | 130 l/s    |
| - Head:  | gross:    | 79 m       |
|  | net:      | 70 m       |
| - Canal: open, trapezoidal, cement-mortar lined, length:   |           | 1'400 m    |
| - Penstock:  | diameter: | 450/200 mm |
|  | length:   | 224 m      |
| - Turbines: 2, Cross-Flow type<br>NEA design, runner<br>Ø: |           | 400 mm     |
| output:  |           | 62 kw/unit |

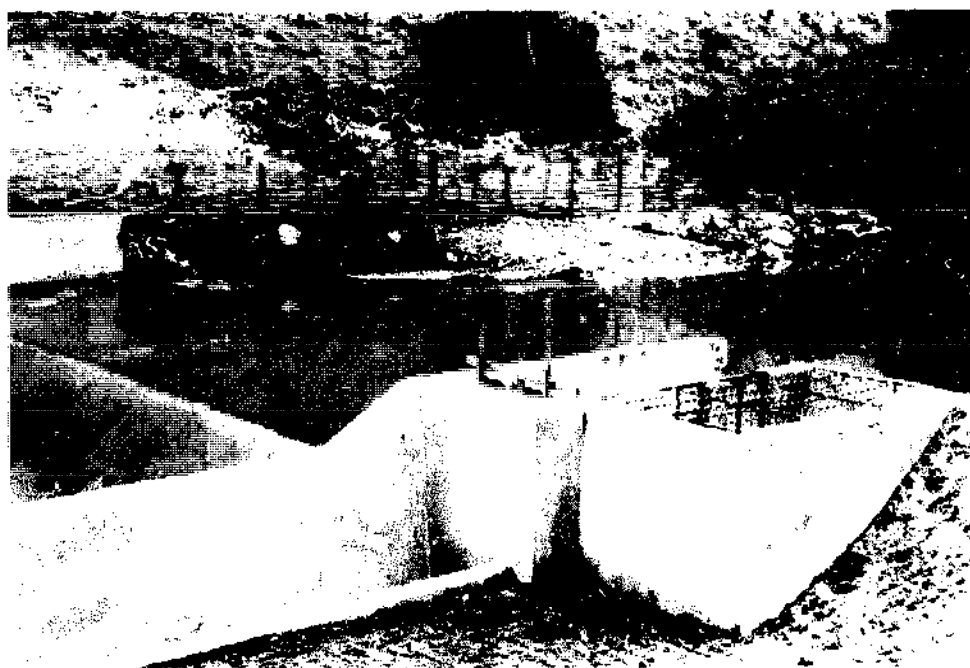
- Step-up transmission:  
chain drive (triplex, 5/8") ratio: 1 : 2
- Alternator: 2, 3-phase, 1500 PRM  
(50 Hz), self-excited, synchronous,  
brushless, italian-made: ANSOLDO  
voltage: 380/220 V
- Speed control: Oil-pressure, me-  
chanical governor, JAHNS, AA2  
(2 sets) speed: 900 RPM  
capacity: 45 mkg
- H.T. transmission: length: 18 km  
voltage: 11 kV

The civil engineering structures are of a **conventional** type in terms of the material used, e.g. mostly cement concrete structures, the reason being that cement is easily available and transportation is no problem. Compared to the situation in Salleri/Chialsa, cement costs about seven times less in the Nam Dang project.

**Fig. 67:**

Intake Weir at Nam  
Dang, Thailand

Photo by: U. Meier



The intake is built with a weir-type barrage of about 1 meter height, across the river at the site of a natural pool, with a box-type sedimentation tank and inlet visible on the right in fig. 67. For this structure, about 200 m<sup>3</sup> of concrete were used. The canal is fully lined and comprises several sections with closed conduits made from concrete pipe, to prevent side gullies from filling

those sections with sediment. The **forebay**, at which the head-race canal ends, is again a concrete structure, perhaps a bit oversized, with a perpendicular overflow weir and a **bottom flush-gate** for flushing out sediment (refer to fig. 68). The **trashrack**, divided into two parts, is arranged vertically in the submerged part and sloping above the water level. As may be seen from fig. 66, the **penstock**, in rolled steel sheet/welded construction, is above ground on concrete supports with a number of anchor blocks that are larger than strictly necessary. The same may be said of the power-house, which is a piece of architecture in itself.

**Fig. 68:**

Forebay with Spill-Way at Nam Dang, Thailand

Photo by: U. Meier



All civil construction work is done very neatly, somewhat more elaborate than strictly necessary, perhaps due to the pilot character of the project and easy accessibility.

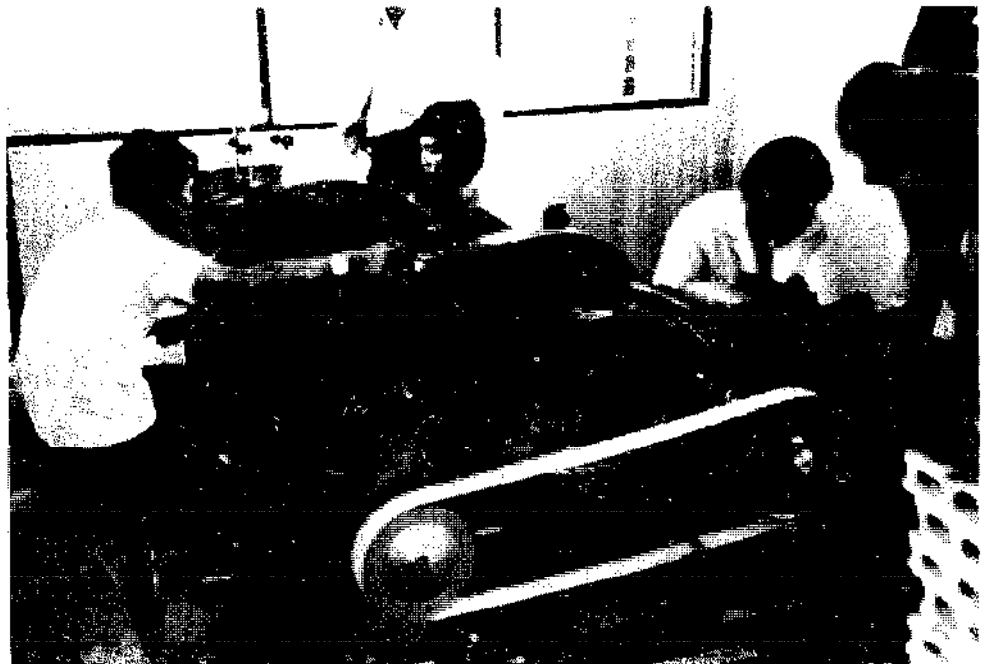
The two Cross-Flow turbines used are actually the prototypes of the NEA design with a runner diameter of 400 mm and a nozzle width of 50 mm. The material used

for the runner blades is stainless steel, as compared to common mild steel used by BYS in Nepal. The optimal turbine speed of 750 RPM necessitates a step-up transmission. For this, a **chain-drive** is used of Triplex, 5/8" pitch and 118 links configuration. Sprocket and pinion are made locally from steel plate.

**Fig. 69:**

View of Generating Equipment during Trial-Run at Nam Dang

Photo by: U. Meier



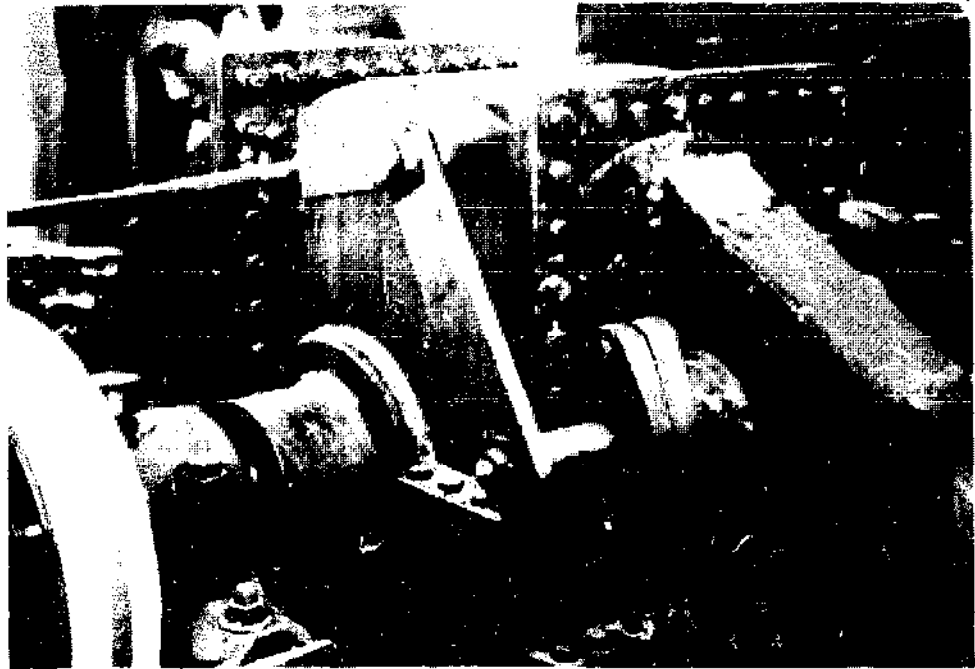
For speed control, a **flow-control** governor of conventional type is used. This governor, connected with a flat belt to the turbine shaft (refer to fig. 69), is of the **oil-pressure, flyweight** variety, and imported from Europe. This item is rather costly and constitutes near about 40 % of total equipment cost (excl. penstock). As is usual, the governor requires also a flywheel that was cast in steel in the country and has a diameter of 750 mm and an operating speed of 1'500 RPM.

Fig. 70 is a detail of the Cross-Flow turbine, with one main bearing, the inlet part with gate-operating lever, and a part of the governor connecting-rod visible. The two sets of the installation are identical in all details and will be switched in parallel into a common network with a transmission voltage of 11 kV.

**Fig. 70:**

Detail of NEA Cross-  
Flow Turbine at Nam  
Dang

Photo by: U. Meier



#### **b) Investment Costs**

For a comparison of costs with other installations described, it should be noted that the main difference is in a higher head which is generally cheaper to develop on a cost per unit basis. Further, construction materials and transportation have lower costs in Thailand, perhaps compensated to a degree by more elaborate construction. Also, in the case of Nam Dang, the cost of earthwork is not included since this was done by the Forest Department itself. In all three examples, design and engineering studies were not accounted for fully.

**Fig. 71:**

**Cost Breakdown of Nam Dang Project, Thailand**

Source: All information pertaining to Nam Dang by courtesy of NEA

Item:	% of total	U.S. \$
Civil Construction including Penstock	52	74'000.--
Power House	7	10'000.--
Generating Equipment	24	34'000.--
Power Transformer 160 kVA	3	4'800.--
H.T. Transmission Line	14	20'000.--
<b>Total</b>	<b>100</b>	<b>142'800.--</b>
Cost W/o H.T. Transmission		\$ 1'180/kW
Cost inclusive of H.T. Transmission		\$ 1'428/kW

**F. ECONOMIC CONSIDERATIONS**

The expert-group on hydropower for the Nairobi-Conference stated that from all renewable energy-sources, existing hydropower ranks top as far as accessible know-how as well as its economy are concerned.<sup>44)</sup> This statement will be elaborated on here by using a multi-level cost-benefit-approach which will be applied on micro-hydro installations compared to larger hydrostructures and on micro-hydro installations compared to alternative energies.

**1. BASIC APPROACH**

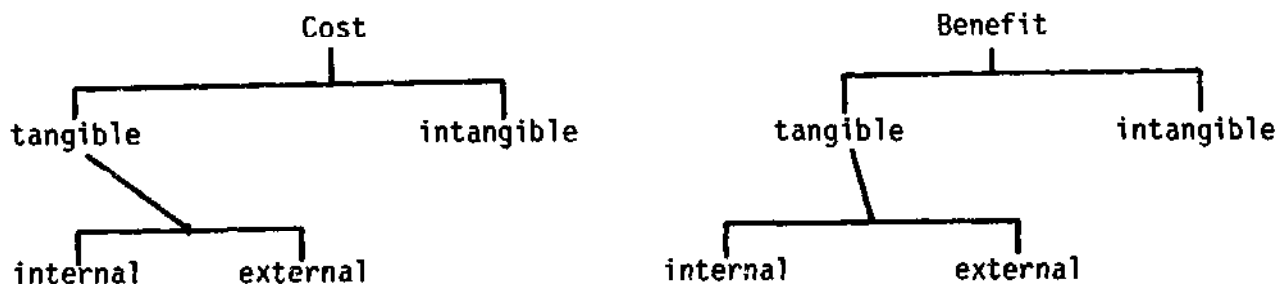
**a) Cost-Benefit-Approach for Socio-Economic Selection**

When the World Bank says that future energy demand should be met at the least cost<sup>45)</sup>, the question arises what cost are to be considered. Likewise one has to decide what kinds of benefits should be taken into the calculation. It is appropriate to say that energetic infrastructures - as all infrastructures - have especially many external economies and diseconomies. One way to get hold of most of the important effects, internal and external, could be the following

44) United Nations, Rapport du Groupe Technique ... p 28

45) World Bank, Energy in the Developing countries, p 8

system.



External cost and benefit are defined as the influence which an economic project's creation and performance exercises unvoluntarily on the "situation" (mostly profitability) of other units. Thus the operation of a micro-hydro plant could exercise **stimulating effects** - via backward linkages - on local workshops for the construction of generating equipment, or on civil engineers etc. (external economies), but would perhaps foster some new sociological stratification if one grainmill-owner or one sawmill-owner uses most of the produced electrical or mechanical energy to the detriment of others (external diseconomies).

It is for operational reasons advisable to differentiate among various levels of the cost-benefit-analysis. Here, three levels are suggested:

**FIRST COST-BENEFIT-LEVEL**

- tangible internal cost:
  - Civil works (dam, canal, powerhouse etc.)
  - Generating equipment (turbine, governor, generator etc.)
  - Penstock
  - Operation and maintenance (also fuel cost if non-renewable energy-source, or labour-cost for collecting dung for biogas-purposes)
  - Local distribution network (L.T.)
  - Other (R+D, project-design, land acquisition etc.)
- tangible internal benefit:
  - Mechanical and/or electrical energy-supply
    - for consumption (domestic) uses
    - for productive (entrepreneurial) uses
  - as "price per kWh" (as measure of comparison to other energy-options)

- Surplus revenues within local community
- Producers IER (internal economic rate of return)

**Comments:**

- Internal cost means cost of producing unit plus some local public investment in local grid.
- Internal benefit means benefit to all individuals, households and economic units (incl. the hydropower-producing unit), which are integrated into the new energy-system
- The price per kWh is to be calculated over the life of the project
- The surplus-revenues of customers (be it economic units or individuals) are obtained because of more economic activity as such and/or because of productivity-effects providing more foodstuffs per acre, more textiles per day, more cement per hour etc.
- The calculation of the IER needs a forecast of costs and revenues (those of the hydropower-producing unit) which requires a concept about selling prices and tariffs. The estimated future costs and revenues (e.g. the net balance) must be discounted as will be shown later on.  
Here comes in a difficult adjustment problem: the shadow-prices, i.e. distorted prices, be it to high or to low prices for cost-components of the hydro-power-plant, or of alternative energies (e.g. subsidies for kerosene).
- It remains to be said that the two-fold aspect of the tangible internal benefit (consumption-aspect and producers-revenue-aspect) coincide when a household or an economic unit is supplier and sole consumer at the same time (e.g. a family-biogas-plant).

So the first cost-benefit-level, by aggregating all cost over the life-period of the installation, determines a selling price of energy (which provides at least a cost-covering IER); the selling price must be related to given purchasing power (incl. the energy-induced increases of it) as well as to the selling prices of alternative energies and their revenue-increasing potential.

**SECOND COST-BENEFIT-LEVEL**

- tangible external cost:
  - Interlocal (regional, national) distribution-grids (H.T.)
  - Step-up and -down transformation
  - Distribution-losses of energy
  - Subsidies
  - Need of foreign currency
- tangible external benefit:
  - Increased tax revenues



- More diversified and possibly cheaper (for economies of scale arise when energy-input increases production per hour) product-supply to the local and regional community
- Less subsidies for alternative energy-sources
- Lowering of import-bill (e.g. oil) and increasing of import-substitution

#### Comments:

- Though this level is still "tangible" the quantifying problem becomes more difficult. At least rough indications should be possible.
- The result of this level cannot stand for itself; it has to be superimposed on the result of the first level. To elucidate this: it would make sense to accept a negative IER and subsidise the hydropower plant with a fraction of the increased tax revenues generated by more economic activities. There would still remain a net benefit to the community.

#### THIRD COST-BENEFIT-LEVEL

- intangible cost (examples):
  - new need arises to regulate the use of rivers by law and enforce its adherence
  - Price-increases for consumer goods in case of monopolistic markets
  - Privileges of electrified households, workshops, farms etc. in contrast to others
  - Increase of local capital-interest and credit-shortage as a consequence of concentrated capital-allocation on a hydroplant
  - Short-term displacement of human energy/work in economic production by mechanical and/or electrical power
  - etc.
- intangible benefit (examples):
  - more comfort
  - educational effects (lighting), health effects (heating)
  - environmental protection, flood control
  - recreation (in case of dam and lake)
  - degree of "self-reliance", local production
  - slowing down of urbanization because rural quality of life increases
  - learning process
  - "fall-out" and "trickle-down effect" of more productive methods as a consequence of hydropower and the demonstration-effects
  - Prevention of deforestation
  - etc.

**Comments:**

The larger the powerplant the more difficult it usually becomes to seize and to assess all intangible effects, internal and external.

Again, considerations of this cost-benefit-level should be at least added if not integrated into the net-effects of the first and second level.

**Summarising** one may say: there is an actual problem of quantifying the inputs into the cost-benefit-analysis. Many factors - above all on the third level - can only be assessed in a qualitative way; and even this is arbitrary. The first-level-result may be a negative IER, e.g. perhaps because of wrong input-prices (expensive turbine, possibly because of a highly overvalued rate of exchange, expensive cement), because of wrong selling-prices per kWh, or wrongly structured tariffs, because of a low use of a high-cost project (load-factor problem), etc. But these influential factors are quantifiable; more difficulties arise when one has to justify a bad IER with intangible benefits like the long-range value of "rural development" or "local self-reliance". Fortunately this problem will not arise too often since empirical evidence shows that large, centralised hydropower-plants have difficulties to compete successfully with smaller plants where loads are small and scattered, when calculated on the basis of tangible (internal and external) costs and benefits. Thus, the intangible benefits are rather an additional than a compensating incentive.<sup>46)</sup>

A further problem connected with cost-benefit is the question of **discounting** in order to calculate the IER. As mentioned earlier, the IER needs a forecast of costs and revenues which then are related to each other and should produce some **positive return** on total initial investment over the life-period of the project. At least the running cost, including capital-interest cost, should be reimbursed. The problem of depreciation is treated later (refer to end of section 2 lit. a). The question is how one can compare costs or revenues of today with those of thirty years ahead? Obviously it can only be done if all future costs and revenues are discounted to the **present value** of costs and revenues. The concept underlying this is simple: money - be it cost (C) or revenue (R) - of a future date ( $t_n$ ) is worth less than the synonym amount today ( $t_0$ ) since this money - if accessible today - would be invested at a given interest-rate

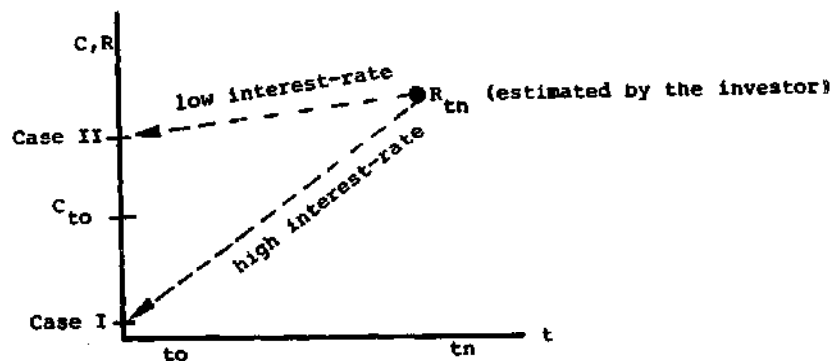
---

46) For more cost-benefit-approaches see: Wright, Micro-Hydro Installations, p 2; World Bank, Rural Electrification, p 41/42; UNIDO, Issue Paper, p 10

(i). Up to  $t_n$ , the initial amount would have increased according to the formula  $C_{tn} = C_{t_0} (1 + i)^n$ . This elucidates that much of the IER depends on the interest-rate chosen, since in hydropower plants, all costs occur today whereas the revenues are distributed over thirty to fifty or even more years. This simplifies the discounting calculation since only the future revenues which one anticipates, have to be discounted to their present value. A high interest-rate lowers the today-worth of future revenues, a low interest-rate makes future revenues appear high at  $t_0$ .

Fig. 72 exemplifies the discounting method; it is assumed that all future revenues occur together at  $t_n$ .

**Fig. 72:**  
Discounting Alternatives

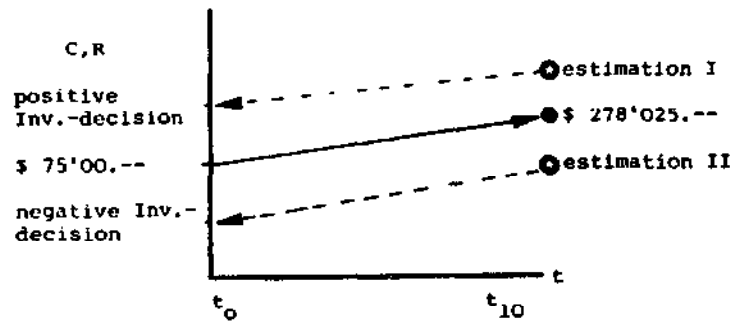


Case I shows that in view of the present value of the future revenue, the today's capital investment is comparably low, since more capital than  $C_{t_0}$  would have to be put into alternative investments today (loans, bank-account etc.) to reach the future revenue  $R_{t_n}$ .

The following example (refer to fig. 73), will further illustrate the problem. A hydropower plant of 50 kW installed capacity at a cost of \$ 1'500/kW (\$ 75'000.-- total investment) is planned for a life-period of 10 years. The prevailing interest rate of the country - also to be used for discounting - is 14 % p.a., for investments through a bank or other financial institutions. Applying the formula mentioned earlier the capital at  $t_{10}$ , including compound interest, will amount to \$ 278'025.--. If the investor's estimated revenue of the investment into the hydropower plant is higher than \$ 278'025.-- (estimation I) he will quickly embark on this energy-investment. Should the estimated future revenue be lower than \$ 278'025.-- (estimation II), then the investor will

prefer to entrust his capital to a bank or another institution granting the return of 14 %.

**Fig. 73:**  
Investment Decisions



The term "investor" needs a further explanation. The discounting procedure is relevant in two cases:

- the private investor choosing among alternative investment-opportunities
- the public investor having an utility-obligation, thus choosing among investment-alternatives within the energy-supply possibilities.

A certain complication of the discounting-method stems from the fact that the future revenue will rather be a yearly return than an aggregated sum at the end of the plant's lifespan. Mathematically it means that each year's revenue must be discounted separately or, should costs also arise yearly, the net balance between yearly cost and revenue.

In other words: the higher the discount-rate must be chosen (again: meaning that at this interest rate one could invest today's money) the less advantageous are capital-intensive installations (unless staggering kWh-prices are applied); a high discount-rate favours labour-intensive installations because it keeps down capital-investment at  $t_0$ . The low initial capital-investment respectively the low capital (interest) cost, will thus allow for more labour-intensive plant operation.

In practice, analysts have tended to underestimate seriously the level of discount rates prevailing in poor areas. One result has been to focus attention exclusively on relatively capital-intensive and complex energy systems.<sup>47)</sup>

47) see: French: Renewable Energy Systems, p 41; for example of calculation see NRECA, Small Hydro-electric Powerplants, p 104 f.

In summary it is necessary to:

- Determine all pertinent factors to be included into the three cost-benefit-levels
- quantify and qualify these factors
- discount the tangible costs and revenues.

The results may then be used to:

- compare hydropower plants of different types and sizes
- compare hydropower plants with alternative energies.

As to the latter point however, one will first have to consider the "second law efficiency" of thermodynamics before embarking on economic analysis since there is a distinct interrelationship between task, energy-source and energy-device, which - when one end-use (task) is considered - eliminates many energy-alternatives at the outset for thermodynamic reasons rather than for economic reasons.

#### b) Constraints on the Selection of Energy-Sources

End-uses like lighting, cooking, heating or grainmilling, sugar-processing, brick-making, water-pumping, dyeing, cooling etc. may require very different energy-sources, ranging from wood, liquefied biomass, grid electricity, mechanical hydropower, biogas, kerosene etc. To begin with, a selection will consider thermodynamic constraints by tabulating the tasks into temperature-grades, lighting, stationary and mobile power. In an outstanding analysis of a village's energy needs, Reddy<sup>48)</sup> shows this as reproduced in fig. 74. Thus the economic cost-benefit-analyses will have to concentrate on the alternative options left over after this energetical pre-selection.

---

48) see Reddy: Rural Energy Centres, p 17

Task	Alternatives	
	Sources	Devices
medium-temperature heating	biogas energy forests	gas burner wood/charcoal stoves
low-temperature heating	waste heat solar	wood/charcoal stoves solar waste-heater/ solar dryer
lighting	electricity	incandescent lamps fluorescent tubes
stationary power	draught animals human labour wind biogas energy forests ethanol electricity	animal powered devices pedal-powered devices wind mills biogas engine producer-gas engine internal combustion engine electric motor
mobile power	draught animals human labour ethanol energy forests biogas	animal powered devices pedal-powered devices internal combustion engine producer-gas engine biogas engine
high-temperature heating	biogas charcoal	furnace furnace

**Fig. 74:****Selection of Sources and Devices for Pura**

Source: Reddy

**c) Concluding Remarks on Decision-Criteria**

The energetical selection (lit. b) and the economic cost-benefit-approach (lit. a) will both limit the energy-options to a few; to narrow further down the remaining alternatives, some more general criteria might be helpful. These are:

- the matching of the time-dependence of the energy-utilising task with the time-variation - if any - of the supply of energy from the chosen source. If matching is bad, energy-storage becomes necessary which implies new cost. The problem may arise with the variable discharge of rivers, the time of sunshine, variable wind-velocities etc.
- the primacy of basic needs
- the local self-reliance and system-independence providing social participation and control
- the environmental soundness; the primacy of renewable energy-sources and the minimising of negative ecological impacts

These additional criteria may be a useful guidance when a non-decisive result among alternatives arises.

The following sections will illustrate some of the criteria of lit a), b) and c), by way of examples of hydropower plants and alternative energy-sources. A full three-level cost-benefit analysis of each and every option is impossible at this place, however.

## 2. MICRO-HYDROPOWER AND LARGER HYDROPOWER PLANTS

All figures given from examples, and experience with hydropower plants are to be taken as order of magnitude since every case will differ very much for reasons of different labour costs, equipment-cost, site-cost, import-cost etc. Furthermore, figures reflect different cost/revenue-years; it would be academic to de- and reevaluate foreign currencies to a comparable international statistical basis in U.S. Dollar (\$) since neither inflation-rates nor rates of exchange can accurately be secured.

### a) Experience with Tangible Internal Costs

The World Bank <sup>49)</sup> states that the economic limit for mini-hydro projects (under 1 MW) is in the \$ 2'000 - 3'000 per kW range. One should consider this statement as too rough and a cost per kW of \$ 3'000 as too high to electrify hamlets, micro-industries and villages, in view of experience made in a number of projects. A report from OLADE <sup>50)</sup>, puts a figure of \$ 1'000 to 2'000 per kW as the desirable goal, and still other sources state that efforts should be made to remain close to \$ 1'000 per kW for obvious reasons. Based on this, it is now of interest to look at some actual figures, to see how far this can be achieved.

A series of different types of turbines from European manufacturers is shown in fig. 75, in the output range from 30 kW to 300 kW, and a head range from 2,3 m to 350 m. <sup>51)</sup> The costs given are updated to the level of 1980 and include complete generating equipment (e.g. turbine, step-up transmission where necessary, flywheel, governor, alternator, valves and other accessories, but excluding penstock). It becomes clear from the table that equipment for low head and low output becomes very costly.

---

49) see World Bank, Energy in the Developing Countries, p 46

50) see OLADE, Small Hydropower Stations ... p 34

51) From Integration GmbH, Laufwasserenergie, data sheets

Type of Installation	kW installed	Head (m)	Cost per kW in \$ (approx.)
Reiffenstein-Spiral-Turbine	30 kW	8,5	2'700.--
Francis-Vertical-Turbine	30 kW	2,7	3'500.--
Ossberger Cross-Flow-Turbine	40 kW	50	750.--
Kaplan-Axial-Turbine	51 kW	2,3	3'000.--
Francis-Spiral-Turbine	63 kW	27	1'500.--
Pelton-Turbine (2 nozzle)	75 kW	65	1'300.--
Francis-Spiral-Turbine	125 kW	40	950.--
Pelton-Turbine	160 kW	350	820.--
Kaplan-Axial-Turbine	220 kW	13,5	730.--
Francis-Spiral-Turbine	250 kW	27	500.--
Ossberger Cross-Flow Turbine	300 kW	5	550.--

**Fig. 75:**  
Different Hydro Generating-Equipment Costs

Source: Integration GmbH, Laufwasserenergie

The same source states that equipment cost ranges from 40 to 50 % of total cost in conventional hydro installations of the sizes referred to. This means that - since low-head installations have a relatively larger flow rate - civil construction costs amount to 50 % of total cost for heads above 20 m, and to 60 % for lower heads. This is of course broadly generalised but it serves the purpose of arriving at a relevant magnitude of total cost.



Based on fig. 75, the calculated total costs are between \$ 1'825 and \$ 8'750 per kW for heads from 2,3 to 13,5 m and \$ 1'000 to \$ 3'000 for heads between 27 and 350 meters. Thus a very clear cost-function of head and size is reflected in total plant costs. Notwithstanding this trend, it is also true that equipment for the highest head with an output far above the average of the examples given, is not the cheapest. Much depends on the type of equipment and the suppliers pricing. It is nothing unusual to get quotations for the same site, which differ by several hundred percent from different suppliers. This adds another variable, making representative cost analysis still more difficult.

As far as costs of civil construction-components are concerned, no standard cost unit can be given here. Dams, canals and intakes will obviously cost a very different share of the total for different sites. Much depends on the topography and the geology, and also on the construction method applied and the materials used.

Of interest in the context of this paper is now a comparison with costs of local technology. The examples in fig. 76 are all actual project costs at about the price level of 1980. In all cases shown, the turbine is of local design and construction. Other equipment components are also made locally, such as step-up transmission, flywheels, coupling, base frames, gate-valves and penstock. Governors are not used at all in the smaller plants, while on the bigger sets, different solutions were found as indicated. Alternators are in all cases imported; either from within the region or from overseas.

Comparing data from fig. 75 and 76 brings to light a number of facts. These should not be interpreted to be the absolute and only truth for reasons of enormous project diversity. However, the trend clearly stands as shown:

- The influence of variations of head and size on price are not pronounced because of a high degree of flexibility as to the chosen equipment configuration, which is appropriate to the situation.
- The average share of equipment cost of the total is 26,5 %, e.g. clearly less than the conventional 40 to 50 %.
- Total costs for the range from 10 to 100 kW using local technology, compared to cost per kW in fig. 75 show reversed economies of scale.

Project	Head output	Equipment Cost \$/kW*	% of Total**	Total** Cost \$/kW	Special Features
Salleri/ Chialisa Nepal	15,5 m 80 kW	372	23	1'640.--	2 turbines, 1 alternator electronic speed controller, difficult canal already built for 120 kW output
Runjatar Nepal***	34 m 80 kW	330	31	1'050.--	2 turbine-generator sets, 1 Mechanical governor
Khun Kong Thailand	5,6 m 10 kW	325	26	1'250.--	no governor short head-race canal
Nam Dang Thailand	70 m 100 kW	200	21	950.--	2 turbine-generator sets, 2 imported governors
Neglasari Indonesia	22 m 15 kW	180	30	600.--	no governor, no canal second hand alternator
Gajuri Nepal	22 m 25 kW	188	28	660.--	existing irrigation canal, no governor

\* Excluding penstock and installation work

\*\* Total cost of power station excluding transmission and distribution

\*\*\* Project not executed, projected costs are updated to price level of 1980

### **Fig. 76:**

#### **Cost of Generating Equipment Using Local Cross-Flow Turbine**

Sources: BYS, Nepal; NEA, Thailand; ITB, Indonesia

- Taking the average figure for equipment cost of \$ 265.-/kW and comparing this with the average of \$ 890.-/kW of eight turbines (imported) in fig. 75, shows that on an average, locally made sets (fig. 76) cost approx. 30 % of imported equipment only. (To arrive at a more representative average cost for imported equipment, the first three figures - representing atypical cost because of low head/low output - have not been included).
- Taking amounts for total cost for both series of examples shows, that only with local technology can the stated goal of \$ 1'000 per kW be approached under "normal" conditions.

## Conclusions:

- . It is possible to counter the rule of traditional economies of scale by using local technology in the range up to 100 kW.
- . It is also possible to reduce traditional overall costs considerably.
- . The result is, that the range up to 100 kW - where local technology is possible - becomes more economical as compared to the range from over 100 kW to 1 MW.

This latter point can not directly be derived from the examples shown but is the result of an evaluation of hydropower activities in Nepal, in the range up to 500 kW. The study referred to<sup>52)</sup>, maintains that there are two economically feasible ranges of size in evidence. The first from 2 to 30 kW\* and the second from 1 to 3 MW because in the latter, economies of scale are pronounced. For the range from over 100 kW to 1 MW, it is the following factors that make it uneconomical:

- too big for local technology, therefore high capital cost
- requires skilled and professional staff, therefore high running costs
- too small for a remarkable effect of economies of scale.

The same authors also introduce a new dimension of cost-reduction for **marginal village electricity-supply**: Many small hydropower installations exist in Nepal for mechanical power supply to agro-processing units, such as mills and oil presses. These projects are operating profitably, and could therefore be equipped with small alternators to provide domestic lighting and very limited other electricity uses, at only **marginal** cost of \$ 250 to 420 per kW (this also includes electricity distribution). As indicated previously, one can take it for granted that the upper limit of these very economical hydropower plants can be extended from 30 kW to about 100 kW, without jeopardising the intangible benefits of still using appropriate technologies, which are locally manageable.

Similar cost-experience has been made with micro-hydro installations in China.<sup>53)</sup> The **cost-concept** is based on the conviction that canals, dams, roads

---

52) see Krayenbühl, Small Hydro Development ... p 20 f.

\* which may be extended to 100 kW if head is over 20 meters as shown in fig. 75

53) see SATA/UMN, Study Tour ... p 58

etc. can be attributed to irrigation and flood-control anyway, so that electric power can be calculated at extra-cost for the generating equipment and civil works implied. In this way, costs attributable to electricity generation and distribution of as low as \$ 350 per kW, are reported.

As to the distribution of energy, local low-tension lines (380 V) were included in the first-level cost outlay. L.T.-lines are possible up to a couple of kilometers, depending on the material used for wiring. Good examples exist in Nepal or in Tanzania. Most of the Tanzanian micro-hydro plants have a short overhead distribution line to the consuming points, with an average length of 800 meters (min. 200 meters, max. 2 km).<sup>54)</sup> The electrical energy produced by these micro-hydro plants, is used mostly for households, water pumping, productive and agricultural machinery, hospital-stations, etc. With such short distances, a low-tension line is sufficient. Since the local low-tension distribution network must be provided anyway, the cost of local distribution would remain the same whether the electricity-supply comes from the local powerstation, or from grid extension fed by a distant power plant. But the point is that the villages have practically no chance to get a grid-extension, since step-down transformation on the high-tension side is a costly thing. One must rather envisage a grid-extension in a maybe not so distant future, after the local power plant has contributed to the village development, so that this can afford later-on to integrate its consumers into a larger grid-system.

Another cost-component of distribution is the metering of energy-consumption. It depends much on the tariff applied and will be discussed later.

To conclude on tangible internal cost, the operation- and maintenance-cost shall briefly be sketched: Hydropower plants are characterised by high initial capital-investment and low operation and maintenance cost, whereas diesel-powered generators are cheaper in terms of investment, with high running fuel-cost. For hydropower plants, operation cost must be seen as a function of the size of the plant and the salaries of local staff. Maintenance cost depend more on the characteristics of the site (rebuilding of intakes, removing slides on canals etc.) than on the size of the plant.<sup>55)</sup> Experts on this problem maintain that

54) see Hassanaly, Exploiting Mini ..., p 6

55) see Krayenbühl, Small Hydel III, p 11 f.

operation and maintenance cost for small hydropower plants (between 100 - 400 kW) are almost independent from installed capacity and amount to roughly \$ 25'000 - 40'000 per annum. Consequently, operation and maintenance cost per unit produced, decrease rapidly with size. They conclude that operation and maintenance costs can only be paid by the revenues of the plant, if its capacity is higher than 200 kW, the load factor is at least 20 % (with an availability of 75 %) and at high electricity prices. This again fosters evidence that the small-sized plant between 100 - 1'000 kW should be avoided.

Smaller plants than 100 kW show a drastic reduction of operation and maintenance cost by a factor averaging 4 - 5.<sup>56)</sup> However, the tendency to overstaff also micro-hydro stations is a problem. It also seems that the running-cost of a micro-hydro plant cannot easily be covered by simply selling electricity at a too high rate; the solution will rather be an adequate shaping of the tariff, in order to promote use of electricity to obtain a good load-factor.

A further element of the operation and maintenance cost is the **depreciation** of the plant. Again experts have calculated a weighted rate of depreciation, according to the different lifespans of the plant's parts like civil-work, generating-equipment etc. They suggest an annual depreciation rate of 4 % of the initial investment. Usually this determines such a high price per kWh in the range of up to US \$1 for depreciation alone that a serious problem is posed. From an economic point of view one has to take a firm stand regarding depreciation. As long as the perpetuum mobile is not invented there is no such thing that does not depreciate. If depreciation of the plant cannot be paid, then the country's development budget or foreign agencies must replace the whole installation, after the wearing out of the plant. If depreciation can be paid, two ways are conceivable: A loan can be repaid step by step thus diminishing capital-cost of the plant, and proportionally increasing the new debt-potential for the new plant, or, internal reserves are accumulated, so that the total replacement of the plant can be paid with proper financial means.

In most cases a subsidy to the plant will be inevitable, be it for private or public hydropower investment. No one would ever question the fact either that schools, streets and other public services have to be depreciated at the

56) see Krayenbühl, Small Hydrel ..., p 22

public'expense. However, to what extent costs are covered, is entirely determined by the revenues, a question that will be dealt with in the following chapter.

b) Experience with Tangible Internal Benefits

Information thereof will focus on the prices - and tariff - situation whereas "surplus revenues" and the "IER" are not elaborated at length.

"Baliguian" in a very remote place in the Philippines, is an example of locally designed and locally built equipment (Welded Francis turbine). With a head of 27 meters, and an installed capacity of 100 kW, the hydropower plant caused total cost of \$ 749 per kW (excluding distribution cost), of which hardly 40 % for the generating equipment (\$ 287). Producing 437'500 kWh per year - implying a load factor of close to 50 % - the selling price is an amazingly low US-cents 2.1 per kWh.<sup>57)</sup> Other small and micro-hydro installations in the Philippines sell at higher prices:

<u>Installation</u>	<u>US-cents per kWh</u>
- Magat A & B with 2'800 kW capacity	4.7
- Agua Grande with 2'750 kW capacity	5.2
- Hasaan with 30 kW capacity	5.3

The third example may demonstrate once more that a micro capacity is by no means in itself a guarantee for a low total investment and selling price. There are so many variables which finally determine the economy of a plant, that relying too much on the cost element of the generating equipment, can be a misleading yardstick.

The East-African power plants mentioned earlier, sold at rates per kWh between US ¢ 13 and 18 in 1966, a not so attractive offer considering the fact that European electricity producers calculate today with a price of US ¢ 3.5 per kWh to cover cost and depreciate the plant within 10 years.<sup>58)</sup> At US ¢ 2.0 per kWh

57) calculated from data in: Dumol, Mini-Hydro Application, p 31  
Looking at investment cost, it appears that capital interest and depreciation are not accounted for.

58) see Integration GmbH, Laufwasserenergie, p 55

the depreciation is stretched over 20 years.

Back to China - a country with a lot of experience on small hydropower plants - more comforting evidence is available. It is said that micro-hydro plants sell cheaper electricity than larger plants; in case of higher investment-cost per installed kW in small plants, this is by far offset by the high transmission costs of larger plants.<sup>59)</sup> For the Xinhui county, a price of US \$ 5 per kWh is indicated for small hydel stations and US \$ 8.4 per kWh for grid-electricity (1979).<sup>60)</sup> It is certainly true that kWh-prices in developing countries often turn out to be higher than in industrialised countries; but the cost of alternative energy sources often are even higher, or - if lower as in the case of wood - have intangible costs which are unmeasurable. At this point, one should simply remember the question of energy-source selection from a thermodynamic standpoint. From this angle, cooking with electricity for example, would energetically be a luxurious undertaking.

Uneconomical and thus unwanted uses of generated power can be controlled by shaping the tariff accordingly. Any electricity supply company has to deliver electrical energy at the moment of production. Due to the fact that electrical energy is not storeable, an electricity supplier has to charge for two services: for keeping a certain amount of generation equipment ready (which is a typical public utility duty), and for the actual supply of energy per period of account.<sup>61)</sup> There results a two-part tariff, one part for the power-capacity, the other part for energy consumption. For hydropower plants with relatively high capital investment and low running cost (no fuel-cost), this means high capacity and low energy charges, whereas thermal generation induces moderate capacity and high energy charges. The two-part tariff however requires the metering of the individual energy-consumption, as well as the consumers peak demand. If upto 90 % of total consumption is by small consumers, this is simply too expensive.

An alternative method is based on the assumption that the power requirements of a domestic consumer correspond to the number of rooms or bulbs etc. he

---

59) see United Nations, Rapport du Groupe ..., p 19

60) see SAITA/UMN, Report ..., p 61

61) see Amann, Energy Supply ..., p 116 f.

possesses. The tariff applied is then a **maximum-demand** equivalent charge per room or per electrical device. Metering is not anymore necessary. The method is called the **flat rate per unit installed**. This tariff does in fact - though in a very simple way - also take into account the two part cost structure of an electric energy supplier: when the electric device is switched on, the flat-rate charged to the consumer pays for energy consumption; when it is turned off, the flat-rate pays for capacity installed. The rate is in both cases the same. The negative aspect of the flat rate is of course that it induces consumers to have the electrical devices on as much as possible, instead of saving energy. However in the case of hydropower, this aspect should be looked at from another angle: the **price per kWh** can only decrease, when the generating equipment is utilised to the largest possible extent. The electric energy supplier is therefore interested in having a high load factor. The flat-rate tariff is in fact a **consumption-inducing** tariff.

Another, also consumption-inducing tariff and thus load-improving method is to price the supply in blocks at a decreasing rate, e.g.:

- the first 1'000 units at 10 US ¢ per kWh
- the next 2'000 at 8 U ¢ per kWh
- all additional units at 6 US ¢ per kWh.

The method increases the load factor and lowers the average price per unit of energy. This can also be combined with an off-peak tariff, thus flattening out uneven capacity use. However, both measures favour the larger consumers.

Finally, a fourth method should be mentioned: the **tariff of the social utility-principle**. To every use a different use-value is attached, expressing the users' appreciation of the different services rendered by electricity.<sup>62)</sup> For example, lighting receives a high use-value, whereas the energy-input into workshop machinery will be rated lower for reasons of its productivity. To further exemplify: The "Mei river" power plant in China charges the following rates:

---

62) see China-Tour, Report ..., p 60



<u>type of consumer</u>	<u>US ¢ per kWh</u>
- Industry	1.2
- Domestic	2.1
- Irrigation and pumping	0.6

The "Gu Don Mountain" power plant in China puts the social utility weight differently. It looks at industry as the most solvent partner, since precisely industry - by means of electricity - is enabled to attain surplus revenues, and is therefore charged most, the domestic-sector second-most, but hardly anything for irrigation and pumping<sup>63)</sup> (though surplus revenue will be generated in agriculture in the first place).

Consequently, the tariff helps determining many things like the load factor and thus the average price per kWh, the peaks and off-peaks in consumption and the socially wanted distribution of the generating costs, by differentiating the tariff according to end-uses. But all in all, the tariff will have to provide an acceptable IER to the producing organisation.

### c) Experience with Tangible External Costs and Benefits

As to external costs, some data will be given here specifically focusing on H.T.-grids as the most crucial factor, whereas state subsidies and foreign-exchange costs are not further quantified.

If one looks at the Brazilian hydroenergy potential of 209'000 MW - 14 % of it which is utilised only - the energy problem of this country seems to be solved. This "global" optimism is an illusion however, because the distances from the sites of hydropotential to the main consumer points are enourmously long. And so are the implied costs of H.T.-lines.

Considering a transmission-line of 10 kV, the Chinese indicate cost per km of \$ 5'500.- to 6'500.-.<sup>64)</sup> Very similar costs are budgeted for a H.T.-line of 7 km length, including transformation to 6 kV in Nepal, with \$ 6'250.- per km

---

63) see China-Tour, Report ..., p 60

64) see SATA/UMB, Report ..., p 55

(1977).<sup>65)</sup> The World Bank stated in 1975 that extending a subtransmission link 25 km to an isolated demand point, may cost around \$ 100'000, thus amounting to \$ 4'000 per km.<sup>66)</sup> Inflation will bring it close to the above-mentioned \$ 6'000.- per km. In Tanzania\* a typical price for a 33 kV line is approx. \$ 8'430.- per km.<sup>67)</sup> A rough average - at costs of today - is therefore approx. 7'000 \$/km. This is valid only in the small-hydro range.

Some analyses have been done of a comparison between public supplies from the main grid and micro-hydro stations.<sup>68)</sup>

For micro-hydro - serving local consumers and public lighting - an installed capacity of 80 kW was considered, and public supplies from the grid was assumed to be of medium-voltage of 33 kV as subtransmission link to the local L.T.-line. The capital costs of supplies from the grid are much higher than those of micro-hydro generation, but are of course depending on the distance from the nearest grid. The crucial point however, is this: the higher the utilisation of the energy-project, the better off is the supply from the public grid, since its fixed transmission costs result in a decreasing unit-cost, if the load-factor increases. This is illustrated in fig. 78, where unit-cost is given for different situations. At a low level of utilisation, public supplies from the grid are too expensive because it is extravagant to extend so expensive networks at \$ 7'000.- per km, to meet small demands in areas remote from the grid. Micro-hydro thus is better off, provided that its local consumers are not too remote either from the power plant, since - as shown earlier - L.T. lines are technically restricted to a relatively small radius of some kilometers at the most. As soon as it comes to transformation and H.T.-lines, micro-hydro tends also to run into high costs.

When the socio-economic uplift of the village has increased energy-consumption, the marginal internal cost of expanding micro-hydro generation, will have to be compared with the external cost of integrating the village into the main

65) see Meier et al., Salleri/Chialisa ...

66) see World Bank, Rural Electrification, p 19

\* 8.3 T.Shs. = 1 \$

67) see Hassanali, Exploiting Mini-Hydro Plants ..., p 3

68) see World Bank, Rural Electrification, p 18 - 2 and the table in fig. 78 of this report

grid. Again the Chinese have even applied a combination, by using small hydro up to its capacity-maximum (maximising the load factor) and supplementing peak-demand by public supplies from regional grids.

**Fig. 78:**

**Average Costs of Different Schemes, US \$ per kWh**

Load Factor %	Supplies from Grid		Micro-Hydro
	4 km	29 km	
10	18	40	21
25	7	17	11
50	4	8	5

Source: World Bank, Rural Electrification, p 21, micro-hydro figures are calculated on the basis of project data from Nepal

Some brief remarks should be added to the **tangible external benefits**. Whether tax revenues will rise depends on surplus revenues generated by the higher energy input into production, be it agricultural or industrial. Product diversification and possible price decreases cannot be generalised here. Similarly, the question of **subsidies** must be looked at from case to case; it is conceivable that subsidies for imported kerosene will turn into subsidies for depreciation of a micro-hydro plant. But it might as well be that subsidies increase, but can be activated in terms of accounting, through local build-up of innovation-centres, more local employment, less expenditures on the trade-balance of the country, etc. It is especially the **import bill**, which could substantially be affected by implementing micro-hydro plants.

Most of the civil work will be entrusted to local engineering firms thus accounting for 30 - 50 % of the total cost. One has of course to safeguard against the tendency of importing steel, cement etc. used in too elaborate construction. As to the mechanical and electrical components, what is possible by local means has been elaborated in chapter D at length.

**d) Experience with Intangible Costs and Benefits**

As indicated earlier this third-level assessment is the most difficult one. The problem will be demonstrated by means of few examples without aiming at a comprehensive description.

Measuring the very long-term discharge of a river over 10 - 40 years can be a cost which nobody really considered. The tropical and subtropical zones have instable climatic features which can play a costly trick to a hydropower plant. The intangible cost of not having correctly assessed the hydro-potential of a chosen site, will suddenly turn into very tangible costs once the water discharge is substantially lower in a dry year. In China the general reliability of micro-hydro plants is rated lower than the one of large power stations. Severe droughts periodically plaguing large areas of China can incapacitate small stations quite rapidly.<sup>69)</sup> Therefore an intangible cost can consist in the interruptions of energy supply from small power stations, causing some disorder and planning problems to the economic life of a village. But experts working with micro-plants insist that - if capacity is based on **minimum-flow** rather than a power plant capacity aiming at **optimum-utilisation** of flow - such incidents are seldom and when they occur, the harm done is not so dramatic.

Certainly one does also have to consider some socio-cultural impacts of a new energy-source like electricity. Examples are: smoke from open fires in houses projects inmates from flies and insects; electrical appliances do not. A fire also heats a house, an electrical cooker does so much less; the fire offers light in the mornings and evenings and provides a natural center for social life, whereas electrical appliances do not substitute for these functions.<sup>70)</sup>

On the **intangible benefit-side** in the first place one has to evaluate the immense "mobilisation-effect" of rural electrification, all the development thrust which can be generated in a small community that makes suddenly power available for irrigation and drainage, for primary processing tasks such as grain treshing and milling, fodder crushing, oil extraction, timber sawing etc., truly the first steps towards sensible modernisation in remote, poor communities. What counts are not only the tangible external benefits (surplus revenues) of the above-mentioned activities, but above all - **intangibly** - the **motivations**, the attitude and the drive towards "being able to do something" against poverty.

---

69) see Smil, China's Energy, p 91 f.

70) see SVMT/LAI, Solar cookers, p 14 f., and Krayenbühl, Small Hydrel ..., p 18

### 3. MICRO-HYDRO PLANTS AND ALTERNATIVE ENERGIES

#### a) General Remarks

The following sections compare alternative energies basically using again the criteria of the multilevel-cost-benefit approach. However, the application of this system will be more eclectic than in section F2. The evaluation will concentrate on costs of installed capacity and user-prices per kWh, surrounded by other tangibles and intangibles.

A first rough impression of relative costs (cost-relation) among energy alternatives is given in fig. 79.

Generator Type	Investment-Costs* \$ per kW	Fuel-Costs US ¢ per kWh	Power-Costs US ¢ per kWh
Hydropower - micro range local technology	1'500	none	5,0***
Diesel - small, light oil fuel	800	10,9	13,2
Steam - coal-fired	1'000	2,7	5,2***
- oil-fired	800	5,5	7,5
- wood-fired	1'500	5,0	10,0
Wind Generator**	5'000- 15'000	none	30 - 100
Solar Photovoltaic**	20'000- 30'000	none	100 - 300

**Fig. 79:**

Comparative Costs of Electricity Generation from various Fuels in 1980 \$

Source: World Bank, Energy in the ..., p 43

\* including costs of transmission and distribution

\*\* intermittent energy sources requiring storage to make energy available on demand at all times; investment cost given include storage costs.

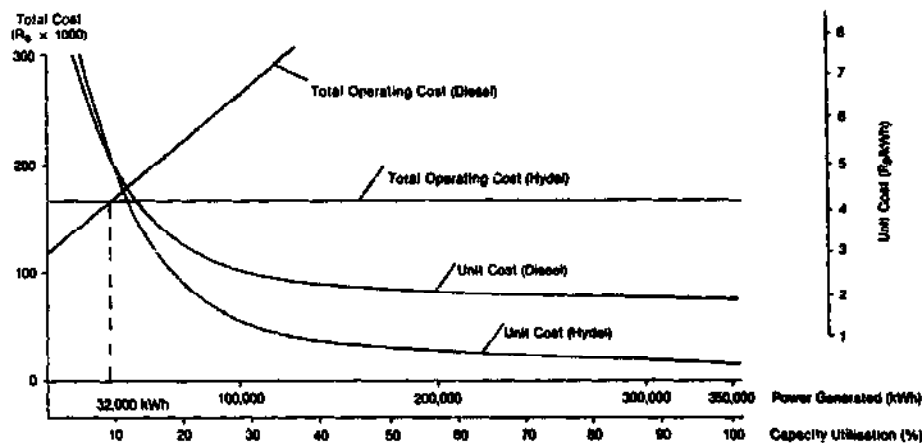
\*\*\* hydropower plants are assumed to operate at a load factor of 5'000 hours per year, coal-units on a base load of 7'000 hours per year.

The diesel-powered generator and the oil-fired steam engine both depend on increasing fuel-costs, thus falling out of competition in the long run. The coal-fired steam engine also will have to face price-increases; beside this, the attractive cost per kWh of only 5.2 US¢ stems from a load factor 40 % higher for coal (80 %) than for the hydropower station (57 %). Wood, wind and solar conversion seem to eliminate themselves for price reasons.

The following sections will deal very briefly with alternative energy-sources individually, in relation to hydro-power, in order to check the so far outlined relative cost situation.

### b) Oil fuels

From a "model-calculation" for two 40 kW-plants, one hydro-electric and the other diesel-electric, the cost-functions as shown in fig. 80 have been derived.



**Fig. 80:**

Total Operating Cost and Unit Cost against Power Generated Capacity/Utilisation for 40 kW Diesel and Hydro-Electric Installations

Source: Wright, Micro-Hydro Installations

The key characteristics of investment costs are: hydropower has twice as much costs as the diesel, especially because of much higher civil-work costs and transmission-costs since a diesel-set can be put right in the centre of a consuming point. As to the operation-costs: the diesel has much higher depreciation-costs because of a three-times shorter lifespan, higher maintenance costs, and above all high variable fuel costs. The main results of the comparison are:

total operation costs are equal for the systems at about 10 % capacity utilisation, but at 40 % capacity utilisation, diesel is twice as expensive.

Another example from the Philippines is also instructive. The National Electrification Administration plans 239 hydropower stations with a total capacity of 305 MW until 1987,<sup>71)</sup> an average capacity thus of 1'276 kW. The total cost is supposed to be 4 billion pesos\* or \$ 533 million. On average, 1 kW installed capacity amounts to \$ 1'748. The total generating capacity to be installed is the equivalent of a medium sized thermal generating plant, which would consume about 2,3 million barrels of oil at a capacity use of 5000 hours per year. At costs of \$ 35.- per barrel of oil equivalent, yearly fuel costs would amount to 80.5 million \$, or 5.3 ¢ US per kWh, in addition to 2,4 ¢\*\* per kWh for capital interest and depreciation. Excluding maintenance and other costs in both cases, 7.7 ¢/kW for the thermal plant compares to 5.2 ¢/kWh\*\*\* for the hydropower plants.

The advantage of such a thermal power plant would be that the initial capital required is lower by 289 million \$, when compared to the hydropower alternative. Future costs of fuel, amounting to 80.5 million \$ per year, have to be discounted as explained in section F1 (p 114 f.), to get a true picture. Thus, assuming 10 % interest, fuel costs over 5 years will amount to 305 million \$, expressed in today's-value of money. From the sixth year onwards, all money spent for fuel in the case of the thermal plant, is equal to a net-saving in the case of the hydropower plants envisaged. Not considering here possible increases of the fuel price, the shorter life of a thermal plant, and other factors, the total amount saved over the life period of 30 years of the hydropower plants, amounts to 470 million \$ - expressed again in today's value of money - when compared to thermal plant operation over the same period.\*\*\*\*

71) see Dumol, Mini Hydro Application ... p 34 f.

\* 7.5 Pesos = 1 US \$

\*\* 15 % on 244 million \$, e.g. \$ 800 per kW

\*\*\* 15 % on 533 million \$ capital investment

\*\*\*\* Calculation:  $C+(1+0.1)^1 + C+(1+0.1)^2 + \dots + C+(1+0.1)^{30} = 759$  million \$  
759 million \$ - 289 million \$ = 470 million \$.

Where: C = yearly fuel costs at today's-value

759 million = today's value of future fuel cost

289 million = today's value of difference in investment

It remains to be said that micro-hydro installations have many external and intangible benefits not inherent to diesel. It starts with the import costs of diesel-sets ranging from \$ 600 to 850 per kW. Hydropower plants in contrast will provide a lot of local employment and improvement of human capital. By any criteria like environment, maintenance, lifespan etc. the hydropower plant is favourable, unless there is no water.

### c) Wood and Dung

Cost comparisons between hydropower and wood/dung are difficult and do not make much sense. Difficulties arise because only a minority of people in developing countries really buy wood; for an Indian village, 4 % is an example.<sup>72)</sup> All others cut the wood at no private cost, at quantities of up to 0,6 tonnes/year per capita. Those who buy wood, get it at prices which are - despite the fuel-wood crisis - much lower than kWh-charges from hydroplants. For Nepal it is indicated that one can acquire 1 kWh<sub>th</sub> for less than 1 US \$. No electric supply company can compete with this price. The comparison, on the other hand, does not make much sense because wood simply is no longer an alternative. The worldwide deforestation rate calls for an immediate campaign of conservation of wood and for a massive planting of fuelwood supplies. But as long as wood is free of cost to the user, and as long as controls over the cutting of wood are ineffective, there are few incentives to plant energy-forests.

A similar problem is posed with dung. Up to 1 billion people use it to fuel their cooking fires. The amount of dung now being burned annually, is believed to be equivalent to some 2 million tons of nitrogen and phosphorous.<sup>73)</sup> The problem is that neither hydro-electric energy can compete economically with wood and dung - even if its price per kWh were a fraction of a US cent - nor does this mean that wood and dung are an economically better solution than hydro-electric power.

In the overall context, only processes in which the fertiliser-value of dung is preserved are feasible propositions and, in the case of power generation from wood, it appears that - in most regions of the world - only planned energy-forests could justify this. The latter, however, have long gestation periods,

---

72) see Reddy, The Design of ..., p 15

73) see World Bank, Energy ..., p 38



and there seems not to be any experience available that would permit a comparison with hydropower.

**d) Biogas**

Biogas will be evaluated in two steps: firstly, the economy of biogas as end-use energy-source is analysed, and secondly, the biogas conversion into electric-energy is compared to hydro-electric energy.

For the first consideration, a typical family size biogas plant in India is taken. Operating costs of such a plant are shown in fig. 81.

**Fig. 81:**

**Total Operating Costs of Family-Size Biogas Plant**

Source: French, Renewable Energy ... with own adjustments & supplements

<u>Item</u>	<u>Cost-Base</u>	<u>Annual operating cost</u>
plant	375.-- total investment	31,25 *
feeding/removing of plant	114.-- annual labour cost	57.-- **
Maintenance of plant		12,50
capital cost (15 %)		<u>28,15</u>
<b>Total</b>		<b>128,90</b>

\* estimated lifeperiod: 12 years

\*\* The plant needs daily 175 pounds of dung and water each; 350 pounds of slurry must be removed daily. It is assumed that after deducting the time formerly spent to collect other fuels, still new labour of 4 hours per day is needed to gather water, to feed and maintain the system, and to unload and distribute the slurry. Annual labour costs amount to \$ 114.-- for the Indian case. Considering the fact that much of the labour will be provided by family members, half of the labour cost is taken into account.

The tangible internal benefits of the plant result from a daily production of 3 m<sup>3</sup> of gas, enough to meet the daily basic energy needs of an Indian family of five to six people. 20 % will be used for home lighting, 80 % for cooking and heating. The gas production corresponds to 16'800 kcal per day or 19.5 kWh per day on a calorific basis. Assuming a capacity rate of the plant of 70 % <sup>74)</sup> total annual production amounts to 5'000 kWh at a price of US ¢ 2.6 per kWh.

74) Technical shut-downs or break-downs will decrease gas-production but hardly labour costs. Experience shows that a family biogas plant technically is not so easy to run and that in India the "load-factor" is approx. 70 %. See also French, Renewable Energy, p 23.

Formerly used energy sources (kerosene, coal) of a comparable calorific amount is said to cost \$ 90.-, thus rendering the biogas uneconomical, not accounting here for the intangible benefits (evitating future oil price increases, protection of forests etc.). One might argue that the biogas economy is quickly uplifted when family work is valued differently and the capacity rate is increased. The break-even point can thus be reached when labour costs in fig. 81 are further reduced by 30 % to \$ 40.- per year and the plants' utilisation rate is increased from 70 % to approx. 85 %.

But there are more intangible costs to consider. Firstly: the plant needs daily dung from 3 - 4 cows; less than 50 % of Indian cattle-owners have this many heads of cattle. Secondly: the very substantial amount of labour required by the plant should be seen as opportunity costs of alternative activities, having a higher return than the operation of the biogas plant. This is one of the very important advantages of the labour-extensive operation of hydropower plants. Thirdly: About 80 liters of water daily per plant, to be mixed with dung (no second use of the water is possible), is a severe constraint in dry regions.

The second step is to compare biogas converted into electric energy with micro-hydro electricity. Projected costs of electricity-generation from biogas are shown in fig. 82, taking the same family-size plant as a basis. A larger plant would benefit from pronounced economies of scale but has not been considered here because of very limited experience with large plants. Nevertheless, with unit costs of electricity, that are 4 to 8 times higher for a small biogas unit, compared to micro-hydro - it is possible to state that there is no economic feasibility of electric energy from biogas, when hydro-electric energy is an alternative. Even if the biogas plant produced at 100 % (7'120 kWh of biogas), the conversion rate were practically doubled (30 %, giving 2'136 kWh of electric power) and the annual cost of the conversion equipment were half (\$ 97.50), the cost would still be close to US ¢ 11 per kWh of electric power.

The conclusion is that biogas must be used for those tasks which thermodynamically match the biogas properties. Biogas as a rule is more economical than electrical power for cooking, but it will already be difficult to compete with micro-hydro installations when it comes to mechanical power, because of the very high labour costs of the biogas plant operation. Finally, biogas is completely

**Fig. 82:**

**Cost-Comparison of Electric Power from Biogas versus Micro-Hydropower**

Total annual biogas production at a capacity rate of 70 %	5'000 kWh <sub>th</sub>
(256 days x 3 m <sup>3</sup> x 6.5 kWh)	
Conversion into electric power (16 % efficiency <sup>75)</sup> )	800 kWh <sub>e</sub>
Annual costs of electric power from biogas:	
- cost of biogas production	\$ 128.90
- cost of conversion equipment*	<u>\$ 195.--</u> \$ 324.--
Cost per kWh of electric power from biogas	► US ¢ 40.--
Cost per kWh of electric power from micro-hydro	► US ¢ 5-10

\* annual operating cost:

<u>Investment</u>	<u>Annual operation cost</u>
Engine \$ 200.--	\$ 33 (lifespan 6 years)
Generator (1 kW) \$ 400.--	\$ 67 (lifespan 6 years)
Maintenance	\$ 50
Capital costs (15 %)	<u>\$ 45</u>
total	<u>\$ 195</u>

out of the acceptable cost-range when electric power supply is desired. The few biogas advantages still dwindle further when one applies a development concept oriented toward the majority of a village population, since only few people possess the necessary cattle. Community plants on the other hand will increase costs very much because of management, gas distribution networks, transportation of enormous quantities of water, skilled technicians to run a large plant etc.<sup>76)</sup> The overall outlook for biogas therefore, is rather bleak in rural electrifica-

75) see Smil, China's Energy, p 106

76) see French, Renewable Energy, p 29

tion.

### e) Liquefied Biomass

The production of methanol is not considered here as potential substitute for micro-hydropower because the production basis is naphta, residual oil and natural-gas. The end-user price ranges from \$ 25.- to 45.- per barrel of oil equivalent, depending on the price of the natural gas feedstock and the size of the production plant. Of more interest is the production of alcohol in the form of ethanol (ethyl-alcohol) from biomass.

Economically, experts agree that ethanol is nowadays a too costly substitute; though very large plants are designed (350 barrels oil equivalent a day), costs are in the range of \$ 10 - 20 million and require about 5'000 - 6'000 hectares of sugarcane annually.<sup>77)</sup> Today, the unit cost of ethanol is substantially higher than that of kerosene, with the decisive cost-factor being the price of sugarcane or other feedstock. It might at the most be a partial solution for Brasil (having large land reserves) or Kenya and Mali which have large surplus molasses from existing sugar production. For the majority of countries, however another problem than the unit-cost is relevant: ethanol from sugarcane plantations needs good agricultural land suitable for food grain production, in contrast to the fuel-wood forests which can grow on non-agricultural land.

### f) Solar and Wind Power

Along with hydropower, the direct use of sun and wind power are two more truly renewable energy sources. The potentials are impressing, at least theoretically. The solar radiation can provide an energy flow up to 1.6 million kcal per m<sup>2</sup> annually. Thus, the 1970 total electricity generation of China - 60 million MWh - is equal to the solar flux received annually by less than 40 km<sup>2</sup> of northern China.<sup>78)</sup>

Yet many technical obstacles of solar energy conversion into electricity make it very expensive. Irregular flow of radiation (seasonal and random fluctua-

---

77) see World Bank, energy in the Developing Countries, p 37 ff. for data on Methanol and Ethanol

78) see Smil, China's Energy, p 110

tions) and its diffusion before reaching the surface make a wide commercial application very unlikely within this century. Electricity from photovoltaic cells, which convert solar energy directly into electricity, costs on the order of \$ 2 per kWh. The widely published forecasts that the price will come down rather quickly, conceal the fact that complementary equipment - above all battery-systems - still remain a very important cost-factor. Solar power for low-lift, small farm-irrigation, for village water supply pumping and village electrification are simply out of the economic range compared to micro-hydropower; the advantage of hydro becomes greater, moreover, in proportion to the load factor of the hydro-plant. Nonetheless, in areas where there is no hydro-potential, small photovoltaic pumping systems without storage batteries are likely to become a sound possibility. Other uses like water heating, desalination, and crop drying with simple solar equipment, are economically more viable.

Wind energy also has a marked seasonality in many cases. The economically very central problem of storage (batteries), arises again. However the economic feasibility of wind energy seems to be closer to hydropower than the solar option. With a cost of over \$ 5'000 per kW installed capacity it is still indisputably more expensive than a micro-hydro installation.

It might be concluded from all these considerations, that micro-hydropower generation will not solve the energy problem of developing countries, but that it can play a very significant role in conjunction with de-centralised patterns of development, providing mechanical and electrical power at lower prices than other alternatives, inducing local employment and technical activities without prejudicing future energy-systems of a larger type, to which local distribution networks can be linked.

## G. ASPECTS OF TECHNOLOGY TRANSFER AND DISSEMINATION

Technology for the development of small hydropower is available for transfer from an increasing number of sources\* covering different approaches, and based on different scales of magnitude. For effective implementation, a number of measures are required from the user's end (country, region), which were so far

---

\* refer to annexe IV for a list of organisations with activities in this field.

very often lacking. That this is so, is corroborated by the fact that relevant technology has been around for a long time, but even where finances were assured, this has not led to the application of the technology on a wide scale. Small hydropower development has so far mostly been done on an ad-hoc basis, without definite objectives on a nationwide scale. Concluding from analyses of the present situation in a number of regions,<sup>79)</sup> some of the ingredients lacking apparently are:

- Clear policies pertaining to water rights, licencing procedures, rural electrification and small hydropower in particular, and also the use of energy for productive applications.
- A practical institutional framework geared to the requirements of small hydropower development in all its aspects.
- Knowledge of the general and specific magnitude of available resources on one hand and energy demand on the other, resulting from above.
- Trained manpower, budget allocations and formulation of specific requirements in overall development plans. All as a result of preceding points.

## 1. POLICIES AND INSTITUTIONS

Concerning hydropower development, the most common state at present is still one of central (state) control. **Water rights and licencing procedures** are geared towards the end of a state **monopoly**, with a very restrictive and not a promotive practice adopted in dealing with development initiatives. Where, in addition, small schemes are treated in the same way as large ones, the danger of a loss of interest on all levels is evident. A **legal framework** is necessary. No doubt, its aim should be to control and coordinate all **water-resource needs** in a wider context, and perhaps less the continuation of a monopoly situation at a time when each kWh produced by hydropower, may be considered to be in the national interest. A fundamental constraint in the large scale dissemination of small hydropower, can be removed by the formulation of an **open policy**, under which local and individual initiative is not only permitted but is **encouraged**. A degree of state control, on the other hand, is necessary in the interest of all. For it to be effective and fair, it appears that it should be delegated to the lowest possible level. This may be on the level of the **drainage-area** concerned, or perhaps even on the village level. The People's Republic of China may be quoted once more as an example where an appropriate policy exists. One may first

---

79) refer to: OLADE, Regional SHPS Program ..., Quito 1980 and UNIDO, report, Kathmandu 1979 and UNIDO, report, Manila 1980

note the overall maxim of "walking on two legs", that stresses small developments in parallel to large schemes. This has been the policy responsible for the large-scale dissemination already achieved. On the implementation side, various levels of government are concerned which the following citation may show: "At the central government level, the Bureau of Farmland Water Conservancy is responsible for the planning and construction of small hydropower stations. Its specific task is to coordinate countrywide the planning and integration of the small stations, to guarantee optimal interconnection of isolated stations and to promote the production of the required equipment at county and province level. The planning is based on the 5 year plans of the communes (as the smallest administrative unit), which are approved at county level for projects smaller than 500 kW and at province level for larger projects."<sup>80)</sup> It may be added that the first step in projects is taken by the communes. For the formulation and technical details, the county waterbureau assists, and thus promotes local initiatives. The communes on their part define their needs based on consultations with individual settlements and thus, while there is central planning, this directly relates to the needs of the rural population, because all local development plans together form the data-base on which the central government acts.<sup>81)</sup> It is clear that other countries with different social structures may require a different organisation to deal with hydropower development. It would in most cases be impossible or impractical to copy the Chinese system. The point to be learned from is much rather that projects and decision-making bodies are related in size, and the authority is on the lowest possible level, without the loss of central overall coordination.

Besides of legal and organisational policies, there are a number of other areas requiring clear guidelines. An important question is which institutions or agencies - be it governmental, communal or private - should best be involved in hydropower development, and at what level and for which specific aspect.

There are basically two groups of problems that require the attention of appropriate institutions. The first group is common to all rural electrification projects, be it hydro, another source of isolated power supply, or extensions

---

80) SATA/UMN, Report on Study tour, p 35 (this report is available from SKAT)

81) see also SATA/UMN, p 4 f.

from a grid-system. The second group of problems concerns specifically hydro-power development which will require organisational involvement, in addition to the basic institutional structure that usually already exists to take care of the first problem group. The World Bank gives an outline of institutional problems in their publication "Rural Electrification".<sup>82)</sup> Material therefrom has been adapted here, with hydro-specific elements added.

#### a) Tasks and Responsibilities

The interdependence of the many elements of an investment program is such that the program's success can be undermined by a failure in any one of them. This includes the institutional arrangements for running the program. At the local level of responsibility, for example, negligence in billing or a lack of trained personnel to repair faults can discredit the program within the locality. At a more central level of responsibility, such lapses as inappropriate or bad **pricing-policies** may eventually discredit the program nationally, however successful the other aspects of the program may be. Analysis of institutions, therefore, requires a careful look at each of their elements. In discussing this problem, it is convenient to classify the elements in terms of who is responsible for them - that is, in terms of organisation.

The diversity of tasks connected with rural electrification programs requires special institutional arrangements at all levels of administration: namely, at the levels of the **government, executing agencies, and the local administration** in the rural areas. The division of responsibilities between these three levels depends partly on conditions and partly on the nature of the tasks. The table fig. 83 lists the more important tasks and how they are sometimes allocated, although the allocation obviously changes from case to case.

Where the country has a significant rural development program, a need clearly exists for the public sector to take an active interest in order to promote coordination between investment in related sectors, particularly in agriculture, irrigation, agro-industries, and other rural infrastructure projects, such as roads, schools, water, and health. In addition, where the country is large, and electricity is generated and distributed by independent regional utilities, a

---

82) World Bank, Rural Electrification, p 60 ff.



**Fig. 83:**

**Typical Tasks and Divisions of Responsibilities in Rural Small Hydropower Development**

Source: Adapted from World Bank, Rural Electrification

Task	Main responsibility of:		
	Public sector	Executing agency	Local institution
Identification of potential	X	X	X *
Project formulation		X	X
Economic analysis and linkage with development aims	X	X	
Program directives and ground rules	X	X	
Identifying power requirements		X	X
Engineering planning		X	X
Equipment procurement		X	X
Construction		X	X
Plant operation		X	X
Maintenance			X
Identification			X
Repairs		X	X
Promoting regional cooperation	X	X	
Training		X	
Supervision		X	X
Accounting		X	X
Record keeping		X	X
Billing			X
Consumer relations			X
Load promotion and management		X	X
Transfer of technology and know how	X	X	
Acceptance standards for equipment and plant	X	X	
Finance	X	X	
Tariffs	X	X	X

\* An "x" in more than one column indicates that the task may be performed jointly, or by any one of the institutions.

central government agency (such as REC\* in India) may be needed to promote standardisation, cooperation between regions, and a regional balance in the rural electrification program.

Another function for the public sector is to provide general directives and ground-rules for tariff and financial policies, the allocation of funds, and

\* Rural Electrification Commission

the criteria to be used for project appraisal and selection. This is traditional, except that the scope of the directives and ground rules needs widening to cover the special problems of rural electrification and, in particular, isolated, small hydropower stations. Much of the public sector's involvement needs to be indirect only, if the ground rules and directives are well laid. A specific function of the public sector may also be to approve equipment designs of local manufacturers; to compare such designs and conduct performance tests. This may permit end users of the technology to select equipment, based on an objective technical appraisal.

Much of the public sector's policy needs to be worked out jointly with executing agencies who are primarily engaged in implementing projects, and therefore have an intimate knowledge of local reality. Questions on tariffs, financing, the setting up of programs and overall potential assessment are thus best done jointly. The responsibilities of executing agencies are in the areas of site identification, formulation of projects, engineering design and construction, decisions on the appropriate quality of service, procurement and contracting. Of much importance, although this is sometimes neglected, are providing of advice and supervision as well as facilities for the training of personnel of the local institutions. Also, a task that is often not carried out at all, is active load-promotion and effective load-management, in which local institutions require considerable assistance from executing agencies.

#### b) Which Institutional Arrangement Is Best?

There is no clear answer to the question of which institutional arrangement is best. The main debate is about the extent to which the responsibilities just outlined should be delegated to the local administration. It is sometimes said that the executing agencies can assume the responsibilities quite well, also in the operative stage of a project, with the additional advantage that the more talented and motivated people can, in working at the centre, spread their efforts more widely. On the other hand, if such centrally appointed personnel is delegated to a small hydropower station to operate it, personnel costs are likely to be high in relation to usually modest revenues of such a plant. It is often stated that operating costs of small hydropower stations are high. This need not be true, if the underlying principle of the institutional arrangement is one of marginality, while still maintaining efficient operation.

In practice, it is necessary to be flexible in deciding the form of organisation. On the one hand, several arrangements may work well; on the other hand, different arrangements suit different countries and cultures.<sup>83)</sup>

### c) A Country Example

Experience in Nepal may be of interest in this context: at the outset, when turbine development was taken up by a local manufacturer, there was virtually no institutional set-up capable of taking care of all related aspects of hydropower development. Consequently, only very few turbines could be sold to daring customers who somehow tackled the problem of financing, site identification, licencing, and installation. To improve the situation, personnel of the manufacturing company was engaged in site-identification surveys and later in installation activities, training of personnel, and maintenance on existing stations. The Agricultural Development Bank at the same time conducted introduction courses for their field personnel to enable them to assess project feasibility from the lending point of view and took up financing of small hydro installations on a sustained basis, taking into account the specific nature of such investments (e.g. longterm, slow return) in the loan repayment requirements. Licencing authority is traditionally on the local level, so that there was no major problem in this area.

The arrangement of institutional involvement was further refined in the following years. Manufacturers (three of them by now) set up specialised installation-units within or affiliated to the company, whose job is to carry through projects from their very inception to the point of regular check-up's during operation. Projects that are executed are always based on a productive activity such as agro-processing or lift-irrigation (refer also to section E.2), and stations are usually privately owned.

In the case of larger projects, but still in the micro-range (e.g. the example in section E.1), the various manufacturer's specialised units cannot cope with all the tasks necessary. Two government agencies were set up to handle projects in the micro- and mini-range respectively, with a third agency, a private limited company, working as a contractor on the mini-scale of projects. Site identification on this scale of operations is usually done by small engineering

---

83) Material used from World Bank, Rural Electrification, p 60 ff.

consultant firms aided by the local authorities, followed by a feasibility study. Detail surveys are then done jointly by one of the manufacturers or the hydro contractors team, with the respective government agency. In the execution stage, engineering design is split into penstock and equipment layout on one hand, and all the rest on the other, as is actual construction and installation work.

The executing agencies here, are the relevant government agency or the hydro-contractor, and the manufacturers team respectively, while electricity-transmission and distribution are taken care of by the government agencies themselves, or are contracted to one of the few local electrical engineering firms.

The several manufacturers of equipment are today in a situation of competition with each other, as are the engineering consultant firms. This has an impact on quality-wise and cost-wise performance. It may be noted that co-operation in hydraulics technology exists among some of the manufacturers despite competition. This is due to the large potential market that bears promise for intensified activities in the future. No one would like to see the failure of a competitor's project in this situation, because it could discredit hydropower development in the area concerned.

The attitude of government authorities in the early phase of activities is also remarkable: requirements of performance and reliability of local equipment was relaxed deliberately to encourage manufacturers. Workshops with no prior experience in equipment manufacturing got the chance to develop skills without having to face undue risks, as did consulting engineers in the case of site-surveys. As previously mentioned, this has led to the situation of competition in which steady technological improvements are evident.

On the operation and ownership-side finally, several arrangements exist. One of the larger stations (but still in the small-scale) is operated successfully as a private limited company, while others are under direct control of a central government agency. Micro plants are often owned and operated privately, as mentioned, while co-operative ownership is also existing. It is still too early to say what institutional structure is the most suitable, except perhaps that institutions that are located geographically close to the hydropower station

under their control, are at an advantage.

#### d) The Need for Training

A number of seminars <sup>84)</sup> on the development of small hydropower have identified problems of insufficient capacity for planning, designing, construction, and operation of hydro stations. This translates primarily into a lack of **know-how** and **skills** in the specific area in many developing countries. It is evident that knowledge on all levels - from policy-makers to plant operators - is a necessity and it is encouraging to see that a lot is already being done about this situation. There is a trend of increasing numbers of seminars and workshops that become more and more meaningful as interantional expertise is built up. This is indeed very valuable on the level of higher cadres. More on the practical side, in project execution and plant operation, individual countries have an important role to play. As pointed out throughout this paper, hydropower development is highly situation-specific. On the job training should therefore be regarded as the most effective instrument. Governments could plan and execute **pilot-projects** that are deliberately **overstaffed**, to give as many training opportunities as possible. In this way, a stock of personnel would be trained that could be engaged in further projects, where again new people could be trained. The **multiplicator-effect** thus initiated, could form the basis of a **skill-bank**, permitting substantial dissemination after a relatively short time.

It should be noted that training on the civil engineering side should be different from that oriented to big project development, because a **non-conventional** approach is usually necessary in small hydro projects, as far as materials and working techniques are concerned. Another point is that people assigned to big projects on the higher level, tend to be specialised in one specific activity, while in small projects **generalists** are required.

## 2. FINANCE

The lack of **financial means** is one of the principal factors limiting technological development and its dissemination in general. This is particularly true in hydropower development for two reasons: First, hydropower is of a capital-

---

84) See for instance UNIDO, Kathmandu 1979, Manila 1980, and NRECA, Quito 1980

**intensive** nature, which cannot be reduced beyond certain limits. Second, the benefits of hydropower in rural areas are often more on the **social** side. Money-wise returns are slow, and in situations where there is open competition for capital, scarce financial resources tend to be absorbed by technologies that promise quicker returns. Commercial money therefore is likely to make up only a relatively small part of finances in all the areas of hydro development. The substantial part should rather come from sources as used for other infrastructural development projects, such as, but not limited to, the regular state budget, development funds, and bilateral and multilateral donor agencies.

Activities that will affect the long-term future of a country must be regarded as an investment which cannot be recovered in financial terms. Specific to hydro development this may include meteorological, hydrological and topographical service, potential-assessment surveys, information-processing, training and the construction of pilot plants for this purpose, and also initial financial assistance to potential equipment manufacturers and contractors. The first few items of this list are usually regular activities in the charge of a government department. Within the framework of overall priorities, these should get appropriate budget allocations.

Assistance to **entrepreneurs** may be in the form of **grants** and could well turn out to be very effective. If, for instance, a few prototypes are financed along with the provision of design blue-prints, this may result in sufficient build-up of capability, which a manufacturer could make **self-supporting** without having to bear the initial risk. In addition, some equipment for production and testing might be required which could be financed with a grant or a soft loan. Exactly this was done from bilateral co-operation sources in the case of the manufacturer **BYS** in Nepal, where in addition to finances for prototypes, equipment was provided for a **testing-facility**, since no national laboratory of the kind required was in existence. The result of this relatively limited input is by now a manufacturing capacity of around twenty turbine-units per year, including accessories and auxiliary items, in part replacing previous activities in general mechanical- and structural-engineering.

Persuading the concept of **on the job training**, financing in this area would consistently have to be included in actual projects. If such a project is of

a pilot-nature or is destined to be a demonstration unit, it may be considered as a long-term investment, financed on a non-recoverable basis.

Regular project financing finally, requires a high degree of flexibility in its approach. Loans in particular should be adapted to the long-life characteristic of hydropower stations with corresponding grace periods and repayment terms. Depending on internal resources, external funding will often have to be sought in the form of grants or long-term soft loans. It is clear that in the interest of self-reliance, the portion of external financing should be as small as feasible. Whether grants or loans are desirable, will depend on the nature of the particular project. If extensive productive use of power is feasible, it may be the consumers themselves who are able to repay a loan, given a long enough period. If benefits, on the other hand, are intangible in monetary terms - in a project that is justified by its expected social impact - an outright grant-component will be more realistic than a permanent obligation of subsidising.

Local involvement in financing is very desirable and should be taken advantage of to the largest extent possible. This is apt to foster interest in efficient station-operation and management, even if the local component of overall funding is relatively small. It is obvious, however, that local participation is not possible in many cases. An uniform policy is unlikely to be satisfactory. Indeed there is no reason to treat different situations equally.

One way of generating internal funds for small hydropower development may be quoted here as a practical example: A "Rural Electrification Fund" has been established in Ecuador, supplied with money of a surtax on electricity bills for commercial and industrial consumers. Under this plan, 10 percent of the invoiced value of electricity consumed by industrial clients, with an installed load greater than 10 kW, and by commercial clients, with a monthly consumption of more than 2'500 kWh, goes to the Rural Electrification Fund. The money so collected is used by the concerned government agency for project activities, and is expected to amount to 5.6 million U.S. \$ in 1981 and more than 7.5 million \$ in 1982.

Such a tax seems sensible due to the fact that the industrial and commercial consumers utilise electric power to derive profits from processing goods,

largely consumed in urban areas and it is just, therefore, that they should contribute in this way to the development of rural areas.<sup>85)</sup>

International financing agencies, with the World Bank ranking at the top, intend to make several billion dollars available for the development of energy resources in the next few years, worldwide.<sup>86)</sup> Individual small hydropower stations may not be an attractive proposition in this context, so it might be necessary to seek funding for a package, comprising a number of projects. To make the formulation of such programs possible, preceding action should be in the fields of working out policy guide-lines, in institution-building and in implementing pilot-scale projects.

In conclusion, it seems credible to state that the development of small hydropower has a great potential in aiding rural development. It is technically and economically feasible in a great number of situations and socially desirable. Where potential exists, it is perhaps the best alternative in more than one sense, and there is no reason why this sector should not invoke substantial efforts from the side of governments and local institutions, and interest from private, national and international development agencies. Basic technology required for a plan of action is mature and available today.

---

85) Material used from Viteri in NRECA, p 274 ff.

86) Refer to World Bank, Energy in the Developing Countries, p 72



ANNEXE I

ALPHABETICAL INDEX OF BIBLIOGRAPHY

- Adam, C., BYS Cross-Flow Turbine, Project Design and Manual, Kathmandu 1974
- Adam, C., Study for the Electrification of the Chialsa Handicraft Center, Kathmandu 1974
- ADB/N, Agricultural Development Bank Nepal, Lift Irrigation Project for the Development of Bhorletar Area, Kathmandu 1978
- Alward, R. et al, Micro-Hydropower, Reviewing and old Concept, DOE, Washington, D.C., 1979
- Amann, H., Energy Supply and Economic Development in East Africa, Weltforum Verlag, Munich 1969
- Arter, A., Diplomarbeit: Durchströmturbine, Zurich 1980
- ATDO, Appropriate Technology Development Organisation, 12th six-monthly Report, Islamabad 1980
- Bossard, W.E., Vorläufige Mitteilung über die ausgenutzten Wasserkräfte der Schweiz, Abteilung für Landeshydrographie, Berne 1914
- Brenken, G., Versuch einer Klassifikation der Flüsse und Ströme der Erde nach wasserwirtschaftlichen Gesichtspunkten, Karlsruhe 1959
- Breslin, W.R., Small Michell (Banki) Turbine: A Construction Manual, VITA, Mt. Rainier
- Buchanan & Somers, Discharge Measurement at Gaging Stations, 1969
- Creager, W.P. & Justin, J.D., Hydro-Electric Handbook, John Wiley & Sons, New York 1927
- Dillo, H.-G., Ein Beitrag zur Energieversorgung in Entwicklungsländern, in Mitteilung Nr. 51 des Franzius-Instituts, University of Hannover 1980
- Dumol, P.G. & Denton, F.H., Mini-Hydro Application in the Philippines, UNIDO, Vienna 1980
- ESCAP, Electric Power in Asia and the Pacific 1975 and 1976, United Nations, New York 1978
- Falkenmark, M. & Lindh, G., The Global Freshwater Circulation, in AMBIO, Vol. 3, No. 3-4, 1974

- French, D., The Economics of Renewable Energy Systems for Developing Countries, Washington, D.C., 1979
- GATE, Statusbericht Biomasse II, Direkte und reduzierte Verbrennung, PN. 78.2247.1 - 01.100, Eschborn 1980
- Gautschi, C., Gloor, W., Wong, T.M., Diplomarbeit 1980: Experimentelle Untersuchung einer Durchströmturbine des Typs Banki, HTL Brugg Windisch 1980
- Gladwell, J.S., Hydrologic Studies for Hydropower Assessment, in NRECA, Small Hydroelectric Powerplants, p 22 ff.
- Gladwell, J.S. & Warnick, C.C., Low-Head Hydro, Moscow, Idaho 1979
- Guerrero, J.L., Turbines: Pelton Wheel Governors, VITA 002178, Mt. Rainier
- Grainger, L., Energy Resources: Availability and Rational Use, A Digest of the 10th World Energy Conference, Science and Technology Press, New York 1978
- Grumann, H.R., Mean Velocity of Flow of Water in open Channels, St. Louis 1928
- Haimerl, L.A., The Cross-Flow Turbine, in "Water Power", january 1960
- Hamerak, K., Elektrische Energie aus kleinen Wasserkraften, in "technica" Nr. 5, 1966
- Hamerak, K., Die Ossbergerturbine: die geeignete Antriebsmaschine für bedienungslose Asynchronkraftwerke, in "Energie und Technik", No. 15, May 1963
- Hassanally, M.G. & Reichel, R., Exploiting Mini-Hydropower Stations for Rural Development in Tanzania, Dar es Salaam 1979
- Hiller, B., Manual Calculation of Check Dams, Kathmandu 1979
- Howe, J., et al., Energy for Developing Countries, (draft), Report to the Rockefeller Foundation, 1977
- How Things Work, The Universal Encyclopedia of Machines, Bibliographisches Institut Mannheim, London 1967
- Integration GmbH, Statusbericht Laufwasserenergie, Kleinwasserkraftanlagen, PN. 78.2247.1 - 01.100, Eschborn 1980
- Jackson, B. & Evans, L., Distribution Considerations for Mini/Micro Hydro Projects, in NRECA. Small Hydroelectric Powerplants, p 214 ff.
- Jagdish Lal, Hydraulics and Fluid Mechanics, Metropolitan Book Co., New Delhi
- Kadete, H. & Reichel, R., Experience with Small Hydro-electric Stations in Tanzania, Dar es Salaam 1978

- Krayenbühl, L. & Ledergerber, E., SHDB - Program Evaluation, Final Report, Kathmandu/Zurich 1981
- Kuntz, H., Hydro-electric Power: Rural Electrification through isolated Systems, in "gate" 1/79
- Lausset, H.R., Electrical Low Tension Installations, House and Factory Wiring, Kathmandu 1977
- Litscher, J., Salleri/Chialisa Small Hydel Project, Kathmandu 1979
- MacKillop, A., Hydropower, Wadebridge 1975
- Mata, J., Design Criteria of Typical Civil Works for Mini-Hydropower Plant Projects, in NRECA, Small Hydroelectric Powerplants, p 145 ff.
- Maucor, M., Les Microcentrales Hydrauliques, GRET, Paris 1979
- Meier, U., Lausset, H.R., Wirz, W., Salleri/Chialisa Micro-Hydel Project: Project Proposal and Report, Kathmandu 1976
- Meier, U., Manual for the Design of a simple Mechanical Water-Hydraulic Governor Kathmandu 1979
- Meier, U., Small Scale Water Power Development, Photo-documentation, Kathmandu 1979
- Meier, U., Small Scale Water Power Development, St. Gall 1981
- Mother Earth News, Cross-Flow Turbine Plans, 1980
- Nakarmi, A.M., Cottage Multi-Purpose Power Unit for Rural Areas in Nepal, Kathmandu 1980
- Noyes, R., (editor), Small and Micro Hydroelectric Power Plants, New Jersey 1980
- NRECA, National Rural Electric Cooperative Association, Small Hydroelectric Powerplants, Proceedings of Workshop in Quito, Ecuador 1980, Washington 1980
- OECD, The Electricity Supply Industry, 24th to 26th Enquiries, Paris 1978
- OLADE, (Latin-American Energy Organisation), Regional SHPS Program: Prospects and Requirements for the Promotion of Technological Cooperation of the Latin American Energy Sector, Quito
- OLADE, Requirements and Methodology for the massive Implementation of Small Hydropower Stations in Latin America, Quito
- Palmedo, P.F., et al., Energy Needs, Uses and Resources in Developing Countries, U.S. A.I.D. Springfield 1978

- Peck, R.B. et al., Foundation Engineering, Wiley & Sons, London 1974
- Pittet, A., Study on an Electronic Load Controller, EPFL, Lausanne 1978
- Reddy, A.K.N., The Design of Rural Energy Centres, in "Rural Technology", p 109, Bangalore 1980
- SATA/UMN, Report on Study Tour on Water Resources Development in China, 19.8. to 12.9.1980, Kathmandu 1981
- Scheurer, H., Metzler, R. & Yoder, B., Small Water Turbine, Instruction Manual for the Construction of a Cross-Flow Turbine GATE-Modul 1/13, Eschborn 1980
- Smil, V., China's Energy, New York 1976
- Statistik der Wasserkraftanlagen der Schweiz, Berne 1928
- Statistisches Jahrbuch der Schweiz, 1950, Basle
- Stern, P. et al., Gabions for Hydraulic Structures, in "Appropriate Technology" Vol. 7, No. 4, London 1981
- SVMT/LAI, Schweizerische Vereinigung für Mittlere Technologie/Lateinamerikanisches Institut, Erfahrungen mit dem Einsatz von Sonnenkochern in Entwicklungsländern, St. Gall 1976
- UNCNRSE, United Nations Conference on New and Renewable Sources of Energy, Conference News 1-6 in ASSET, UN-University, Tokyo 1981
- UNESCO-WMO, Design of Water Resources Projects with inadequate Data, Proceedings of Madrid Symposium 1973
- UNIDO, Draft Report on Seminar-Workshop on the Exchange of Experiences and Technology Transfer on Mini Hydro-Electric Generation Units at Kathmandu, Vienna 1979
- UNIDO, Issue Paper for the Second Seminar-Workshop in the Development and Application of Technology for Mini-Hydro Power Generation at Hangzhou and Manila, Vienna 1980
- UNIDO, Report on Second Seminar-Workshop/Study Tour in Development and Application of Technology for Mini-Hydro Power Generation at Hangzhou and Manila, Vienna 1980
- United Nations, Electric Power in Asia and the Far East, ECAFE Bangkok 1957
- United Nations, Proceedings of Regional Seminar on Energy Resources and Electric Power Development, ECAFE, Bangkok 1962
- United Nations, Rapport du Groupe Technique de l'Energie Hydraulique, UNCNRSE secretariat, New York 1981

**United Nations**, Dept. of Economic and Social Affairs, Natural Resources of Developing Countries: Investigation, Development and Rational Utilization, Report of the Advisory Committee on the Application of Science and Technology to Development, New York 1970

**U.S. Bureau of Reclamation**, Earth Manual: a Guide to the Use of Soils as Foundations and Construction Materials for Hydraulic Structures, Denver 1960

**Vischer, D. & Huber, A.**, Wasserbau, Springer-Verlag, Berlin 1979

**VITA**, The Planning, Installation and Maintenance of Low-Voltage Rural Electrification Systems and Subsystems, Mt. Rainier 1979

**Viteri, H.**, Financial Aspects, in NRECA, Small Hydroelectric Powerplants, p 274 ff.

**Water Power and Dam Construction**, various articles on Mini-Hydro, January 1979

**Wilson, P.N.**, Water-Driven Prime Movers, in Engineering Heritage, Vol. 1, VITA 001686, Mt. Rainier

**World Bank**, Energy in the Developing Countries, Washington, D.C. 1980

**World Bank**, Rural Electrification, Washington D.C. 1975

**Wright, D.L.**, An Appraisal of Some Recent Micro-Hydro Installations in Nepal, ITIS, Rugby

ANNEXE II

GLOSSARY OF ABBREVIATIONS USED

AC:	Alternating Current
ADB/N:	Agricultural Development Bank Nepal
ATDC:	Appropriate Technology Development Organisation, Islamabad, Pakistan
BEW:	Butwal Engineering Works, private limited, Butwal, Nepal
BYS:	Balaju Yantra Shala private limited, Kathamndu, Nepal
CEDT:	Centre for Electronics Design Technology, Bangalore, India
CMEC:	China Machinery Export Corporation, Beijing, China
DC:	Direct Current
DOE:	U.S. Department of Energy
EAP & L:	East African Power and Lighting Company, Ltd.
EPFL:	Ecole Polytechnique Fédérale, Lausanne, Switzerland (Swiss Federal Institute of Technology)
ESCAP:	Economic and Social Commission for Asia and the Pacific, Bangkok, Thailand
ETHZ:	Eidgenössische Technische Hochschule, Zürich, Switzerland (Swiss Federal Institute of Technology)
GATE:	German Appropriate Technology Exchange, Eschborn, Federal Republic of Germany
GRET:	Groupa de Recherche et d'Echanges Technologiques, Paris, France
GWh:	Giga Watthour (see also Annex V)
HMG:	His Majesty's Government of Nepal
HP:	Horsepower (see also Annex V)
HPS:	Hydropower Station
H.T.:	High Tension (>1000 V)
HTL:	Höhere Technische Lehranstalt (Swiss Engineering College)
Hz:	Hertz = cycles per second
IER:	Internal Economic Rate of Return
kg:	kilogram
kgce:	kilogram coal equivalent (see also Annex V)
kgce/c.y.:	kilogram coal equivalent per capita and year
km:	kilometer = 1000 m
kVA:	kilo Volt Ampère, equivalent to kW at a power factor of 1 (Apparent Power)

kWh:	kilo Watthour (see also Annex V)
LDC:	Least Developed Country as per U.N. definition
LNG:	Liquid Natural Gas
LPG:	Liquid Petroleum Gas
l/s:	liters per second
L.T.:	Low Tension (<1000 V)
m:	meter
mm:	millimeter, 1000 mm = 1 m
m <sup>3</sup> /s:	Cubic meters per second (Unit for Mass Flow Rate)
MW:	Mega Watts (see also Annex V)
NEA:	National Energy Administration of Thailand, Bangkok
NRECA:	National Rural Electric Co-operative Association, Washington, D.C., U.S.A.
NRs:	Rupees, Nepal-currency, NRs 12 = U.S. \$ 1
OECD:	Organisation for Economic Co-operation and Development, Paris, France
OLADE:	Organizacion Latinoamericana de Energia (Latin-American Energy Organisation, Quito, Ecuador)
PE:	Polyethylene
PVC:	Poly Vinyl Chloride
RPM:	Revolutions per Minute
SATA:	Swiss Association for Technical Assistance in Nepal comprising the Swiss Government Development Co-operation and HELVETAS, a non-profit organisation, Kathmandu, Nepal
SHDB:	Small Hydel Development Board, Department of Electricity, Kathmandu, Nepal
SKAT:	Schweizerische Kontaktstelle für Angepasste Technik (Swiss Center for Appropriate Technology) St. Gall, Switzerland
TANESCO:	Tanganyika Electric Supply Company, Ltd.
UEB:	Uganda Electricity Board
UMN:	United Mission to Nepal
UNCNRSE:	United Nations Conference on New and Renewable Sources of Energy (to be held August 81 in Nairobi, Kenya)
UNESCO:	United Nations, Economic, Social and Cultural Organisation
UNIDO:	United Nations Industrial Development Organisation, Vienna, Austria
U.S. A.I.D.:	United States Agency for International Development
VITA:	Volunteers in Technical Assistance, Mt. Rainier, U.S.A.
W:	Watt (see also Annex V)
WMO:	World Meteorological Organisation, Geneva, Switzerland

ANNEXE III

ALPHABETICAL MANUFACTURER'S LIST

**Balaju Yantra Shala private limited**

P.O. Box 209, Balaju

Kathmandu, Nepal

- General engineering firm specialising in the manufacture of Cross-Flow turbines and related equipment. Standardised turbine program within output capacity of max. 70 kW/unit.

**Barata Metalworks & Engineering P.T.**

Jalan Kaplen P. Tendean 12-14

Jakarta, Indonesia

- Heavy industry and general engineering firm. Manufacture Francis- and Cross-Flow turbines occasionally upto 450 kW capacity.

**Bell, Maschinenfabrik AG**

6010 Kriens/Lucerne, Switzerland

- Highly specialised firm with a standard range of newly developed S-Propeller turbines from 0.1 - 1 MW capacity. Also manufacture large units of Francis and Pelton.

**Butwal Engineering Works**

Butwal, Nepal

- General engineering firm specialising in the manufacture of Cross-Flow turbines and related equipment. Standardised turbine program within output capacity of max. 70 kW/unit.

**China National Machinery Imp & Exp Corporation**

12 Fu Xing Men Wai Street

Beijing, PR China

- Exporters of Small Hydro turbines 12 to 12'000 kW of Francis, Pelton, Kaplan and Turgo-type.

also: - Alternators upto 12 MW capacity

- Speed governors of various types and other accessories.

**Disag Dieselmotoren AG**

7320 Sargans, Switzerland

- Manufacturer of Cross-Flow turbines and Pelton turbines in the small range. Also produce a small governor.



**Drees GmbH**

Postfach 43

4760 Werl, Federal Republic of Germany

- Manufacture a variety of Pelton and Francis turbines in the small range.

**Elektro GmbH**

St. Gallerstrasse 27

8400 Winterthur, Switzerland

- Manufacture small Pelton sets with output upto 25 kW beside non-related other equipment.

**GEC Machines Limited**

Mill Road

Rugby, Warwickshire, England CV21 1BD

- Manufacturer of complete electrical generating equipment with capacities form approx. 500 kW to 10 MW

**Gilbert Gilkes & Gordon Ltd.**

Kendal, Cumbria, England LA9 7BZ

- Manufacturer of Francis, turgo and Pelton-turbines with capacity upto 350 kW.

Also manufacture control equipment beside other non-related products.

**James Leffel & Co.**

426 East Street

Springfield, Ohio 45501 USA

- Manufacturer of a large range of Kaplan, Francis and Pelton turbines from a few kW upto the MW range

**Jyoti Limited**

R.C. Dutt Road

Baroda 390 005, India

- Manufacturer of a range of water turbines more or less according to the program of Gilkes, including alternators and associated equipment.

**Koessler GmbH**

St. Georgener Hauptstrasse

3151 St. Pölten, Austria

- Manufacture Pelton, Francis and Kaplan turbines in the small range

**Leroy-Somer**

Boulevard Marcellin Leroy

B.P. 119

16004 Agouleme Cédex, France

- Manufacturer of a large range of standard alternators from 4 kW to 1'200 kW. Also produce a bulb turbine with built-in alternator for low-head installations upto 34 kW output.

**Mitsubishi electric Corporation**

Nagasaki, Japan

- Manufacture a very small bulb turbine with 4 kW output for very low-head application.

**Nikki Corporation, Engineering Company**

2940 Shin Yoshidamachi

Koohoku

Yokohama, Japan

- Have recently started manufacture of Cross-Flow turbines upto 800 kW output.

**Ossberger-Turbinenfabrik**

Postfach 425

8832 Weissenburg, Bavaria, Federal Republic of Germany

- Longtime producer of Cross-Flow turbines. Have delivered equipment up to 1'000 kW per unit.

**Peltech Hydraulic Turbines**

5141 Wickersham, Acme, Washington 98220, USA

- Manufacture small Pelton turbine-sets.

**Sukaraja, C.V.**

Jalan Kom. Ud.

Supadio 98

Bandung, Indonesia

- Manufacture Cross-Flow turbines of local design

**Tamar Designs Pty. Ltd.**

Deviot, Tasmania 7251, Australia

- Manufacture Francis, turgo and Pelton turbines upto about 100 kW capacity.

**Turbomeccanica Düsol SA**

6807 Taverne, Switzerland

- Manufacture a range of turbines including all accessories.

**Voit GmbH**

Postfach

7920 Heidenheim, Federal Republic of Germany

- Manufacture Vertical Francis turbines 50 to 2'000 kW.

**Woodward Governor Company**

Engine and Turbine

Controls Division

Ft. Collins, Colorado, USA

- Manufacture a variety of speed governors of high quality.

ANNEXE IV

ALPHABETICAL LIST OF INSTITUTIONS AND ORGANISATIONS INVOLVED IN HYDRO DEVELOPMENT

**ADB/N, Agricultural Development Bank**

Putali Sadak

Kathmandu, Nepal

- Local financing agency for a large number of small productive-use, hydro-projects.

**ATDA, Appropriate Technology Development Association**

Projects Division

P.O. Box 311, Gandhi Bhawan

Lucknow 226001, India

- Have taken up integrated village development projects, based on hydro-electricity plants.

**ATDO, Appropriate Technology Development Organisation**

1-B, 47th Street, F-7/1

Islamabad, Pakistan

- Work on more than twenty small hydro projects using local Cross-Flow turbines in the output range from 3 to 20 kW

**DEH, Directorate for Development Co-operation and Humanitarian Aid, of the Swiss Government**

Eigerstrasse 73

3003 Berne, Switzerland

- Sponsoring agency for hydro development activities (among other things) in Nepal and elsewhere.

**DIAN DESA, Appropriate Technology Organisation**

Jalan Kaliurang km7,

Juruksari, P.O. Box 19, Bulaksumur

Yogyakarta, Indonesia

- Work on village electrification projects with their own design of Cross-Flow turbine.

**ETHZ, Institute for Fluid-Technology**

Sonneggstr. 3, 8092 Zurich, Switzerland

- Technical consulting in small hydro development.

**GATE, German Appropriate Technology Exchange**

Dag Hammerskjöld-Weg 1

6236 Eschborn, Federal Republic of Germany

- Have published a manual on Cross-Flow turbine construction and other related manuals. Maintain an enquiry-service and information network.

**GRET, Groupe de Recherche et d'Echange Technologiques**

34, rue Dumont-d'Urville

75116 Paris, France

- Have published an introductory manual on micro-hydro generation. Maintain an enquiry-service and information network.

**HELVETAS**

St. Moritz Strasse 15

8042 Zurich, Switzerland

- Sponsoring and executing agency of Cross-Flow turbine development at BYS in Nepal.

**ITB, Institute of Technology Bandung**

Departemen Mesin

Jalan Ganesha 10

Bandung, Indonesia

- Have implemented about ten small hydro-projects so far, with their own design of Cross-Flow turbine.

**ITDG, Intermediate Technology Development Group**

9 King Street

London WC2E 8HN, U.K.

- Technical consulting and development activities in small hydro projects. Have collaborated in electronic load controller development.

**ITIS, Intermediate Technology Industrial Services**

3rd floor Mayson House, Railway Terrace

Rugby, CV21 3HT, U.K.

- Project executing agency of ITDG collaborating with BEW in Nepal (among others).

**ITINTEC, Division de Energia**

Apartado 145

Lima, Peru

- Have developed a range of Cross-Flow turbines and associated equipment for local manufacture.

**NEA, National Energy Administration of Thailand**

Pembultan Villa, Yose

Bangkok 5, Thailand

- Have developed Cross-Flow turbines for local manufacture and implement hydro projects in the small range.

**NERD-Centre, National Engineering Research and Development Centre**

Ekala Ja Ela, Sri Lanka

- Have developed Cross-Flow turbines for local manufacture.

**NRECA, National Rural Electric Co-operative Association**

1800 Massachusetts Avenue, N.W.

Washington, D.C. 20036, U.S.A.

- Assisting in small hydro development in developing countries on behalf of U.S. A.I.D.

Have organised a workshop in Quito 1980 on small hydro and have published proceedings thereof. Further workshops are to follow elsewhere.

**OLADE, Organizacion Latinoamericana de Energia**

Casilla 119-a

Quito, Ecuador

- Are promoting and disseminating small hydro technology in Latin America.

**RCTT, Regional Centre for the Transfer of Technology**

Manickveen Mansions, Box 115

49 Palace road

Bangalore 560052, India

- Are disseminating small-hydro technology in the ESCAP region. Have collaborated in organising the Kathmandu 1979 workshop on small-hydro with UNIDO.

**RECAST, Research Centre for Applied Science and Technology**

Tribhuvan University

Kirtipur Campus

Kathmandu, Nepal

- Are collaborating in the local development of improved water-wheels such as the Multipurpose Mini-Power Unit.

**SATA, Swiss Association for Technical Assistance**

P.O. Box 113

Kathmandu, Nepal

- Is the local agency of DEH and HELVETAS collaborating with BYS and SHDB on small hydro development (among other activities).

**SHDB, Small Hydel Development Board**

Bagh Bazaar

Kathmandu, Nepal

- Project implementing agency of HMG Electricity Department.

**SKAT, Swiss Center for Appropriate Technology, at ILE, Institute for Latin-American Research and for Development Co-operation, University of Saint-Gall**

Varnbuelstrasse 14

9000 St. Gall, Switzerland

- Technical documentation and consulting in small hydro development (among other activities). Development of Cross-Flow turbine T3 in collaboration with other institutions in Switzerland.

**SPATF South Pacific Appropriate Technology Foundation**

P.O. Box 6937

Boroko Papua New Guinea

- Work on village electrification projects based on hydropower.

**THE, Technical University of Eindhoven**

Den Dolech 2

Postbus 513

5600 MB Eindhoven, The Netherlands

- Development of Cross-Flow turbine in collaboration with ITB, Bandung. Also thesis work on other turbine types and load controllers.

**UMN, United Mission to Nepal**

Thapathali

Kathmandu, Nepal

- Sponsoring agency for small hydro development activities in BEW, Butwal and other local organisations.

**UNIDO, United Nations Development Organisation**

Lerchenfeldstrasse 1

P.O. Box 707

1011 Vienna, Austria

- Are promoting and disseminating small hydro technology. Have organised workshop and study tour on small hydro at Hangzhou, Manila 1980

**VITA, Volunteers in Technical Assistance**

3706 Rhode Island Ave.

Mt. Rainier 20822, Maryland, U.S.A.

- Information and documentation on small hydro technology within a comprehensive renewable energy program.



ANNEXE V

STANDARD ENERGY CONVERSIONS

Unit	Abbreviation	(Equivalent Values Lie in Vertical Columns)												
Barrels per Day Oil Equivalent (a)	BDOE	---	---	---	---	---	---	---	---	---	.013	1	1.6	2.74
Metric tons of Coal Equivalent (b)	Mtce	---	---	---	---	---	0.05	0.21	1	77.5	125	212		
Barrels of Oil Equivalent (c)	BOE	---	---	---	---	---	.0047	0.25	1	4.7	365	586	10 <sup>3</sup>	
Kilograms of Coal Equivalent	kgce	---	---	---	---	---	1	53.5	212	10 <sup>3</sup>	77.5	125	212	
Kilocalories per Day (a)		---	---	---	---	---	18.7	1000	3970	18.7	1.45	2.33	3.97	
Kilowatthours (10 <sup>3</sup> watt-hours)	kWh	0.28	---	---	---	1	8.0	428	1700	8000	0.62	10 <sup>6</sup>	1.7	
Kilocalories (10 <sup>3</sup> calories)	kcal	240	0.24	0.25	1	860	6.9	3.65	1.45	6.9	530	860	1.45	
British Thermal Units	BTU	950	0.95	1	4.0	3413	27.3	1.46	5.8	27.3	2.12	3.4	5.8	
Kilojoules (10 <sup>3</sup> joules)	kJ	---	1	1.06	4.2	3600	28.8	1.54	6.1	28.8	2.24	3.6	6.1	
Mega joules	MJ	1	0.001	0.0011	0.0042	3.6	28.8	1.54	6.1	28.8	2.24	3.6	6.1	

- (a) Equivalentents in other units are shown on a per annum basis. For example, one barrel per day of oil, maintained for a year, equals 2.24 x 10<sup>9</sup> kilojoules.
- (b) One metric ton = 1000 kilograms = 2202 pounds = 1.1 short tons.
- (c) One barrel of oil = 5.8 million BTU.

STANDARD POWER CONVERSIONS

Unit	Abbreviation	(Equivalent Values Lie in Vertical Columns)									
Watt	W	1	1000	$10^6$	$10^9$	9.81	735.5	1	4185.9	1055.1	
kilo Watt	kW	0.001	1	1000	$10^6$	0.0098	0.736	0.001	4.19	1.06	
Mega Watt	MW	---	0.001	1	1000	---	---	---	0.0042	0.0011	
Giga Watt	GW	---	---	0.001	1	---	---	---	---	---	
Meter-kilogram -force per second	mkp/s	0.102	102	1.02	1.02	1	75	0.102	427	107.6	
				$\times 10^5$	$\times 10^8$						
Horse power	HP	0.0014	1.36	1359.6	1.36	0.0133	1	0.0014	5.69	1.43	
					$\times 10^6$						
Joule per second	J/s	1	1000	$10^6$	$10^9$	9.81	735.5	1	4185.9	1055.1	
kilo Calorie per second	kcal/s	---	0.24	238.9	2.4	0.0023	0.1757	---	1	0.2521	
					$\times 10^5$						
British Thermal Unit per second	BTU/s	0.0001	0.95	947.8	9.5	0.0093	0.6971	0.0001	3.97	1	
					$\times 10^5$						

## SKAT PUBLICATIONS

SERIES: HARNESSING WATER POWER ON A SMALL SCALE

Publication No. 11

- Vol. 1: Local Experience with Micro-Hydro Technology
- Vol. 2: Construction Manual for the Cross-Flow Turbine T 1
- Vol. 3: Illustrative Implementation Activities
- Vol. 4: Design Manual for a Simple Mechanical Governor
- Vol. 5: Construction Manual for the Cross-Flow Turbine T 3