

Restoring a hydro unit

The alternator is the mainstay of wind and water power systems and homebuilt standby generators

[This is the second in a series of articles on hydropower. Last issue, in *Do-it-Yourself Hydro Survey* (Jan/Feb 2001), I detailed how to evaluate the potential to generate power from the runoff or the seasonal or annual flow of water across one's land. This article details alternator rebuilding and simple, practical control circuits for these systems, including homebuilt ones. The hydro unit restored in this article is part of an installation in progress and will be the subject of an article in a future issue.]

By Michael Hackleman

The alternator has replaced the generator as the preferred way to produce low-voltage dc for recharging the battery and powering lights, wipers, and other big loads in today's automobiles. The alternator has found further application in producing electricity in wind and water energy systems and standby generators, and is a favorite with manufacturers and hobbyists alike. I was recently asked to check out a used hydro-electric unit as part of a planned water power installation. As most of the effort focused on restoring the alternator in this unit, I felt it was a good opportunity to share the process with those interested in adapting or using such a universal



electricity-producing device in their own projects.

Donna D'Terra wanted to supplement the energy produced by her solar-electric modules at Motherland, her homesite and retreat center located in the mountains outside Willits, California. More specifically, she wanted to cut back on the cost and noise of a standby generator in the winter when the waning sunlight reduced panel output.

A site survey established that she could take advantage of the energy of several streams that flow seasonally. As well, I was able to confirm that a used, Pelton-type hydro unit she had traded for work several years previously would operate in this application.

Using the hose-and-pressure gauge method of establishing head (see *Do-it-Yourself Hydro Survey*, Jan/Feb 2001) and the pipe-and-bucket method of finding seasonal flow, I designed the system around a static head of 100 feet and a flow of 24 gpm. I identified the hydro unit as a Burkhardt turbine which was produced locally here in Mendocino County. This unit was reported to be operational when removed from service. I was asked to check it out. A control box (missing) would need to be purchased or fabricated.

The hydro unit

The Burkhardt turbine consists of a Delco alternator, a Pelton-type impeller, an input nozzle assembly, two aluminum spray shields, and a support framework for bolting the unit down.

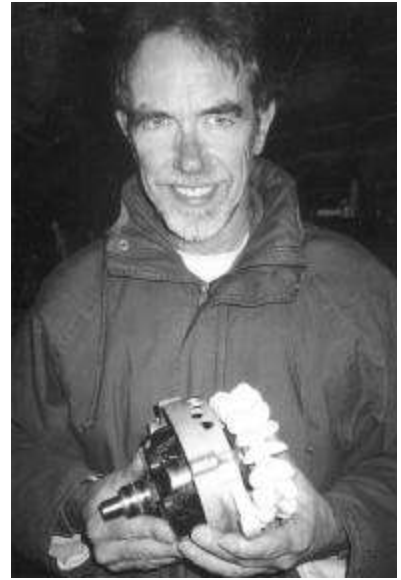

Michael Hackleman holds refurbished alternator parts.

The hydro unit appeared to be in good shape. I reached in with my hand to discover that the Pelton impeller was both intact and virtually unworn. The impeller has twin rows of tiny, spoon-shaped buckets distributed equally around the rim of a center-punched disk. The all-plastic part has 17 buckets to a row, or 34 buckets total. The resulting impeller is 5 inches in diameter and 1¾ inches thick at its widest part.

There was some resistance when I attempted to spin the impeller, so I knew that I would need to check the alternator's bearings. Further inspection revealed that the impeller would have to be removed for the alternator to pull through the back of the salad-bowl housing. A complete disassembly of the unit was called for. This was okay. While I had no idea as to how long the unit had been in service, I *did* know that it would be used in its new application for six months at a time, 24 hours a day. Every component needed to be in top condition for this extreme duty cycle.

The spray shield housing functions as spray guard and drain guide. The spray from a jet of water hitting an

impeller at high rpm is intense, so the spray guard helps keep the surroundings dry. The two halves of this housing are aluminum salad bowls that were adapted to this application. As such, the outermost bowl is cut away about 1½ inches wide along its rim for about a third of its circumference to help route waste water out of the bottom of the unit.

I removed the bolts that held the two bowls together around the rim and separated the two halves. I took a

moment to examine the nozzle assembly. This consists of a casting that bolts to the inner spray shield and has a threaded jet in one end (inside) and a threaded receptacle for the 2-inch pipe at the other end (outside). The size of the jet is critical in matching the head and rate of water flow with the turbine for best efficiency. Selecting the correct size of jet (orifice) is part of the “tuning” process once the hydro unit is in place and has water flowing to it. (This will be

covered in greater detail in the installation article next issue.)

With the spray shield halves separated, the nut that holds the impeller onto the alternator shaft is exposed. The shaft has a hex-shaped hole machined into its end so that a large Allen wrench can grip the shaft for removing the nut. I didn’t have this size of wrench handy so I contemplated my options.

Rather than risk breaking the impeller (a \$100 item) by trying to hang onto it to remove the nut, I elected to open the alternator casing to get at the shaft. After scratching a line across the casing halves (for correct alignment during reassembly), I removed the four small bolts that held the alternator case together and pulled off the rear alternator casing. This exposed the alternator shaft with its field coils. I was able to lock some vise-grips onto one of the solid iron jaws surrounding the field coils and, with a medium-sized crescent wrench, was able to twist free the impeller nut at the other end of the shaft.

To complete the disassembly, I removed the four bolts holding the framework and the rear bowl housing to the alternator’s front casing and this separated all the parts of the unit. Incidentally, the hydro unit weighs 17 pounds, with the bulk taken by the alternator (10 lbs).

The alternator

Opening up an alternator may seem daunting the first time you do it, but it’s really no big thing. In pulling the alternator’s rear casing off the rotor,

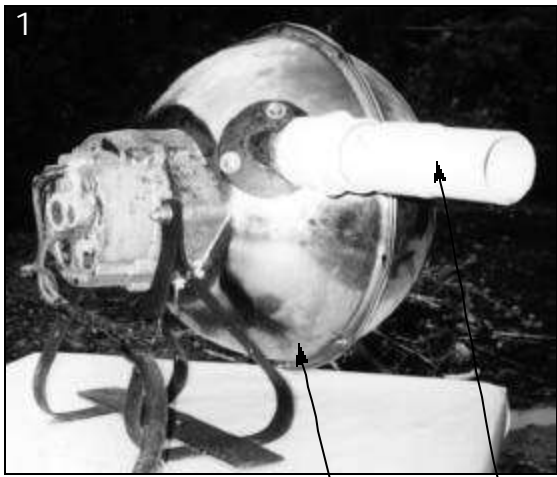

1

Burkhardt Turbine

1. The Burkhardt turbine with inlet pipe and framework

2. Water exits the turbine through a slot in the outer bowl.

3. Removing the spray shield reveals the impeller and nozzle jet. The impeller nut can be loosened with a crescent wrench on the nut and an Allen wrench on the shaft ...

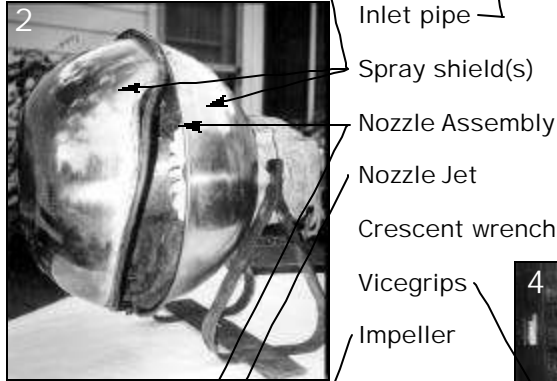

2

Inlet pipe

Spray shield(s)

Nozzle Assembly

Nozzle Jet

Crescent wrench

Vicegrips

Impeller

4. ... or by grasping the field rotor with vicegrips.

5. Case halves, field rotor, and impeller

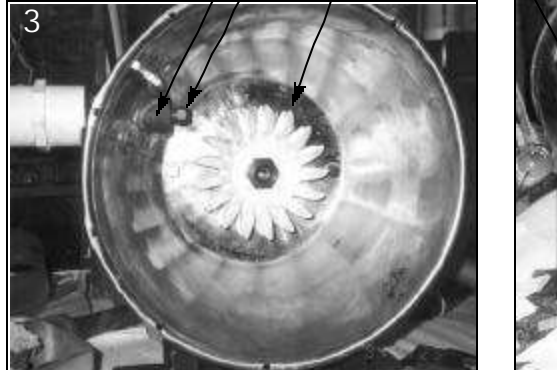

3



4



5

two brushes leap from their sockets. At this point, you may wonder how will you hold them in their guides until you push the rotor back and the brushes are once again held against the rotor's sliprings? If you look carefully, you'll see that the manufacturer solved this by providing a hole in the rear housing. Professionals insert a paper clip through it to temporarily hold the spring-tensioned brushes in their guides. Alternately, a thin wire may be routed over the brushes and out another opening and twisted together. Once the rotor is back in place, the clip or wire is pulled out and the brushes will seat against the sliprings.

Whenever opening something for the first time, it's important to position the parts on the bench and simply look at them. Troubleshooting starts with careful observation. What was I looking for? Signs of arcing or burning or open-ended (disconnected) wires are not good. If the unit shows evidence of this kind of damage, deal with it first. Alternators are not that expensive, new or re-manufactured, so anything beyond your ability to rectify easily or inexpensively is not worth it. As well, alternator shops can do everything I did to this unit and have the tools, parts, and experience to handle all alternator brands.

This unit passed the initial visual inspection. The brushes (rear casing) and sliprings (rotor shaft) drew my attention next. The brushes transfer power to the field coils in the rotor through the sliprings. Since the field coil in a standard alternator only draws about 3 amps at 12 volts, these

are small brushes and they don't work very hard. The sliprings had a nice chocolate brown look to them, which is good. The brushes still had plenty of length (which decreases with wear), a smooth curvature to fit the sliprings themselves, and were not gouged, burned, or pitted. The brush leads were neither frayed nor corroded. Brushes are not expensive but *new* brushes must be "arced" to the slipring curvature. This work is unwarranted unless the brushes *must* be replaced for one of the aforementioned reasons.

I used a multimeter to test the field winding's resistance. With a test lead held against each of the copper sliprings on the rotor, I observed a 4.2 ohm reading. I did the math. Volts equals amps times ohms. Therefore, amps equals volts divided by ohms. 12V divided by 4.2 ohms equals 2.85 amps. That's close to the approximately 3 amps I knew the field would draw.

The front and rear bearings were my next focus. The front one was a standard ball bearing. The rear one was a much smaller, needle-roller type. Both turned smoothly but slowly. I peeled the plastic side off the front "sealed" bearing. The lubricant inside was dried and crusty. I felt tempted to soak out the old lubricant and repack the bearings with good grease. However, with no knowledge of the history of this unit, I opted for new bearings. Toward this end, I removed both bearings, using a socket and shaft extension like a punch to drive them out. The local bearing distributor was able to upgrade these Chinese

and Hungarian bearings to higher quality ones for a cost of \$17.

Checking the diodes

It was time to check the diodes. The diodes in an alternator can be checked with a standard multimeter but the process is somewhat involved for the novice (Sidebar A).

My measurements resulted in some distinctly different readings between some diodes, so I opted to take the casing to a local alternator shop. Their test equipment, designed specifically for testing diodes, confirmed the same borderline readings. Since these values can be influenced by a high-resistance path across the diode surfaces (usually a result of corrosion), a shop worker bead-blasted the entire rear casing and retested. Everything checked good. In a split second, the technician even popped in a rear bearing. (Darn if it wasn't the same one I'd just bought.). Since I had brought the alternator in disassembled, I was only charged \$5 for the 5 minutes of time this entire process took.

Assembling the unit

I was now ready to reassemble the hydro unit. I relied on photographs I had taken of the unit *before* disassembly to help orient everything correctly.

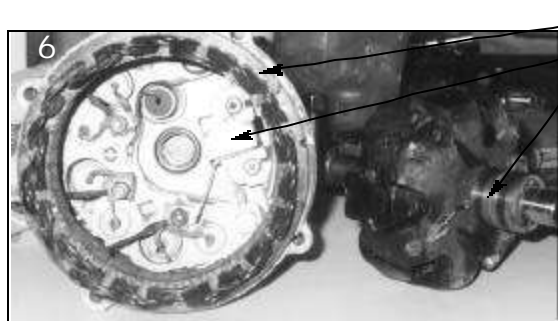

6. The rear alternator casing and field rotor.

Stator coils
Brush assembly
Rotor slip rings

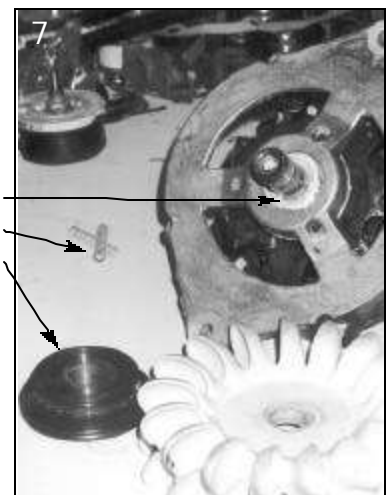

7. The front bearing is packed with grease. The backing plate and impeller are ready to install on the rotor shaft.

Front bearing
Brush springs
Impeller plate

Since I would need the grip on the rotor to re-install the impeller nut, I began by installing the new sealed ball bearing and its retaining plate in the front alternator casing. Since this bearing is within an inch of the water-driven impeller, I packed plenty of Lubriplate on either side of the

bearing to help keep out water. Next, I slid the bushing onto the shaft of the alternator rotor and inserted the shaft through the front bearing in the alternator casing. I squeezed out a thin coating of Form-a-Gasket (non-hardening type) onto the front of the alternator casing and mated it against

the inner spray shield to further waterproof the unit.

Alternators have two mounting holes, one larger than the other. The hole for the smaller bolt is threaded, so its bolt is inserted from the inside of the bowl and is simply tightened down. The larger bolt slips through

Sidebar A: Alternator diodes

Alternators have rotating fields and stationary stator windings. As the name implies, the field coils on the rotating core generate an electromagnetic field. The stator (power) windings are stationary and produce electricity up to 35-45 amps at 12V as a result of rotation through the field. The field coils receive power from B+, or the alternator's output through graphite brushes in contact with sliprings on the rotor. The stators are wound to produce 3-phase ac electricity which is converted into DC with diodes. Each phase needs two diodes, each one of which are ganged together at B+ or ground.

So, there are six diodes mounted in the alternator—three in the rear casing and three in a metal plate that is electrically-isolated from the casing. Unless there is reported trouble with the alternator's output, the diodes are generally assumed to be good and are left alone. A diode in your hand is easy to test with an ohmmeter or a continuity tester (both functions are found on inexpensive multimeters) to find out if it's shorted or open. However, alternator diodes are

pressed into tight holes and are difficult to remove. To test them in place, a diode lead must be disconnected so that each diode is essentially "out of the circuit" and not influenced by other wiring or diodes.

The process of checking the diodes begins by locating the stator windings. These are wound in a frame that fits the inside curvature of the casing and they handle all the power generated in the alternator. Three wires from this array terminate on three separate posts on the rear plate, each wire representing 1 phase of the generated 3-phase output. The leads from two diodes also attach at each post. So, three windings (phases) = three posts = six diode leads.

A few words of caution before you tackle this. First, it's a small space and the stator wires are stiff. Be gentle and don't move anything more than you have to. Second, make a drawing. At least, it's a good place to write down the readings. It's also a great guide during assembly when you can no longer, perhaps a few days later, remember which of several possible ways something might go back together.

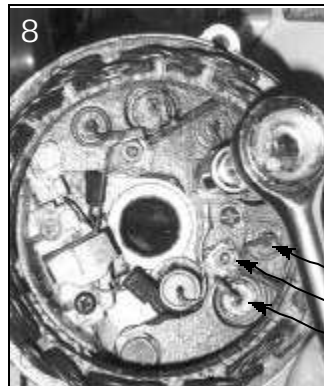

8. The nut is removed from a stator terminal to free two diode leads.

9. A grocery tie holds the brushes in place before the rotor is re-inserted in the casing.

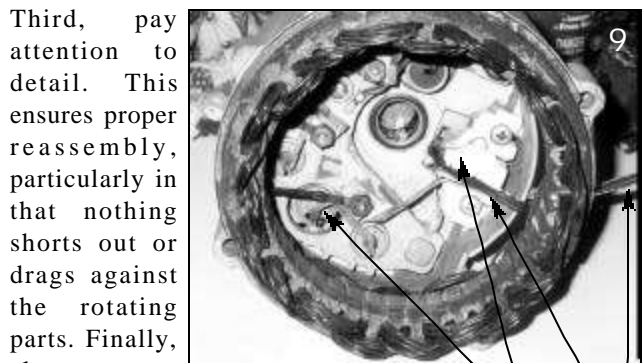

Third, pay attention to detail. This ensures proper reassembly, particularly in that nothing shorts out or drags against the rotating parts. Finally, alternators are not all the same. Adapt my procedure to fit your alternator.

I used a small nut driver to remove the nut from one of the posts where the stator windings meet the diode leads. I used needle-nose pliers to gently lift the diode connectors off the post, removing other leads only if necessary to get at the diode leads. I figured that working with one terminal post at a time would prevent any crossed wires.

I touched one lead of the multimeter to the diode lead I had just freed and the other to the metal case (or

Stator lead
Brush holder
Grocery tie for brushes

standoff plate) in which the diode is embedded. A continuity tester will show current flow in one direction only, so reverse the multimeter leads, finding first continuity, then no continuity. This tells you if the diode is good or bad. I also tested these diodes with the ohm function of the multimeter, providing me with actual values of ohms (a measure of resistance) in each direction for each diode.

the bowl and the alternator flange. At this point, I slipped the support frame for the hydro unit over the exposed threads and added nuts to each.

The impeller is held to the alternator shaft by a big brass nut and a large, thick brass backing plate. I slid the plate onto the alternator shaft, pushed the impeller into place—ensuring that its buckets are correctly oriented to the nozzle—and added the nut. As with disassembly, the vice grips held the alternator rotor while I tightened the nut against the impeller, being careful not to over-tighten it.

I was ready to install the field brushes. This job requires some dexterity. I set the rear alternator casing onto a towel on my workbench so that I had both hands free. I inserted a spring into the rear brush holder and held it in place with a screwdriver. With my free hand, I grabbed the brush with needlenose pliers and oriented it over the spring, slipping out the screwdriver as I pressed the brush into place. I inserted a grocery tie (used for holding market vegetables together) through the hole in the rear casing and across this brush to hold it in place. I repeated this process for the front brush, then routed the grocery tie out another hole so that I could twist the two ends together outside the casing. This process is tedious because the brush leads are short and already anchored to their terminals. Be patient or you'll be starting over a lot.

Since the rear needle-type bearing was already installed in the rear alternator casing, I was ready to join the alternator halves. I slipped the rear casing over the rear of the rotor and aligned the scratch marks I'd made (before disassembly) with those of the front casing. I inserted and tightened the four case bolts.

Once the alternator was assembled, I untwisted the grocery tie holding the brushes in place and pulled it out. I again checked the field coil resistance with my multimeter, placing one test

lead on the F+ (Field positive) post and the other at the B- (Battery minus, which is also F-) post. The reading was the same as before: 4.2 ohms. This one test confirmed a good electrical contact through the terminals, brushes, sliprings, and field coils.

The control box

The control box for the Burkhardt turbine was missing in this application. The circuitry requirements for an alternator in a hydro unit are nearly identical to those used in a windplant or a standby generator—an ammeter, a diode, a rheostat, a fuse, a terminal junction, and an enclosure (Fig. 10). The ammeter displays alternator output (current) in amps. The diode blocks battery voltage from powering the field coils, which rely instead on the residual magnetism in the rotor's iron for excitation. The rheostat (another name for a potentiometer or variable resistor) manually adjusts field current, replacing the function of the voltage regulator used in automobiles. The fuse protects the field from too much electric current. The terminal strip helps with electrical connections between the unit and the alternator and battery pack. Finally, the enclosure protects these components from the environment.

Since I had the tools and experience to assemble such a simple circuit, I

opted to fabricate a control box from scratch, mostly copying the original design.

I strayed from the original design of the control box in two ways: how the field coils are energized and where the external shunt is located (Sidebar B and Fig. 11). The first one simplifies the circuitry and reduces the amount of the output power that is taxed to energize the field coils. The second increases the accuracy of monitoring power output from the system and avoids running large wires through the control box.

I obtained a rheostat—rated at 28 ohms (resistance) and 50 watts (heat dissipation ability)—directly from John Takes, who owned and operated Burkhardt Turbines for many years. For a 12-volt system, a 12-ohm rheostat is generally more appropriate, but I will try the 28-ohm one first. (This will be tested when the hydro unit is installed and water is available to it.) I purchased the fuse holder and fuse, a pushbutton switch, terminal strip, and enclosure from a local Radio Shack for this circuit. I used terminals for multimeter test leads from my own parts' stock.

Construction tips

After a careful inspection of the system schematic, I recognized that the control unit was basically handling field current circuitry and a small bit of metering. Its container would mount the rheostat, pushbutton switch, two meter terminals, a fuse, a terminal strip, and interconnecting wires.

Accordingly, I selected a 5-inch long, 3-inch wide, and 2-inch deep plastic box for the control unit. (It was a tight fit; a novice might want to pick something larger.) Since the control unit is attached to (or near) the hydro unit itself, it is

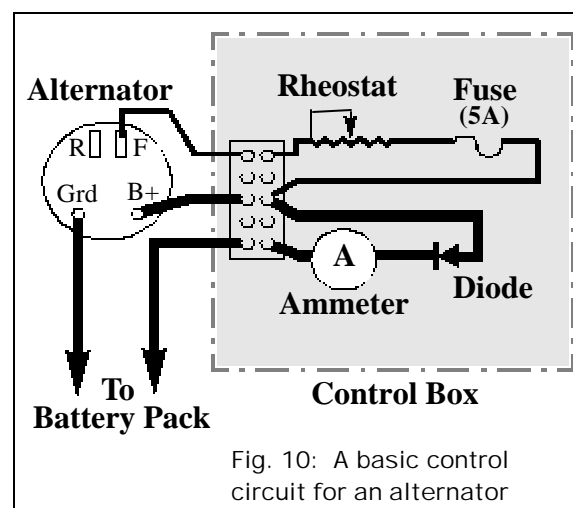

Fig. 10: A basic control circuit for an alternator

exposed to a water environment and must be fairly waterproof. I initially considered using a Tupperware container for this application because it provides great access and seals so well. I rejected this idea only because I thought the sunlight might eventual-

ly embrittle it. I also rejected the use of a steel box, since it would require a grounding rod at the hydro site.

The rheostat is large and takes up most of the room, so I positioned this at one end of the box. The only other holes in this face of the box are the

pushbutton switch and the two meter terminals. Other considerations in layout? Components should not interfere with each other. Wires take up space, so allow for them. Finally, position the exit hole in the end face of the box to permit easy hookup of

Sidebar B: Control box

The control box I built uses a field circuit modified from the standard field circuit and measures output current differently.

1. Field connection.

While the diode (as shown in Fig. 10) provides a way to supply field current to the alternator, it also assesses its own tax for this effort. Common diodes dissipate (as heat) as much as one watt per amp—a whopping 35 watts for a 35-amp output—due to their own internal resistance. If you choose to use this circuit, use a Schottky diode. While more expensive, it will reduce this loss by half.

However, there is a way to avoid the use of a diode altogether which works especially well with hydro-electric units and standby generators. (Sorry, it won't work well with homebuilt windplants.) This method relies on the use of the **R** (rotor) terminal on Delco alternators (or the similar spade terminal of other alternator brands) to supply field current. The **R** terminal actually taps *one* rotor phase in the alternator while the output leg (**B+**) represents *three* phases. The difference? The **R** terminal is connected to one stator and produces ac (not dc) with about half the volt-

age (and, therefore half the current) normally available at the **B+** terminal.

The control circuit that takes advantage of the **R** terminal (Fig. 11) is radically different than the one using a diode (Fig. 10). A critical component in this setup is the momentary-contact, pushbutton switch. Without it, the field coils might not self-energize because of the lower voltage available from the **R** terminal. Fortunately, hydro-electric units that employ the Pelton-wheel are "tuned" for a specific head and flow of water. As such, the reduced current to the field coils is part of this tuning process. Once adjusted, the hydro unit may be energized by the owner via the pushbutton switch and, thereafter, left unattended.

Two cautions. First, momentary means *momentary*, i.e. *less* than a second. Any longer and there is risk of blowing a diode or the fuse. Second, don't miswire the circuit, or you can add heat and fire to the symptoms listed above. If you can't get it to work, go back to the circuit shown in Fig. 10.

2. Meter shunt. The original design of control box used a stock ammeter with

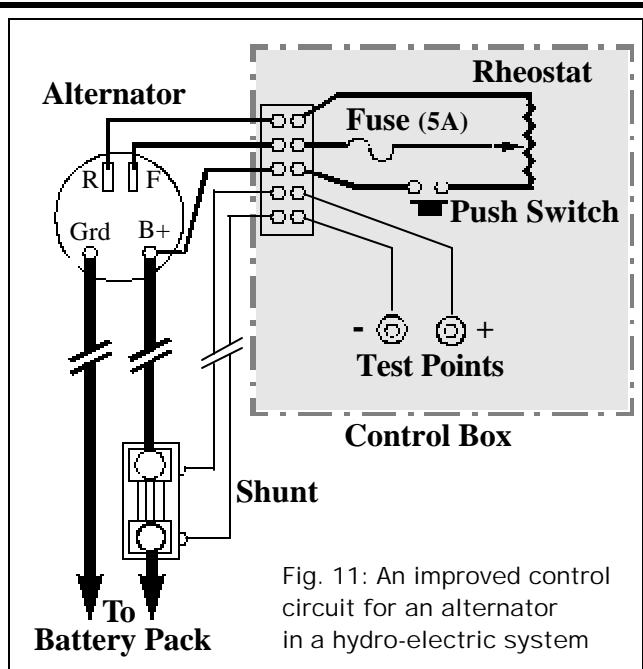

Fig. 11: An improved control circuit for an alternator in a hydro-electric system

a built-in shunt. While this is nicely packaged, this type of meter offers poor resolution for anything except mid-scale readings, must be waterproofed, and limits output readings to the immediate vicinity of the hydro unit.

I elected instead to use a standard meter shunt. This calibrated gizmo offers accurate readings to within 1/10th of an amp of current across the range of amperage measured when used in conjunction with even a cheap (\$20) digital multimeter. The advantage of the shunt is that it may be mounted anywhere in the line between the control box and its connection with the battery pack. Small-

gage wires may then be run to meters or terminals that accept the test leads from a multimeter. In this application, I wanted to mount the shunt near the battery pack where it would pull double duty, monitoring the output of the existing solar modules. From there, I could run small wires to test points in the control box at the hydro site.

A side benefit of this arrangement was that I did not need to mount the shunt inside the control unit, thereby avoiding having to route large-gauge (power) wires *through* the control box itself.



Fig. 12: Components for the control box are based on the circuit illustrated in Fig. 11.

Fig. 13: Draw a wiring diagram and check it against the schematic before you start construction.

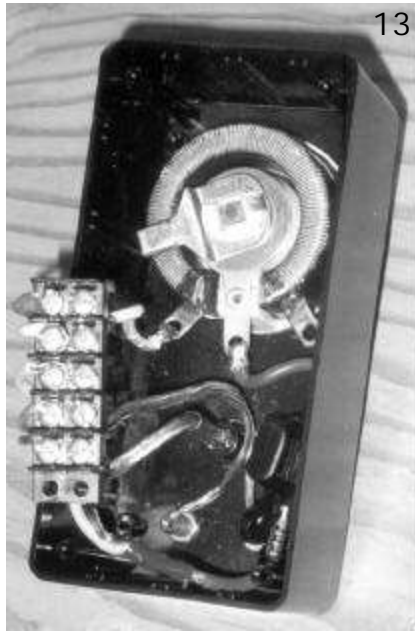

The layout will help you decide their length. While the shortest distance between two points is a straight line, it's not always practical. My work with communications and radar equipment when I served in the U.S. Navy taught me the virtue of routing wires in a neat and orderly fashion. Basically, you want them out of the way. More importantly, you want to be able to remove components later without having to undo wires just to get at or extract them.

What about wire size and color? It's a good rule of thumb not to use wires any smaller *or* larger than they need to be. Too small, they may

heat up, catch fire, and melt. Too large and they are harder to work with. From the schematic, I readily knew that the control unit is only handling field current (3 amps) and a metering circuit (0.1 amps). Stranded #12 wire is more than adequate for the field current and stranded #18 (or smaller gage) wire works for the meter circuit. (Stranded wires conduct dc current better than a similar gage of solid wire, like that used in Romex for ac wiring in homes.)

Wires of different color help you keep things straight as you hook things up. More significantly, they will aid the eye in tracing *one* wire through the maze of other wires. While this is very helpful in troubleshooting, it has a more immediate benefit: checking your work *before* you hook it up and apply power to it for the first time.

In ac circuits, black is power, white is common, and green is ground. In dc circuits, red is positive (power) and black is negative (common). Since I was limited in the color wire available to me in this construction *and* the circuits weren't really power circuits, I followed *neither* of these conventions. However, I did maintain the same color on each side of the

the external wires to the terminal strip.

If you're fabricating something yourself, a wiring diagram is important, so make one. At least, it minimizes confusion, which usually leads to mistakes. Better yet, it helps you figure out the best way to hook something up. The easiest way is not always the best way. For example, it would have been easier to avoid using a terminal strip. I could much more easily route all of the wires straight out of the box directly from their connections with the components.

I used the terminal strip for three reasons. First, it makes it easy to disconnect and remove the control unit from the hydro system and, then, reinstall it *without* disturbing the bulk of the internal wiring. Second, the wires can't be easily ripped from the unit since the terminal strip won't fit through the exit hole for the wires. Finally, a terminal strip makes for easier troubleshooting by minimizing the possibility of inadvertent shorts when probing through wiring to reach test points. I believe that anything I can do to help anyone who might later work on the unit is worth the extra effort it takes.

The components inside this control box are interconnected with wires.

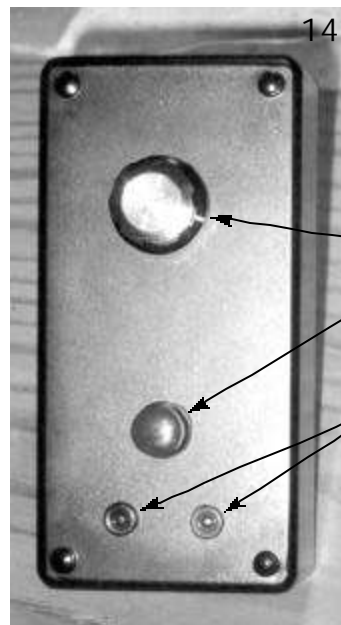

Fig. 14: The completed hydro unit's control box

terminal strip, so that the colors of the external wires had a corresponding

Field rheostat knob

Pushbutton switch for field excitation

Test points to measure alternator output current

color match in wires from the internal components.

One tricky job is wiring up the rheostat correctly. Most military, industrial, and commercial electric and electronics devices are built with a common understanding that clockwise rotation increases something, i.e., more volume on a stereo, brighter light with a dimmer, etc. Since the rheostat's job is to limit current to the field, it was wired so that turning the knob clockwise (cw) increases the field current by decreasing the in-line resistance. Thus, counterclockwise (ccw) limits the field current by increasing resistance. Since the rheostat is wired from the back side, it's easy to get confused and wire it backward. Doublecheck it. Did you do it backward? Simply swap the wire from the outside terminal on one side of the rheostat to the other side to reverse it.

There's a protocol to getting good electrical connections. The first rule of a good connection is to make it physically strong, such as a wire under a bolt, a wire lug under a bolt, etc. The second rule is maximum surface area of contact, best accomplished by soldering. Over time, the *weak* link in wiring between components is usually a connector, i.e., a plug, a receptacle, or a joint. I resist using spade (slide-on) connectors for this reason. Consequently, I soldered wires to a number of components in this box. If your skills are less developed, purchase these spade connectors from a local hardware or Radio Shack. Also purchase the special crimping tool for these connectors and learn to use it correctly. (Crimping is the process of squeezing the soft metal of the connector around an exposed end of a copper or aluminum wire.) Using crimpers avoids the bad crimps that result from *misapplying* needlenose or regular pliers or diagonal cutters for the job.

There is wisdom in the notion of minimizing the number of exposed connections in electrical circuits, so I purchased a bag of heat-shrink tubing of mixed sizes. When exposed to the heat from the tip of the soldering gun, a match, or a butane lighter, this stuff will shrink to about 60% of its original size, forming a snug fit over the joint. As needed, I selected the correct size (50% bigger than the wire itself) of tubing, cut it to a length that would overlap the joint, and slipped it over the wire before I physically secured the wire to the terminal with needlenose pliers. Adding a little flux, I was ready to solder the connection. If you're holding any part of the joint (i.e., the wire itself), hold it still for a full three seconds after removing the heat of the soldering iron or gun. Otherwise, the molten joint may not set, resulting in a cold-solder joint and a weak electrical connection. After waiting 15 seconds for the soldered joint to cool, I slipped the shrink-tubing over the joint. Just the radiant heat from a soldering gun will shrink the tubing. With practice, the result has a professional look to it.

Once the control box was wired internally, I performed a visual check, tracing the wires to their respective terminals and components. I followed this up with an electrical check, using my multimeter. Most of this is a simple continuity check—does this connect with that?—but I used the ohms scale on the multimeter to confirm the full resistance of the rheostat (28 ohms) and to confirm that this value decreased as I turned it clockwise.

The next job was to drill the exit hole for the wires that run to the alternator terminals and meter shunt. I figured to size this hole just large enough for the wires—two #12 wires (rotor and field), a #14 wire (B+), and two #22 wires (+ and -, meter

shunt)—and use silicone sealant to weatherproof the exit. Accordingly, I drilled a ¼-inch hole and fed through the first three wires. Their ends were stripped, shaped, and tightened under screws on the terminal strip. I cut these wires to equal lengths, about 18 inches long, which should easily reach the end of the alternator from the mounting position on the framework. I soldered a ring-connector to the wire that goes to B+, and added push-on connectors to the ends of the other two, for connection to the F+ and R terminals on the alternator. Once the control box is installed on the hydro unit, the two wires from the remote meter shunt will be fed into it, and also connected to the terminal strip. Afterwards, I will use silicone sealant on the inside and outside of the exit hole to effectively seal this opening against the elements and insect life.

I like to add schematics and/or wiring diagrams to black boxes, so I embarked on this final task. The resulting diagram is a mix of a schematic and wiring diagram, with particular emphasis on the terminal strip and the colors of the different wires. I reduced this image to a size smaller than the back plastic cover. Once positioned, I used fiberglass tape in overlapping strips to secure and seal this artwork against the cover inside this cover, and used the four screws to secure the cover to the control box. Once the hydro system is installed, I will add a tiny bead of Lubriplate or similar compound around the perimeter of the cover plate (before screwing it on) to further seal it against weather.

(Michael Hackleman, P.O. Box 327, Willits, CA 95490. E-mail: mhackleman@saber.net) D

To read more of Michael Hackleman's energy articles, visit *BHM's* webside at www.backwoodshome.com.