

“Water Baby” Micro Hydro



RAINBOW POWER COMPANY LTD

A.B.N. 74 003 323 420

1 Alternative Way, Nimbin, NSW, Australia 2480

phone: (02) 6689 1430
international: phone: +61 2 6689 1088
e-mail: sales@rpc.com.au

fax: (02) 6689 1109
international: fax: +61 2 6689 1109
web site: www.rpc.com.au

The “Water Baby” Micro Hydro

Congratulations on your purchase of a new Water Baby micro-hydro generator! With a thorough installation and a little routine maintenance, your water Baby will provide you with years of trouble free operation. This manual will help you to install your Water Baby as well as assist you in troubleshooting and problem solving. Of course, you may contact Rainbow Power Company Ltd if you run into trouble. May your renewable energy adventures prove successful!

Table of Contents

1.	Special Water Baby Features	2
2.	Site Evaluation	2
3.	How the Hydro Works	2
4.	Choosing a Hydro Site	3
5.	Head Measurement	3
6.	Flow Measurement	3
7.	Intake, Pipeline & Tailrace	3, 4
8.	Power System Components	4
9.	Alternator Configuration	4, 5
10.	Batteries, Inverters & Controllers	5
11.	Wiring and Load Centre	5
12.	Design Example	6
13.	Water Baby Output	7
14.	Nozzle Flow Chart	7
15.	Voltage and Current Output Adjustment	7
16.	Bearings, Service and Assembly	7
17.	Plasmatronics Regulator Settings	8
18.	Load Dump: Water Heating Element	8
19.	Power Performance	9
20.	Pipe Friction Head Loss Chart	10
21.	Pressure Conversion	11
22.	Cable Sizing Charts	12
23.	Environmental Impact	13

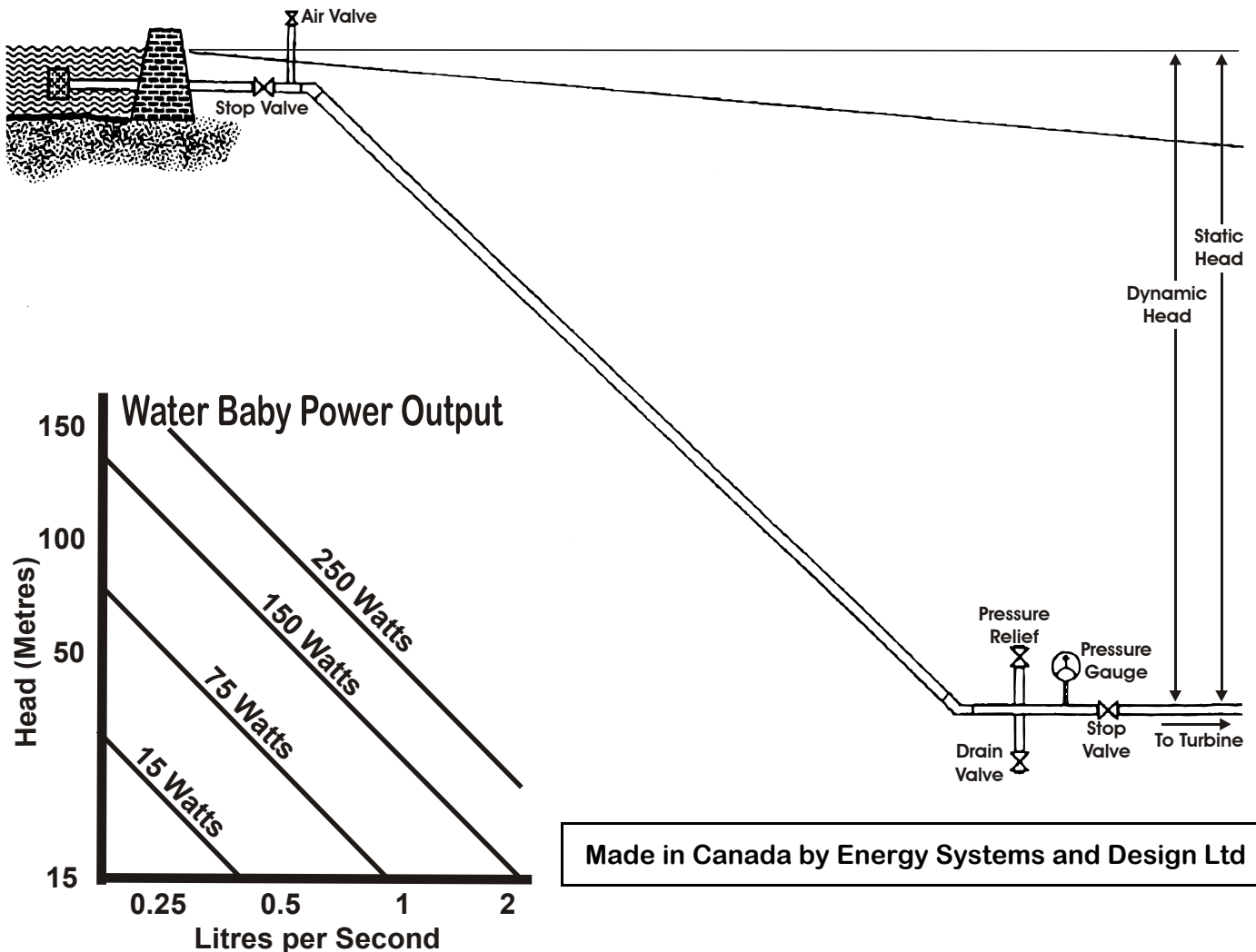

Special Water Baby Features:

- Operates efficiently on ultra low flow (0.2 l/s)
- Super lightweight and compact design
- High quality turbine at a low price

This turbine is a smaller ('baby') version of the Stream Engine. It is a lightweight and compact device which converts energy in water under pressure into electricity. It can operate on flow rates as low as 0.2 litres per second, on heads from 15 to 150 metres. To compare, 0.2 litres per second is only slightly greater than the amount of water flowing out of a typical water faucet in your home.

The Water Baby's bronze turgo runner is only 2 inches in diameter, making this one of the smallest turbines on the market. It is the perfect hydro turbine for a site with low flow rate but a large 'drop' in elevation, such as a spring coming out of a hillside or a mountain stream.

The Water Baby uses a maintenance free, highly efficient permanent magnet alternator. This alternator is specially designed to allow adjustments in output to be made while the turbine is spinning. This feature greatly simplifies optimization of power output for each hydro site.

The Water Baby comes standard with 12V, 24V or 48V DC output. It can also be outfitted with additional nozzles (up to 4 in total) to accommodate higher flow rate. A high voltage option is also available for longer transmission distances.

INTRODUCTION

This manual describes The Water Baby Micro Hydro. The installer must have a reasonable knowledge of plumbing and electrical systems. These machines are small, but can generate some very high voltages. Even 12 volt machines can produce lethal voltages under certain conditions. Practice all due safety. Electricity cannot be seen.

It is important to consult with local officials before conducting any watercourse alteration. You should acquaint yourself with and follow all local laws and ordinances regarding watercourses.

Electricity is produced from the potential energy in moving water from a high point to a lower one. The vertical (altitude) difference between these two points is called "**head**" and is measured in units of distance (metres) or in units of pressure (metres of head, kilo-Pascals, pounds per square inch). "**Flow**" is measured in units of volume against time (litres per second - l/s), and is the second portion of the power equation. The total power available is related (directly proportional) to both the head and the flow.

The Water Baby is designed to operate over a wide range of heads and flows. Nozzle diameters of 3.18mm to 6.35mm (1/8" to 1/4") are available, and up to four nozzles can be used on one machine (depending on the model), to utilize heads as low as 15 and as high as 100 metres.

SITE EVALUATION

Site measurements must first be obtained to evaluate the potential power that the Water Baby may be able to produce. The most important of these measurement is head (vertical or altitude difference between water source and hydro location). Frictional loss and pipe diameter both can have a large impact on the static pressure created by the head. It is therefore very important to know the total pipe length between the water source and the hydro location. We must also determine variations in available flow rate (eg dry times and wet times) to determine maximum hydro output and maximum water flow to achieve this output. This maximum flow rate is needed to determine the most appropriate pipe diameter that will not limit the maximum hydro output but is not in excess of requirements.

HOW THE HYDRO WORKS

The Water Baby uses a permanent magnet type alternator. This design eliminates the need for brushes and the maintenance that accompany them while increasing efficiency. The Water Baby's output can be optimized by simply adjusting the position of the stator. Power is generated at a constant rate by the Water Baby and stored in batteries as direct current (DC). Power is supplied, as needed, by the batteries, which store energy during periods of low consumption for use in periods where consumption exceeds the generation rate. Appliances can be used that operate directly from batteries, or 240 volt alternating current (AC) power can be supplied through an inverter.

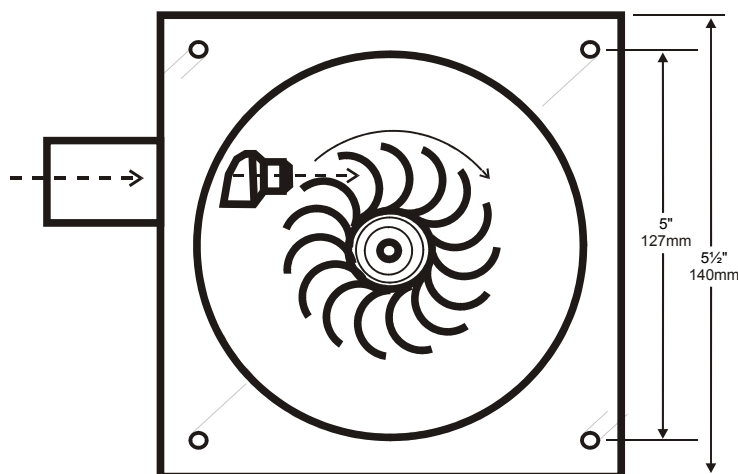

CHOOSING A HYDRO SITE

Sites may vary, so please consider flow, pipe length and head very carefully when choosing yours. Remember, maximum head will produce the most power for a given quantity of water and maximum head can be achieved by placing the Water Baby at as low an elevation as possible whilst the intake is as high as possible. But going too close to a stream may cause the machine to become submerged in flood times and be washed away!).

HEAD MEASUREMENT

Head may be measured using various techniques. A garden hose or length of pipe can be submerged with one end upstream and the other end downstream. Anchor the upstream end with rocks or have an assistant hold it; water should flow out the low end, especially if the pipeline is pre-filled. Once water is flowing, raise the downstream end until it stops. Do this slowly since the water tends to oscillate. When the flow has stabilized, measure the distance down to the level of water in the stream with a tape measure. This will give a very accurate measurement of that stream section. Mark the spot and then repeat the procedure until the entire distance is covered.

Another technique is to use a surveyor's transit. This method can also be approximated using a carpenter's level using a measuring stick or a "story pole." This technique is also done in a series of steps to arrive at the overall head. A variation on this method is the use of altimeters. Casio makes a wristwatch with a built-in altimeter.

FLOW MEASUREMENT

The easiest method to measure small flows is to channel the water through a channel which protrudes beyond a temporary dam such that you can hold a 10 litre bucket or other container of known volume under the end of the channel. Use an open channel rather than an enclosed pipe to guarantee that the water isn't building up at the mouth of the pipe, thus not getting a true reading of flow. Measuring the time to fill the container enables you to calculate the flow rate. Divide the number of litres by the number of seconds to get a litre per second flow rate.

The weir method is more versatile and may prove useful for higher flows. This technique uses a rectangular opening cut in a board or piece of sheet metal set into the brook like a dam. The water is channelled into the weir and the depth is measured from the top of a stake that is level with the edge of the weir and a metre or so upstream.

Measuring the flow at different times of the year helps you estimate maximum and minimum usable flows. If the water source is seasonally limited, you may have to depend on some other source of power during dry times (eg solar or wind). Keep in mind that a reasonable amount of water must be left in the stream (Don't take it all, that water supports a whole ecosystem of life forms).

When head and flow are determined, the expected power output can be determined from the charts on page 9. Keep in mind that chart values represent generated output and that actual power delivered to the batteries will be reduced by transmission lines, power converters, and other equipment required by the system. All systems should be carefully planned to optimize power output to meet actual requirements.

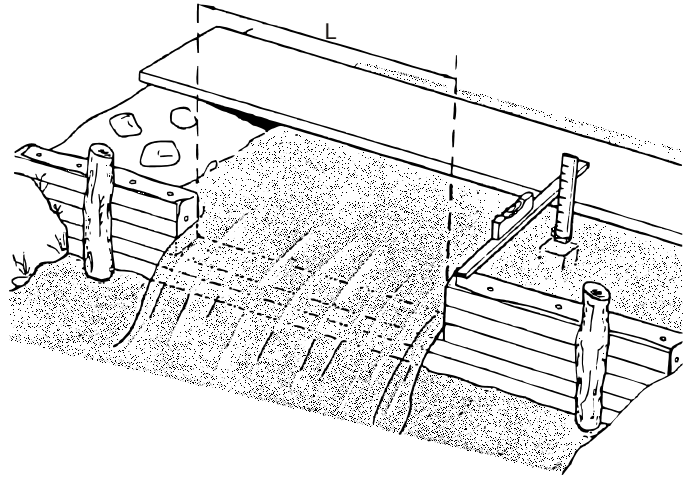
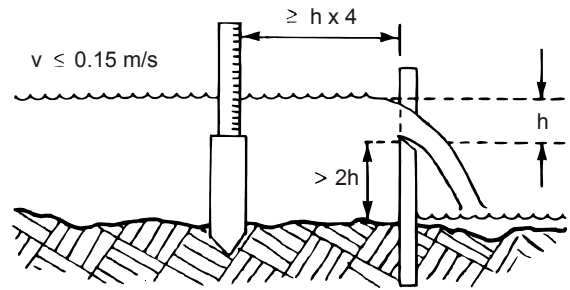

height h (mm)	L = Weir Width (mm)				
	100	200	300	400	500
5	0.06	0.13	0.19	0.25	0.32
10	0.18	0.36	0.54	0.72	0.9
15	0.32	0.65	0.98	1.31	1.64
20	0.49	1	1.51	2.02	2.53
25	0.68	1.39	2.1	2.81	3.52
30	0.88	1.81	2.75	3.69	4.62
35	1.1	2.27	3.45	4.63	5.81
40	1.32	2.76	4.2	5.64	7.08
45	1.56	3.28	5	6.72	8.44
50	1.81	3.82	5.84	7.85	9.86

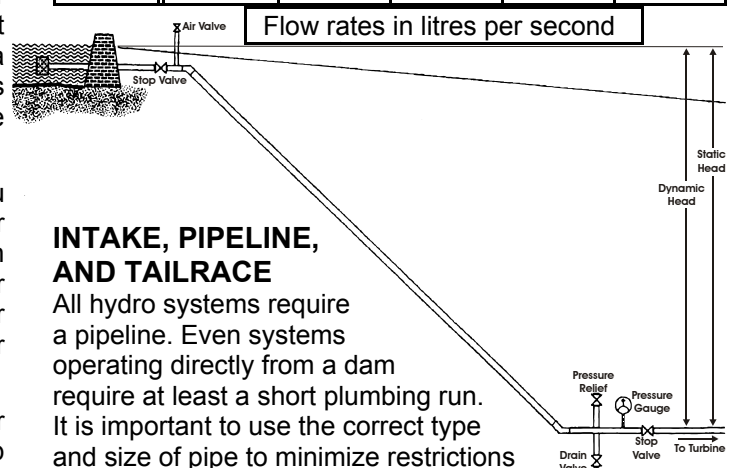

INTAKE, PIPELINE, AND TAILRACE

All hydro systems require a pipeline. Even systems operating directly from a dam require at least a short plumbing run. It is important to use the correct type and size of pipe to minimize restrictions in the flow to the nozzle(s). When possible, pipelines should be buried; this stabilizes the line, reduces accidental damage and prevents animals from chewing it. Put markers down at regular intervals to alert anybody to the fact that there is a buried water line and not to start digging there without taking appropriate action to prevent pipe damage and unwanted water loss.

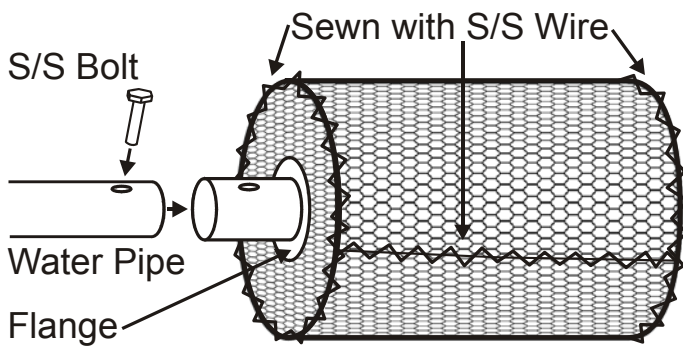

At the inlet of the pipe, a filter should be installed. A screened box can be used with the pipe entering one side, or add a considerable section of pipe drilled full of holes wrapped with screen or small holes and used without screen. The larger the surface area of the filter, the less flow restriction that will cause and the less likely the filter will be totally clogged with debris that has been sucked onto it. Make sure that the filter holes are smaller than the smallest nozzle used.

The intake must be above the stream bed so as not to suck in mud and silt and should be deep enough so as not to suck in air. Be aware that water can form into a whirlpool conical shape as it is sucked down and still suck air down a small depth (depending on suction rate). The intake structure should be placed to one side of the main flow of the stream so that the force of the flowing water and its debris bypasses it. Routinely clean the intake of any leaves or other debris.

If the whole pipeline doesn't run continuously downhill, at least the first section should, so the water can begin flowing and build up sufficient pressure to cope with any ups and downs further down the pipe. One or more bypass valve may be necessary. These should be installed at low point in the pipe to help get the flow going and to flush out air pockets.

For pipelines running over the top of dam walls, the downstream side may be filled by hand, for instance, by turning off the valve at the hydro, turning on the valve at the end of the section of pipe and lifting the section of pipe to be filled above the hydro. Once filled, the section of pipe can be reconnected and the stop valves can be opened to start the flow. If full pressure is not developed, a hand-powered vacuum pump can be used to remove air trapped at the high point. Ideally the pipe should go through the dam wall rather than over the top such that the entire pipe is below the level of the water in the dam.

At the turbine end of the pipeline a bypass valve may be necessary to allow water to run through the pipe without affecting the turbine, purging the line of air or increasing flow to prevent freezing in very cold climates.

A stop valve should be installed upstream of the nozzle. A pressure gauge should be installed upstream of the stop valve so both the static head (no water flowing) and the dynamic head (water flowing) can be measured at the valve.

The stop valve on a pipeline should always be opened and closed slowly to prevent water hammer (the column of water in the pipe coming to an abrupt stop). This can easily destroy your pipeline and for this reason, you may wish to install a pressure relief valve just upstream of the stop valve. This can also occur if debris clogs the nozzle.

Nozzles can be installed or changed by removing the nozzle holder by backing off the setscrew using a 1/8" allen wrench. The use of flexible pipe or union valves makes it easier to remove the plumbing from the nozzles.

The turbine housing can be mounted on boards to suspend it above the stream. It is recommended to have the Water Baby in a small enclosure or under some cover to keep it dry and provide a place for auxiliary equipment.

Mounting the machine on concrete is also possible (you may wish to try a temporary wood mounting first). The opening under the housing to catch the water should be at least the size of the turbine housing opening, and preferably a little larger. Make certain the tailrace (exit channel) provides enough flow for the exiting water. The housing opening is 140mm (5½") in diameter, the bolt holes are on a 127mm (5") square, and the housing is 152.4mm (6") square.

In cold climates, it may be necessary to build a "trap" into the exit. This prevents outside air from entering the housing and causing freeze-ups.

POWER SYSTEM COMPONENTS

Components supplied with the turbine -

1. The Alternator - the alternator produces 3-phase AC electricity
2. The Rectifier - the rectifier converts the 3-phase AC electricity to DC electricity.

Components not supplied with the turbine -

1. The Wiring - The wire carries the electricity (power) from the turbine alternator to the balance of the DC system (battery, etc). The wire must be sized correctly for the type of electricity being transmitted (DC or 3-phase AC), the voltage, the amount of current (amperage) it is to transmit, and the transmission distance. If the power is DC, you need two wires - a positive and a negative. If the power is 3-phase AC, you need three wires. With 3phase AC, all three wires have the full system voltage and all three transmit power, but the current (amperage) is distributed equally over the three wires. (See page 12 for cable sizing)
2. The Charge Regulator (Controller) - Hydro turbines are like wind turbines in that they are what I call "active power producers". When the water is flowing and the hydro turbine is spinning, it is producing power. And that power has to be used or damage to the hydro turbine will result. The function of the Charge Regulator is to ensure that all of the power produced by the hydro turbine is used - first by the electrical load, then in recharging the battery (but not over-charging of the battery), with any excess diverted to a secondary electrical load, where it is consumed. The Charge Regulator has to be a "diverting" style (load shunt) and have sufficient current capacity to handle all of the current the hydro turbine is capable of generating.

ALTERNATOR CONFIGURATION

The Water Baby uses the same style but smaller size of alternator as the Stream Engine. It thus shares the same configuration flexibility. Utilizing different wiring configurations (field configurable by a qualified technician), the alternator can produce either 12V, 24V, 48V, or 120V (remember, it's 3 phase AC).

STANDARD CONFIGURATION — Extra Low Voltage (12V,24V,48V). If system is extra low voltage and the distance from the hydro turbine site to the balance of the DC system is minimal, use the standard factory DC turbine configuration and use the formula for determining wire size. The alternator wiring is configured for the desired voltage and a Rectifier (supplied with the turbine) converts the AC to DC. The Rectifier is incorporated into the turbine control so that DC power of the correct voltage is provided. You have a DC positive and a DC negative connection - very clean and simple.

EXTERNALLY RECTIFIED — Extra Low Voltage (12V,24V,48V). If the system is extra low voltage but the distance from the hydro turbine site to the balance of the DC system is far enough that wire loss becomes a concern, the Rectifier can be removed from the turbine control box and installed externally at the end of distribution wire. The voltage produced by the alternator is the same, but it is travelling as 3-phase AC to the rectifier so the current is distributed over three wires instead of two.

LONG TRANSMISSION — Low Voltage (120V)

A low voltage unit is typically required because the power needs to be transmitted a long distance from the hydro turbine site in which case the alternator is wired for 120V (3-phase AC) for easier transmission of the power.

BATTERIES, INVERTERS & CONTROLLERS

System Voltage

A small system with a short transmission distance is usually designed to operate at 12 volts. Larger systems can also be 12 volts, but if higher power is desired or the transmission distance is long, then a system of 24 volts or higher may be preferable. This is especially true if all loads are inverter powered. In a 12-volt system operating at a low power level, it may be advantageous to operate all loads directly from batteries. Many 12-volt appliances and a range of inverters are available. In 24-volt systems, it may also be preferable to operate the loads directly (although not as many appliances are available).

In higher voltage systems it is usually better to use an inverter to convert battery voltage to regular 240 VAC power. This has been made feasible with the advent of reliable high power inverters. There are many home power systems in operation with only AC loads.

Sizing Battery Capacity

A typical hydro system should have about two days of battery storage capacity. This will generally keep lead-acid cells operating in the middle of their charge range where they are the most efficient and long-lived. Batteries should be located outside of living space, or adequate ventilation should be provided, as a rising charge level tends to produce both hydrogen gas and corrosive fumes. The production of a highly explosive mixture of oxygen and hydrogen is the result of the electrolysis of water, causing the electrolyte in the battery to become more concentrated and the volume of electrolyte to reduce.

This water consumption will eventually cause the lead plates in the battery to become exposed to the air with the end result of battery failure. It is therefore important to regularly add only distilled water (not tap water) when required in order to maintain the electrolyte level. Up to a point, the gasses produced by the disassociation of water into hydrogen and oxygen performs a valuable task of stirring up the electrolyte (overcoming or preventing electrolyte stratification) and equalising the battery cells.

Charge Control

A hydro system requires that a load be present so that the power has somewhere to go. Otherwise, system voltage can rise to very high levels and the hydro will spin faster due to the lack of a load. The need for a load provides an opportunity to do something with the excess power (eg a water heating dump load can be used).

As the batteries become fully charged, their voltage rises. At some point, the charging process should stop and the power diverted to the dump load. The voltage set-point should be somewhere between 13.5 and 14.5 for a 12-volt system depending on the charge rate. The higher the charge rate, the higher this may cause the voltage to go. If the batteries are likely to spend a lot of time fully charged whilst the hydro is running, the voltage limit should be on the low end of the range.

A Plasmatronics PL regulator can be set up to switch power to a dump load when their set point is reached. Load dumps are usually resistive, such as heaters, but can be anything that is compatible with the system.

A voltmeter or a watt-hour meter can be used to monitor battery charge level. The Plasmatronics PL regulator with the addition of a shunt and interface has a watt-hour and state of charge function. Battery voltage is roughly a function of the charge level, and varies according to the load level and charge rate. As you gain experience, the battery voltage can be used to assess the charge level more accurately.

WIRING AND LOAD CENTRE

Every system requires some wiring to connect the various components. Power Distribution boxes are available as a complete package that easily facilitates the connection of loads and power source(s). All circuits in the system should use wire of adequate size and have fuses or breakers of sufficient capacity to carry the expected load current. The cable to the Water Baby must be fused since it can suffer from a short or similar fault just like anything else in the system.

Inside the junction box on the side of the machine are two terminal blocks for the battery wiring. The negative terminal is bolted to the box and the positive terminal is bolted to the plastic plate. Your transmission wire ends are inserted into these two connectors (after being stripped of insulation) and then tightened. Make sure that the battery wiring is correctly connected or the rectifier will be destroyed. Do not operate the machine without being connected to the batteries as very high voltages may be generated and the hydro will spin much faster without a load.

A clampmeter available at Rainbow Power Company (Cat.# MET-013) provides a simple means to measure current output without needing to disconnect any wires or opening up the junction box. This measurement translates into a charging rate to the battery or load dump when the battery is full. A voltmeter connected to the batteries will roughly indicate the charge level, as described in Charge Level above.

DESIGN EXAMPLE

This example shows how to proceed with a complete installation. The parameters of the example site are:

- 36 metres of head over a distance of 300 metres
- a flow of over 0.95 l/s (most of the time)
- 30 metres distance from the house to the turbine
- 12 volt system

The first thing we do is determine the pipeline size. Although maximum power is produced from a given size pipe when the flow loss is 1/3 of the static head, more power can be obtained from the same flow with a larger pipe, which has lower losses. Therefore, pipe size must be optimized based on economics.

Looking at the nozzle flow chart, we see that a 1/4" nozzle will produce a flow of 0.8 l/s at a 36m head. The pipe flow charts show us that 1 1/2" diameter polyethylene pipe has a head loss of 1.81 metres of head per 100 metres of pipe at a flow rate of 0.8 l/s. This is 5.43 metres of loss for 300 metres of pipe.

Polyethylene comes in continuous coils because it is flexible (and more freeze resistant). A flow of 0.8 l/s gives a net head of 30.53 metres (36m – 5.43m). The losses caused by the various pipe fittings and intake screen will further decrease the dynamic head, so 30 metres is a good working figure for the net head.

At this head and flow condition, the output of the machine is equal to about 100 watts.

Since we require 12 volts and the transmission distance is relatively short, we can generate and transmit 12 volts using the Water Baby. This Water Baby could also be used for higher voltages like 24, 48, 120 and 240, and power could be transmitted longer distances.

We need to go 30m with 100 watts of power at our site. This will be about 6.7 amps at 15 volts at the generator. Note that there will be some voltage drop in the line and batteries require somewhat higher voltages than nominal to become charged. So the 6.7 amps must pass through 60 metres of electric cable for the round trip. Resistance losses should be kept as low as economics permit, just like the pipeline losses.

Let's say we wish to have no more than a 5% loss. This is 5 watts out of the original 100. The formula for the cross sectional area of the cable is as follows:

$$A = 2 \times L \times I \times R \div V_d$$

where A = cross sectional area of the cable in mm².
L = route length (one way distance) of cable in metres

I = Intensity (current in amps)

R = Resistance in ohms (S) per m per mm² = 0.0183

V_d = Acceptable voltage drop

a 5% voltage drop for a nominal 12 volt battery is 0.6V

$$A = 2 \times 30 \times 6.7 \times 0.0183 \div 0.6 = 12.27$$

This is the wire size that will produce a 5% loss. Increasing the wire size further reduces the losses. Any cable size larger than this would give us a lesser voltage drop than 5%.

So if the battery voltage is 13.6 the generator will be operating at close to 14.3 volts. Keep in mind that it is always the batteries that determine the system voltage. That is, all voltages in the system rise and fall according to the battery's state of charge.

At this site, we would be generating 6.7 amps continuously or:
6.7 amps × 24 hrs = 161 AmpHrs. generating capacity per day.

We would probably use an inverter and load controller with the system. The diagram for such a system would look like this:

Diagram of Typical Battery Based Hydro Power System

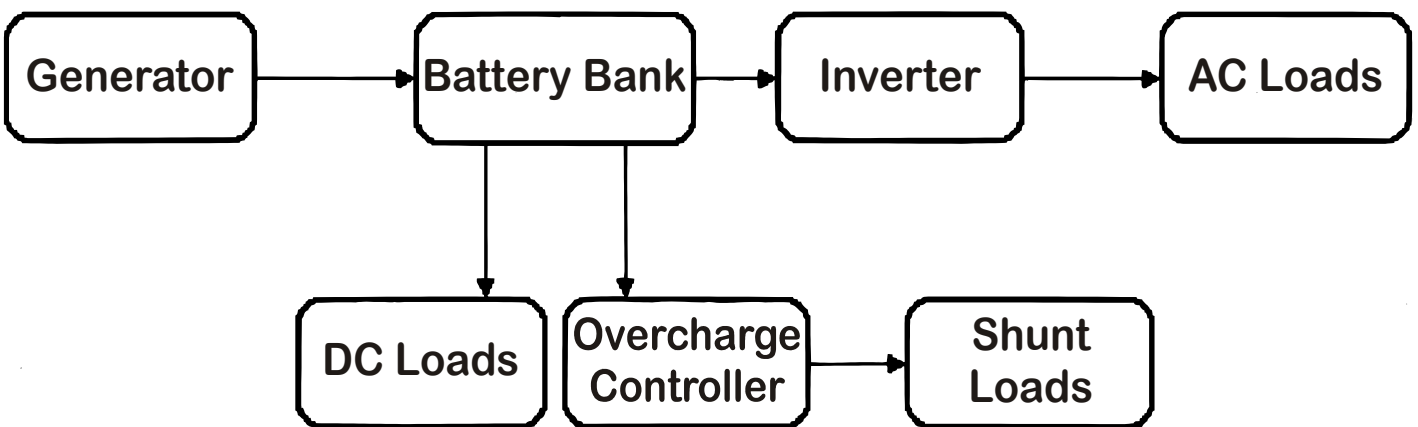

WATER BABY POWER OUTPUT (Watts – Continuous)

Head Metres	Flow Rate (Litres per Second)			
	0.31	0.63	1.25	2.5
15	15	35	70	
30	40	80	160	300
60	80	160	300	600
90	120	220	400	
120	160	300	550	
150	200	350		

FLOW FROM NOZZLE (Litres per Second)					
Head Metres	Nozzle Size				
	#4	#5	#6	#7	#8
	1/8"	5/32"	3/16"	7/32"	1/4"
	3.18mm	3.97mm	4.76mm	5.56mm	6.35mm
15	0.14	0.21	0.31	0.42	0.55
18	0.15	0.23	0.34	0.46	0.6
24	0.17	0.27	0.39	0.53	0.69
30	0.19	0.3	0.44	0.59	0.78
36	0.21	0.33	0.48	0.65	0.85
45	0.24	0.37	0.57	0.73	0.95
60	0.27	0.43	0.62	0.84	1.1
75	0.31	0.48	0.69	0.94	1.26
90	0.34	0.53	0.76	1.03	1.35
120	0.39	0.61	0.87	1.19	1.55

OUTPUT ADJUSTMENT

The machine should be adjusted in order for it to produce the maximum output. Firstly one must decide whether to wire the connector box in Delta or "Y" configuration. The graphs on page 9 should help you to decide. Use the diagram below to change the wiring. Next you need to adjust the magnetic field. This can be done by rotating the upper stator to the best position. This is done by first loosening the thumbscrews and then slowly rotating the stator while observing the output current. The current can be measured using a DC clampmeter with the clamp around a single conductor or by using the supplied multimeter with the test leads plugged into the "shunt" in the junction box. Use the millivolt scale which is labelled 200m which puts the handle in the 9 O'clock position. The leads should plug into the meter in the normal position for measuring voltage as we are measuring the voltage drop across a resistance. The black lead goes into the jack that says "COM" and the red lead goes above. Then these are inserted into the colour coded jacks in the shunt in the junction box. This adjustment is necessary to best match the output of the turbine with that of the generator.

BEARINGS, SERVICE & ASSEMBLY

To gain access to the bearings, loosen the thumbscrews and then lift off the top stator. This may require a bit of effort as there is the magnetic attraction to overcome and the top bearing must pull out of its bore which has an o-ring inside it to keep the bearing from rotating. The upper bearing is retained with a small screw and is a slip fit on the shaft. To remove the lower bearing the turbine runner is first removed by holding the magnet rotor and then removing the bolt holding the turbine runner using a 7/32" allen wrench. Once this is done, the rotor assembly can be pulled out of the bearing. Then the bearing can be removed after removing the two retaining screws.

WIRING DIAGRAM

Lower Voltage
Higher Current

Series Delta

Positive Out Negative Out

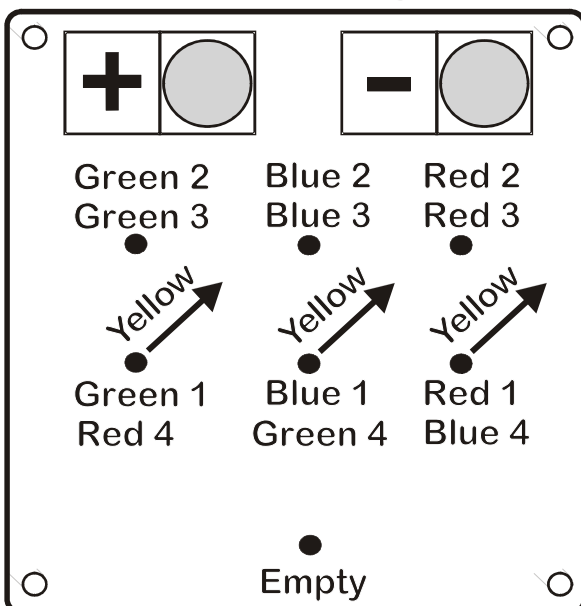

Higher Voltage
Lower Current

Series Y

Positive Out Negative Out

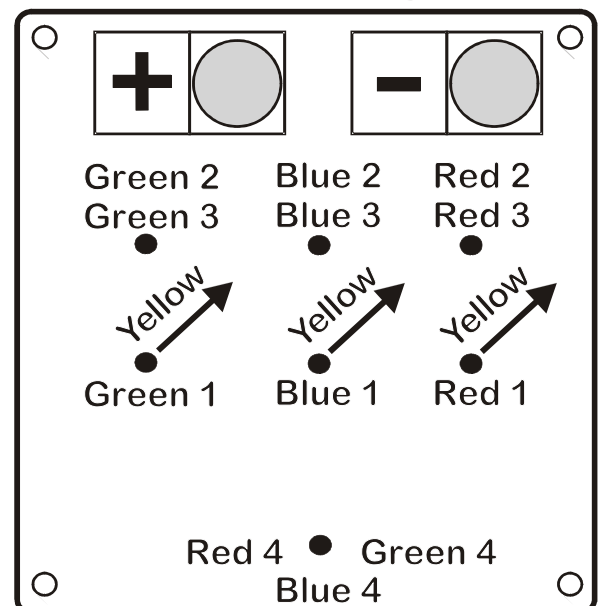

PLASMATRONICS REGULATOR SETTINGS

If you use a Plasmatronics PL regulator with the hydro, the following diagram will show you which parameters need to be set for the regulator to work correctly. Follow the instructions supplied with the regulator to connect it to your battery supply. Once connected you can proceed with setting the parameters. A small arrow indicates a short push on the yellow button on the regulator and the larger arrow indicates a long push.

See page 12 for a diagram on wiring up a relay to operate the load dump.

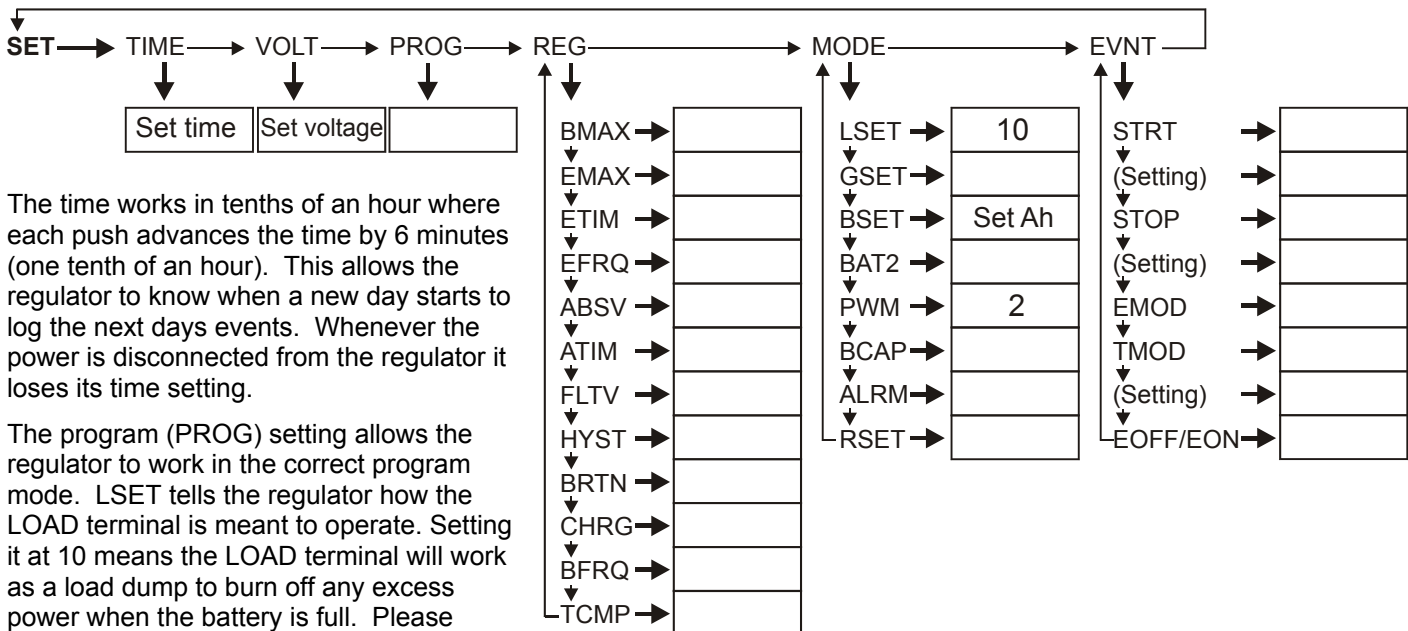

The time works in tenths of an hour where each push advances the time by 6 minutes (one tenth of an hour). This allows the regulator to know when a new day starts to log the next days events. Whenever the power is disconnected from the regulator it loses its time setting.

The program (PROG) setting allows the regulator to work in the correct program mode. LSET tells the regulator how the LOAD terminal is meant to operate. Setting it at 10 means the LOAD terminal will work as a load dump to burn off any excess power when the battery is full. Please ensure that an appropriate resistive load such as a DC heating element is connected to the regulator (see Load Dump: Water Heating Element below) and that if it is a water heating element that it is immersed in water. PWM sets the correct Pulse Width Modulation mode for the regulator to work in conjunction with the hydro.

LOAD DUMP: WATER HEATING ELEMENT

DC water heating elements are available from Rainbow Power Company that can act as load dumps for the Plasmatronics PL regulator. These elements have standard 2" thread found on many hot water systems and come with 2 metre insulated leads. The element length is approximately 500mm. Each of these elements can burn off up to 20 amps at 24 volts or 10 amps at 12 volts. The relay is activated by the LOAD terminal on the regulator. **Please ensure that the water heating element remains immersed in water at all times.**

12 Volt System: Up to two heating elements can be connected directly to the Plasmatronics PL20 LOAD terminal. If more than two elements are required (up to 4), they will need to be connected via a relay which is connected to the load terminal. The elements will again be connected in parallel. The power to the load dump then comes from the battery via the relay.

24 Volt System: Only one element can be connected to the Plasmatronics PL20 LOAD terminal and this will equal the maximum output of the Water Baby.

48 Volt System: Two elements can be connected in series directly to the Plasmatronics PL20 LOAD terminal which exceeds the maximum expected output of the Water Baby.

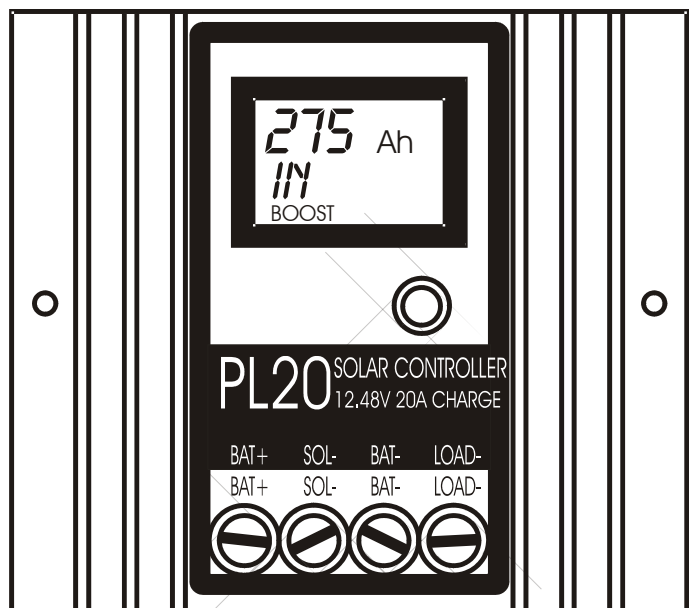

**Resistive Load is connected
between these two terminals
(Or relay turned on/off
by these two terminals)**

Power Output

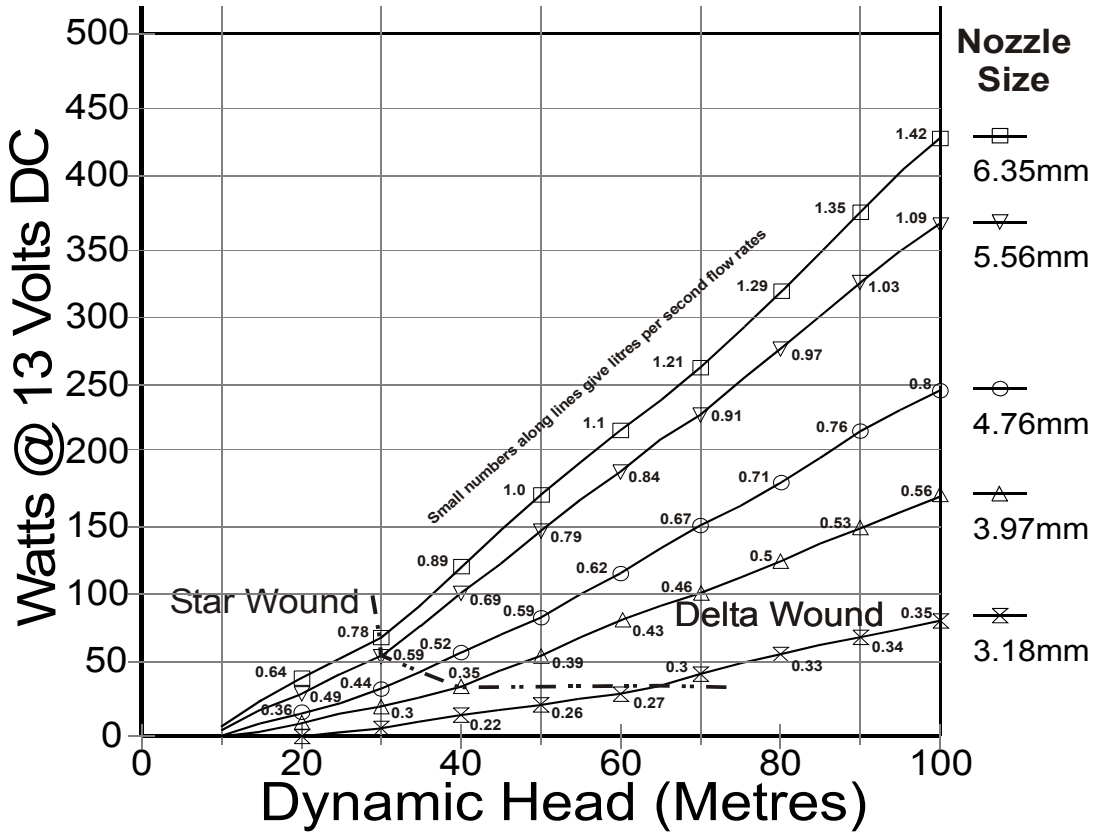

Power Output

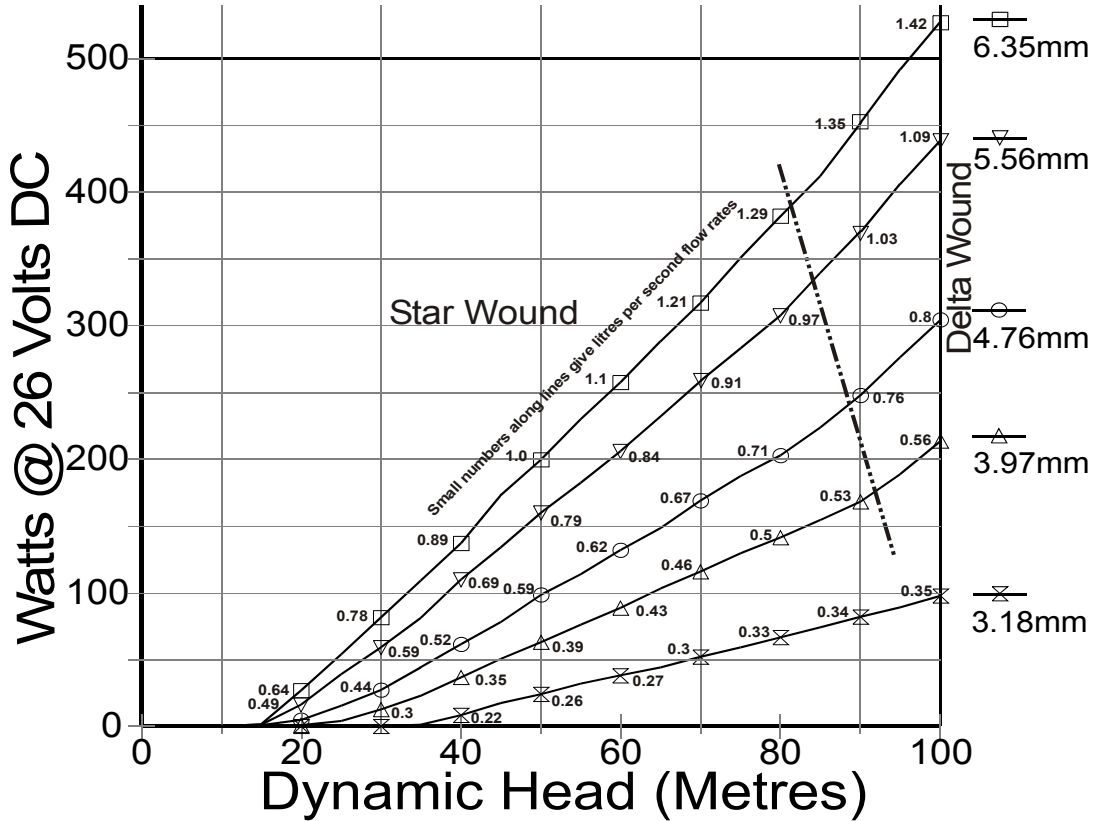

Appendix A Head Loss

metres per 100 metres

Nominal Pipe Diameter (OD for Metric and ID for Imperial) - Polyethylene Pipe – Type 50 – Class 6 ('B' class)														PVC	
l/sec	25mm	1"	32mm	1¼"	40mm	1½"	50mm	2"	63mm	2½"	75mm	3"	90mm	100mm	125mm
0.1	0.57	0.28	0.16	0.11	0.05	0.04	0.02	0.01	0	0	0	0	0	0	0
0.2	2.05	1.01	0.6	0.39	0.2	0.14	0.06	0.03	0.02	0.01	0.01	0	0	0	0
0.3	4.34	2.14	1.26	0.83	0.41	0.29	0.14	0.07	0.04	0.02	0.02	0.01	0.01	0	0
0.4	7.39	3.64	2.15	1.41	0.7	0.5	0.23	0.12	0.07	0.04	0.03	0.02	0.01	0.01	0
0.5	11.17	5.5	3.25	2.14	1.07	0.76	0.35	0.18	0.11	0.06	0.05	0.02	0.02	0.01	0
0.6	15.66	7.72	4.56	3	1.49	1.06	0.49	0.26	0.15	0.08	0.06	0.03	0.03	0.02	0.01
0.7	20.83	10.27	6.06	3.99	1.99	1.42	0.65	0.34	0.2	0.11	0.09	0.04	0.03	0.02	0.01
0.8	26.88	13.15	7.76	5.1	2.54	1.81	0.83	0.44	0.26	0.14	0.11	0.06	0.04	0.03	0.01
0.9	33.18	16.35	9.66	6.35	3.16	2.26	1.04	0.55	0.33	0.18	0.14	0.07	0.05	0.03	0.01
1	40.33	19.88	11.74	7.72	3.85	2.74	1.26	0.67	0.4	0.22	0.17	0.08	0.07	0.04	0.01
1.1	48.12	23.72	14	9.21	4.59	3.27	1.5	0.79	0.47	0.26	0.2	0.1	0.08	0.05	0.02
1.2	56.54	27.87	16.45	10.82	5.39	3.84	1.77	0.93	0.56	0.31	0.23	0.12	0.09	0.06	0.02
1.3	65.57	32.32	19.08	12.55	6.25	4.46	2.05	1.08	0.65	0.35	0.27	0.14	0.11	0.06	0.02
1.4	75.22	37.08	21.89	14.39	7.17	5.11	2.35	1.24	0.74	0.41	0.31	0.16	0.12	0.07	0.02
1.5	85.48	42.13	24.88	16.36	8.15	5.81	2.57	1.41	0.84	0.46	0.35	0.18	0.14	0.08	0.03
1.6	96.33	47.48	28.04	18.43	9.19	6.55	3.01	1.59	0.95	0.52	0.4	0.2	0.16	0.09	0.03
1.7		53.12	31.37	20.62	10.28	7.33	3.37	1.78	1.06	0.58	0.44	0.22	0.18	0.11	0.03
1.8		59.06	34.87	22.93	11.43	8.15	3.74	1.98	1.18	0.65	0.49	0.25	0.2	0.12	0.04
1.9		65.28	38.55	25.34	12.63	9.01	4.14	2.15	1.3	0.72	0.55	0.27	0.22	0.13	0.04
2		71.79	42.39	27.87	13.89	9.9	4.55	2.41	1.43	0.79	0.6	0.3	0.24	0.14	0.05
2.1		75.58	46.4	30.5	15.2	10.84	4.98	2.63	1.57	0.86	0.66	0.33	0.26	0.16	0.05
2.2		85.65	50.57	33.25	16.57	11.82	5.43	2.87	1.71	0.94	0.72	0.36	0.29	0.17	0.06
2.3		93	54.92	36.1	17.99	12.83	5.9	3.12	1.86	1.02	0.78	0.39	0.31	0.18	0.06
2.4			59.42	39.07	19.47	13.88	6.38	3.37	2.01	1.11	0.84	0.42	0.34	0.2	0.07
2.5			64.09	42.13	21	14.97	6.88	3.64	2.17	1.19	0.91	0.46	0.36	0.22	0.07
3			89.84	59.06	29.44	20.99	9.65	5.1	3.04	1.67	1.27	0.64	0.51	0.3	0.1
3.5				78.58	39.17	27.93	12.83	6.78	4.04	2.22	1.69	0.85	0.68	0.4	0.13
4					50.16	35.76	16.44	8.69	5.18	2.85	2.16	1.09	0.87	0.51	0.17
4.5					62.39	44.48	20.44	10.81	6.44	3.54	2.69	1.36	1.08	0.64	0.21
5					75.8	54.07	24.85	13.14	7.82	4.3	3.27	1.65	1.32	0.78	0.25
5.5					87.91	64.51	29.65	15.67	9.34	5.14	3.9	1.97	1.57	0.93	0.3
6						75.8	34.84	18.41	10.97	6.03	4.59	2.31	1.84	1.09	0.36
6.5						87.91	40.4	21.36	12.72	7	5.32	2.68	2.14	1.26	0.41
7							46.35	24.5	14.59	8.03	6.1	3.08	2.45	1.45	0.47
7.5							52.67	27.84	16.58	9.12	6.94	3.5	2.79	1.65	0.54
8							59.36	31.37	18.69	16.28	7.82	3.94	3.14	1.85	0.61
8.5							66.41	35.1	20.91	11.5	8.75	4.41	3.51	2.31	0.76
9							73.83	39.02	23.25	12.79	9.72	4.9	3.91	2.31	0.76
9.5							81.61	43.14	25.7	14.13	10.75	5.42	4.32	2.55	0.84
10							89.74	47.44	28.26	15.54	11.82	5.96	4.75	2.8	0.92
11								56.6	33.71	18.55	14.1	7.11	5.67	3.35	1.1
12								66.49	39.61	21.79	16.57	8.36	6.66	3.93	1.29
13								77.12	45.94	25.27	19.21	9.69	7.72	4.56	1.49
14								88.47	52.7	28.99	22.04	11.12	8.86	5.23	1.71

Appendix B

Pressure Conversion

metres	kPa	feet	PSI	metres	kPa	feet	PSI	metres	kPa	feet	PSI	metres	kPa	feet	PSI
5	49.03	16.42	7.11	10	98.1	32.84	14.22	20	196	65.7	28.4	45	441	147.8	64.0
5.1	45.96	16.75	7.25	10.2	100.0	33.50	14.51	20.5	201	67.3	29.2	46	451	151.1	65.4
5.2	46.86	17.08	7.40	10.4	102.0	34.15	14.79	21	206	69.0	29.9	47	461	154.4	66.8
5.3	47.76	17.41	7.54	10.6	104.0	34.81	15.08	21.5	211	70.6	30.6	48	471	157.6	68.3
5.4	48.66	17.73	7.68	10.8	105.9	35.47	15.36	22	216	72.3	31.3	49	481	160.9	69.7
5.5	49.56	18.06	7.82	11	107.9	36.12	15.65	22.5	221	73.9	32.0	50	490	164.2	71.1
5.6	50.46	18.39	7.96	11.2	109.8	36.78	15.93	23	226	75.5	32.7	51	500	167.5	72.5
5.7	51.37	18.72	8.11	11.4	111.8	37.44	16.21	23.5	230	77.2	33.4	52	510	170.8	74.0
5.8	52.27	19.05	8.25	11.6	113.8	38.10	16.50	24	235	78.8	34.1	53	520	174.1	75.4
5.9	53.17	19.38	8.39	11.8	115.7	38.75	16.78	24.5	240	80.5	34.8	54	530	177.3	76.8
6	54.07	19.70	8.53	12	117.7	39.41	17.07	25	245	82.1	35.6	55	539	180.6	78.2
6.1	54.97	20.03	8.68	12.2	119.6	40.07	17.35	25.5	250	83.7	36.3	56	549	183.9	79.6
6.2	55.87	20.36	8.82	12.4	121.6	40.72	17.64	26	255	85.4	37.0	57	559	187.2	81.1
6.3	56.77	20.69	8.96	12.6	123.6	41.38	17.92	26.5	260	87.0	37.7	58	569	190.5	82.5
6.4	57.67	21.02	9.10	12.8	125.5	42.04	18.21	27	265	88.7	38.4	59	579	193.8	83.9
6.5	58.57	21.35	9.24	13	127.5	42.69	18.49	27.5	270	90.3	39.1	60	588	197.0	85.3
6.6	59.48	21.67	9.39	13.2	129.5	43.35	18.77	28	275	92.0	39.8	61	598	200.3	86.8
6.7	60.38	22.00	9.53	13.4	131.4	44.01	19.06	28.5	279	93.6	40.5	62	608	203.6	88.2
6.8	61.28	22.33	9.67	13.6	133.4	44.66	19.34	29	284	95.2	41.2	63	618	206.9	89.6
6.9	62.18	22.66	9.81	13.8	135.3	45.32	19.63	29.5	289	96.9	42.0	64	628	210.2	91.0
7	63.08	22.99	9.96	14	137.3	45.98	19.91	30	294	98.5	42.7	65	637	213.5	92.4
7.1	63.98	23.32	10.10	14.2	139.3	46.63	20.20	30.5	299	100.2	43.4	66	647	216.7	93.9
7.2	64.88	23.65	10.24	14.4	141.2	47.29	20.48	31	304	101.8	44.1	67	657	220.0	95.3
7.3	65.78	23.97	10.38	14.6	143.2	47.95	20.77	31.5	309	103.4	44.8	68	667	223.3	96.7
7.4	66.68	24.30	10.53	14.8	145.1	48.60	21.05	32	314	105.1	45.5	69	677	226.6	98.1
7.5	67.59	24.63	10.67	15	147.1	49.26	21.33	32.5	319	106.7	46.2	70	686	229.9	99.6
7.6	68.49	24.96	10.81	15.2	149.1	49.92	21.62	33	324	108.4	46.9	71	696	233.2	101.0
7.7	69.39	25.29	10.95	15.4	151.0	50.57	21.90	33.5	329	110.0	47.6	72	706	236.5	102.4
7.8	70.29	25.62	11.09	15.6	153.0	51.23	22.19	34	333	111.7	48.4	73	716	239.7	103.8
7.9	71.19	25.94	11.24	15.8	154.9	51.89	22.47	34.5	338	113.3	49.1	74	726	243.0	105.3
8	72.09	26.27	11.38	16	156.9	52.55	22.76	35	343	114.9	49.8	75	736	246.3	106.7
8.1	72.99	26.60	11.52	16.2	158.9	53.20	23.04	35.5	348	116.6	50.5	76	745	249.6	108.1
8.2	73.89	26.93	11.66	16.4	160.8	53.86	23.33	36	353	118.2	51.2	77	755	252.9	109.5
8.3	74.80	27.26	11.81	16.6	162.8	54.52	23.61	36.5	358	119.9	51.9	78	765	256.2	110.9
8.4	75.70	27.59	11.95	16.8	164.8	55.17	23.89	37	363	121.5	52.6	79	775	259.4	112.4
8.5	76.60	27.91	12.09	17	166.7	55.83	24.18	37.5	368	123.2	53.3	80	785	262.7	113.8
8.6	77.50	28.24	12.23	17.2	168.7	56.49	24.46	38	373	124.8	54.0	81	794	266.0	115.2
8.7	78.40	28.57	12.37	17.4	170.6	57.14	24.75	38.5	378	126.4	54.8	82	804	269.3	116.6
8.8	79.30	28.90	12.52	17.6	172.6	57.80	25.03	39	382	128.1	55.5	83	814	272.6	118.1
8.9	80.20	29.23	12.66	17.8	174.6	58.46	25.32	39.5	387	129.7	56.2	84	824	275.9	119.5
9	81.10	29.56	12.80	18	176.5	59.11	25.60	40	392	131.4	56.9	85	834	279.1	120.9
9.1	82.00	29.89	12.94	18.2	178.5	59.77	25.89	40.5	397	133.0	57.6	86	843	282.4	122.3
9.2	82.91	30.21	13.09	18.4	180.4	60.43	26.17	41	402	134.6	58.3	87	853	285.7	123.7
9.3	83.81	30.54	13.23	18.6	182.4	61.08	26.45	41.5	407	136.3	59.0	88	863	289.0	125.2
9.4	84.71	30.87	13.37	18.8	184.4	61.74	26.74	42	412	137.9	59.7	89	873	292.3	126.6
9.5	85.61	31.20	13.51	19	186.3	62.40	27.02	42.5	417	139.6	60.4	90	883	295.6	128.0
9.6	86.51	31.53	13.65	19.2	188.3	63.05	27.31	43	422	141.2	61.2	92	902	302.1	130.9
9.7	87.41	31.86	13.80	19.4	190.3	63.71	27.59	43.5	427	142.9	61.9	94	922	308.7	133.7
9.8	88.31	32.18	13.94	19.6	192.2	64.37	27.88	44	431	144.5	62.6	96	941	315.3	136.5
9.9	89.21	32.51	14.08	19.8	194.2	65.02	28.16	44.5	436	146.1	63.3	98	961	321.8	139.4

Appendix C

Minimum Cable Sizing

Charging 12 Volt Battery

metres	Amps					
	2.5	5	7.5	10	15	20
5	1.8	1.8	1.8	1.8	2.9	2.9
10	1.8	1.8	2.9	2.9	4.6	7.9
15	1.8	2.9	4.6	4.6	7.9	13
20	1.8	2.9	4.6	7.9	13.6	13.6
25	1.8	4.6	7.9	7.9	13.6	21
30	2.9	4.6	7.9	13.6	13.6	21
40	2.9	7.9	13.6	13.6	21	32
50	4.6	7.9	13.6	21	21	32
60	4.6	13.6	13.6	21	32	49

Charging 24 Volt Battery

metres	Amps					
	1	2	4	6	8	10
10	1.8	1.8	1.8	1.8	1.8	1.8
20	1.8	1.8	1.8	1.8	2.9	2.9
30	1.8	1.8	1.8	2.9	4.6	4.6
40	1.8	1.8	2.9	4.6	4.6	7.9
50	1.8	1.8	2.9	4.6	7.9	7.9
60	1.8	1.8	4.6	7.9	7.9	13.6
70	1.8	2.9	4.6	7.9	7.9	13.6
80	1.8	2.9	4.6	7.9	13.6	13.6
100	1.8	2.9	7.9	13.6	13.6	21

Note:

- The body of the tables give cable sizes in mm².
- These tables are for determining appropriate cable sizes to give a maximum of 10% transmission loss (or voltage drop) on the DC side of the control box. To improve on performance use a larger cable size.
- For a 5% transmission loss double the cable sizes.
- Use 1.5mm² 3 phase cable for the AC transmission between the hydro unit and the control box.
- The control box is placed close to the battery bank in most circumstances.

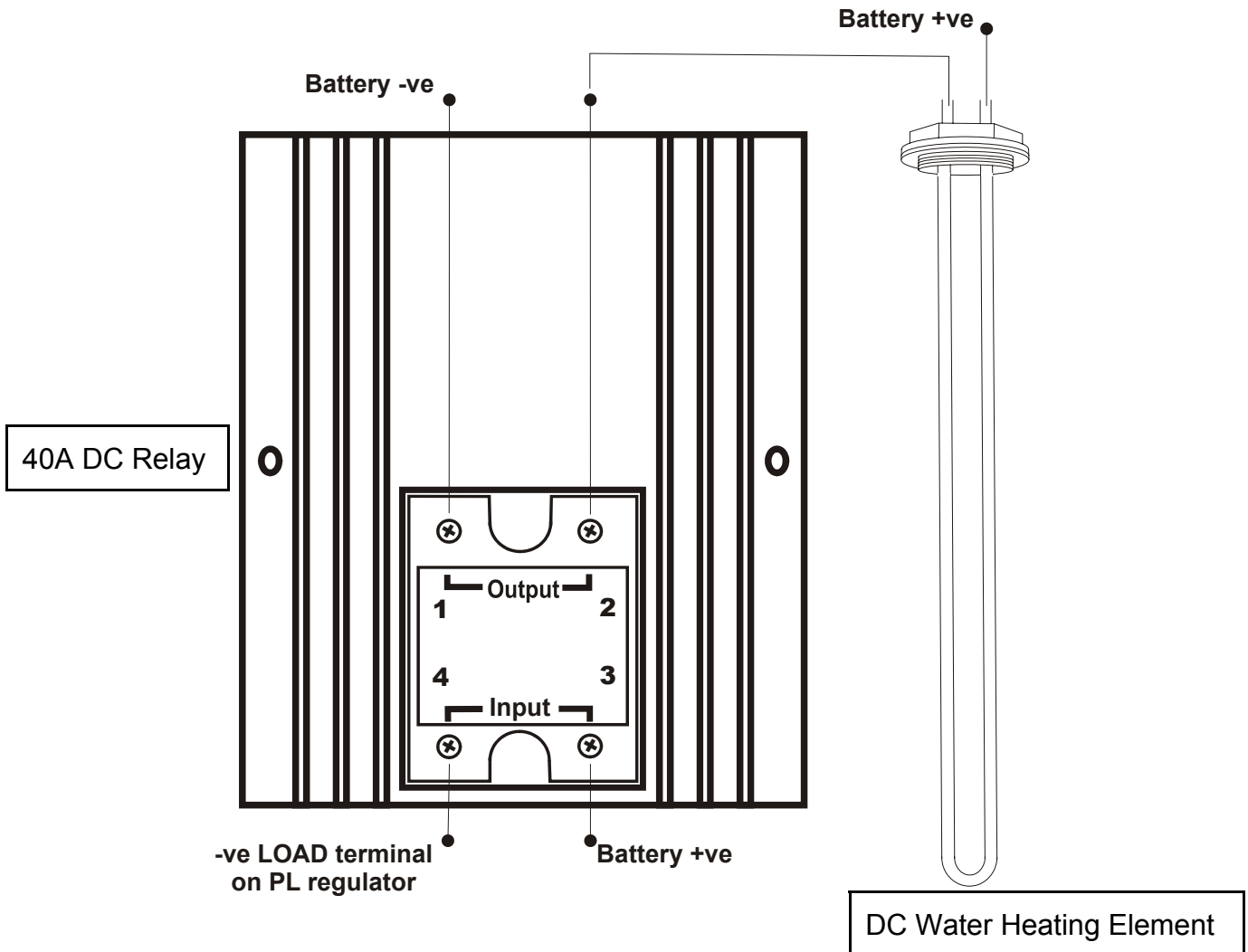

Appendix D

Environmental Impact



It became a fashionable rumour that so many of the "alternate" sources of energy required more energy to produce than they ever could repay in their life-span. This made them a sort of non-rechargeable battery rather than a generation system. This may have been the case with early solar panels, but things have come a long way since then. The Water Baby Micro Hydro stands up well to criticism. In a 10 year life span it would have produced the electricity otherwise requiring 20 tonnes of coal to be burned. Even this sells it short, because really the energy cost of the grid reticulation which we are comparing with should include lots for the transmission lines - their manufacture, erection and protection. The grid infrastructure level is indicated by the \$20,000+ connection cost that is typical, compared to the less than \$1,000 cost of polypipe and cable for a micro-hydro installation. The costing is of course complicated by the fact that the mains option supplies more of the house systems than does a small hydro system and that other environmental impacts are made necessary by it, such as a gas stove. At the end of the sums, Micro Hydros win easily. The more local environmental issues are often the deciding arguments. Many people find power lines very offensive because of cleared forest under the wires, 4WD tracks to cause soil erosion, and unsightly poles and wires across the view. Underground lines are usually too expensive and impractical in rough country.

A frequent concern is that the water used by the turbine is "wasted" and that the usual watercourse will be deprived by the flow through the penstock. Water flow in the creek is certainly reduced, but the effect is less than might be expected. During dry times the pipe stops as there is no point running the turbine at 1/10 litre per second. The only time there is a noticeable difference is when the creek is very low. No animals will be high and dry and no plants affected as they rely on ground-water. Water continually joins a creek bed on the way down so the proportion of water used for power is small. You should always keep some water flow happening between where you take the water and where you return the water back to the water course in order to keep the ecosystem intact. In any case you need to be aware of government or council water usage laws.

Tail water from a hydro system must be controlled properly, otherwise soil erosion, land slips and dead trees can result. Anything from pipes to old sheets of iron can easily solve this problem. The Water Baby Micro Hydro unit is made of a range of different material. The main power unit enclosure is made of recyclable low density polyethylene and the motor shell is made of cast aluminium. Its long term environmental impact is modest however as its life is indefinite and it is recyclable. The lifespan of the machine is usually limited by damage in transit or during floods. Please tie it to an immovable object if there is any chance of a flood covering the site. The biggest risk to a turbine is being washed away.