

Getting Started Everything You Need to Know - Hydroponics.

Please Connect to the Internet When Viewing this Information Package.

[Home.](#)

[History of Hydroponics.](#)

[General Hydroponics.](#)

[Benefits Hydroponic
Food Production.](#)

[Build Your Own Hydro
Systems.](#)

[Hydro Media &
Supplies.](#)

[Mineral Elements /
Nutrient Mixing
Directions.](#)

[Advanced Nutrient
Management.](#)

[Super Nutrients.](#)

[Mixing Hydroponic
Juices.](#)

[Mineral Deficiencies in
Plants](#)

[pH Acidbase.](#)

[Foods Grown in
Hydroponics.](#)



Hydroponic gardening can be **VERY** complicated, with computers and sensors controlling everything from watering cycles to nutrient strength and the amount of light that the plants receive.

On the other hand, hydroponics can also be incredibly simple, a hand watered bucket of sand with a single plant is also a method of hydroponic gardening. Most hobby oriented hydroponics systems are somewhere between the two extremes mentioned above.

The "average" home hydroponic system usually consists of a few basic parts: a growing tray, a reservoir, a simple timer controlled submersible pump to water the plants and an air pump and air stone to oxygenate the nutrient solution. Of course, light (either natural or artificial) is also required.

[Using CO2 Successfully.](#)

[Most Common Problems.](#)

[Postharvest Handling Systems.](#)

[Debate "Organics" or "Hydroponics"](#)

[Hydroponic Terminology](#)

[Beginner's Growing Tips.](#)

[Periodic Table of Elements.](#)

[Conversion Calculation Tables.](#)

[Science projects.](#)

[References.](#)

[Visit Our Wholesale Website.](#)





Hydroponic gardening can be **VERY** complicated, with computers and sensors controlling everything from watering cycles to nutrient strength and the amount of light that the plants receive.

On the other hand, hydroponics can also be incredibly simple, a hand watered bucket of sand with a single plant is also a method of hydroponic gardening. Most hobby oriented hydroponics systems are somewhere between the two extremes mentioned above.

The "average" home hydroponic system usually consists of a few basic parts: a growing tray, a reservoir, a simple timer controlled submersible pump to water the plants and an air pump and air stone to oxygenate the nutrient solution. Of course, light (either natural or artificial) is also required.



History of Hydroponics.

Hydroponics basically means working water ("hydro" means "water" and "ponos" means "labor"). Many different civilizations have utilized hydroponic growing techniques throughout history. As noted in *Hydroponic Food Production* (Fifth Edition, Woodbridge Press, 1997, page 23) by Howard M. Resh: "The hanging gardens of Babylon, the floating gardens of the Aztecs of Mexico and those of the Chinese are examples of 'Hydroponic' culture. Egyptian hieroglyphic records dating back several hundred years B.C. describe the growing of plants in water." Hydroponics is hardly a new method of growing plants. However, giant strides have been made over the years in this innovative area of agriculture.

Throughout the last century, scientists and horticulturists experimented with different methods of hydroponics. One of the potential applications of hydroponics that drove research was for growing fresh produce in nonarable areas of the world. It is a simple fact that some people cannot grow in the soil in their area (if there is even any soil at all). This application of hydroponics was tested during World War II. Troops stationed on nonarable islands in the Pacific were supplied with fresh produce grown in locally established hydroponic systems. Later in the century, hydroponics was integrated into the space program. As NASA considered the practicalities of locating a society on another planet or the Earth's moon, hydroponics easily fit into their sustainability plans. This research is ongoing.

But by the 1970s, it wasn't just scientists and analysts who were involved in hydroponics. Traditional farmers and eager hobbyists began to be attracted to the virtues of hydroponic growing. A few of the positive aspects of hydroponics include:

- The ability to produce higher yields than traditional, soil-based agriculture
- Allowing food to be grown and consumed in areas of the world that cannot support crops in the soil
- Eliminating the need for massive pesticide use (considering most pests live in the soil), effectively making our air, water, soil, and food cleaner

Commercial growers are flocking to hydroponics like never before. The ideals surrounding these growing techniques touch on subjects that most people care about, such as helping end world hunger and making the world cleaner. In addition to the extensive research that is going on, everyday people from all over the world have been building (or purchasing) their own systems to grow great-tasting, fresh food for their family and friends. Educators are realizing the amazing applications that hydroponics can have in the classroom. And ambitious individuals are striving to make their dreams come true by making their living in their backyard greenhouse, selling their produce to local markets and restaurants.

General Hydroponics.

Crops

Crops produced in today's modern greenhouse ranges are many and varied. They can be loosely categorized as follows:

- vegetables including tomatoes, cucumbers, fancy lettuces, bell peppers, cherry tomatoes and a host of minor ones such as radish, melon and strawberry
- cut flowers e.g. roses, mums, carnations
- potted flowers e.g. geraniums, azalea, poinsettia, tulip
- numerous bedding plants

Growing Media

Porous, well aerated substrate are used as anchorage for the plants root system and feeding area. Rockwool and Heydite are the most popular as they are most readily available, and easiest to use and transport. There are various other mediums which are not as widely used. [Click for more info](#)

Growing Techniques

There are different ways to bring water to the plants. [Learn more about growing techniques.](#)

- Nutrient Film Technique,
- Drip-Irrigation or Micro-Irrigation,
- Aeroponics / Deep Water Culture,
- Flood & Drain,
- Home Hobbyist Systems,
- Passive Planters / Hydroculture.

Carbon Dioxide Enrichment

In an outdoor garden the CO₂ level in the air is about 300 parts per million (ppm). Plants thrive when they are able to take in a higher level of CO₂. Growers today monitor their greenhouse CO₂ levels with special purpose control monitors which in turn operate CO₂ burners or generators to replenish CO₂ consumed by the plants.

HAF (Horizontal Air Flow)

Working with CO₂ enrichment and indeed an important part of the greenhouse environment is horizontal air flow. Conceived in the late seventies following research involving finer aspects of greenhouse air circulation, horizontal air flow, or HAF as it is now referred to, is widely used.

Security

Commercial growers end up with very sizeable portions of their yearly turnover as work-in-process. The closer the crop gets to harvest, the higher the risk of catastrophic loss, should a key part of the greenhouse's climate control system fail. Accordingly, growers go to great lengths to protect themselves. Early warning is a vital part of their security. Most now employ automatic phone dialers with electronic voice simulation to alert them of impending problems long before serious crop damage can occur.

Biologicals

Environmental concerns are uppermost in the minds of today's consuming public. The horticultural industry has been working for many years to reduce its dependence on chemical pesticides, many of which have been linked to cancers. Numbers of key pesticides have been deregistered for particular crops, others have been removed from the market altogether. Promising advances have been made in the use of predator insects in greenhouse ranges as natural biological control against pest insects. While much work remains to be done to educate the grower in their use, progressive members of the industry are now well on their way to 100% biological insect control.

Bumble Bees

Until recently, pollination of greenhouse tomato crops was accomplished with a labourious method of fruit truss vibration utilizing battery operated hand-held vibrators ("electric bees") manually touched against mature flower sets. It was a strictly artificial way of simulating natural pollination in the absence of a natural outdoor environment where wind and insects are the vectors. In today's modern tomato ranges, hives of bumble bees are placed strategically amongst the crop and left to accomplish naturally what has been, until now a monotonous and tedious task for greenhouse staff.

Lighting

In order to get the best possible results from a Controlled Environment Agriculture System, we will need to bring the spectrum and intensity of sunlight indoors. This is accomplished using High Intensity Discharge lamps. These lamps, in conjunction with specially designed luminaries, will reflect light downwards to plants, where it may be utilized to the maximum. [Click for more info.](#)

Climate Controls

Modern greenhouses employ advanced environment control aids such as relays, humidistats, thermostats,

CO2 injection systems and fans which are often controlled by a central computer. Smaller systems employ various individual control units.

Bioponics

The organic hydroponic display or Bioponics, we believe, is of significant interest to both commercial and hobby growers. This method employs an organic tea based nutrient solution with added microbial agents to facilitate their breakdown into mineral elements which plants are able to take in.

Controlled Environment Agriculture Systems

Commercial Structures

Today's commercial greenhouses are constructed of galvanized steel, extruded aluminum, fibreglass, polycarbonate, acrylic, polyethylene and glass. The percentage of each, comprising a typical structure, varies by type of design.

Loosely categorized, the following basic shapes and styles are prevalent:

- **freestanding grade to grade hoop houses** (quonset) clad in polyethylene, double polyethylene, corrugated fibreglass sheet, or plastic composite structured panels
- **linked or gutter-connected straight-wall hoop houses** clad in polyethylene, double polyethylene and so on as above
- **linked or gutter-connected straight-wall hoop houses** clad in curved automotive glass
- **linked or gutter-connected straight-wall peaked houses** clad in flat tempered glass. This style of range breaks down into three further sub-categories:
 - single peak gutter-to-gutter
 - double peak with floating gutter
 - triple peak with two floating gutters

All of the above styles or designs of greenhouses are popular, the grower selecting which he will build based on crop to be grown, usage pattern, seasonal pattern, as well as economic considerations.

- Nutrient control insures that the plants get the minerals they need at the right pH and temperature.
- Faster growth then soil grown plants.
- No weeds. The medium is mostly inert and unless it is out doors, there is no way for weed seeds to get into the growing medium.

- No guess work about what nutrients are going to the plant.
- Easy to correct for plant deficiencies.
- No backbreaking soil conditioning.
- The water has all the nutrients that is required by the plants. The roots don't have to grow bigger looking for food. The growth of the plant goes mostly to the upper plant.
- Plants can be spaced closer together then in soil. Spacing is dependent only on the space needed to supply adequate light to the plant.
- Garden can be at a good working height.
- Up to twenty times the amount of plants can be grown in the same space in hydroponics then in soil.
- No soil to harbor bugs.
- Healthy plants have better taste.
- Healthy plants resist insect infestations. Less insecticide is needed.
- Educational for children of all ages learning about plant growth.
- Faster growth so that more then one crop can be raised in a season.
- Can be made portable so that you can move it from classroom to classroom or take it with you when you move.
- Ground is left undisturbed on rented property.
- Condensed growing methods make better use of greenhouse space.
- Consumes 1/10 the water that field crops do.
- Conversation piece.
- Good past time for those that likes to tinker.
- It's something the Jones' don't have. :-)

Some disadvantages to growing plants in hydroponics are;

- Higher cost to get started then soil culture.
- System failure could result in a lost crop if not caught right away. Some systems can go days before damage occurs.

Watering Methods

All the plants needs are supplied by water. The roots are placed in an inert growing medium. Water, enriched with all the nutrients the plants need, is supplied to the roots by several different methods.

1. **Aeroponics**; the roots are sprayed with the nutrient solution. This method ensures that the roots get plenty of oxygen to the root system. It has not been proven that this method helps to make plants grow any faster then in other methods. It has some inherent problems such as nozzles getting plugged up. One of the more expensive methods of hydroponics.

2. Ebb and flow; also called flood and drain. Periodically floods the medium. As the water drains out new air comes in. Not as hard to maintain as an aeroponics system. Roots can plug up waterways however.
3. NFT; the Nutrient Film Technique is one of the methods most often used by commercial growers. Plant roots are contained in a channel through which a thin "film" of nutrient solution passes. The nutrient solution is aerated and recycled with the addition of makeup water.
4. Run to waste; in this method the nutrient is fed to the plants at near the same rate as the plants use the water. In all the other methods, the nutrient solution returns to a tank to be recycled. This system is the cheapest to get started, however, it requires a lot of monitoring to insure the plants are getting enough nutrient but at the same time not getting too much nutrient. Plants will only take up the nutrients it needs. On sunny days they take up mostly water and leave the nutrients behind to build up. The built up salts must be purged from the system one or two times a week. This system wastes the most nutrients.

Systems

Plants most generally have to be started in a small amount of medium before they can be placed in the growing area. Seeds are started with no nutrients in the water. Seeds have their own food and don't require any additional nutrients until the first set of leaves appear. Nutrient is added at half strength to encourage root development until it's transplanted. Then full strength nutrients are used for the rest of the plants growth. There are two kinds of formulas for plants. One promotes the vegetative growth and the other promotes Fruiting. A system that has both types of plants will have to have one or the other formulas depending on which crop is more important. There are two methods of growing systems, horizontal and vertical. The following are systems:

- Bag culture; used commercially in run to waste systems. The hobbyiest can also use this inexpensive method in a recirculating system. Bags are filled with a lightweight medium and nutrient is fed to each bag by inexpensive spaghetti tubes. Has the advantage of being able to space the plants as they mature.
 - [Tomatoes in bag culture.](#)
- Gutter/NFT; A lot of hobbyiests have tried just about everything with this type system.
 1. Manufactured channels; Square corners help to prevent damming.
 2. Rain gutter; Metal gutter can oxidize and add undesirable materials to the nutrient

solution. Line with plastic sheet. Plastic gutters require total support to keep it strait.

3. PVC pipe; most hobbyists use PVC pipes with holes drilled for plants. This system is usually more expensive than bag culture. Too often the roots clog up the waterways and dam the water causing root rot. Aeration in the root zone may become a problem.
- Beds; are extra wide channels. Beds can be filled with a growing medium or pots can be placed in the bed so that they will pick up the water from the bed through a wicking action. Pots are the most versatile. Plants can be spaced to meet the plants needs. I use this method for houseplants and for starting seeds. A 1/4 inch of water can be maintained in beds with pots. Water must be drained well in filled beds. Beds can be made from any material that will hold the weight of the plants and the medium. A plastic film can be used to line construction. Nutrient solution is usually aerated and returned to the bed.

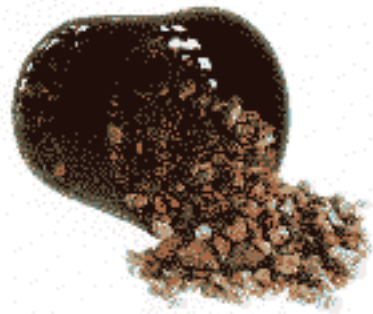

Although there is no soil in a hydroponic garden, the plants must still be anchored. There is a wide range of inert materials which can be used to support plant roots and we call them "growing mediums".

Heydite, clay pellets, Perlite, vermiculite, and Rockwool are the most popular media. The hydroponic media that work best are pH neutral, provide ample support for plants, retain moisture, and allow space for good air exchange. The type of media you choose will depend on the size and type of plants you wish to grow, and the type of hydroponic system being used.

For continuous drip systems, coarse media such as Heydite (a porous shale) or Hydrocorn (clay pellets) are best. The 1/4 " to 3/4 " pebbles provide enough free drainage and air space to take advantage of continuous feeding. These media also provide good anchorage for larger plants, and are easy to clean and re-use indefinitely.

Rockwool is also another popular medium. Made from rock which has been melted and spun into fibrous cubes and growing slabs with the texture of insulation, Rockwool provides roots with a good balance of water/oxygen. Small cubes are used for starting seeds and cuttings, 3" or 4" cubes for small plants or intermediate growth, and slabs for larger plants. Rockwool can be used with continuous drip or flood and drain systems. Although it is possible to sterilize and re-use Rockwool, most often it is used only once.



Perlite, made from volcanic rock, is a white, light weight material often used as a soil additive. The 1/8" to 1/4" pellets can be used alone as growing medium, but don't provide enough anchorage for large plants. Perlite is often used to start seed and cuttings, which can easily transplanted after rooting.

Vermiculite is use the same way as Perlite, and the two are sometimes mixed together. It is made from heat expanded mica and has a flaky, shiny appearance. Soilless mix such as Pro-mix BX, and Pro-mix lite has the appearance and texture of light soil. Mainly peatmoss, mixed with Perlite, it contains very little nutrient, and is used a a soil additive, or alone as a hydroponic medium.

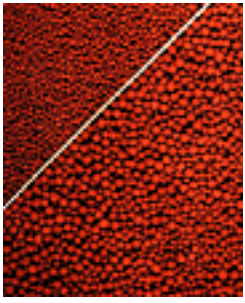

Some hydroponic systems do not require any growing medium at all. Various methods are used to support the plants while the roots are directly fed nutrient solution. Some examples of these are, aeroponic, N.F.T., or "Nutrient Film Technique" and deep water culture.

Growing Techniques

[Beginner's Growing Tips.](#)

Nutrient Film Technique.

The purist form of today's highly developed hydroponic growing systems is Nutrient Film Technique (N.F.T.). It is also the form of hydroponics most intriguing to the public because of its futuristic nature and appearance.

The nutrient is fed into growtubes where the roots draw it up. The excess drains by gravity back to the reservoir. A thin film of nutrient allows the roots to have constant contact with the nutrient and the air layer above at the same time.

Drip-Irrigation or Micro-Irrigation

Today's greenhouse irrigation systems employ, to an ever-increasing extent, the concept of drip or micro-irrigation. It entails a principle of minimized water consumption with maximized plant benefit. There are literally hundreds of emitting/dripping/trickling/micro-spraying/etc. devices on the market today for the commercial/hobbyist grower to choose from.

A submersed pump feeds nutrients solution through header tubes to secondary feed lines connected to drip emitters.

A controlled amount of solution is continuously drip-fed over the medium and root system. Another tube is connected to the lower part of the garden system to recover the solution.

Aeroponics / Deep Water Culture

Plant roots are suspended in highly oxygenated nutrient solution allowing easy inspection and pruning of roots. Air pumps, compressors or Oz injectors provide oxygen which is crucial to healthy plant growth. The simplicity and affordability of these very active systems make them popular with home hobbyists and commercial growers alike.

In an **Aeroponic** system the roots are misted within a chamber. A pump pushes the water with nutrient solution through sprayers, keeping the roots wet while providing a maximum amount of oxygen.

This technique is an excellent way to propagate cuttings.

Deep Water Culture is another form of aeroponics. The root system of a plant grown in Deep Water

Culture is immersed in water with a bubbling aerator keeping the roots oxygenated.

This technique is very good to use with plants that are heavy feeders.

Flood & Drain

Flood & Drain systems are similar to N.F.T. systems. They are ideal for multiple plant per square foot growing where individual plant inspection is difficult. They are also very popular as propagation tables.

A plastic growing tray is flooded periodically by a submersed pump connected to a digital timer (or the ControlFreak!). Medium and root system are soaked, then drained (via gravity back through the pump) at specific intervals.

Various mediums can be used, Rockwool is the most popular with Flood & Drain systems.

The Ebb & Flow trays are examples of the Flood & Drain system.

Home Hobbyist Systems

There are a number of compact hydroponic systems and kits most popular with home hobbyists, researchers and teachers. These are made to be especially attractive to children in order to get their attention and interest. Hobby systems include deep water and aeroponic systems which are scaled down versions of commercial systems.

Passive Planters / Hydroculture

This is probably the most commonly know form of hydroponics. These systems do not require a water or air pump and are therefore called passive systems. Passive Planters have been used in office buildings and restaurants for many years.

Hydroculture planters utilize a clean, porous growing medium to support plant roots. A nutrient reservoir in the base of the growing container allows the plants to take as much or as little water as they require. Water level indicators show exactly when and how much to water. Clean, odourless and non-allergenic, hydroculture or passive planters are ideal for every environment.

Beginner's Growing Tips.

[Growing Tips From the Experts.](#)

This page has been designed to help answer the important questions beginning growers might have when just getting started in hydroponics. A lot of these concepts are connected to each other. Follow the links and put the pieces of this growing puzzle together.

The more you know, the easier it is to grow!

Carbon Dioxide

During [photosynthesis](#), plants use carbon dioxide (CO₂), light, and hydrogen (usually water) to produce carbohydrates, which is a source of food. [Oxygen](#) is given off in this process as a by-product. Light is a key variable in photosynthesis.

[Conductivity](#)

Measuring [nutrient solution](#) strength is a relatively simple process. However, the electronic devices manufactured to achieve this task are quite sophisticated and use the latest microprocessor technology. To understand how these devices work, you have to know that pure [water](#) doesn't conduct electricity. But as salts are dissolved into the pure water, electricity begins to be conducted. An electrical current will begin to flow when live electrodes are placed into the solution. The more salts that are dissolved, the stronger the salt solution and, correspondingly, the more electrical current that will flow. This current flow is connected to special electronic circuitry that allows the grower to determine the resultant strength of the nutrient solution.

The scale used to measure nutrient strength is electrical conductivity (EC) or conductivity factor (CF). The CF scale is most commonly used in hydroponics. It spans from 0 to more than 100 CF units. The part of the scale generally used by home hydroponic gardeners spans 0-100 CF units. The part of the scale generally used by commercial or large-scale hydroponic growers is from 2 to 4 CF. (strength for growing watercress and some fancy lettuce) to as high as approximately 35 CF for fruits, berries, and ornamental trees. Higher CF values are used by experienced commercial growers to obtain special plant responses and for many of the modern hybrid crops, such as tomatoes and some peppers. Most other plant types fall between these two figures and the majority is grown at 13-25 CF.

--Rob Smith

[Germination](#)

When a seed first begins to grow, it is germinating. Seeds are germinated in a [growing medium](#), such as perlite. Several factors are involved in this process. First, the seed must be active--and alive--and not in dormancy. Most seeds have a specific [temperature](#) range that must be achieved. Moisture and [oxygen](#) must be present. And, for some seeds, specified levels of light or darkness must be met. Check the specifications of seeds to see their germination requirements.

The first two leaves that sprout from a seed are called the seed leaves, or cotyledons. These are not the true leaves of a plant. The seed develops these first leaves to serve as a starting food source for the young, developing plant.

[Growing Medium](#)

Soil is never used in hydroponic growing. Some systems have the ability to support the growing plants, allowing the bare roots to have maximum exposure to the [nutrient solution](#). In other systems, the roots are supported by a growing medium. Some types of media also aid in moisture and nutrient retention. Different media are better suited to specific plants and systems. It is best to research all of your options and to get some recommendations for systems and media before making investing in or building an operation. Popular growing media include:

- Composted bark. It is usually organic and can be used for seed [germination](#).
- Expanded clay. Pellets are baked in a very hot oven, which causes them to expand, creating a porous end product.
- Gravel. Any type can be used. However, gravel can add minerals to nutrient. Always make sure it is clean.
- Oasis. This artificial, foam-based material is commonly known from its use as an arrangement base in the floral industry.
- Peat moss. This medium is carbonized and compressed vegetable matter that has been partially decomposed.
- Perlite. Volcanic glass is mined from lava flows and heated in furnaces to a high temperature, causing the small amount of moisture inside to expand. This converts the hard glass into small, sponge-like kernels.
- Pumice. This is a glassy material that is formed by volcanic activity. Pumice is lightweight due to its large number of cavities produced by the expulsion of water vapor at a high temperature as lava surfaces.
- Rockwool. This is created by melting rock at a high temperature and then spinning it into fibers.
- Sand. This medium varies in composition and is usually used in conjunction with another medium.
- Vermiculite. Similar to perlite except that it has a relatively high cation exchange capacity--meaning it can hold nutrients for later use.

There are a number of other materials that can (and are) used as growing media. Hydroponic gardeners tend to be an innovative and experimental group.

Hydroponic Systems

The apparatuses used in hydroponic growing are many and varied. There are two basic divisions between systems: media-based and water culture. Also, systems can be either active or passive. Active systems use pumps and usually timers and other electronic gadgets to run and monitor the operation. Passive systems may also incorporate any number of gadgets. However, they do not use pumps and may rely on the use of a wicking agent to draw nutrient to the roots.

Media-based systems--as their name implies--use some form of [growing medium](#). Some popular media-based systems include ebb-and-flow (also called flood-and-drain), run-to-waste, drip-feed (or top-feed), and bottom-feed.

Water culture systems do not use media. Some popular water culture systems are raft (also called floating and raceway), nutrient film technique (NFT), and aeroponics.

Light

Think of a plant as a well-run factory that takes delivery of raw materials and manufactures the most wondrous products. Just as a factory requires a reliable energy source to turn the wheels of its machinery, plants need an energy source in order to grow.

Artificial Light

Usually, natural sunlight is used for this important job. However, during the shorter and darker days of winter, many growers use artificial lights to increase the intensity of light (for [photosynthesis](#)) or to expand the daylight length. While the sun radiates the full spectrum (wavelength or color of light) suitable for plant life, different types of artificial lighting are selected for specific plant varieties and optimum plant growth characteristics. Different groups of plants respond in physically different ways to various wavelengths of radiation. Light plays an extremely important role in the production of plant material. The lack of light is the main inhibiting factor in plant growth. If you reduce the light by 10 percent, you also reduce crop performance by 10 percent.

Light transmission should be your major consideration when purchasing a growing structure for a protected crop. Glass is still the preferred material for covering greenhouses because, unlike plastic films and sheeting, its light transmission ability is indefinitely maintained.

No gardener can achieve good results without adequate light. If you intend to grow indoors, avail yourself of some of the reading material that has been published on this subject. If you are having trouble growing good plants, then light is the first factor to question.

--Rob Smith

Natural Light

A large part of the success in growing hydroponically is planning where to place the plants. Grow plants that have similar growing requirements in the same system. Placing your system 1-2 feet away from a sunny window will give the best results for most herbs and vegetables. Even your regular house lights help the plants to grow. Make sure that all of the lights are out in your growing area during the night. Plants need to rest a minimum of 4 hours every night. If your plants start to get leggy (too tall and not very full), move the system to a spot that has more sun. Once you find a good growing area, stick to it. Plants get used to their home location. It may take some time to get used to a new place.

--Charles E. Musgrove

Macronutrients

Plants need around 16 mineral nutrients for optimal growth. However, not all these nutrients are equally important for the plant. Three major minerals--nitrogen (N), phosphorus (P), and potassium (K)--are used by plants in large amounts. These three minerals are usually displayed as hyphenated numbers, like "15-30-15," on commercial fertilizers. These numbers correspond to the relative percentage by weight of each of the major nutrients--known as macronutrients--N, P, and K. Macronutrients are present in large concentrations in plants. All nutrients combine in numerous ways to help produce healthy plants. Usually, sulfur (S), calcium (Ca), and magnesium (Mg) are also considered macronutrients.

These nutrients play many different roles in plants. Here are some of their dominant functions:

- Nitrogen (N)--promotes development of new leaves
- Phosphorus (P)--aids in root growth and blooming
- Potassium (K)--important for disease resistance and aids growth in extreme temperatures
- Sulfur (S)--contributes to healthy, dark green color in leaves
- Calcium (Ca)--promotes new root and shoot growth
- Magnesium (Mg)--chlorophyll, the pigment that gives plants their green color and absorbs sunlight to make food, contains a Mg ion

--Jessica Hankinson

Micronutrients

Boron (B), copper (Cu), cobalt (Co), iron (Fe) manganese (Mn), molybdenum (Mo), and zinc (Zn) are only present in minute quantities in plants and are known as micronutrients. Plants can usually acquire adequate amounts of these elements from the soil, so most commercial fertilizers don't contain all of the micronutrients. Hydroponic growers, however, don't have any soil to provide nutrients for their plants. Therefore, [nutrient solution](#) that is marketed for hydroponic gardening

contain all the micronutrients.

--*Jessica Hankinson*

Nutrient Solution

In hydroponics, nutrient solution--sometimes just referred to as "nutrient"--is used to feed plants instead of plain water. This is due to the fact that the plants aren't grown in soil. Traditionally, plants acquire most of their nutrition from the soil. When growing hydroponically, you need to add all of the nutrients a plant needs to water. Distilled water works best for making nutrient. Hydroponic supply stores have a variety of nutrient mixes for specific crops and growth cycles. Always store solutions out of direct sunlight to prevent any algae growth. See also conductivity, macronutrients, and micronutrients.

Disposal Unlike regular water, you need to be careful where you dispose of nutrient. Even organic nutrients and fertilizers can cause serious imbalances in aquatic ecosystems. If you do not live near a stream, river, lake or other water source, it is fine to use old nutrient on outdoor plants and lawn. Another possibility is to use it on houseplants. However, if you live within 1,000 feet of a viable water source, do not use your spent nutrient in the ground.

Osmosis

The ends of a plant's roots aren't open-ended like a drinking straw and they definitely doesn't suck up a drink of water or nutrients. Science is still seeking a complete understanding of osmosis, so to attempt a full and satisfactory description of all that's involved in this process would be impossible. However, we can understand the basic osmotic principle as it relates to plants.

First, consider a piece of ordinary blotting paper, such as the commonly used filter for home coffee machines. The paper might appear to be solid. However, if you apply water to one side of it, you'll soon see signs of the water appearing on the opposite side. The walls of a feeding root act in much the same way. If you pour water onto the top of the filter paper, gravity allows the water to eventually drip through to the bottom side. Add the process of osmosis and water that's applied to the bottom side drips through to the top.

With plants, this action allows water and nutrients to pass through the root walls from the top, sides, and bottom. Osmosis is the natural energy force that moves elemental ions through what appears to be solid material. A simplistic explanation for how osmosis works, although not 100 percent accurate, is that the stronger ion attracts the weaker through a semipermeable material. So, the elements within the cells that make up plant roots attract water and nutrients through the root walls when these compounds are stronger than the water and nutrients applied to the outside of the roots.

It then follows that if you apply a strong nutrient to the plant roots--one that's stronger than the

compounds inside of the root--that the reverse action is likely to occur! This process is called reverse osmosis. Many gardeners have at some time committed the sin of killing their plants by applying too strong a fertilizer to their plants, which causes reverse osmosis. Instead of feeding the plant, they have actually been dragging the life force out of it.

Understanding how osmosis works, the successful grower can wisely use this knowledge to promote maximum uptake of nutrients into the plants without causing plant stress--or worse, plant death--from over fertilizing. All plants have a different osmotic requirement or an optimum nutrient strength.

--Rob Smith

Oxygen

As a result of the process of [photosynthesis](#), oxygen (O) is given off by plants. Then, at night, when light isn't available for photosynthesis, this process is reversed. At night, plants take in oxygen and consume the energy they have stored during the day.

Pests and Diseases

Even though hydroponic gardeners dodge a large number of plant problems by eschewing soil (which is a home to any number of plant enemies), pests and diseases still manage to wreak havoc from time to time. Botrytis, Cladosporium, Fusarium, and Verticillium cover most of the genera of bacteria that can threaten your plants. The insects that can prove annoying include aphids, caterpillars, cutworms, fungus gnats, leaf miners, nematodes, spider mites, thrips, and whiteflies.

A few good ways to prevent infestation and infection are to:

- Always maintain a sanitary growing environment
- Grow naturally selected disease- and pest-resistant plant varieties
- Keep your growing area properly ventilated and at the correct temperatures for your plants
- Keep a close eye on your plants so if a problem does occur, you can act quickly

With insects, sometimes you can pick off and crush any large ones. Or you can try to wash the infected plants with water or a mild soap solution (such as Safer Soap).

If a problem gets out of control, it may be necessary to apply a biological control in the form of a spray. Research which product will work best in your situation. Always follow the instructions on pesticides very closely.

Alternatively, there are a number of control products on the market today that feature a botanical compound or an ingredient that has been synthesized from a plant material.

On botanical compounds as controlling agents:

Over the last few years, researchers from all around the world have started to take a much closer look at any compounds present in the plant kingdom that might hold the answer to our pest and disease control problems. Many companies have even switched from producing synthetic pesticides to copying nature by synthesizing naturally occurring compounds in a laboratory setting. Extracts of willow, cinnamon, grapefruit, garlic, neem, bitter-sweet, lemon grass, derris, eucalyptus, and tomato have been helpful in controlling diseases and pests.

--Dr. Lynette Morgan

pH

The pH of a [nutrient solution](#) is a measurement of its relative concentration of positive hydrogen ions. Negative hydroxyl ions are produced by the way systems filter and mix air into the nutrient solution feeding plants. Plants feed by an exchange of ions. As ions are removed from the nutrient solution, pH rises. Therefore, the more ions that are taken up by the plants, the greater the growth. A solution with a pH value of 7.0 contains relatively equal concentrations of hydrogen ions and hydroxyl ions. When the pH is below 7.0, there are more hydrogen ions than hydroxyl ion. Such a solution "acidic." When the pH is above 7.0, there are fewer hydrogen ions than hydroxyl ions. This means that the solution is "alkaline."

Test the pH level of your nutrient with a kit consisting of vials and liquid reagents. These kits are available at local chemistry, hydroponic, nursery, garden supplier, or swimming pool supply stores. It is also a good idea to test the pH level of your water before adding any nutrients. If your solution is too alkaline add some acid. Although such conditions rarely occur, sometimes you may have to reduce the level of acidity by making the solution more alkaline. This can be achieved by adding potassium hydroxide (or potash) to the solution in small amounts until it is balanced once again.

--Charles E. Musgrove

Photosynthesis

Plants need to absorb many necessary nutrients from the nutrient solution or--in the case of traditional agriculture--the soil. However, plants can create some of their own food. Plants use the process of photosynthesis to create food for energy. Carbohydrates are produced from carbon dioxide (CO₂) and a source of hydrogen (H)--such as water--in chlorophyll-containing plant cells when they are exposed to light. This process results in the production of oxygen (O).

Plant Problems

Every now and again, you are sure to run into a problem with your plants. This is just a simple fact of any type of gardening. The key is to act quickly, armed with quality knowledge.

Mineral Deficiency Symptoms

Nitrogen deficiency will cause yellowing of the leaves, especially in the older leaves. The growth of new roots and shoots is stunted. In tomatoes, the stems may take on a purple hue.

A phosphorous deficiency is usually associated with dark green foliage and stunted growth. As in nitrogen deficiency, the stems may appear purple. But since the leaves don't yellow as they do in nitrogen deficiency, the whole plant can take on a purplish green color.

Iron deficiency results in yellowing between the leaf veins. In contrast to nitrogen deficiency, the yellowing first appears in the younger leaves. After a prolonged absence of iron, the leaves can turn completely white.

--*Jessica Hankinson*

Wilting

This condition can be caused by environmental factors or disease (usually caused by Fusarium). Nutrient and media temperature can be adjusted to remedy wilt. However, if Fusarium have taken hold, the chances that your plants will survive are slim.

If wilting is due to environmental causes:

Try to spray the plants and roots with cool, clean water to rejuvenate them. If this hasn't helped them by the next day, try it again. If the plants respond, top-off the nutrient solution and check the pH. If the plants don't respond to the misting, empty the tank, move it to a shadier spot, and refill with cool, fresh nutrient solution. Don't reuse the old solution--start with fresh water and nutrients.

--*Charles E. Musgrove*

If wilting is due to a system blockage of nutrient:

I have seen tomato plants that have been so dehydrated due to a nutrient supply blockage that they were lying flat and for all the world looked stone-cold dead. When the nutrient flow resumed and the plants were given the less stressful environment of nighttime, they rebounded so well that I wondered if I had dreamed the previous day's "disaster." The moral of this story is to always give plants a chance to revive, even when the situation looks hopeless.

--*Rob Smith*

Propagation

Plants can be propagated by a number of methods. Growers can let a plant go to seed, collect the seeds, and then start the cycle over again (see [germination](#)). Another method is to take stem cuttings, which is also known as cloning (because you are creating an exact copy of the parent plant).

Although this process won't work with all plants, it is a highly effective technique. Simply cut off a side shoot or the top of the main shoot just below a growth node. Make sure that there are at least two growth nodes above the cut. Remove any of the lower leaves near the base of the new plant. This cutting can then be rooted by placing it in water or in a propagation medium (perlite works well) that is kept moist. The use of some rooting hormone can help your chances of success.

Pruning

Remove any discolored, insect-eaten, or otherwise sick-looking leaves from plants. Picking off some outer leaves or cutting the top off a plant can help it grow fuller. Use sharp scissors to prune your plants. Sometimes you will want to prune a plant to focus its energy on the remaining shoots. Pruning is an art and should be performed with care. Damaged or dying roots may also need to be pruned from time to time.

Soil

Never use soil during any aspect of hydroponics. If you ever move a plant from a soil-based situation to hydroponics, remove all traces of soil or potting mix from the roots. Soil holds lots of microbes and other organisms and materials that love to grow in and contaminate your hydroponic system. Some of these will actually parasitize your plant and slow its growth. This is another advantage of hydroponic growing: The plant can get on with growing without having to support a myriad of other organisms as happens in conventional soil growing.

--Rob Smith

Temperature

Different plants have different [germination](#) and growing temperatures. Always make sure that you check each plant's growing requirements--especially minimum and maximum temperature levels. Keep in mind that specific varieties of plants may have different requirements.

Water

Because the water supply is the source of life for your plants, quality is important. All plants rely on their ability to uptake water freely. Between 80 and 98 percent of this uptake is required for transpiration (loosely compared to perspiration in animals), which allows the plant to produce and somewhat control its immediate microclimate. Plants also need clean, uncontaminated water to

produce their own healthy food supply.

--*Rob Smith*

The water you use in your hydroponic system needs to be pure. It is always a good idea to test your water source before adding nutrients so you aren't adding an element that is already present. In small systems, it would be wise to use distilled water.

If you are starting a larger hydroponic operation, it would be a good idea to have a water analysis completed. Factors such as sodium chloride (NaCl, or salt) content and hardness will be of great use to growers. Also, groundwater can have elements normally not present in conditioned water. A key piece of advice: Get to know your water!

Growing Tips From the Experts

Rooting a Cutting:

- have everything ready first then take your cuttings and plant them right away
- for best results, take cuttings first thing in the morning
- use only healthy actively growing stock plants with soft green stems (woody stem cuttings do not root fast!!!)
- for green stem (softwood) cuttings use a straight clean cut; for yellow or brown stem cuttings use a slanted cut
- remove any leaves or branches that would be below the soil line (snip off leaf stem, leaving a 1/4" stub)
- dip cutting into "Roots" or other hormone products
- after planting, trickle a few drop of water down the stem to settle the soil mix around the stem

To Root in Potting Soil or Soiless Mixes:

- fill containers with potting mix
- water well with room temperature water with "Nutri-Boost" added ("Nutri-Boost" is a vitamin mix; add 7 drops per litre or quart of water)
- it is always a good idea to have "No-Damp" nearby in case you notice any signs of wilting; if this occurs, use the recommended application rate of 10m. "No-Damp" to 1 litre of water and spray generously
- now take your cuttings, dip them into a rooting hormone and plant them right away

To Root in Rockwool Cubes:

- rinse cubes in lukewarm pH balanced water
- water cubes with "Nutri-Boost" solution as described above
- plant the cutting 3/4" of the way into the cube

More Helpful Hints:

- root cuttings under moderate light (flourescent light) at 70 - 75°F
- if you use a clear cover, remove twice a day and wipe any condensation off the cover and replace
- use only water and "Nutri-boost" solution until cuttings show signs of new growth at tips then feed with 1/2 strength fertilizer

Hydroponic Nutrient Manipulation and Modification Techniques

or "Playing with your food"

Some gardeners are ignoring their mother's advice and modifying their fertilizer mixes. The fact is, the soil-less mixes, lava rock, rockwool, etc. hold little or no food compared to garden dirt, so any change in fertilizer strength or quality is noticed by the plant almost immediately.

This is why gardeners use different fertilizers for different stages of growth, giving the plant just what it needs for today's "Work". Here are some other tips on changing your fertilizer mix for special circumstances.

Food Strength

We match food strength to growing conditions in the garden, and to the health and activity of the plant.

Weak fertilizer for:

- newly rooted cuttings
- plants in low light conditions
- plants in hot gardens (over 90°F or 33°C)
- plants under stress - disease, bugs, etc.
- plants in transition between stages of growth
- plants in poor growing conditions - crowded, root-bound, poor air movement, etc.

Regular Strength Fertilizer for:

- healthy plants in active growth
- good light levels, temperature and air movement

Strong Fertilizers for:

- natural spurts of growth in crop plants
- plants in very good growing conditions - very high light levels; precise, consistent temperatures; major air movement through plants; excellent exhaust and intake fans; huge quantities of CO2 delivered efficiently to the garden; regular growth hormone treatments (to help the plant take up stronger foods)

Note: Increase food strength gradually - watch for black leaf tips!

Food Formulas - We modify fertilizers by changing the quantity of individual nutrients for special circumstances.

Low Nitrogen Fertilizers:

- to avoid "stretching" (long thin stems) of plants between stages of growth.
- a good example would be a chrysanthemum grower who has shortened the day length to make the plants start their flower cycle; he would use a full strength fertilizer with Nitrogen only (1/2 strength or less) to keep the plants compact until the flower buds form.
- return to regular Nitrogen levels once your plants have actually begun their next growth stage.
- this trick works especially well with our "B" and "C" fertilizers.

You can see that gardeners start by examining the conditions in the garden and the "job" of their plant, then decide what strength and quality to mix their fertilizers.

So What's the Deal with Pesticides?

Well, they suck! However, sometimes they are necessary to save your valuable crop. The "new" trend is to use pesticides only as a last resort. Your object is to control your pests and you might even get lucky and wipe them out.

Start with a healthy plant! It's much less likely to develop problems than a plant under stress. Bugs seem to sense a hurting plant, much like a pack of wolves will prey on an injured or tired animal. That's where our Predators come in. Just wonderful little things. They are moderately priced and they do all the work for you. When the bad guys are all gone, (ie. no more food), they either pack their bags and leave, or eat each other down to the last one. Predators are carnivores (eat meat) not herbivores (vegetarians), therefore no worries about damage from them.

Predators have been used since before the "Dead Sea" was even sick. It's only since First World War France, where pesticides and rodenticides were first used in the trenches to relieve troops of overwhelming infestations that we have changed our thinking. We've been poisoning our land, our water, and ourselves ever since. Some treatments are much safer than others. Pokon and Safers Soap are a good organic way to go, plus we can get you Predators within a day or two. This old/new topic is called "Integrated Pest Management", or I.P.M. for short.

Avoiding Plant Diseases

Watching healthy plants get sick and die is a very depressing sight to a gardener. Plant diseases are always out there, waiting to attack your garden. While some diseases are easily treated, other more serious diseases will require repeat treatments to handle. Some diseases are so serious (tobacco mosaic virus for example), that the plant is doomed. Plant diseases can seriously lower crop production, even if the sick plants recover. Let's keep diseases out of our gardens! Here's how:

Good Growing Conditions and Practices:

The best defence against plant disease is to keep your plants healthy and actively growing, by creating good conditions in your garden.

Attention to temperature, air movement and air change, proper spacing of plants, consistent growing conditions - all these practices ensure healthy, stress-free plants that can resist bugs and disease well. Often, bugs and disease will attack a weak plant in your garden and build up armies to invade the rest of your healthy plants!

Sanitization:

Use Healthy Plant Stock

- a cutting from a sick plant will carry on the disease in the new plant.
- some varieties of a plant will have greater natural resistance to disease than their "weak sisters"; if possible, grow only varieties that have known disease resistance.

Keep Tools, Hands and Clothing Clean

- diseases, pests and insect eggs can travel to new host plants
- during pruning, transplanting and handling; wash your hands after handling diseased plants before you touch a healthy one
- clean tools and knives well after use
- keep garden clear of dead leaves

Sterilize Garden or other Grow Mediums

(a Medium is what your roots are growing in)

- this is especially important when using garden dirt from the backyard in a container indoors or when using recycled rockwool or lava rock for new crops
- the soil-less potting mixes and new rockwool are considered clean already - no further treatment is needed

Use R/O Water or Distilled

- if you are concerned about the possibility of disease in your water, there are a couple of simple methods to treat water and kill disease before you infect your garden:

Chlorine Bleach (1/4 cup for 30 gallons)

- add to water and stir well
- add fertilizer to water after treating with bleach
- use air pump and air stone to drive off bleach and keep water bubbly

Hydrogen Peroxide (35%) (1 tablespoon for 10 gallons)

- this product is actually water with extra oxygen, and the active oxygen will kill disease in the water
- add to water
- stir well, then add fertilizer

Note: Peroxide helps plants to take up food easier and quicker, so this treatment has an extra benefit to the garden.

Watch your garden for problems and treat them promptly! You may eliminate the disease entirely, before it gains a foothold in your garden.

Treating Fungus and Bacteria in Your Garden

Seedlings and Newly Rooted Cuttings

- treat with No-Damp or other mild fungicide
- be sure roots are already wet before root-drench treatment: No-Damp contains alcohol that could damage dry roots or unrooted cuttings
- treat plants once a week until plants recover

Vigorous Plants - Green Growth (no flowers or crop on plant)

- spray top-growth well with Safers Garden Fungicide
- wet all leaves until liquid runs off leaves

" Caution " - Do not spray plants with flowers or crop on them; you will definitely burn your crop!

- treat your plants once a week - the best time to spray is late in the day, so the plants can dry in the dark; avoid spraying in strong light.

Flowering or Crop Plants

- treat plants by hand-watering Benomyl fungicide into the roots

" Caution " - Never spray a flowering plant with fungicide; it could damage the flower or crop!

- water enough Benomyl solution into the roots to drench the entire root system
- treat the plants when the roots are already wet from feeding or watering, and when they won't be watered again for at least a few hours
- treat once a week

Hints on Treating Plants for Disease

- avoid high temperature and strong fertilizers until plants recover
- disease can become tolerant of a fungicide if used many times; after you have used one product three or four times in a row, switch to another suitable product and attack the disease with a new weapon.

Safers Garden Fungicide is a sulphur based product only for spraying Green Growth.

Do not use Safers Garden Fungicide for crop plants!

Lighting Tips Photosynthesis

Photosynthesis is the process by which plants use light energy to collect carbon dioxide from the atmosphere and convert it to chemical energy in the form of sugar. The products of photosynthesis serve to nourish the plant and enable it to release free oxygen. Plants use only the spectrum of light that is visible to the human eye. Although the light appears white, it is actually a mixture of all the colours of the rainbow. Pigments, which are the light harvesting units of the plants, absorb certain colours of the spectrum and reflect the rest. Chlorophyll, the main pigment used in photosynthesis, absorbs light in the violet and blue wavelengths as well as in the red, leaving green the colour it reflects, and the plant colour we see. Photosynthesis can also occur indoors, providing the artificial light source used supplies the necessary spectrum and intensity.

Wide spectrum fluorescent, metal halide, and high pressure sodium are the types of lights most widely used for indoor growing. All of these lights require a ballast to operate and come in a variety of sizes and wattage's.

Homegrown provides a wide range of grow lights that provide the necessary spectrum and intensity to suit plants' needs.

Sunmaster line of Metal Halide Lamps was developed specifically for plant growth by closely matching the spectrum of natural sunlight.

Light is the most growth influencing factor!

Read more about: [Fluorescent](#) - [HID](#) - [Light Movers](#)

Lighting Tips

- mylar reflects with up to 95% efficiency
- flat white paint reflects with up to 80% efficiency
- never use tinfoil for reflection it creates "hot Spots"
- use air cooled reflectors when heat build-up is a problem
- 15 minute time delays for halides prevent "hot starts"
- low pressure sodium lights greatly increase intensity for pennies a day
- light movers increase growth by up to 40%
- halide "super"bulbs increase intensity but not your hydro bill
- 430 watt Son Agro sodiums supply 30 extra watts of blue light
- wear sunglasses when working close to an H.I.D. bulb
- if your light fails, don't try to fix it yourself, contact a qualified expert

Lighting Types.

Fluorescent

Before high intensity discharge light came along, indoor growers depended mainly on fluorescent lights for best results. They are inexpensive, reasonably energy efficient, and most emit a wide enough spectrum of light for plant growth. There is a wide range of fluorescent bulbs or "tubes" available, and are categorized by wattage, length, and colour of spectrum range. Indoor growers should look for the type specifically made for plants such as the vita-Lite* or Ultralume 5000*.

The fixtures for these lamps are usually complete with lamp holders, reflector, and built-in ballast. Since the introduction of H.I.D. lights, fluorescent now are mainly used for propagation and early vegetative growth. The 20 watt, 24 INCH, and 40 watt, 48 inch, are the most common. The more intense and energy efficient H.I.D.'s are now the choice for maturing high-light plants and vegetables indoors.

High Intensity Discharge (H.I.D.) Grow Lights

Metal halide lights were created to provide a spectrum as close as possible to that of the natural sunlight. This coupled with their intensity and energy efficiency, makes them ideal for indoor gardening. The bulbs range in size from 100 watt to 1000 watt with 400 watt and 1000 watt most popular.

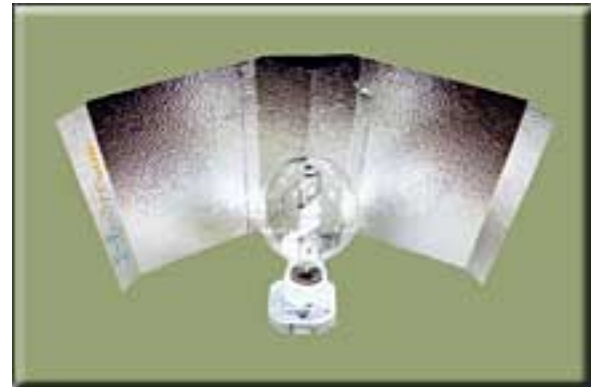

An abundance of blue light emitted by metal halide makes them the best light for propagation and vegetative growth, promoting short internodal length. High Pressure Sodium lights do not emit as broad a spectrum as Metal Halides lights, but have many advantages, especially when used in conjunction with halide. Sodiums last longer, and burn brighter, but are still more energy efficient.

More yellow/red colour in the spectrum and less blue promotes a higher flower-to-leaf ratio in flowering plants. H.P.S. lights are widely used in commercial greenhouses, where natural sunlight provides sufficient blue. A combination of the two lights provides the best balanced for indoor growroom, especially when used with a light mover. 430 Watt Son Agro H.P.S. bulbs which supply 30 extra watts than regular ones are

now available. This extra light in the blue end of the spectrum is great news for indoor growers. If you are planing a "single lamp" growroom, you can still get the benefits of both halide and sodium light. High pressure sodium "conversion bulbs", specially made to operate with M.H. ballasts, are available in 400 watt and 1000 watt models. The bulbs can easily be interchanged as needed, using the same ballast and fixture. The size of the light you will need will depend on the size of the growing area, and the type of plants you wish to grow.

High-light plants such as herbs and vegetables will require between 20 and 60 watts of light per square foot of growing space. A 400 watt metal halide in a three foot by three foot area will provide 45 watts per square foot, compared to 25 watts per square foot in five foot by five foot growroom. A 1000 watt metal halide in a five foot by five foot area will provide 40 watts per sq.ft., compared to 20 watts per square foot in a seven by seven foot growroom.

Proper reflectors, light movers, and reflective material on walls greatly increases intensity and efficiency of these lights.

Most high intensity lights can be run with either 120 volt (standard house current), or 240 volt (e.g. used for electric dryer).



Electricity cost would be the same but the latter would draw half the amps allowing the grower to run twice as many lamps on the same electrical circuit.

Light timers are available for either voltage but always check to see that the amperage rating on the timer exceeds that of the light or lights.

Care should always be taken when installing and using H.I.D. lights. Remote ballasts should be placed safely out of the way where they can't be knocked over or splashed with water. Never keep your ballast on the floor in case it gets wet. Installing the fixture and reflector is simple. Locate a stud in the ceiling near the centre of the grow area. Screw a metal hook capable of holding 40 to 50 pounds into the stud and test it's strength. Attach a 4' to 6' length of lightweight link chain to the hook or hooks on top of the fixture and hang the fixture from the ceiling hook at

the desired height. The link chain allows you to easily raise and lower the light when necessary. Hold the lamp near the base and firmly, but gently, screw the bulb into the socket. Connect the timer to the power source, plug the power cord from the ballast into the timer which should be set in the "on" position. It may take up to 30 seconds for the bulb to ignite and up to five minutes to reach full brightness. As the lamp ignites, they tend to flicker and change colour for several minutes. This is quite normal, especially with halide bulbs, which may appear to change colour slightly during normal use. If the lamp does not ignite after 30 or 40 seconds, unplug it. After the power has been disconnected, check

- that the bulb is screwed in all the way
- that the timer is set on the "on" position
- that all plugs or electrical connections are O.K.

NOTE: Do Not Open The Ballast Enclosure To Check Wiring Yourself! H.I.D. capacitors can hold a charge even after the ballast is unplugged! Once these points have been checked, try the light again.

Once a metal halide lamp is turned off it requires a 15 to 20 minute "cool down" period before it can be re-started. If ample cooling time is not allowed, a "hot start" occurs, and too many "hot starts" can seriously affect the intensity and longevity of the bulb. For best results, replace halide bulbs after one year of steady use. High pressure sodium lamps require only 2 to 3 minute "cool down" period and need only be replaced every two to three years.



LIGHT MOVERS

The most efficient way to use high intensity lights is to have them moving within the growroom.

There are many advantages to this, and a number of different ways it can be done. Moving the lights will eliminate plants tendency to grow toward the light source and provide light to areas which otherwise may be shaded. Since the light is moving, it can pass quite close to the plants without burning the leaves.

Moving lights cover more area than stationary ones, reducing electricity costs and ensuring more even growth.

More intensity also allows plants to be placed much closer together, greatly increasing yield and quality. The size and shape of your room will determine the type of light mover that will best suite your needs.

Lineal movers carry the light fixture slowly along a track and back again during the light cycle. Most are six feet long, support a single lamp, and are recommended when the growing area is long and narrow.

Circular movers are best when the length and width of the room are similar. They are designed to carry either one, two, or three lights, in a 360 degree circle, ideally lighting a ten by ten foot area. This diameter can be reduced but rarely extended.

Two arm and three arm movers are most popular, with the latter supplying much more light per square foot. More intensity means plants can be placed much closer together, greatly increasing yields.

Advantages of using light movers:

- more even growth over a larger area
- lamps may be placed closer to crop
- increase growth by 40%
- stronger plant stems
- counteract leaf shading
- circular movers can move up to 3 lamps
- 1 or 2 meter linear track support single lamps, extension kits are used for additional lamps



Benefits of Hydroponic food production.

Hydroponics and Environmental & Health issues

- Pesticide free products through biological pest control.
- Nutrient solutions may be re-used in other areas such as potted plants and turf management.
- Growing mediums can be re-used and recycled.
- Hydroponic systems use little or no growing medium.
- More intense cropping technique requires less space.
- Non-arable land may easily be facilitated.
- Year round crop production in Canada reduces transportation of imports and therefore associated solution e.g. fossil fuels.
- Promotes an overall awareness of our environment.
- Closed recirculating systems allow the grower control of the nutrient solution and therefore exactly what nutrients the plants receive.
- Varying nutrient formulas to suit different plants at different stages.
- Regular nutrient testing ensures all elements are present in their desired concentrations. Unwanted build ups of undesirable nutrient concentrations, such as nitrites, can be avoided.
- Hydroponic plants are more pest resistant.
- Control over environmental factors translates to a nutritionally superior, vegetable product.
- Vine ripened, Canadian grown produce eliminates consumption of artificial ripening agents and pesticides used on imported produce.
- Vine ripened, Canadian grown produce tastes superior and is nutritionally sound.

Hydroponics and Economical and Social issues

- Canadian business stimulates Canadian economy for growers, manufacturers of their supplies, as well as distribution, wholesale and retail outlets.
- Opens up positions for job training and employment.
- Satisfies consumer demand.

Building Your Own Hydroponic System.

[Germinating and Transplanting.](#)

[Hydroponic Root Chamber.](#)

[Flood and Drain.](#)

[Drip Feed System.](#)

[12 Plant Patio Table Garden.](#)

[11 Plant 1 inch screw off bottle garden.](#)

[Expandable 9 plant garden.](#)

[Water Culture System.](#)

[Windowsill Wonder.](#)

[The Aquafarm.](#)

[Controller Instructions.](#)

[WaterFarm / AquaFarm Setup Instructions.](#)

[Powergrower Setup Instructions.](#)

[Eve's Garden Setup Instructions.](#)

[Planning and Building a Greenhouse.](#)

[Indoor Lighting.](#)

[Retail Hydroponic Systems.](#)

[Mixing Hydroponic Juices.](#)

[Hydroponic Pumps.](#)

BASIC PRINCIPALS; Plant foliage requires light, oxygen and carbon dioxide. Plant root systems require water, nutrients and oxygen. When plants are grown normally water leeches nutrients from the soil and carries them to the roots. The water and nutrients are taken up by the roots to feed plant growth. Soil drainage then allows water to be replaced by air in the gaps between soil grains. This supplies the roots with oxygen.

In hydroponics the nutrients are dissolved in the water. Soil is replaced with a growing medium to supply the roots with water, nutrients and oxygen. Hydro juice (nutrient solution) can be drip fed to each plant, it can also be used to regularly flood the root chamber, then drain out. Both methods require a pump and timer to circulate the nutrients through the roots and are covered by these diagrams and notes. Roots can also be grown in the air by spraying roots with a fine mist of hydro juice, or grown in the hydro juice and the solution aerated under each root mass with an air pump. With both of the second two methods the plants must be secured at the base of the stem or something.

The hydroponic system described does work and is suitable for any plant with stringy roots. I have not tried it with any bulb plants or plants such as orchids that require fungus or mold in the soil to grow. This method is similar to Nutrient Film Technique (NFT) the thin Rockwool slice acting as a capillary mat. This eliminates the need to have a flat bottom the root chamber and to level the bottom of root chamber, making it easier and cheaper to set up.

This method will get the most vigorous growth if each plant has its own continuous drip feed. The dripper is positioned drip on roots growing from the base of the seedling block, the roots will grow thick, hairy and compact under the dripper. 4L per hour drippers are used however their drip rate depends on pressure, this is effected by height and size of the drip feed tank. The drip rate will slow as the tank empties.

Feeding can also be achieved with a faster dripper at the top of each top end of each side of the root chamber. The plants grown like this had a large root mass, the roots of three plants taking up about a third of the root chamber. With the timer I had could only flood the root chamber every 4 hours, the growth rate was similar to the last. The growth rate will improve by flooding every hour or even less. After the root chamber is flooded it should drain to a trickle in a few minutes.

STARTING PLANTS; Soak seeds in damp paper or cotton wool, cover seed with damp paper or cloth, drain off excess water and don't allow to dry out. When the seed root is 2 - 5mm. long place the seed root first in the small hole with tweezers (fig.3). Make sure the root is protected by the open jaws of the tweezers and that the seed or root isn't squashed. Then place seedling block hole up on a plate and wet Rockwool until it won't take any more water. Keep the plate on an angle for drainage, but the seedling blocks shouldn't dry out too much and seedling should come up in a few days. Seedlings can stay on the plate until roots grow from the bottom or sides of the seedling block (fig.4). When this happens seedlings are ready to be transplanted on to the Rockwool mat in the root chamber. (Before the seedling blocks go into the root chamber the rockwool is soaked in water 24 hours then with hydro juice at half strength.) Roots will grow from seedling block, through and along the under side of the Rockwool mats. Place three to eight plants per side, evenly spaced along the slot, and it will soon grow into mass of green. When the system is operational and plants are growing, the inside of the root chamber should have a rich earthy smell. Three or four plants if your growing them big (outdoors), eight if your growing fast and flowering early (under lights).

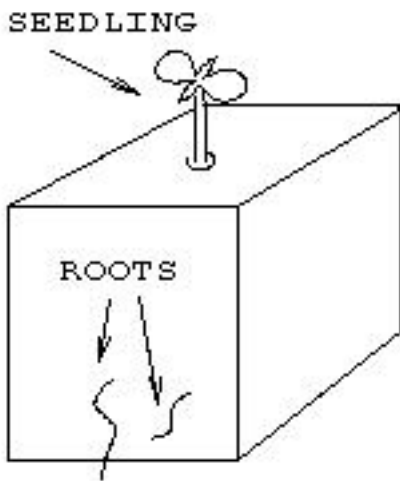
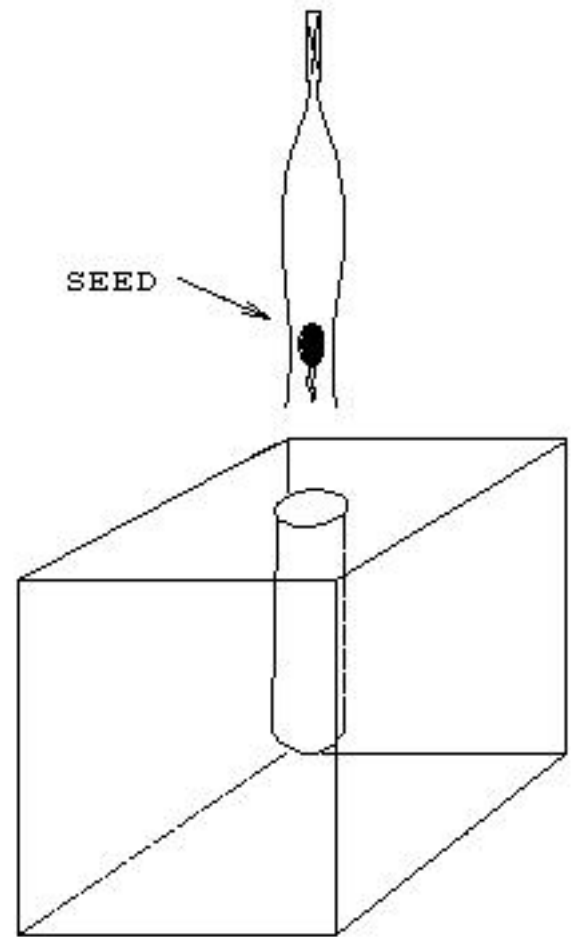

When the roots grow from the bottom or sides of the Rockwool block it's ready to transplant into the grow tube. Once the roots have grown into the mat you can hit them with full strength hydro juice. Light proof plastic should be used to cover the top of the root chamber white side up, this is to stop green slime growing on the rockwool. This can only be done when the plant is tall enough, take care not strain or damage the plant.

CROSS SECTION OF THE
HYDROPONIC ROOT CHAMBER

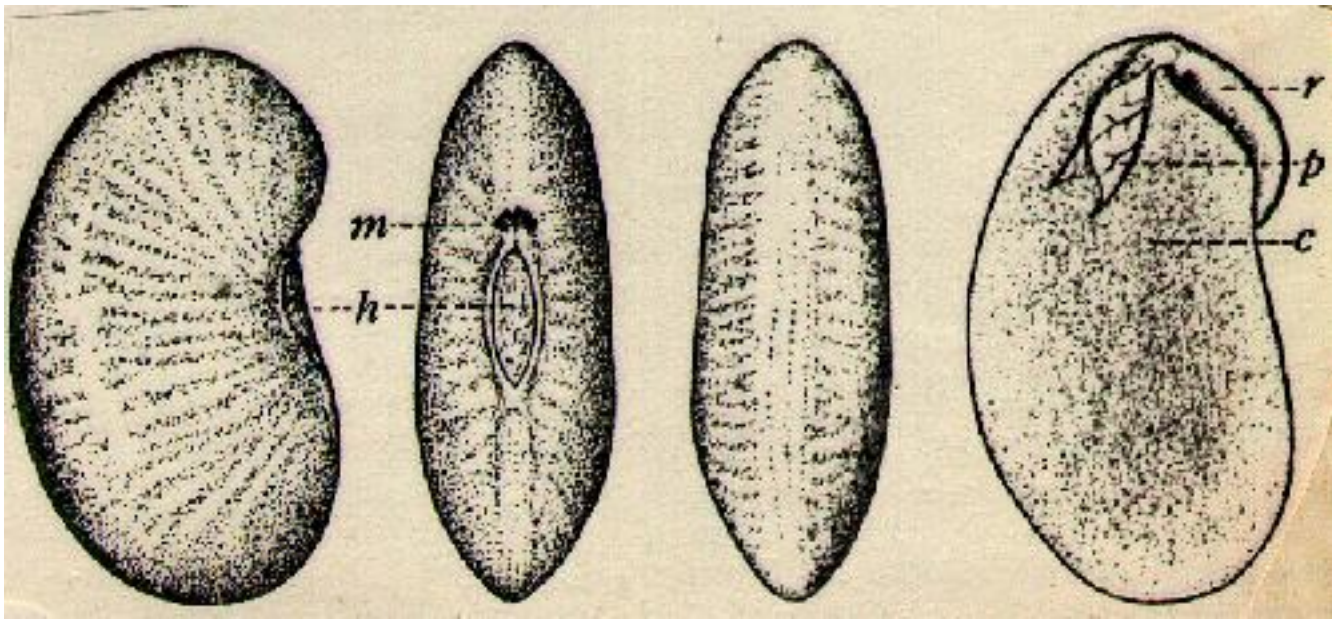
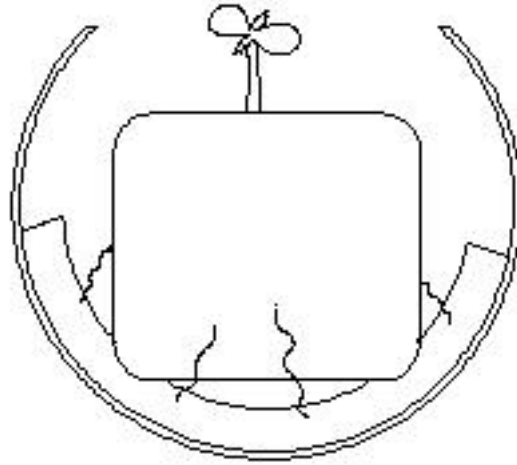

Many seeds require special conditions to germinate. For example, most garden vegetables and herb seeds need to remain damp or wet for some time.

Seeds can be germinated in a hydroponic grower, and often they germinate even better than in soil.

Planting Seeds

Most seeds are placed below the surface of the media. A suggested placement is from $\frac{1}{2}$ to 1 inch below the surface. This keeps the seed very moist and will give it some feel for when the light is and where the dark is. The root of the plant will grow down towards the dark and the water, and the plant stem and leaves will go towards the light.

Many seed packets include instructions for soil and mention how deep to bury the seeds. They can be planted at the same depth in hydroponics.

Some seeds, like beans and corn, will germinate in just a few days. Some others, such as tomato, bell pepper and herbs may take as long as two weeks until they appear. Growers with seeds should be watered each day although no plants are showing. If you do not see any sign of life after two weeks, it is best to replant the grower.

Occasionally the grower root area will be so cold or so dry, the seeds will not germinate.

To germinate very small seeds like many herbs, a special form of germination may be required. One way is to start the seeds between two pieces of paper or a towel soaked with water. The towel is kept moist each day.

Germinating some types of seeds is more complicated than just soaking in water. Some seeds need to be damaged in some way to germinate, and others are specialized to respond to periods of temperature or light. If there something you would like to grow, it might help to learn what the seed requirements are to germinate.

Other Methods of Reproducing

Some plants can reproduce from cuttings. This means cutting a small part of the growing tip of a plant, pulling off the bottom leaves and sticking the cut end into the growing media. Some of the plants that can be reproduced from cuttings are basils and many of the herbs.

Garlic reproduces from individual garlic cloves. Some of the garlic in the grocery store is treated and will not sprout. An organic garlic is more likely to sprout.

Potatoes are grown from a planted potato. The potato can be cut into pieces or planted whole.

ROOT CHAMBER.

ROOT CHAMBER; The Root Chamber is made from 90mm. PVC storm water pipe. This type is used for all new building constructions so off cut are about. A selection of 90mm. PVC storm water pipe and 90mm. fittings are available at large hardware stores. Fittings include right angles, tee junctions, end caps and others. These can be used to make the root chamber suit any room. The root chamber show in Diagrams (fig.5,6,7) is made with two lengths about 1 miter for the sides, 2 lengths about of 600mm. for the ends and 4 right angles for the corners. PVC pipe glue is used to make all joins water tight. A slot is cut in the top of each side providing access to change growing medium and remove root mass. Holes instead of a slot may be used for each plant but another way of access must be used. A drain hole or holes are drilled in the bottom of one end of the root chamber and a flood hole is drilled in the top of the other end. The root chamber is mounted on an angle with drain end below then the flood end. This is to ensure that the roots don't get water logged. Too much of an angle will cause the Rockwell and roots to dry out at the high end.

END VIEW



TOP VIEW

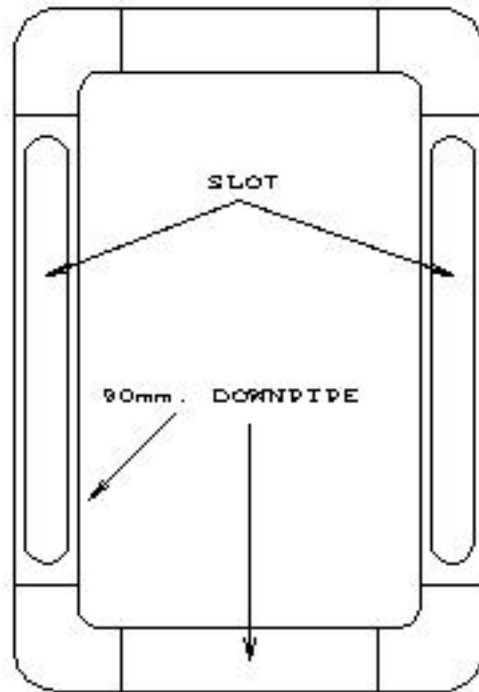

SIDE VIEW

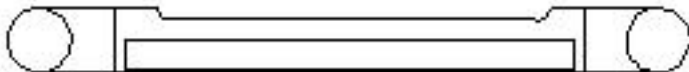

FLOOD AND DRAIN.

A flood and drain system requires a timer, a pump and a drain tank to catch the hydro juice. Hose is run from the bottom of the drain tank to the pump inlet. Hose is run from pump outlet to the hole in the top of the flood (high) end of the root chamber. The pump inlet is below the bottom the drain tank. As the drain tank is filling hydro juice flows through to the pump inlet through the pump and up the flood hose till level with the hydro juice in the tank. This is to prime the pump as the pump can't suck air, it can only push out what flows in the inlet. The timer runs the pump for 1 minute and the hydro juice fills about half the root chamber. If chamber over flows increase size of drain holes. If a hose is used at the drain end, it must not cause hydro juice to stand at the drain end. A recycling type bin is ideal for the drain tank (see end of Drip Feed section to attach hose to drain tank). Putting the pump on the floor and the drain tank on bricks should raise it enough prime the pump.

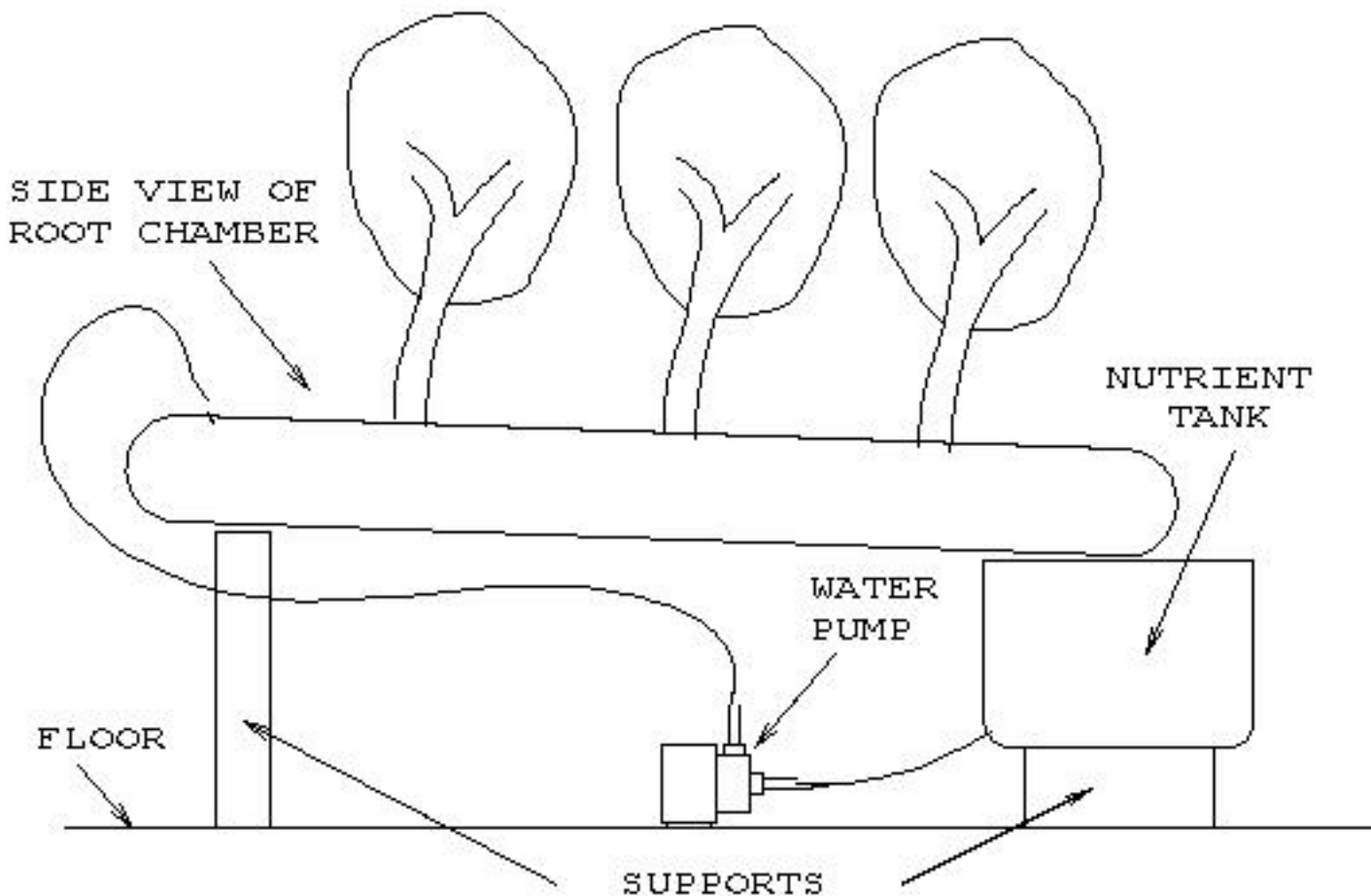

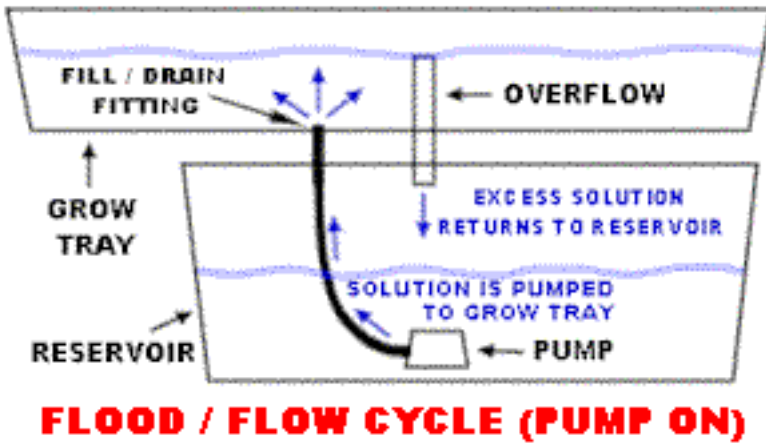

EBB AND FLOW (FLOOD AND DRAIN)

The Ebb and Flow system works by temporarily flooding the grow tray with nutrient solution and then draining the solution back into the reservoir. This action is normally done with a submerged pump that is connected to a timer.

When the timer turns the pump on nutrient solution is pumped into the grow tray. When the timer shuts the pump off the nutrient solution flows back into the reservoir. The Timer is set to come on several times a day, depending on the size and type of plants, temperature and humidity and the type of growing medium used.

The Ebb and Flow is a versatile system that can be used with a variety of growing mediums. The entire grow tray can be filled with Grow Rocks, gravel or granular Rockwool. Many people like to use individual pots filled with growing medium, this makes it easier to move plants around or even move them in or out of the system. The main disadvantage of this type of system is that with some types of growing medium (Gravel, Growrocks, Perlite), there is a vulnerability to power outages as well as pump and timer failures. The roots can dry out quickly when the watering cycles are interrupted. This problem can be relieved somewhat by using growing media that retains more water (Rockwool, Vermiculite, coconut fiber or a good soilless mix like Pro-mix or Faffard's).

Drip Feed System.

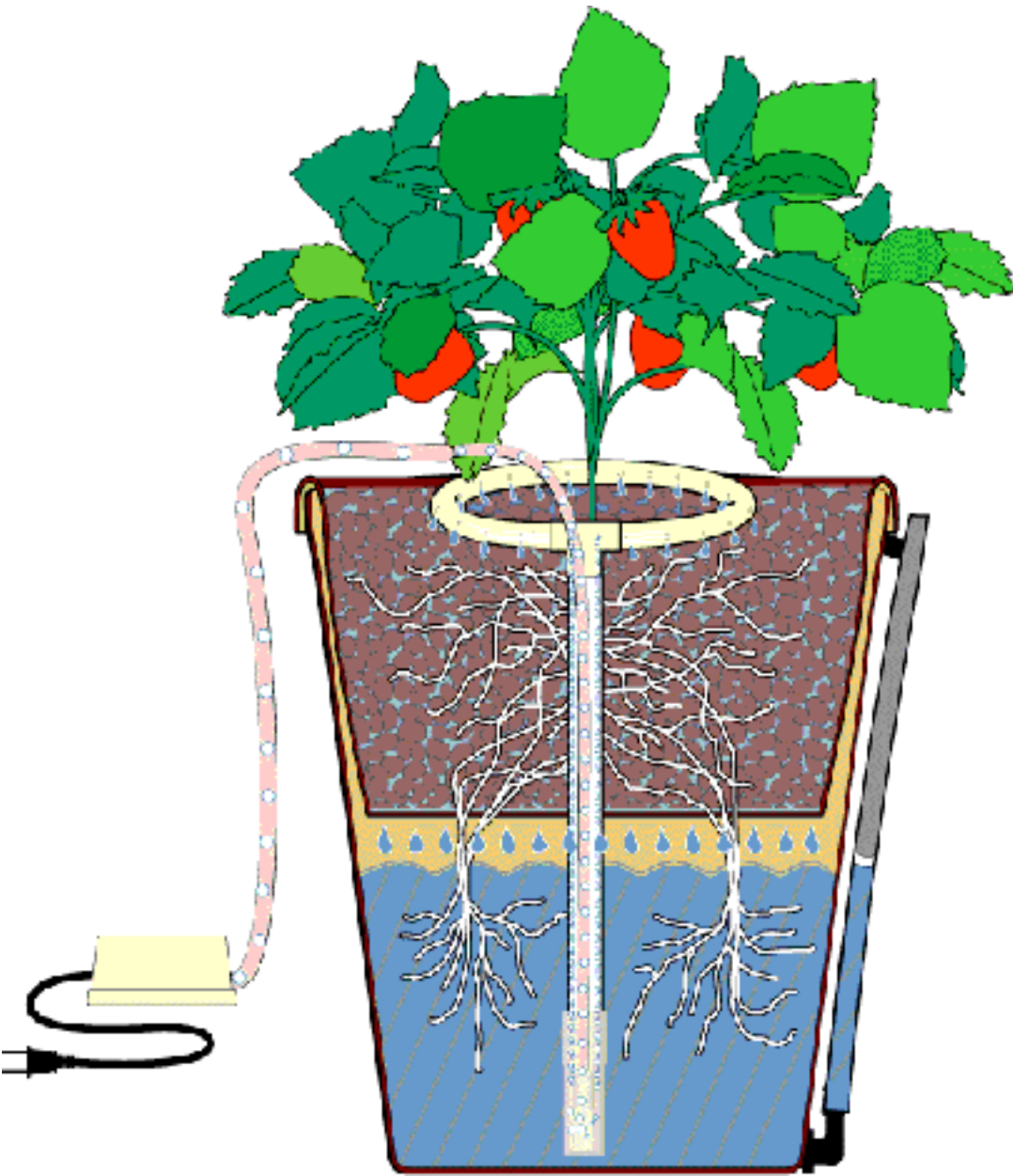

This feed system has a dripper for each plant. Dripping the hydro juice directly on the top of the root mass should stop the plant from sending out long roots in search of food. Resulting in more growth on top or so the theory goes. The drip system uses a drip feed tank about one meter above the drippers and reticulation system.

Reticulation is via 13mm. poly tube to just above the root chamber. A hole is punched in the 13mm. tube. A 4mm. adapter is screwed into the hole. Then 4mm. poly tube is attached to the 4mm. adapter. A dripper is attached to the other end of the 4mm. tube. The 4mm poly tube should be kept as short as possible so there is enough pressure to start the drippers. Barbed right angles and tee's are used to route the 13mm. poly tube close to each plant. The top of the 13 mm. poly tube is about 50mm. below the bottom of the drip feed tank. A 13mm. to snap-on

adapter is fitted to the top of the 13mm. poly tube. If the 13 mm. poly tube is positioned at right angles to the slot and the 4mm. adapter, 4 mm. poly tube and the dripper positioned over the slot. Any leakage at the joins in the poly tube will drip into the slot preventing loss of hydro juice.

A 42 liter plastic garbage bin and lid is used for the drip feed tank. Snap-on fittings and 13mm. garden hose connect the bottom of the drip feed tank to the to 13mm. poly tube. They also connect the pump outlet hose to the top of the drip feed tank. A Stop Snap-on is used where the garden hose connects to the Snap-on adapter on the 13mm. poly tube. This prevents the hydro juice flowing from when the Snap-on is removed from the 13mm. poly tube.

To convert from flood and drain to drip feed. Move the pump outlet hose from the flood inlet on top of the root chamber, to the top of the drip feed tank.

Snap-on universal sprinkler adapter are used to connect hoses to the side of the drip feed tank . These are a Snap-on to 13mm. thread adapter. There is also a 20mm. thread that screws onto a 13mm. thread. A hole no larger than the 13mm. thread is drilled in the side of the tank. The 13mm. thread is pushed through the hole from the outside of the tank. Now the 20mm. thread is screwed on to the 13mm. thread inside the tank creating a water tight seal. Make sure the hole is away from obstructions inside the tank that would prevent the 20mm. thread from attaching to the 13mm. thread. This method is used for all tanks and also for the pump outlet hose connection to the top of the flood end of the root chamber.

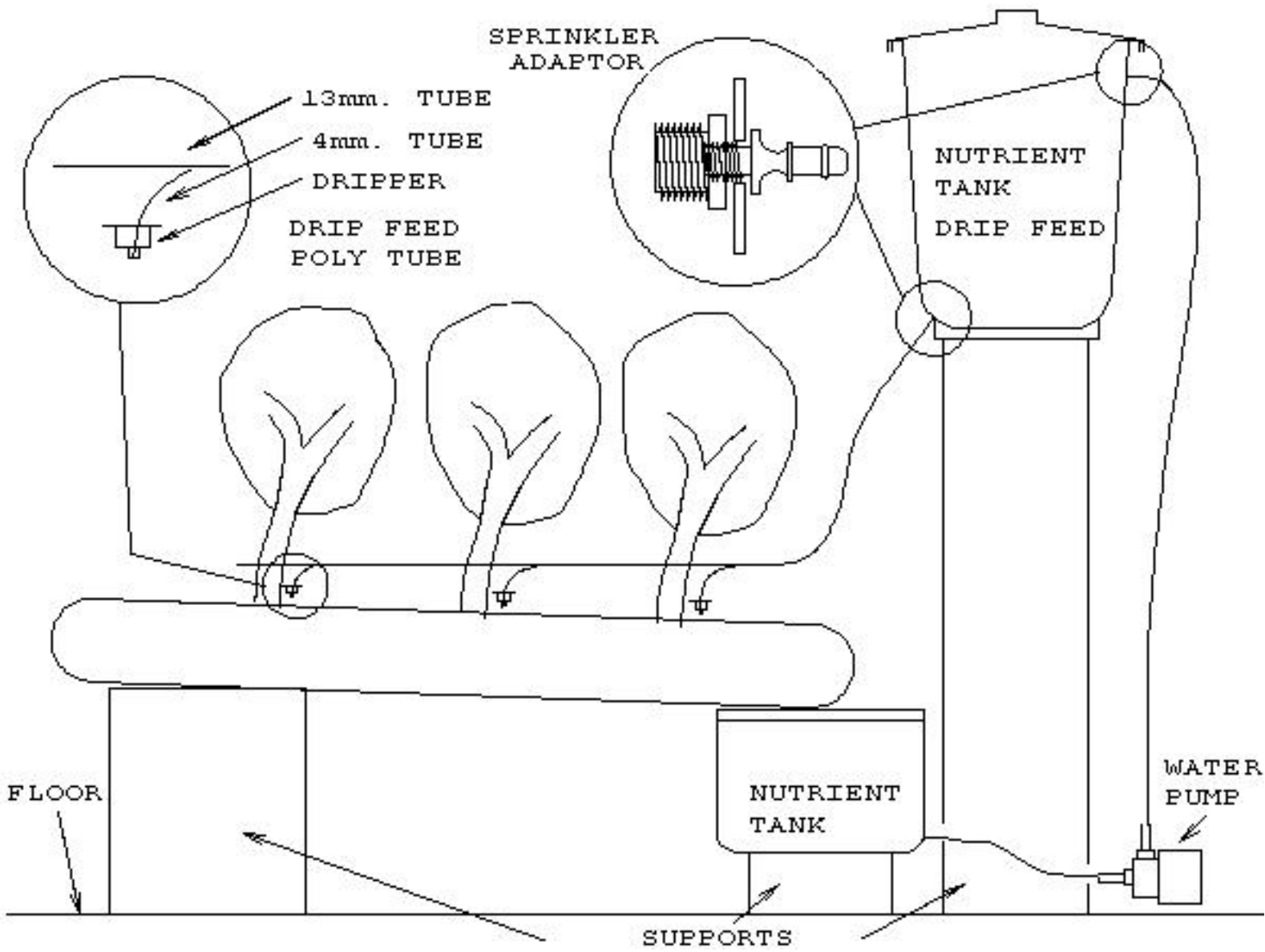

The Easiest and Cheapest Systems below.

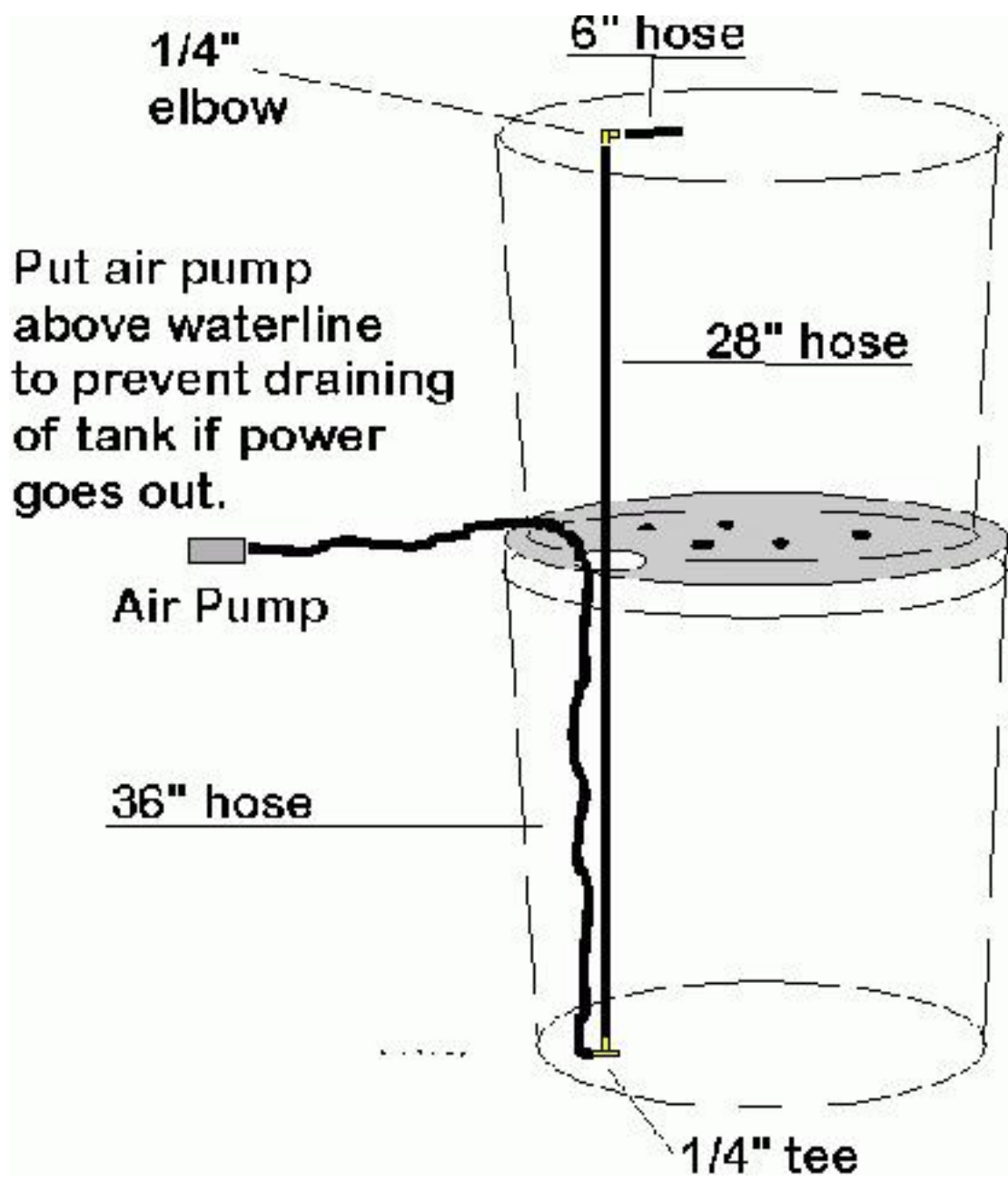

5 Gallon Bucket Drip Garden for large plants

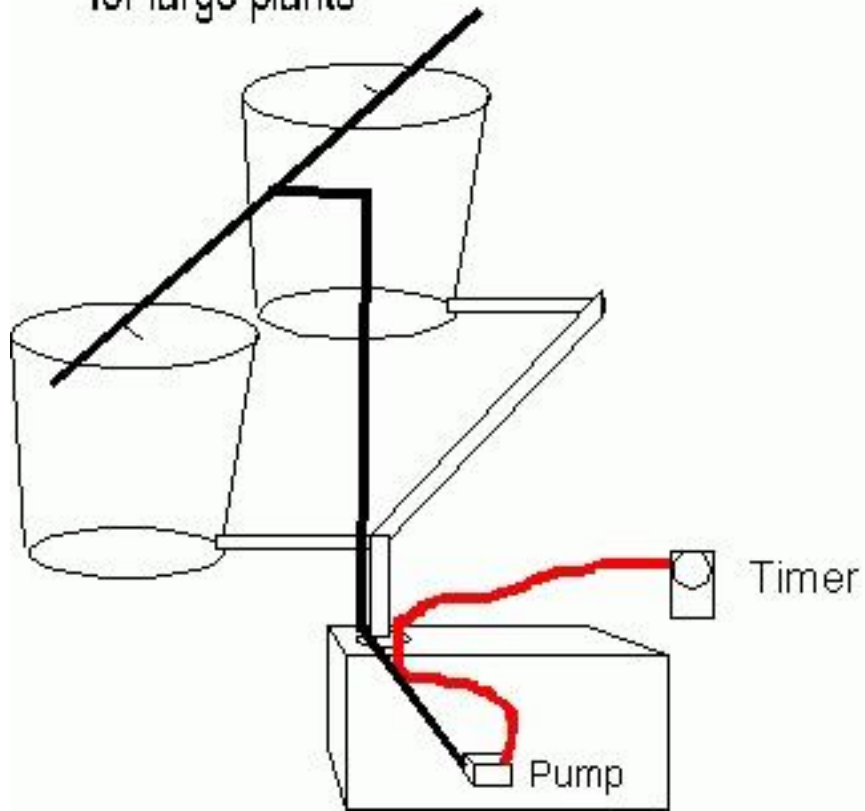

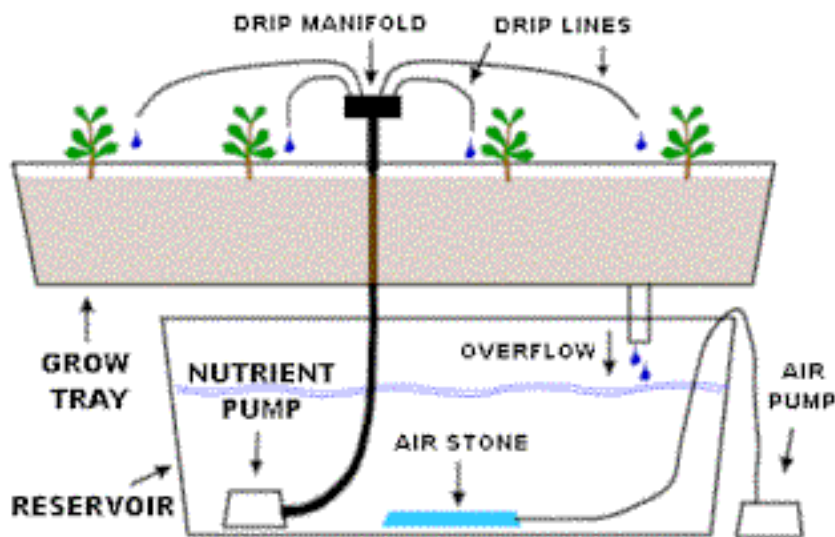

DRIP SYSTEMS

RECOVERY / NON-RECOVERY

Drip systems are probably the most widely used type of hydroponic system in the world. Operation is simple, a timer controls a submersed pump. The timer turns the pump on and nutrient solution is dripped onto the base of each plant by a small drip line. In a Recovery Drip System the excess nutrient solution that runs off is collected back in the reservoir for re-use. The Non-Recovery System does not collect the run off.

A recovery system uses nutrient solution a bit more efficiently, as excess solution is reused, this also allows for the use of a more inexpensive timer because a recovery system doesn't require precise control of the watering cycles. The non-recovery system needs to have a more precise timer so that watering cycles can be adjusted to insure that the plants get enough nutrient solution and the runoff is kept to a minimum.

The non-recovery system requires less maintenance due to the fact that the excess nutrient solution isn't recycled back into the reservoir, so the nutrient strength and pH of the reservoir will not vary. This means that you can fill the reservoir with pH adjusted nutrient solution and then forget it until you need to mix more. A recovery system can have large shifts in the pH and nutrient strength levels that require periodic checking and adjusting.

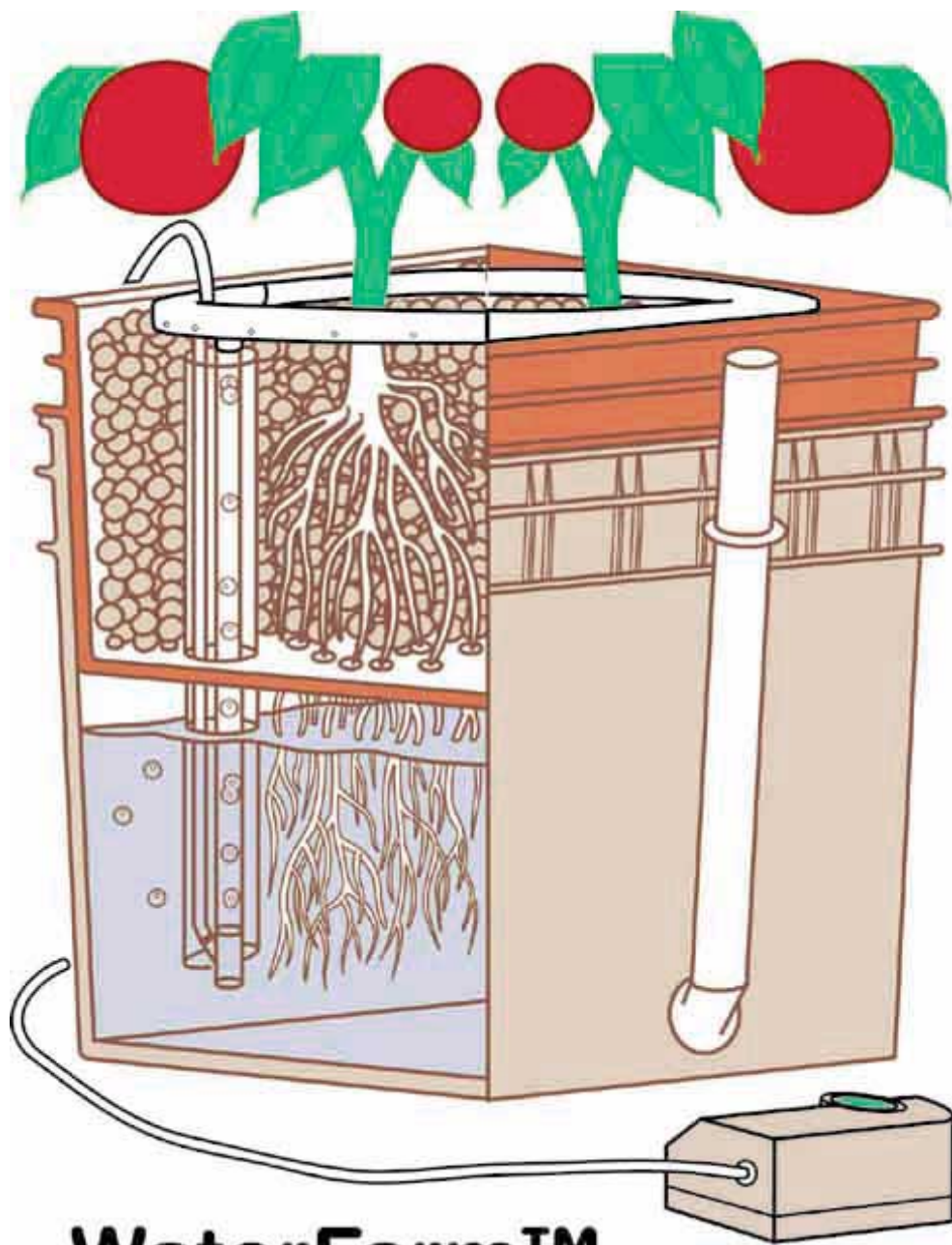

WaterFarm™

12 Plant Patio Table Garden System.



Drill the 12 holes for the bottles and two in the center for the overflow pipe. Make sure you drill between the braces under the table.



The 1/2 inch PVC pipe is hidden under the table where it isn't seen from the top.

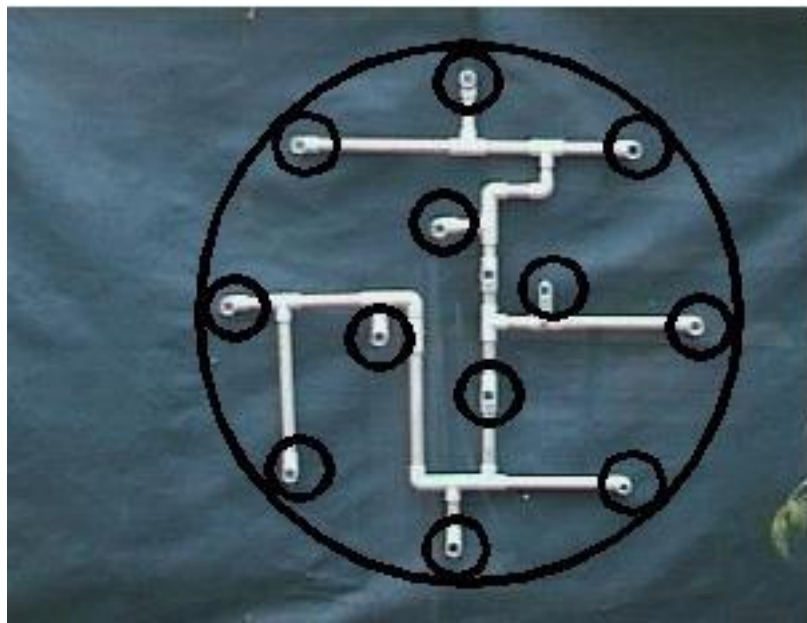

The PVC under the table doesn't have to follow a particular pattern as long as all 12 fittings for the bottles and 1 in the center for the overflow pipe point up through the holes you drilled and don't forget the intake fitting pointing down where the pump attaches.



Here is the finished top of the 12 plant patio garden. Notice the overflow pipe in the center of the table.





Information Provided from Hydroponics Online.

11 Plant Hydroponic Garden.



Most Popular.



The Finished Product.

[Step 1.](#)

[Step 2.](#)

[Step 3.](#)

[Step 4.](#)

[Step 5.](#)

[Step 6.](#)

[Step 7.](#)

[Step 8.](#)

[Step 9.](#)

Required Parts List. 11 Plant Hydroponics System.

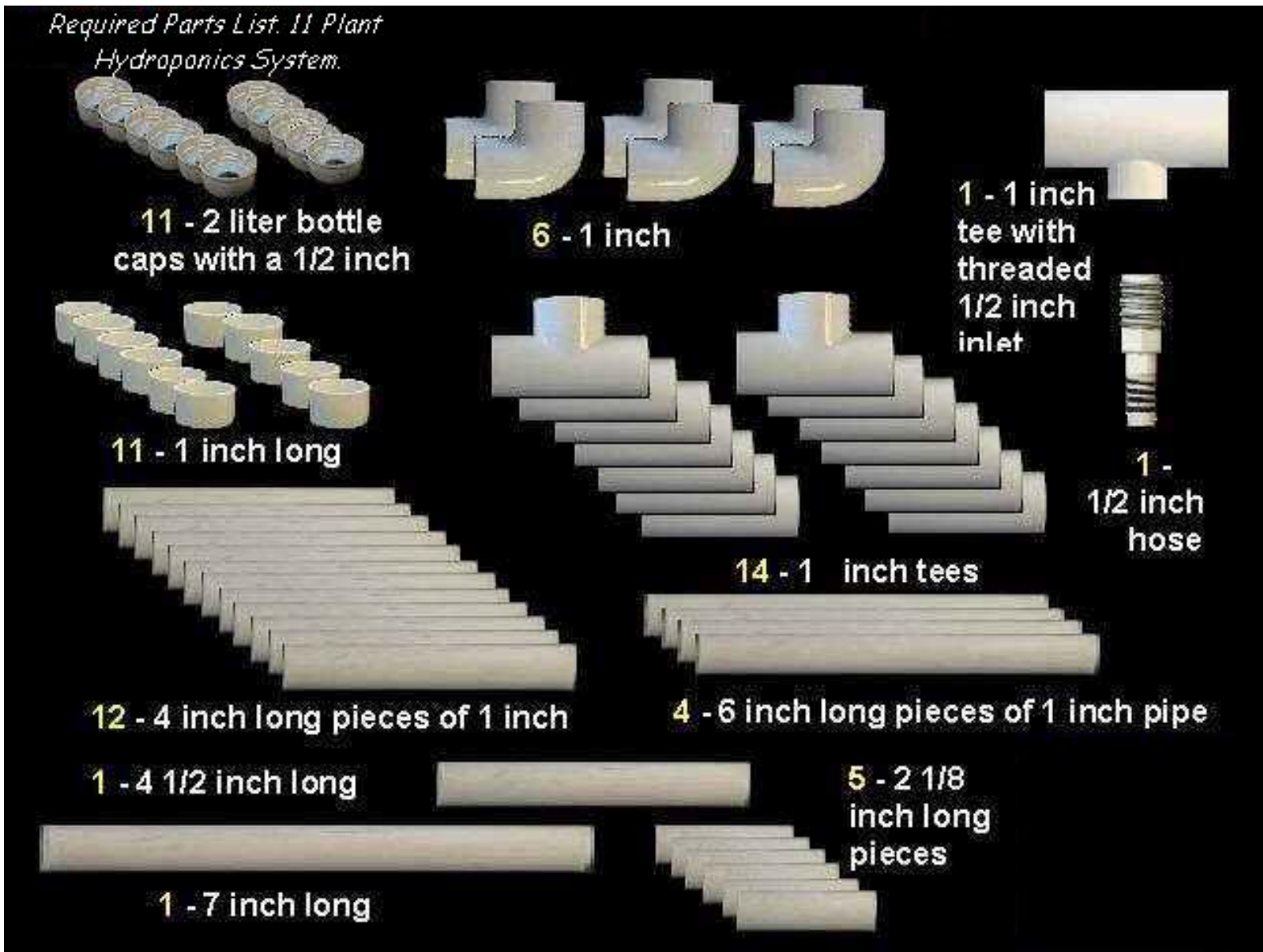

Required Parts - 11 Plant Hydroponic System.

11 Plant Garden Parts List

14 - 1" PVC Tees

6 - 1" PVC Corners

1 - 1" PVC Tee w 1/2" threaded Inlet

1 - 1/2" Hose Connector

1 - 10 ft. piece of 1" PVC SLD 26 (thinwall) pipe cut

1 - 7" long

4 - 6" long

1 - 4 1/2" long

12 - 4" long

5 - 2 1/8" long

11 - 1" long

11 - 2 liter bottle caps with a 1/2" hole drilled through them.

11 - 2 liter bottles cut in half.

Detailed Parts List.

Information received from Pipe Dreams Hydroponics.

Step 1.

Glue 6 pieces of 4 inch pipe to:

3 tees lying flat



**with 2 tees and
2 corners facing up**

Step 2.



**Make 2 of these exactly the same
One will be the right side and one
the left side of your 11 plant
garden.**



Step 3.

**Glue four
6 inch pieces
of pipe in 2 of
the tees**

**Make sure
all three
pieces are
the same
length**



**Glue the 2 1/8
pieces of pipe
in 2 tees facing
up**

**And the
threaded tee
lying flat**

**1/2 inch
threaded
1 inch tee**

Step 4.

Glue the two sides of the garden with the three middle sections

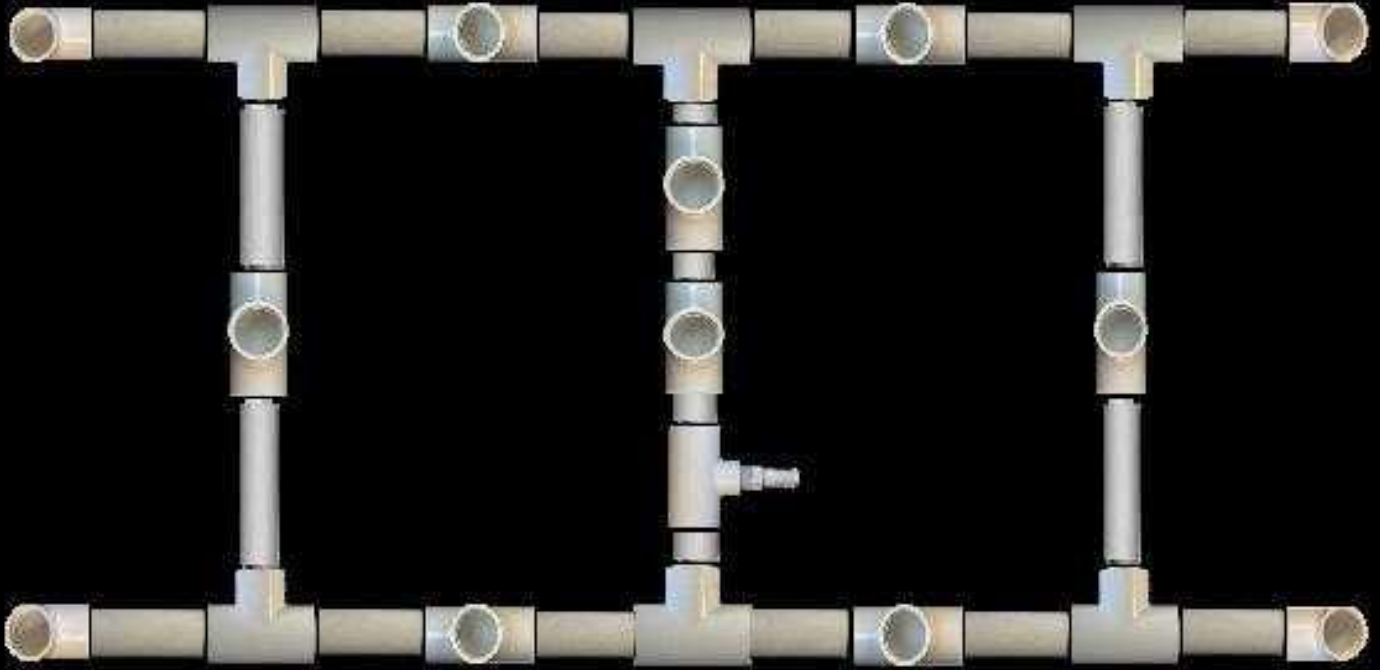

Step 5.



Then glue the 2 liter bottle caps with a 1/2 inch hole drilled in them into the inserts.



Glue 1 inch thin wall PVC (SDR.26) inserts cut 1 inch long



into 7 of the 1 inch tees and the 4 corners of the garden

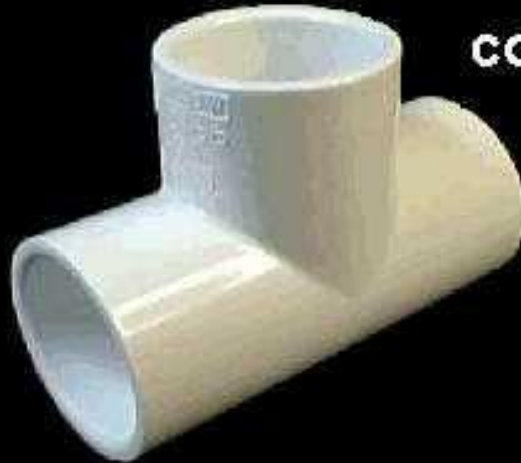

Step 6.



Glue 11 of the 1 inch thin wall PVC inserts and 11 of the bottle caps into seven of the 1 inch tees and four of the 1 inch corners as shown in the next slide.

Step 7.



Glue the 1 inch inserts and the bottle cap with the hole in 7 of the 1" Tees and in the 4 corners as shown

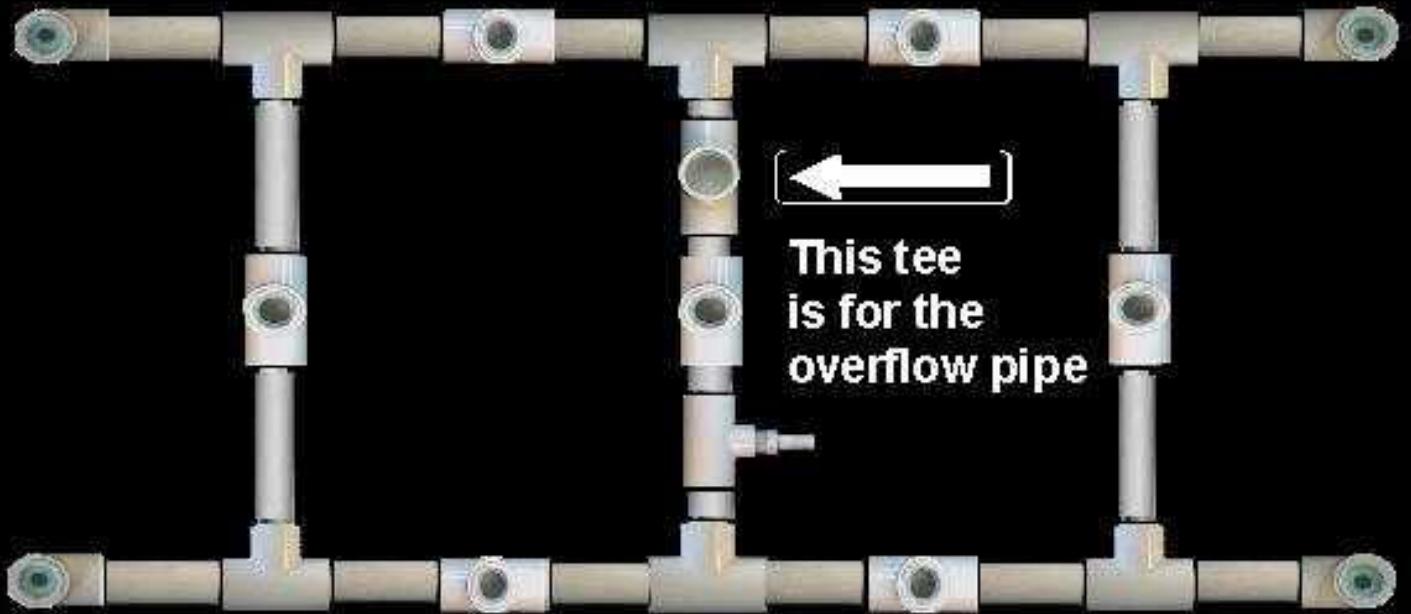

Step 8.

Over Flow Pipe

Glue two of the 1 inch corners to one of the short 2 1/4" pieces of pipe

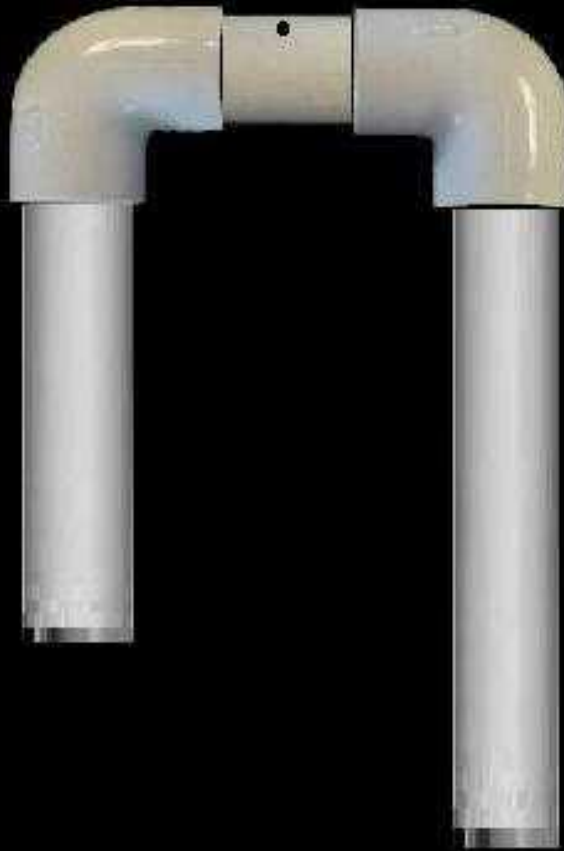

Next glue the 5" pipe into one side

and the 7" pipe into the other side

Step 9.

The pump comes on and fills the bottles to the height that the over flow pipe is cut to.

Don't forget to drill a small hole in the top of the over flow pipe to prevent the siphoning effect

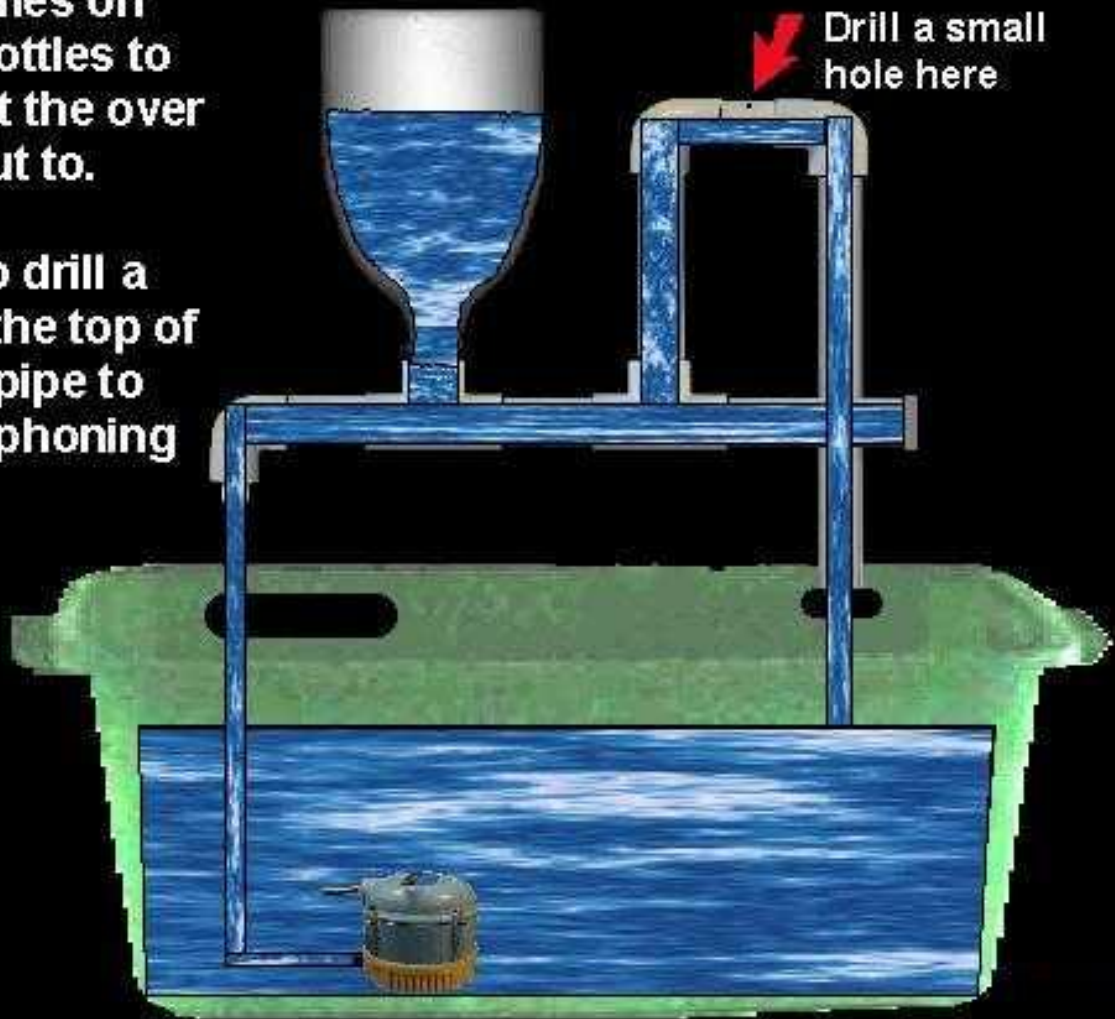

Expandable 9 plant garden.

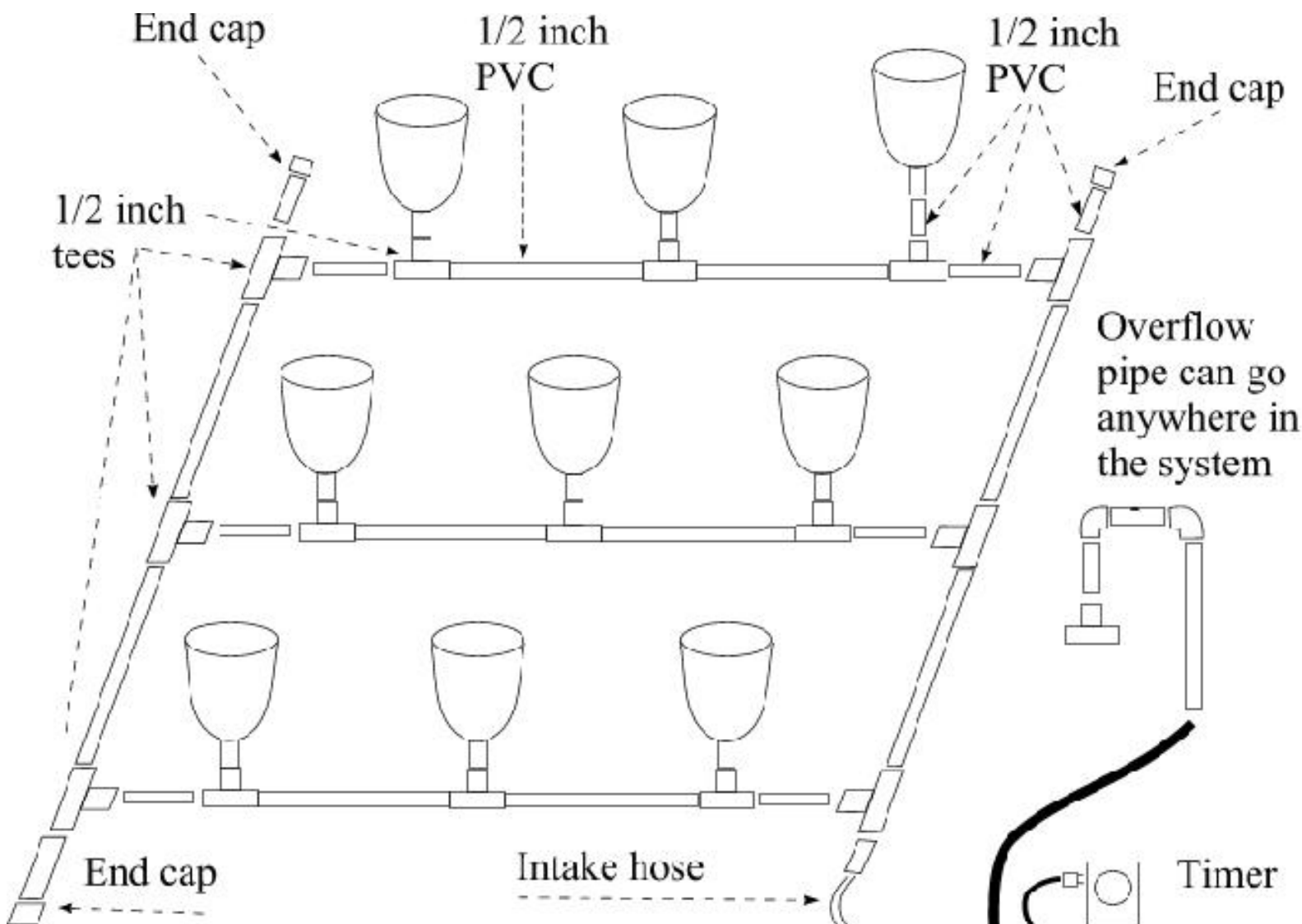

The garden can be made larger by adding more rows.

The distance between the cups is determined by what you want to grow.

Don't glue the end caps so you can add more units.

If you use a cycle timer then you don't need the overflow pipe just add more one minute pins until you get the right water level.

The pump shuts off and the water drains back through the pump to start the

The pump shuts off and the water drains back through the pump to start the cycle again about every 20 minutes.

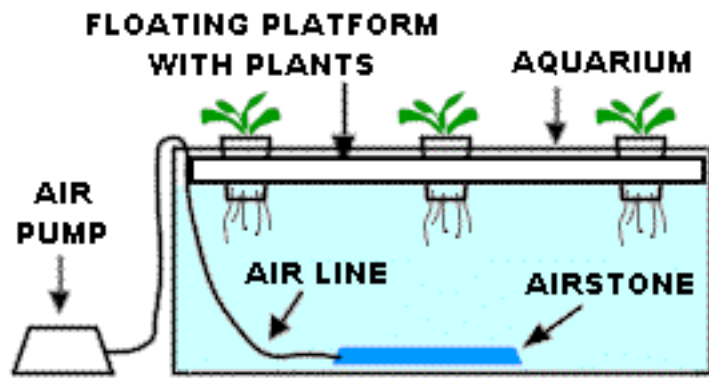

WATER CULTURE SYSTEM

Convert an aquarium into a simple hydroponic system. The plants are suspended on a floating Styrofoam platform. This system is popular for classrooms because the roots of the plants are visible hanging below the floating platform.

Materials Required:

AQUARIUM - Any water tight container with fairly vertical sides will work. Light breaks down the nutrient solution and encourages algae growth so if you use an aquarium you will need to construct a light shield out of cardboard or aluminum foil to keep light out of the reservoir (aquarium). If you wish to view the roots make the light shield (or part of it) removable.

FLOATING PLATFORM - You will need a piece of Styrofoam 1 1/2" to 2" thick. Cut Styrofoam to fit loosely inside the aquarium (or whatever you are using for a reservoir).

PLASTIC CUPS - Use several small plastic or Styrofoam cups to hold the plants on the floating platform. (NOTE: We usually use Solo brand 3oz. plastic bathroom cups, but you can use any small plastic cup as long as it has tapered sides).

GROWING MEDIUM - You will need a small amount of growing medium, enough to fill the plastic cups. (NOTE: The Professor recommends using Perlite or a perlite / Vermiculite mix for the growing medium).

AIR PUMP AND AIR STONE - You need to use an air pump and airstone to oxygenate the nutrient solution. A regular air pump designed for an aquarium is all that is required.

HYDROPONIC FERTILIZER * - A good quality hydroponic fertilizer is required, regular "dirt" fertilizers do not contain essential "micro-nutrients".

pH TEST KIT * - You will need some way of checking and adjusting the pH of your nutrient solution.

ASSEMBLY OF SYSTEM:

1. Cut the Styrofoam float to fit the reservoir. Cut the float a little smaller than the opening so that it won't bind up when the water level changes.

2. Cut the holes in the float to the proper size for the plastic cups that you are using, you want the bottoms of the cups to hang below the bottom of the float but not fall through. (NOTE: We usually use Solo brand 3oz. plastic bathroom cups, these require a 1 7/8" to 2" hole.
3. Cut several holes (aprox. 1/8" to 1/4" dia.) in the bottom of your plastic cups. Add growing medium to the cup (NOTE: if the growing medium falls out through the holes you can put a small piece of fiberglass window screen or small piece of cloth over the holes before adding the growing medium.
4. Plant your seedling, rooted cutting or seed in the growing medium.

CARE AND FEEDING INSTRUCTIONS

5. Fill the aquarium (reservoir) with water. Mix your nutrient solution as per the instructions on the fertilizer package. Check pH and adjust accordingly. NOTE: The required pH value will vary depending on the requirements of the plant.
6. Attach 1/4" airline to the air stone and place airstone in reservoir. Attach free end of tubing to air pump and plug in air pump to outlet, make sure that there are bubbles coming from the air stone. (NOTE: NEVER submerge the air pump in water as electrical shock could occur).
7. Place floating platform on top of the nutrient solution. Put plastic cups into the holes in the floating platform.
8. When the plants have used up about half of the nutrient solution you can add **WATER ONLY** to bring the level back up (do not add fertilizer or you could cause a nutrient build up that could harm the plants). Recheck pH and adjust if necessary.
9. When the plants have used half of the nutrient solution for the second time you need to change out the nutrient solution by draining the reservoir and then mix a fresh batch. Use the old nutrient solution on house plants or other vegetation.

Information Provided by Simple Hydroponics.



What You'll Need

- Air pump
- Timer
- Plastic tubing
- 2-liter bottle
- Straight through connectors
- T connector
- Bleed valve
- Ice cube holding bin
- Medium
- Waterproof glue or silicon caulk
- Drill

Windowsill Wonder.

Anyone can build a simple, automated hydroponic system without spending a lot of money. This system is compact enough to fit on a kitchen windowsill--although it can easily be expanded to accommodate any growing plant collection. All the materials that are needed for this system can be found at discount superstores, aquarium supply stores, or hardware stores for under \$25.

We used a 2-liter bottle for the nutrient reservoir and an ice cube holding bin for the plant trough. Once you comprehend the logistics, feel free to experiment with other containers. To prepare your nutrient reservoir, drill two holes in the cap of the 2-liter bottle. The holes should be just big enough to snugly hold the 1/4-inch straight through connectors. One hole will be for the water line and the other will be for the air line. Drill a hole in the side of the trough (the ice cube holding bin) as close to the bottom as possible. If you plan on expanding your system, drill another hole on the opposite side. Insert the straight through connectors in the drilled holes. Create a quality seal around the connectors with glue or silicon caulk.

Create your water distribution hose by drilling several small holes in a piece of irrigation tubing cut to fit the bottom of the trough. Connect one end of the tube to one of the fittings on the inside of the trough. The other end of the tube can be sealed with a dab of glue or caulk. If you plan on expanding your system, don't seal the other end. Instead, connect it to the other fitting on the opposite side of the trough. Connect the water line from the nutrient reservoir to the trough. Cut another piece of water line to about the same length as your nutrient reservoir. Then connect this line to the other side of the water line connector, on the inside of the bottle cap. The line should hang down to the bottom of the 2-liter bottle when the cap is on.

Run the air line from the air pump to the other straight through connector on the cap of the bottle. At some point in the air line, splice the line to put in the T connector. Off the T, connect the aquarium air line bleed valve.

Fill your 2-liter bottle with water until it's about three-quarters full. Reconnect it to your trough and place the trough where it will be situated. Turn on the air pump and close the air valve. The water will be pushed into the trough. Gradually ease open the valve until the water is moving into the trough very slowly. It's okay if it takes up to a half-hour for the air pump to push all the water out of the bottle. The goal here is to have the valve closed enough to allow adequate pressure to build inside the bottle to push the water out, but open enough to allow air to escape when the pump is off, so the water can flow back into the bottle.

Now you're ready to add the medium and plants. We found that expanded clay or lava rock works well. Any number of plants will work in this system. Succulent herbs, such as basil and mint, are particularly easy to grow.

If you want to expand your system, simply build another trough and attach the incoming water line of the new trough to the end of the previous trough. We found that up to two modules of this size could be powered from the same pump and nutrient bottle.

Flooding and draining the system once a day should be adequate. But if you're growing a large plant in a sunny location, you may have to set the system to flood and drain twice a day.

The "Aquafarm"

This system was developed and popularized by General Hydroponics nearly twenty years ago as their first product. The original design, which is still in production, is known as the "Aquafarm". In recent years it has seen new embodiments named the "Watergarden" (a decorative version), the "Powergrower" (a revised version of the watergarden), the "Waterfarm" (a square version), and the "Megafarm" (a 20 gallon version). A similar bucket based system is also being sold by another company under the name of the "Universal Garden". These units are extremely reliable, easy to operate and are very simple to construct. All of these systems retail in the 50 dollar per unit range. This document will show you how to build this type of system for very low cost.

This system will accommodate several small plants or (as best suited for) hold one large plant. I personally have seen a 12 foot tall tree being grown in an aquafarm, as well as a very large banana tree, both indoors. The plants are grown in a chamber suspended above a reservoir (basically a bucket within a bucket) that holds the nutrient solution. A small aquarium pump powers a simple pumping mechanism which delivers nutrients from the reservoir up to the top of the growth chamber, where it trickles back down through the root zone and into the reservoir. This system is so effective it is not uncommon for tomato plants to grow over 4 inches per day! This system gives huge yields! I HIGHLY recommend this unit for the first time hydroponic grower.

Parts List to make one "Aquafarm"

Item	Cost	Notes
1 ea. 5 gallon bucket	\$4.00	Get this at just about any hardware store or scrounge it - they are everywhere. Make sure you use a "standard" pail. See the detail drawings .
1 ea 3.5 gallon bucket	\$4.00-6.00	This is the most difficult part to find. This bucket is the same diameter as the 5 gallon size but several inches shorter. The criteria for this bucket is that it nests inside the 5 gallon bucket. See detail drawings.
1 ea. ½" rubber grommet	\$0.69	You'll find this item in the electrical supply part of your hardware store. The ½" measurement refers to the inside diameter of the rubber grommet. See the detail drawings.
1 ea. 14" long piece of schedule 125 or 200 ½" dia. PVC pipe	\$0.60 per ten feet	You'll find this near the sprinkler supply stuff in the plumbing section of the hardware store.

<p>1 ea. 14" long white polyethylene tubing.</p> <p>3/8" Outside diameter, 1/4" Inside diameter</p>	<p>\$0.10 per foot</p>	<p>Once again, you'll find this in the plumbing section of your hardware store. The white polyethylene tubing is not a must, but it works the best (I have used 3/8" O.D. clear aquarium tubing). What is most important is the outside diameter, it must be small enough to fit inside the "tee". Secondly an inside diameter of 1/4" makes the pump perform best. The pump I made with the aquarium tubing (which had a larger inside diameter) did not perform as well.</p>
<p>1 ea. 15" long, 5/16" outside diameter vinyl tubing</p>	<p>\$0.10 - \$0.20 per foot</p>	<p>Plumbing section, right next to the poly tubing. Once again, you just have to get close. The important qualities of this part are first, the outside diameter of the tubing and secondly flexibility. 5/16" tubing makes a nice snug fit into the "tee", unfortunately this size tubing is not common. You can use 3/8" O.D. tubing and wrap it with tape to make a tight fit into the "tee". The tubing must be flexible enough to be bent into a ring without kinking.</p>
<p>1 ea. 1/2" Raindrip barbed "tee"</p>	<p>\$0.55</p>	<p>Raindrip is a popular brand of drip irrigation product. You should be able to find this in the sprinkler section of you local hardware store. If you cannot find this part you can order it from one of the suppliers that I have listed. Also you may study the detail drawing that I have provided and make a substitution.</p>
<p>1 ea. 1/2" Raindrip barbed elbow</p>	<p>\$0.55</p>	<p>Same thing as above, but an elbow.</p>
<p>1 ea. 10" long 1/2" I.D. tubing</p>	<p>\$0.40 per foot</p>	<p>You'll need to find a transparent tubing as this is used to indicate the level of solution in the reservoir.</p>
<p>1 ea. 16" long 3/16" O.D. aquarium air tubing</p>	<p>\$0.80 per 3 feet</p>	<p>You'll find this at the pet store, one three foot length will make two pump columns.</p>
<p>1 length of 3/16" I.D. aquarium pump tubing</p>	<p>\$0.20 per foot</p>	<p>Pet store</p>

1 small aquarium pump	\$3.00 to \$40.00	You can use any size aquarium pump. I have successfully used the smallest \$3.00 cheapo pump. Although, I do recommend buying a pump a few notches up from bottom of the line. The small pumps provide enough air to run the system but they only last for about a year and they usually start humming after a few months. Another benefit to buying a larger air pump - the increased output is enough to run more that one Aquafarm. I have powered up to six aquafarms on one "mega" 30 dollar aquarium pump.
-----------------------	-------------------	--

Assembly Instructions

1. Remove the handles from the buckets.

2. Drill drainage holes in the bottom of the 3.5 gallon bucket. The size of the drainage holes is not critical, just keep them small enough to keep your growing medium from falling into the nutrient reservoir. I usually drill holes somewhere around 5/32" in diameter. Also, be sure to drill enough holes for adequate drainage. I usually drill about 30 to 40 holes in a pattern similar to the one pictured to the right.

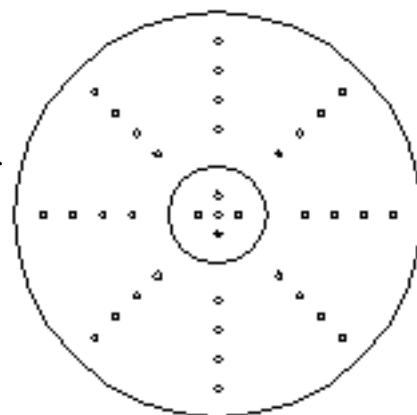

Bottom View of 3.5 gallon bucket.

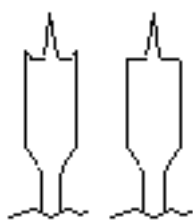

A B

3. Drill the pump column hole in the bottom of the 3.5 gallon bucket. Use a 13/16" diameter spade drill bit to do this. Drill this hole approximately two inches away from the outer edge of the bucket. Refer to the

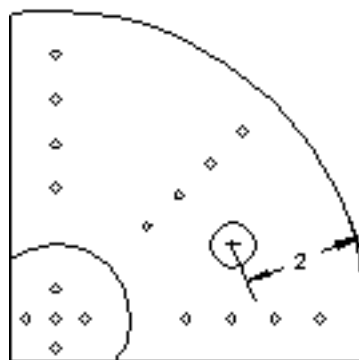

drawing at right for placement.

Pictured at left you will see a diagram of the two

types of spade bit available. Bit "A" has pointed outer teeth where bit "B" does not. I have found that type "A" works far better for drilling holes in plastic pails. The two outer teeth cut through the thickness of the pail before the main cutter engages. This makes for an easy cut resulting in a perfectly circular hole with no irregularities. Finally, when drilling the hole proceed with light pressure and, if you have a variable speed drill, a slow drill speed. Be ready to stop the drill as you break through the bucket, if you continue to drill after you have pierced the bucket, the bit will rattle in the hole and "hog" it out into a larger, triangular shaped hole. A perfect hole in the 5 gallon bucket is necessary for the grommet to seal

properly, so it pays to practice here where it really doesn't count.

4. Drill the grommet hole in the side of the five gallon bucket. Drill this hole on the side of the bucket as close to the bottom as possible. Be careful not to pierce the bottom web of the bucket. Unfortunately I can't give you the exact size of the hole to drill because there are several types of rubber grommets which vary slightly in size. You will need to measure your grommet and determine what size hole to drill (this should be in the ballpark of 3/4" or 13/16"). I suggest that you drill a test hole in something other than your bucket and check the fit of the grommet. The diagram at right shows the 5 gallon bucket with the hole drilled, the rubber grommet fitted and the elbow pressed into place.

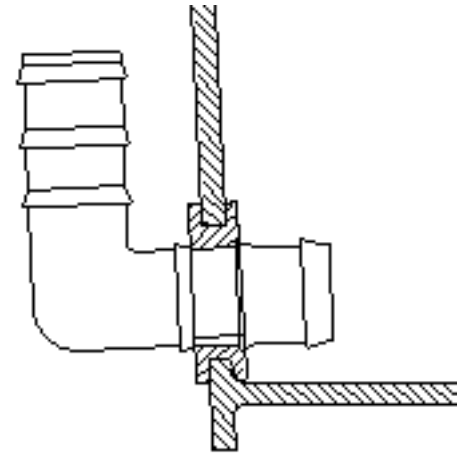

5. Insert the rubber grommet into the 5 gallon bucket. It is important that the grommet forms a water tight seal with the bucket, so you may have to remove any burrs left from the drilling process with a utility knife.

6. Insert the elbow into the rubber grommet. When you press the elbow into the grommet hold your hand on the grommets' back side to keep it from pushing through into the bucket. Insert the elbow about half way into the grommet so that it still has room to swivel. When you're done with this step you should have something that looks like the drawing above.

7. Attach the 10" long, 1/2" I.D. tube to the elbow. Attach this tubing to the part of the elbow on the outside of the bucket. This tubing will serve to indicate the level of nutrient in the Aquafarm. When it's time to change the solution it also acts as a drain, you simply swivel it down and let the solution drain out!

8. Insert the 3.5 gallon bucket into the 5 gallon bucket. At this point you have completed the body of the Aquafarm and you should have something that looks like the drawing at right.

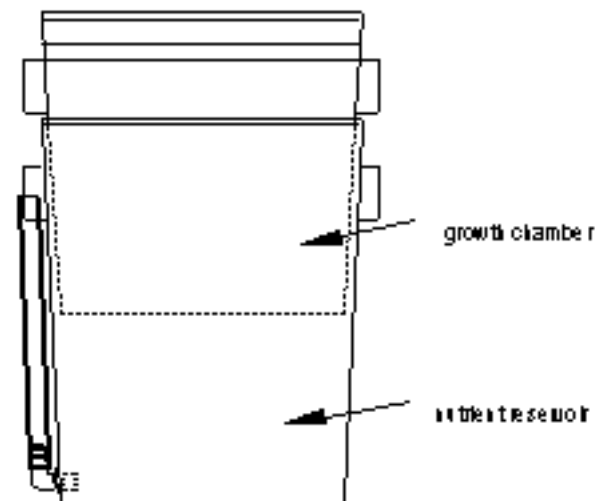

9. Cut the pump column support tube. Following the diagram at right, cut the 1/2" pvc pipe to 14" in length measuring from the tip of the bevel. Make the cut at

approximately 45 degrees.

10. Insert the pump column support tube (from previous step) into its hole (from step 3) in the bottom of the 3.5 gallon bucket. Insert it beveled end first and push it all the way in, until it bottoms out in the nutrient reservoir.

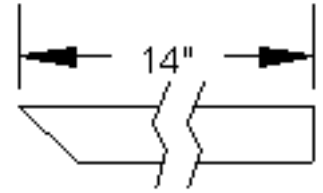

11. Cut the tee as shown. A small hacksaw works best. Discard the two small pieces.



12. Cut and drill the drip ring. Cut the 5/16" O.D. tubing to 15 inches long and drill seven 1/8" diameter holes equally spaced along its length (refer to the diagrams below).

13. Insert the drip ring into the "tee". Press the ends of the tubing into the cut ends of the "tee". Make sure the holes in the tubing point towards the stem of the "tee". Set this aside for later.

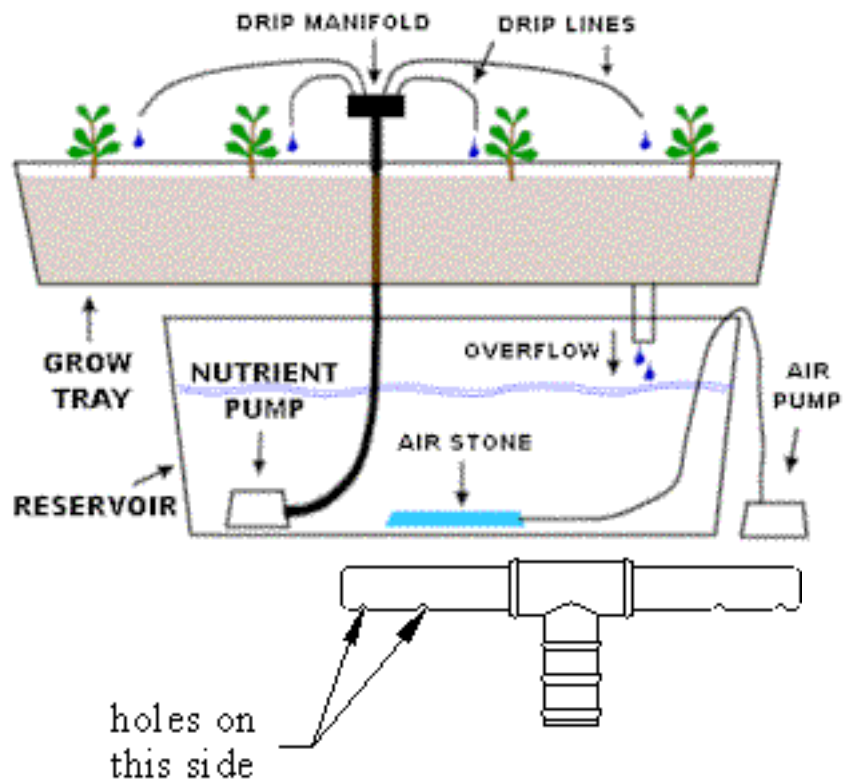

14. Heat the 3/16" aquarium tubing. Heat the tubing about 1" from the end until it is soft enough to bend. Rotate it just over the tip of a flame so it is evenly heated, just a few seconds will do the trick.

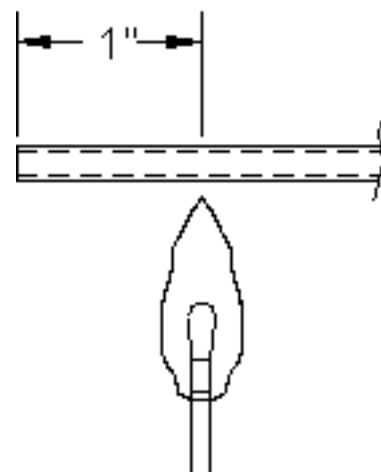

15. Bend the tubing. Make the bend to just a little less than 45 degrees. It is important that you do not kink the tubing as air must flow through it.

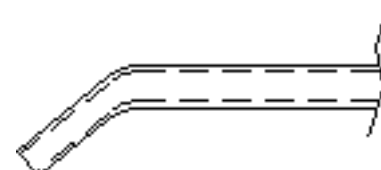

16. Trim the tubing. Bevel the end of the tubing as shown. The length of the bent portion of the tubing should be about 1/4" long.

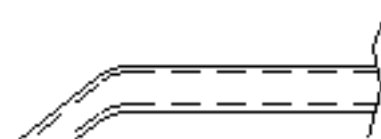

17. Drill the hole in the 3/8" O.D. pump column tube. Drill a 3/16" diameter hole in the side of the pump column tube, approximately 1 inch from the end.

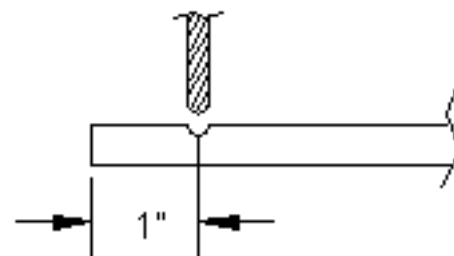

18. Assemble the pump column. Insert the bent end of the 3/16" aquarium tubing into the hole in the pump column tube. Seal the joint with a non water soluble glue. Hot glue is wonderful, but something like epoxy works too. Spot glue the aquarium tube to the pump column tube in several places too.

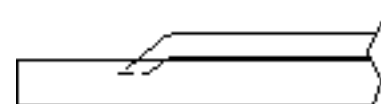

19. Attach the pump column to the drip ring. Slip the drip ring over the pump column, don't glue it. Voila! You've completed the pump column!

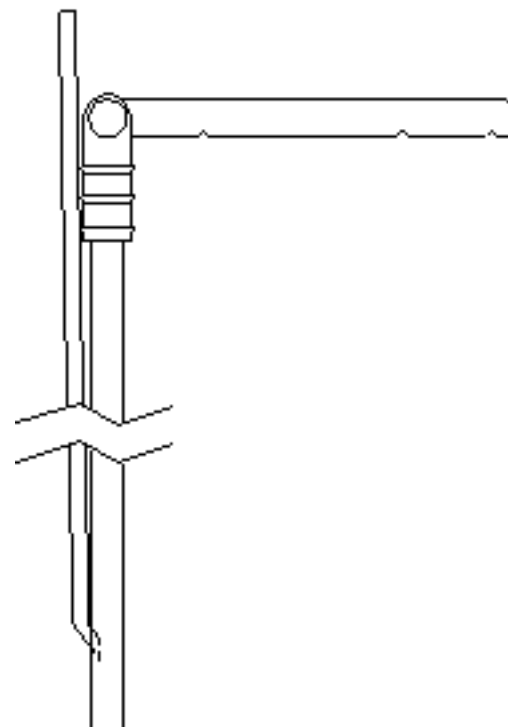

20. Final step. Insert the pump column assembly into the pvc support tube. You should now have something like the drawing below. Congratulations on completing your first "aquafarm".

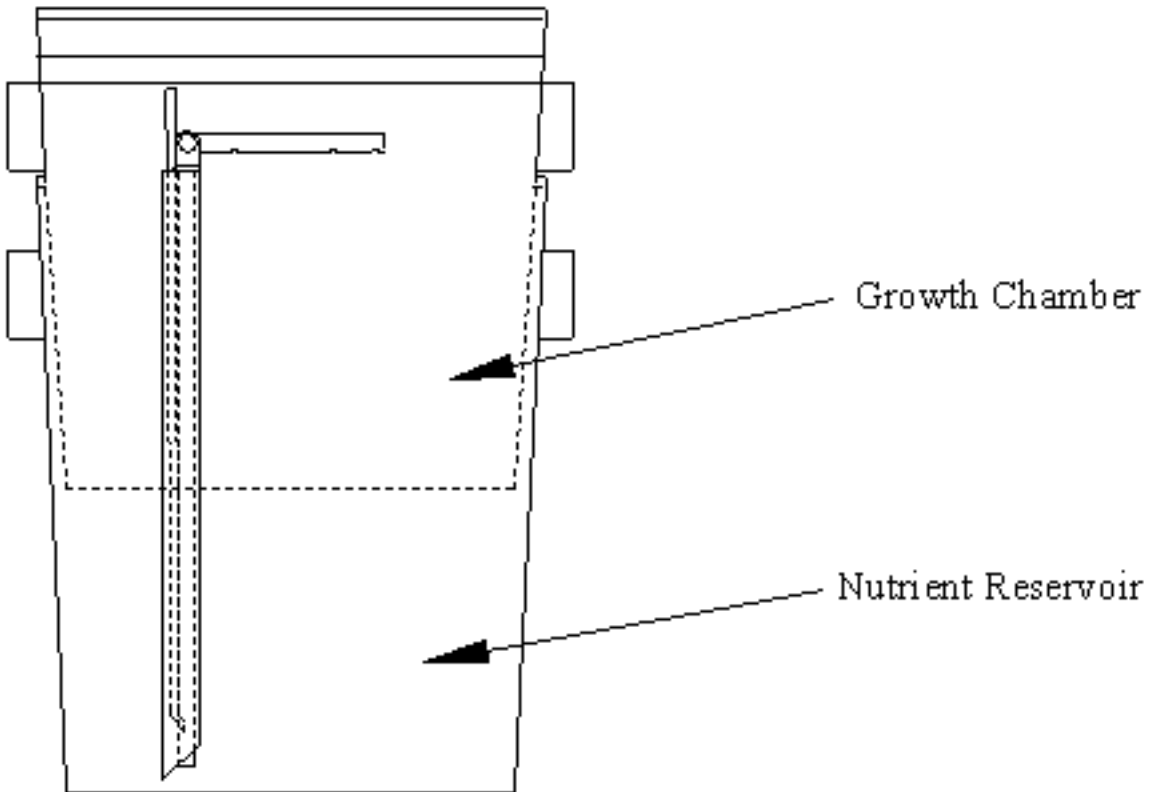

**How
to
use**

your hydroponic unit.

**Now comes the fun part!
Growing**

First you need to select a growing medium. There are a whole host of different mediums that have been used over time. They include rockwool, sawdust, peat, perlite, vermiculite, sand, gravel, and various inert mixtures. You could probably use most of these mediums successfully in this system but let me boil it down to two choices for you - perlite and expanded clay pellets (baysour, grow rocks, geolite). Perlite is great because it's dirt cheap, about 10 dollars for 4 cubic feet. That will fill over nine systems! Once your crop is done you can just throw it away and start with fresh perlite. You don't have to worry about cleaning and sterilizing your medium. The clay pellets perform well too, they are THE choice for commercial hydroponic farmers in Holland (the land of hydroponics and greenhouses). They last quite a long time and they are guaranteed to not affect your nutrient balance. The drawback to using the expanded clay is that it is expensive. They run 10 dollars for 3.5 gallons - that's nine times more expensive! Since you'll not be discarding the clay pellets I recommend using them for long term crops.

Now that you have your medium in hand, along with your plants and your newly made "Aquafarm", we're ready to have fun. First off, the reason that we didn't glue the drip ring onto the pump column is so we could take it off and get it out of our way when we fill the growing chamber with medium and plants! So.....pop that sucker off now! Next, fill the growing chamber with your medium. Make sure not to fill it any higher than the level of the drip ring. You may adjust the level of the pump column and drip ring by moving the pvc support tube up and down (ahaaaa!!....that's why it fit so tightly in the hole) as necessary. If you are using perlite I suggest they you pre-wet it with plain old water. Give it a pretty good soaking with a hose and let the excess water drain off (be sure to dump the excess water out of the nutrient reservoir).

If you are transplanting from soil, gently wash as much of the soil out of the root ball as possible. It is not necessary to remove all of the soil, just as much as possible without mauling the root system. If you have started your plants in rockwool cubes, vegetable plugs or peat pellets just plant the whole thing. Next, find that drip ring and hold in its place for a second. Use the exact science of guessing and get an idea of where the center of the ring is in relation to the bucket. Put the drip ring down and dig a hole wherever you determined the center to be. Gently place your plant into the hole, evenly distributing its roots. Backfill the hole. Find that drip ring again. Unplug one end of the ring from the tee. Put the ring back onto the pump column, wrap the ring around the stem of the plant, and plug it back into the tee. Finally, fill the reservoir with 2.5 gallons of nutrient solution. Just slowly pour it right into the growing chamber. Connect the aquarium pump to the 3/16" tube on the pump column and plug the pump in. The column should immediately start pumping nutrient up out of the reservoir and drip it around the base of the plant. It is best that you use a simple light timer to turn the pump on during daylight hours and off during the night time.

Happy Hydroponic Gardening!

A note about nutrients.....

I strongly recommend the use of the General Hydroponics line of nutrients. GH is considered to be the best nutrient manufacturer by the hydroponic community. So good that the USDA, the EPA and NASA uses them. They make four different lines of nutrient, ranging from a "beginner-no-brainer" one part powder to a three part liquid system (can you say "turbo charge your plants"?).

Controller Instructions.

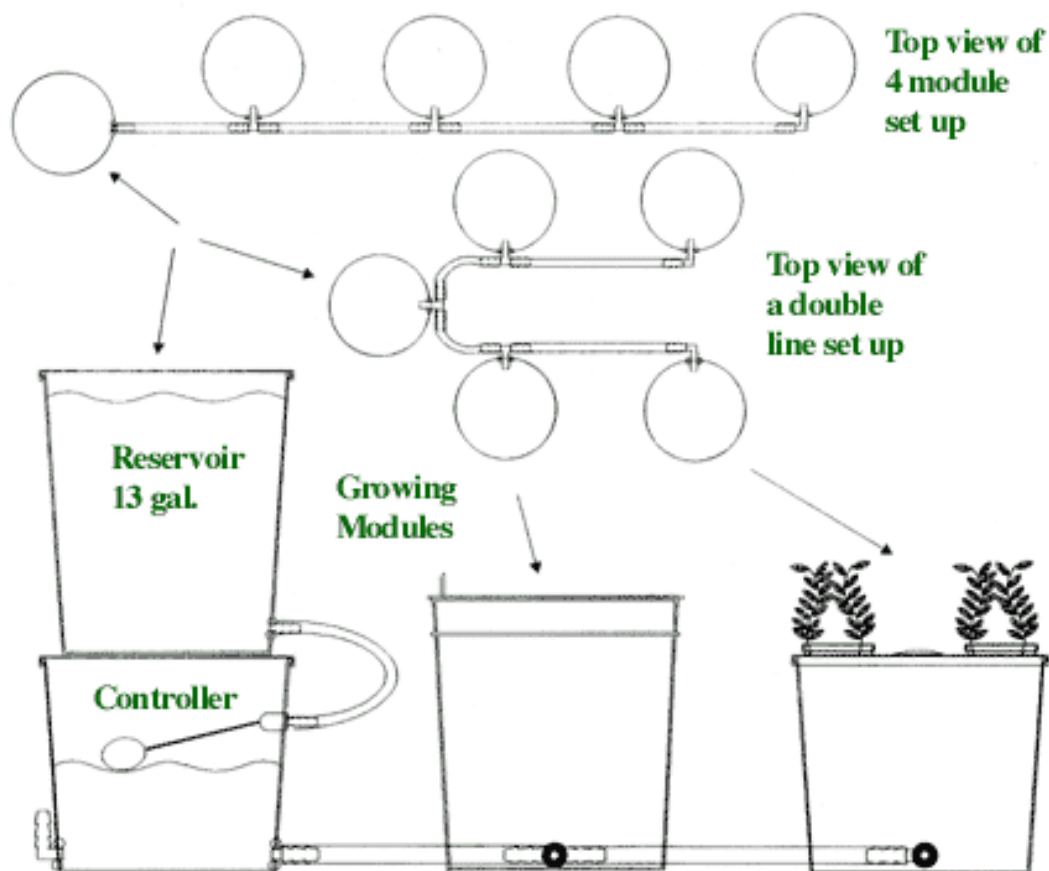

Controller Components

Each controller system consists of:

· **1 Controller Container**

· **1 Reservoir Container**

· **20 Fittings**

· **1/2" blue vinyl tubing**

(8 gallon with float valve, 2 grommets and lid)

(13 gallon with grommet and lid)

(7 Barbed 1/2 inch tees, 2 Elbow fittings and 2 straight fittings, 1 drain valve & 1 clip)

These fittings are appropriate for an 8 place set up, either in a straight row, or you may place the controller in the center and have two rows

(9 2 ft. sections of tubing)

The General Hydroponics controller/reservoir system automatically maintains the proper fluid level in multiple growing units. It is compatible with the WaterFarm, PowerGrower and Aquafarm modules. By feeding all your plants from a single source, you don't need to monitor the fluid depth, pH and PPM of each individual module, but only of a single reservoir. The large reservoir also lets you forget about tending your garden if you go away for a few days.

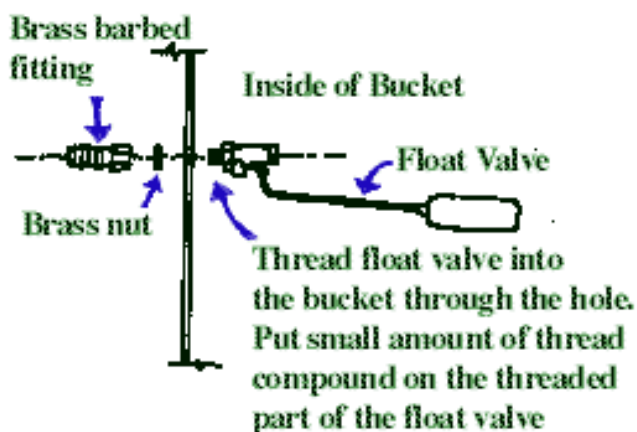

ASSEMBLY

Arrange the growing modules in either a single or double row (see diagram 1) on a level surface. The Controller can accommodate up to 8 modules.

Insert the straight fitting into the grommet near the bottom of the controller. Insert a tee fitting into the grommet near the bottom of each module. Place the elbow fitting in the last module(s). Connect the modules and controller container together using the blue vinyl tubing. Insert the drain level tube into the grommet on the opposite side of the controller.

Insert the float valve (see diagram 2) into the controller and attach the brass barb fitting. Add the nutrient solution to the controller container until all of the modules are filled to the proper level and the float valve shuts off the flow. Adjust the float valve rod by bending up or down to adjust the level in the modules. Place the lid onto the controller and sit the reservoir on top of controller container. Insert the straight fitting into the grommet near the bottom of the reservoir and attach the blue vinyl tubing to the fitting and the controller's barbed brass fitting. Fill the reservoir with the nutrient solution.

"General" Troubleshooting Guides

If white salt deposits form on the GROROX:

1. Try using a milder nutrient solution and topping off with plain water only.
2. Occasionally drain your system, refill with plain water and run the pump overnight. After the overnight rinse, empty reservoir and refill with fresh nutrient.

If plants are not growing well and you suspect "hard" water:

1. Try distilled or purified water. You should see a significant improvement in plant health and growth within one week
2. Collect rainwater for use in your system.

If nutrient solution stops flowing from the drip ring:

1. Check to ensure that pump is plugged in and reservoir is filled with nutrient solution.
2. Disconnect air line from the air inlet and check whether the air is coming through (put end under water and look for bubbles). No air flow could mean that the pump is broken and must be replaced or that the air line is loose or blocked. Try cutting an inch off each end of the line to provide a tighter fit.
3. Blow into the air inlet to check whether it is clogged. Rinse the pumping column in hot water. This type of clogging is usually an indication that you have hard water or too strong a nutrient solution.
4. Check whether emitter holes in the drip ring are clogged. To clear, disassemble drip ring by pulling it apart at the tee, rinse drip ring and tee in hot water and clear the holes with a toothpick.

How often should the reservoir be drained and the nutrient solution changed?

The reservoir should be drained and cleaned every 7-10 days. Definitely drain and clean whenever you change the nutrient ratio formula. Also, it is a good idea to rinse off the growing media each time the reservoir is cleaned. Plant waste will tend to accumulate on the growing media.

When reservoir levels begin to drop, should it be topped off with fresh water or nutrient solution?

Generally nutrient strength should run between 800 to 1200 parts per million (PPM). To measure PPM you will need to purchase a nutrient testing device and start monitoring your nutrient solution. We use meters with a "sodium chloride" scale.

When in doubt, remember that it is always better to apply too little nutrient than too much, and unless you know the specific PPM tolerance level for the plant you are growing, it is best to keep the nutrient solution between 800 and 1200 PPM.

ACCESSORIES

General Hydroponics offers many helpful products to support your system. These include:

- Controller—for interconnecting many planters
- Advanced Nutrient System: FloraMicro, FloraGro & FloraBloom
- Growing cups and covers
- GROROX®
- Pump Rebuild Kit
- pH Test Kit and pH Control Kit
- Digital electronic pH, ppm and temperature meters
- Meter calibration solutions
- PowerGrower—for growing very large plants

WaterFarm / AquaFarm Setup Instructions.

WaterFarm

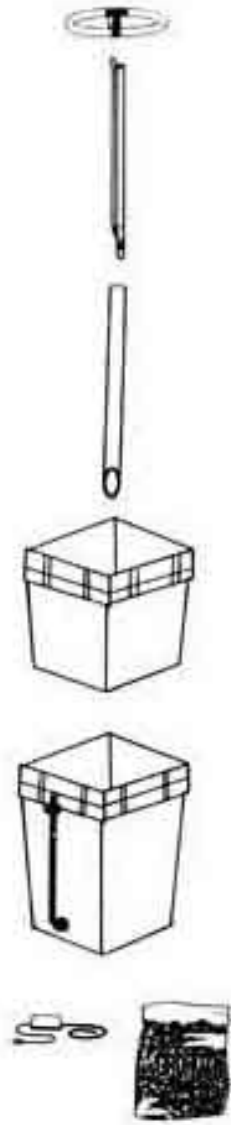

• **DRIP RING ASSEMBLY**

(circular plastic ring attached to tee)

• **PUMPING COLUMN**

(2-piece white tube with air inlet at bottom)

• **PUMPING COLUMN SUPPORT TUBE**

(white PVC tube with bevel facing down)

• **2 GAL. GROWING CHAMBER**

(shallow pot with perforated bottom)

• **3.5 GAL. GROWING CHAMBER**

(shallow pot with perforated bottom)

• **4 GAL. RESERVOIR**

(deep chamber for water, shown with drain level tube installed)

• **5 GAL. RESERVOIR**

(deep chamber for water, shown with drain level tube installed)



AIR PUMP • AIR LINE • GROROX

AquaFarm



	FLORAKIT (PINTS)	
--	-------------------------	--

Assembly Guide

FARM

Configuration

The growing chamber, filled with Grorox, sits in the reservoir container. The pumping column fits into the pumping pipe, reaching into the nutrient solution contained in the reservoir. Air pressure from the pump pushes the solution up through the pumping column to the drip ring, which is connected to the column with the tee connector, drip holes facing down. Solution drains to the drain/level tube elbow, which is inserted through the rubber grommet at the bottom of the reservoir.



Step #1.

Insert black clip.

**Step # 2.**

Install the blue drain/level tube along the outside of the reservoir . Moisten the end of the elbow fitting and push it through the rubber grommet from the outside until the third ridge enters the grommet . As you push, place your other hand inside the reservoir on the grommet to support it, so the grommet does not pop out. The tube fits into the clip at the top of the reservoir. If the grommet pops out, push it back in (the wider end points inward). If water leaks from this area after the reservoir is filled, make sure the blue tube fits tightly onto the elbow. Fill the reservoir to the white line marked on the blue drain/level tube, with tap water. Add General Hydroponics nutrient as per directions on the label.

**Step #3.**

Place the growing chamber on the reservoir.



Step #4.

Push the column support tube (the white PVC pipe), with the beveled end, into the large hole located in the bottom of the growing chamber so that it protrudes down into the reservoir. Adjust it so that its top comes to one inch below the rim of the growing chamber.



Step #5.

Attach the circular drip ring to the T fitting. Make sure holes on the drip ring are facing down.



Step # 6.

Push the entire drip ring assembly (which includes the drip ring, the T fitting and the white tubes attached to the drip ring) down into the pumping pipe. It is a good idea to disassemble and wash the drip ring assembly and pumping pipe from time to time in hot water.



Step # 7.

Move drip ring out of the way and pour the bag of Grorox into the growing chamber.



Step # 8.

Securely attach the air tube (the thin, flexible, clear tubing connected to the drip ring assembly) to the outlet nipple on the pump. Plug your Farm into any standard household electrical outlet. If you're using your Farm outside, use only extension cords and outlets designed for outdoor use.

Planting



To prepare a seedling or a plant for transplanting, remove all soil and/or organic material from around the roots. Plants must be sturdy with established roots before transplantation into the Farm. Choose seedlings, because it's more difficult to successfully transplant older plants. If your plant has been growing in soil or peat moss, gently remove the plant from its pot and carefully rinse as much soil as possible from the roots before transplanting. Although this method of transplanting from soil to hydroponics is somewhat risky, (soil may contain diseased organisms that proliferate in the rich hydroponic solution), we have been very successful in implementing it, particularly with culinary herbs and encourage you to try. Or, you can avoid these problems by starting plants from cuttings in one of our RainForest hydroponic systems.

**One plant centered
inside drip ring**



**Several plants spaced
outside drip ring**



If you plan to grow several small plants in the Farm, place your plants just outside the drip ring, near the drip holes. If you prefer a single large plant, place it in the center of the drip ring. Gently add Grorox around the plant roots until thoroughly covered.

PowerGrower Setup Instructions.

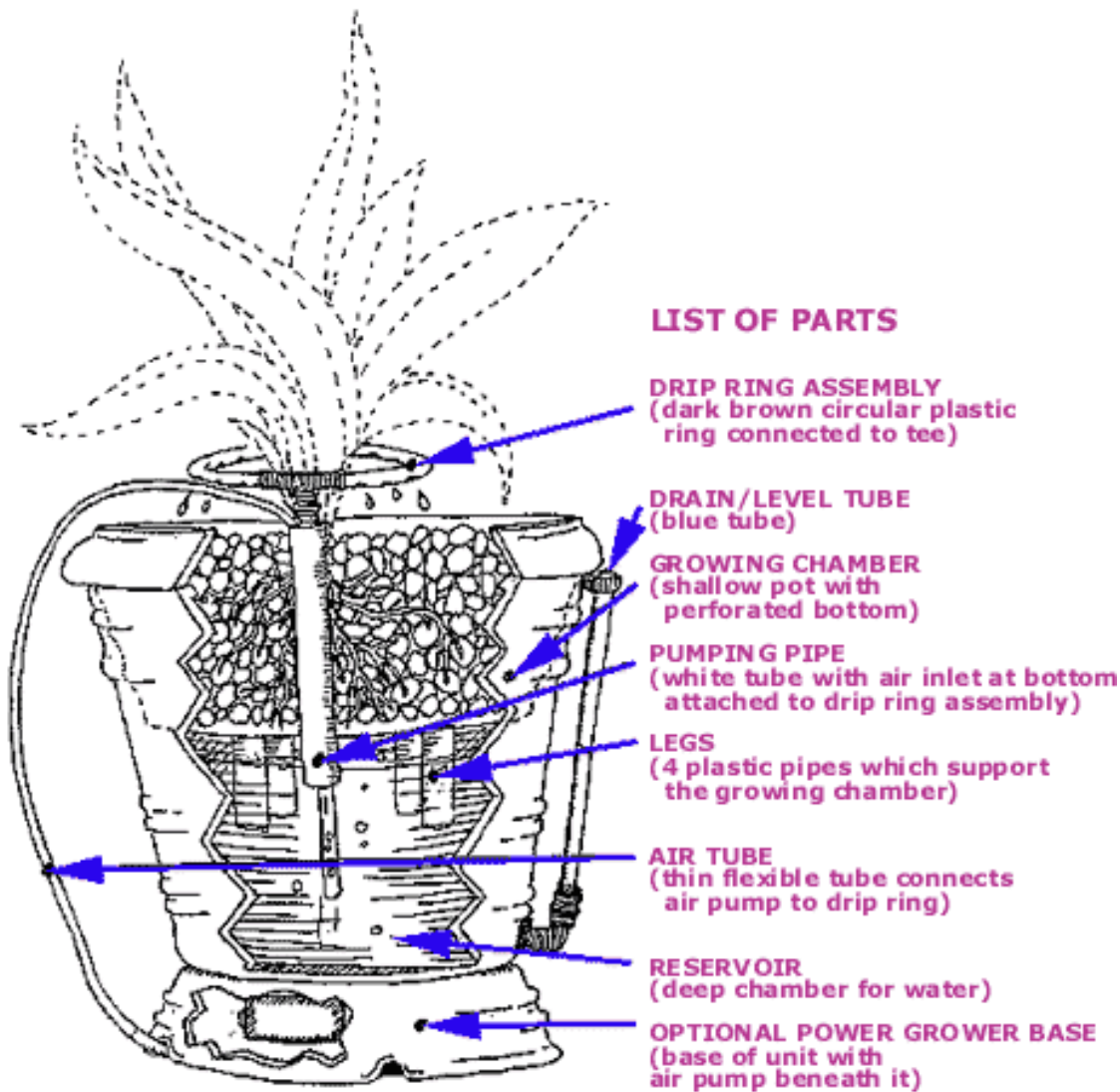

Configuration

The growing chamber, filled with Grorox, sits in the reservoir container. The pumping column fits into the pumping pipe, reaching into the nutrient solution contained in the reservoir. Air pressure from the pump pushes the solution up through the pumping column to the drip ring, which is connected to the column with the tee connector, drip holes facing down. Solution drains to the drain/level tube elbow, which is inserted through the rubber grommet at the bottom of the reservoir.

ASSEMBLY INSTRUCTIONS

Step #1. Securely attach the air tube (the thin, flexible, clear tubing connected to the drip ring assembly) to the outlet nipple on the pump.



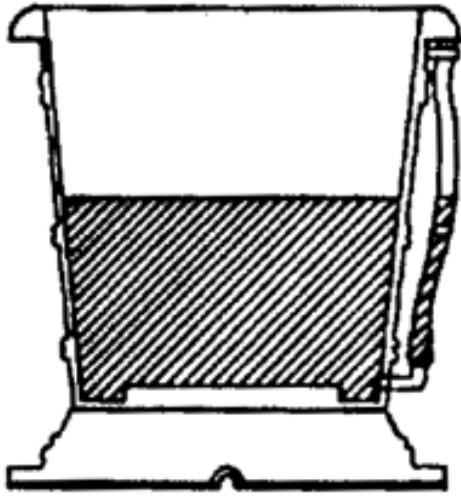

Step #2. Fill the reservoir to one inch above the white line marked on the blue dual function tube, with tap water. Add General Hydroponics nutrient as per directions on the label.

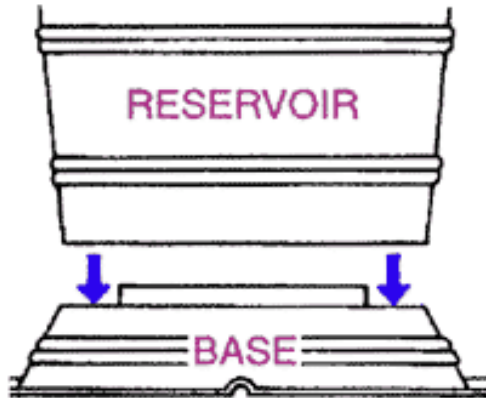

Step #3. Instructions for the optional Power Grower Base. Set the reservoir on the base, be sure the electrical cord and air tube each emerge separately from the air pump via notches located at the bottom of the base.

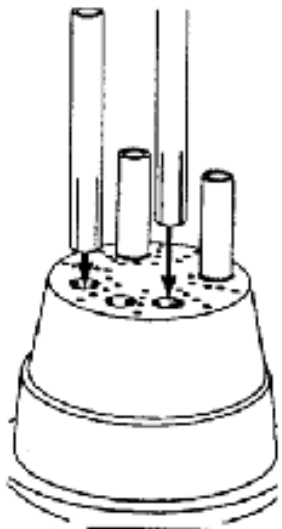
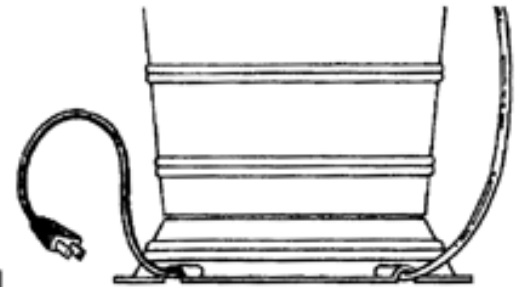

Step #4. Insert each of the legs (the long plastic pipes with slits) into each of the four indentations in the perforated base of the growing chamber. Push the slotted ends into the openings so they fit snugly. These legs support the growing chamber when removing for cleaning.

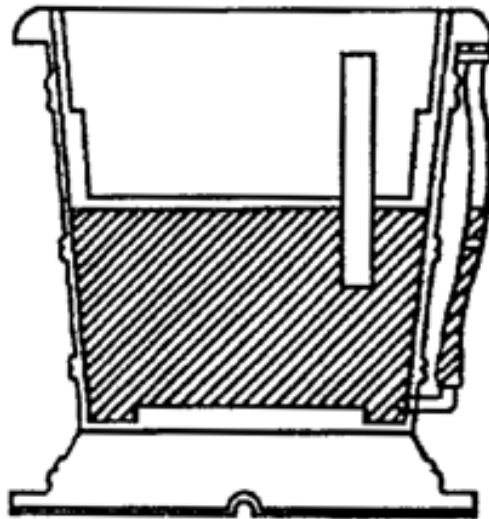

Step #5. Place the growing chamber on the reservoir. Push the pumping pipe (the remaining plastic pipe) into the large hole located in the bottom of the growing chamber so that it protrudes down into the reservoir. Adjust it so that its top comes to one inch below the rim of the growing chamber.

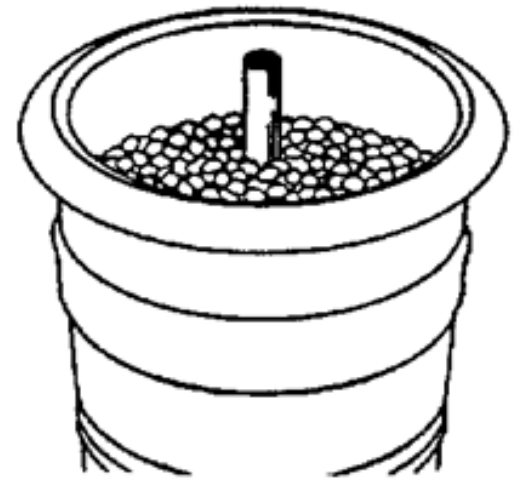

Step #6. To remove sand and other debris, pour Grorox into reservoir and rinse. Soak Grorox overnight in nutrient solution to precondition, then empty all Grorox from reservoir into the Growing Chamber to a level of three inches.

To prepare a seedling or a plant for transplanting, remove all soil and/or organic material from around the roots. Plants must be sturdy with established roots before transplantation into the Power Grower. Choose seedlings, because it's more difficult to successfully transplant older plants.

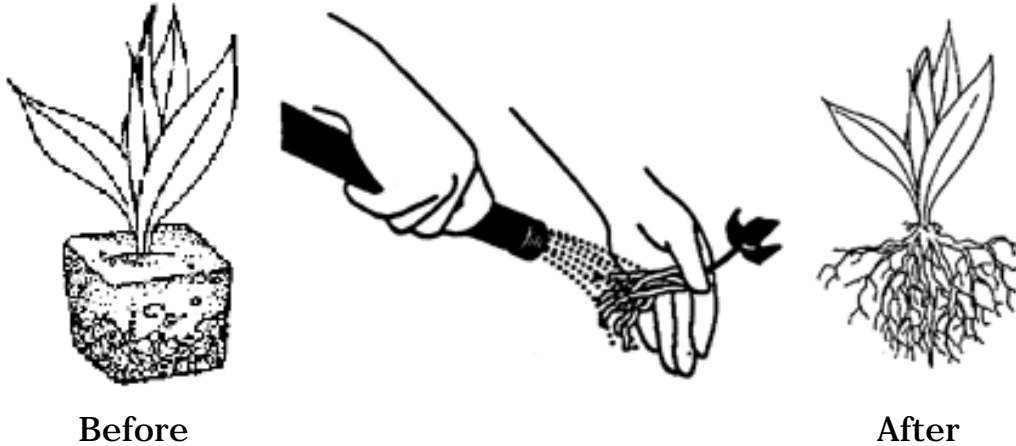

Before

After

Step #7. If your plant has been growing in soil or peat moss, gently remove the plant from its pot and carefully rinse as much soil as possible from the roots before transplanting. Although this method of transplanting from soil to hydroponics is somewhat risky, (soil may contain diseased organisms that proliferate in the rich hydroponic solution), we have been very successful in implementing it, particularly with culinary herbs and encourage you to try. Or, you can avoid these problems by starting plants from cuttings in one of our [RainForest](#) hydroponic systems.

One plant centered
inside drip ring Several plants spaced
outside drip



ring

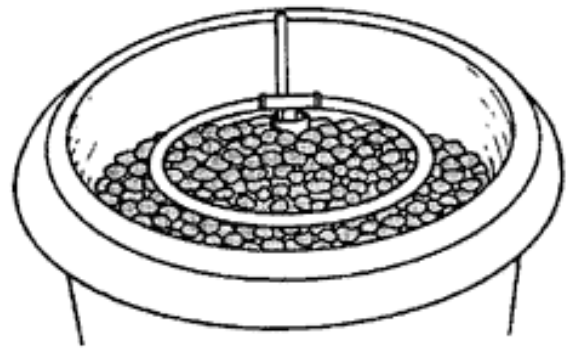

Step #7a. If you plan to grow several small plants in the Power Grower, place your plants just outside the drip ring, near the drip holes. If you prefer a single large plant, place it in the center of the drip ring. Gently add Grorox around the plant roots until thoroughly covered.

Step #8. Attach the circular brown drip ring to the T-clamp by pushing each end of the drip ring face down. Push the entire drip ring assembly (which includes the drip ring, the T-clamp and the white tubes attached to the drip ring clamp) down into the pumping pipe so that the whole assembly rests on, or slightly above, the Grorox. It is a good idea to disassemble and wash the drip ring assembly and pumping pipe from time to time in hot water.

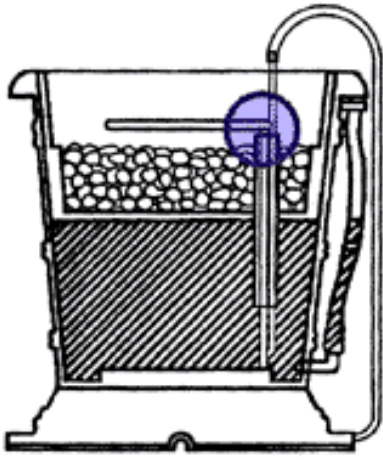

Step #9. Attach the air tube that is connected to the air pump into the stiff narrow tube of the drip ring assembly emerging from the pumping pipe.

Step #10. Plug your Power Grower into any standard household electrical outlet. If you're using your Power Grower outside, use only extension cords and outlets designed for outdoor use.

Abundant light, proper temperature and adequate ventilation are crucial for fast growth, healthy plants and higher yields. Place the Power Grower in a warm, well-lit, well-ventilated location, such as an outdoor garden, sunlit window, patio or greenhouse. And of course, keep your Power Grower away from areas where the inevitable dripping that occurs during filling, draining and pH adjustment could cause water damage.

Operation

For moisture-loving plants, operate your Power Grower pump continuously. Plants preferring drier conditions grow best when the pump runs for 12 hours and is off for 12 hours (a simple timer will turn the pump on and off for you automatically).

Use mild to normal strength nutrient solution and avoid strong or aggressive nutrient. As your plants consume nutrient solution, the level in the reservoir will drop. Top off with half strength solution or plain water (the pump is more efficient when the reservoir is full). It is necessary to change the water and nutrients every two to three weeks, simply empty the reservoir by rotating the blue dual function tube 90 degrees so water drains on the ground, or indoors in a pail. When changing or topping off solution, pour directly over the Grorox (rather than into the reservoir itself) to flush out excess salts.

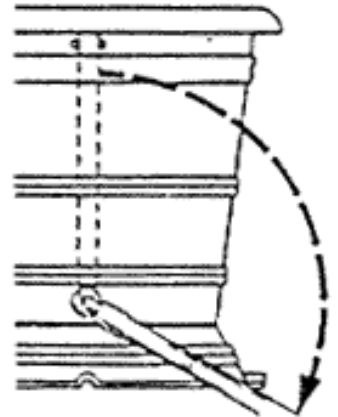

Preparation for Replanting

After harvesting and before replanting your Power Grower, dismantle the system and clean all parts with hot water. Rinse Grorox in very hot water and soak overnight. Unlike Rockwool, Grorox is reusable.

Troubleshooting

If white salt deposits form on the Grorox:

1. Try using a milder nutrient solution and topping off with plain water only.
2. Occasionally drain your system, refill with plain water and run the pump overnight. After the overnight rinse, empty reservoir and refill with fresh nutrient.

If Plants are not growing well and you suspect "hard" water:

1. Try distilled or purified water. You should see a significant improvement in plant health and growth within one week.
2. Collect rainwater for use in your Power Grower.

If nutrient solution stops flowing from the drip ring:

1. Check to ensure that pump is plugged in and reservoir is filled with nutrient solution.

2. Disconnect air line from the air inlet and check whether the air is coming through (put end under water and look for bubbles if you are not sure). No air flow could mean that the pump is broken and must be replaced or that the air line is loose or blocked. Try cutting an inch off each end of the line to provide a tighter fit.
3. Blow into the air inlet to check whether it is clogged, and rinse the pumping column in hot water. This type of clogging is usually an indication that you have hard water or too strong a nutrient solution.
4. Check whether emitter holes in the drip ring are clogged. To clear, disassemble drip ring by pulling it apart at the tee, rinse drip ring and tee in hot water and clear the holes with a toothpick.

Eve's Garden Setup Instructions.

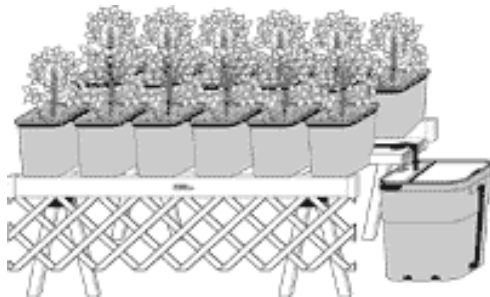
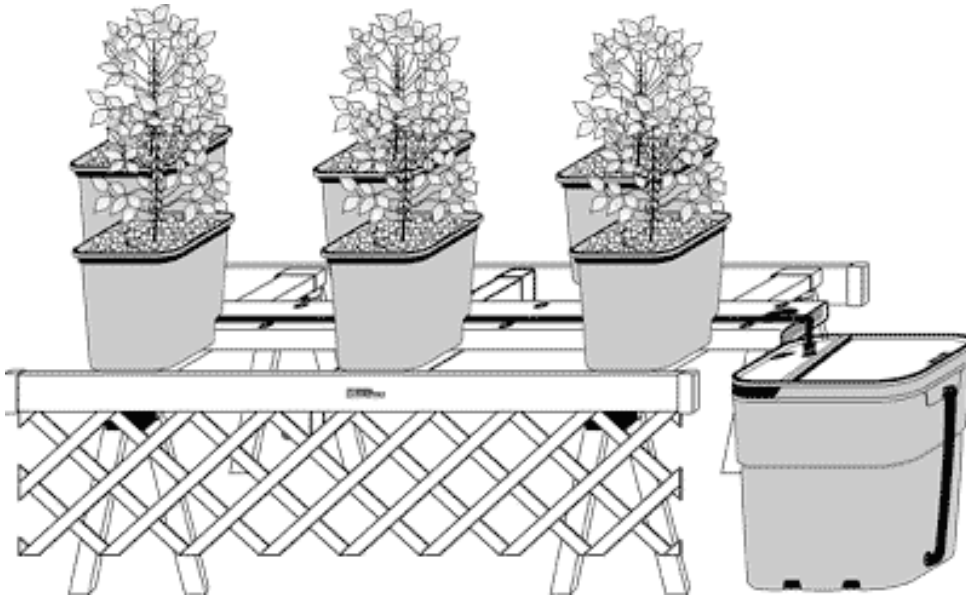

Eve's Garden™ 12

Congratulations on your selection of the Eve's Garden (Dutch Garden), the state of the art system in modern hydroponics. The Eve's Garden can be used in a greenhouse, on a patio or deck and indoors under lights. We look forward to your growing success and we welcome the opportunity to serve you during the coming years.

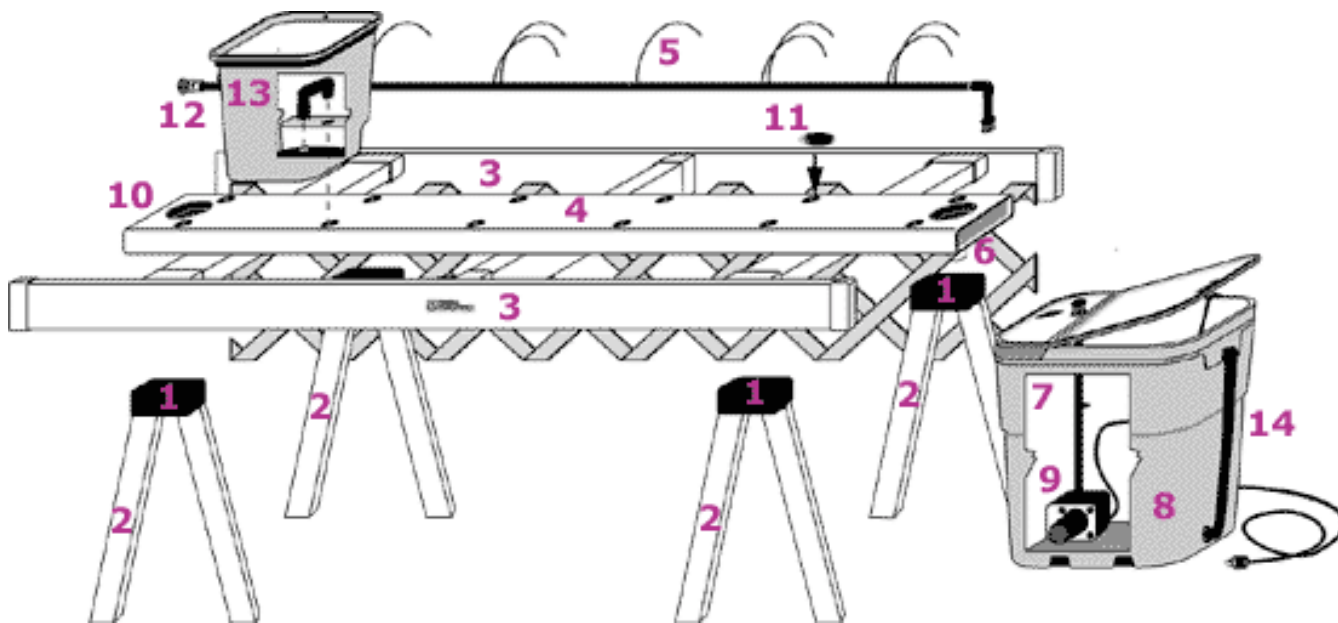

Packing List

Qty	Description (Eve's Garden in 3 boxes, Eve's Garden 12 in 5 boxes)
1. 4	Sawhorse brackets
2. 8	Sawhorse Legs
3. 2	68" support rails
4. 1	68" drain rail with 3 attached cross/braces
5. 1	68" drip line - 1/2" dripline tube, 12 spaghetti tubes, and 1 elbow fitting
6. 1	drain rail outlet
7. 1	15", 1/2" pump line tube with red spray emitter, and pump attachment fitting
8. 1	reservoir with lid
9. 1	pump
10. 2	large brown cap plugs
11. 6	small brown cap plugs
12. 6	Dutch Pots (Dutch 12 contains 12 Dutch Pots)
13. 12	drain fittings (6 assembled), Dutch 12 contains 24 fittings
14. 1	blue drain level tube with elbow fitting and DLT clip
Misc. 6	drip stakes (12 in 12 pack)
1	13.2 gallon bag of Grorox (Dutch 12 contains 2 bags)
1	Flora Kit (FloraMicro, FloraGro, FloraBloom)
1	pH test kit
3	Cocopeat bricks (Dutch 12 contains 6 bricks)
1	lattice (18"x66")
1	timer

Step 1.

Attach the sawhorse brackets and legs onto the cross braces.

Saw Horse Assembly Instructions

***Flip drawing over for upright
view***

Step 1)

Insert Carriage Bolt into countersunk
1" hole in Crossbrace

Step 2)

Put Sawhorse Bracket onto
Crossbrace

Step 3)

Install Legs, making sure they are
fully seated

Step 4)

Install Wedge onto Carriage Bolt.
Push down on legs and install Wing
Nut. Tighten Wing Nut until snug

Step 5)

Repeat for all Legs

Step 6)

Flip over and push Black Plastic Caps
into 1" countersunk holes

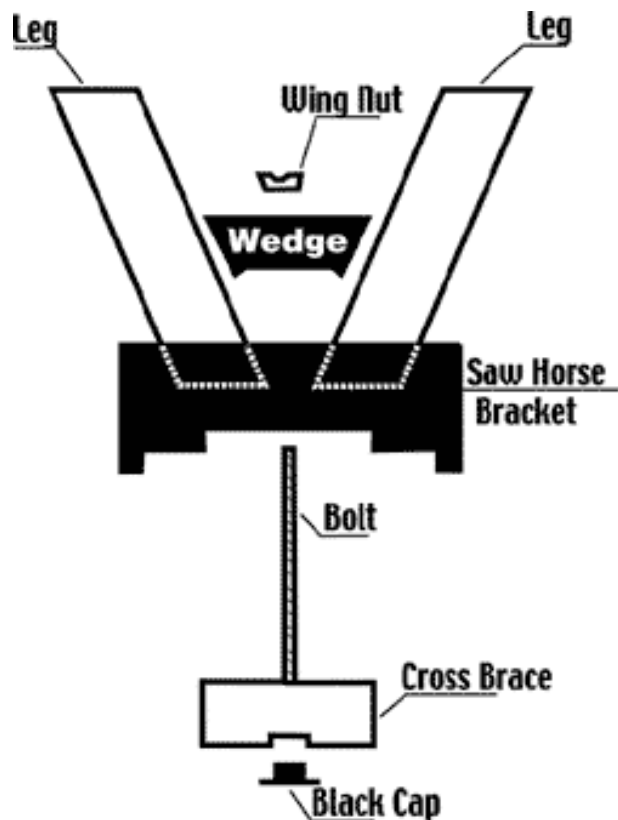

Step 2.

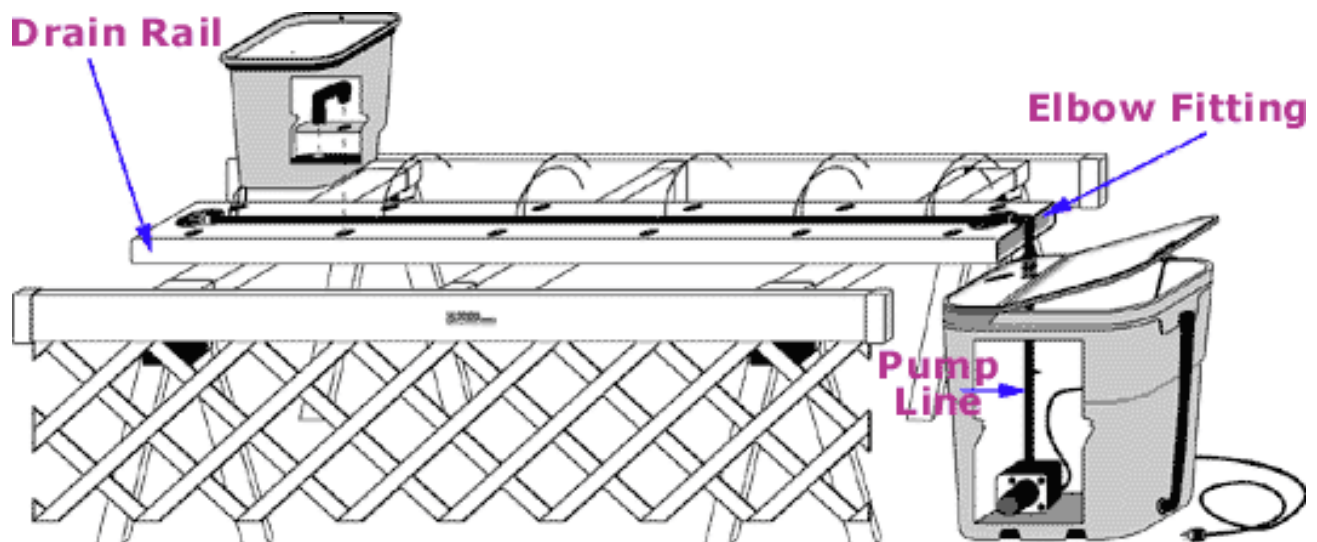

Screw pump line onto pump. Place pump into reservoir by inserting the end of pump line through the hole in the lid of the reservoir. Place pump parallel to left side of reservoir, placing power cord through cutout in lid. Lift drain end of structure and slide the reservoir under the drain tube; align drain tube with large hole in lid. Place black drip line, with attached spaghetti tubing, on top of drain rail. With elbow fitting extending past drain rail, screw elbow onto pump line. Attach the lattice to the backside of the support rail with screws.

Step 3

Insert drain fittings into each dutch pot. The smaller end of drain fitting fits into hole on upper ledge of pot; wide end fits over plastic extension located in bottom of pot.

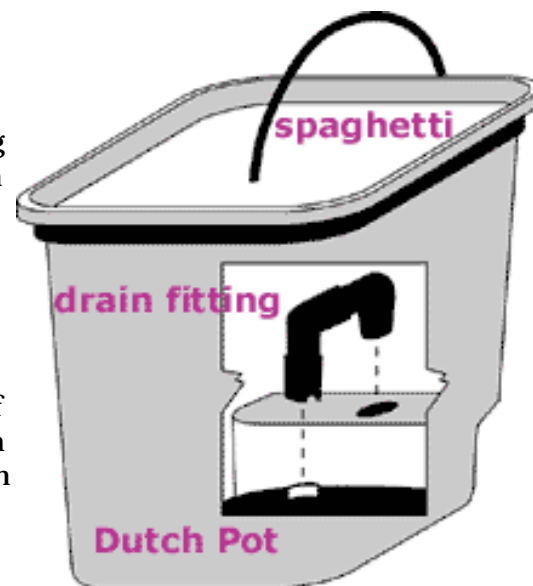

Step 4

Open the bag of Grorox and rinse thoroughly with plain water. Fill the dutch pots to an inch above the drain fittings. Reserve a like amount of Grorox for top mulch (step 5). The remaining Grorox will be mixed with prepared cocopeat (step 5). Note: One 13.2 gallon bag of Grorox, when mixed with the 3cocopeat bricks, will fill the six Dutch pots.

Step 5

Fill a 5 gallon bucket with 3 gallons of water and place the three bricks of Cocopeat into the bucket of water. Soak until the Cocopeat breaks down into a soil like substance. Thoroughly mix the Grorox into the Cocopeat and then fill the Dutch Pots with this mixture. Top dress the Dutch Pots with 1" of Grorox.

Step 6

Prepare your seedling or plant for transplanting by removing and rinsing away all soil and/or organic material from around the roots. It is best to choose seedlings as it is more difficult to successfully transplant older plants. Then place the seedling or plant into the Grorox/Cocopeat mixture. You can, of course, begin with seeds by planting them exactly as you would with soil.

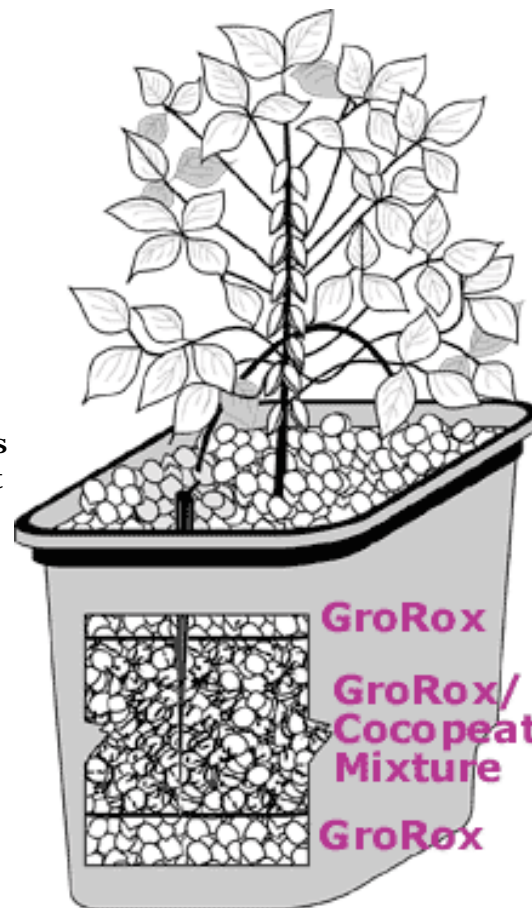

Step 7

Place the Dutch Pots onto the support rail and into one of the holes on the drain rail. Then attach the drip stakes to the end of the spaghetti tubes. Insert the pointed end of the drip stakes into the Dutch Pots near the plants. Insert any unused spaghetti lines into the small brown cap plugs. Insert the cap plugs into the unused holes on the drain rail.

Planning and Building a Greenhouse.

Adapted from Fact Sheet 645 - University of Maryland Cooperative Extension Service, David S. Ross, Extension Agricultural Engineer, Department of Agricultural Engineering

Location	Types of Greenhouses	Structural Materials
Foundations & Floors	Heating	Air Circulation
Ventilation	Cooling	Watering Systems

Careful planning is important before a home greenhouse project is started. Building a greenhouse does not need to be expensive or time-consuming. The final choice of the type of greenhouse will depend on the growing space desired, home architecture, available sites, and costs. The greenhouse must, however, provide the proper environment for growing plants.

Location

The greenhouse should be located where it gets maximum sunlight. The first choice of location is the south or southeast side of a building or shade trees. Sunlight all day is best, but morning sunlight on the east side is sufficient for plants. Morning sunlight is most desirable because it allows the plant's food production process to begin early; thus growth is maximized. An east side location captures the most November to February sunlight. The next best sites are southwest and west of major structures, where plants receive sunlight later in the day. North of major structures is the least desirable location and is good only for plants that require little light.

Deciduous trees, such as maple and oak, can effectively shade the greenhouse from the intense late afternoon summer sun; however, they should not shade the greenhouse in the morning. Deciduous trees also allow maximum exposure to the winter sun because they shed their leaves in the fall. Evergreen trees that have foliage year round should not be located where they will shade the greenhouse because they will block the less intense winter sun. You should aim to maximize winter sun exposure, particularly if the greenhouse is used all year. Remember that the sun is lower in the southern sky in winter causing long shadows to be cast by buildings and evergreen trees (Figure 1).

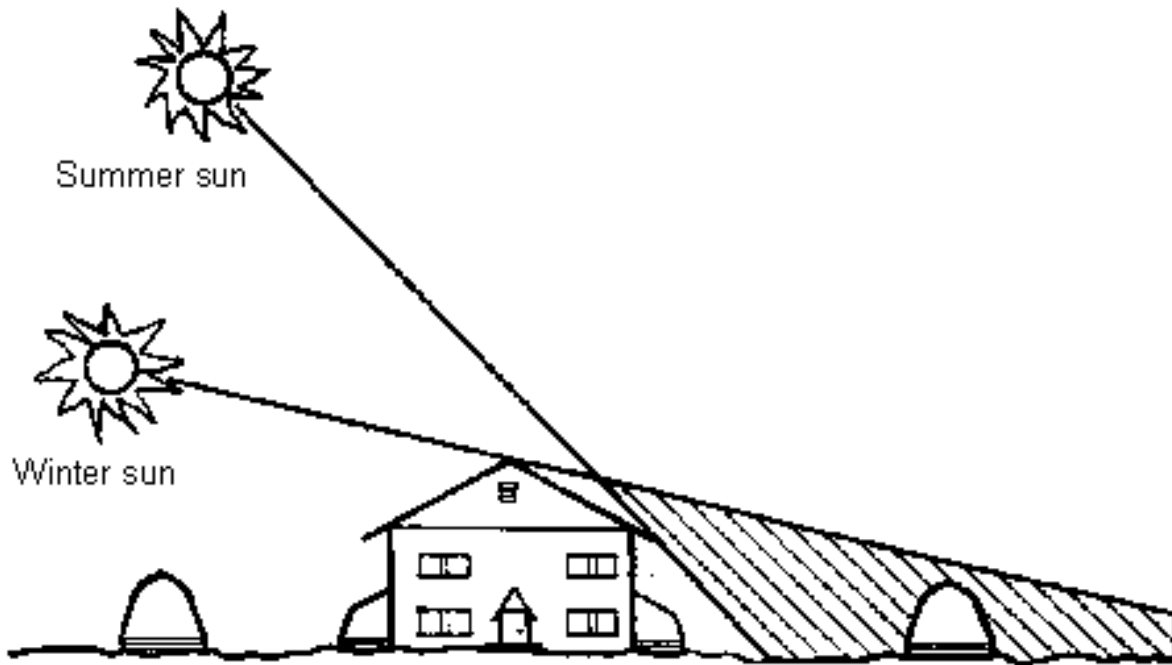

Figure 1. Select location carefully. Note where the shade line occurs in both the winter and summer.

Good drainage is another requirement for the site. When necessary, build the greenhouse above the surrounding ground so rainwater and irrigation water will drain away. Other site considerations include the light requirements of the plants to be grown; locations of sources of heat, water, and electricity; and shelter from winter wind. Access to the greenhouse should be convenient for both people and utilities. A workplace for potting plants and a storage area for supplies should be nearby.

Types of Greenhouses [↑](#)

A home greenhouse can be attached to a house or garage, or it can be a freestanding structure. The chosen site and personal preference can dictate the choices to be considered. An attached greenhouse can be a half greenhouse, a full-size structure, or an extended window structure. There are advantages and disadvantages to each type.

Attached Greenhouses

Lean-to. A lean-to greenhouse is a half greenhouse, split along the peak of the roof, or ridge line (Figure 2A), Lean-tos are useful where space is limited to a width of approximately seven to twelve feet, and they are the least expensive structures. The ridge of the lean-to is attached to a building using one side and an existing doorway, if available. Lean-tos are close to available electricity, water and heat. The disadvantages include some limitations on space, sunlight, ventilation, and temperature control. The height of the supporting wall limits the potential size of the lean-to. The wider the lean-to, the higher the supporting wall must be. Temperature control is more difficult because the wall that the greenhouse is built on may collect the sun's heat while the translucent cover of the greenhouse may lose heat rapidly.

The lean-to should face the best direction for adequate sun exposure. Finally, consider the location of windows and doors on the supporting structure and remember that snow, ice, or heavy rain might slide off the roof or the house onto the structure.

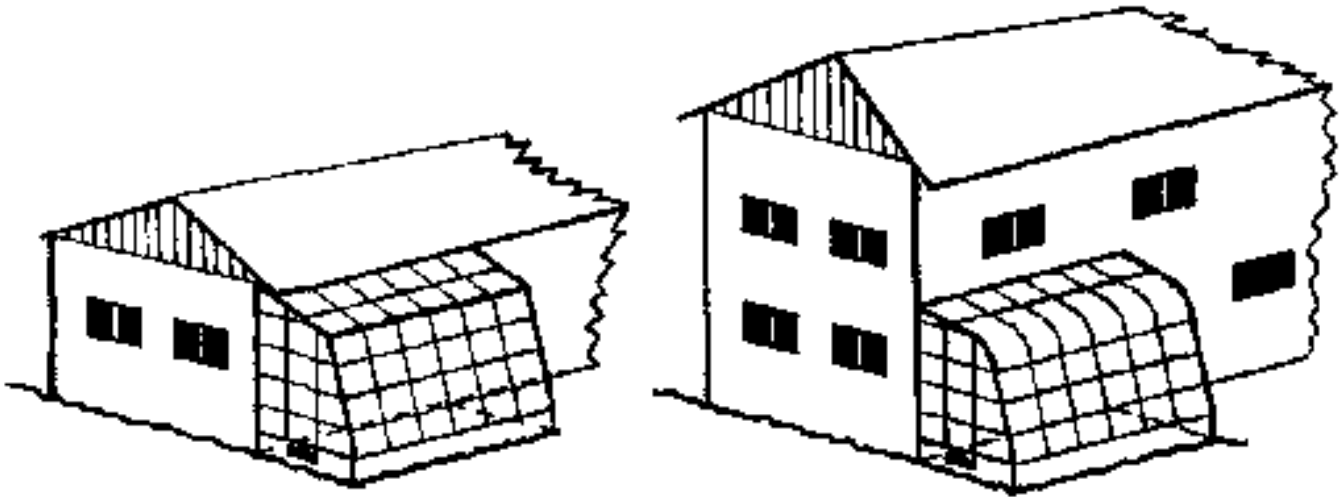

A straight-eave lean-to greenhouse can fit under the roof of a single-story house.

This is an example of a curved-eave lean-to built on a two-story house.

Figure 2A. Different types of greenhouses allow many options.

Even-span. An even-span is a full-size structure that has one gable end attached to another building (Figure 2B). It is usually the largest and most costly option, but it provides more usable space and can be lengthened. The even-span has a better shape than a lean-to for air circulation to maintain uniform temperatures during the winter heating season. An even-span can accommodate two to three benches for growing crops.

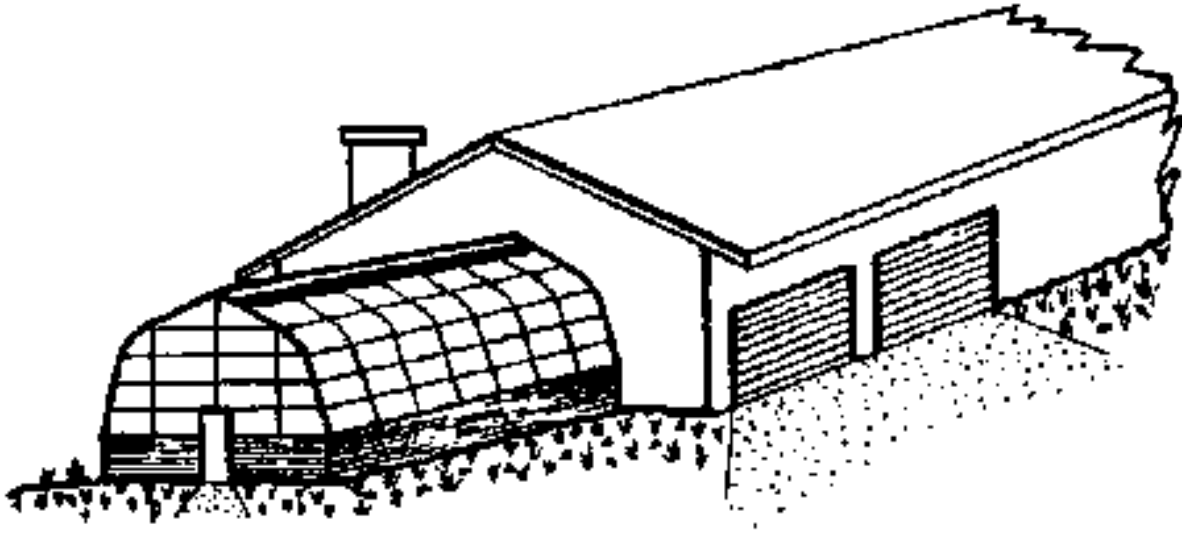

An even-span attached to a garage allows a larger greenhouse in a limited space.

Figure 2B. Different types of greenhouses allow many options.

Window-mounted. A window-mounted greenhouse can be attached on the south or east side of a house. This glass enclosure gives space for conveniently growing a few plants at relatively low cost (Figure 2D). The special window extends outward from the house a foot or so and can contain two or three shelves.



Freestanding greenhouses allow more location choices and can be larger than attached greenhouses.

Figure 2C. Different types of greenhouses allow many options.

Freestanding Structures

Freestanding greenhouses are separate structures; they can be set apart from other buildings to get more

sun and can be made as large or small as desired (Figure 2C). A separate heating system is needed, and electricity and water must be installed.

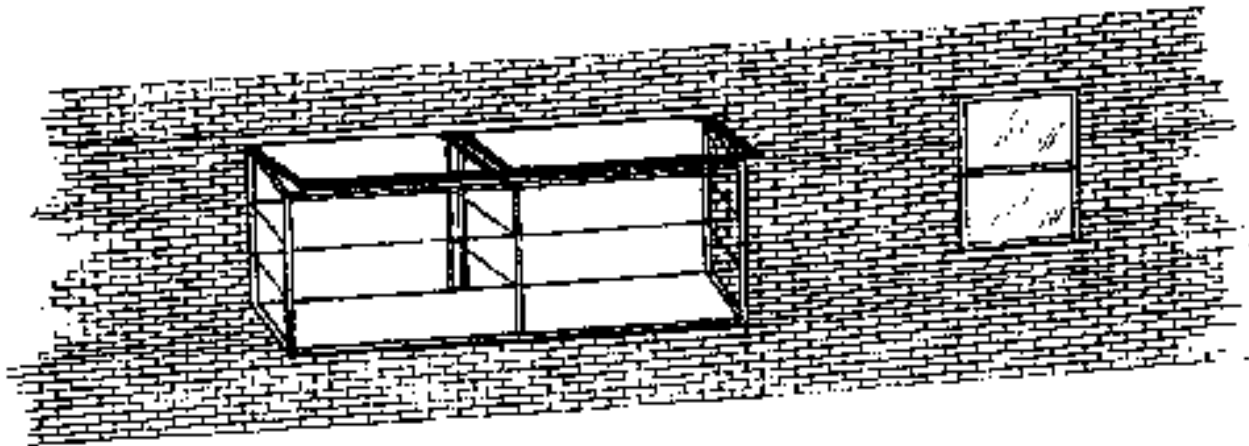

A window-mounted unit extends a house's growing space.

Figure 2D. Different types of greenhouses allow many options.

The lowest cost per square foot of growing space is generally available in a freestanding or even-span greenhouse that is 17 to 18 feet wide. It can house a central bench, two side benches, and two walkways. The ratio of cost to the usable growing space is good.

When deciding on the type of structure, be sure to plan for adequate bench space, storage space, and room for future expansion. Large greenhouses are easier to manage because temperatures in small greenhouses fluctuate more rapidly. Small greenhouses have a large exposed area through which heat is lost or gained, and the air volume inside is relatively small; therefore, the air temperature changes quickly in a small greenhouse. Suggested minimum sizes are 6 feet wide by 12 feet long for an even-span or freestanding greenhouse.

Structural Materials

A good selection of commercial greenhouse frames and framing materials is available. The frames are made of wood, galvanized steel, or aluminum. Build-it-yourself greenhouse plans are usually for structures with wood or metal pipe frames. Plastic pipe materials generally are inadequate to meet snow and wind load requirements. Frames can be covered with glass, rigid fiberglass, rigid double-wall plastics, or plastic film. All have advantages and disadvantages. Each of these materials should be considered--it pays to shop around for ideas.

Frames

Greenhouse frames range from simple to complex, depending on the imagination of the designer and

engineering requirements. The following are several common frames (Figure 3).

Quonset. The Quonset is a simple and efficient construction with an electrical conduit or galvanized steel pipe frame. The frame is circular and usually covered with plastic sheeting. Quonset sidewall height is low, which restricts storage space and headroom.

Gothic. The gothic frame construction is similar to that of the Quonset but it has a gothic shape (Figure 3). Wooden arches may be used and joined at the ridge. The gothic shape allows more headroom at the sidewall than does the Quonset.

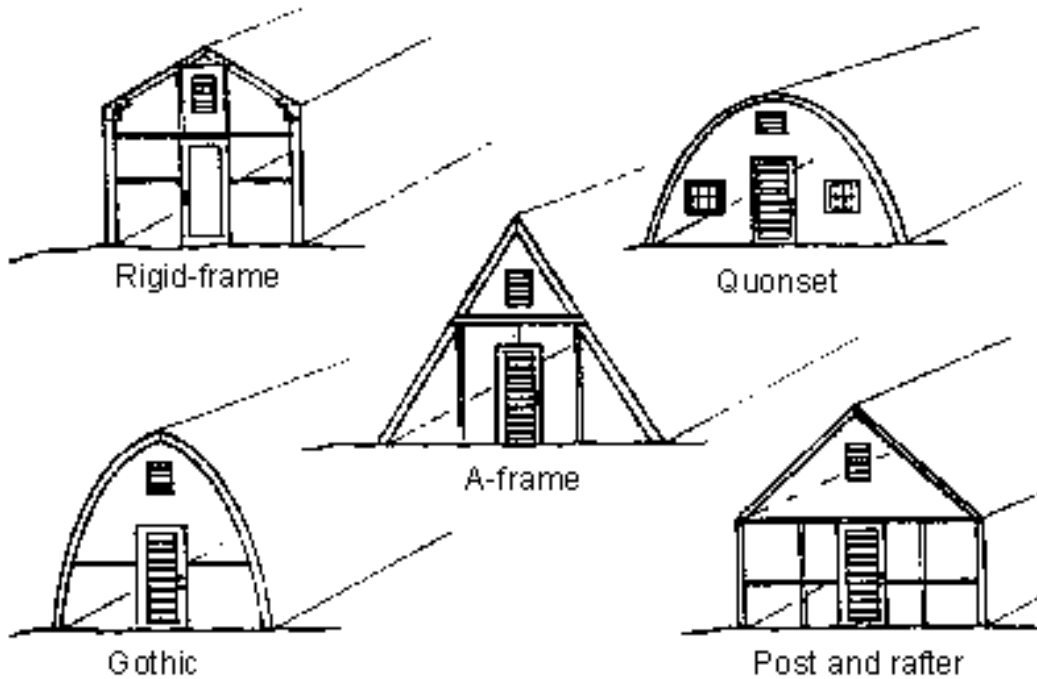

Figure 3. Greenhouses can have a variety of different structural frames.

Rigid-frame. The rigid-frame structure has vertical sidewalls and rafters for a clear-span construction. There are no columns or trusses to support the roof. Glued or nailed plywood gussets connect the sidewall supports to the rafters to make one rigid frame. The conventional gable roof and sidewalls allow maximum interior space and air circulation. A good foundation is required to support the lateral load on the sidewalls.

Post and rafter and A-frame. The post and rafter is a simple construction of an embedded post and rafters, but it requires more wood or metal than some other designs. Strong sidewall posts and deep post embedment are required to withstand outward rafter forces and wind pressures. Like the rigid frame, the post and rafter design allows more space along the sidewalls and efficient air circulation. The A-frame is similar to the post and rafter construction except that a collar beam ties the upper parts of the rafters together.

Coverings

Greenhouse coverings include long-life glass, fiberglass, rigid double-wall plastics, and film plastics with 1- to 3-year lifespans. The type of frame and cover must be matched correctly.

Glass. Glass is the traditional covering. It has a pleasing appearance, is inexpensive to maintain, and has a high degree of permanency. An aluminum frame with a glass covering provides a maintenance-free, weather-tight structure that minimizes heat costs and retains humidity. Glass is available in many forms that would be suitable with almost any style or architecture. Tempered glass is frequently used because it is two or three times stronger than regular glass. Small prefabricated glass greenhouses are available for do-it-yourself installation, but most should be built by the manufacturer because they can be difficult to construct.

The disadvantages of glass are that it is easily broken, is initially expensive to build, and requires much better frame construction than fiberglass or plastic. A good foundation is required, and the frames must be strong and must fit well together to support heavy, rigid glass.

Fiberglass. Fiberglass is lightweight, strong, and practically hailproof. A good grade of fiberglass should be used because poor grades discolor and reduce light penetration. Use only clear, transparent, or translucent grades for greenhouse construction. Tedlar-coated fiberglass lasts 15 to 20 years. The resin covering the glass fibers will eventually wear off, allowing dirt to be retained by exposed fibers. A new coat of resin is needed after 10 to 15 years. Light penetration is initially as good as glass but can drop off considerably over time with poor grades of fiberglass.

Double-wall plastic. Rigid double-layer plastic sheets of acrylic or polycarbonate are available to give long-life, heat-saving covers. These covers have two layers of rigid plastic separated by webs. The double-layer material retains more heat, so energy savings of 30 percent are common. The acrylic is a long-life, nonyellowing material; the polycarbonate normally yellows faster, but usually is protected by a UV-inhibitor coating on the exposed surface. Both materials carry warranties for 10 years on their light transmission qualities. Both can be used on curved surfaces; the polycarbonate material can be curved the most. As a general rule, each layer reduces light by about 10 percent. About 80 percent of the light filters through double-layer plastic, compared with 90 percent for glass.

Film plastic. Film-plastic coverings are available in several grades of quality and several different materials. Generally, these are replaced more frequently than other covers. Structural costs are very low because the frame can be lighter and plastic film is inexpensive. Light transmission of these film-plastic coverings is comparable to glass. The films are made of polyethylene (PE), polyvinyl chloride (PVC), copolymers, and other materials. A utility grade of PE that will last about a year is available at local hardware stores. Commercial greenhouse grade PE has ultraviolet inhibitors in it to protect against ultraviolet rays; it lasts 12 to 18 months. Copolymers last 2 to 3 years. New additives have allowed the manufacture of film plastics that block and reflect radiated heat back into the greenhouse, as does glass which helps reduce heating costs. PVC or vinyl film costs two to five times as much as PE but lasts as long as five years. However, it is available only in sheets four to six feet wide. It attracts dust from the air, so it must be washed occasionally.

Foundations and Floors

Permanent foundations should be provided for glass, fiberglass, or the double-layer rigid-plastic sheet materials. The manufacturer should provide plans for the foundation construction. Most home greenhouses require a poured concrete foundation similar to those in residential houses. Quonset greenhouses with pipe frames and a plastic cover use posts driven into the ground.

Permanent flooring is not recommended because it may stay wet and slippery from soil mix media. A concrete, gravel, or stone walkway 24 to 36 inches wide can be built for easy access to the plants. The rest of the floor should be covered by several inches of gravel for drainage of excess water. Water also can be sprayed on the gravel to produce humidity in the greenhouse.

Environmental Systems

Greenhouses provide a shelter in which a suitable environment is maintained for plants. Solar energy from the sun provides sunlight and some heat, but you must provide a system to regulate the environment in your greenhouse. This is done by using heaters, fans, thermostats, and other equipment.

Heating

The heating requirements of a greenhouse depend on the desired temperature for the plants grown, the location and construction of the greenhouse, and the total outside exposed area of the structure. As much as 25 percent of the daily heat requirement may come from the sun, but a lightly insulated greenhouse structure will need a great deal of heat on a cold winter night. The heating system must be adequate to maintain the desired day or night temperature.

Usually the home heating system is not adequate to heat an adjacent greenhouse. A 220-volt circuit electric heater, however, is clean, efficient, and works well. Small gas or oil heaters designed to be installed through a masonry wall also work well.

Solar-heater greenhouses were popular briefly during the energy crisis, but they did not prove to be economical to use. Separate solar collection and storage systems are large and require much space. However, greenhouse owners can experiment with heat-collecting methods to reduce fossil-fuel consumption. One method is to paint containers black to attract heat, and fill them with water to retain it. However, because the greenhouse air temperature must be kept at plant-growing temperatures, the greenhouse itself is not a good solar-heat collector.

Heating systems can be fueled by electricity, gas, oil, or wood. The heat can be distributed by forced hot air, radiant heat, hot water, or steam. The choice of a heating system and fuel depends on what is locally available, the production requirements of the plants, cost, and individual choice. For safety purposes, and to prevent harmful gases from contacting plants, all gas, oil, and woodburning systems must be properly

vented to the outside. Use fresh-air vents to supply oxygen for burners for complete combustion. Safety controls, such as safety pilots and a gas shutoff switch, should be used as required. Portable kerosene heaters used in homes are risky because some plants are sensitive to gases formed when the fuel is burned.

Calculating heating system capacity. Heating systems are rated in British thermal units (Btu) per hour (h). The Btu capacity of the heating system, Q , can be estimated easily using three factors:

1. A is the total exposed (outside) area of the greenhouse sides, ends, and roof in square feet (ft^2). On a Quonset, the sides and roof are one unit; measure the length of the curved rafter (ground to ground) and multiply by the length of the house. The curves end area is 2 (ends) \times $2/3$ \times height \times width. Add the sum of the first calculation with that of the second.
2. u is the heat loss factor that quantifies the rate at which heat energy flows out of the greenhouse. For example, a single cover of plastic or glass has a value of $1.2 \text{ Btu/h} \times \text{ft}^2 \times ^\circ\text{F}$ (heat loss in Btu's per hour per each square foot of area per degree in Fahrenheit); a double-layer cover has a value of $0.8 \text{ Btu/h} \times \text{ft}^2 \times ^\circ\text{F}$. The values allow for some air infiltration but are based on the assumption that the greenhouse is fairly airtight.
3. $(T_i - T_o)$ is the maximum temperature difference between the lowest outside temperature (T_o) in your region and the temperature to be maintained in the greenhouse (T_i). For example, the maximum difference will usually occur in the early morning with the occurrence of a 0°F to -5°F outside temperature while a 60°F inside temperature is maintained. Plan for a temperature differential of 60 to 65°F . The following equation summarizes this description: $Q = A \times u \times (T_i - T_o)$.

Example. If a rigid-frame or post and rafter freestanding greenhouse 16 feet wide by 24 feet long, 12 feet high at the ridge, with 6 feet sidewalls, is covered with single-layer glass from the ground to the ridge, what size gas heater would be needed to maintain 60°F on the coldest winter night (0°F)? Calculate the total outside area (Figure 4):

two long sides	$2 \times 6 \text{ ft} \times 24 \text{ ft} = 288 \text{ ft}^2$
two ends	$2 \times 6 \text{ ft} \times 16 \text{ ft} = 192 \text{ ft}^2$
roof	$2 \times 10 \text{ ft} \times 24 \text{ ft} = 480 \text{ ft}^2$
gable ends	$2 \times 6 \text{ ft} \times 8 \text{ ft} = 96 \text{ ft}^2$
	$A = 1,056 \text{ ft}^2$

Select the proper heat loss factor, $u = 1.2 \text{ Btu/h} \times \text{ft}^2 \times ^\circ\text{F}$. The temperature differential is $60^\circ\text{F} - 0^\circ\text{F} = 60^\circ\text{F}$.

$$Q = 1,056 \times 1.2 \times 60 = 76,032 \text{ Btu/h (furnace output).}$$

Although this is a relatively small greenhouse, the furnace output is equivalent to that in a small residence such as a townhouse. The actual furnace rated capacity takes into account the efficiency of the furnace and

is called the furnace input fuel rating.

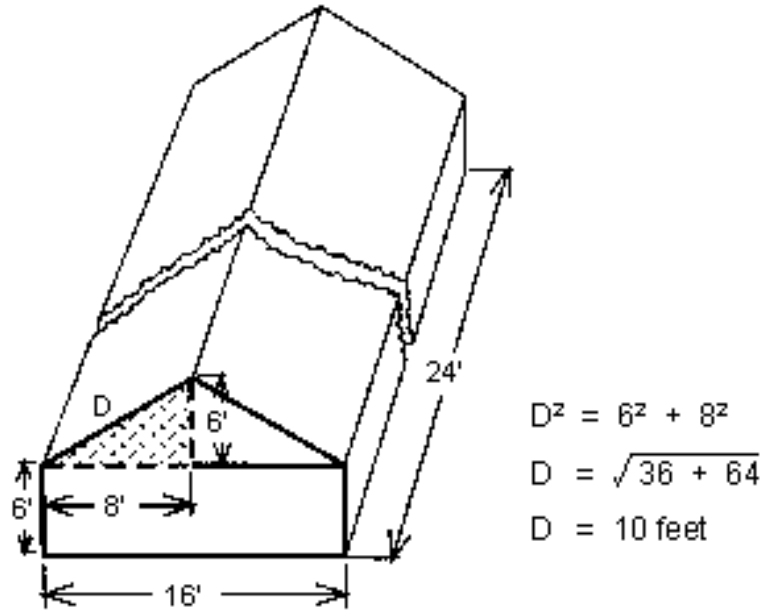

Figure 4. Use the greenhouse's dimensions to determine the necessary heating system capacity.

This discussion is a bit technical, but these factors must be considered when choosing a greenhouse. Note the effect of each value on the outcome. When different materials are used in the construction of the walls or roof, heat loss must be calculated for each. For electrical heating, convert Btu/h to kilowatts by dividing Btu/h by 3,413. If a wood, gas, or oil burner is located in the greenhouse, a fresh-air inlet is recommended to maintain an oxygen supply to the burner. Place a piece of plastic pipe through the outside cover to ensure that oxygen gets to the burner combustion air intake. The inlet pipe should be the diameter of the flue pipe. This ensures adequate air for combustion in an airtight greenhouse. Unvented heaters (no chimney) using propane gas or kerosene are not recommended.

Air Circulation

Installing circulating fans in your greenhouse is a good investment. During the winter when the greenhouse is heated, you need to maintain air circulation so that temperatures remain uniform throughout the greenhouse. Without air-mixing fans, the warm air rises to the top and cool air settles around the plants on the floor.

Small fans with a cubic-foot-per-minute (ft^3/min) air-moving capacity equal to one quarter of the air volume of the greenhouse are sufficient. For small greenhouses (less than 60 feet long), place the fans in diagonally opposite corners but out from the ends and sides. The goal is to develop a circular (oval) pattern of air movement. Operate the fans continuously during the winter. Turn these fans off during the summer when the greenhouse will need to be ventilated.

The fan in a forced-air heating system can sometimes be used to provide continuous air circulation. The fan must be wired to an on/off switch so it can run continuously, separate from the thermostatically controlled burner.

Ventilation

Ventilation is the exchange of inside air for outside air to control temperature, remove moisture, or replenish carbon dioxide (CO₂). Several ventilation systems can be used. Be careful when mixing parts of two systems.

Natural ventilation uses roof vents on the ridge line with side inlet vents (louvers). Warm air rises on convective currents to escape through the top, drawing cool air in through the sides.

Mechanical ventilation uses an exhaust fan to move air out one end of the greenhouse while outside air enters the other end through motorized inlet louvers. Exhaust fans should be sized to exchange the total volume of air in the greenhouse each minute.

The total volume of air in a medium to large greenhouse can be estimated by multiplying the floor area times 8.0 (the average height of a greenhouse). A small greenhouse (less than 5,000 ft³ in air volume) should have an exhaust-fan capacity estimated by multiplying the floor area by 12.

The capacity of the exhaust fan should be selected at one-eighth of an inch static water pressure. The static pressure rating accounts for air resistance through the louvers, fans, and greenhouse and is usually shown in the fan selection chart.

Ventilation requirements vary with the weather and season. One must decide how much the greenhouse will be used. In summer, 1 to 1½ air volume changes per minute are needed. Small greenhouses need the larger amount. In winter, 20 to 30 percent of one air volume exchange per minute is sufficient for mixing in cool air without chilling the plants.

One single-speed fan cannot meet this criteria. Two single-speed fans are better. A combination of a single-speed fan and a two-speed fan allows three ventilation rates that best satisfy year round needs. A single-stage and a two-stage thermostat are needed to control the operation.

A two-speed motor on low speed delivers about 70 percent of its full capacity. If the two fans have the same capacity rating, then the low-speed fan supplies about 35 percent of the combined total. This rate of ventilation is reasonable for the winter. In spring, the fan operates on high speed. In summer, both fans operate on high speed.

Refer to the earlier example of a small greenhouse. A 16-foot wide by 24-foot long house would need an estimated ft³ per minute (cubic feet per minute; CFM) total capacity; that is, 16x24x12 ft³ per minute. For use all year, select two fans to deliver 2,300 ft³ per minute each, one fan to have two speeds so that the

high speed is 2,300 ft³ per minute. Adding the second fan, the third ventilation rate is the sum of both fans on high speed, or 4,600 ft³ per minute.

Some glass greenhouses are sold with a manual ridge vent, even when a mechanical system is specified. The manual system can be a backup system, but it does not take the place of a motorized louver. Do not take shortcuts in developing an automatic control system.

Cooling ↑

Air movement by ventilation alone may not be adequate in the middle of the summer; the air temperature may need to be lowered with evaporative cooling. Also, the light intensity may be too great for the plants. During the summer, evaporative cooling, shade cloth, or paint may be necessary. Shade materials include roll-up screens of wood or aluminum, vinyl netting, and paint.

Small package evaporative coolers have a fan and evaporative pad in one box to evaporate water, which cools air and increases humidity. Heat is removed from the air to change water from liquid to a vapor. Moist, cooler air enters the greenhouse while heated air passes out through roof vents or exhaust louvers. The evaporative cooler works best when the humidity of the outside air is low. The system can be used without water evaporation to provide the ventilation of the greenhouse. Size the evaporative cooler capacity at 1.0 to 1.5 times the volume of the greenhouse. An alternative system, used in commercial greenhouses, places the pads on the air inlets at one end of the greenhouse and uses the exhaust fans at the other end of the greenhouse to pull the air through the house.

Controllers/Automation

Automatic control is essential to maintain a reasonable environment in the greenhouse. On a winter day with varying amounts of sunlight and clouds, the temperature can fluctuate greatly; close supervision would be required if a manual ventilation system were in use. Therefore, unless close monitoring is possible, both hobbyists and commercial operators should have automated systems with thermostats or other sensors.

Thermostats can be used to control individual units, or a central controller with one temperature sensor can be used. In either case, the sensor or sensors should be shaded from the sun, located about plant height away from the sidewalls, and have constant airflow over them. An aspirated box is suggested; the box houses each sensor and has a small fan that moves greenhouse air through the box and over the sensor (Figure 5). The box should be painted white so it will reflect solar heat and allow accurate readings of the air temperature.

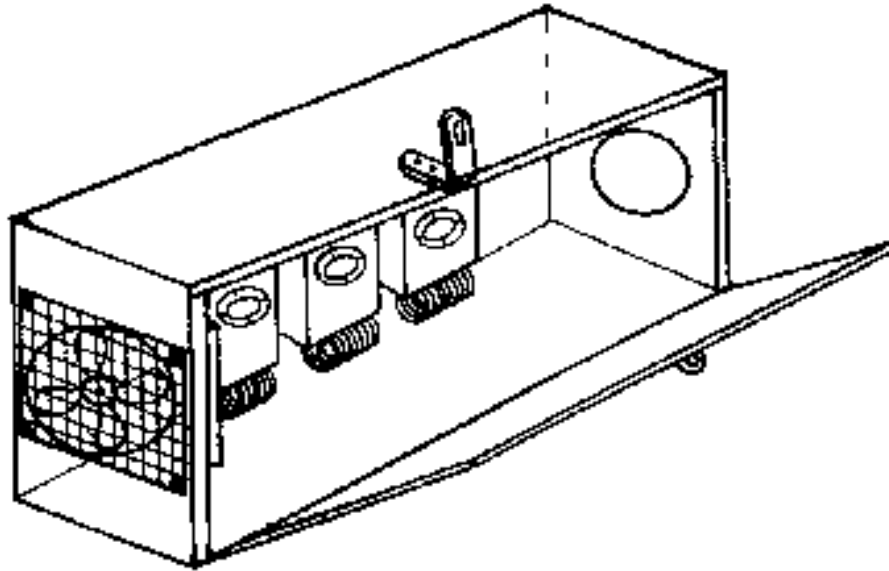

Figure 5. Thermostats in the middle of the greenhouse in a shaded, white, and aspirated box.

Watering Systems

A water supply is essential. Hand watering is acceptable for most greenhouse crops if someone is available when the task needs to be done; however, many hobbyists work away from home during the day. A variety of automatic watering systems is available to help to do the task over short periods of time. Bear in mind, the small greenhouse is likely to have a variety of plant materials, containers, and soil mixes that need different amounts of water.

Time clocks or mechanical evaporation sensors can be used to control automatic watering systems. Mist sprays can be used to create humidity or to moisten seedlings. Watering kits can be obtained to water plants in flats, benches, or pots.

CO₂ and Light

Carbon dioxide (CO₂) and light are essential for plant growth. As the sun rises in the morning to provide light, the plants begin to produce food energy (photosynthesis). The level of CO₂ drops in the greenhouse as it is used by the plants. Ventilation replenishes the CO₂ in the greenhouse. Because CO₂ and light complement each other, electric lighting combined with CO₂ injection are used to increase yields of vegetable and flowering crops. Bottled CO₂, dry ice, and combustion of sulfur-free fuels can be used as CO₂ sources. Commercial greenhouses use such methods.

Alternative Growing Structures

A greenhouse is not always needed for growing plants. Plants can be germinated in one's home in a warm place under fluorescent lamps. The lamps must be close together and not far above the plants.

A cold frame or hotbed can be used outdoors to continue the growth of young seedlings until the weather allows planting in a garden. A hotbed is similar to the cold frame, but it has a source of heat to maintain proper temperatures.

Lighting.

Growing under lights allows plants to be in light 24 hours a day, promoting vigorous growth. Some growers use 18 hours light and 6 hours dark. Many types of lights are available. Agro-type HPS and HMI lights are better for growing in doors and a single 400watt light is easier to handle ten 40watt fluoro lights. However they are expensive and require a control box to fire the globe(\$200 - \$400 for a 400watt globe, reflector and control box.). Fluorescent lighting is also effective, Gro-lux and other Agro-type tubes are available but aren't as powerful. Fluorescent light fitting can be purchased second hand for about \$5 - \$15 for single a 36 watt fitting and \$10A - \$25 for a double 72 watt fitting. New fitting are about twice the maximum cost of second hand unit.

Only one double fitting can grow many plants until they about 2 weeks old. As they grow taller the light is too dim at the sides and bottom of plant, more tubes will be needed to light these parts of the plant. The light from fluoro's needs to be very close to the foliage about 10cm. max., heat may cause burning or curling of the leaves if there touching the tube. If there are 6 large plants they will need 10 or 12 of 36 watt fluorescent tubes.

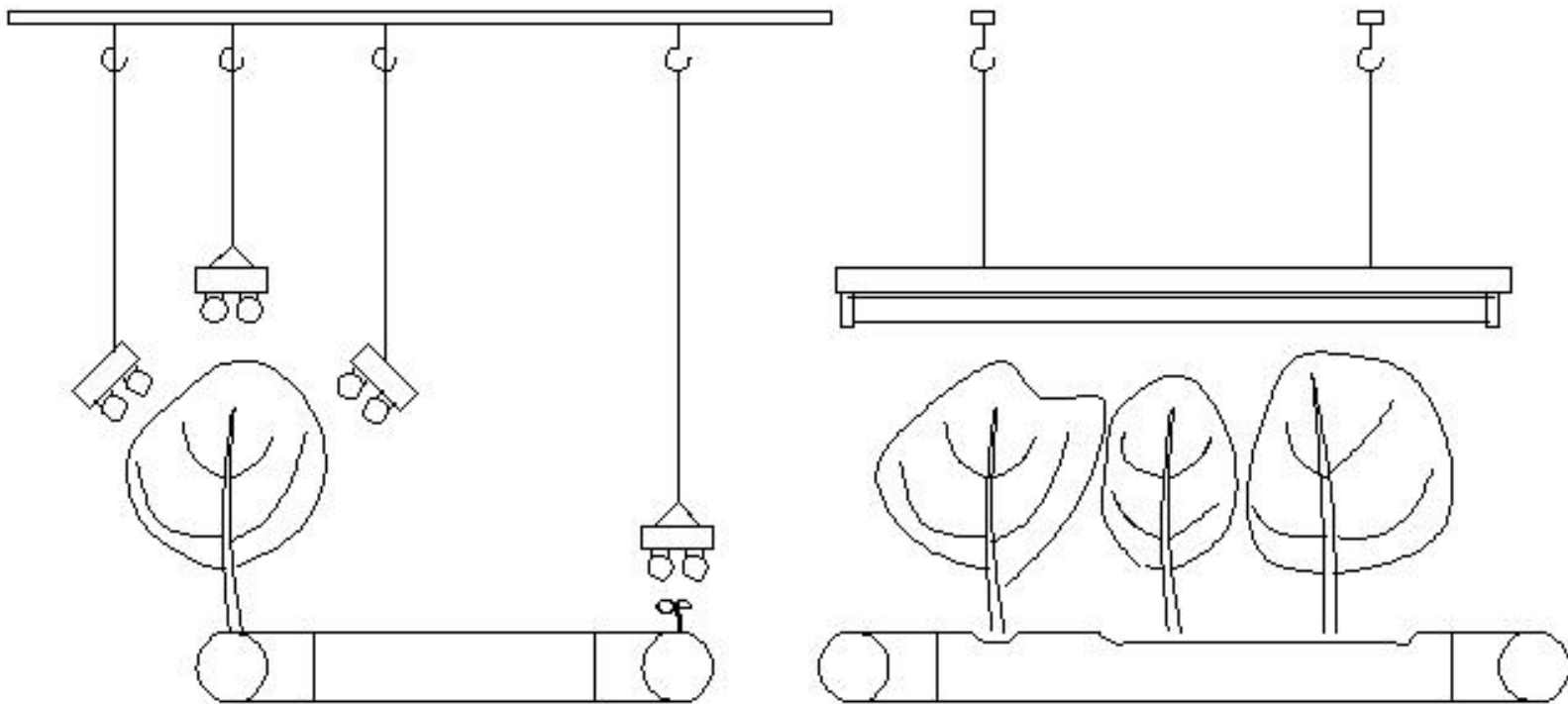

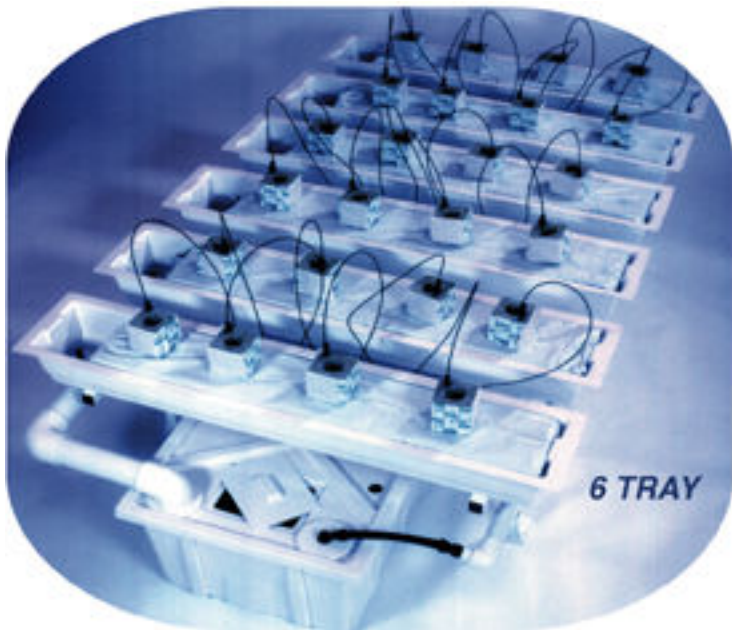

Drip Irrigation - Drip irrigation hydroponic systems are perfect for larger plants that require a good root base and room to spread. These systems are easy to maintain and are very reliable.

Ebb & Flow - Ebb and flow hydroponic systems were the first hydroponic systems to be developed and they are still around today because they work great! Perfect for plants of different sizes and shapes.

Aeroponic Growth - Aeroponic systems grow plants faster than any other we offer. These systems use a nutrient rich mist to deliver food to the plants. Aeroponic systems are perfect for the experienced grower looking to move to the next level.

NFT Systems - These systems are perfect for smaller plants such as Herbs and Lettuce.

Clone Machines- High tech root propagators and cloning solutions.

Manufacturers.

- [ACI-Hydroponics](#)
- [Agri-Growth International Inc.](#)
- [American Agritech](#)
- [Avon Gro-Lite Systems](#)
- [BC Light Manufacturing Inc.](#)
- [Doktor Doom](#)
- [Eco Pager Reporting Systems](#)
- [General Hydroponics](#)
- [Green Air CO2 Products](#)
- [Light Manufacturing Company](#)
- [Nature2, Inc.](#)
- [Rambridge Wholesale Supply](#)
- [Rubicon Products Inc.](#)
- [Technaflora Plant Products Ltd.](#)

- [Western Water Farms/Nutrilife Products](#)

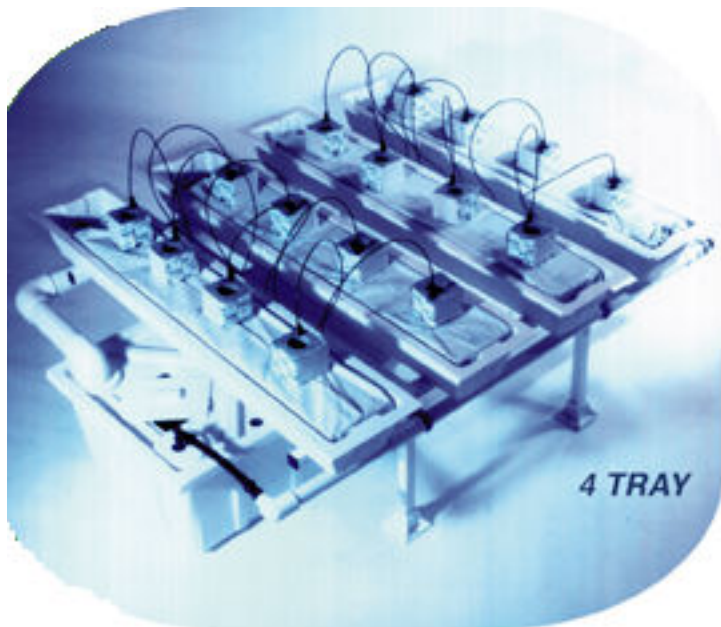

The Jetstream is a commercial quality, recirculating drip irrigation system designed to grow tomatoes, peppers and other crops that require a firm support structure. It uses a rockwool or aggregate growing medium requiring minimum maintenance and offering excellent growth rates and yields. The system comes complete with anodized/white powder coated aluminum bench, 20 gallon reservoir, growtrays, pump, timer, 1" PVC feed line and 2" PVC drain, 4 GPH emitters, stakes, PH control kit, nutrients and rockwool cubes, blocks and slabs. It is available in 2, 4, 6, & 8 tray configurations. Larger sizes available for greenhouse applications.



The WaterFarm (10"x10"x15") is built with high-impact plastic to assure a long lifetime. The unique square design allows you to pack WaterFarms together with close spacing for large installations. You can grow small and medium plants using this system.

Package: 1 Waterfarm growth chamber, pump, nutrient reservoir, grorox (growing medium) and FloraMagic nutrient.

What you need to grow: All you need in addition to this system is a suitable light source. If growing indoors or in a low natural light position please select a **light** from that section of the catalog. A 400w light will support about 4 WaterFarms. Additional **nutrients** are also something that should be purchased along with this unit.



The PowerGrower features an attractive shape based upon a classic stylized Italian clay pot, but with Grorox, growing chamber and air pump to drive the plants into a higher level of growth and yield. It is the perfect choice where performance plus decorative styling are brought together to provide an enhancement for any home, office or classroom setting.

Ebb & Flow Hydroponic Systems.



The MEGAGARDEN (by Hydrofarm) - This is our most cost effective ebb & flow garden. A convenient 24" x 24", the Megagarden can support 15 smaller sized plants. This system has an extra large reservoir for ease of maintenance. All that's needed with this system are **nutrients** and **lighting**.

The Baby Bloomer Complete Set (by American Hydroponics) - This is the *best* set for someone with a limited budget or space. The Baby Bloomer Set is one of the easiest to use and most reliable systems available.

The *complete system* comes with the Baby Bloomer Grow



System, a 250w Metal Halide light, bench and light stand, nutrients, pump, timer, 10 containers and clay aggregate growing medium. It even comes with lettuce & tomato seeds!

The Baby Bloomer fits in a 14" x 35" area. With light stand, bench and legs it stands 5' tall. There is room for 10 medium sized plants such as peppers and even tomatoes.



The JETFLOW Package (by American Agritech) - This is a top of the line ebb & flow system. The JETFLOW comes with an anodized aluminum bench with PVC feed and drain. This professional construction assures performance and reliability and takes all of 25 minutes to assemble. The JETFLOW can expand to a larger system with the snap of a leak-resistant clamp. Systems come in 1-4 tray configurations. The system is perfect for any stage of growth. This system can easily support full sized plants.

1 Tray	44" x 34"
2 Tray	44" x 58"
3 Tray	44" x 82"
4 Tray	44" x 106"



Vegi-Table (by American Hydroponics)

The Vegi-Table is a high performance and versatile piece of garden equipment designed for the serious hydroponic gardener. It is incredibly easy to use even for the beginner.

The Smithsonian Institute in Washington, DC uses the Vegi-Table in their "Where Next, Columbus?" exhibit to simulate growing lettuce in space. Here on Earth you can grow a thriving garden year after year with ease.

Comes with tray, bench, 30 gallon reservoir, hose, fill and drain fittings, pump and timer.

Aeroponic Systems.



The Aerojet (by American Agritech) - Our top of the line aeroponic system is a hydroponic wonder. This system comes in the many easily expandable sizes below. The Aerojet has consistently produced faster growth than any other system we've seen, it is recommended for advanced growers. The Aerojet utilizes 3" net pots, giving root support and plant stability, enabling Aerojet users the flexibility to move plants in and out of the system for individual harvesting. Each system comes complete with an anodized aluminum bench, reservoir, trays, high-output pump. All that is needed to make the system complete are nutrients and lighting.



The AeroFlo2 (by General Hydroponics) - The AeroFlo2 is a true "water culture" system in which plant roots are suspended in a rapidly flowing stream of oxygen-infused nutrient. It is a serious system which will provide remarkable results. The AeroFlo2 is ideal for growing many small plants close together, or large plants farther apart, up to tomato, cucumber and pepper size. The ideal environment is a green house or growroom with proper ventilation and comfortable temperatures and humidity. Greenhouse installations in temperate climates will provide excellent results. For hobby growers, the AeroFlo2 systems are ideal indoors, under high-intensity lighting.

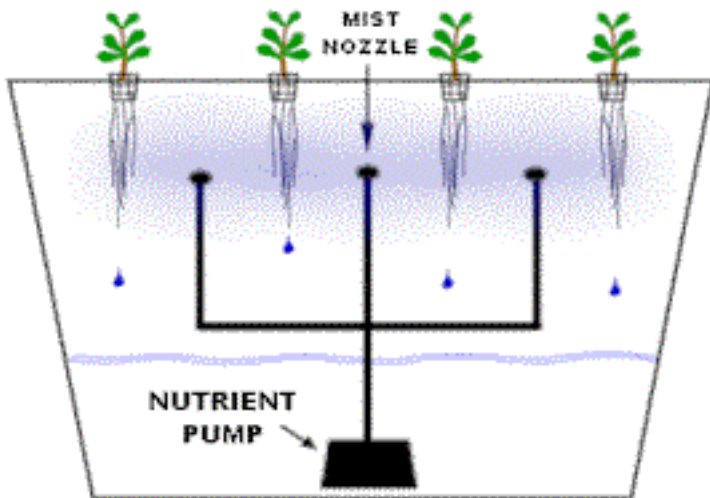

AEROPONIC

The Aeroponic system is probably the most high-tech type of hydroponic gardening. Like the N.F.T. system above the growing medium is primarily air. The roots hang in the air and are misted with nutrient solution. The mistings are usually done every few minutes. Because the roots are exposed to the air like the N.F.T. system, the roots will dry out rapidly if the misting cycles are interrupted. A timer controls the nutrient pump much like other types of hydroponic systems, except the aeroponic system needs a short cycle timer that runs the pump for a few seconds every couple of minutes.

NFT / Film Hydroponic Systems.



The Jetfilm - The Jetfilm is perfect for gardeners who choose to use as little substrate as possible, ideal for lettuce, basil, strawberries, herbs and flowers. The system can be run constantly. The Jetfilm can use clay pellets or small rockwool starting cubes in net pots as the growing substrate. Using the net pots gives root support and plant stability. You can easily harvest individual plants. All that is needed to make the system complete are nutrients and lighting.

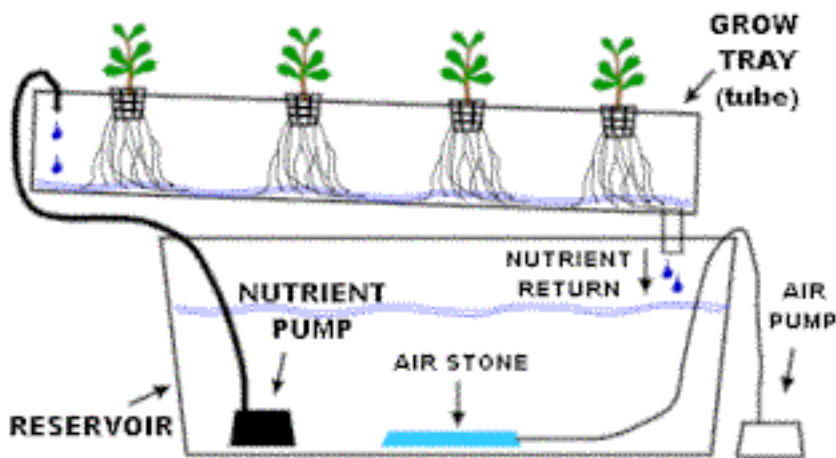

N.F.T.
(Nutrient
Film
Technique)

This is the kind of hydroponic system most people think of when they think about hydroponics. N.F.T. systems have a constant flow of nutrient solution so no timer required for the submersible pump. The nutrient solution is pumped into the growing tray (usually a tube) and flows over the roots of the plants, and then drains back into the reservoir.

There is usually no growing medium used other than air, which saves the expense of replacing the growing medium after every crop. Normally the plant is supported in a small plastic basket with the roots dangling into the nutrient solution.

N.F.T. systems are very susceptible to power outages and pump failures. The roots dry out very rapidly when the flow of nutrient solution is interrupted.

Clone Machine.



The Clone Machine provides the perfect balance of oxygen and nutrient in a self-circulating system. Clones will establish a healthy root mass in 3-10 days in easily transferable 2" netpots. Comes complete with Pump, NetPots, Neoprene Inserts and Mist/Spray Bottle. For time tested, proven results, use the recommended solutions listed below.

Is available for 20, 42, 74 and 154 plant sites.

ACI-Hydroponics

Hydroponic Equipment Manufacturer

Hydroponic gardens, HID grow lights, high pressure sodium, metal halide, light movers, co2 regulators, greenhouses, rockwool, grow rocks, pH test equipment and hydroponic plant food. Aqua Culture, Inc. has supplied hydroponic equipment to growers worldwide since 1982. We are on the cutting edge of technology and are planning to introduce new products in the near future. We run specials on our website, so now would be a good time to file our site in your "favorites".

Freedom Garden - Flood and Drain

The Freedom Garden is a flood and drain system that can grow with your needs. A pump unit can run on it's own or you can add up to five extension unit trays at any time. Each tray is 6ft x 1ft x 1ft. There is a ten gallon reservoir for each tray (on multiple tray systems, the reservoirs are connected together). These gardens are ideal for large plants such as tomatoes, cucumbers, snow peas and chiles.

Features include:

- Pumice rock used as primary medium.
 - Expandable from 1 to 6 trays.
 - Includes pump, timer, pH test kit and all plumbing.
 - Can grow more plants per foot than any other garden on the market.
-
- Pump Unit I
 - Pump Unit II
 - Extension Unit



Net Harvest - Nutrient Film Technique (NFT)

Our newest garden uses the nutrient flow technique (NFT) method of hydroponic gardening. This garden has four 4' x 4.5" x 3" trays. Net pots and Gro-Rock are the perfect combination for any type plant. Comes complete with everything you need to get started. NEW SIZE! Four 6' x 4.5" x 3" trays.

- 9 gallon reservoir with stainless steel float valve and water hook-up kit.
- 3.5" net pots.



- Cycle timer and pump included.
- Adjustable manifold for water depth.
- Stand included.
- Can be mounted on a wall.

- Net Harvest IV (24 pots)
- Net Harvest VI (36 pots)

Net Harvest II

This garden is a great starter garden. Measuring 38" x 24" x 18" This unit is a must for people with limited space. Comes complete.

- 4 gallon reservoir with stainless steel float valve and water hook-up kit.
- Cycle timer and pump included.
- Twelve 3.5" net pots.
- Adjustable manifold for water depth.
- Stand included.



Patio Gardens - Ebb and Flow

Aqua Culture's patio ebb and flow garden can be customized to fit any gardener's needs. The above photos show four different configurations of the same system. Each unit has two 10" x 42" trays and a 9 gallon reservoir. You have the option of using one of two different mediums. This garden can be used indoors, outdoors or in a greenhouse.



- Choice of mediums:
- 8 x 3 rockwool slabs or Gro-Rock.
- 9 gallon reservoir with stainless steel float valve and water hook-up kit.
- Stand is included. (~ 1 ft. in height).
- Comes complete with everything you need.

- Ideal for any size plant.
 - Easy to assemble.
-
- End to End unit - 86" x 10"
 - Corner unit - 54" x 32"
 - Parallel - to 72" x 42"
 - Parallel unit - 40"x 42"
-

Home Pro - NFT

- Scaled down version of system used by large commercial operations.
- 15 gallon reservoir.
- Primary medium - Oasis or rockwool cubes.
- Customize footage and plant spacing for your garden needs.
- Comes as a complete kit.



Brightstar HID Lights - Spectrum

The Brightstar Spectrum uses a polished aluminum spectral wing, not an arched insert like other manufacturers. The double parabolic design eliminates light bounce back onto the bulb, directing the light down. This will give you a larger coverage at 150 degrees from the edges.

The Brightstar Spectrum gives the illusion of three light bulbs, maximizing light distribution to your plants.

White Powder Coated - The Brightstar is also available with a white powder coated interior and exterior. Aqua Culture manufactures complete horizontal light systems, using double parabolic Brightstar reflectors, air cooled ballasts and high quality bulbs. We carry a complete line of replacement bulbs, including conversion bulbs.



Systems:

- 250 watt Metal Halide* - 23,000 lumens - 10,000 hours

- 400 watt Metal Halide* - 40,000 lumens - 20,000 hours
- 1000 watt Metal Halide* - 115,000 lumens - 12,000 hours
- 250 watt High Pressure Sodium - 27,500 lumens - 24,000 hours
- 400 watt High Pressure Sodium - 50,000 lumens - 24,000 hours
- 1000 watt High Pressure Sodium - 140,000 lumens - 24,000 hours
- 430 watt Son Agro** - 53,000 lumens - 16,000 hours

* We use only super output horizontal bulbs.

**Sold only with specific 430 watt ballast.

- Brightstar reflectors are light weight, yet very durable.
- We offer two reflector sizes in your choice of spectral aluminum or white powder coated finish.
- 26" x 17" x 8" - for "1000" watt bulbs
- 20" x 17" x 8" - for "400" watt bulbs
- 250 watt systems have the ballast enclosed in a 26" x 17" x 8" white powder coat reflector. This item can be special ordered with a remote ballast with your choice of our spectral aluminum or powder coated "400" reflector (making this an ideal light for coral reef tanks).
- Aqua Culture's ballast is an aired ventilated box for cooling and is super quiet. They are wired for a standard 110v. We can wire for 240v upon request.
- Our remote ballasts were the first to use a detachable power cord .
- The unique design of our horizontal reflector enables you to convert from a spectral aluminum to a white powder coat or from a "400" size to "1000" size (or vice versus) easily. By purchasing a "wing" you can replace the double parabolic middle piece, altering the size or finish . This will help to customize your lighting needs with any change of location, without a lot of additional expense.



Here are several tips to help when considering purchasing a high intensity discharge (HID) light system:

- There are several types of HID lights.
- Metal Halide (blue/green spectrum)
- High Pressure Sodium (red/orange spectrum)
- Son Agro (orange/red spectrum w/ blue spike)
- The area of your garden will help to determine the wattage of light you will need.
- 250 watts - 3' x 3' primary - 4' x 4' secondary
- 400 watts - 4' x 4' primary - 6' x 6' secondary
- 1000 watts - 6' x 6' primary - 8' x 8' secondary
- The length of area you are trying to light can be extended by using a linear light mover. This can save on the expense of electricity and possible purchase of additional lighting.
- Horizontal light systems are considered to be more efficient than base up models because the most intense light is shining directly on the plant vs. off the reflector.
- The closer the reflector size is to the bulb size, the more intense the light output will be.
- There is very little difference in the actual brand of ballasts and bulbs that are manufactured. The design of the reflector and the ballast box will greatly effect the light's efficiency.

CO2 Regulators - Quality, Function and Design

Aqua Culture's CO2 regulator maintains consistent CO2 levels using only components that are calibrated for CO2. Our compact design offers easy flow meter adjustments, swivel disconnects and the following features:

- CO2 calibrated pressure gauge
- Flow meter calibrated for CO2
- 1500 lb. pressure gauge
- 180 degree view of flow meter setting
- All fittings between components are brass
- Includes 20 ft. emitting tube & 6 ft. lead tubing
- Comes in three flow meter sizes (based on room size)



- HIGH - .08 to 8.0 cfh (for 80 to 800 sq.ft.)
- LOW - .04 to 5.0 cfm (for 40 to 500 sq.ft.)
- MICRO - 0.12 to 1.2 cfh (for 12 to 120 sq.ft.)

CO2 Test kit

- Check the carbon dioxide levels in your garden space
- Comes with two detection tubes
- Additional detection tubes available



Star Trak - Light Movers

Fast for foliage, slow for bloom.

The Star Trak with the built Growth Controller is the best light mover on the market!

With more control options, this mover is "smarter" than any other light mover including Light Rail III.

- Variable speed control - from 1 to 10 rpm.
- Adjustable end stop - dial pause from 0 to 50 seconds.
- Variable distance on a 6 ft track.
- Variable traction.
- Three hanging positions to accommodate for reflector weight.
- Designed to stabilize horizontal light movement.
- 12 volt DC detachable power supply.

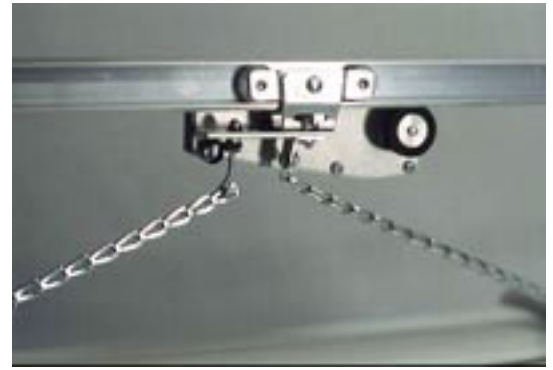

Star Trak Features	Benefits	Compare to Other Tracks
1 to 10 RPM Motor	Travel from 3 to 20 minutes down a 6' track. Faster speed for foliage, slower for bloom development.	Pre-set speed.
12 volt DC power supply	Detachable. Will run in any country without losing RPMs	120 volt power only.
End Pause Control Dial	Set the end pause for 0 to 45 seconds. This will maintain an even plant canopy.	Feature is not offered. Can purchase a pre-set (30 second) delay.
Three Position Traction	Attach the light in one of three positions, based on weight, for ideal traction.	One traction.
Two or Four Hang Chains	To balance horizontal reflectors.	Purchase a light stabilizer.
70 Durometer Drive Wheel	Durable, long lasting rubber.	Rubber "O" ring needs replacing, often enough to include a replacement.
Adjustable End Stops	Use any or all the track.	Adjustable by 1'.
Aluminum Track	Included.	Buy tracks by the case. Some use steel that will rust.
Nylon Bearings	Durable.	Steel ball bearings subject to rust.
Extender	Runs two lights with one motor. Covers up to 18' length.	Not available.
Shipped in UPS Crush Proof Tubes.	Packed complete. Ready to reship to mail order customers.	Pack and repack.

Solar Shuttle - Light Movers

The Solar Shuttle is the original light mover on the market. We have a patented sprocket end pause (30 seconds) and a steel ball bearing drive shaft for long life. There are copies out there, like Hydrofarm's light track, but this is the best chain drive light mover.



- Chain driven mover
 - Durable components
 - 30 sec pause delay at each end
 - Available in 6 ft or 4 ft length
 - An extender is available to run two lights with one motor.
-
- Solar Shuttle 6ft.
 - Solar Shuttle 4ft.

Plant Food - Nutrients

Granular formulas: One part formulas. Add a teaspoon per gallon directly into your reservoir.

- All Purpose 16-12-16
- Foliage Developer 20-6-16
- Bloom Developer 9-21-12
- 8 ounce (makes 50 gallons)
- 5 pounds (makes 500 gallons)
- 25 pounds (makes 2500 gallons)



Aqua Culture, Inc.

1325 S. Park Lane Suite #1

Tempe, AZ 85281

For a dealer near you or to order call: 1-800-633-2137

Website: <http://www.aci-hydroponics.com>

Agri-Growth International Inc.

Nitrozyme

Nitrozyme is a plant extract which is quality controlled for particular growth hormones. To name a few - Cytokinins - Auxins - Enzymes - Giberellins - Ethylenes - plus many Micro-nutrients.



HOW IS THE CYTOKININ HORMONE LEVEL CONTROLLED?

Nitrozyme is produced using the strictest quality control methods possible. The test used to determine hormonal activity is state-of-the-art and approved by Government Regulators.

WHAT IS THE PLANT THAT NITROZYME IS MADE OF?

The plant from which it is extracted is Ascophyllum Nodosum and is found in the Northern Atlantic Ocean and the Norwegian Sea. This plant grows on rocks in sea water, which is as cold as -20°C in the winter and as warm as 32°C in the summer months.

HOW DOES NITROZYME WORK?

Plants progress through a cycle of growth stages. Using the example of wheat, the plant starts out as a seed, germinates, goes through the seedling stage, through the three, five and seven leaf stages, and finally forming a head and producing new seed.

When a plant is under stress at any given stage of growth, reduced levels of cytokinin growth hormones are produced. If this reduction occurs at certain key stages of growth such as the tillering stage, yields can be affected.

By making available extra hormone to the plant at these stages, you can influence the crops final yield.

Growth Plus

Growth Plus is a plant extract which is quality controlled for particular growth hormones. To name a few - Cytokinins - Auxins - Enzymes - Giberellins - Ethylenes - plus many Micro-nutrients.

HOW IS THE CYTOKININ HORMONE LEVEL CONTROLLED?

Growth Plus is produced using the strictest quality control methods possible. The test used to determine hormonal activity is state-of-the-art and approved by Government Regulators.



WHAT IS THE PLANT THAT GROWTH PLUS IS MADE OF?

The plant from which it is extracted is Ascophyllum Nodosum and is found in the Northern Atlantic Ocean and the Norwegian Sea. This plant grows on rocks in sea water, which is as cold as -20°C in the winter and as warm as 32°C in the summer months.

HOW DOES GROWTH PLUS WORK?

Plants progress through a cycle of growth stages. Using the example of wheat, the plant starts out as a seed, germinates, goes through the seedling stage, through the three, five and seven leaf stages, and finally forming a head and producing new seed.

When a plant is under stress at any given stage of growth, reduced levels of cytokinin growth hormones are produced. If this reduction occurs at certain key stages of growth such as the tillering stage, yields can be affected.

By making available extra hormone to the plant at these stages, you can influence the crops final yield.

Auto Pot Hydro-Pak Systems

The hydroponics system that automatically makes you an expert. The only hydroponic system that can be left unattended for weeks.

- No Batteries
- No Pumps
- No Power
- No Problems



If you are intimidated by the technology necessary for other Hydroponic Systems, then the Auto Pot Hydro-Pak System may be the one for you. The Auto Pot system uses the same principles of standard hydroponics, but is simpler to use as it does not involve any electrical components. This does not reduce its effectiveness however, as the Auto Pot Hydro-Pak Kit produces outstanding results for a very large variety of plants and is used successfully by commercial as well as home growers. For you this means, outstanding results with less cost!

Fairy Ring Blaster

This multipurpose completely water soluble product destroys the fungus in the soil which produces the fairy rings (mushrooms). It will not harm your grass. You do not have to pick the mushrooms - they dry up.

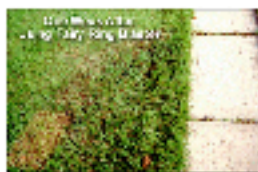

A healthy lawn requires proper nutrients - not just N.P.K. Fertilizer. It requires minerals, nutrients & bio-stimulants. If your lawn has weeds, fairy rings and other problems - the underlying problem is a lack of proper nutrients. Our product, Seasons Lawn Fertilizer contains 70 nutrients that a healthy lawn requires.

Fish Agra

Features and Benefits

- Effective when plant is under stress.
- Proven to increase antioxidant (SOD) activity.
- Natural chelating agent.
- Provides slow release of nitrogen for 15 weeks.
- Compatible with most fungicides, insecticides and herbicides.
- Blended to produce active high energy soils.
- Filtered for easy spray or use in fertigation system.
- Increases cation exchange capacity.
- Increases plant cell membrane permeability.
- Turns on chlorophyllase.
- Compatible with most fertilizers, pesticides, herbicides, and fungicides.



- 100% soluble, sprayable, screened through #80 mesh.

Hyper Oxygen (Quantifix)

Quantifix

Peroxide 100

100 Test sticks Quantifix for semiquantitative determination of peroxide (1-100 mg/l H₂O₂)



Please read package insert. Store below +30°C in a dry place. Reseal the container immediately after use.

Comes in sizes: 1 Litre to 210 Litres (45 gallon drum)

Insect Stop - Diatomaceous Earth

100% NATURAL SILICON DIOXIDE

At long last a safe, harmless and very effective insecticide that eliminates insects is available. No longer is it necessary to use toxic poisons to control these pests. The use of INSECT STOP kills insects physically and is non-chemical.



* * INSECTS CANNOT BUILD UP A TOLERANCE OR RESISTANCE TO IT.

INSECT STOP REMAINS ACTIVE FOREVER. (unless it is washed away or cleaned up)

INSECT STOP is a proven insect controller, repellent and killer of earwigs, ants, cockroaches, spiders, beetles, silverfish, bedbugs, fleas and grain insects, to name only a few. It is an all year round insecticide.

What is Diatomaceous Earth? How does it work?

It is a non-toxic, safe substance made up from crushed fossils of freshwater organisms and marine life. Crushed to a fine powder and observed through a microscope, the particles resemble bits of broken glass. Deadly to any insect and completely harmless to animals, fish, fowl or food. Most insects have a waxy outer shell covering their bodies, INSECT STOP scratches through this shell causing the insect to dehydrate leading to eventual death.

INSECT STOP has a list of attractants on its label enabling you to attract a wider range of

insects which may not be otherwise attracted to a specific bait already added to prepackaged products. For example, ants desire sweet baits while certain cockroaches tend to be more attracted to starch products. INSECT STOP gives you the choice. However, 90 percent of applications do not require attractants.

Soluble Kelp Powder 1 – 4 – 14 (NPK)

Approved for Organic Agriculture

Soluble Kelp Powder is a dehydrated liquid extract from the kelp *Ascophyllum nodosum*, which is harvested on the Maine coast. The purpose of this product is to provide plant hormones and micronutrients to your crops. These compounds are known to accelerate growth, increase fruiting and flowering, and intensify coloration, and provide resistance to disease, insects and frost.

Benefits of Kelp Powder:

- Improved seed germination and thicker root development (mitosis).
- Increased bloom set and increased size of flowers and fruit.
- Increases and stabilizes chlorophyll in plants, which results in photosynthesis, darker green leaves and increased sugar content in plants.
- Relieves stress in plants caused by extreme weather conditions.
- Increased plant vigor, thus a greater resistance to disease, insect attack and frost. This is a result of increased protein, Ribonucleic Acid (RNA) and Deoxyribonucleic Acid (DNA) content of plants.
- Increased micro-organisms in the soil, which can fix nitrogen from the air.

- Increased mineral uptake from the soil and into the plant's leaves.
- Increases the storage life of fruits and vegetables by retarding the loss of protein, chlorophyll and RNA in produce.
- Retards the aging process in plants (senescence), keeping them producing longer.
- Many of the trace minerals contained in kelp have important regulatory functions in plants, and in the animals and humans that consume the plants.

Liquid Kelp

Liquid Kelp contains many micronutrients and bio-stimulants which all plants require for health-vigorous growth.

Organic - Natural - Non Toxic
Plant Food For All Indoor and Outdoor Plants



Liquid Kelp contains many micronutrients and bio-stimulants which all plants require for health-vigorous growth.

Use **Liquid Kelp** with confidence on all indoor and outdoor plants, excellent for gardens, vegetables, fruit trees and lawns.

Liquid Kelp is an excellent growth supplement to your regular plant feeding program.

Guaranteed Minimum Analysis

^^

Nitrogen (N)	0.1
Phosphoric Acid(P ₂ O ₅)	0.1
Soluble Potash (K ₂ O)	1.0
Cytokinin	100 ppm
Source: Ascophyllum Nodosum	^^

Myco Net - Biological Inoculum

Agricultural Applications for VA Mycorrhizal Inoculum

Current agricultural practices can severely affect populations of beneficial soil micro organisms. Intensive tillage and soil fumigation kill or limit the activity of many pests, however, most of the root growth promoting bacteria and fungi are also destroyed in the process. Many of these agents and mycorrhizae in particular are known to perform valuable functions that increase yield and reduce pathogen activity.



Function of Mycorrhizae

The symbiotic or interdependent relationship between mycorrhizae (*myco=fungus, rhizae=roots*) and host plants is probably the oldest known relationship between two living species. Mycorrhizae attach to and coat the surface of roots, drawing food in the form of carbon from the host. These fungi, in return grow outward like a sponge absorbing and supplying moisture and nutrients to the plant. Without the presence of mycorrhizae, many arid regions of the world that support viable ecosystems would be void of any vegetation.

Benefits of Mycorrhizae in Agricultural Crops

The primary benefits of mycorrhizal colonization in crops was originally perceived to be an improved utilization of phosphorus, particularly in phosphorus fixing soils. Recent studies however, have shown that in addition to this function:

- Mycorrhizae can reduce moisture stress because of greater root development.
- Improve soil texture through aggregation.
- Reduce attack from soil pathogens by producing a protective shield on the surface of the roots.
- Act as a conduit for other beneficial soil organisms that aid in nutrient mineralization and perform predatory functions against pathogens.

Crops Responding to Inoculation

Many high value crops such as grapes, citrus, olive, stone fruit, strawberries, ginseng, tomatoes and peppers are key candidates for inoculating with **Endo Net Mycorrhizae**. In addition, several commonly grown food and ornamental crops can benefit from the treatment. The attached list identifies the major species that form VA Mycorrhizal associations.

Benefits of Inoculation with Endo Net Mycorrhizae

- Reduced fertilization costs
- Improved utilization of soil moisture
- Earlier flowering and fruit formation
- Increased yield potential
- Insurance against disease

Nutri-Max

Plant Starter Paks Slow Release Fertilizer plus Water Storing Polymers, Cytokinin, Humic Acid & Vitamin B1



PRODUCT DESCRIPTION

Organic - Natural - Non Toxic - Teabag Packets

A premeasured biodegradable packet containing:

- Polymer Coated Slow Release Fertilizer
- Water Storing Super Absorbent Polymers
- Plant Biostimulants including Humic Acid & Vitamin B1

APPLICATIONS

NUTRI-MAX are applied at "Time of Planting" to most Herbaceous and Woody Plants.

- Establishment of New Orchards, Vines and Small Fruit Plants.
- New Landscape Construction
- Container Grown Plants
- All new plantings subject to irregular irrigation or dependent on rainfall for moisture supply.

BENEFITS

NUTRI-MAX are a simple "Time of planting" Treatment that provides:

- A Long Term Nutrient Supply.
- A Temporary Moisture Reserve to Reduce Planting Stress.
- BioStimulants promote Nutrient & Moisture Uptake by the Plant and encourage the development of populations of Beneficial Micro Organisms.

Sea Mix

SEA MIX Improves the health, vitality and yield of house and garden plants by supplying vital micronutrients from SEAWEED harvested from coastal waters of the northern Atlantic Ocean.



FISH & SEA PLANT LIQUID FERTILIZER

3 - 2 - 2

SEA MIX Improves the health, vitality and yield of house and garden plants by supplying vital micronutrients from **SEAWEED** harvested from coastal waters of the northern Atlantic Ocean. The species of *Ascophyllum Nodosum* which we harvest is very high in natural compounds which the sea plant manufactures for its own survival. These compounds are

then combined with sea fish rich with macro-nutrients, a natural source of nitrogen, phosphorus and potash.

Available in the following sizes:

- 1 Litre * 1.2 KG
- 4 Litre * 4.8 KG
- 19 Litre * 22.8 KG

Seasons Lawn Fertilizer

Natural Organic Fertilizer for Lawns, Gardens & Turf

"Seasons" Lawn Fertilizer

6 - 2 - 4

Covers up to 460m (5000 sq.ft.)

"**Seasons**" natural organic lawn fertilizer is derived from 99.9% natural organic recycled material. "**Seasons**" patented process "Thermophilic Aerobic Digestion" helps retain the high nutrient value your lawn turf requires. "**Seasons**" organic lawn fertilizer provides the necessary soil microbial activity for thatch control, steady turf growth and root formation. "**Seasons**" organic lawn fertilizer is easy to apply with existing fertilizer spreaders or by hand. Make your lawn environmentally friendly for personal enjoyment and to help improve the environment as a whole.

"**Seasons**" organic lawn fertilizer was developed as an economic alternative to synthetic lawn fertilizers. Perfected to increase the strength and health of your turf grasses. "**Seasons**" Organic lawn fertilizer encourages a stronger, deeper root structure, natural thatch control, drought-resistance, improved disease and pest resistance.

Soil Blaster

CALCIUM PEROXIDE -- A NATURAL APPROACH TO SOLVING CONTAMINATED SOIL PROBLEMS

SOIL BLASTER is a time-release supplier of Oxygen designed to be mixed with soil giving you a healthier, more disease resistant soil. **SOIL BLASTER** restores a healthy balance of aerobic bacteria vs. anaerobic bacteria and controls the spread of harmful viruses.

SOIL BLASTER breathes more life into your soil and plants by:

- Increased total soil microbial population. About twice that of tilled soil.
- Improves the soil's hydraulic conductivity which permits more efficient movement of nutrients and oxygen through soil (particularly important to heavy soils).
- Increased microbial species and enzymatic diversity.
- Speeding biological activity and aerobic activity under high-moisture conditions.

- Giving plants the ability to absorb more nutrients and water and utilize them more efficiently.
- Protecting seeds and increasing germination.
- Protecting and maintaining healthy plant root systems.

SOIL BLASTER provides long-lasting, control-released microbial oxygen up to 6 weeks depending on:

- Soil Blaster concentration.
- Soil pH.
- Soil moisture level.

Willard Water

Dr. Willard's 100% Organic Earth Food

Earth Food is a quick-acting yet gentle, 100% organic plant food that will immediately improve plant growth, durability, disease tolerance, and restore all-important organic matter to the soil.



Mix concentrated Earth Food with water for use on house plants, lawns, gardens, trees and shrubs.

Contact herb@agriorganics.com or visit the Agri-Growth International Inc. website at <http://www.agriorganics.com>, for more information

[American Agritech](#)

Ascend

ASCEND is a beneficial natural soil or soiless root inoculant. ASCEND populates plants root systems forming secondary roots. This second growth allows for greater nutrient and water uptake. ASCEND also helps keep competitive and detrimental root pathogens (pytheum, fusarium) at bay, creating a natural biological ecosystem in the root zone. ASCEND promotes vigorous root and vegetative growth in the early stages of the plant and helps in disease resistance.



Apply to newly rooted seedlings and cuttings. ASCEND is also used in cutting solutions. Available in one gram, five grams, and one ounce packages.

Bio-Humic

This Leonardite Ore extraction is a high quality and very concentrated Humic Acid. Plant acids play a role in stimulating Microbial activity; helping in the process of breaking down minerals into a more soluble form. The advantage of this process is the increased uptake of water and minerals to the plants.



Bio-Humic Acid also aids in the enlargement of the root system, helping to rebuild dead soil, brining back a rich Humus, and promoting the breakdown of organic matter into useable plant nutrients.

Cal-Mag

Cal-Mag Plus is a custom blend of Calcium complex with Nitrate Nitrogen and a highly soluble amount of chelated Magnesium; this combination helps to stop blossom end rot in tomatoes and to help prevent deficiencies in Calcium and Magnesium. This formula is to be used as a supplement for standard nutrient formulations, but can be used as a Foliar application after fruit set. Cal-Mag Plus also contains a catalyst, Gold Label Reactant, which increase the cation exchange capacity and provides for increased water and nutrient uptake.



Profoliar

This Profoliar feeder is unique in that the Nitrogen source is a slow release. Organic Nitrogen (Triazone) allows a more controlled feeding application, without a burning effect to the plant. This is achieved through a closed chain molecule formulation which provides for the slow release abilities (up to 90 days). This product allows for up to 5 to 10 times the amount of Nitrogen application to the plants, without burning, over other forms of Nitrogen.



American Agritech's Profoliar also contains high levels of Seakelp as part of this powerful formulation. These high levels of Seakelp contain vast amounts of trace elements, natural growth hormones, cytokinens, auxins, and gibberilins; the combination of these elements provide for more compact plants and larger flower and fruit sets.

Another advantage of the high levels of Seakelp is the presence of Amino Acids, enzymes, and vitamins. These

items help with cell division, and disease and drought resistance within the plant.

Aerojet

The AeroJet is a true aeroponic gardening system and is the most advanced aeroponic system on the international market. Hard-lined, internal plumbing contains eight microjet sprayers within each tray. Three inch neoprene pots with neoprene inserts are utilized with the AeroJet. Each grow tray is eight inches wide by 42 inches in length, with a removable lid for ease in cleaning and maintenance. All components are professionally fitted with a no leak fit. Each AeroJet comes with the Hydroflex Expansion Adapter for extra modules to be added by unplugging Hydroflex and slipping on the new module.



The AeroJet is powered by a high pressure pump enabling the grower to give the root system a super oxygenated environment. To properly use the AeroJet, the gardener must also use a sequence timer. The timer controls the sequential blast of nutrient solution, insuring the oxygen content is optimum. These blasts also reduce the build up of heat in the reservoir. Each AeroJet also comes with the custom designed Multi-Res Reservoir.

We recommend the Custom Automated Product Timer ART II or NFT I. With American Agritech's upgraded bench delivery and drainage module, constructed of powder coated, anodized aluminum frame and steel three-way connectors, the user is insured of an industrial strength hydroponic system. The AeroJet can also be equipped with the optional light stand that mounts directly on to the bench module.

Clone Machines

American Agritech has designed these machines to be low budget and practical. The Clone 20 and Clone 42 are ideal for rooting cuttings where no Humidity Dome or high output pump is necessary. American Agritech recommends a Maxi Jet 1000 for the Clone 20 and for the Clone 42. Each machine contains a true aeroponic mist application (to ensure the best rooting and aeration to achieve the best rooting results).



Simply dip the cutting in your choice of cloning Hormone, place cutting in the neoprene insert and place in the 2" pot (all pots and neoprene inserts included in the Clone Machine price). Operate the machine for 24 hour periods until roots appear (3 to 10 days). Upon notice of ample rooting, transplant your cutting into any substrate desired.

The Clone Machines work best with 18-24 hours of Fluorescent lighting at 3 to 4 feet away to keep plant transpiration at a minimum. American Agritech suggests that you mist leaves one to two times daily. For best results, American Agritech suggests you use Olivias Cloning solution in the clone machine reservoir. American Agritech also recommends the use of a fungicide in the solution to reduce stem rot.

Econojet

American Agritech created the EconoJet Series for the gardener who wants a smaller hydroponic application; where expandability is not a concern. This system was also designed with the budget conscience person in mind without having to sacrifice quality or structural integrity.

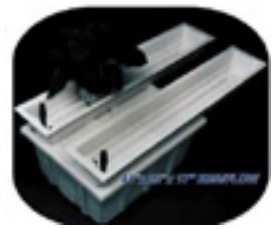

American Agritech has attached two 44" x 6" x 4" trays to the lid of our 20 gallon Multi-Res Reservoir. With this design, you still have the access port, as all Multi-Res reservoirs do; to alleviate having to remove the entire reservoir lid. This system also includes our unique double gasket seal and our feed, drain and overflow fittings (with the particle filters included). These trays will hold two 6" wide slabs of Rockwool or Florafoam substrates. This system will also accommodate twelve 6" square pots (must be purchased separately) using expanded clay pebbles. Trays are equipped with raised platforms to keep the grow substrate out of the nutrient solution channels and to provide ample aeration to the root zone. Available in Ebb & Flow or Drip Method.

EconoMini Jet Flow

The EconoMini Jet Flow by American Agritech, was designed to keep costs at a minimum without sacrificing quality or structural integrity. This mini system is an Ebb & Flow flood system that is attached to the lid of our 20 gallon Multi-Res reservoir. This system is ideal for smaller hydroponic applications where expandability is not of concern.



This system tray contains an extra raised platform to keep the grow substrate out of the nutrient solution channels and to provide ample aeration to the root zone. The tray is 7" deep and is ideal for expanded clay pebble applications, due to its deep flooding capability. Rockwool and Florafoam applications also work well in this system. Once again the fittings have American Agritech's unique double gasket and particle filter system to prevent leaking or clogging of debris.

Jetfilm

The JetFilm is a high performance Nutrient Film Technique (NFT). The oxygen rich, nutrient solution runs along the bottom of the trays in shallow channels. Ideal for lettuce, strawberries, herbs and flowers, the JetFilm is the easiest and most reliable NFT system on the market.



The JetFilm utilizes two, three or four inch net pots, depending on the grower's particular crop application. Pots are filled with expanded clay pebbles for plant stability and a suitable environment for hydro-organic fertilizers. For growers using inorganic nutrients, neoprene inserts are used with the net pots, providing a collar for plant support and to block out algae growth within the trays.

Jetflow

The JetFlow is a modular ebb and flow system, utilizing the 44" x 24" x 7" inch trays, placed on the bench delivery and drainage module. The JetFlow is ideal for rooting cuttings, germinating seedlings, and vegetating young plants. For rooting cuttings, use the optional "Humidome" and rockwool cubes. After cuttings are rooted, remove the dome and transplant cuttings into larger rockwool propagation blocks and vegetate under 18 - 24 hours of light. Plants can be grown to full term in the Jetflow or used in



conjunction with the JetStream Systems. When a larger system is desired, unplug the Hydroflex Expansion Adapter and slip on a new expansion bench module. For added water volume, add an additional Multi-Res Reservoir and join the two together with our unique, no leak, bulkhead fittings.

JetStream Mini

The JetStream Mini is similar to its forebearer, the Jet Stream, except the grow trays are only 24 inches in length. This system is ideal for areas limited in space. These trays are 24 inches long by eight inches in width. Trays are also available with an optional lid that holds two, six inch square pots.



The JetStream Mini utilizes the Multi-Res ten gallon reservoir that compactly sits beneath the bench delivery and drainage module. The JetStream Mini contains professional hydroponic components that only commercial growers utilize. Perfect for the gardener who is starting out small and wants the flexibility to expand into a larger hydroponic configuration.

JetStream

The JetStream is American Agritech's most popular modular hydroponic system. The JetStream was designed to grow tomatoes, cucumbers, peppers, herbs and flower crops. Any preferred grow substrate can be utilized with the Jet Stream: Rockwool, Florafoam, polyurethane grow slabs, or pots filled with grow rock or perlite. This system is popular with small commercial growers, as well as hobbyists, schools, and for research use.



The JetStream has a top watering drip method using four G.P.H. Stream emitters. Trays come equipped with a double gasket seal drain fitting and users can install a stand off to adjust the solution level in the tray (ideal for flooding the slabs for periodic leaching of salts). The JetStream can handle high volumes of water due to the two inch drain. Users can be assured of no drain backups or overflows. Trays may be selected of either six or eight inch wide grow trays of high impact plastic. All JetStream Systems come with durable, no leak spinlock fittings; no clamps necessary.

24" x 8" x 4" Trays

American Agritech's 24" x 8" x 4" mini grow tray is perfect for limited space areas. This tray holds one half of an 8" slab of Rockwool or Florafoam (polyurethane) substrate. American Agritech also provides a lid that holds two 6" square pots (must be purchased separately); ideal for using expanded clay pebbles or perlite.



Our mini grow tray also boasts raised platforms to keep the grow medium out of the solution channels and supply ample aeration (oxygen) to the root zone. Each end of this tray is outfitted to accommodate feed and drain fittings.

The plumbed versions of our mini grow tray is equipped with Ebb & Flow fittings to provide American Agritech gardeners with a ready equipped hydroponics tray.

42" x 8" x 4" Trays

This tray was designed with versatility in mind. This grow tray has the ability to hold 36" x 8" slabs of Rockwool or Florafoam (polyurethane) substrate giving the American Agritech gardener excellent project flexibility.



Our 42" tray has a raised platform to keep the substrate out of the solution channels, and to provide ample aeration to the root zone. This tray was designed with extra length on each end to accommodate the ability to add drain fittings at one or both ends.

These plumbed trays are fully equipped with microJets to supply a true aeroponic application. Simply hook up a high pressure pump. American Agritech recommends operating pump on interval cycles for increased aeration and to keep reservoir temperatures to a minimum.

American Agritech gardeners can use this aeroponic plumbed tray to build their own aeroponic garden for experimental purposes or to root cuttings.

44" x 24" x 7" Propagation Trays

American Agritech designed this deep propagation tray to be versatile in application. Rockwool, Florafoam, or expanded clay pebbles can be used due to the 7" depth, to allow for deep flooding. This tray was designed to accommodate four true 6" wide slabs of substrate and has allowances on each end and both sides to accommodate feed and/or drain fittings. You will no longer have to try to squeeze four slab substrate or settle for three slabs when you use American Agritech's line of Propagation trays.



This tray contains a raised platform to keep the grow substrate out of the solution channels and to provide ample aeration to the root zone, and provide for better drainage to prevent root blockage.

American Agritech has taken its two most popular propagation trays and equipped them with Ebb & Flow fittings. These trays are ideal for the gardener who needs a ready made tray, but does not need a full Hydroponic system. Each tray contains all of the same features found in the regular propagation trays; we have added our unique double gasket fittings to provide no leak usage. The feed and drain fittings also contain a particle filter to prevent clogging from any debris.

44" x 6" x 4" Trays

American Agritech designed this tray for versatility in use to allow for more project flexibility. Each tray interior holds 36" x 6" slab of Rockwool or Florafoam (polyurethane) substrate, or six 6" square pots (must be purchased separately).



This tray was designed with extra length on each end to accommodate the ability to add drain fittings at one or both ends. The bottom surface has an extra raised platform to keep the grow substrate out of the solution and to provide ample aeration to the root zone.

This tray also comes with an optional lid pre-drilled to fit eight 3" net pots. For an additional fee, these lids can be custom drilled to accommodate four 6" net pots, thirty five 2" net pots, or any other configuration you may desire; all pots must be purchased separately.

48" x 4" x 3" Trays

American Agritech's NFT troughs have specially designed end caps and seals using NO glue or silicone. This design accommodates easy removal of end caps to allow for routine cleaning and maintenance of your system. Gullies are UV treated to allow for outdoor and long term applications.



These troughs are outfitted with drain fittings which have double gasket seals to insure a no-leak fit. The gullies are also pre-drilled with two 1/4" holes at the opposite end cap for easy installation of feed tubing.

The NFT tray includes the lid, which is pre-drilled to accommodate six 2" pots. These lids can also be drilled to accommodate six 3" net pots, upon request (no extra charge). For an additional fee, these lids can be custom drilled to meet any customer specification.

Avon Gro-Lite Systems

Horticultural lighting & control systems manufacturers to the UK hydroponics industry

Avon Gro-Lite Systems have been manufacturing horticultural lighting at their Bristol factory since 1992 ,and have manufactured lighting for some of the biggest names on the UK hydroponics scene today.

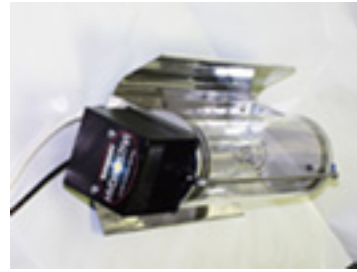

Our continuing program of research into new products ,while constant development and upgrading of existing products we believe makes us one of the leading manufacturers of horticultural lighting in the UK today.

Contact philb@gro-lite.co.uk or visit the Avon Gro-Lite Systems website at <http://www.gro-lite.co.uk>, for more information.

BC Light Manufacturing Inc.

BC Light Manufacturing Inc. is a leader in the research, design and production of state-of-the-art High Intensity Discharge (HID) light fixtures.

We continually strive to bring the latest in energy efficient lighting technology to the international marketplace and to provide innovative solutions for the intensive lighting requirements of the horticultural, industrial and commercial sectors, as well as all other HID artificial lighting applications.

In every aspect of BC Light's operations we take pride in making a positive contribution to environmental impact issues. This is reflected in our near zero waste manufacturing processes, the use of recycled and recyclable material whenever possible, simplified packaging and labeling and the manufacturing of products that are made to last.

BC Light takes pride in contributing significantly to improving the quality of artificial light for any and all applications that would benefit from the use of our fixtures. The technologies which are applied to the design and manufacture of our lighting products will, on average, reduce electricity consumption by two-thirds. Right: Pepper plants grown under BC Light fixtures are healthier and stronger.

All of BC Light's products are Canadian Standards Association (CSA) and Underwriter Laboratories (UL) listed. We are an ISO 9001 registered manufacturer, ensuring that the company continues to meet the highest possible global and industry standards.

Look to our product line as a cost-effective solution for your HID lighting needs. Currently in use around the world, BC Light fixtures are used in applications as varied as the mind can imagine.

Here are just a few examples:

- Airport hangers (Canada)
- Automotive Plants (Australia)
- Factories (Australia, Canada, Philippines)
- Gas Stations (Canada)
- Greenhouses (Australia, Canada, Holland, United States)
- Pavilions (Australia)
- School Gymnasiums (Canada)
- Warehouses (Australia, Canada, Philippines)

The LR Model Shades

Models Available:

- LR 1000
naturally aspirated with strategic heat louvers
- LR MV 1000
mechanically vented complete with tempered glass, support kit, 4" duct connectors
- LR 400
naturally aspirated with strategic heat louvers



- LR MV 400
mechanically vented complete with tempered glass, support kit, 4" duct connectors

Contact info@bclight.com or visit the BC Light Manufacturing Inc.

website at <http://www.bclight.com>, for more information.

DOKTOR DOOM - The "Total Release" Aerosol Fumigator/Fogger"

Kills and Repels - Spidermites, Whiteflies, Thrips, Aphids, Spiders, Wasps, Hornets, Yellowjackets, Ants, Cockroaches, Flies, Fleas, Mosquitoes, Moths, Beetles, Ticks, Silverfish, Mites, Catpillars, Lice and over 200 other crawling and flying insects.

For Use In - Greenhouses, Atriums, Homes, Basements, Offices, Cabins, R.V.'s, Tents, Boats, Garages, Resorts, Schools, Hotels, Motels, Hospitals, Storage Sheds, Disposal Bins, Chicken Coups, Barns, Stables, Tack Rooms, Silos, Attics, Lofts, and many other areas.



One can will fumigate over 5,000 Cu. Ft. (25' x 25' x 8' Ceiling)

- Natural Pyrethrum
- No Artificial Fragrances
- Extra Dry Formula (Reduced Mineral Oils)
- Neutral PH Balanced
- No Scented Oils
- No Residuals



Pyrethrum - A broad spectrum non-systemic botanical insecticide that causes paralysis initially, with death of the insect thereafter. Pyrethrum is very toxic to insects.

Applied as a spray, pyrethrum is very effective to control crawling and flying insects. Pyrethrum is non-toxic to animals or humans. Natural pyrethrum degrades quickly in sunlight and (HID Lamps), air and moderate humidity making it ideal for repeated insecticide applications. Pyrethrins are normally combined with synergists, e.g. Piperonyl Butoxide, which inhibits the insects ability to detoxify.

Active Ingredients - Pyrethrins 0.4%, Piperonyl Butoxide 2.0%

General Indoor Application Instructions - For Total Release Aerosols

Remove all Pets, Birds and Fish Bowls

- Shut off all open flames, including pilot lights in the area being fumigated (Furnaces, Water Heaters, CO2 Generators, etc.).
- Turn off lights, fans and air conditioners.
- Seal area to be fumigated. Close all windows and doors.
- For distant areas spray manually pointing towards ceiling. 4 to 6 seconds is ample for an average 3m x 3m x 3m room.

- Place can on stand or table in center of area to be fumigated.
- Depress valve lever down firmly until it clicks and stays depressed.
- Leave area at once and close door.
- Keep area closed for two hours before airing out.
- Open all windows and doors, (fans) and ventilate for 30 minutes.
- Do not spray directly on plants (DOKTOR DOOM FUMIGATOR).
- For optimum indoor area insect control use DOKTOR DOOM every four days.

READ INSTRUCTIONS ON LABEL BEFORE USE!

Proper Insecticide Application

- Insects must be contacted by spray to be killed.
 - Insecticides should be used with caution on young plants and new growth.
 - Do not spray in direct sunlight (or with HID lamps on). Early morning or evening preferred. A red or green colored light bulb may be used during 'dark cycle'
 - Spray with a slow sweeping motion keeping 30 to 45 cm away from the plants to avoid wetting the foliage. Upper and lower leaf surfaces should be treated. Stems and surrounding soil should be sprayed as well.
 - If you get a white residue on your plants, you're spraying too close.
 - For best results spray plants twice daily in 1 to 2 hour intervals.
 - Before spraying fungicides and insecticides, make sure the plants are well watered. With more water in the system a plant suffers less shock from the killing spray.
 - Always use a respirator or face mask when spraying, especially if using an aerosol/fogger. Spray residues remain very concentrated in the enclosed area.
 - Do not spray on vegetables, herbs, or fruit within 3 days of harvest. Wash fruits and vegetables before eating.
 - Spray your plants with water thoroughly 2 days prior to harvest.
 - Discontinue use of Piperonyl Butoxide (P.B.O.'s) when vegetables, plants, and fruit trees start their flowering cycle.
-

Basic Insecticide Information For All Gardeners

- Pyrethrum (*Tanacetum 'Chrysanthemum', Cinerarilifolium*). A broad-spectrum non-systemic botanical insecticide that causes paralysis initially, with death of the insect thereafter. Pyrethrum is very toxic to insects. Applied as a spray, pyrethrum is vesy effective to control crawling and flying Insects. Pyrethrum is non-toxic to animals or humans. Natural Pyrethrum degrades quickly in the presence of sunlight or (HID lamps), air and moderate humidity. Pyrethrin is recommended for organic gardening.
- Pyrethrins are the best natural insecticide for killing spider mites.
- Insecticidal Soaps are mild contact insecticides made from fatty acids of animals and plants. Soft soaps such as Ivory are biodegradable and kill insects but are not potent. Do not use detergent soaps, they may be caustic. Soaps take time to mix and must be applied many times to be effective. Soaps do not

have any residual effects.

- Horticultural Oils are safe, non-poisonous and non-polluting insecticides. Oil kills slow moving and immobile sucking insects by smothering and suffocating them. Oils when applied to plants, clog the stomata and slow the plants growing process.
- Predators introduced to a garden must have special precautions taken to ensure their well-being. Spraying of toxic chemicals must be discontinued at least two weeks before introducing predators. Pyrethrum may be used up to a few days before introducing predators. Predators are most often very small and must be introduced to each plant separately, taking time and patience. Predators have very specific requirements. For best results, pay attention to the predators needs and maintain them.
- Synthetic Insecticides (*Resmethrin, Pyremetherin, Sumethrin, Pyrethroids, etc.*) are widely used chemicals on plants and vegetables that are not recommended for ingestion or digestion in humans. Many have a long lasting residual effect.
- Piperonyl Butoxide is used to enhance the insecticidal properties of the pyrethrins by blocking the pyrethrin detoxification enzymes in the insect. Pyrethrins alone produce a very rapid knockdown of insects followed by substantial recovery, whereas addition of a synergist such as piperonyl butoxide decreases the insecticidal dose of pyrethrin. Piperonyl butoxide is also formulated with synthetic pyrethrin analogues. such as allethrin and tetramethrin. Piperonyl Butoxide is no longer approved for organic gardening.
- All commereial and domestic insecticides (except Chrysanthemum Flowers Insecticide Plant Spray) have artificial fragrances which contain attar oils. These are not recommended, as when applied, the stomata are clogged and growth is slowed.

Pyrethrins

Have been approved for the effective control of the following insects:

Almond Moth	Drosophila Fly	Midge
American Cockroach	Drugstore Beetle	Millipede
American Dog Tick	Drugstore Beetle (larvae)	Mimosa Webworm
Angoumois Grain Moth	Ear Mite	Mite
Ant	Earwig	Mosquito
Aphid	Elm Spanworm	Moth
Armyworm	Face Fly	Mud Dauber Wasp
Asparagus Beetle	Fall Webworm	Mushroom Fly
Aster Beetle	Fern Scale	Northern Fowl Mite
Bagworm	Firebrat	Oakworm
Bean Aphid	Fireworm	Oleander Scale
Bed Bug	Flat Grain Beetle	Oriental Cockroach
Bee	Flea	Palmetto Bug
Beetle	Flea (egg)	Parisitic Chalcid
Biting Fly	Flea (larvae)	Pear Psylla
Biting Midge	Flea Beetle	Pear Sawfly
Black Fly	Flour Beetle	Pharaoh Ant

Blister Beetle	Flour Beetle (larvae)	Pine Butterfly
Blister Mite	Flower Thrips	Plant Bug
Booklouse	Fly	Potato Beetle
Boxelder Bug	Flying Insect	Potato Leafhopper
Branbug	Flying Moth	Pre-adult Flea
Brownbanded Cockroach	Food Moth	Psocid
Brown Dog Tick	Fruit Fly	Psyllid
Brown Soft Scale	Fruittree Leafroller	Red Flour Beetle
Budworm	Gall Midge	Redhumped Caterpillar
Bug	German Cockroach	Rice Weevil
Cabbage Bug	Gnat	Rose Chafer
Cabbage Looper	Grain Beetle	Rose Chafer (larvae)
Cabbageworm	Grain Insect	Rose Slug
Cadelle	Grain Mite	Roseslug
Cankerworm	Grain Moth	Rusty Grain Beetle
Carpenter Ant	Granary Weevil	Saddleback Caterpillar
Carpet Beetle	Granary Weevil (larvae)	Sawfly
Carpet Beetle (egg)	Grape Leafhopper	Sawtoothed Grain Beetle
Carpet Beetle (larvae)	Greenhouse Thrips	Scale
Carrot Rust Fly	Green Peach Aphid	Scorpion
Caterpillar	Gypsy Moth	Sheep Ked
Cat Flea	Gypsy Moth (larvae)	Silverfish
Cat Flea (pupae)	Harlequin Bug	Skipper
Centipede	Heliothis Sp.	Sowbug
Cheese Mite	Hornet	Spider
Cheese Skipper	Horn Fly	Spider Beetle
Cherry Climbing Cutworm	Hornworm	Spider Mite
Chewing Insect	Horse Fly	Spotted Cucumber Beetle
Chewing Louse	House Fly	Spruce Budworm
Chicken Mite	Humpbacked Fly	Stable Fly
Chigger Mite	Imported Cabbageworm	Stink Bug
Cigarette Beetle	Inch Worm	Stored Product Insect
Climbing Cutworm	Indianmeal Moth	Striped Cucumber Beetle
Clothes Moth	Indianmesit Moth (exposed)	Sucking Insect
Clover Mite	Indianmeal Moth (larvae)	Sucking Louse
Cluster Fly	Insect	Tabanid
Cockroach	Jack Pine Budworm	Tarnished Plant Bug
Colorado Potato Beetle	Japanese Beetle	Tent Caterpillar
Common Cattle Grub	Lace Bug	Thrips
Confused Flour Beetle	Leafhopper	Tick
Corn Earworm	Leafminer	Tick, Deer
Cranberry Fireworm	Leafroller	Tick, Lime Disease
Cricket	Leaftier	Tobacco Budworm
Cross Stripped Cabbageworm	Lesser Grain Borer	Tobacco Moth
Cucumber Beetle	Lesser Mealworm	Tobacco Moth (larvae)
Cutworm	Looper	Tomato Hornworm
Darkling Beetle	Louse	Twospotted Spider Mite
Darkwinged Fungus Gnat	Louse (egg)	Vinegar Fly (complex)
Deer Fly	Maggot	Wasp
Dermeid Beetle	Meal Moth	Waterbug

Diamondback Caterpillar
Diamondback Moth
Diamondback Moth (larvae)
Dog Flea
Dog Flea (pupae)
Douglas Fir Moth
Driedfruit Beetle

Meal Moth (larvae)
Mealworm
Mealybug
Mediterranean Flour Moth
Merchant Grain Beetle
Mexican Bean Beetle
Mexican Bean Beetle (larvae)

Webworm
Weevil
Western Spruce Budworm
Whitefly
Wood Tick
Yellowjacket
Yellow Mealworm

Eco Pager Reporting Systems

P2000 Pager System

"High-Tech Simplicity" Best Describes This Easy to Use Start-Up System.

Using the latest in wireless technology, the P2000 will silently receive and transmit messages from up to 32 Eco Pager transmitters. The P2000 even pages you when your employees come and go.



The phrase "IF ONLY I KNEW" is commonly used by dissatisfied growers everywhere, but now you can relax, knowing that the P2000 control panel is watching over your grow room or greenhouse. The P2000 will silently maintain watch over your growing environment and let you know via pager or digital cell phone the instant a problem occurs. Growers from the hobbyist level to commercial level can all benefit from this easy to use system. Up to 32 Eco Pager wireless transmitters can be handled by the P2000 allowing you to expand your system at any time. Installation is quick and easy. All of our environmental transmitters are wireless and will work up to 500 ft. from the P2000 control. The system is intelligent and will let you know the exact problem using unique code numbers for each sensor type. All you need is a basic numeric pager or digital cell phone to operate the system. Eco Pager systems DO NOT require the use of a monitoring station.

How the P2000 will benefit you!

- Protect your investment from theft and vandalism.
- Be instantly informed of overheat conditions that may ruin a crop.
- Find out immediately that your pump has failed and prevent disaster.
- Know that your reservoir level is low and requires a refill before a dry-up occurs or your tds level becomes too high.
- Be informed straight away when a power outage occurs.
- Know who's coming and going from your grow room or greenhouse.

P2000 System Includes:

- 32 zone processor
- Liquid crystal keypad (with nite lite)
- 900 mhz wireless receiver & antennas
- Strobe light
- T1000 wireless door/window transmitter
- Wireless keychain remote control
- Long life back-up battery
- Plug-in power transformer
- Wallet card that lists the pager codes.

System Features:

- Pages information to 1 or 2 pagers or digital cell phones
- Accepts up to 5 extra code numbers for friends or employees.
- Pages you when employees or friends are turning the system on or off.

- Memory that will show the last 128 events on the keypad display
- Keypad chime to alert you of approaching visitors.
- Programming security feature (keeps your pager or cell # secure)
- Pages you when a power failure occurs
- Pages you if any system battery becomes weak.
- System continues to run on it's battery in a power outage
- Very easy installation and completely portable.

Contact info@ecopager.com or visit the Eco Pager website at <http://www.ecopager.com>, for more information.

LW1000 Low Reservoir Wireless Transmitter

Many growers have experienced system leaks, or have been away too long resulting in a low or dry reservoir and starved crops. The LW1000 monitors your reservoirs 24 hours a day and sends a signal to the Eco Pager control the moment that the minimum probe level is reached. The LW1000 gives you the assurance that you wont return to find a dry reservoir. Installation is easy, thanks to the LW1000s wireless technology. Simply set the probe at the desired water level and let the LW1000 do the rest. The Eco Pager control unit will page you a code 22 the instant that the minimum water level is reached.



Contact info@ecopager.com or visit the Eco Pager website at <http://www.ecopager.com>, for more information.

FC500 Flow Check Wireless Transmitter

One of the most critical functions in a hydroponic growing system is consistent water and nutrient supply. If you are running an aeroponic system and a pump failure or major leak occurs, a crop can be lost within hours. The FC500 has been designed to automatically check for flow in your header line when the pump is switched on, and report a failure to a pager or digital cell phone. Greenhouse operators and staff who routinely check their pumps can directly benefit in labour savings, freeing up time for more productive tasks. The applications for this unit include, water cooled lighting, ebb and flow systems, drip feed systems, flood and drain systems, and, drain to waste systems. When a pump failure occurs the FC500 will transmit a wireless signal to the Eco Pager control panel and subsequently a code 66 will be sent to a pager or digital cell phone.



Contact info@ecopager.com or visit the Eco Pager website at <http://www.ecopager.com>, for more information.

PF110 and PF240 Power Fail Wireless Transmitter

One of the biggest fears of an indoor grower is a power outage. Typically you have just checked your crop and everything looks good, you leave thinking everything is on schedule and you decide to return in two days to see how things are progressing. You return in two days only to find out your entire crop has died due to a power failure, which occurred five minutes after you left.



The PF110 has been specifically designed to supervise constant 110/120 VAC power sources. Power failures are detected instantly and reported to your pager or digital cell phone with a code 55.

Contact info@ecopager.com or visit the Eco Pager website at <http://www.ecopager.com>, for more information.

HT1000 High Air Temperature Wireless Transmitter

When summer approaches and grow room temperatures rise, problems may occur. The HT1000 lets you know of a problem before you return and find out it's too late. Air temperature can rise quickly when exhaust, intake, or circulation fans fail, the HT1000 will sense the rise and transmit a wireless signal to your Eco Pager control which in turn will send a code 33 to your pager or digital cell phone. Let the HT1000 watch out for high temperatures in your growing environment.



The HT1000 is designed to inform you when ambient air temperature exceeds a pre-set level. Grow room temperatures can rise quickly when cooling devices fail or electrical equipment overheats. A code 33 will be paged to your pager or digital cell phone via the Eco Pager control unit.

Contact info@ecopager.com or visit the Eco Pager website at <http://www.ecopager.com>, for more information.

General Hydroponics

FloraGro, FloraBloom and FloraMicro

Our plant nutrient products are recognized world-wide as the industry leaders in quality, reliability and innovation. Available throughout North America, Europe, Australia and many parts of Asia and the Middle East - General Hydroponics nutrients are the standard for scientific research, commercial crop production, education, and for hydroponic gardening enthusiasts who insist on only the best.

The magic we see using hydroponic cultivation methods is really based upon the nutrients - the nutrients are what make plants grow, the hydroponic systems activate the nutrients by providing water and oxygen to stimulate growth.

Most hydroponic growers avoid the use of pesticides and never require herbicides since there are no weeds to contend with, and bugs generally don't seek healthy plants - they tend to go for the weaker ones.



Nutrient research is the most dynamic division at General Hydroponics. We are very pleased with our track-record - better crop quality, extraordinary growth rates and yields - and a lot of this achievement can be attributed to the nutrients. It is because of the effort we put into our nutrient products that we've been so successful.

We've built such a reputation within the scientific community that our nutrients are now recognized as preferred for scientific tests using plants under U.S. Department of Agriculture and EPA (Environmental Protection Agency) regulations. NASA scientists refer to our nutrients as "reliable, adaptable and pH buffered," and so our Flora-series is used for space flight experiments. The list of satisfied clients is long and needless to say, a source of great pride to us at General Hydroponics.



Different kinds of plants have significantly different nutrient needs. Different stages in a plant's life-cycle also result in changes in the plant's nutrient requirements. We have studied these cycles and worked to perfect nutrient products which will empower the grower to fulfill the crops needs with precision and ease. We call this approach "evolutionary formulation," the nutrient evolves along with the crop. As the crop grows the grower is able to alter the nutrient formulation to meet the crop's changing requirements.

We're always looking to the future, always searching for ways to improve our nutrient lines. An area with great potential is human nutrition. By adding appropriate sub-micro elements to the nutrient formulations we enhance the quality of produce in terms of vitamin and mineral content associated with good human nutrition. Tests performed by Plant Research Technologies Laboratory proved that tomatoes and peppers grown with General Hydroponics Flora nutrients were up to three times more nutritious than the soil grown control group - a significant achievement. We continue to search for ways and for ingredients that will improve our nutrient lines. Foliar sprays using seaweed compounds show potential - this is an area where organic ingredients show great promise. Coconut fiber as a rooting media is another example of an organic product with real value to hydroponic growers; with time we'll discover more and more. For now you can be sure that our products represent the state of the art in hydroponic plant nutrients.

FloraGro, FloraBloom and FloraMicro comprise our nutrient flagship. Recognized world-wide as the most advanced hydroponic nutrient line ever developed, the Flora-series is used by NASA, Argonne National Laboratory, Los Alamos National Laboratory and has been specified for research using hydroponics by Laboratories, Universities, Government Agencies, and Scientists throughout the world. The Flora series is the result of the collective contributions of many famous scientists in the fields of hydroponics, agriculture and chemistry.



Some of the contributors include Dr. Cal Herrmann - our senior chemist and Dr. Hillel Soffer - world renowned scientist in hydroponics; further contributions have come from scientists of the national hydroponic research centers in Israel, Holland and England; University of California Laboratories at Los Angeles and Berkeley plus commercial hydroponic farmers and years of input from growers world-wide. The amount of data-analysis, research, field-testing and pure effort dedicated to developing the finest nutrient line has paid off through the Flora-series.

The concept behind the Flora-series remains unchanged. A combination of three products enable the grower to mix a huge range of different nutrient solutions to satisfy the needs of practically any type of plant, and each different stage in its life cycle by varying the combinations and overall strength of the mix. Think of it as changing flavor by mixing different ratios of FloraGro, FloraBloom and FloraMicro; and different nutrient strengths by varying the amount of water with which they are blended. This gives the grower three dimensional control over the nutrient.

Choosing the Right Hydroponic System

Choosing the right system is an important decision. There are a number of questions to be considered: How large an area do you wish to cultivate? Do you only want a single module, or complete system? You can expect to achieve extraordinary results, but you've got to choose the right system.

You may plan to push the system to the max by spending significant time starting plants, cultivating and harvesting; or simply want a low maintenance module to power-drive one or a few plants through an extraordinary growth cycle yet only spending a few minutes every few days tending to the system. These are different needs, and we have the systems, which will fulfill these needs.

Single module growers or small set-up growers who want top results without much effort should look at the WaterFarm and PowerGrower. Each of these systems can be operated as single stand-alone modules, or interconnected in-groups of two to sixteen modules with the optional controller systems.

For propagating cuttings or quick-starting seeds, transplants or seedlings, there is no hydroponic system that will match the performance of the RainForest.

The AeroFlo requires frequent attention since growth rates are very high. Abundant and good-quality fresh water and electricity must be readily available. The successful grower will monitor the system and plants, always making sure that their needs are fulfilled. Rapidly growing plants need to be maintained. Vines require trellising (external support). Fruit and flowers must be harvested in a timely manner. New plants must be started as older plants complete their life cycles. Running an AeroFlo is like driving a very fast car, the grower must look ahead and anticipate what's to come.



Serious growers who want a larger system should look at the Eve's Garden (Dutch Garden). Eve's Garden comes with 6 or 12 individual pots that fit together on a sturdy PVC frame. Eve's Garden comes complete with a recirculating pump, growing media, our famous Flora Nutrients and all the hardware you need to start-you just add the plants.

Hydroponics is somewhat like growing crops organically; it is satisfying and fun. It brings us closer to the earth, provides us with enhanced nutrition through better quality food, and helps us establish a spiritual connection with the growing world around us. As a means to improve our nutrition, as a teaching tool or a way to bring the family together with a common goal, there are few more rewarding experiences than cultivating crops; mankind's oldest vocation.

Experienced hydroponic growers know what it is like to participate in the life cycle of plants, words cannot convey the feelings a successful grower experiences watching a crop fulfill its potential - it's a special kind of joy; and you can experience it with a single WaterFarm or a huge commercial installation. The hydroponic experience will bring a new meaning into your life, one that is fun, educational and very satisfying.

AeroFlo 30 System includes:

- 20 gallon reservoir
- 3 - 6 ft. grow chambers
- Mag Drive #7 pump
- Injection manifold
- Support structure
- 30 - 3" grow cups
- Polywool and Grorox
- 3 part FloraKit

Eve's Garden

We are very proud to offer Eve's Garden (Dutch Garden) to North American growers. This is the only hydroponic system we offer that we did not develop here at General Hydroponics, it was developed in Holland. We have improved the design for Eve's Garden, we offer our exclusive beige model which is better for outdoor installations since the light beige color prevents solar heating.

- Imagine fresh, fragrant flowers, fresh greens, herbs or tomatoes right off the vine and into your salad in minutes; all growing in a single Eve's Garden!
- Enjoy the power of hydroponics in a compact, attractive package. Includes everything you need (except plants or seeds) to get started!
- Assembled and ready to use in about twenty minutes.
- Inexpensive, easy and fun!

- Available in 6 and 12 pot versions; comes complete with reservoir, support stand, pump, GroRox, coconut fiber rooting media and one pint of FloraGro, FloraBloom and FlorMicro nutrients.

Eve's Garden is similar to the AquaFarm from the plant's point of view. A container filled with GroRox, or a combination of GroRox plus coconut fiber is irrigated intermittently with nutrient enriched water. A pump delivers nutrient outbound from the reservoir, and spaghetti tubes supply each Dutch Pot. Eve's Garden system is simple to operate, reliable, economical and extremely practical.



An additional advantage is that Dutch Pots filled with GroRox plus coconut fiber are the first truly "organic-hydroponic" systems yet developed. This combination plus our "Flora" - Advanced Nutrient System offer the best of both worlds; organic rooting media combined with ultra-high purity mineral nutrients.

Contact info@genhydro.com or visit the General Hydroponics website at <http://www.generalhydroponics.com>, for more information.

Green Air Products

Dehumistat

Our DEHUMISTAT is a popular controller for removing unwanted atmospheric moisture accumulating within an enclosed area. High humidity conditions will activate fans or other dehumidifying apparatus until level drops approximately 9% in relative humidity. At this point equipment is disabled until humidity raises again 9%. Switches 110V at 10 amp maximum.



Install the Dehumistat to activate an exhaust fan or other dehumidifying equipment to remove excess humidity. The Dehumistat may be plugged directly into a standard 110 VAC wall outlet or into other Green Air Products timers or controllers. When plugged into the wall, as in the example above, the Dehumistat will operate independently to maintain humidity within your desired range.

Humistat

Control humidity automatically and accurately with Green Air Products HUMISTAT. This control operates fogging or other humidifying equipment by activating switches, motors, valves or pumps. The 110V outlet receptacle receives power when atmospheric moisture content becomes less than your preset minimum allowable percentage. Sensor allows a 9% comfort zone between "on" and "off" functions. Power handling 10 amp maximum.



If your humidifier already has a humidity control, turn it to full on position and set humistat dial to your minimum desired humidity. The Humistat can also be used with any humidity devices or any other electrically triggered appliance.

The HUMISTAT humidity switch controls humidifying equipment by providing power when humidity falls below the adjustable set point. Humidifiers can be precisely controlled according to atmospheric humidity to create ideal conditions for any environment.

MCC-1 Micro Climate Controller

The Micro Climate Controller MCC-1 is designed to perform all the major atmospheric and timed functions required in an automated growth environment including temperature, humidity, carbon dioxide enrichment, lighting and irrigation control. The controller incorporates an external coil cooling thermostat, a dehumidifying humidistat, a 24-hour clock timer, a photo-sensor and a repeat cycle timer. Heating and humidifying control is provided by triggers for remote high-amperage relays which enable synchronized equipment management. Automatic override and defeat systems coordinate controls to consider all possible variables. The MCC-1 is enclosed in a black anodized, brush finish aluminum housing. An attractive screen-printed front panel with function indicator lights makes system monitoring and adjustment quick and easy. All connections are standard 3-prong grounded plugs and receptacles. No hard wiring is required for basic operations. Low



and high voltage relays are available to operate auxiliary equipment. Every aspect of the growing environment may be addressed by the Micro Climate Controller (MCC-1). Operates on 110VAC with 15 Amp switching capacity.

Model 24-CT-1 Independent Outlets

For the basics in garden room control the 24-CT-1 might be just what you need. This handy item incorporates two of the more common requirements of a small enclosure. A timed outlet and a thermostatically controlled outlet. This unit is ideal for operating lighting, CO2 equipment, watering systems, fans etc. and provides an economical solution for many greenhouse control needs.



Model CT-DH-1 Integrated Outlets

This CT-DH-1 is designed to turn "On" and "Off" exhaust fans and/or intake fans to remove unwanted atmosphere due to heat or humidity. This device is intended as a cooling and dehumidifying control. This controller is ideal for situations where excess heat and humidity need to be exhausted. Internal sensors will allow a 7° temperature comfort zone and a 7% humidity span (differential) between the time the fans go "Off" and come back "On" again. Temperature rise will activate the right outlets and deactivate the left outlets.



Model CT-DH-2 Independent Outlets

The CT-DH-2 controller is designed to give you independent outlets for cooling and dehumidifying equipment. Set the temperature and humidity dials to the desired settings. If the temperature rises beyond the set limits, the left outlet comes "On" and if the humidity increases, the right outlet comes "On". When temperature and / or humidity fall below the set limits, left and right outlets turn "Off" independently. This allows you to use a dehumidifier to control humidity and an exhaust fan to control temperature and neither side will defeat the other when they initialize. Internal sensor will allow a 7° temperature or 7% humidity differential between the time equipment comes "On" and goes back "Off" again. Small amber lights indicate when the outlet has power. Operates on 120VAC 15 Amps Max. Do not exceed power handling capacity of your wall outlet.



Model CT-DH-3 Synchronized Outlets

While the CT-DH-3 has many applications, it was primarily developed to be used with CO2 equipment and exhaust type fans. Internal sensors will allow a 7° temperature comfort zone and a 7% humidity (differential) between the time the fans go "Off" and come back "On" again. Temperature or humidity raise will activate the right hand outlets and deactivate the left hand outlets. The CT-H-3 has an internal relay that automatically switches power from the equipment side to the



exhaust side of the unit when either temperature, humidity or both are in excess of the dial settings. Plug the controller into 110V wall outlet. Set the temperature and humidity to the desired settings. The left or equipment side of the controller is normally in the "On" position and is able to activate CO2 equipment if needed. Equipment to be used for CO2 generation should be plugged into the left outlet. All equipment needed to exhaust the growing area should be plugged into the right outlet which is the exhaust side of the controller. The left outlet (CO2) is defeated whenever the exhaust outlet is activated. See optional thermostat sensors. Also available with built in photo sensor to defeat equipment (left) outlet during darkness periods. Indicate this option with a "P". (CT-DH-3P) Operates on 120VAC with 12 amp switching capacity.

Model CT-HT-1 Independent Outlets

This controller features fully independent sensors for cooling and heating equipment. The cooling thermostat activates the left outlet of the controller and the heating thermostat activates the right outlet. If you require a tighter control of your temperature than the internal heating \ cooling thermostats allow, alternate sensors are available with a 4° differential. Operates on 110VAC with 15 Amp switching capacity.



Plug controller power cord into 110V outlet. Plug cooling equipment into left side outlets. Plug heating equipment into right side outlets. Standard thermostats are accurate to $\pm 7^\circ$. If your growing situation requires the temperature to be no cooler than 50° and no hotter than 70° you would set your heating thermostat to 57° and the cooling thermostat for 63° to allow for the thermostat differential. This would give you a minimum buffer zone of 6° and a maximum of 20°. Do not exceed power handling capacity of your wall outlet.

Tempstat

The TEMP-C temperature switch controls cooling equipment by providing power when temperature exceeds the adjustable set point. Exhaust fans, evaporative coolers, air conditioners or ventilators can be precisely controlled according to atmospheric temperature to create ideal conditions for any environment.



External coil hydraulic sensor provides accurate dependable switching with a 6° differential and a load capacity of 15 amps or ½ hp at 110V. See optional 10 ft. lead remote bulb sensor.

The TEMP-H controller will trigger heating equipment used to maintain temperatures for atmospheric, nutrient or propagation heating systems. Precise sensor moderates temperature by operating heating equipment if level falls below the acceptable range. Offers the same specifications as the coolstat and is also available with remote bulb sensor.

CDM-1 CO2 Monitor

The CDM-1 is a breakthrough in CO2 detection and control. It is a sensing device which measures the level of CO2 in ambient atmospheres. It employs a revolutionary passive infrared element which samples the air once every second and interprets a value instantly. The passive infrared sensor precisely determines and displays the CO2 values in parts per million (ppm). CO2 is monitored continuously and displayed on a large LCD screen. This enables you to maintain precise CO2 enrichment levels without guesswork. The LCD readout displays CO2 levels from 0 to 2000 ppm. The monitor output jack provides 0 to 2 VDC linear signal which can be used to interface with a computer or other auxiliary devices used to control CO2 or venting equipment. The CDM-1 operates on 12VDC and will function as a portable hand held. The CDM-1 plugs directly into Green Air Products Carbon Dioxide Digital Sequencer (CDDS-1) with a single patchcord and becomes an automatic and programmable CO2 control system. The built in battery backup will power the monitor for minutes without auxiliary power. The CDM-1 can be quickly unplugged and removed from it's wall mount and carried to all areas of the enclosure for instantaneous spot checks, or from one greenhouse to another. The internal Ni-Cad battery pack will recharge automatically when plugged back into it's power source. The CDM-1 plugs directly into the Green Air Products Carbon Dioxide Digital Sequencer (CDDS-1) with a single patchcord and becomes a precise and programmable CO2 control system.



CDDS-1 Digital Controller

The CDDS-1 provides a method of accurately and automatically controlling CO2 producing equipment to insure exacting and consistent levels. The Green Air Products CDDS-1 (Carbon Dioxide Digital Sequencer) is what transforms the CDM-1 monitor into a powerful versatile control. The CDDS-1 provides an easy to use set point controller which enables the user to adjust CO2 level and span. CO2 values are adjustable in 50 ppm increments from 0 to 2000 ppm. The span between CO 2 "On" and CO2 "Off" (hysteresis) is also adjustable to 50, 150, 200 or 300 ppm differential. An LED changes color to indicate CO2 function status. The CDDS-1 also provides a photo-sensor to disable CO 2 production during darkness periods. The CDDS-1 controller has two standard 110V outlets on the right hand side to operate CO2 producing equipment. This same controllers left outlets can be used to operate exhaust systems for venting excess CO2 accumulation in hospitals, class rooms, offices, auditoriums, laboratories or mushroom culture facilities. The CDM-1 and the CDDS-1 are available as a package in the CDMC-2 system. The CDMC-2 is ready to use and no other equipment is needed to operate with your CO 2 emitter systems or generators. For more sophisticated applications call our information line to see how the CDDC-1 may be installed into your current system.



HAR-1 Function Relay

The HAR-1 is a power relay that uses high amperage capacity contacts to transfer power to large fans or lighting systems requiring high voltage or amperage service. Use to operate 110 or 240 Volt high draw equipment. 30 Amp switching capacity with 110 Volt trigger.



HF-1 Function Relay

The HF-1 is a high amperage relay with a built in humidifying humidistat. Use to supply 110 or 240 Volt power to humidifying equipment when humidity falls below set point. 30 Amp switching capacity for heavy load requirements.



HR-1 Function Relay

The HR-1 is a high amperage relay with a built in external coil heating thermostat. Use to supply 110 or 240 Volt power to heating equipment when temperature falls below set point. 30 Amp switching capacity for heavy load requirements. A jack receptacle and internal low voltage dry contacts are used to function gas type heaters.



Light Manufacturing Company

6-Cell "Closet" Starter Kit

A great way to begin or sharpen your hydroponics skills, this starter kit is the ideal introduction to growing vegetables, herbs or flowers indoors or out. Kit includes 6 plant cells, one of which is modified to function as a heart, and 3-months' supply of nutrients. You can expand this kit to 12 cells with an additional 6 cell kit, or convert it to a traditional Living System with a separate Heart and Nutrient Supply Center.



The Ultimate Plant Growth Lighting System: Super Spectrum Dual Lighting

Avoid the outlandish cost of chasing the far ends of the red and blue color spectrum with this broad-spectrum dual lamp fixture. At Light Manufacturing we've taken a different approach. Our dual lamp systems combine the blue spectrum of metal halide (MH) lamps with the red spectrum of high pressure sodium (HPS) lamps in a single, integrated fixture. The result is a fixture that offers a spectrum of light unparalleled by any single lamp source at an attractive price. Super Spectrum Dual Lighting Systems use both MH and HPS lamps for affordable lighting performance.



Complete systems are comprised of an aluminum heat sink ballast enclosure with one MH ballast and one HPS ballast (both multi-tap, multi-voltage), two socket assemblies, two lamps (1 MH, 1 HPS), and a dual super horizontal reflector with a pebble-tone reflective insert. Options include protective glass lens and 4" vent adapters for air-cooling. Our 265 CFM blower and 4" ducting are recommended for air cooled systems. These dual lighting systems are UL listed and approved for horizontal MH systems with enclosed reflectors, and for all HPS systems and vertical MH systems. Specify 120V or 240V system when ordering.

Contact lite-info@litemanu.com or visit the Light Manufacturing Company website at <http://www.litemanu.com/>, for more information.

Golden Grow - Important Nutrient Information

Whether you grow plants in soil or in the nourishing liquid environment of hydroponics, the best nutrients and pH adjustment solutions available on the market today are found in Golden Grow™ products from Light Manufacturing Company. Golden Grow's three-part formula represents the complete, ideal mix of elements required by most plants. If these individual

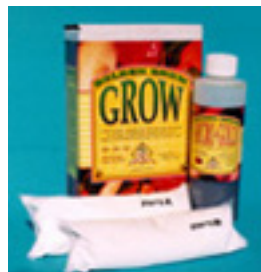

elements were packaged together in the high concentrations in which we offer them, they would react chemically, and the result would be non-soluble form, unusable by plants. Our nutrients are 100% water soluble, so there is virtually NO waste, and they are easily absorbed and assimilated by plants. Our many satisfied customers agree that Golden Grow

nutritive products are the best. Here's why—Golden Grow products contain the required balance of:

Three Macro nutrients - the "N", "P", "K" elements:

- NITROGEN - "N"
- PHOSPHOROUS - "P"
- POTASSIUM - "P"

Three Secondary Macro nutrients - equally vital in large quantities:

- CALCIUM - "Ca"
- MAGNESIUM - "Mg"
- SULFUR - "S"

Six Micro nutrients - essential for optimum growth:

- BORON - "Bo"
- COPPER - "Cu"
- IRON - "Fe"
- MANGANESE - "Mn"
- MOLYBDENUM - "Mo"
- ZINC - "Zn"

These nutrient mixes contain high-quality food grade and technical-grade ingredients (we use the same potassium compound that is found in "Gatorade") so you can be sure that you are receiving the finest products possible. Golden Grow uses only un-coated hydroponics grade calcium nitrate as a nitrogen source, not inferior "ammoniac nitrogen," a low-quality source of nitrogen found in many fertilizing products that can cause excessive leaf and stem growth, or long, spindly plants. The respected publication, Plant Nutrient Facts, says nitrate nitrogen is absorbed and assimilated by plants at a much slower rate for more balanced plant growth, and promotes production of abundant, perfectly-timed flowers and fruits.

Golden Grow ranks among the most richly concentrated nutrient products available, giving you more high-quality nutrients for your money than less complete, lower-quality garden store varieties. And our pH adjustment solutions are at least 50% stronger (2.5 mol) than other brands, but cost 20% - 30% less.

Golden Grow products are extremely easy to use mixed by either weight or volume. Or, use our available Nutrient Mixing Kit for easy and accurate formulation of a potent three-part nutrient solution. Either way, with Golden Grow products you will enjoy the highest quality, broad spectrum, and most complete nutrient products available on the market today

Contact lite-info@litemanu.com or visit the Light Manufacturing Company website at <http://www.litemanu.com/>, for more information.

Living System™

Ultimate Hydroponics Gardening with a "Heart"

Living System™ is an innovative method of growing plants through a central distribution system. At its core is a pumping heart that automatically flushes, drains and circulates a source of nutrients to all the connected plant cells at timed intervals. This method allows growers to measure levels of pH and concentration of nutrients in solution at any cell spout, then correct those levels at the heart. Cells radiate outward from the heart in six directions and are linked by feed and drain lines. The nutrient supply center provides a 5-gallon mixing reservoir, nutrient level regulation, and a reservoir expansion port, to which a 50-gallon expansion reservoir can be added. Living System is easily expandable and can accommodate as many as 72 plant cells at once. Bypass clamps ensure a constant flow rate, even as you increase or decrease cells.



Living System was developed by Light Manufacturing Company and is ideal for both commercial greenhouse growers and home gardeners who want the ultimate in hydroponics gardening.

All Living System components can be purchased separately and can adapt to any irrigation method. (Please call for information.) Living System growth modules are interchangeable with the Living System Nursery module; just move the Living System Nursery plants to the Living System, without the need for transplanting, to achieve continuous production.

Tip: A good rule of thumb when deciding what size Living System to use is to allow 2 sq. ft. per plant.

The Nutrient Supply Center connects to the system at the end of any drain line, through the Cell drain tee.

Cell Expansion Kits

6, 12, and 18 cell kits let you expand your Closet Starter Kit or Living System easily. Just plug the additional cells directly into your current system.

Contact lite-info@litemanu.com or visit the Light Manufacturing Company website at <http://www.litemanu.com/>, for more information.

Nature2, Inc.

NPTM-626 Digital Timer

Designed not to block the 2nd wall plug

Features:

- 7 days and 24 hours program
- 8 On and Off program locations
- Reset function for clearing the whole switching program and Time-of-day setting through rotary switch
- Permanent Override operation mode through push button for ON/AUTO/OFF
- Back up battery:
NiCd/NiMH (green battery as optional) button battery 1.2 VDC. For power reserve more than 100 hours after fully charged
- Programming interval minimum 1 Minute On and Off switching



Approval:

UL , EC, CSA

Int. Plugs:

Germany, Sweden, British, Australia, USA & Canada.
Others upon request.

Switchable Capacity:

Input: 110-130 VAC @60Hz,

Output: 15 amps@125 VA, Resistive max.1875 watts.

Input: 220-250 VAC @ 50Hz,

Output: 10amps @ 250 VAC, Resistive max. 2500 watts.

NPTM-6333 Digital Timer

Programs up to 56 on/off settings per week

It is like paying for one and getting another free!

Features:

- 7 days and 24 hours program
- Digital time switch with extension power cord
- Simple and easy to set
- 8 on/8 off programs with 56 on/off setting
- LCD digital clock and readout
- LED indication turn on
- Manual key for temporary override
- Back up battery:



NiCd/NiMH (green battery as optional) button battery 1.2 VDC. For power reserve more than 100 hours after fully charged.

- Programming interval minimum 1 Minute On and Off switching
- Extension Cable cord length: 6'/1.8 meter
- 1 year limited warranty

Approval:

UL & CSA. Others upon request

Sockets:

USA & Canada. Others upon request.

Capacity:

Input: 110-130 VAC @ 60Hz

Output: 10 amps @ 125 VAC

Resistive max. 1875 watts

Tungsten: 500 watts

AGHI Environmental Forestarium

The only component of your living space with life-giving and health-restoring powers, the AGHI Environmental Forestarium not only recycles oxygen, but cleans and purifies the air, giving you unmatched capabilities to control and shape your environment. Whether at home or in the office, AGHI Environmental Forestarium let you create and shape a beautiful, all-natural indoor environment, enhancing the overall quality of your health and your life. Intelligent and invigorating AGHI Environmental Forestarium make your living space designs come alive.



AGHI Enviromental Forestarium with the most efficient electric illumination source and comply with the plant growth sensitivity curve for growing your plants to produce oxygen. The wide ranges (350nm - 750nm) of light spectral stimulates the opening up of stoma on the surface of the plants' leaves, along with enhancing moisturizing of the leaves' cell structures. And the concentration gradients encouraging the inner and outside particed air automatic absorption of toxic substances from the air, making for cleaner, purer air.As plants photosynthesize, electrolytic exchange is occuring in the surrounding environment, with increasing concentrations of negative ions, resulting in luxuriant plant growth. In addition, plants' phytoncide prevents germs and bacteria from breeding indoors. All this proves that ensuring an environment full of fresh, healthy air starts with greening your indoor living spaces.

The patented, independently developed AGHI Environmental Forestarium simulates the best possible growing conditions and plant ecologies found in nature, and is the result of many years of painstaking planning and experimentation.

Contact info@nature2inc.com or visit the Nature2, Inc. website at <http://www.nature2inc.com>, for more information.

[Rambridge Wholesale Supply](#)

Tropf Blumat

Fully Automatic Watering System for Soilless/Soil Gardeners



- Every Tropf Blumat works individually
- Automatically waters when plants need it
- Each plant is fertilized individually
- Fed from a 20 litre pail or works with a very small pump from a reservoir
- Inexpensive and works for years
- Ideal for small or larger grow areas
- Silent - makes no noise
- No spray

FUNCTION. . .

The Tropf Blumat trickling installation functions fully automatically. When the ground is dry, its natural suction power triggers the trickling function. The Tropf Blumat's membrane opens, thereby allowing the water to flow. When the ground is sufficiently moist, the Tropf Blumat automatically stops the trickling function and the membrane closes again. Every Tropf Blumat cone is fully automatic and on it's own: It reacts to sunshine, air temperature, humidity and plant growth. The formation of calcium deposits in the system is impossible.

After installation, the system should be checked every 2 days for 1 to 2 weeks. If necessary, adjust it by turning the setting screw slightly for more (open) or less (close). In most cases, an adjustment of 1/2 arrow will be sufficient. Changing the trickling function later will not be necessary after it has been adjusted properly.

Wegener's Liquid Organic Growth Promotant

Combining nature's essential organic elements Wegener's Liquid provides a balanced NPK (8-6-6) with calcium magnesium plus a formulation of trace elements and minerals including natural extracts from bees wax and select foliage that help plants to absorb and use organic nutrients.



Use A Little - Grow A Lot. . . Whether you are a commercial grower or a home gardener you will find that Wegener's Liquid addresses nutrient imbalances and is ideal for helping plants recover from stress. Wegener's Liquid provides a gentle release of nutrients which will not burn plants even when applied as a spray to seedlings.

Environmentally Safe. . . Wegener's Liquid is NOT harmful to birds, bees, animals or the environment. Wegener's does not easily leach into waterways making it a preferred choice for golf courses, lake front landscaping, around ponds and water gardens.

Commercial Use. . . Wegener's Liquid Organic Growth promotant provides the complete nutrition required for growing in soilless mediums. This makes it ideal for interior plant maintenance, nursery stock, fruit, vegetables or herbs.

Lawn Management. . .Wegener's Liquid promotes a healthy root system in lawns. Healthy lawns grow at an even rate and squeeze out weeds. Wegener's Liquid increases micro organism level, improves soil drainage, make grass more drought resistant and more resilient.

Bio-Bran, Protecting The Plant World

In combination, the bio-bran and guardian angel team provides the best nontoxic environmentally safe control for root rot problems. it really is about good crop insurance.

BIO-BRAN
"PROTECTING THE PLANT WORLD"



Bio-Bran aids in nutrient exchange and digestion of organic materials in the system, plus Bio-Bran impedes the spread of damaging bacteria/fungus growth on root systems, acting as a passive defence. Guardian Angel is a safe, nontoxic protection system that takes over where Bio-Bran can't spread, like the rest of the system (your pumps, irrigation lines, medium and reservoir). Guardian Angel is an active defence system that reacts with root rot causing bacteria and fungus, disabling them upon contact.

BIO-BRAN contains many friendly bacteria that occur naturally in soil. Friendly or "benign bacteria" feed on minerals and organic matter, breaking them down to a plants usable or "ionic state," in turn releasing previously unavailable vitamins, hormones and making minerals more available to plants.

Friendly bacteria feeds many times faster than bad bacteria and when present in large quantities, starve bad bacteria to levels of little or no concern. BIO-BRAN can be used immediately on freshly rooted cuttings. Add the contents of a BIO-BRAN cap to a quart of distilled water and let it stand for a day. Then water each cutting with a small amount when the first roots have formed. Once added to the nutrient tank BIO-BRAN continually multiplies, simulating natures biological and organic cycles by protecting against infection and enhancing plant food availability.

BIO-BRAN links the biological benefits of organics with the control and vigour of hydroponics for truly superior plant production and yield.

Guardian Angel, Protection At Its Best

Guardian Angel effectively protects your root systems from bacterial and fungus infections that can cause root rot. In fact it protects your entire hydro system, pumps, reservoir, etc. from spreading infections.



"Ideal for hot weather root problems." Use throughout all stages of growth for *"total protection."* Guardian Angel is safe to use, nontoxic and does not enter into the plant or product.

Hydroponics

Cuttings: Soak rockwool cubes with a 3mL per 1 litre of water before starting cuttings. Can reduce algae growth on cubes and protect the cutting. Compatible with all rooting compounds.

Systems: Add 1mL per 1.5 litres of nutrient solution. Use with every nutrient change for best protection. Protects the whole garden system (reservoirs, pumps, filters, drip lines, medium, and plants). Compatible with all nutrients.

Soil / Pro-Mix / Sunshine Mix

Cuttings: Mix 3mL per 1 litre of water. Apply one application to the rooting mediums. Re-apply if you flush the medium.

Maturing Plants: Mix 5mL per 1 litre of water. Soak each pot until water comes out the bottom. Repeat once a month or add 1 mL per 1.5 litres of water everytime you water.

[Rubicon Products Inc.](#)

Bat Guano or Bat Manure (2-26-0)

This natural fertilizer is obtained from fruit eating bats. The vitamins and proteins contained in the fruits allows the bats to feed themselves. In return, an excellent biological fertilizer is created. The 'guano' allows the plants to multiple it's branches and flowers. A multitude of trace elements also contributes to a healthy flowering period. Best to be applied 4 to 6 weeks in, anticipation of flowers. Simply scatter 50 - 75 ml per plant in growing medium OR dilute in hot water, let rest for 1 hour and apply to root system.



Bat Guano or Bat Manure (10-3-1)

This natural fertilizer derives from insect eating bats and has been used for centuries by Incas. It's obtained by scrapping the cave's floor. The bats hunt at night for high protein insects. In return, a potent fertilizer is obtained. These elements take about 2-3 weeks to release into the roots. Use bat Guano during the grow season. Simply dilute in hot water 25-50 ml OR scatter in growing medium and water abundantly.

GUANO 100% Natural Organic Soil Amendment

The word guano originated from the Quichua language of the Inca civilization and means "the droppings of sea birds". It is a misnomer to refer to bat dung as guano. As the word is used today, guano describes both bat and sea bird manure. The most famous guano was that used by the Inca. The guano Would collect on the rain less islands and coast of Peru. Atmospheric conditions insured a minimal loss of nutrients. There is very little leaching of valuable material, nor is there a considerable loss of nitrogenous matter. For this the Inca would guard and regulate the treasured soil enricher. Access to the guano deposits were restricted to chosen caretakers. Disrupting the rookeries could result in punishment by death.

Premium Worm Castings

Worm castings is 100% natural. The organic matter is digested and transformed through the guts of the worms. Their manure is Collected and packed in bags. The freshness and quality of this natural fertilizer is kept by the 60% humidity contained in, the product. Premium worm castings ableable the plants to grow without any nutrient deficiency. It also reinforces the stem and branches of plants to support the flowers. When replanting trees or clones, you can use Premium by adding 1-2 cm under root system and then water abundantly. Premium contains 75% organic matter and more than 20 trace elements including Iron and calcium.



Marinis Seaweed (2-2-17)

This seaweed (Asicophyllum nodosum) is extracted from the cold waters of Nova Scotia (Canada). It is processed into a concentrated and natural fertilizer. Non toxic to plants, Marinis enables the plant to rapidly expand it's number of leaves and roots. Best to be in a fine mist on surface of plants. Simply dilute 2.5 ml / liter of water and spray on leaves Or inject into the root system. Do not apply in full sun.

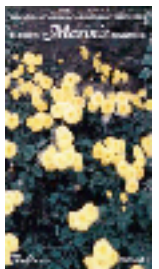

Liquid Seaweed Concentrate is extracted from freshly harvested Ascophyllum nodosum seaweed (Rockweed) from the cold and clean North Atlantic coast of Nova Scotia, Canada. Judicious use of Liquid Seaweed Concentrate supplements a well balanced crop nutrition program. Increased productivity is a result of

proper utilization of the nutrients provided. To achieve the desired results, the levels of major and minor nutrients must be adequate to support the increase in production, quality and conservation.

[Technaflora Plant Products Ltd.](#)

The Technaflora Family of Products

Founded in 1995, Technaflora Plant Products Ltd. is a Canadian owned and operated company located in Vancouver, British Columbia. Boasting a full line of exceptional plant nutrients and additives, with unique products such as *Thrive Alive™* and *Rootech™*, Technaflora Plant Products is a leader in the specialty gardening industry.

At Technaflora Plant Products, we pride ourselves in meeting the needs, and exceeding expectations, of our customers. The total combination of consistent and *superior products*, experience and knowledge, and outstanding customer service, makes Technaflora Plant Products an enterprising and dynamic organization.

Awesome Blossoms: Liquid Flowering Supplement

*"You'll never see plants flower, until you unleash the power:
Awesome Blossoms, the name says it all"*

Awesome Blossoms is scientifically designed to meet the needs of all vigorously flowering plants. A superior formulation of *micro elements*, *phosphates* and *2% humic acids*, Awesome Blossoms is a concentrated liquid that is easy to apply effectively. Regular application of Awesome Blossoms throughout the flowering phase will see your plants achieve maximum flowering density with rich colour and a beautiful bouquet.



B.C. Hydroponic Nutrients: Liquid Hydroponic Fertilizer

B.C. Hydroponic Nutrients *will provide both amateur and professional growers with the confidence and satisfaction that comes with "a superior crop in two simple steps."*



B.C. Boost, B.C. Bloom, and B.C. Grow are professional, highly concentrated vegetative and flowering fertilizers. When used in combination, B.C. Hydroponic Nutrients provide the proper balance of all the essential elements, ensuring that your plants will achieve optimal growth and maximum yield. The specially balanced formula maintains nutrient reservoir pH levels, so that frequent pH adjustment is not necessary. With B.C. Hydroponic Nutrients there are no secrets, and there is no guessing; tested and proven mixing ratios are clearly printed on every label, so that the parts per million (PPM) of any solution can be manipulated with ease!

Mixing Directions

A combination of B.C. Grow and B.C. Boost in the vegetative phase provides high levels of *nitrogen* and *macro* elements that are required by plants to enhance leaf and stem growth. A combination of B.C. Bloom and B.C. Boost in the flowering phase provides high levels of *phosphorus* and *potassium* which will ensure bountiful yields and improved disease resistance.

For Vigorous Vegetative Growth, Add To Water:

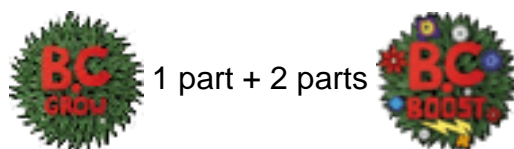

For Magnificent Flowering, Add To Water:

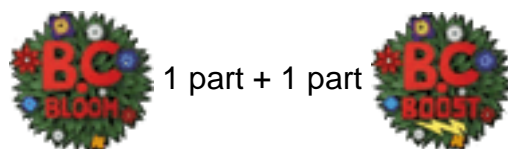

"A superior crop in two simple steps."

B. Seaweed: Liquid Organic Fertilizer

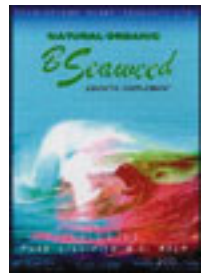

B. Seaweed is an undiluted premium blend of liquefied organic British Columbian sea kelp (*Macrocystis integrifolia*). Sea kelp has been used by coastal farmers for generations as a growth enhancer which enables plants to absorb nutrients more effectively. Technaflora's sea kelp is harvested in accordance with government regulations. To preserve and sustain the resource, the sea kelp is harvested by hand to ensure that the integrity of the kelp bed is preserved for future generations. Ideal for use in soil, hydroponic systems, or as a foliar spray, B. Seaweed is an aggressive, naturally organic way for growers to supplement their regular feeding programs

"Naturally organic British Columbian sea kelp"

Liquid Humus: Organic Supplement

Known to growers for centuries, and recently rediscovered, technical *humic acids* are an excellent natural and organic way to provide plants with a concentrated dose of essential nutrients, vitamins and trace elements. *Humic acids* are complex molecules that occur naturally in soils, peats, oceans and fresh waters, resulting from the decomposition of organic matter. The *humic acids* for Liquid Humus are extracted in the form of salts (humates) from a soft coal, called Leonardite, resulting in a solution of 15% *humic acids*. For use in both soil and hydroponic mediums, Liquid Humus promotes the uptake of nutrients by increasing the permeability of the plant membrane, and by increasing the buffering capabilities of the medium. Liquid Humus has the ability to chelate metals, notably iron, and will absorb and slowly release nutrients and hormones. With the systematic application of Liquid Humus, the end results are greener, healthier plants with more vigour, faster growth, and larger yields.



pH Up & pH Down: pH Regulators

pH is a term used to describe the relative acidity or alkalinity of a solution or medium. Maintaining an optimal pH range is a fundamental growth requirement of all plants. Technaflora's pH Up and pH Down will allow the gardener to control and maintain optimum pH levels.

Technaflora's pH Up and pH Down are made using only the highest quality ingredients: potassium hydroxide and *nitric acid*, respectively. Technaflora's pH Up and pH Down are strong enough to be used sparingly while ensuring that industry standards for safety are met.



Rootech: Cloning Gel

"Put your best genes forward"

Rootech Cloning Gel is a premium formulation of hormones, vitamins and nutrients, ideal for promoting rapid, healthy root development for clones. A thick, rich gel, Rootech adheres to the plant cutting throughout the rooting phase, sealing cut tissue immediately and reducing the risk of embolism or infection.



Rootech comes in a ready-to-use, wide-lid container, into which several cuttings can be dipped at the same time, without fear of tipping or spills. Unique in the industry, and currently registered with the Canadian Food Inspection Agency, under the authority of the *Fertilizers Act* (registration #990008A), Rootech enjoys governmental recognition as a safe and effective product.

There is no substitute for Rootech, ask for it by name.

The Cloning Process

Plants have the amazing ability to regenerate from small pieces of vegetative tissue called *cuttings*. The cloning process is a simple method, which guarantees that the new plants will possess the same genetic qualities as the parent. By selecting parent plants whose genetic qualities maximize the benefits of the crop, cloning ensures that these desired qualities are consistently reproduced in future crops, time after time.

Soluble Seaweed: Organic Powdered Fertilizer

Soluble Seaweed Extract is made from pure, natural, Norwegian kelp (*Ascophyllum nodosum*) harvested from the Atlantic Ocean in eastern Canada. The Norwegian kelp used in our Soluble Seaweed Extract has long been recognized as a highly effective natural plant fertilizer, and has been celebrated for its beneficial qualities, including, enhanced seed germination, promotion of a healthy root system, increased disease resistance, and rapid shoot and stem development.

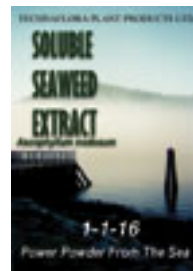

Soluble Seaweed Extract provides over 60 assorted chelated nutrients and growth enhancers, which are readily assimilated by plants. Ideal for use in soil, hydroponic systems, or as a foliar spray, regular application of **Soluble Seaweed Extract** will enable the grower to maximize the benefits of the:

"power powder from the sea."

Thrive Alive B1: All Purpose Plant Tonic



Green
Natural and Organic



Red
Fortified with
Alpha-
Naphthalene
Acetic Acid and
Kinetin

Thrive Alive B1 is a highly effective, safe, affordable, and easy to apply general purpose plant tonic. The professionally balanced formulation contains vitamins, hormones, *macro* and *micro* nutrients, cultured in premium quality organic British Columbian sea kelp. Thrive Alive B1 is an original Canadian vitamin B1 formulation, and it continues to stand alone, unequalled in quality, consistency and strength. Use Thrive Alive B1 with every watering of your plants; it's ideal for house, garden and hydroponic applications.

Thrive Alive B1 will keep your plants green and lush by promoting rapid vegetative growth and it will increase the yield of floral crops by promoting rapid flower development during blossoming. Thrive Alive B1 protects your plants from transplant-related shock and will greatly contribute to the correction of nutrient deficiencies, while promoting vigorous root development for both cuttings and established root systems.

Nutrilife Products - Western Water Farms

Nutrilife is an innovative and growing company, which develops horticultural products for commercial indoor and outdoor use. Nutrilife offers a wide variety of plant fertilizers, nutrients, pesticides, growth enhancements, supplements and calibration solutions. These products are supremely blended for quality and top performance and exclusively distributed by Western Water Farms in Canada and Green Air Products in the United States. Unlike other common fertilizers, Nutrilife products are made from the purest material available to give our customers performance in growing.

Two part fertilizer systems for superior plant growth.

Heavy Harvest Micro

Heavy Harvest Micro is the essential component of the Heavy Harvest feeding system. Heavy Harvest Micro provides Nitrogen, Potassium and Calcium.



Heavy Harvest Grow

Heavy Harvest Grow is for plants in the vegetative stage of growth. When mixed with Micro, Heavy Harvest Grow is a premium blend of food needed to stimulate structural and vegetative growth. The mixture contains high levels of nitrogen and potassium.



Heavy Harvest Bloom

Heavy Harvest Bloom is for plants in the flowering stage of growth. Bloom is mixed with Heavy Harvest Micro to create a mixture that plants need to stimulate plant flowering and yields. The mixture contains high levels of phosphorous and potassium.



NutriGreen Part "A"

NutriGreen Part "A" provides the proper proportions of nitrate nitrogen, calcium and iron chelate to begin the process of building a complete and balanced nutrient.



NutriGreen Part "B"

NutriGreen Part "B" provides proper proportions when used with NutriGreen Part "A" for the vegetated stage of growth to build a complete and balanced grow nutrient.



NutriGreen Part "C"

NutriGreen Part "C" provides the proper proportions when used in combination with the **NutriGreen Part "A"** for flowering and fruiting cycle to build a complete and balanced high yield nutrient.



Growth Enhancers and Pest Control

PyroClay

PyroClay is an excellent source of silicon and clay. Silicon is the second most abundant element in plants and without it they cannot survive. However, growers commonly overlook this fact. PyroClay is an excellent source of silicates, which are a decisive factor in the healthy development of plants, not only for the silicic acid content, but also for trace elements, ph buffering, and enhancement of the microbial population in the growing medium.



SM-90

SM-90 is an organic based pest inhibitor, which discourages pest infection, fungus and root rot. SM-90 is prepared from natural plant oils and blended with the finest quality and delivered to you, our customer. The organic composition of SM-90 results in it's ability to be biodegradable and is also non-toxic to humans, animals and plants.



Vac Roc

Vac Roc has been developed from traditional European technology, which we then import to North America. Using a special manufacturing process of heating raw material to a temperature of 1600 degrees celsius hot molten mass is ejected onto rotors, which spin at a high rate of speed. Often called fiberization process, centrifugal force produced from the spinning rotors are then used to draw fibers from the molten mass to produce a thick dense blanket of Vac Roc. A phenolic agent is then applied to bind the molten blanket together, followed by wetting agents and then cured in an oven to produce Vac Roc.



Commercial lettuce growers in New Zealand using Vac Roc have reported that lettuce crops consistently mature 5 to 6 days ahead of other versions of rockwool.

Vac Roc propagation cubes and blocks maintain a temperature 1-2 degrees Celsius higher than the leading competitors, which induces faster germination.

Vac Roc's moisture retention characteristics are comparable to those of the leading competitors.

The evaporative rates of Vac Roc are lower than those of the leading competitors, lowering the possibility of water stress.

Western Water Farms
103-20120 64th Ave
Langley, BC V2Y 1M8
Canada
Tel: (604) 533-9301
Fax:(604) 533-2834
Toll Free: 1-800-533-9301
Website: <http://www.western-waterfarms.com>
Email: nutrlife@direct.ca

Mixing Hydroponic Juices.

Plant nutrient is available from the hydro shop (hydroponics supplier). These concentrated nutrient solutions are diluted in water to make the hydro juice to feed the plants. Simple nutrient concentrates are easier and cheaper (from \$8 for 750 ml.). But some of the nutrient chemicals precipitate out as flakes before use and are lost. Two part nutrient concentrates (from \$20 for 2L.) don't have this problem. By separating nutrient chemicals they allow more nutrients to be added same amount of water.

Mixing the two part hydro juice. Half fill the nutrient tank, mix the required amount of concentrate Part A in the water. Fill the tank and mix required amount of concentrate Part B. Check the instructions on the containers before buying or using either type of nutrient concentrate.

List of the 16 elements all plants need to grow and concentrations in solution.

NAME	ELEMENT	PPM
Nitrogen	N	96
Phosphorous	P	48
Potassium	K	246
Calcium	Ca	123
Magnesium	Mg	48
Sulfate	SO	412
Iron	Fe	3
Manganese	Mn	0.5
Zinc	Zn	0.08
Copper	Cu	0.06
Boron	B	0.5
Molybdenum	Mo	0.1

The 16 elements in the table above are derived by plants from the atmosphere or from minerals in the soil, Dr. Alan Cooper proposed this formulation for his NFT hydroponic system, a typical nutrient solution.

The table below contains the ingredients to be added to 1000 liters of water, in practice the solution is concentrated in to 2 parts, preventing loses from chemical reactions. Fill two 10 liter plastic bottles

with water mark that part "A" and part "B". Dissolve calcium nitrate and EDTA iron in part "A" and the rest of the ingredients in part "B".

Concentrates are used by adding 100mls.(cc's.) of each part per 10 liters of water. The concentration of the final solution can be measured with a EC meter (electrical conductivity meter), this reads the conductivity of the nutrient solution.

Nutrient Chemicals	Weight in grams
Potassium dihydrogen phosphate	263.00
Potassium nitrate	583.00
Calcium nitrate	1003.00
Magnesium sulphate	513.00
EDTA iron	79.00
Manganous sulphate	6.10
Boric acid	1.70
Copper sulphate	0.39
Ammonium molybdate	0.37
Zinc sulphate	0.44

Hydroponic Pumps.



To figure out the pump size you need, multiply the drip emitter size by the number of drippers you have and then multiply that figure by 2. For example: 4gph x 10 (drippers) = 40 x 2 = 80gph. You will need an 80gph pump.

[Media and Supplies.](#)

[Comparing Growing Media.](#)

[Buckets, Nets, Baskets.](#)

[Metering and Measurement.](#)

[Super Nutrients.](#)

[Lighting Equipment.](#)

Media and Supplies.

There are many types of growing media that have been successfully used for hydroponics and there are probably many more that have never been tried.

Some are:

1. ***Perlite*** - a volcanic rock a gray obsidian, that has been heated to 1500 degrees F in a kiln and expanded. It is a light weight porous material that can "wick" water from a bottom container of water.
2. ***Ceramic grow rock*** - a clay material also called Geolite, which is often used for aquaculture because the porous material is a good media for growing bacteria to clean water. It does not break down.
3. ***Rockwool*** - a material made from rock spun into a fiber like material. A phenol based resin is added as a binder. Rockwool also tends to increase the pH of the water.
4. ***Pea gravel*** - this media is just simple gravel but has been graded for size and shape. It is not a porous media so it does not wick water from below and must be used in a system that provides aeration for the water. It can be used to grow bacteria as well as plants.

There are many other types of media used in hydroponic systems. Some have special advantages and disadvantages.

Sand - Many sands, such as beach sand, have salts already in the media, that can cause problems in

hydroponics. However, sand is a useful media that retains water. It has to be sterilized between crops.

Sawdust - where there is an extensive timber production, sawdust may be available. The species of tree is important, with softwoods decaying more slowly than hardwoods. Douglas fir and western hemlock work great but red cedar is toxic to plants. Some sawdust is from logs soaked in salt water and is therefore toxic to plants.

Peat - There are three types of peat: peat moss, reed sedge and peat humus. Peat is very acid and can lower the pH of the nutrient water. It breaks down after one or two growing seasons.

Vermiculite - This is a volcanic mica which has been popped in a kiln. It is a magnesium aluminum iron silicon material that can be compressed and lose its porosity.

Pumice - A silicon material of volcanic origin can break down after repeated use.

No media - There are many hydroponic systems that use no media whatsoever. The plant is usually started in a small piece of rockwool, or specially designed plastic collar. The plant is then placed in a growing tube or container that applies nutrient water to the roots.

GROWING MEDIUM

by Professor Hydro

There are probably hundreds of different kinds of growing medium, anything that a plant can grow in is considered a growing medium. There are manmade as well as organic (natural) mediums. Even plain old AIR can be an effective growing environment for roots.

I have been asked many times what growing medium is the best. This is like asking what is the best color? Or what is the best kind of vehicle to own. Sometimes the answer depends on the job you need it to do. You wouldn't try to use a soilless mix in an Aeroponic system and you don't plow a field with a Rolls Royce limousine. However, if you want to build a Non-Recovery Drip hydroponic system then the soilless mix would be an excellent choice, and a John Deere tractor can handle the field (save the Rolls for a night on the town, pick me up at 8). What I'm trying to say, is that the best growing medium for your purpose depends on many variables. The type of system you are using, what kind of crop you are growing and local environment are just some of the many determining factors involved when choosing a growing medium. There may be several mediums that will work equally well for your particular needs. Many times it boils down to availability, price or personal preference.

I have listed the most popular types of growing mediums below, click on the name to view details about the general use, advantages and disadvantages, and particular characteristics of the specified growing medium.

Growing Medium Index

[Oasis cubes](#)

[Expanded Clay
Pellets](#)

[Rockwool](#)

[Coconut Fiber](#)

[Sand](#)

[Gravel](#)

[Perlite](#)

[Sphagnum Moss](#)

[Water](#)

[Vermiculite](#)

[Fiberglass
Insulation](#)

[Saw Dust](#)

[Soilless Mix\(s\)](#)

[Air](#)

[Lava Rock](#)

Oasis cubes



These lightweight pre-formed cubes are designed for propagation. A very popular medium for use when growing from seed or from cuttings. This product has a neutral pH and retains water very well.

The cubes are meant to be a starter medium and come in three sizes up to 2" x 2". They can be easily transplanted into practically any kind of hydroponic system or growing medium (or into soil).

Coconut Fiber



Coconut fiber is rapidly becoming one of the most popular growing mediums in the world. In fact it may soon be ***THE*** most popular. It is the first totally "organic" growing medium that offers top performance in hydroponic systems. Coconut fiber is essentially a waste product of the coconut industry, it is the powdered husks of the coconut itself.

There are many advantages - it maintains a larger oxygen capacity than rockwool, yet also has superior water holding ability than rockwool which is a real advantage for hydroponic systems that have intermittent watering cycles.

Coconut fiber is also high in root stimulating hormones and offers some protection against root diseases including fungus infestation. Dutch growers have found that a mixture of 50% coconut fiber and 50% expanded clay pellets is the perfect growing medium.

One word of caution about coconut fiber, you must be careful when you purchase coconut fiber. There is a commonly available, lower grade of coconut fiber that is high in sea-salt and is very fine grained. This lower grade coconut fiber will lead to disappointing results when used in a hydroponic system.

Perlite



Good old perlite! It's been around for years, mainly for use as a soil additive to increase aeration and draining of the soil. Perlite is a mined material, a form of volcanic glass that when rapidly heated to more than 1600 deg. f. it pops much like popcorn as the water vaporizes and makes countless tiny bubbles.

Perlite is one of the best hydroponic growing mediums around. Used by itself or as a mixture with other mediums. Perlite is commonly used with vermiculite (a 50 - 50 mix is a very popular medium), and is also one of the major ingredients of soilless mix's. perlite has good wicking action which makes it a good choice for wick-type hydroponic systems. Perlite is also relatively inexpensive.

The biggest drawback to perlite is that it doesn't retain water well which means that it will dry out quickly between watering. The dust from perlite is bad for your health so you should wear a dust mask when handling it.

Vermiculite



Vermiculite is another mined material. In its natural state it resembles mica rock, but when quickly heated it expands due to the generation of interlaminar steam.

Vermiculite is most frequently used in conjunction with perlite as the two complement each other well. Vermiculite retains moisture (about 200% - 300% by weight), and perlite doesn't so you can balance your growing medium so that it retains water and nutrients well but still supplies the roots with plenty of oxygen. A 50/50 mix of vermiculite and perlite is a very popular medium for drip type hydroponic systems as well as ebb and flow systems. Vermiculite is inexpensive.

The major drawback of vermiculite is that it retains too much water to be used by itself. It can suffocate the roots of plants if used straight.

[◀ PREVIOUS](#)

[◀ INDEX](#)

[NEXT ▶](#)

Hydroponic University is brought to you as a service of [Simply Hydroponics and Organics On-line](#) as part of our consumer education program. We welcome your feedback, your ideas are what makes this site work for you. [Contact Us](#) with any ideas or questions. To view the growing medium section of our catalog [CLICK HERE](#).

Soiless Mix(s)



There are many kinds of soiless mix's containing a vast assortment of ingredients. Most contain things like Spagham moss, Perlite and Vermiculite.

These kind of growing medium are usually considered organic and are frequently used for container gardening wick systems and on-recovery drip systems. They can be used in recovery systems, however most of these mixes have some very fine particles that can clog pumps and drip emitters if you don't use a good filtration system (NOTE: The professor says that you can use panty hose as a filter, use on the return line and on the pump inlet to filter out the fine particles).

Most soiless mixes retain water well and have great wicking action while still holding a good amount of air, making them a good growing medium for a variety of hydroponic and organic gardens.

Expanded Clay Pellets



This man-made product is often called grow rocks and is an extremely good growing medium. It is made by baking clay in a kiln. The inside of the clay pellets is full of tiny air pockets (much like lava rock) which makes this a light weight medium (some of the pellets even float).

The pellets are great for ebb & flow systems or other systems that have frequent watering cycles (clay pellets do not retain much water so they need to be watered often so that the roots of your plants do not dry out). The rocks are often mixed with other growing medium(s) to increase oxygen retention.

Expanded clay pellets are rather expensive but they are one of the few kinds of growing medium that is easily reusable, which makes them a good choice for the long term. After you harvest your crop you can wash the clay rocks to remove all the old roots and then sterilize them with a 10% bleach and water mix (one part bleach to 9 parts water). The grow rocks can also be sterilized by using a mixture of Hydrogen Peroxide and water (use 1 or 2 teaspoons of 35% food grade hydrogen peroxide per gallon of water).

Sand

The Hanging Gardens of Babylon were thought to be sand-based hydroponic systems (what else would you use if you're stuck in the middle of the desert?). This is probably the first hydroponic growing medium ever used, and it is still being used successfully.

Sand has a tendency to pack tightly together reducing the amount of air available to the roots. So you should use a coarse builders sand or mix the sand with perlite or other material that will increase aeration.

Sphagnum Moss



A completely natural medium that is used as a major ingredient in most soilless mixes. Sphagnum moss can also be used by itself in a hydroponic system. Sphagnum moss makes a good fluffy growing medium that retains a high percentage of air and retains water well also.

The major problem with this growing medium is that it can decompose over time and you can get small particles that can plug up your pump and (or) drip emitters if you are using a recovery type hydroponic system.

Fiberglass Insulation

I have never personally used fiberglass insulation but I have known several people that have used it in their hydroponic systems. There were mixed reviews, and none of those people are still using it.

The most common complaint that I have heard is that it retains too much water, not leaving room for enough air around the roots, which can cause problems with the plant. I have heard that sometimes the insulation is treated with chemicals for fireproofing, etc., so unless you want to experiment, the Professor would not recommend using fiberglass insulation.

Air

People talk about hydroponic systems that do not use any growing medium at all. As far as I know, that would be impossible. The plants roots would have to growing in a complete vacuum. This would instantly kill the plant.

Air on the other hand is frequently used as a growing medium. Aeroponic systems have the plants roots hanging in air and are periodically sprayed with a nutrient solution.

The biggest advantage to growing in air is the roots get all the oxygen they could possibly need (roots need plenty of oxygen). Another major advantage to air is it's cost (Free is hard to beat!). There is no disposal problems as with some other mediums either.

The biggest problem associated with aeroponics is it's susceptibility to power failures and pump or timer failures. There is **NO** buffer. The roots could start to dry out within minutes and the loss of the total crop can come very quickly.



Gravel

This growing medium has been used for years and works well. Many of the earlier hydroponic systems that were commercially available to the public were gravel based ebb / flow (flood and drain) type systems.

Gravel supplies plenty of air to the roots, but doesn't retain water, which means that the plants roots can dry out quickly if they are not watered enough. Another drawback to gravel is its weight, it's very heavy, and toting it around is difficult.

Gravel is usually fairly cheap (depending on where you live) and easy to find. You can easily reuse gravel as long as you wash and sterilize well between crops. After you harvest your crop you can wash the gravel to remove all the old roots and then sterilize them with a 10% bleach and water mix (one part bleach to 9 parts water). The gravel can also be sterilized by using a mixture of Hydrogen Peroxide and water (use 1 or 2 teaspoons of 35% food grade hydrogen peroxide per gallon of water).

Water



When most people think of hydroponics they think of plants with their roots suspended in water with the nutrients dissolved in it. This is a very popular method of growing hydroponically and there are several types of systems that use water as the growing medium (deep flow N.F.T., shallow flow N.F.T. and water culture are among the most popular).

Water is a critical element in the growth of plants anyway, so using it as the growing medium makes a lot of sense. Care must be taken when selecting a system that uses water as the only growing medium, to ensure that the plant(s) are compatible. For example: Water-loving plants like "Bibb" type lettuce does best in a water-culture system where the plants float directly on the surface with their roots hanging into the water, but the same system will not work as well for most other plants because there is too much water and not enough oxygen. These other plants will do much better in a N.F.T. system where more oxygen is available to the roots because the plants are suspended above the level of the water.

Saw Dust

This growing medium has had limited success. There are many variables that determine how well saw dust will work, most predominantly is the KIND of wood that the dust is made from. Some kinds of wood can give off chemicals that are detrimental to the health of the plant(s). Another problem with saw dust is that it will decompose, which can cause problems. Saw dust also retains a lot of moisture so care must be taken not to over water.

The best thing about saw dust is that it's usually free. I don't recommend using saw dust unless you are into experimenting.

Lava Rock



Lava rock has been used successfully for years, it is light-weight and retains a fair amount of water in it's holes and pores. It is used most often in ebb & flow (fill & drain) systems with frequent watering cycles.

With a good selection of first rate growing mediums available lava rock is used much less often these days. The drop in popularity is due mostly to the fact that the sharp edges of the rock can cause root damage to the plants, and in most areas of the world it can be hard to find lava rock that is not chemically treated.

Choosing a Media

The hydroponic plant roots need to have both nutrient water and air.

If the water is pumped or poured only once or a few times a day, there should be enough media around the plant roots to capture and retain some water. This means the media should be somehow able to capture some air and some water. That is why the "best" hydroponic media are porous materials like pumice, perlite, grow rock and rockwool.

Also, in a system that is pumped or pored a few times a day, there should be some reservoir of extra water for the plant. If the plant runs out of water, first it shuts down or quits working, and then it starts to die.

If the plant roots have a growing area, with both water and air, and a water reservoir, the plant will continue to thrive and grow. If there is a small plant root growing area, or the plant roots run out of water, the plant does not thrive.

If the plant roots "see" extra water below the root growing area, the plant does not have to grow extra root to "find or follow" the water. So the plant can relax about its water supply and use its energy to grow more above ground.

In the simple tub system, there is a root growing area, the water reservoir, and the overflow water container. There is a way to design this to help the plant grow.

The plant root growing area is the area where the roots see air and water. How much area is needed for the plant partly depends on the type of media, how it holds both air and water.

Perlite is an excellent media because it "wicks" water, or draws up water from below. The best mixes of water and air are in the 50-60% range, and with perlite this area can be up to about 4 inches above the

water level.

If a media like perlite is used, less area is required for the root growing area.

Comparing Growing Media.



Many types of growing media have been used for hydroponics and there may be many more that have never been tried. Some of the common types of media that are used in hydroponics are:

Perlite - a volcanic rock of gray obsidian, that has been heated to 1500 degrees F in a kiln and expanded. It is a lightweight porous material that can "wick" water from a bottom container of water.

Ceramic grow rock - a clay material also called Geolite, which is often used for aquaculture because the porous material is a good media for growing bacteria to clean water. It does not break down.

Rockwool - a material made from rock spun into a fiber like material. A phenol-based resin is added as a binder. Rockwool also tends to increase the pH of the water.

Pea gravel - this media is just simple gravel but has been graded for size and shape. It is not a porous media so it does not wick water from below and must be used in a system that provides aeration for the water. It can be used to grow bacteria as well as plants.

Different media provide different positive and negative affects for a hydroponic system. Also, some are more available or cheaper than others are Some have an environmental impact greater than others do, in the ways they are gathered or manufactured.

If you can find perlite, it is probably the best media you can use for a home system. Perlite is forgiving for the beginner because it will retain water for three or four days if you forget to water your system. If Perlite is not available, gravel is a good second choice because it will allow for a once a day watering and does not break down.

In this experiment you can compare plant growth behavior in 4 types of growing media.

1. Prepare four growing pots in a water container.
2. Fill each with a different media such as gravel, perlite, sand, etc.
3. Plant a bean or pea seed about 1 inch below the surface of the media in each of the four pots.
4. Place the pots sunlight or sufficient artificial light and record signs of growth for each media every day.

DATA RECORD SHEET

Inspect, observe and record data about the plant's condition. Once the plant has germinated and broken through the growing media, include an illustration of its appearance and begin recording on Day 1.

Buckets, Nets, Baskets.



3.5 Inch Baskets

These baskets are made sturdy with flow-through holes on the sides and bottom to prevent rock fallout, yet large enough to readily assist plant growth.



5 Inch Baskets

These baskets are made sturdy with flow-through holes on the sides and bottom to prevent rock fallout, yet large enough to readily assist plant growth.



8 Inch Baskets

This very sturdy basket has plastic nodes and flow-through holes on the bottom, raising it slightly off the surface which it sits, assisting plant root growth.



10 Inch Baskets

This pot is designed to sit comfortably as an insert in a 20 or 10 litre pail, and is very sturdy in construction.

Metering and Measurement.



CMS Nutrient Meter.

The Nutradip CMS Nutrient Meter, with automatic temperature compensation, is a new way of measuring the total dissolved solids in your water. The system uses a remote probe which stays in your reservoir and an AC powered display unit. Total Dissolved Solids (TDS) or salts, are found in all aqueous solutions. Dissolved solids can be beneficial in controlled concentrations, but can quickly change to undesired levels. Salts can accumulate to toxic levels in sensitive environments like plants, aquariums or drinking water, therefore the need to measure TDS is very important. The Nutradip Continuous Monitoring System (CMS) is an effective TDS management tool.

Tri-Meter.

The Nutradip Tri-Meter (CMS) Continuous Monitoring System Meter gives you the ability to monitor pH level, Total Dissolved Solids (TDS) and Temperature all at the same time. This portable/continuous monitoring system requires no batteries, just plug it in a AC wall receptacle and the meter will remain in a calibrated mode for months.



The pH Meter is a new way of measuring the acidity or alkalinity in your water. It is a continuous monitoring pH meter with automatic temperature compensation. The system uses a remote probe which stays in your reservoir and an AC powered display unit.

Potential of Hydrogen (pH), are found in all aqueous solutions. Potential Hydrogen can be beneficial in controlled concentrations, but can quickly change to undesired levels of acidity of alkalinity of the solution. pH can accumulate to toxic levels in sensitive environments like plants, aquariums or drinking water, therefore the need to measure pH is very important. The

Potential Hydrogen Monitoring System is an effective pH management tool.

The pHMS operates very easily. Simply plug in the power supply, drop 2/3 of the probe into your solution, and in minutes your display will show an accurate temperature compensated measurement from your solution. Once placed, the probe can remain there indefinitely.

This economical meter indicates the pH measurement on a large 7 segment display. The replaceable electrode (included) attaches to the meter with a standard BNC connector and comes with a 0.9m (3 ft.) cable.

The Nutradip Tri-Meter, with automatic temperature compensation, is a new way of measuring the total dissolved solids in your water and monitoring temperature at the same time. The system uses a remote probe which stays in your reservoir and an AC powered display unit.

The Light Monitoring System (LMS).

In every green house, density of light is a major factor for the plants. For this reason, North American Greenhouse Supplies has introduced the world's portable light meter. The Light Monitoring System (LMS) is capable of measuring a wide range of luminous of light for any hydroponic grower. This is brought to you using the latest electronic technology and using a silicon pin photodiode enhanced for blue sensitivity.

The LMS meter is very easy to operate. It is designed to measure the luminous of light in the unit of Lux. It has only an on/off switch to display readings on a large seven segment LCD display. The LMS meter comes in a specially designed hand held case



pH Meter.

The Nutradip pH Meter is a new way of measuring the acidity or alkalinity in your water. It is a continuous monitoring pH meter with automatic temperature compensation. The system uses a remote probe which stays in your reservoir and an AC powered display unit.

Potential Hydrogen (pH), are found in all aqueous solutions. Potential Hydrogen can be beneficial in controlled concentrations, but can quickly change to undesired levels of acidity or alkalinity of the solution. pH can accumulate to toxic levels in sensitive environments like plants, aquariums or drinking water, therefore the need to measure pH is very important. The Potential Hydrogen Monitoring System (pHMS) is an effective pH management tool.



Super Nutrients.

[Secrets to Hydroponic Nutrients.](#)

[Color Pictures of Mineral Deficiencies in Plants.](#)



Super Veg A & B - All essential trace elements (micros) are included for lush vegetative growth. Super Veg A & B is pH balanced to achieve 6.0 to 6.5, with little to no pH up/down required. When ordering, order **both** A & B.

Super Bloom A & B - Delivers an instant source of nutrient uptake, as well as the proper trace elements (micros) to gain large, multiple blooms. pH balanced, will not burn plants and will increase yields dramatically. When ordering, order **both** A & B.

An awesome combination when added to most nutrient solutions. Dutch scientists, after measured analysis and research, have isolated and distilled an enzyme that promotes rapid plant cell division and increased cell wall thickness. While many nutrient supplements have made various claims of increased yields and flavor enhancement, **B-CUZZ delivers !**

- Totally organic
- Totally clean for hydroponic applications
- Descriptive brochure with directions included with each order.



Dynagro is a one part formula containing all macro, micro and trace elements

Grow - Grow is a mixture made for the vegetative growth stage.

Bloom - Bloom is a mixture made for the flowering stage.



General Hydroponics The Flora series is a three part nutrient formula. All three are mixed in varying proportions to suit plant variety and growth stages. Recipes are on bottles. General Hydroponics recommends a 3-2-1 ratio for aggressive plant growth. In the vegetative stage, a mix of 3 teaspoons Grow, 2 teaspoons Micro, 1 teaspoon Bloom per gallon of water and in the flowering stage, 3 teaspoons Bloom, 2 teaspoons Micro and 1 teaspoon Grow per gallon of water are recommended.

Instructions

In rockwool and hydroponics, it is important to know the quality of your water. In case of doubt, please refer to your closest retailer or contact us directly, we will be happy to help you. For your cuttings and for smaller containers like our WaterFarm, it is a good idea to mix 1/2 tap water and 1/2 demineralized or rain water.

A RULE OF THUMB FAVORED BY OUR MORE EXPERIENCED CUSTOMERS IS THE «1-2-3» FORMULA FOR FAST GROWING ANNUALS.

	FloraGro	FloraMicro	FloraBloom
Seedlings and Cuttings	2	2	2
Vegetative stage	3	2	1
Flowering stage	1	2	3

These are proportions for each nutrient.

Although there are lots of different recipes, we suggest that the EC recommendations to follow be:

Seedlings and Cuttings 0.3 à 0.5 (250 à 350 PPM)

Vegetative stage 1.2 à 1.8 (750 à 1150 PPM)

Flowering stage 0.9 à 1.3 (700 à 950 PPM)

These ranges are for water culture. Slightly increase concentration in rockwool. In soil, use only 1/4 of that strength to apply every other watering. Before mixing, adjust your water to a pH of 5.5 to 6.5. Readjust after mixing if needed.

Easy Measurement :

Use a syringe or the cap of your 1-liter bottles

For 2 liters of pure water : 1ml FloraGro + 2ml FloraMicro + 3ml FloraBloom = 1.00 EC

OR : 1 full cap= 10 ml

For 20 liters of pure water : 1 cap Gro + 2 caps Micro + 3 caps Bloom = 1.00 EC



One Part™ Bio Active Nutrient has been on our mind for a long time.

To answer a growing demand, we wanted a one part nutrient that would not be just another one part fertilizer, but a product that would be up to General Hydroponics' customary high standards: user-friendly, comprehensive, and highly efficient.

At the same time, we wanted it to enhance active principles in plants, specially medicinal, aromatic and culinary plants and herbs.

APPLICATIONS

HARD WATER :

For 10 L of water	Total Gro	Total Bloom	EC
Cuttings and seedlings Or mix Total Gro and Total Bloom together	7 à 10 ml 5 ml TG	0 + 5 ml TB	0.3 à 0.5 0.3 à 0.5
Vegetative stage	40 à 50 ml	0	1.2 à 1.8
Flowering and fruiting	0	80 ml	1.2 à 1.8
Foliar spray (vegetative)	7 à 10 ml	0	0.3 à 0.5
Foliar spray (flowering)	0	15 ml	0.3 à 0.5

SOFT WATER :

Same proportions as in hard water.

Add any source of ordinary calcium (Gypsum, Plaster of Paris, chalk powder, etc...) to your solution in the proportion of 4 g/ 10 Liters.

- Before mixing, adjust your water to a pH of 5.5 to 6.5. Verify your pH level regularly
- These proportions are for hydroponics. For all substrates (clay pebbles, rockwool, coconut fiber, etc...). In soil, use ¼ strength, and apply every watering.
- When needed, add plain water with adjusted pH, to avoid salt build-up.
- Last days: add water with adjusted pH, without fertilizers
- **Notice:** During transition between growing and flowering, simply replace Total Gro with Total Bloom, without changing the solution.

GROWRITE™ AND BUDRITE™

Growrite™ and Budrite™ is a two part inorganic nutrient which was developed ten years ago in Holland and have developed through this time with the latest technology in plant nutrition. Growrite and Budrite are "crop specific" and have been formulated with the highest quality salts and trace elements and fully chelate trace elements. During the manufacturing stages these nutrients are subject to strict quality control to ensure quality and product uniformity.

Growrite™ and Budrite™ nutrients are fully dissolved (no sediment or precipitation) and therefore the only nutrient on the Australian market to achieve this. These nutrients are also by far the most concentrated hydroponic nutrient on the market. Growrite™ and Budrite™ nutrients are verly economically priced and they have comprehensive and easy to follow instructions .



Growrite™ and Budrite™ are registered trademarks.

Growrite™

Nutrient Analysis

Total Nitrogen	6.74
Phosphorus as water soluble	3.49
Total Potassium	10.39
Calcium	3.82
Magnesium	0.86
Sulphur	1.12
Iron	0.0274
Boron	0.1541
Manganese	0.3281
Zinc	0.0389
Copper	0.0339
Molybdenum	0.0167

Budrite™

Nutrient Analysis

Total Nitrogen	4.15
Phosphorus as water soluble	5.46
Total Potassium	12.00
Calcium	3.82
Magnesium	1.10
Sulphur	1.44
Iron	0.0274
Boron	0.1541
Manganese	0.3281
Zinc	0.0389
Copper	0.0339
Molybdenum	0.0167



A carefully selected blend of 100% organic fertilizers formulated to promote strong, extra-large, multiple blooms along with sweeter fruit and thick seed pods. An environmentally friendly mix of premium select grades of worm castings and bat guano, Big Bloom is a potent, fast-acting source of nutrients for both plants and soil. Offers a balanced element mix of .08-3.0-1.0 for indoor or outdoor potted plants, roses, vegetables, herbs, flowers, fruit trees, berries, flowering shrubs, fuchsia, African violets, orchids, gardenias, hibiscus, ornamental flowering trees, azaleas, rhododendron, annuals and perennials. A liquid concentrate which is mixed 4 tablespoons per gallon.

Derived from Ammonium Phosphate, Ammonium Nitrate, Potassium Nitrate, Calcium Nitrate, Monopotassium Phosphate, Magnesium Sulfate, Boric Acid, Cobalt Sulfate, Copper Sulfate, Iron EDTA, Ammonium Molybdate, Zinc Sulfate, Chelating Agent - Tetrasodium Ethyl.

Guaranteed Analysis	
Total Nitrogen (N)	
7.1% Ammoniacal Nitrogen	
12.9% Nitrate Nitrogen	
Available Phosphoric Acid (P2O5)	
Soluble Potash (K2O)	
Calcium (Ca)	
Magnesium (Mg)	
Sulfur (S)	
Boron (B)	
Cobalt (Co)	
Copper (Cu)	
Iron (Fe) 0.20% chelated	
Manganese (Mn) 0.05% chelated	
Molybdenum (Mo)	
Zinc (Zn)	



Eco's formulas are buffered and pH adjusted and contain the appropriate amounts off all major and trace elements known to be required by plants. EcoGrow is a highly concentrated formula balanced for the growth stages of most plants. EcoBloom is a low-nitrogen, high-phosphorous mix to slow vegetative growth and promote flower and fruit production. Both formulas contain ample amounts of nitrogen, potassium, calcium, magnesium, and trace elements to keep plants healthy and vigorous throughout their life cycle.

The Genesis Formula has been provided for you by the same people who have been bringing you quality products to this industry for over a decade, these products have demonstrated our ability to design the types of systems you need to make your business of hobby easier, more profitable and more fun. Our products have, and will continue to reflect the finest of today's technologies. "The Genesis Formula" is no exception. Our chemists and horticultural staff have spent years in the lab and greenhouses coordinating their efforts to formulate the most complete feeding program available today. "The Genesis Formula" is innovative in it's design and composition providing the most versatile nutrient package on the market. The four part system allows flexibility to construct nutrient blends to meet the nutritional requirements of any crop in any stage of growth.

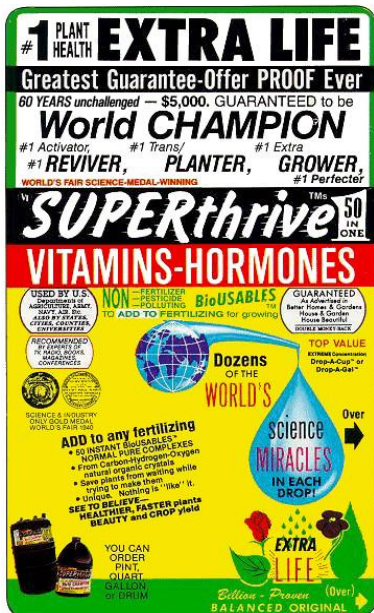

A classic vitamin-hormone supplement, Superthrive has been used for decades. Its consistent results as a plant stimulant and tonic are famous. Of all the products that you will find on this site, none come more highly recommended than Super Thrive. I began using it over 25 years ago, and I consider it as necessary to successful bonsai cultivation as tools or pottery. One drop per gallon will help revive an ailing bonsai, increase growth and give more, longer lasting blooms. When you repot or root prune a bonsai, eight to ten drops per gallon used for a 15 minute soak will dramatically reduce transplant shock and losses. It also works wonders on house plants.

From the richest source of agronomically effective and organically certified plant active humates. It is known that humates work best when applied continuously during the growing season. Diamond Black is the only granular Leonardite proven soluble during a single season. Humates released into the plant's environment regulate the flow and enhance the transport of nutrients. Blend with rooting media, Diamond Black will slowly break down adding humates to the root environment. This is a pure mined material and meets all organic standards for crop production.

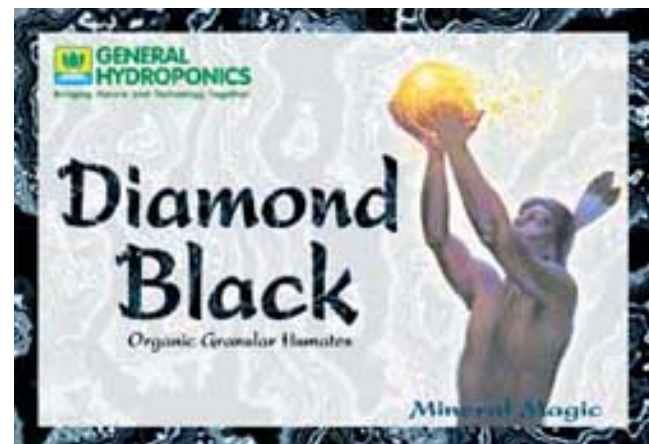

Diamond Black is a unique form of Leonardite containing an

exceptionally high percentage of beneficial plant active organic humic and fulvic acids. Diamond Black is rich in organic substances beneficial to plant growth and affords growers the advantages of natural organic matter in a highly available and easy to use form.

- Hundreds of University studies have proven Humates increase plant growth and yield.
- Increases the availability and uptake of plant minerals and nutrients.
- Derived from the only Leonardite source with proven solubility.
- Meets guidelines for organic production.

Diamond Black can be applied to all cultivated plants including fruits, flowers, vegetables, trees, vines and ornamentals. Use in soil, potting mixes, soilless rooting media and hydroponics.

Directions for use

Hydroponics

Mix with hydroponic or conventional growing media such as potting mixes, soil, coconut fiber (CocoTekä), clay pebbles (GroRoxÒ), rockwool or Perlite. Blend at a rate of 15030 grams per liter media (2-4oz per gal).

Secrets to Hydroponic Nutrients.

In the time plants have evolved on Earth, they have adapted to utilise five major resources in order to grow. These are Light, Water, Oxygen, Carbon Dioxide, and mineral elements. From these, plants can synthesise a wide range of organic molecules required for life. Of these five factors, it is the mineral element requirements of plants which we aim to provide through the use of hydroponic or soilless culture, and under optimum conditions of light and temperature the productivity of crops is largely dictated by the mineral composition in the root zone.

As hydroponic growers and suppliers, it is therefore worth taking a look at what elements are actually required for plant growth, what their purpose is inside the plant, and what levels and ratios are most appropriate for optimising plant growth in a range of conditions.

Hydroponic Elements - Why we need them ...

The elements required for plant growth include the following.

Nitrogen

Nitrogen is a component of all amino acids in proteins and enzymes used in plant tissue, as well as flavour compounds and lignin, and as a result the entire plant metabolism depends on nitrogen supply.

Example of Amino Acid containing NITROGEN : $\text{HOOC}-(\text{CH})_n-\text{NH}_2$

Without nitrogen, plant growth ceases, and deficiency symptoms rapidly appear. Most obvious deficiency symptoms are yellowing or purple colouration of the older leaves, thin stems, and low vegetative vigour. Nitrogen is readily mobilised within the plant, so deficiencies first appear as symptoms on the older foliage. Excess nitrogen, or specifically a high nitrogen to carbon ratio within the plant, predisposes the plant to lush soft growth, usually undesirable for commercial crops and can retard fruitset, promote flower abscission, and induce calcium deficiency disorders as fruit develop.

Nitrogen is supplied as nitrate in the hydroponic nutrient solution, usually from sources calcium nitrate, and potassium nitrate (Saltpetre). Occasionally, for example under low light conditions, a small amount of nitrogen is supplied in the

ammonium form from compounds such as ammonium nitrate or ammonium phosphate, but this should be limited to less than 10% of the total nitrogen content of the nutrient solution to maintain balanced vegetative growth and avoid physiological disorders relating to ammonia toxicity. Urea should never be used in hydroponics.

Potassium

Potassium is a key activator of many enzymes, especially those involved with carbohydrate metabolism. Potassium is also responsible for the control of ion movement through membranes and water status of stomatal apertures.

Potassium therefore has a role in controlling plant transpiration and turgor. It is generally associated with plant 'quality' and is necessary for successful initiation of flower buds and fruit set. As a result the levels of potassium in nutrient solutions are increased as plants enter a 'reproductive' phase, and as crops grow into lower light levels, in order to maintain nutrient balance in solution. Symptoms of potassium deficiency are typically, scorched spots towards the margins of older leaves, along with generally low vigour and susceptibility to fungal disease. Crops such as tomatoes can almost double their uptake of potassium during fruiting. An ideal source of potassium for hydroponics is monopotassium phosphate, along with potassium nitrate. Potassium sulphate can be used as an additive to boost potassium levels without affecting nitrogen or phosphorous. Potassium chloride should be used sparingly if at all, to avoid excessive chloride levels in solution.

Phosphorous

The energy utilisation process within plants relies on bonds between phosphate molecules - energy is stored and released by the compound adenosine triphosphate (ATP).



Phosphorous is an integral part of the sugar-phosphate molecules used in respiration and photosynthesis, and is a major component of all cell membranes formed using phospholipids.

NUTRON2000 TM is a registered Trademark of Casper Publications Pty Ltd and Suntec (NZ) Ltd.

The phospholipid Lechitin, a component of every living cell.

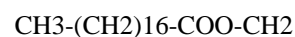

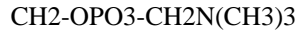

Phosphorus is involved in the bonding structure of nucleic acids DNA and RNA. Deficiency of phosphate appears as a dull green colouration of the older leaves followed by purple and brown colours as the foliage dies. Root development becomes restricted as phosphorous deficiency occurs, due to sugar production and translocation being impeded. The main source of phosphate in hydroponics is monopotassium phosphate, although limited amounts of ammonium phosphate can sometimes be added. Compounds such as calcium superphosphate should be avoided. Small amounts of phosphorous are also supplied by the use of phosphoric acid for pH control.

Magnesium

Magnesium is the central ion of the chlorophyll molecule, and therefore has a primary role in the light collecting mechanism of the plant and the production of plant sugars through photosynthesis. Magnesium is also a co-factor in the energy utilisation process of respiration in the plant.

Magnesium deficiency first appears as yellowing of the leaves between veins on the older parts of the plant, although under worse deficiency the symptoms can spread towards the newer growth. Magnesium deficiency can also occur during periods of low light intensity or heavy crop loading and when excessive levels of potassium are provided in the nutrient solution. The main, probably universal source of magnesium for hydroponics is magnesium sulphate (Epsom salts). Although limited use is sometimes made of magnesium nitrate it is rarely an economical option. Soil fertiliser salts magnesium phosphate or magnesium ammonium phosphate are not suitable.

Calcium

Calcium is deposited in plant cell walls during their formation. It is also required for the stability and functioning of cell membranes. Calcium deficiency is common in hydroponic crops, and is apparent as tipburn in lettuce, and blossom

end rot in tomatoes. Calcium is almost totally immobile in the plant, as once deposited in cell walls it can not be moved. Therefore the deficiency occurs in the newest growth. Calcium transport is dependent on active transpiration, and so calcium deficiency occurs most often under conditions where transpiration is restricted, ie warm overcast or humid conditions are often referred to as "calcium stress" periods. Increasing calcium content in solution is unlikely to improve uptake, and in fact, reducing CF is one way to improve calcium uptake in most species by enhancing the uptake of water. Calcium is supplied by default in most formulations through the use of Calcium nitrate. Extra calcium can be provided by calcium chloride.

Sulfur

Sulfur is used mainly in sulfur-containing proteins using the amino acids cysteine and methionine. The vitamins thiamine and biotin, as well as the cofactor Coenzyme A, all use sulfur, and so this element also plays a key role in plant metabolism. Sulfur deficiency in hydroponics is rare, usually because sulfur is present in adequate quantities through the use of sulfate salts of the other major elements particularly magnesium and potassium, and plant requirements for the element are reasonably flexible within quite a wide range. Where it occurs, sulfur deficiency shows up as a general yellowing of the entire foliage, especially on the new growth.

Iron

Iron is a component of proteins contained in plant chloroplasts, as well as electron transfer proteins in the photosynthetic and respiration chains. Deficiency occurs on the newest leaves, and appears first as a yellowing of the leaves between veins, and eventually the whole leaf becomes pale yellow, even white, ultimately with necrotic (dead) spots and distorted leaf margins. Iron must be supplied as chelated Iron EDTA, EDDHA or EPTA in hydroponics, rather than sulphate. Iron is the element most susceptible to precipitation at high (>7) pH, so pH control to below pH6.5 is necessary to maintain Iron in solution in hydroponics.

Manganese

Manganese catalyses the splitting of water molecules in photosynthesis, with the release of oxygen. It is a co-factor in the formation of chlorophyll and the respiration and photosynthetic systems. Manganese deficiency appears as a dull

grey appearance followed by yellowing of the newest leaves between the veins which usually remain green. Spots of dead tissue become apparent on affected leaves. Manganese is supplied by manganese sulfate, or manganese EDTA in hydroponics. The content of manganese in these fertilisers can vary widely between different sources, due to such factors as different 'water of crystallisation' ($MnSO_4 \cdot nH_2O$), and different chelating agents and raw ingredients as well as manufacturing processes. Manganese, like iron, is less available to plants at high pH.

Zinc

Zinc contributes to the formation of chlorophyll, and the production of the plant hormone auxin. It is an integral part of many plant enzymes. Zinc deficiency appears as distortion and interveinal chlorosis of older leaves of the crop, and retarded stem development. Zinc is provided by zinc sulfate, or zinc EDTA in hydroponics.

Boron

Boron is required mostly for cell division in plants, and deficiencies appear similar to calcium deficiencies, with stem cracking and death of the shoot apex being the most significant symptoms. Boron is supplied as either borax (sodium borate) or boric acid in hydroponic production.

Copper

Copper is required in small amounts as a component in several important enzymes. Toxicity is more common than deficiency of copper in hydroponics. Copper sulfate is most often used, although copper EDTA can also be used in nutrient solutions.

Silica

Recently silicates have been reported to improve the growth and development of some crops. When readily available, silica is incorporated into the root system, and appears to enhance nutrient uptake, improving the potential of crops to produce higher yields. Silicates have also been implicated in enhancing pollination, as well as providing increased structural strength of stems and some resistance to foliar diseases.

It should be noted, that among the 110 or so known elements, many more are likely to be implicated in plant growth.

Nickel, cobalt, chromium, titanium, iodine, selenium, lithium and numerous others have been reported to have some function in some species of plants.

Hydroponic Nutrient Basics

There are several important factors to decide when purchasing salts for hydroponic nutrient formulae:

1. The salt must be completely soluble in water, that is the salt must not contain additives or insoluble fillers, or components (such as insoluble sulphates and phosphates) which while useful for soil fertiliser are unacceptable in hydroponics.
2. Contents of sodium, chloride, ammonium and organic nitrogen, or elements not required for plant growth should be minimised under normal use. These elements if not used by plants tend to accumulate in recirculating hydroponic nutrients to the extent that the measured CF includes a high proportion of unusable salts.
3. The salt must not react with other components in the same mix to produce insoluble salts, and it should not radically alter the pH of the nutrient solution.
4. For commercial use, the fertiliser source must be economical. There is no point using expensive fertiliser salts when a cheaper source is perfectly adequate.

What Salts to Use

Macro Elements

Nitrogen

Recommended sources

Calcium Nitrate (15.5% N): Commercial calcium nitrate also forms 1% Ammonium-N in solution, and supplies 20%

Calcium

Potassium Nitrate (13% N): Also supplies 36.5% Potassium

Ammonium Nitrate (33% N): Nitrogen form is split between ammonium-N and Nitrate-N, the total ammonium-N % of a formula should be kept below 15% in most conditions.

Other sources:

Ammonium Phosphate (10%N): Supplies N and is soluble, but all N is in the ammonium form, which limits its application in hydroponics.

Ammonium Sulfate (21%N): As above, redundant if using conventional salts. Urea (46%N): Can cause problems with ammonia toxicity, and has no CF charge so difficult to measure.

Nitric Acid: Used often for pH control, but should not be considered a nitrogen source, especially not mixed with salts in stock solutions.

Phosphorus

Recommended Sources

MonoPotassium Phosphate (21% P): Also provides 25% Potassium.

Other sources:

Ammonium Phosphate (22% P): Not used as the main phosphate source as too much ammonium would be produced.

Phosphoric Acid: As for Nitric acid above. Older formulations used it as a P source in "Topping-up" mixtures but this approach is no longer valid.

Calcium Superphosphate (10% P): Phosphate is highly soluble (as phosphoric acid), but produces an insoluble calcium sulfate / calcium phosphate residue in hydroponics.

Potassium

Recommended Sources

Potassium Nitrate (37% K)

MonoPotassium Phosphate (25% K)

Potassium Sulfate (40% K): Also adds sulfur (17%). Useful as an additive to existing formulae to boost potassium levels.

Other sources:

Potassium Chloride (49% K): Can be added in small amounts, although preferably omitted due to its chloride content.

Magnesium

Recommended sources

Magnesium Sulfate (10% Mg): Also adds sulfur. Is highly soluble and universal Mg source

Other sources:

Magnesium Nitrate Expensive, and unnecessary

Dolomite (Magnesium carbonate) Insoluble residues

Fertiliser sources of magnesium used in agriculture (Dolomite, Causmag etc) are generally very insoluble, and can not be used for hydroponics.

Calcium

Recommended sources

Calcium Nitrate (20% Ca): Calcium is supplied almost entirely by this salt in most nutrient formulations

Calcium Chloride (36% Ca): Useful to add extra calcium without altering other elements. Limited use due to its chloride content, so only used as an 'additive'

Other sources:

Calcium chelates: Expensive and unnecessary

Calcium Ammonium Nitrate: Not recommended due to ammonia content

Calcium cyanamide: Release amine - N into solution which produces free ammonia.

Calcium carbonate: Insoluble, and inherent pH problems

Calcium Sulfate: Highly insoluble.

Sulfur

Recommended sources

Magnesium sulfate (13% S): Potassium sulfate (18% S)

Other sources:

Ammonium sulfate

Sulfuric acid

Trace Elements

Iron

Recommended sources

Iron EDTA (6 - 14% Fe): Readily soluble, and stable form of Iron for nutrient solutions. Ensure the element (Fe) content of the chelate is known before making formulations.

Iron EPTA: Using different chelating agents the iron can be protected in solution at higher pH levels.

Iron EDDHA " " "

Other sources:

Iron Sulfate (20% Fe): No longer widely used in hydroponics due to its instability in solution. In nutrient solutions iron sulfate tends to form iron hydroxides which are insoluble.

Iron Chloride: As above

Manganese

Recommended sources

Manganese Sulfate (24%): Different sources may vary in Mn% due to being hydrated or anhydrous. In solution with Iron EDTA, the manganese becomes partly chelated.

Manganese Chelate (*%): As for Fe EDTA * the content of Mn can vary between sources.

Boron

Recommended sources

Boric Acid (18% B), Sodium borate (Borax) 11 - 14% B

Zinc

Recommended sources

Zinc Sulfate (23% Zn), Zinc EDTA (*%)

Copper

Recommended sources

Copper Sulfate (25% Cu), Copper EDTA (*%)

Molybdenum

Recommended sources

Ammonium molybdate (48% Mo), Sodium Molybdate (39% Mo)

Ratios and Content of Elements in Nutrient Solutions

Once we have the source of elements (fertiliser salts) for a nutrient formula, the next stage is to combine these into ratios which give the acceptable element contents in solution. Plants will take up nutrient elements roughly according to their needs, this is especially true for the major elements, so adding elements to solution when they are not required results in the formula becoming unbalanced for plant growth. Adding excessive quantities of some of the trace elements can in fact lead to toxicities, while adding insufficient amounts of any element will eventually lead to deficiency and poor crop growth. As hydroponic growers it is essential to have an understanding of acceptable ratios for all the elements used in hydroponic formulations to ensure the nutrient solution is supplying the plant's needs and is neither toxic or deficient. Generally the range of acceptable element concentrations is wider for the major nutrients, than for the trace elements as can be seen from the table below.

Element Range in PPM for Nutrient Solution

N 100 - 450

P 10 - 100

K 100 - 650

Mg 10 - 95

Ca 70 - 300

S 20 - 250

Fe 0.5 - 6

Mn 0.3 - 4

B 0.1 - 0.8

Zn 0.1 - 0.5

Cu 0.05 - 0.1

Mo 0.02 - 0.07

Even within these ranges, nutrient elements can become very unbalanced if the ratios are incorrect. Leaf analysis of crops is a good indicator for acceptable ratios for a formulation within the above range. The ratios for a hydroponic nutrient for any new crop can be estimated from leaf analysis of a well grown plant, as if a plant appears to be thriving and producing well, then we can assume its nutrient mineral content is optimum, hence tissue analysis will give the nutrient ratios optimum for the root zone solution. This basic formula can then be fine tuned during different crop growth stages and seasons. Some indications for acceptable ratios of major nutrient elements are given below.

Element Ratio Ratio

N: P 3 - 8

N:K 0.25 - 1.5

Ca:N 0.8 - 1.2

Mg:N 0.1 - 0.4

P:S 0.6 - 1

CF and EC PPM.

'CF' or 'EC' is a commonly used measure to determine the strength of a hydroponic nutrient solution. As salts disassociate into ions in solution, they carry a positive or negative charge (eg $\text{KNO}_3 \rightarrow \text{K}^+ + \text{NO}_3^-$), which can transmit electricity. Pure water will not transmit electricity, but as soon as salts are added, the ability of the solution to conduct electricity increases. This conductance increases with increasing solution strength. CF (Conductivity Factor) and EC

(Electrical Conductivity) are a measure of this characteristic of nutrient salt solutions.

While CF seems to be a very convenient measure, there are problems associated with relying only on CF to control hydroponic nutrient formulae.

i) The CF will be roughly the same regardless of the element content of the solution. A nutrient solution with CF 20 can not be distinguished from a sodium chloride solution with CF 20.

ii) Different nutrient salts show different capacities to conduct electricity when in solution, so that depending on the nutrient ratios and the individual salts used, the CF may give a very different indication of the true ionic strength of the solution. A solution of potassium nitrate at CF20 will be approximately half the strength (in ppm) of a solution of magnesium sulfate at CF20. This is because potassium nitrate conducts nearly twice as much electricity at the same ionic strength.

iii) Even if the nutrient element content of the formula was known accurately at the start, once the solution has been recirculating through a growing crop for a few weeks, the element content changes - the CF may well stay the same.

Conductivity of Some Common Hydroponic Nutrients at 2000 PPM

SALT mg/l CF EC

Calcium Nitrate 2000 20 2

Potassium Nitrate 2000 25 2.5

Magnesium Sulfate 2000 12 1.2

The CF of a nutrient formulation is a combination of the CF contributed by all the dissociated nutrient salts from the A and B stock solutions as well as impurities from the water supply, and is not really any indication of the quality of the formula, just an estimate of its strength. In hydroponics the only way to determine the nutrient makeup of a formula is either to have a complete mineral analysis done, use a range of specific ion meters or to calculate the nutrients in advance and use these in drain to waste systems. Any solution in recirculating hydroponics will change over time.

Outside of hydroponics CF may not even be a measure of the strength of a formula, as a range of nutrients (eg Urea) and compounds (eg fungicides) are added to water in fertigation or spraying which do not conduct electricity.

PPM

The other common indicator for hydroponic nutrient strength is PPM, or parts per million. 1 part per million is equivalent to 1 mg per litre, or 1 g per m

3

. In theory, this is a measure of the actual strength of the nutrient elements in solution, and would seem to be an ideal measurement for hydroponics. However, measuring this in practice is very difficult for a grower in hydroponics.

Why Not TDS Meters?

An alternative to solve the problems with CF as a measurement may seem to be to use 'TDS' or total dissolved solids as a measure of nutrient solution strength, and if 'TDS Meters' in fact did this, it would solve the problems. However a 'TDS' meter is simply a 'CF' meter with different calibration and display - it still only measures electrical conductivity, and in fact is less accurate because of the assumptions made regarding the salt makeup of the solution - many assume sodium chloride and have a fixed conversion factor (eg 70ppm per CF unit) which can not be adjusted for different solution formulations. TDS meters which can be calibrated for different formulations are a better alternative, but still are only measuring CF in reality.

CF Effects on Plant Growth

If we assume that in hydroponics, the CF is a measure of the strength of a nutrient solution, this has a significant affect on the growth of plants, regardless of the mineral content of the solution.

Osmosis describes the behaviour of ions in solution when separated by a semi-permeable membrane, as for example at the interface of root cells and nutrient solution. The concentration of ions on either side of the membrane determines the net flow of ions through the membrane, as if ions are more concentrated in solution than in root cells and the membrane permits the transmission of ions, then ions will tend to flow into the roots. This process is known as 'passive' transport or diffusion, and is assisted by the flow of water in the transpiration stream of the plant. In fact, root

cells tend to maintain quite high 'osmotic potentials' but low concentrations of ions which attract water and ions into the

roots. Some ions, Ca

2+

and K+, NO

3-

, for example, are able to be transported into root cells, even against a concentration

gradient by the energy requiring process of active transport. Once water and ions are inside the roots they

diffuse through into the xylem vessels and flow with the transpiration stream up into the stem. A natural reaction of

some plants to increasing solution strength, is to accumulate assimilates in the leaves and fruit to equalise the osmotic

potential with the root zone.

This explanation may seem complicated, but it is the basis for the effects noticed by increasing or decreasing CF in

hydroponics. CF influences the 'osmotic potential' of the solution in the root zone, which influences the plant's rate of

water and nutrient uptake, and the adjustments made to osmotic potential inside the plant. Increasing CF will reduce

water uptake by the crop, and cause many crops to concentrate organic compounds in fruit and foliage. Increasing CF

tends to slow vegetative growth, and 'harden' plants. Conversely, lowering CF will increase water uptake, and produce

lush soft growth. Consequently, the CF of solutions is normally increased during winter and for fruiting crops, while

summer growing and leafy crops are normally run at a low CF to maintain optimum quality.

CF can be maintained at higher levels in solution culture than in media or drain to waste systems. In solution

culture there is a constant supply of water and the CF does not fluctuate in the root zone, whereas in media

systems evaporation from the surface of the media and plant water uptake can result in the CF becoming much

higher in the rootzone than in the 'feed' solution. The ratio of CF in the feed to rootzone and leachate solutions

needs to be well regulated in drain-to waste systems, and CF 'in' (feed) and CF 'out' (drainage) are standard

daily measurements.

pH

The pH of a nutrient formula is the measure of acidity below pH 7 or alkaline above pH 7. It is defined as the "inverse log of the hydrogen ion concentration". The practical implication of this definition is that each pH reduction of 1 unit actually means the formula becomes 10 X more acidic, a solution with a pH of 4 is 10 x more acidic than pH 5, and 100 x more acidic than pH 6.

pH and Formulations

The strength (CF) of the formula does not affect the pH, but it does affect the 'buffering capacity' at any pH. This is demonstrated by the amount of acid/alkali needed to change pH by 1 unit at different CF - as CF increases, more pH adjuster is needed to alter pH by the same amount.

Different formulations will have different starting pH values, because different salts become more or less acidic when dissolved into water. Salts such as monopotassium phosphate lower the pH more than salts such as calcium nitrate.

Most formulations will result in an initial pH of around 5.5 - 6.0, which is ideal for the growth of most crops. This pH results from only the commonly used salts being dissolved into stock solutions, and so addition of acid or alkali to stock solutions is usually unnecessary. However, these pH levels assume neutral water supplies, if the water supply has a high pH, along with high 'alkalinity' then the pH of the stock solutions when diluted into water will be quite different. 'Alkalinity' refers to the strength of the high pH, as a water supply with high alkalinity will require more, stronger acid, to reduce the pH by the same amount as a water supply with low alkalinity. This inherent buffering ability will carry on into the nutrient formulation. It is best to correct the pH of unsuitable water before making up the stock solutions

In hydroponics, some salts can be used to influence the pH control of the nutrient solution, reducing the requirement for acids during growth development phases of the crop. Ammonium nitrate is one salt used for this purpose, and the optimum amount seems to be that which provides 15% of the total nitrogen of the formula in the ammonium form.

Ammonium in nutrient solution tends to be acidifying, as firstly unlike nitrate it is a positive ion, and when taken up by plants is replaced by hydrogen ions reducing pH in the root zone, and secondly ammonium forms ammonium

hydroxide and hydrogen ions which produces a mild acidifying effect when in solution.

pH and Hydroponic Crop Growth

Consideration of pH is important for hydroponic growers, because the pH of the solution affects the solubility of elements, and their availability to plants. Most problems occur where pH becomes too high, above 7, resulting in firstly iron then manganese and calcium forming insoluble salts which precipitate out of solution. As the pH increases above 7, plant uptake of some ions becomes less efficient, so plants become deficient even if the ion is present in solution.

As plants remove some ions from solution, the solution pH drifts, upwards or downwards. If left uncontrolled, typically the pH will drift downwards (to approx 4.5) for several days after planting a new crop, after which the pH will steadily increase (to approx 7 or above). This feature is due to the differential uptake of ions from solution, with the release of hydrogen (H⁺) or hydroxyl (OH⁻) ions from the root system. As positive ions, cations (Ca

2 +

, K⁺,

Mg

2 +

etc) are removed from solution, hydrogen ions are released from the plant root system to equalise the ratio

of anions to cations in the root zone. This lowers the pH of the solution. As the crop commences active growth

anions (NO₃ etc) are taken up which increases pH through the release of hydroxyl ions into solution.

Hydroponic Nutrient Formulation Basics

The range of hydroponic nutrient formulations available seems very diverse, and yet if we look closely at their content there are several underlying principles involved in formulating hydroponic nutrient solutions. The following are some standard features of hydroponic formulations:

Reason for '2-Part' 'A' and 'B' mix.

In order to combine all the elements commonly needed for plant growth into a concentrated form, the salts need to be mixed into 2 separate solutions. The reason for this is that, while in dilute solution all ions become soluble, in concentrated solution certain ions react together to form insoluble salts. If an ion is in an insoluble salt, it is no longer available for plant growth. Once 'precipitated' it can only very slowly dissolve back into solution when diluted again. Precipitation is simply the result of two ions combining in solution to form a salt which is insoluble, eg when calcium nitrate and magnesium sulfate are added to water in strong solutions the salts dissociate producing magnesium nitrate along with calcium and sulfate ions which then combine to form calcium sulfate or gypsum which 'precipitates'. This occurs because compounds such as calcium sulfate have very low 'saturation' values (see later) and can not exist as concentrated solutions. Generally it is necessary to keep the calcium separate from the sulfate and phosphate salts. Therefore the calcium nitrate and calcium chloride is kept separate from the magnesium sulfate, potassium sulfate, sulfates of trace elements, and monopotassium phosphate, all other salts can be mixed in either A or B. There are certain brands of nutrient which seem to combine all elements into a single mix, but the manufacture of these products is beyond the reach of most growers.

Grow vs Bloom, Summer vs Winter, Drain-to-Waste vs NFT

Plants in nutrient solution culture will remove different ions faster from solution at different stages of growth or development, as well as during different light and temperature conditions, and if left unchecked this quickly results in formulations being unbalanced. Note that unbalanced does not necessarily mean 'precipitated', or 'toxic'.

While there are for example, 'Grow' and 'Bloom' formulae available, it is important to note that using eg a "Bloom" formula will not suddenly force vegetative plants to commence flowering and fruiting, any more than using a "Summer" formula produces fine weather. The differences between the formulae is simply to allow the nutrient solution to remain balanced for longer periods, while estimating the likely rate of removal of certain ions from solution under different conditions.

In general, as plants grow from being vegetative to flowering and fruiting, the uptake of potassium and phosphorus increases in proportion to nitrogen. Therefore a 'Bloom' formula will typically have more potassium or a higher K:N ratio than the equivalent 'Grow' formula. Other changes can result from the increased K:N ratio, the pH of the formulation can become slightly lower, the working CF may become higher, and the amount of magnesium supplied can also increase to avoid potassium induced magnesium deficiency, common for example on tomatoes with heavy fruit loads. Conversely a 'Grow' formula will provide a higher N:K ratio, slightly lower CF at the same dilution, and less extreme variation between the ratios.

Plants growing under low light conditions and cold temperatures usually take up extra potassium, and tolerate a higher CF. Therefore a 'Winter' formula may be similar to a 'Bloom' and summer formula can be similar to 'grow'. The CF for warm, high light conditions is usually lower to allow for increased transpiration and water uptake.

The differences between the two sets of formulae becomes more extreme the further the grower is from the equator, and obviously depends on the crop being grown. For example a Norwegian tomato grower is likely to make bigger changes to their nutrient solution during the year, than a lettuce grower in Singapore.

The difference between growing in media and drain to waste, compared to recirculating solution as in NFT, is mainly due to the CF and the fact that nutrients do not become unbalanced in media systems to the extent that they can in NFT. Generally solutions used for media and drain to waste are run at lower CF than if the same solution was running in a recirculating solution culture system. For example a capsicum grower using rockwool may apply nutrient solution at a CF 16, whereas in NFT the same solution would be used at CF 25. This difference is due to the solution applied being at a different CF to the 'root zone', and the drainage solution in media systems. Some media are reported to influence the retention or chemical nature of the applied nutrient solution especially the pH, but this is often only a minor problem when using new material, and in the case of pH alteration is easily managed. In reality, there should be no difference between nutrient solutions used for different growing systems other than the working CF, and the frequency of replacement.

Strength and Dilution

There is a physical and chemical limit to the amount of salts which can be dissolved into nutrient stock solution. This limit, the saturation value, is different for each salt, and restricts most formulations to a maximum dilution rate of 500 -1000 times. This value varies depending on how the formula is split between A and B, and the predominant salts used, for example, much more calcium nitrate can be dissolved into 1 litre of water than potassium nitrate. Above the saturation value for a particular salt, the salt remains in crystal form and does not dissociate in solution. A useful practice to overcome this limitation is to split the potassium nitrate requirement of the formula equally between the A and B solutions - as potassium nitrate has the lowest saturation value of the major salts, this increases the potential concentration of the formula above what could be achieved if all the potassium nitrate was in part A or B.

Solution 'Balancing'

Under certain conditions, for example if alternating between 'A' and 'B' stock solutions in drain to waste, it is useful if both stock solutions each have the same CF when diluted for use. In this situation the ratio of potassium nitrate in A to B is adjusted until the CF are the same. Normally, this is not important, and the CF of 'B' is usually about 1.5 or 2 times the CF of 'A' if potassium nitrate is not divided between A and B. When both are diluted equally the correct CF will result.

Buying Pre-Made or Make Your Own

It was commonly suggested by nutrient manufacturers that it was false economy if not disastrous for mere growers to attempt to make their own nutrient formulations. Often these suggestions were prompted by commercial interests, and the few failures that occurred in growers making their own nutrients were capitalised on and used as examples of why growers should only trust 'reputable' nutrient manufacturers.

However, there are significant cost benefits to making your own nutrient formulations, there is great flexibility, and if done correctly growers are likely to end up with a better formula.

There are of course advantages and disadvantages to both situations.

Buy Pre-Made If . . .

You can not obtain all the correct nutrient salts at an economical price or acceptable quality.

You do not have weighing equipment capable of weighing down to about 5g (small amounts for trace elements are weighed out in large amounts and the stock solutions diluted into A or B)

You do not have the time to weigh out salts and dissolve them.

Good brands are available which you have used successfully, and the price difference to change isn't warranted.

You do not see the need to change your formula during growth.

You don't have the information or understand the calculations involved in making your own nutrient formula.

You don't trust your own ability to make a correct decision.

You like to have someone else to blame if things go wrong.

Make Your Own If . . .

You can spare the time.

You want to save money, where salts are available and cheap with good quality.

You want to optimise your nutrient solution so you are not dumping so frequently - save money again.

You have the equipment to weigh and measure salts.

You would like to customise your solution to crop growth and environment to get better results.

You can handle the calculations and you have the correct information.

You want to maintain flexibility.

You get nutrient analysis done every so often and you are confident you know what to do.

Lighting & Accessories

HP Sodium / Metal Halide / Replacement Bulbs / Light Movers / Germination

Something about indoor lighting.... Giving your plants the right amount of light is one of the most important things to a plant's happiness. Having used HID lights for over 15 years now, we are convinced more than ever, that they rival the sun for horticultural applications, and in some respects, are even better. After all, there are no cloudy days in the grow room and with indoor grow lights, you get to choose the seasons.

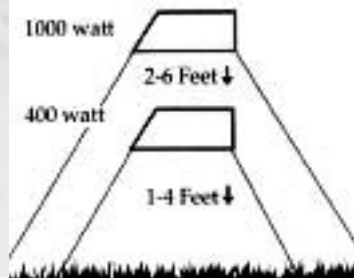
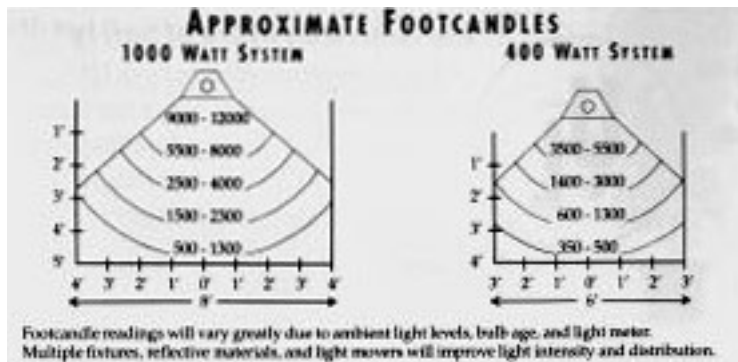

VARIOUS LIGHTING PRODUCTS

Super Spectrum Combi-Systems	Stealth Lighting Series	Sun System - enclosed
Switchable Ballast System	Reflective Wall Coverage	Super Grow Wing
Full Spectrum Fluorescent Lighting	Light Movers	Sunburst
Conversion Bulbs	Budget Growlights	The Germinator
Vertizontal System	Sun Gro System	Replacement Bulbs & Upgrades
SuperSun Reflector Systems	P.L. Light Systems	FAQ's (and answers)

[Stealth Lighting Series](#)



Black Anodized Aluminium Ballast

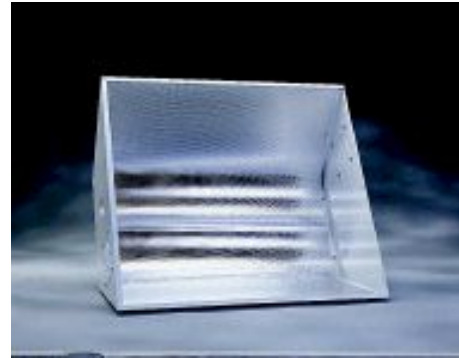

Standard Horizontal Reflector

Running quiet and cool, the Stealth Lighting Series brings you state-of-the-art technology and materials in an affordable, no-frills package. Available in Metal Halide and High Pressure Sodium models ranging from 400W - 1000W, they deliver reliable HID light for all of your growing needs. They are backed by a 5 year warranty.

All systems include:

- **Remote Black Anodized Ballast (can be wall mounted or remain on floor with 4 rubber feet)**
- **15' Detachable Lamp Cord w/Sealed Socket Assembly**
- **8' Power Cord**
- **Standard Reflector**
- **Standard (Universal) Bulb**

P.L. Lighting Systems

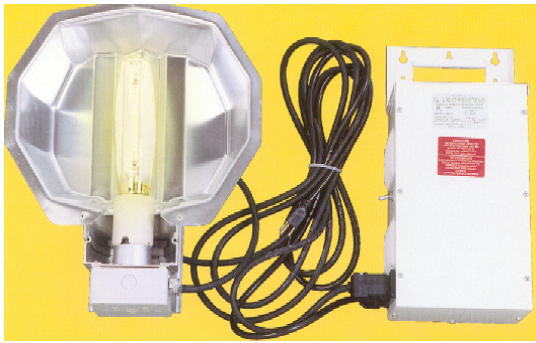

On/Off switch for power supply
Combination wall mount and carrying handle
6 styles of reflectors available for maximum intensity and uniformity
U.L. listed

*** The Grow Room endorses the PL 600W and 1000W HPS Deep Reflector...the BEST reflector hood available for uniformity and intensity**

Sunlight Supply, Inc.

- Sealed, extruded aluminium ballast protects internal components from dust and moisture
 - Wide range of reflectors for any budget or application
- Unique features such as on/off switch and built in timer make systems user friendly
 - Five year warranty on ballast, one year on bulbs

Super Spectrum Combi Systems (Includes: Super Spectrum Reflector (24 1/2" X 25"), Dual output remote ballast, 1 Metal Halide and 1 High Pressure Sodium lamp)



To truly get full-spectrum HID light, the blue spectrum (metal halide) must be blended with the red spectrum (high pressure sodium). When this is done, the spectrum of the fixture is unparalleled by any single light source.

Available In:

500W	(1) 250W Halide + (1) 250W HPSodium = 51,500 lumens
800W	(1) 400W Halide + (1) 400W HPSodium = 87,500 lumens
1000W	(1) 400W Halide + (1) 600W HPSodium = 130,000 lumens

Super Sun Reflector Systems

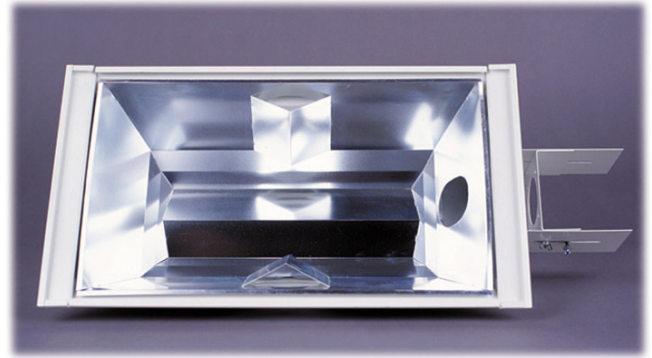

Sunlight Supply's top of the line reflector, "**The SuperSun**", offers superior reflectivity and diffusion in a compact design suitable for large or small growrooms. Measuring only 10" wide by 17 1/2" long it fits anywhere and delivers uniform coverage from either low or high ceiling heights. System includes:

- Sun System 1 sealed, extruded aluminium remote ballast.
- 15 foot detachable lamp cord
- Lamp cord/socket assembly
- Standard (Universal) Bulb
- SuperSun Reflector
- 5 year Warranty

SunGro System (Complete unit: Bulb, sealed, extruded aluminium Remote Ballast, Detachable Lamp Cord, SunGro Reflector)

This four sided parabolic reflector (20 1/2" x 20 1/2") allows you to give your garden uniform light even behind the socket, and lets you go from wide angle to narrow beam depending on your garden size. Full specular aluminum insert eliminates hot spots. Can be air cooled with optional hose adapter and glass lens.

Available with Built-in Timer



Vertizontal System (Complete unit: bulb, remote ballast, detachable lamp cord, reflector)

Designed specifically to provide evenly distributed light over large garden areas with low ceilings. An excellent choice for 1000W systems, MH or HPS.

48" eight sided parabolic reflector, Faceted Spectral aluminum insert and adjustable socket assembly bracket is standard.



Sun System (Enclosed Ballast)



The System to choose if space is at a premium. Excellent for any space not big enough for a remote ballast. Increases hanging weight of fixture.



Light Movers

For maximum coverage and even growth rate, **MOVE YOUR LIGHTS!**

Light Rail III uses external motor w/time delay at each end, can be set to any length. Sun Circle unit requires a minimum 8 foot diameter to operate.

Replacement Bulbs & Upgrades

When choosing a replacement bulb please consider one of the horticultural bulbs offered below. The AgroSun will operate in a metal halide system and offers an enhanced spectrum in a high output bulb. The classic AgroSun offers a 30% increase in the red spectrum while the AgroSun Gold offers 50% more red. For High Pressure Sodium Systems the Hortilux bulbs give you 15% more blue in the spectrum while boosting lumen output by nearly 10%, giving you more bang for your energy buck and enhancing overall growth and yields. These bulbs fit standard horizontal HID units. All bulbs manufactured by Phillips, Osram/Sylvania, Eye Lighting, Venture or Sunmaster, and guaranteed for 1 year.

Frequently Asked Questions (and answers).

Q. What is the difference between Metal Halide and High Pressure Sodium?

A. **The spectrum and comparative lumen output (brightness) per watt.** If you had to choose just one or the other, the Metal Halide provides the better all-purpose spectrum for plant growth. It is strong in blue and indigo which promotes compact stem and leaf production. It is a better light for the early

stages of growth, when leaf and stem production are most important. In the flowering stage, there is just enough red and yellow to produce average flowering.

The High Pressure Sodium comes into its own as a flowering light. It is strong in the red/yellow part of the spectrum which promotes larger and more abundant blooms with longer stems. It is more efficient and brighter (lumens per watt), than the Metal Halide which increases yield.

Q. Would a warm Metal Halide be as good for flowering as a HPS?

A. In our opinion, **no**. Which is why the combi lights and switchable ballasts are such a good idea.

Q. What size light should I purchase?

A. The wattage you choose is determined by the size of your garden.

250W - 2' x 3'

400W - 3' x 4'

600W - 4' x 4'

750W - 4' x 5'

1000W - 4' x 6'

Reflector styles may vary these dimensions somewhat but your most intense light will always be under the lamp. Spreading the light uniformly is the challenge faced by most reflector designers.

Q. Which is the best type of lighting to use for supplemental greenhouse lighting?

A. If your crops stay green, (lettuce, basil, parsley), metal halide is what you want. If your crops are tomatoes, peppers or flowers, HPS would be your best choice

Rockwool is probably the most popular growing medium on earth. Rockwool was originally used as insulation and was called "Mineral Insulation". It was developed for gardening in Denmark and is used extensively around the world for "Drip-Style" hydroponic systems.



[What is Rockwool?](#)

Rockwool is made by melting a combination of rock and sand and then spinning the mixture to make fibers which are formed into different shapes and sizes. The process is very similar to making cotton candy. The shapes vary from 1"x1"x1" starter cubes up to 3"x12"x36" slabs, with many sizes in between, which makes rockwool one of the most versatile growing mediums.

The advantages to rockwool are many, however there are several disadvantages to this type of growing medium as well. The pros and cons are listed below.

Advantages of Rockwool



RETAINS WATER - Rockwool holds an incredible amount of water which gives you a "buffer" against power outages and pump (or timer) failure.



HOLDS AIR - Rockwool holds at least 18 % air at all times (unless it is sitting directly in water), which supplies the root zone with plenty of oxygen. This means that it is practically impossible to over-water rockwool.



COMES IN A VARIETY OF SIZES AND SHAPES - From 1" cubes designed for use in propagation, to 3"x12"x36" slabs capable of holding the root systems of huge plants, rockwool comes in dozens of shapes and sizes making it a versatile growing medium. Rockwool also comes "Loose" so you can fill pots or containers of any size.



CLEAN AND CONVENIENT - Rockwool holds together very well so it can't spill. Rockwool also comes wrapped in plastic, which makes it easy to handle and keeps evaporation to a minimum.

Disadvantages to Rockwool



NOT ENVIRONMENTALLY FRIENDLY - Rockwool is hard to dispose of, if buried it will last indefinitely.



DUST AND FIBERS ARE A HEALTH RISK - The fibers and dust from the rockwool are bad for your lungs. Wear a dust mask when handling to prevent problems.



pH PROBLEMS - Rockwool has a high pH which means you have to adjust your nutrient solution low so that the root zone is neutral. Rockwool is also susceptible to pH shifts meaning a bit more routine maintenance to keep the pH levels correct.



LONG PRE-SOAK PERIOD - Rockwool must be pre-soaked for 24 hours before use. Most other growing medium only needs to be well watered.

Getting Started with Rockwool

Before you use rockwool you must first soak it in water adjusted to a pH of 4.5 to 5.0. You should soak the rockwool for about 24 hours. To soak rockwool cubes use a bucket or other water tight container, just put the cubes in the water and let them float around. To soak the rockwool slabs cut a hole in the bag around the slab and pour in pH adjusted water until the slab is totally saturated, let soak for 24 hours Then cut drainage slits in the bottom.

Using Cubes

Rockwool cubes come in many different sizes. There are two sizes of "starter cubes" that are designed for propagation. The 1" cubes are not wrapped in plastic and are normally used for starting seeds. The 2" cubes are wrapped on four sides with plastic to slow evaporation and are used primarily for taking cuttings.

The 3" and 4" cubes can be used as the primary growing medium or in conjunction with other growing mediums. For small plants a large cube may be all the growing medium that you need. For larger plants these cubes are used as an intermediate medium that gets transplanted into a different type of growing medium as the plants grow.

The larger cubes come with or without a hole that is designed to fit the 1" cube. With the hole you can easily transplant the 1" starter cube into the larger cube simply by inserting it into the hole.

Using Slabs

Slabs come in 6, 8, 10 and 12 inch widths, all are 3 inches deep and 36 inches long. The 6" and the 8" are by far the most popular sizes and are large enough to grow just about anything.

The slabs are wrapped and sealed in plastic. Most people will start their plants in rockwool cubes (see above) and then transplant them to the slab. To transplant a rockwool cube to the slab you simply cut an "X", that is the same size as the cube, in the plastic on top of the slab. You then lift the plastic tabs and set the cube on top of the slab. You may want to "pin" the cube temporarily with a plastic spike until the roots grow down into the slab. (see drawing below)

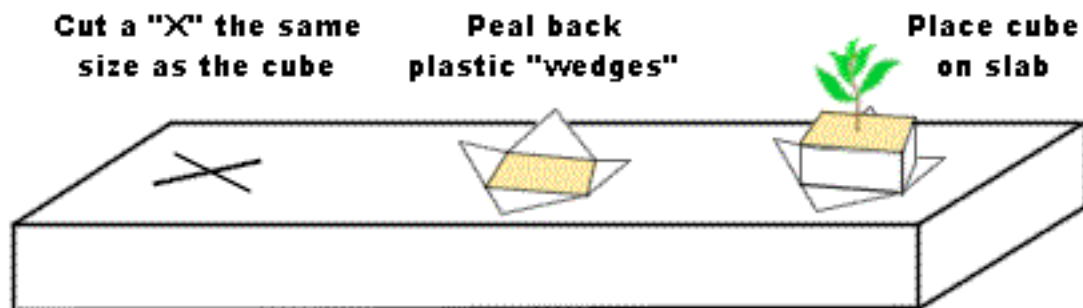

Using "loose" Rockwool

There are basically three kinds of loose rockwool, absorbent, repellent and Hortiwool. Using loose (or granular) rockwool enables you to fill pots or other containers with the growing medium so that you aren't locked into the preset sizes of the cubes and slabs mentioned above.

Another benefit of using the "loose" rockwool is that you can custom tune your medium to retain just the right amount of water for your particular plant.

Care must be taken when handling rockwool, especially the "loose" varieties. You should wear a particle mask because the fibers of the rockwool are bad for your lungs.

What is rockwool?

- a mixture of “rocks” that is melted at high temperature to form a molten matrix, and then is passed across an air stream that cools the material and forms long fibrous strands that are bonded together to form slabs, blocks, plugs, etc., and granulates (non-bonded)
- General Hydroponics rockwool is mainly a mixture of basalt and dolomite (same constituents as Grodan made in Denmark)
- the material is chemically and biologically inert
- the rockwool is “clean” of any plant pathogens
- GH brand rockwool is produced using an electric melter which virtually eliminates pollution, versus the use of a coke-fired oven and is VERY BAD for the environment; also, the resin used to bond the fibers is a new technology from Canada which eliminates release of formaldehyde during the curing process making it a safer manufacturing process.

Rockwool is 97% (by volume) air (which means):

- you can control the air / water ratio in the substrate
- the greater volume of air will enhance root growth
- there will be less fluctuation in pH and EC compared with other growing mediums
- as water and nutrients drain from the rockwool or are taken up by plants, the “pores” of the material again are filled with air

Why use rockwool?

- >95% of the world’s greenhouse vegetable production is on rockwool!
- rapid rooting of cuttings and seeds and maximum yields
- allows optimum control of air / water ratio, pH and EC
- rockwool products come in a variety of shapes and sizes that allow the grower to utilize it in many different types of hydroponic systems
- the most consistent production and highest yields in commercial production of vegetables occur on rockwool
- rockwool is a manufactured product so the material will be consistent; organic products, “natural” products and substrates that are simply dug from the ground will be much more variable

Advantages of using General Hydroponics (versus other brands):

- broader product line (BAB-12s, Chubby slabs, RP plugs, 50/50 granulate) than the competition
- new products always under development that can make your business more successful
- better prices and better quality make more money for you
- the only rockwool recommended for use with GH nutrients and the only rockwool with the GH name!
- made in North America using environmentally friendly technology
- Vibeke won’t show up at your store anymore!

Why?

- why is GH rockwool brown? Actually the rockwool is a yellow- green color but the new resin used to bond the fibers gives it the brown color. We here it’s made the Grodan people “brown with envy.”
- why are GH slabs heavier than Grodan? To keep costs low Grodan sells their “one year” Talent slab in the hobbyist market which is not their top-of-the-line product. The one year slabs tend to compress over time which reduces the amount of air and can lead to lower yields and sometimes even disease problems. GH sells only one kind of slab, which the commercial vegetable growers call a “multi- year” product. Even though it rarely is used for more than one crop the “multi-year” slab is denser and more durable and does not compress and lose it’s air structure.
- why does Grodan push the vertical fiber slab? Originally the vertical fiber slab was developed as a

gimmick to thwart another rockwool manufacturer that had a slab that drained faster than that of Grodan. The problem with this is that the water tends to run out of the slab too fast, which forces the grower to irrigate more often than he would like and the roots just go straight to the bottom of the bag instead of spreading out. In Europe, where there are over 30,000 acres of hydroponic vegetables produced, growers prefer horizontal fiber slabs because it helps to develop a better root system.

- why does GH make both vertical and horizontal fiber slabs? We recognize the fact that many people growing in rockwool have never even seen a horizontal slab (thanks to Grodan!) so we will continue to produce vertical slabs for people who are comfortable with this. We will let our customers know as much information as possible about rockwool and then let them decide the product(s) they prefer.
- why does GH have products like the BAB and Chubby and the other rockwool manufacturers do not? General Hydroponics' business is to provide superior technology to their customers. Grodan, as an example, only cares about their big commercial grower accounts and so they manufacture products for them, and if some of these products work for small growers and hobbyists, then fine, but they won't go out of their way to develop new products for our market. Conversely GH continually works on new products and innovations that benefit our industry.
- why do the Grodan people say that all of the world's best growers use their product? Because they are not telling the truth! For many years they had the entire market alone but in recent years their competitors have taken away a significant portion of that. Examples: Leamington, Ontario: 600 acres: 25% on Grodan; BC Hothouse Growers: 250 acres: 10% on Grodan; Houweling USA: 60 acres: NO Grodan; Bonita Nurseries (AZ): 120 acres; NO Grodan. By the fall of 2000, their market share in North America is expected to decline by an additional 10%. If you want to buy based on reputation, why look anywhere other than GH?
- why do you make the Chubby slab? The Chubby was developed for two reasons: 1) to provide small growers a greater degree of flexibility when growing on slabs; and 2) the Chubby is one inch taller than a "regular" slab so it makes it even easier to maintain the "optimum" 60 / 40 water / air ratio in the slab.
- why do you make the BAB blocks? Ever heard of "bigger is better?" Just like the Chubby the BAB provides growers with more flexibility. It's very tall, so it helps optimize the air / water ratio and also provides lots of rooting area. It can be used like a "mini-slab" by placing a plant (s) in a small block on top or directly transplant into it. It's also adaptable to both ebb & flood and drip irrigation. And, it makes a joke of the Grodan DM10!
- why is GH rockwool an environmentally-friendly product? GH rockwool is made from basalt and dolomite, two natural constituents. Since the production process "spins" them into fibers composed mainly of air, our rockwool is an excellent amendment for garden soil. There actually are land-fills that allow deposit of used horticultural rockwool for free because mixing it with the other land-fill constituents helps to enhance activity of aerobic bacteria. Of course that's only part of the story. Our manufacturing process utilizes two key methodologies that impart the environmentally-friendly "label": 1) our electric melter uses hydro-electric power (no coal generation) and by melting the rock in this way (versus the traditional coke-fired oven) there is no sulfur given off in the production process; and 2) we use a resin to bond the fibers that does not give off free formaldehyde, which can be very dangerous to workers involved in production of bonded rockwool.

What?

- what will the Grodan people say or do? If they're smart they won't say anything negative about GH but they definitely will do and say a number of things that they have done in the past that include:

-Vibeke will refer to it as the "brown wool" (which is kind of neat since GH rockwool really is brown!) to suggest to the customer that it's just off-spec stuff compared to Grodan. ANSWER: Take a look at the product. Quality is as good or better than anything else on the market and the starting materials (basalt and dolomite) are the same as Grodan's. And yeah, it's brown because we use an environmentally friendly resin and they don't!

-They will say that GH rockwool can't possibly be as good as Grodan because the price is so much

lower; they also will say that there is no way our prices will remain this low ANSWER: Unlike Grodan we don't keep adding dozens of new people all over the world and using profits from one market to develop another. Our prices are lower than those of Grodan because our costs are lower (and always will be!).

-Vibeke will claim that a particular GH product "won't work because of . . ." which she actually tried with the BAB blocks the first time she saw them (Grodan now says they will be coming out with their own BAB block!). ANSWER: Point out to the customer that people already are using the product successfully in the manner for which it is intended and in many cases the same or similar products are being used (under the Hydrogro® brand) by large commercial growers like Houweling in Camarillo, who grow on a form of the Chubby slab on 40 acres!

-They will tell the retailer that he can't drop Grodan because they will lose the enormous strength of that brand. ANSWER: The GH brand is stronger in the hobbyist market than Grodan and in fact there is a distinct possibility that the GH name will help to expand the total market for rockwool!

-They will claim that Grodan is THE rockwool in the commercial market and that proves they are the best. ANSWER: Wrong! Take away Village Farms, which is owned by the same company that has a joint venture with Grodan in North America and they MIGHT be third! I really don't think many people are too impressed when most of your commercial sales are to yourself! As noted in another part of this outline, Grodan people still live in the BC (Before Competition) time period.

-They will claim that their vast resources give them the ability to supply their customers with information that is not available from other manufacturers and that they have the "best" tech reps in the business. ANSWER: Wrong again! Yes, they have tech reps, but all they know is what the Grodan people in Denmark and Holland tell them. And in turn, where do those guys get their information? That's right, the same place we do. From growers, university trials and other information in the public domain (isn't the Web a wonderful thing?). We are in constant contact with growers, researchers and industry organizations around the world. We know more about rockwool than the Grodan guys because they just sell the stuff while we actually make our own products. As a little post-script, they do have the best paid tech reps in the business.

Handling rockwool:

-for a more complete description refer to Prof van Hydro's 1-2-3 instructions

- before using any rockwool it must be "charged" with water or nutrient solution; the initial soaking of the product ensures that it will readily wick moisture on subsequent irrigations
- soak propagation plugs in plain water and rooting blocks in nutrient solution; there are people that claim rockwool has a high pH and must be pre-treated to make it lower, but that's an old "wives' tail" or perhaps the work of some marketing genius; if you are transplanting plugs into rooting blocks, it's OK to soak the rooting block (prior to use) in nutrient solution; slabs always are charged with the same nutrient solution that will be used in ebb & flood or drip.
- rockwool is inert and as such you must be careful not to over-fertilize or over-dose with a pesticide because there is nothing to absorb and buffer the excess material; basically whatever you add to the rockwool is available to the plant; that of course can be both good and bad
- once a seedling is exhibiting a fair number of healthy roots it's OK to start using a dilute nutrient solution with the rockwool
- prior to placing plants in an automated environment (ie., ebb & flood or drip system on a timer) irrigation and fertigation is a "touchy-feely" kind of thing; the tendency is to over-water but 36x40 mm propagation plugs in a room temperature environment under lights only need to be moistened every 2- 3 days until they are transplanted into rooting blocks
- just like GH nutrients, GH rockwool is a 1-2-3 system; start seed in 36x40 mm tapered plugs

(TP3640) and cuttings in 36x40 mm round plugs (RPT3640 or RP3640); when lots of roots are evident transfer the plug into a rooting block (RB 4, 5, 6, 8 or 10); plants can be grown on the rooting blocks or, when they too have developed good roots transfer the rooting blocks onto a slab or a BAB.

The Product Line:

- **PLUGS-** anything used primarily to establish a seedling via seed or vegetative propagation is called a propagation plug. GH plugs may be tapered or round; singulated or in mats; and may be loose or in trays. The most common products people will be using are: TP3640 (tapered plugs in mats) and the RP3640 and RPT 3640 (round plugs loose and in trays, respectively). The TP3640 product is used primarily for germination of seed while the RP plugs are used for vegetative propagation.
- **ROOTING BLOCKS-** this is the largest category mainly because there are so many different types and sizes of systems in the hobbyist market that it requires many different blocks. The main products that customers will use will be: RB 4 (3" block); RB 6 (4" block); and the BAB-12 (the really BIG block). BABs don't come with holes but the RB 4 and RB6 products come with- or without a 4240 hole that accommodates 3640 tapered and round plugs as well as RB4040 (miniblock) blocks. Refer to the product code sheet for all of the sizes and dimensions, as well as the other block products not mentioned here. Our competitors don't have a BAB block!
- **GROWING SLABS-** slabs are used commercially with drip irrigation systems but many hobbyists also used them in ebb & flood (refer to primer on potential plant problems growing on rockwool). Plants are rooted in plugs after which plugs are transplanted into blocks where they grow for 7-10 days and when roots begin to penetrate the grooves in the bottom of the blocks they are transplanted onto slabs (see 1-2-3 instructions for details of the process). GH currently has two basic types of slabs: the "standard" slabs are either 15 or 20 cm wide, 7.5 cm tall and either 90 or 100 cm long and wrapped in a poly bag (black inside / white outside). The other type is the Chubby, whose dimensions are 25 cm wide, 10 cm tall and 45 cm long (also wrapped). All slabs carry the code "GS" for "growing slab." The first type of slab also can come in either a "vertical" or "horizontal" fiber orientation. Please see the "Why?" section of this guide for a bit of background on this concept. At this time, GH is the only brand with a Chubby slab, which because of its dimensions, is perfect for hobbyists who need flexibility in spacing and desire the positive benefits of a "taller" slab. We hope to introduce 10 cm tall 90 and 100 cm-long slabs by the end of the year.
- **GRANULATED ROCKWOOL-** granulated rockwool does not have the resin used to "bond" the plugs, blocks and slabs. This so-called "loose wool" can be used alone or combined with other growing mediums to modify air- and water-holding characteristics. GH offers three types: absorbent; repellent; and a 50/50 mixture of each. The product comes in a 20 kg bale, compressed that provides approx. 14 cubic feet of material. GH is the only brand that provides the compressed 50/50 combination, which is a sought-after product by hobbyists. When things go wrong- a primer for problems with plants grown on rockwool
- During the production process a wetting agent is added to the fiber that helps make it "wet up" more rapidly. If someone calls and says they have blocks that float for hours without submerging in a bucket of water, it means they don't have enough wetting agent in them. Solution: add about 50 ppm of an agriculturally approved wetting agent to the water and the blocks will soak it up. This is a rare occurrence but if a customer gets "floaters," this is the cause.
- Someone's EC was running high and they leached the system with clean water and the plants started looking REALLY bad. They should have immediately changed the solution in their nutrient tank and used that solution to leach the slabs or blocks rather than the "clean" water. Unlike substrates where the nutrient solution quickly flows out and is added on a more frequent basis, nutrient solution slowly drains from the rock- wool matrix, so adding "clean" water temporarily throws off the pH and EC even more. By adding the correct concentration of nutrient solution it will help "equilibrate" the system.
- Seedlings in propagation plugs "damped off" and the customer thinks the rockwool killed them. No, possibly the seedlings were over-watered, but since rockwool is inert and pathogen-free, they either had a "dirty" growing area or they watered so much that the roots "suffocated" from lack of oxygen.
- The so-called "slab and block" rockwool system was developed for use with drip irrigation. Unfortunately slabs are used quite often by hobbyists with ebb & flood, and so many of them tend to keep the rockwool too wet. This is where the Chubby slab can be very helpful because the extra height

helps keep it “drier” even in ebb & flood. Basically, if someone is using ebb & flood with slabs, they should change their irrigation scheduling so that they irrigate more frequently but cut back on the flooding period by about 20% (eg., instead of flooding 3 times per day for 15 minutes at a time, flood 5 times per day for 10-12 minutes).

- Rockwool is such a good growing medium that there aren't that many problems associated with it.

Mineral Elements / Nutrient Mixing Directions.

There are 20 Mineral Elements

Macronutrients are required in large amounts		
Carbon	C	Component of all organic compounds
Oxygen	O	supplied by air & water
Hydrogen	H	
Nitrogen	N	Part of chlorophyll, amino acids, proteins
Phosphorus	P	Used in photosynthesis and almost all aspects of growth
Potassium	K	Activates enzymes, used in formation of sugar and starch
Calcium	Ca	Used in cell growth and division, part of cell wall
Magnesium	Mg	Part of chlorophyll, activates enzymes
Sulfur	S	Part of amino acids and proteins

Micronutrients are required in trace amounts		
Boron	B	Affects reproduction
Chlorine	Cl	Aids in root growth
Copper	Cu	Used in chlorophyll, activates enzymes
Iron	Fe	Used in Photosynthesis
Manganese	Mn	Part of chlorophyll, activates enzymes
Sodium	Na	Used for water movement
Zinc	Zn	Part of enzymes, used in auxins
Molybdenum	Mo	Used in nitrogen fixation
Nickel	Ni	Liberates Nitrogen
Cobalt		Fixates Nitrogen
Silicon		Makes tougher cell walls: enhances heat and drought tolerance

6 Pack Nutrient Mixing Directions

Mix each nutrient separately following the order of appearance on the list until all are added. Test pH after nutrients are added. (pH will drop about a point.) Ideal pH reading is 6.5. Once every week to two weeks pump out your reservoir and re-mix the nutrient solution. This is a good time to leach your system by running on straight water for six to eight hours or until the EC rises to approximately 1000 mmho/cm. A manual leach may be done by flushing with straight water during the pumping out cycle. Plants use more water than nutrient. In between nutrient changes top up the reservoir with pH balanced (6.5) water thereby avoiding a concentration.

CaNO ₃	Calcium Nitrate
K ₂ SO ₄	Potassium Sulphate
KNO ₃	Potassium Nitrate
KH ₂ PO ₄	Mono Potassium Phosphate
MgSO ₄	Magnesium Sulphate
TE	Trace elements
NH ₄ NO ₃	Ammonium Nitrate

Herbs in General

mixing directions based on teaspoon/10 litre (for small quantities only)

	Veg	Bloom
CaNO ₃	2 1/2	2
K ₂ SO ₄	1/6	1
KNO ₃	5/6	none
KH ₂ PO ₄	5/8	3/4
MgSO ₄	2 3/4	2 7/8
TE	1/5	1/6

Herbs in General

mixing directions based on grams/ltr (more accurate on a larger volume)

	Veg	Bloom
CaNO ₃	1.500 gr	1.020 gr
K ₂ SO ₄	0.115 gr	0.695 gr
KNO ₃	0.522 gr	none
KH ₂ PO ₄	0.348 gr	0.435 gr
MgSO ₄	1.120 gr	1.212 gr
TE	0.100 gr	0.090 gr

A & B concentrate (stock solution)
for mixing directions based on teaspoon/10 litre

When using an EC Meter it's helpful to form a concentrate that is easily administered to the nutrient solution to keep EC at optimum level. To achieve a 100x concentrate mix ten times the amount shown of each A's and B's in two separate one litre containers: A = 1st, 3rd and 6th on the list, B = 2nd, 4th and 5th on the list.

A & B concentrate (stock solution)
for mixing directions based on grams/ltr

When using an EC Meter it's helpful to form a concentrate that is easily administered to the nutrient solution to keep EC at optimum level. To achieve a 100x concentrate mix ONE HUNDRED times the amount shown of each A's and B's in two separate one litre containers: A = 1st, 3rd and 6th on the list, B = 2nd, 4th and 5th on the list.

Lettuce in NFT
mixing directions based on
grams/1000 ltr

CaNO ₃	825 gr
KNO ₃	433 gr
K ₂ SO ₄	111 gr
KH ₂ PO ₄	130 gr
NH ₄ NO ₃	57 gr
MgSO ₄	350 gr
TE	15 gr
HNO ₃	50 ml

Cucumber in NFT
mixing directions based on
grams/1000 ltr

CaNO ₃	833 gr
KNO ₃	450 gr
K ₂ SO ₄	223 gr
KH ₂ PO ₄	174 gr
NH ₄ NO ₃	29 gr
MgSO ₄	355 gr
TE	25 gr
HNO ₃	50 ml

Tomatoes or peppers in NFT
mixing directions based on
grams/1000 ltr

CaNO ₃	765 gr
KNO ₃	580 gr
K ₂ SO ₄	223 gr
KH ₂ PO ₄	220 gr
MgSO ₄	456 gr
TE	29 gr
HNO ₃	50 ml

Optimum levels for EC: Using CO₂ 3500 - 3800; Without CO₂ 2500 - 2800.

The calculations

- Determine the size of the tank.
- Determine what the ppm of the element is to be in the final mix.

- Go to the chart and select number of gallons.
- Divide the goal ppm by corresponding number.
- The answer is the number of ounces of nutrient to use.

Example

1. You have determined that you have a 50 gallon tank and you need 125 ppm(goal) of calcium added. You don't want to add any more nitrate so the compound you choose is calcium chloride. You next find that one ounce in a 50 gallon tank will add 27 ppm calcium. Next divide the goal by this number. $125/27 = 4.63$ oz. = about 1/2+ cup.
2. You have determined that you have a 150 gallon tank and you need 140 ppm(goal) of calcium added. You need more nitrate so the compound you choose is calcium nitrate. You next find that one ounce in a 50 gallon tank will add 33 ppm calcium and 23 ppm nitrate. Next divide the goal by this number. $140/33 = 4.25$ oz. Since you need it for 150 gallons, you will have to multiply by 3. So $4.25 * 3 = 12.75$ oz = about 1 1/2 cup. If you want to determine how much nitrogen you are adding, simply multiply the amount added to 50 gallons (4.25) by the ppm of nitrate from one ounce(23) which equal 115 ppm nitrate increase in the 150 gallon mixture when 12.75 oz of calcium nitrate have been added.

Conversions

1 Tbs = 3 tsp = 1/2 oz. = .5 oz

2 Tbs = 1oz = 1/8 cup

4.5 oz = 1/2 cup = .5 cup

Anything above 1/2 cup should be weighed. One cup of most compounds weigh about 9 oz.

- The cup is for liquids. A liquid ounce is measured by volume. A dry ounce goes by weight.

[Advanced Nutrient Management for Hydroponic.](#)

[Hydro-Gardens CHEM-GRO 4-18-38.](#)

Advanced Nutrient Management for Hydroponic Growers Check your nutrient IQ.

by Lawrence Brooke

To the skilled hydroponic grower, nutrient management represents an opportunity to enhance plant growth. To the novice, it represents a challenge to be dealt with. The difference is in knowledge, understanding and equipment. Consider the following questions to test your nutrient IQ:

What temperature is your nutrient solution, what is the range during a day and during a season?

What is the "dissolved solids" content of the water you use to mix your nutrient and does this content vary greatly from season to season? Does your water supplier provide you with good water from one reservoir at one time of the year and bad water from a different reservoir at another?

Are there any components in your water that could affect the availability of nutrients to your crop?

What is the "EC" or strength of your nutrient? Do you mix special nutrient blends for different kinds of plants and for each stage of the crop's life-cycle?

Does the pH of your nutrient stay within a reasonable range?

Are there any pathogens in your nutrient from a contaminated water supply or from sick plants that may spread disease to the rest of your crop?

Do you change your nutrient often enough to prevent excesses from salt accumulation or deficiencies from nutrient exhaustion?

Did you know that an important reason to change your nutrient solution is to eliminate the wastes your plants discard into the nutrient? Did you know that as plants transpire, moisture and nutrient levels drop in your reservoir and the EC or strength of the nutrient can rise to dangerous levels?

These are only a few basic questions that may help you better realize what you already know, and what you may need to learn to achieve outstanding crops every time. This discussion is especially for the advanced grower who wants to achieve the highest yields and is seriously interested in being at the leading edge of plant growing technology. Hobby growers generally don't have to worry about all of these questions, but don't stop reading just yet. When problems arise and a crop isn't growing as well as it should, the problem can often be traced to nutrient management. Once you know what can go wrong, it's easier to recognize a problem when it happens.

The root environment is what separates hydroponics from soil cultivation. In soil, plants await rainfall or irrigation, and their roots search out essential nutrients. With good, fertile soil and abundant water plants thrive.

In hydroponics, the plant roots are constantly provided with water, oxygen and nutrients--no searching for available nutrients or waiting for the next rain. The challenge for the grower is to keep up with the plants' needs and to avoid damaging plants with excesses or deficiencies of minerals, extremes in pH and temperature, or a lack of oxygen. A few simple tools and techniques can make the difference between success and failure.

What's In Your Water?

The first question to consider is water quality. With good, soft water it's easy to succeed. Just add the right combinations of nutrients to the water and you're off and growing. If you have very hard water, or water contaminated with sodium, sulfide, or any number of heavy metals, you may have to filter your water using "reverse osmosis."

So, what's in your water anyway? The most complete answer comes from having an analysis of your water done by a lab. If you're on a municipal water system, call your water district and request a copy of their most recent analysis.

Another approach - highly recommended - is to check your water regularly with a dissolved solids meter, also called an electrical conductivity (EQ) or parts per million (PPM) meter. These instruments are one of the most important tools for a grower to have and use regularly.

All of these instruments work in essentially the same way. They measure the electrical conductivity of the water. It is the dissolved salts in most water that allows it to conduct electricity. Pure water is a poor conductor since there are none of the conductive salts found in impure water. Purified water will show no, or very low, salt content (conductivity) when tested with a dissolved solids meter.

It is not uncommon to find high levels of salts in well water or municipal water supplies. Calcium and Magnesium carbonates are among the most common ingredients in tap water and in well water. In fact, water "hardness" is defined as a measure of the water's content of calcium and magnesium carbonates, or sulfates.

Since calcium and magnesium are important plant nutrients, water with reasonable levels of these elements can be just fine for hydroponic cultivation. However, even a good thing can become a problem if the levels are too high.

Generally, a calcium content of more than 200 PPM, or 75 PPM for magnesium, are on the verge of excessive for most hydroponic applications. An excess can cause other important elements in the nutrient solution to "lock-out" and become unavailable. For example, excess calcium can bond with phosphorous to make calcium phosphate, which is not very soluble and therefore not available to the crop. The key is to start with decent water and add the right combination of nutrients.

Too Hot, Too Cold

Water temperature is another important factor. If your solution is too cold, seeds won't germinate, cuttings will not root and plants will grow slowly - or stop growing and die. If it's too hot, the same seeds won't germinate, cuttings won't root and plants will die from oxygen deficiency or simply from temperature stress. Most plants prefer a root zone temperature range of between 65 degrees (18 C) and 80 degrees (27 C), cooler for winter crops, warmer for tropical crops. When adding water to your reservoir, it is a good idea to allow it to come to the

same temperature as the water in the reservoir.

Remember, plant roots have evolved in a soil environment, where temperature changes occur slowly, tempered by the thermal mass of the earth.

Plants do not like rapid temperature changes, especially in the root zone!

Water pH

A subject that is often discussed but rarely understood by many growers is nutrient pH. Generally, we worry about pH and its affect on nutrient availability. For example, if pH is too high, iron may become unavailable. Eventhough your nutrient solution may have an ideal iron content, your plants may not be able to absorb it, resulting in an iron deficiency: the plant's leaves will yellow and weaken.

On the other hand, advanced hydroponic plant foods contain special "chelates" that are designed to assure iron availability at higher pH ranges. The result is that your crop will grow reasonably well. even at higher pH levels. Nonetheless, high pH can damage plants in other ways, The cause of a high solution pH can be fairly complex. Most city water supplies contain calcium carbonate to raise the pH of the water and prevent pipes from corroding. As a consequence you are starting with water that has an abnormal pH, typically 8.0 for city water.

The beg way to deal with this is to mix fresh nutrient with your water, let stand for a while to stabilize, then test and adjust the pH. With city water supplies you will often have to add a bit of pH down (usually phosphoric acid) to lower the pH to the range for most plants, between 5.8 and 6.2.

As the plants grow. it is a good idea to occasionally test the pH and adjust it if needed. You can safely allow pH to drift between 5.5 and 7.0 without adjustment. in fact, constantly dumping chemicals into your system to maintain a perfect pH of 5.8 to 6.0 can do a lot of damage. It is common for pH to drift up for a while, then down, and up again. This change is an indication that your plants are absorbing nutrient properly. Adjust pH only if it wanders too far.

A pH below 5.5 or above 7.0 can mean trouble. but don't overreact. An apparently sudden and dramatic shift in pH can be the result of a malfunctioning pH meter. If in doubt, double check with a reagent (color match) pH kit before adjusting your solution. Also remember that all pH measuring methods are temperature dependent. Read and follow all of the instructions that came with your meter or test kit.

Media Culpa

Another cause of unstable pH is poor quality growing media. Industrial grade rockwool and gravel are notorious for having very high pH levels that cause your nutrient pH to rise, often to constantly rise, often to dangerous levels.

A simple way to test a new growing medium is to put some of the medium - rockwool, gravel, soil - into a clean cup, then immerse (soak) the sample. in distilled or "deionized" (chemically pure) water. Let this sit for a little while and then test the pH of the water, note the pH and continue to let the sample sit. Test the pH occasionally for about a week until it has stabilized. Has the pH risen to 8.0, perhaps 9.0? Construction grade gravel can go as high as 10.0 - torture to roots. death to plants!

Never underestimate growing media as sources of pH problems. This is one of the primary reasons that "waterculture" hydroponic methods are gaining popularity over "media-based" hydroponics. The less medium you use, the fewer problems you will encounter with pH instability and salt accumulation. Plus, the water-culture systems require less water and nutrient than media-based methods, due to higher efficiency and reduced evaporation.

Time for a change?

How often should you change your nutrient solution? That's one of the most common questions asked, and one of the most difficult to answer. Many people have tried to come up with a simple, easy-to-follow rule - once a week, every two weeks - but they're all wrong! They're wrong because there is no simple answer. It all depends on the species, the number and size of your plants, the capacity of the reservoir, the kind and quality of nutrient you use, water quality, environmental conditions such as temperature and humidity, and the type of hydroponic system used. Instead of a simple answer, what we need is a procedure that takes many of these variables into account and is responsive to changing conditions.

It sounds complicated, but it's actually quite simple. All it takes is a little monitoring and some basic record keeping. Start with a fresh reservoir of nutrient and make note of the date, pH, and EC or PPM of the solution. As you run the system, the level will drop in the reservoir. Note the EC/PPM level, then top-up the reservoir with fresh water. Test again for nutrient concentration. If the nutrient strength has dropped significantly, add a bit of nutrient to bring it back up to specs.

Be sure to record how much water you added to top-up the reservoir. Repeat the procedure every time you top up the system, carefully recording the amount of water added. When the total amount of water added equals the capacity of your reservoir, it is time to drain and replace all of the nutrient solution.

For example, imagine a hydroponic system in a cool, spring greenhouse with 24 strawberry plants and a nutrient capacity of 20 gallons. Typically, such a system would require about 5 gallons of added water each week. After four weeks the plants will have transpired 20 gallons - the capacity of the reservoir. You need to completely drain and replace the nutrient every four weeks in this example.

Nutrient Pathogens

The problem of pathogens or disease in the nutrient solution can be a serious one. It is not uncommon for this to be a regional and seasonal problem. For example, in Holland during the winter, fungi thrive in the cool and damp environment: the air is full of spores. All kinds of soil-borne diseases become endemic in the Dutch winter and growers have to work hard to avoid infestations. One of the reasons Dutch growers adopted hydroponics so readily was to avoid soilborne diseases.

Keep your growing area clean. Never allow soil to get into the nutrient stream. If soil is accidentally kicked into the reservoir, the entire crop can be at risk. Some growers will place a sponge-mat soaked with disinfectant at the doorway of the greenhouse. Everyone who enters must clean their shoes on this mat before entering. This is an effective and practical way to prevent disease organisms from entering the greenhouse and endangering the crop.

If an infected plant is introduced into a hydroponic system, the disease can race through the entire crop. By the time a problem is noticed it may be way out of control. Plant diseases are beyond the scope of this article, but the best advice is to avoid problems by working clean, planting only healthy disease free plants, and closely

monitoring the crop.

If you see evidence of disease in a single plant, remove and destroy it quickly before the disease spreads. Watch the crop closely and destroy any other plants that show signs of disease. It is better to lose a few sick plants than to risk an entire crop.

If you do encounter disease problem, it is a good idea to completely drain and renew your nutrient after removing the sick plants. If it is possible there is nothing better than to flush the system by running fresh water without nutrient for a day. Then drain and refill with fresh nutrient. Flushing between every three or four nutrient changes can help maintain cleanliness in the root zone and in the hydroponic system. Periodic flushing is especially helpful for gravel systems to remove salt accumulation in the medium.

To the Limit

To some hobby growers, especially those who come to hydroponics from the "U-plant-em-and-pray" school of outdoor gardening, the techniques described above might seem too difficult and time-consuming. Remember, hydroponics offers great control over the health and quality of plants today's grower with the interest and the skill to exercise that control. That's what this article is all about - pushing it to the limits. Remember, too, that it is possible to produce a hydroponic garden that will out-perform any soil garden by simply following the manufacturer's instructions on system operation and nutrient changes, and paying attention to the condition of your plants. But even the most casual grower can benefit from an understanding of a few basic concepts.

Quality water is a great advantage, poor water is a challenge. Use only the highest quality plant food, designed specifically for hydroponics. Low grade plant foods and common fertilizers offer your plants poor and incomplete nutrition, cause pH drift, and sometimes contain impurities that can become toxic to hydroponic plants. Only high-quality plant food can grow superior plants. Healthy plants grow faster, generate higher yields and are resistant to disease and insect infestation. When you mix fresh nutrient always measure carefully.

Keep notes on your observations of EC drift, pH drift, total water usage, temperature range, and comments on crop health and progress. Keep an eye on pH, and an especially close watch on nutrient strength (PPM, EC, dissolved solids). Look out for diseases and remove and destroy sick plants immediately.

Control your nutrient temperature - use high quality aquarium heaters to warm nutrient in the winter, look for "chillers" to cool your nutrient in the summer if high nutrient temperature becomes a problem. The aquaculture or fish farming people have developed excellent chillers. Fish don't like water that's too hot or too cold either.

Don't be overwhelmed or intimidated. Plants can tolerate quite a lot of stress and still produce well. On the other hand, the grower who knows the questions and how to find answers, is the one who will have consistently good crops. It is far easier to avoid problems through knowledge and proper technique than to fix them after they arise.

Lawrence L. Brooke is the owner and founder of General Hydroponics in Sebastopol, California.

Hydro-Gardens

CHEM-GRO 4-18-38

Fertilizer Mixing Instructions (Sump Tank Dilution)

To make 100 gallons of (plant usable) working nutrient solution in a holding (sump) tank, the following amounts should be combined by following the instructions.

For 'DUTCH' Tomato Varieties (Laura, Caruso, Match, Trust, Etc.)

SEEDLING PLANTS

- 100 gallons of water
- 8 ounces (1/2 pound) of CHEM-GRO 4-18-38
- 4 ounces (1/4 pound) of Calcium Nitrate
- 4 ounces (1/4 pound) of Magnesium Sulfate
- Adjust pH to 6.5
- Conductivity 1200ppm including source water

SECOND FLOWER CLUSTER TO 4TH FLOWER CLUSTER

- 100 gallons of water
- 8 ounces (1/2 pound) of CHEM-GRO 4-18-38
- 8 ounces (1/2 pound) of Calcium Nitrate
- 4 ounces (1/4 pound) of Magnesium Sulfate
- Adjust pH to 6.2
- Conductivity 1500ppm including source water

AT 4TH CLUSTER OF FLOWERS AND OLDER PLANTS

- 100 gallons of water
- 8 ounces (1/2 pound) of CHEM-GRO 4-18-38
- 8 ounces (1/2 pound) of Calcium Nitrate
- 5 ounces (.31 pound) of Magnesium Sulfate
- Adjust pH to 6.2
- Conductivity 1700ppm including source water

For 'Nitrogen Sensitive Tomato Varieties

SEEDLING PLANTS

- 100 gallons of water
- 8 ounces (1/2 pound) of CHEM-GRO 4-18-38
- 4 ounces (1/4 pound) of Calcium Nitrate
- 4 ounces (1/4 pound) of Magnesium Sulfate
- Adjust pH to 6.5
- Conductivity 1200ppm including source water

MATURE SIZE PLANTS (at 4th Flower Cluster)

- 100 gallons of water
- 8 ounces (.50 pounds) of CHEM-GRO 4-18-38
- 8 ounces (.50 pounds) of Calcium Nitrate
- 4 ounces (.25 pounds) of Magnesium Sulfate
- Adjust pH to 6.2
- Conductivity 1500ppm including source water

Hydro-Gardens does not recommend using the same fertilizer solution for "nitrogen sensitive" Varieties with "Nitrogen tolerant" varieties like Caruso and Laura. Too high a nitrogen level will adversely effect thier production.

Examples:

Quantity of Fertilizer	Quantity of Water	Quantity of Fertilizer	Quantity of Water
1/2 lb. Chem-Gro	100 gallons	5 lbs. Chem-Gro	1,000 gallons
1/2 lb. Calcium Nitrate			
1/4 lb. Magnesium Sulfate			

The best growing temperatures for tomatoes should be measured at the FLOWERING LEVEL of the crop. This means that you will have to adjust your temperature sensing equipment as the plants grow, We recommend the following temperatures:

	<u>DAY</u>	<u>NIGHT</u>
Germination	78°F	78°F
Seedlings	78°F	62°F
Mature Plants	78°F	64°F

NOTE:

If the calcium level of your source water is below 50 PPM, you should add 1 ounce of Calcium Chloride, (or 25% of the weight of Calcium Nitrate that you are adding) per 100 gallons of working solution, in with the calcium nitrate until you have increased your calcium levels to full strength. This will supplement the calcium levels in your working solution without increasing the amount of nitrogen to your seedling plants.

Adjustments may be necessary to correct minor elements on mature plants. Analysis of plant tissue and nutrient solution should be made on a monthly basis to determine the requirements of the plants through the changing seasons of the year. It is very difficult to diagnose a nutritional problem without lab reports. The nutrient requirements of plants change with the seasons of the year and with available light conditions. Rapid response to these changes will enable you to keep your production at optimum levels.

We strongly recommend that you have on hand a copy of "Nutritional Disorders In Glasshouse Tomatoes, Cucumbers and Lettuce" by J.P.N.L. Roorda van Eysinga and K.W. Smilde. This book is a collection of color photographs, plates, and slides showing the deficiency and toxicity symptoms for each of these disorders. It also provides a written description of each disorder and the recommended procedures to correct the problem. To see more info. on the book ---- [Click Here](#)

The formulation of **4-18-38** has been developed from **Hydro-Gardens'** years of experience with hundreds of growers across the country. It has been used on thousands of tomato crops in every type growing system and with every type media available. This fertilizer has a very low salt index. This means you get more usable fertilizer for your money, and healthier plants that have higher yields.**If you don't see the Chem-Gro trademark, you may be getting an inferior substitute.**

Calcium Nitrate and **Magnesium Sulfate** must be added to this formula to obtain a complete nutrient. Recommendations should be based on nutrient and tissue analyses. Samples should be sent to;

Servi-Tech Laboratories
1816 East Wyatt Earp
Dodge City, KS 67801
(316) 227-2047
FAX: (316) 227-2047

4-18-38 is soluble and completely balanced. Use with injectors, NFT or sump tank application. It contains all of the trace minerals needed in the proper amounts for maximum production. It is our most popular formula since it can be used with peat-lite, wood shavings, sand, gravel, soil, rice hulls, perlite, rockwool and NFT.

The above has been copied by permission from the hydro-Gardens web site.

Color Pictures of Mineral Deficiencies in Plants

from

[The Diagnosis of Mineral Deficiencies in Plants by Visual Symptoms](#)

by **Thomas Wallace, M.C., D.Sc., A.I.C.**

University of Bristol Agricultural and Horticulture Research Station, Long Ashton, Bristol

London — Published by His Majesty's Stationary Office — 1943

— Crown Copyright Reserved —

pH Acidbase.

pH Acidbase

Chemical change results in the production of new substances; these substances may be helpful or harmful (and sometimes both!). Two types of substances which are very important in everyday life are acids and bases.

Acids are sour, water-soluble substances which are very useful in industry, household cleaning agents, and cooking; some examples are vinegar, vitamin C tablets, club soda, Aspirin, lemon juice and cream of tartar. Vinegar is a solution of about one part acetic acid to 20 parts water - such a mixture of acid and water is called an acidic solution. Lemons and grapefruit have a tangy flavour, because they contain an acid called citric acid. Baking powder contains a dry acid called tartaric acid. Another very important acid is stomach acid (dilute hydrochloric acid) which aids in the digestion of our food. Acids which are not diluted in water are dangerous - they undergo chemical change so readily that they can react with skin and cause burns.

Bases are bitter, water-soluble substances which are also very useful. Examples of bases are ammonia, baking soda, and drain cleaner. Bases are also used in some batteries. The solutions they form with water are called basic or alkaline solutions. Bases are also highly reactive and must be treated with extreme caution, as they also react readily with skin.

You have probably heard of antacids. These substances are bases which are safe to ingest and which react with stomach acid. A chemical change in which an acid reacts with a base is called neutralization. It is called neutralization because equal amounts of acid and base produce a solution which is neutral - neutral acidic nor basic. Antacids are used when the stomach contains too much acid, which irritates the stomach lining.

The pH scale is a measure of how acidic or basic a solution is. This scale ranges from 0 for an extremely acidic solution to 14 for an extremely basic solution. A neutral solution has pH 7. A decrease of one unit on this scale represents multiplying acidity ten times. Most plants prefer a slightly acidic pH 6.0 - 6.5. Correct pH levels are important for the plant to be able to take up all the nutrient supplied in the solution. A too high or low pH is one of the most common problems associated with home hobby growers. These problems show quickly and can be countered quickly and easily!

Most city tap water has a slightly basic pH 7 - 8, the nutrient we mix into a solution is acidic based and will adjust the pH a point or so lower. We may however have to adjust further down using a stable, usable acid such as a dilute phosphoric acid. This is the most common scenario.

Perhaps the source of water we use is acidic (eg. some well and ground waters) and after mixing the nutrient we need to adjust the pH higher. In this case we would use a stable, usable alkali such as a dilute di-potassium phosphate.

A simple method can be used to detect whether a solution is acidic or basic. An indicator is a substance which changes color, depending on whether it is placed in an acidic solution or a basic solution. There are also electronic meters available to easily check pH levels in solution. They are simply dipped into the solution and give a digital read out.

Perhaps one of the most overlooked aspects of gardening, pH is very important in hydroponic and

organic as well as regular "dirt" gardening. pH is measured on a scale of 1-14 with 7 being "neutral". Acids are lower than 7 and alkalis (bases) are above 7.

This article deals with the pH of hydroponic gardening and the availability of nutrients at different pH levels in a soilless growing medium. Organic and dirt gardening have different levels, so the following chart doesn't pertain to them.

To be technical, the term pH refers to the potential hydrogen-hydroxyl ion content of a solution. Solutions ionize into positive and negative ions. If the solution has more hydrogen (positive) ions than hydroxyl (negative) ions then it is an acid (1-6.9 on the pH scale). Conversely if the solution has more hydroxyl ions than hydrogen it is alkaline (or base), with a range of 7.1-14 on the pH scale.

Pure water has a balance of hydrogen (H⁺) and hydroxyl (OH⁻) ions and is therefore pH neutral (pH 7). When the water is less than pure it can have a pH either higher or lower than 7.

The pH scale is logarithmic, which means that each unit of change equals a ten fold change in the hydrogen/hydroxyl ion concentration. To put it another way, a solution with a pH of 6.0 is 10 times more acidic than a solution with a value of pH 7.0, and a solution with a pH value of 5.0 would be 10 times more acidic than the solution of 6.0 pH and 100 times more acidic than the solution with a 7.0 pH. This means that when you are adjusting the pH of your nutrient solution and you need to move it 2 points (example: 7.5 to 5.5) you would have to use 10 times more adjuster than if you were moving the pH value just 1 point (7.5 to 6.5).

WHY IS pH IMPORTANT?

When the pH is not at the proper level the plant will lose it's ability to absorb some of the essential elements required for healthy growth. For all plants there is a particular pH level that will produce optimum results (see chart 1 below). This pH level will vary from plant to plant, but in general most plants prefer a slightly acid growing environment (between 6.0 - 6.5), although most plants can still survive in an environment with a pH of between 5.0 and 7.5.

When pH raises above 6.5 some of the nutrients and micro-nutrients begin to precipitate out of solution and can stick to the walls of the reservoir and growing chambers. For example: Iron will be about half precipitated at the pH level of 7.3 and at about 8.0 there is virtually no iron left in solution at all. In order for your plants to use the nutrients they must be dissolved in the solution. Once the nutrients have precipitated out of solution your plants can no longer absorb them and will suffer (or die). Some nutrients will precipitate out of solution when the pH drops also. Chart 2 (below) will give you an idea of what happens to availability some of the nutrients at different pH levels:

Chart 1

pH Values For Different Hydroponic Crops

(From *Hydroponic Food Production*
by Howard M. Resh
Woodbridge Press, 1987)

Plant	pH Range
Beans	6.0-6.5
Broccoli	6.0-6.5
Cabbage	6.5-7.5
Cantaloupe	6.5-6.8
Carrots	5.8-6.4
Chives	6.0-6.5
Cucumbers	5.8-6.0
Garlic	6.0-6.5
Lettuce	6.0-6.5
Onions	6.5-7.0
Peas	6.0-6.8
Pineapple	5.0-5.5
Pumpkin	5.0-6.5
Radish	6.0-7.0
Strawberries	5.5-6.5
Tomatoes	5.5-6.5

Chart 2

Availability Of Nutrients Available At Different pH Levels

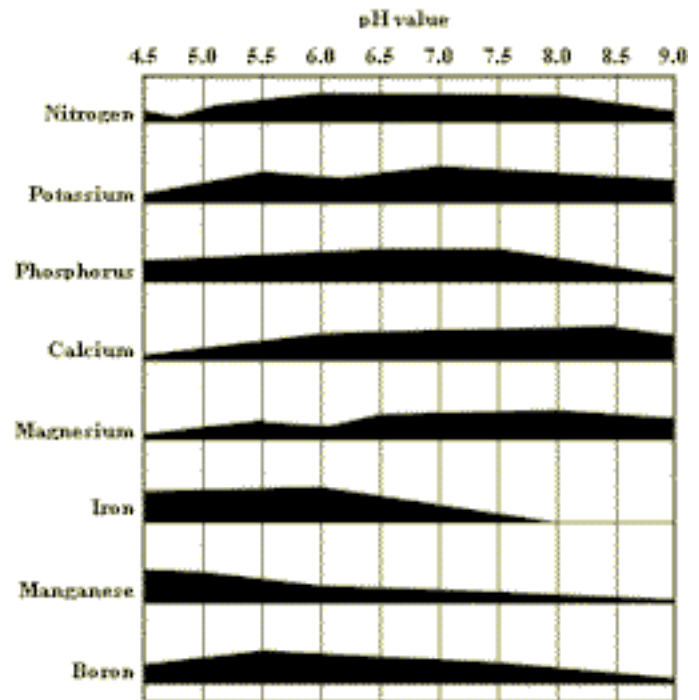

NOTE:

This chart is for soilless (hydroponic) gardening only and does not apply to organic or dirt gardening.

CHECKING pH

When you are growing hydroponically checking and adjusting pH is a simple matter, it can be a bit more complicated when growing organically or in dirt. There are several ways to check the pH of the nutrient solution in your hydroponic system.

Paper test strips are probably the most inexpensive way to check the pH of the nutrient solution. These paper strips are impregnated with a pH sensitive dye which changes color when dipped into the nutrient

solution. The paper strip is then compared to a color chart to determine the pH level of the solution being checked. These test strips are inexpensive, but sometimes they can be hard to read, because the color differences can be subtle.

Liquid pH test kits are probably the most popular method to check pH for the hobby gardener. These liquid test kits work by adding a few drops of a pH sensitive dye to a small amount of the nutrient solution and then comparing the color of the resulting liquid with a color chart. The liquid kits are a bit more expensive than the paper test strips but they work very well, and are normally easier to "read" than the paper indicator strips.

The Most high-tech way to check pH is to use the digital meters. These meters come in a huge array of sizes and prices. The most popular type of pH meter for the hobby gardener are the digital "pens". These pens are manufactured by several different companies and are very handy and easy to use. You simply dip the electrode into the nutrient solution for a few moments and the pH value is displayed on a LCD display.

The pH meters are very accurate (when properly calibrated) and fast. They need to be cared for properly however, or they will quit working. The glass bulb electrode must be kept clean and wet at all times. The pH meters are actually very sensitive volt meters and are susceptible to problems with the electrode.

The pH meters are slightly temperature sensitive. Many of the pH meters on the market have Automatic Temperature Compensation (ATC), which corrects the reading with respect to temperature. On meters without ATC the pH should be checked at the same time of day each time in order to minimize any temperature related fluctuations.

The pH meters usually need to be calibrated frequently, as the meters can "drift" and to insure accuracy you must check calibration often. The tip needs to be stored in a electrode storage solution or in a buffer solution. The tip should never be allowed to dry out.

Due to the fact that pH meters have a reputation of breaking down without warning it is a good idea to keep an emergency back up for checking pH (paper test strips or a liquid pH test kit), just in case.

ADJUSTING pH

There are several chemicals used by the hobby gardener to adjust pH. The most popular are probably phosphoric acid (to lower pH), and potassium hydroxide (to raise pH). Both of these chemicals are relatively safe, although they can cause burns and should never come in contact with the eyes. Most hydroponic supply stores sell pH adjusters that are diluted to a level that is reasonably safe and easy to use. Concentrated adjusters can cause large pH changes and can make adjusting the pH very frustrating.

Several other chemicals can be used to adjust the pH of hydroponic nutrient solutions. Nitric acid and

sulfuric acid can be used to lower pH but are much more dangerous than phosphoric acid. Food grade citric acid is sometimes used in organic gardening to lower pH.

Always add the nutrients to the water before checking and adjusting the pH of your nutrient solution. The fertilizer will usually lower the pH of the water due to it's chemical make up. After adding nutrient and mixing the solution, check the pH using what ever means you have. If the pH needs to be adjusted add the appropriate adjuster. Use small amounts of pH adjuster until you get familiar with the process. Recheck the pH and repeat the above steps until the pH level is where you want it to be.

The pH of the nutrient solution will have a tendency to go up as the plants use the nutrients. As a result the pH needs to be checked periodically (and adjusted if necessary). To start out I suggest that you check pH on a daily basis. Each system will change pH at a different rate depending on a variety of factors. The type of growing medium used, the weather, kind of plants and even the age of the plants all effect the pH variations.

Foods Grown in Hydroponics

HERBS

[Basil](#)

[Chamomile](#)

[Chives](#)

[Dill](#)

[Lavender](#)

[Mint](#)

[Tarragon](#)

[Thyme](#)

[Sage](#)

SALAD GREENS

[Lettuce](#)

[Watercress](#)

[Arugula](#)

[Mustard](#)

[New Zealand spinach](#)

VEGETABLES

[Beans](#)

[Peas](#)

[Squash](#)

[Melon](#)

[Tomato](#)

[Garlic](#)

[Corn](#)

[Eggplant](#)

[Cucumber](#)

[Peanut](#)

[Radish](#)

[Bell Pepper](#)

[Parsnips](#)

[Turnips](#)

[Potato](#)

[Carrot](#)

[Onion](#)

Sweet Basil
Ocimum basilicum



Basil



Dark Opal Basil
Ocimum basilicum 'Purpurascens'



Globe Basil
Ocimum basilicum
'Globe'

Basil is a highly flavored herb that grows very quickly in hydroponic culture. It can be grown from seed, but it takes as long as two weeks to germinate. It can also be started from cuttings simply cut from new growth on an existing plant, stripped of its lower leaves and then placed in a tub grower with its lower portion in the nutrient water.

Basil is grown and then harvested from green leafy portions. A basil plant will continue to grow as it is being harvested but will eventually become woody and may need to be replaced. The basil leaves are used in a wide variety of cooking and have medicinal uses as well.

Basil is kept on grow nutrient to reduce the flowering. It should be ready for picking leaves after about 60 days of growth, and a single plant should provide about three sprigs a day. There is seldom need for a whole tub of basil, and three plants should be more than enough for most kitchens. Plants should be started every three months to replace basil that are getting "too woody".

Trace mineral supplements should be added to the water of the basil plants as they ripen.

Links to Internet

[Planting information](#)

Basil is a highly flavored herb that grows very quickly in hydroponic culture



Holy Basil
Ocimum sanctum

Basil (*Ocimum basilicum* L. and its varieties) is a popular herb known for its flavorful foliage. The fresh or dried leaves add a distinctive flavor to many foods, such as Italian style tomato sauces, pesto sauce and salad dressing. The essential oils and oleo-resins may be extracted from leaves and flowers and used for flavoring in liqueurs and for fragrance in perfumes and soaps.

Varieties - Many types of basil are available, depending on use. For fresh market production, select a basil with good flavor and attractive, dark green or purple foliage. Sweet basil (*Ocimum basilicum* L.) is the culinary classic. Italian, Lettuce Leaf and Opal are popular sweet basil varieties. Scented basil, such as Lemon, Licorice and Cinnamon basil, are used fresh or dried in potpourri, jellies, honeys, vinegars and baked goods. For production of dried leaves or essential oils, French, American or Egyptian basil may be grown. There are also several ornamental type basil.

Planting - All basil are tender annuals which are easy to grow, but are very susceptible to cold weather. They should be planted in late spring after all danger of frost is past. To produce high quality basil, grow it in full sun in warm, well-drained soil. Raised beds are highly recommended because they promote good drainage and warm quickly in the spring. A light sand to silt loam with a pH of 6.4 is best.

Basil may be grown in the field from seed or transplants. For a direct-seeded crop, sow seed thinly (8-10 seeds per inch) in a well-prepared seedbed. About 6 lbs. of seed are required to seed one acre. A small, manual seeder, or a commercial onion seeder, will provide an even seeding rate. To prevent the soil from crusting, cover with a fine layer of soil (approx. $\frac{1}{8}$ inch) mixed with vermiculite or peat and keep the soil surface moist. Plants should emerge in 8-14 days.

Basil may also be grown from transplants started in the greenhouse in late March to early April for the piedmont and coastal counties and mid-April to early May for the mountains. Trim transplants to encourage branching and plant into the field when about 6 inches tall (4-6 weeks old). Basil also roots readily from cuttings.

Space plants 2-3 feet between rows, depending on cultivation equipment, and 6-12 inches within the row. Double-row plantings on 2-4 foot wide beds increase yields per acre and help to shade out weeds. Large producers growing for oil plant 30,000 to 35,000 plants per acre. Planting dates may be staggered to provide a continuous supply of fresh leaves throughout the growing season.

For fresh-cut basil production, the use of mulch is highly recommended. Mulch conserves moisture, reduces weed growth, and keeps the basil leaves clean. Highest yields have been obtained with black, polyethylene mulch. Hardwood bark and straw also are good choices.

Fertilization - Do not overfertilize basil or flavor will be sacrificed for growth. Although specific recommendations are not available, generally it is suggested that 100 pounds each of N, P₂O₅ and K₂O per acre be broadcast and incorporated at time of planting or follow guidelines for fertilization of salad greens. If more than one harvest is made, sidedress with 15 to 30 pounds N per acre shortly after the first or second cutting.

Irrigation - Basil will not tolerate moisture stress. Provide a regular supply of water through drip or overhead irrigation.

Weed Control - Currently, there are no herbicide registrations for basil in NC with the exception of Devrinol, which may be used only on basil grown for oil production. Weed control is critical, however, because competition with weeds decreases the quality of fresh or dried basil leaves. To keep weed populations low, use high plant populations, shallow cultivation, or mulch. Mulch, plastic or organic, also helps retain moisture in the soil and prevents soil from being splashed onto the foliage.

Disease Control - There are no pesticides registered for disease control on basil. Prevention of disease through good cultural practices is the most effective means for healthy crop production. To help prevent foliar fungal diseases, keep foliage as dry as possible by watering early in the day so foliage dries quickly, or by using drip irrigation. To reduce soil borne diseases, rotate herbs to different parts of the field each year and remove and destroy all plant debris after final harvest.

A devastating basil wilt disease caused by a soilborne pathogenic fungus, *Fusarium oxysporum f. sp. basilicum*, was first discovered in the U.S. in 1991 and identified in N.C. in 1992. Plants infected with this disease usually grow normally until they are six to twelve inches tall, then they become stunted and suddenly wilt. Initial symptoms usually include brown streaks on the stems, discoloration of the internal stem tissue, and sudden leaf drop. Interestingly, only sweet basil is affected. Some of the specialty basil, such as lemon basil and purple basil, show some resistance to the disease.

The disease is introduced into fields, hydroponic systems, and greenhouse culture primarily through contaminated seed. Growers should only buy basil seed that has been tested for the fusarium wilt fungus. Currently, these tests involve growing out a large number of seed and looking for disease symptoms. This does not guarantee that the seed will be free of infection, but it greatly reduces the risk. If it is not possible to obtain tested seed, the seed should be soaked in cold water for four hours followed by a heat treatment of 20 minutes in 133-136 degree F water. Seed germination rates will probably be reduced by the hot water treatment, so a germination test should be conducted on a small lot of the treated seed to determine how much seeding rates need to be adjusted. Also, the hot water treatment causes a sticky layer to develop on the outer surface of seed making it difficult to handle.

Once a field has become infested with the fusarium wilt pathogen, infective propagules may persist in the soil for 8-12 years. During that time, growers should avoid growing sweet basil or members of the mint family. Mints will not exhibit symptoms of the disease but may carry over the inoculum from year to year. There are currently no products registered to help control this disease.

Insect Control - Javelin (*Bacillus thuringiensis*) is the only insecticide registered for use on basil in North Carolina. It is a biological control that kills a variety of caterpillars. If other insect problems become serious, other organic methods may be tried. Reflective mulches, beneficial insects, insecticidal soaps, traps and hand-picking may give some level of control.

Harvesting - Leaf yields range from 1 to 3 tons per acre dried or 6 to 10 tons per acre fresh. Foliage may be harvested whenever four sets of true leaves can be left after cutting to initiate growth, but when harvesting for fresh or dried leaves, always cut prior to bloom. Presence of blossoms in the harvested foliage reduces the quality, and consequently price, of the fresh and dried product. Frequent trimming helps keep plants bushy. For small-scale production of fresh-market basil, the terminal 2- to 3-inch long whorls of leaves may be cut or pinched off once or twice a week. This provides a high quality product with little stem tissue present. Basil can also be cut and bunched like fresh parsley. A sickle bar type mower with adjustable cutting height is commonly used for harvesting large plantings for dried production. When harvesting for essential oil production, basil should be harvested during full bloom.

Postharvest Handling - For fresh market sales, after harvest, wash and dry leaves and remove all weeds and flowers. Only the highest quality basil with the best color and aroma should be used. Wholesale packs may be prepared by filling perforated plastic bags with one pound of loose leaves. For retail sales, small, uniform bunches of leaves may be tied and packaged. Keep all basil refrigerated until sold. The optimum storage temperature is 40 to 45 F. Lower temperatures may cause discoloration.

For a dried finished product, wash leaves, spread on screens, and sort out weeds and blossoms. To retain maximum color, circulate warm air (less than 130 F) around the leaves until dry. Sun-dried leaves tend to be brownish. Store in air-tight containers in the dark. For essential oil production, cut basil should be field dried for 1-3 days prior to collecting and distilling.

Further Reading

- Davis, J.M. 1995. *North Carolina Basil Production Guide*. North Carolina Cooperative Extension Service, N.C. State University, Raleigh. AG-477.
- Foster, S. 1993. *Herbal Renaissance*. Peregrine Smith Books, Layton, Utah.
- Simon, J.E. 1996. *Basil*. New Crop Factsheet. Purdue University, West Lafayette, Indiana.
- Trueman, S.L. and R.L. Wick. 1996. Fusarium wilt of herbs. *Proceedings of the international symposium on medicinal and aromatic plants*. Craker, Nolan, and Shetty (eds.). Acta Hort 426, ISHS

Chamomile (*Anthriscus cerefolium*) is used as a tea and a medicinal herb. The flowers and leaves are mostly used for teas and medicinal tonics, but they are also used to add texture and bind foods such as meatloaf or dressing.

Chamomile can be grown from seed and takes as long as two weeks to germinate. It can then be changed to bloom nutrient when it starts to flower. Chamomile is a pioneer herb and can collect trace minerals.

Hydroponic Culture: Chamomile is a slow growing herb and does not produce much blossom per plant, so a full tub of 20 plants is needed to provide enough for daily use. Chamomile is planted about 40 seeds per tub and then thinned when it reaches 6" high. It is often a slow grower but survives well once it is established.

Chamomile is kept on grow nutrient to reduce the flowering. It should be ready for harvesting blossoms in about 60 days. If possible, chamomile can be grown near the sleeping area to help promote a restful sleep.

Medicinal uses:

Chamomile is useful in providing manganese, which can be helpful for seizure disorders. It can be added to the diet of a person suffering from stress or sleep disorders. It is well known for use in ulcers and wounds.

A chamomile tea is said to be good for a restful sleep, reducing stress and nervousness.

Helps digest food and increases appetite.

Applied to skin for dry skin disorders, including scalp.

Can be helpful to allergy as a tea or stuffed in pillow, or live plants.

Chamomile is a pioneer plant and can collect trace minerals from poor soils. It is useful in providing manganese, which can be helpful to seizure disorders.

Trace mineral supplements should be added to the water of the chamomile plants to ensure trace minerals. This can be from a mineral supplement from a health food store, and we are selling Equinox Master Formula for this purpose. Some of the flavor is apparently due to trace minerals.

Chamomile Tea: Two teaspoons or more of flowers steeped in hot water for five minutes. Can be used with peppermint for sleep.

Herbal Pillow: Chamomile flowers can be dried and stuffed into a pillow for sleep. Should be replaced

each month.

Live plants can be placed near sleeper in bedroom.

Caution: Handling live plant can cause dermatitis.

[Chamomile Information.](#)

Chamomile Planting.

One of the oldest and best studied herb. Medicinal uses include the famed tea for Peter Rabbitt. The name chamomile is derived from the latin:

Chamos - ground : grows close to the ground

Melos - apple : for the scent of the foliage and flowers

The name is used interchangeably to two types of plants:

German Chamomile- Annual- *Matricarica recutita*

Roman Chamomile- Perennial - *Anthemis nobile*

Description:

Flower:

German Flowers up to 1" across. Hollow cone-shaped receptacle with yellow disk flowers covering the cone. The cone is surrounded by 10-20 down-curving ray petals similar to a daisy.

Roman Same as German except cone is a much flatter cone and it is solid.

Plant:

German: Tiny twice divided linear segmented leave growing on a sweetly scented braching stems to a height of 2.5 feet. Native to Europe and westren Asia wher it has escaped from cultivation. Roman- Fern like leaves of gray green color on ground hugging stems that reach about 12" in height. Native to Western Europe to Nrothern Ireland. Stems are slightly hairy and flowers sit singly on top of the stem. Seed: The seeds of chamomile are very small and dust like.

They are three sided and have no thistle down.

Roman: Spreading habit about 1' tall. Same leaf strucutre with the leaflets being shorter and wider.

Cultivation: Likes sunny dry conditions. Can be grown from seed or rotted cuttings. Roman chamomile can be divided.

Usage: Chamomile tea is to be good for digestive complaints and given as a sleep aid to children. Modern uses include hair rinses and soothing skin washes. The herb has anit-bacterial and anti-viral qualities. Used for cut lawns in England.

History: Early gardeners believed that if you had chamomile in your garden then the plants would remain healthy. Bacon's writings describe paths planted in chamomile and there is evidence of mounded

garden benches covered in this herb.

Medicinal Qualities:

German : Until recently chamazulene was thought to be the primary componet of the 120 active chemicals in german chamomile. Now researches belive that the antiinflammatory,antispasmodic,antimircobial,and mildly sedative effects are caused by bisabolo.

Roman: The effects of roman chamolie are the same as the german but with greater dosages. This combined with the allergic reation sometimes caused by this type, it is not as well studied.

Chives (*Allium Schoenoprasum*) is a commonly used flavoring that has a delicate onion like flavor. Chives grow in clumps like very small onions, and are harvested by cutting off a section of the green foliage. Chives also produce flowers that are highly prized in cooking.

Hydroponic Culture: Chives are grown from seed and takes as long as two weeks to germinate. Seeds are placed 1/4" under media and watered with grow nutrient until the plants show signs of flowering. If flowers are desired switch to Bloom nutrient. If green plant is desired keep on the Grow nutrient.

Medicinal uses:

Safeguards health and wards off disease.

Natural antibiotic.

Reduces high blood pressure.

Reduces indigestibility of fats so often used with fatty foods.

Insect repellent:

Chives seem to help protect against aphid attack. They are often planted with roses to increase health and aroma of roses. Often used with cabbages and brassica vegetables to reduce aphid attack.

Chive are relatively fast growing once established, and about 1/4 tub should provide enough chives for most households. However, place a small bunch of chives in all brassica tubs to prevent insect attack. Plant about 5 to 10 seeds per tub.

Trace mineral supplements should be added to the water of the chives to ensure trace minerals. This can be from a mineral supplement from a health food store. Chives may be a source of selenium and so it is recommended in diets to reduce cancer risks.

[Garlic and Lung Cancer](#)

[Planting Chives Information](#)

Garlic Slows Growth of Lung Cancer Cells

A compound in garlic slows the spread of human lung cancer cells, according to researchers in Penn State's College of Health and Human Development. A compound in garlic slows the spread of human lung cancer cells, according to researchers in Penn State's College of Health and Human Development.

Kazuko Sakamoto, a Penn State research associate in nutrition, reported that diallyl trisulfide (DATS), a compound in processed garlic oil, slowed the growth of -- or even killed -- human lung tumor cells grown in culture. Lung cancer is the leading cause of cancer death in the United States.

Sakamoto described her findings at Experimental Biology '96, a meeting of 18 scientific societies.

"We found DATS to be extremely effective in reducing the growth of human lung carcinoma cells in culture," says John Milner, professor and head of Penn State's Department of Nutrition and a co-researcher on the study. The study, funded by the American Institute for Cancer Research, was conducted in Milner's laboratory.

The effectiveness of DATS was comparable to that of 5-fluorouracil, a widely used chemotherapy agent, Milner says. In addition, while DATS was effective against the lung cancer cells, it was considerably less toxic to healthy cells.

"The results have profound implications, both for diet and for drug therapy," Milner says.

The findings are the latest in a growing body of evidence that garlic can suppress human cancer cells, both in laboratory cultures and in test animals.

In the current study, treatment with 10 micrograms of DATS for 24 hours reduced cancer cell growth by 47 percent. A larger dose (50 micrograms) for the same length of time reduced cell growth by 72 percent, and an even more powerful treatment (100 micrograms) killed the cancer cells outright within 24 hours.

In previous studies, Milner and his colleagues reported that two other compounds in garlic -- S-allylcysteine or SAC, and diallyl disulfide or DADS -- have anti-carcinogenic properties as well. They found that SAC interfered with the formation of breast tumor cells in rats, while DADS inhibited the growth of human cancer cells (colon, skin, and lung) grown in lab cultures. The new study is especially promising because it found DATS to be 10 times as effective as DADS.

"Clearly we are learning that there is more than one mechanism by which garlic can reduce cancer," Milner says. "Our studies and others have shown that compounds in garlic can block the initiation phase of cancer as well as the subsequent promotion phase."

DATS and DADS can be found in ordinary clove garlic. They also are found in garlic oil preparations, which are available (usually in capsule form) in many health food stores. Deodorized garlic products, on

the other hand, typically do not contain DATS and DADS, although they do contain SAC.

CHIVES This mild-flavored member of the onion family is often considered more of a herb than a vegetable. The fine-textured foliage is chopped and used in soups, stews, salads, and other recipes. The bulb is small and not usually consumed. Chives are also used as a small ornamental. The plants bear purple flowers early in the year.

Soil Preparation - A rich soil with additional organic matter incorporated before planting is ideal for chives. This plant will tolerate most soil types and has a low nutrient requirement.

Propagation - Small clumps or individual bulbs should be transplanted early in the spring. A small patch (a 1 m or 3 ft row) will be sufficient for the average family. The vegetable does not spread rapidly and seldom becomes a weed. But because it propagates by offshoots, a patch will begin to compete with itself as it spreads. When this happens, the chives will not grow as well. The solution is to renew the patch . Dig up a portion of the patch, thin it out, and transplant it to another area of the garden.

Cultural Requirements - Watering and fertilizing requirements are the same as for all members of the onion family. The plants are fairly shallow-rooted, so frequent watering is suggested, although a reasonable yield can be obtained with minimal watering. Chives generally require little attention.

Harvesting - If you plan to freeze or process the chives, remove all growth about 5 cm (2 in.) above the ground. This should be done only once a year, before mid-July, to allow the bulbs to replenish their food reserves. Alternatively, if you want fresh chives, selectively cut off individual plants. This method can be practiced all season long until frost, with little risk of damage to the plants.

Winter Preparation - About 5 cm (2 in.) of mulch can be placed over the patch in late fall to help prevent winter injury. In most areas this is not required.

WINTER ONIONS This is another common perennial in the onion family. Unlike chives, these onions produce numerous seeds which germinate in the spring. The resulting seedlings are eaten later in the fall or early the next spring. Winter onions produce a much-appreciated green onion early in the year.

The propagation, planting and cultural conditions are the same as for chives and other members of the onion family.

Pests - Onion maggots are a common insect with most onion crops, including the perennial onion. Diazinon applied in the spring is one of the recommended controls.

Harvesting - As noted earlier, seedlings can be eaten in the fall, but are commonly left until the following spring. If picked before flowering, these onions make an excellent green onion for use in soups and salads. The mother plant can be consumed; however, the seedlings are much preferred. The mother plant can be left to provide a continuous source of new seedlings. Like chives, perennial onion plants produce offshoots. Therefore, the patch should be renewed by division every 4 or 5 years to control its growth

NEW ZEALAND SPINACH Although a perennial, this type of spinach will seldom survive prairie winters. A very sheltered location with a good mulch cover is required for winter protection.



Dill (*Anethum graveolens*) can reach about 5 feet in height so it must be given some space in a tub grower. The seeds, stems and leaves of dill are all used for flavoring.

Hydroponic Culture: Place seeds 1/2" under media and water with grow nutrient. Continue to use grow nutrient to keep dill from flowering, or change to bloom to promote flowering. The dill plant may need support from a stake.

When grown from seed it takes about two weeks to germinate. It can also be started from cuttings simply cut from new growth on an existing plant, stripped of its lower leaves and then placed in a tub grower with its lower portion in the nutrient water.

A live dill plant in the eating area is said to increase appetite, so it is a good choice for growing in a dining area. Dill is harvested from growing leaves and it will continue to grow as long as it is harvested. Dill leaves are used in rice, salads, sauces, egg dishes and noodles. The seed is used in pickles, sauerkraut, stew, salad dressings, butter, breads and fish and chicken dishes.

Dill is kept on grow nutrient to reduce the flowering. It should be ready from picking leaves after about 60 days of growth, and a single plant should provide about one spring a day. There is seldom need for a whole tub of Dill, and one plant should provide enough dill.

Medicinal uses:

Used in ancient Babylonia as an astringent, and used to disinfect wounds. Dill is a good preservative and good at fighting bacteria.

It is used to reduce nausea and stomach problems

and gas.

It is a mild diuretic and used for bad breath.

Dill Tea: - a dill tea is made from two to three springs of fresh leaf or 1/4 teaspoon of seeds steeped five minutes in hot water.

Trace mineral supplements should be added to the water of the tarragon plants to ensure trace minerals. This can be from a mineral supplement from a health food store, and we are selling Equinox Master Formula for this purpose. Some of the flavor is apparently due to trace minerals.

[Dill Planting Information](#)

Dill VARIETIES (approximately 65 days)

Boquet, Dukat (highly aromatic), Fernleaf, Mammoth. For trial: Long Island.

SEEDING

Dill seed numbers approximately 14,000 per ounce. Seeds are sown to allow for a final stand of plants 6-10 inches apart in rows 2-3 feet apart. One to two lb of seed are needed per acre if grown for fresh market, and 5-8 lb per acre if grown to be distilled for oil. When grown for distillation, plant population is higher, with approximately 6-10 plants per lineal foot.

For use with dill pickles, seed 1 week earlier than pickling cucumbers.

SOILS AND FERTILIZER

A well-drained sandy soil is best. Fertilizer applications should be based on soil test. The crop should not be over fertilized with nitrogen or it will produce excess leaves and stalk rather than seed. If available, apply barnyard manure at 10 tons/acre early in the spring. Also at, or just before planting, apply:

Nitrogen: 75-100 N lb/acre

Phosphorus: 80-120 (P205) lb/acre

Potassium: 80-120 (K20) lb/acre

Sulfur: 15-20 (S) lb/acre

HARVESTING AND HANDLING

Yields of dill are estimated at about 5,000 lb fresh weight/acre. Dry weight is reported at from 1,000 to 3,000 lb per acre.

When bunching for fresh market, cut or pull stalks and bunch after the majority of seeds have formed but are still green.

If dill is to be distilled for oil, harvest just as plants begin to form seed stalks. Plants are machine harvested into special steel tanks for steam distillation.

For seed, combine when seed has dried to 10% moisture or less.

PACKAGING

Dill is bunched 12-18 plants per bunch for fresh market.

PEST CONTROL FOR DILL

THE PESTICIDES LISTED BELOW, TAKEN FROM THE PACIFIC NORTHWEST PEST CONTROL HANDBOOKS, ARE FOR INFORMATION ONLY, AND ARE REVISED ONLY ANNUALLY. BECAUSE OF CONSTANTLY CHANGING LABELS, LAWS, AND REGULATIONS, OREGON STATE UNIVERSITY CAN ASSUME NO LIABILITY FOR THE CONSEQUENCES OF USE OF CHEMICALS SUGGESTED HERE. IN ALL CASES, READ AND FOLLOW THE DIRECTIONS AND PRECAUTIONARY STATEMENTS ON THE SPECIFIC PESTICIDE PRODUCT LABEL.

USE PESTICIDES SAFELY!

Wear protective clothing and safety devices as recommended on the label. Bathe or shower after each use.

Read the pesticide label--even if you've used the pesticide before. Follow closely the instructions on the label (and any other directions you have).

Be cautious when you apply pesticides. Know your legal responsibility as a pesticide applicator. You may be liable for injury or damage resulting from pesticide use.

WEED CONTROL

The Pacific Northwest Weed Control Handbook has no control entries for this crop. Cultivate as often as necessary when weeds are small. Proper cultivation, field selection and rotations can reduce or eliminate the need for chemical weed control.

INSECT CONTROL

Proper rotations and field selection can minimize problems with insects.

THE PESTICIDES LISTED BELOW ARE TAKEN FROM THE PACIFIC NORTHWEST INSECT CONTROL HANDBOOK, AND ARE FOR INFORMATION ONLY. CONSULT PRODUCT LABELS FOR CURRENTLY LEGAL REGISTRATIONS, RATES AND COMPLETE INSTRUCTIONS.

For aphids, including the carrot aphid (*Cavariella aegopodii*), apply Pyrellin at 1 to 2 pt per acre or M-Pede, 1 to 2% solution (see label), or Neemix 4.5 at 5 to 7 oz product/acre.

Carrot aphids are green plant lice that colonize the heads of dill.

DISEASE CONTROL

Diseases are not generally a problem. The Pacific Northwest Disease Control Handbook has no control entries for this crop.

Proper rotations, field selection, sanitation, spacings, fertilizer and irrigation practices can reduce the risk of many diseases. Fields can be tested for presence of harmful nematodes. Using seed from reputable sources reduces risk from "seed-borne" diseases.

Lavender (*Lavandula officinalis*) flowers and leaves are used for medicinal purposes, and as a flavor for some exotic foods. It is also an excellent plant to use as an insect spray, and is used in clothes to prevent moth attack.

Hydroponic Culture: Lavender can be grown from seed and takes as long as two weeks to germinate. Seeds are placed 1/4" under media and watered with grow nutrient until the plants show signs of flowering. The lavender is then switched to bloom nutrient.

Lavender is slow growing at first and does not produce much blossom per plant, so a full tub of 20 plants is needed to provide enough for daily use. Lavender is planted about 40 seeds per tub. Although a slow grower, it survives well once established.

Medicinal uses:

Antibacterial and antiseptic.

Calming effect.

Used to fight insect infestations such as head lice.

Used in bath to relieve pain of sore muscles.

Lavender Oil:

Fill a glass jar with lavender blossoms and then add olive oil. Place in a sunny place for 4 to 6 weeks.

Lavender sugar:

Mix lavender blossoms and sugar in a jar and mix in more fresh lavender every few days. Crush lavender to increase flavor.

Lavender bath:

Add a cup full of fresh lavender to a bathwater.

Herbal pillow:

Lavender flowers can be dried and stuffed into a pillow for repelling insects.

Live lavender plants:

Live lavender has a wonderful aroma, and is well placed in an area where it will be slightly brushed during the day. The aroma also repels many insects so it makes sense to plant near likely attack.

Mint (*Menthe verdtte*) leaves and springs are used for flavorings and a very popular tea. Good addition to fruit, lamb or pork. Mint sauce can be used for meat, chocolate, and ice cream.

Hydroponic Culture: Peppermint is grown from seed and takes as long as two weeks to germinate. Seeds are placed 1/4" under media and watered with grow nutrient. Continue on Grow nutrient to reduce flowering. It is a perennial and can last for years in tub systems. It grows to 20" to 2 feet, so it can take up about a half tub.

Medicinal uses:

- Used for colds and breathing problems.
- Used with chamomile for a restful sleep.
- Used to reduce nausea or stomach problems.
- Reduces nervousness and stress.
- Helps digest food and increase appetite.
- Used as an antiseptic or to repel insect attack.

Peppermint Tea: Two to three fresh sprigs of fresh leaf in hot water and steeped for five minutes. Often good at the first sign of illness.

Trace mineral supplements should be added to the water of mint to ensure trace minerals.

[Indigestion Remedy](#)

Indigestion (Functional Dyspepsia)

Symptoms referred to the GI system in which a pathological condition is not present, is poorly established, or, if present, does not entirely explain the clinical state.

This is a vague and variable problem that is functional in nature and usually not due to an underlying structural cause. Belching, distension and borborygmus often occur associated with abdominal or epigastric pain. There is often an overt psychological component, but it is too easy to conclude that all indigestion is psycho-somatic. Dietary factors are often crucial. However, the symptom picture may be similar to some presenting signs of cardiac ischaemia, peptic ulceration and Cholecystitis. Thus differential diagnosis is crucial. Any case of 'indigestion' that proves intransigent needs skilled diagnosis.

Actions indicated for the processes behind this disease:

The key to correcting such functional problems is in "tuning up" the fine control of both metabolic and physical aspects of digestion and assimilation. whilst easing the discomfort with appropriate remedies.

Bitter stimulation will promote an integrated and adequate secretory response to food or hunger, as well as increasing muscular tone in peristalsis.

Carminatives will ease flatulence, reduce localized inflammation, muscular spasm leading to colic and act as mild anti-microbials.

Anti-spasmodics may be indicated if the carminatives do not ease abdominal cramping.

Nervines can be used to help stress, anxiety & tension. They are usually also anti-spasmodic.

System Support

The digestive system, but then any part of the body that is a focus for energy usage may be strengthened by using system tonics. Thus may possibly enable the body to integrate the various aspects of digestive functioning more effectively.

Specific Remedies

Every herbalist and every culture have their favorite remedies for indigestion. They are, as would be expected from the above, often **bitter carminatives** or **nervine carminatives**. European 'specifics' include Gentian, Peppermint, Chamomile, Balm. Hops & Valerian. Of course the possibilities can be endless.

One possible prescription

Often the traditional **simple**, or tea made from a single fresh remedy, is best. This should be an herb that the patient likes the taste and aroma of. It ideally should be a plant they could easily cultivate, thus providing a steady supply of fresh leaf. The actions of the herb will give the clue as to which is most therapeutically indicated. Suggestions could include:

Peppermint, Chamomile, Balm

This may be augmented by using a combination of tinctures that aids the digestive system in general through a bitter/carminative approach:

Chamomile

Peppermint

Gentian

Valerian **equal parts of the tincture to 2.5ml taken 10 minutes before eating.**

This approach will provide:

- **carminative** (Peppermint, Chamomile, Lemon Balm)
- **anti-inflammatory** (Peppermint, Chamomile, Lemon Balm)
- **bitter** (Gentian, Chamomile)
- **nervine** (Valerian, Chamomile)

Broader Context of Treatment

Persistent problems call for skilled medical diagnosis. Because of the functional nature of this problem, just about anything that helps the person to be at ease with themselves or help physiological activity will be indicated. Diet is fundamental, but the problem could just about anything. Structural considerations show that therapies from chiropractic to rolfing may potentially help. Counseling about stress related issues or deeper psychological issues will help. Etc. etc.!!

Tarragon (*Artemisia dracunculus*) is a highly flavored herb that grows very well in hydroponic culture. It can be grown from seed, but it takes as long as two weeks to germinate. It can also be started from cuttings simply cut from new growth on an existing plant, stripped of its lower leaves and then placed in a tub grower with its lower portion in the nutrient water.

Hydroponic Culture: Tarragon is harvested from growing stems and it will continue to grow as long as it is harvested. A Tarragon plant can live for over a year. The Tarragon leaves are used in a wide variety of cooking and have medicinal uses as well. Tarragon is also used as a tea.

Tarragon is kept on grow nutrient to reduce the flowering. It should be ready from picking leaves after about 60 days of growth, and a single plant should provide about three springs a day. There is seldom need for a whole tub of Tarragon, and three plants should be more than enough for most kitchens.

Trace mineral supplements should be added to the water of the tarragon plants to ensure trace minerals. This can be from a mineral supplement from a health food store, and we are selling Equinox Master Formula for this purpose. Some of the flavor is apparently due to trace minerals.

Thyme (*Thymus vulgaris*) is a highly flavored herb that grows very well in hydroponic culture. It can be grown from seed, but it takes as long as two weeks to germinate. It can also be started from cuttings simply cut from new growth on an existing plant, stripped of its lower leaves and then placed in a tub grower with its lower portion in the nutrient water.

Hydroponic Culture: Thyme is harvested from growing stems and it will continue to regrow as long as it is harvested. A Thyme plant can live for over a year. The thyme leaves are used in a wide variety of cooking and have medicinal uses as well. Thyme is also used as a tea.

Thyme is kept on grow nutrient to reduce the flowering. It should be ready from picking leaves after about 60 days of growth, and a single plant should provide about three springs a day. There is seldom need for a whole tub of thyme, and three plants should be more than enough for most kitchens.

Trace mineral supplements should be added to the water of the plants as they ripen. This can be from a mineral supplement from a health food store, and we are selling Equinox Master Formula for this purpose. Some of the flavor is apparently due to trace minerals.

Sage (*Salvia officinalis*) is a highly flavored herb that grows very well in hydroponic culture. It can be grown from seed, but it takes as long as two weeks to germinate. It can also be started from cuttings simply cut from new growth on an existing plant, stripped of its lower leaves and then placed in a tub grower with its lower portion in the nutrient water.

Sage is harvested from growing stems and it will continue to regrow as long as it is harvested. A sage plant can live for over a year. The sage leaves are used in a wide variety of cooking and have medicinal uses as well. Sage is also used as a tea.

Hydroponic Culture: Sage is kept on grow nutrient to reduce the flowering. It should be ready from picking leaves after about 60 days of growth, and a single plant should provide about three springs a day. There is seldom need for a whole tub of sage, and three plants should be more than enough for most kitchens.

Cosmetic Uses:

Sage is also used as a hair darkener. A handful of sage is boiled in water for an hour or more, then used on hair as a rinse.

Trace mineral supplements should be added to the water of the sage plants as they grow.

Lettuce leaves are commonly used in salads and sandwiches. They are also part of the filling for tacos, and a wide variety of traditional dishes. There are two basic types of lettuces, head lettuces and cos lettuce.

Head lettuces - in these varieties, the leaves form into a head in the center of the plant. Many of these are difficult to grow in hydroponics, and the excess moisture can cause rot to begin inside the head.

Cos lettuces are characterized by a leafy plant that continues to grow as it is being harvested. Cos lettuces are usually much better in hydroponic culture because the leaves are exposed to air and can remove excess water. Also, most cos lettuces can be harvested by picking outside leaves, and the plant will continue to grow. A cos lettuce can produce eight times as much green leafy vegetable if harvested in this manner rather than removing the whole plant.

Lettuce seeds should be germinated at about 50 seeds per tub, and then thinned by harvesting to about 20 plants as they grow. Leaves should be harvested only when the plants reach about 8" tall.

Trace mineral supplements should be added to the water of the plants as they ripen. This can be from a mineral supplement from a health food store, and we are selling Equinox Master Formula for this purpose. Some of the flavor is apparently due to trace minerals.

Providing some sort of shade may be necessary. This may be as simple as pulling a loose layer of straw over the plant, or setting up a fine mesh netting over the plant. Lettuce need to have steady and rapid growth.

Diseases: Lettuce rot.

Harvest: If you have planted heading lettuce, it does not necessarily have to head up to be harvested. Go ahead and pull up the whole plant and eat it! If you have planted a loose-leaf lettuce harvest the tender outer and lower leaves as they are needed, leaving the plant in the ground to mature more leaves. For maximum crispness, harvest lettuce in the morning after the plant has had the benefit of a cool moist night.

[Hydroponic Parameters - Cornell](#)

[Home Garden Lettuce](#)

POND AREA STAGE

Environmental Set-Points

The environmental parameters during the pond area stage are adjusted to the following set-points:

- Day Temperature - 24° C (75F) (e.g., 08:00 - 18:00 hr)
- Night Temperature - 19° C (65F)
- pH - 5.8
- EC - 1200 microS cm⁻¹
- DO - 4 ppm or greater
- Light - 17 moles/m²d⁻¹
- Nutrient Solution Temperature - 24° C (75° F)
- Relative Humidity - less than 70%

Growing conditions remain at these set-points during the entire pond area growth stage. Day and night temperatures are based on the length of the daylight period.

Head lettuce is the most important salad vegetable grown in the United States. Per-capita consumption exceeds 25 lb annually. Lettuce is adapted to cool growing conditions with the optimum temperatures for growth of 60 to 65⁰F. At 70 to 80⁰F the plants flower and produce seed. Lettuce can tolerate a few days of temperatures from 80 to 85⁰F provided nights are cool.

Lettuce seed will germinate at 35⁰F, but optimum germination is 70 to 75⁰F. If the plants are sufficiently hardened, they will withstand freezing. Repeated exposure to subfreezing temperatures, however, can seriously injure or kill the crop.

Lettuce has a relatively high water requirement. Soil moisture shortage rainfall will seriously stunt growth and head quality. Irrigation greatly reduces risk of crop failure.

There are considerable differences among lettuce varieties in heat tolerance. These differences are the primary reasons some lettuce varieties can be grown in warmer climates.

In North Carolina, the crop can be grown in both the spring and fall in eastern N.C. and even during midsummer in western N.C. at elevations over 3,000 ft. In the Piedmont, lettuce is intermediate in season and probably is best as a late spring and early fall crop.

Romaine has requirements similar to head lettuce except it can stand more heat. Butterhead and leaf types can stand even more heat and have a longer season of production.

Varieties -- Request mosaic-tested (M.T.) seed from your seed supplier.

- **Head:** Strains of Ithaca, Salinas and Pennlake have performed best in N.C.
- **Romaine/Cos:** Romulus or Signal
- **Leaf:** (green) Salad Bowl, Slobolt, Grand Rapids, Green Vision; (red fringe) Red Sails, Royal Red; (red) Ruby.
- **Butterhead:** (loose head) Buttercrunch, Nancy (a.k.a. Boston head), Esmeralda, Ermosa.

Soils and Fertilizers -- Successful production of lettuce depends on vigorous growth. A wide range of well-drained soils can be used; however, the crop does best on fertile, high organic matter soils that have good water-holding capacity.

Adequate nutrients and a continuous moisture supply are essential to vigorous growth. A soil test is the only way of knowing the amount of lime and fertilizer required, and soil samples should be taken well ahead of field preparation. Your county Extension center can advise you in having your soil analyzed.

The pH should be 6.0 to 6.7. If soil potassium and phosphorous level is high, 2 lb per 100 ft² of 10-10-10 should be adequate. At least one-half of the fertilizer should be broadcast and raked in prior to making the rows. Side-place the remainder in either one or two bands 4 inches to the side and 2 inches below the

seeded row. One or more sidedressings of 3 oz of 10-10-10 per 10 ft of row should be made. The first sidedressing should be made soon after plants begin to grow. The decision of whether to apply the second sidedressing will have to be based on the appearance of the crop and the rate at which it is growing.

Spacing -- Choose a row width that complements your tillage equipment. For head lettuce, rows 30 to 42 inches apart are common. Regardless of the row width, the in-row spacing between each head lettuce plant should be 12 inches. If 42-inch rows are used, yield can be increased by planting 2 seed rows per bed. Leaf and butterhead types should be grown in double rows 12 inches apart and 8 to 10 inches in row spacing.

Planting the Crop -- Lettuce can be either transplanted or seeded. The method you choose will depend mostly on availability of transplants and the season in which you will grow the crop. Spring head lettuce often fails because it is planted too late, and for this reason you should consider transplants. Fall crop lettuce is most often started when the climatic conditions are hot and dry. In this period direct seeding would be a good choice provided irrigation is constantly available until the plants are well established.

Plant the seed $\frac{1}{4}$ to $\frac{3}{8}$ inch deep. Be sure the seed is treated with a fungicide to reduce damping-off. About 0.1 oz of seed is needed per 100 ft of row.

When to Plant -- Lettuce is relatively cold-tolerant. Even the seedlings will withstand short periods of freezing temperatures, provided they are reasonably acclimatized. Soft, succulent seedlings can be injured by exposure to freezing. The crop can be transplanted or direct-seeded in late January and early February in eastern N.C. and during late March or early April in the west. The fall crop should be seeded about 80 days before the expected first hard freeze (August 15 to September 1 in the East and July 25 to Aug. 15 in the West).

Growing Transplants -- Lettuce seed for transplants can be sown directly in a coldframe or hotbed, or they can be grown in plastic trays. Growing plants in plastic containers is likely too expensive except for home garden use.

In coldframes, 10 to 12 weeks is required to grow an acceptable transplant, while a heated greenhouse or hotbed requires 4 to 5 weeks. The seeds should be planted in rows 4 to 6 inches apart. Thin the plants to a uniform spacing of 1 to 2 inches. This will produce stocky plants and reduce the chances of damping-off.

You can reduce transplant shock by avoiding too rapid growth during plant production and by hardening the plants. Expose the plants to outside conditions during the last 7 to 10 days before transplanting. The beds should be thoroughly watered the day before transplants are pulled so that minimum root damage will occur. Consult Horticulture Information Leaflet 8104, *Growing Vegetable Transplants for the Home Garden*.

Irrigation -- Irrigate to establish a stand and to keep the crop growing.

Cultivation -- Lettuce is shallow-rooted, and shallow cultivation (1 1/2 inches or less) is all that is necessary. Late cultivation, especially when soil is moved toward the plant, may result in excessive soil in the lower part of the head. Herbicides are available for weed control in lettuce. Check the current *North Carolina Commercial Vegetable Recommendations* (AG-586) for current recommendations.

Insects and Diseases -- Lettuce is attacked by aphids, armyworms, imported cabbage worm, and loopers. The pest pressure on summer and fall crops is much greater than on spring crops.

Damping-off is a serious disease of young seedlings, whereas mildews and sclerotinia are serious on the more mature plants.

Both insects and diseases can be controlled if the correct chemicals are properly applied. Consult your Cooperative Extension agent regarding pest buildup, proper diagnosis, and control.

Harvesting and Packaging -- In most instances, the head lettuce will be ready for harvesting in 70 to 80 days after seeding or 60 to 70 days after transplanting. Cut only those heads that are firm. Leave 3 to 4 wrapper leaves to protect the head. You will have to harvest every 2 to 3 days, depending on moisture and temperature.

Watercress is a form of watercress *Nasturtium officinale*. It is a small green leafy vegetable that grows almost effortlessly in hydroponics. A tub will produce sprigs each day and the greens can be used in sandwiches and salads. There are two basic varieties, watercress and wild watercress.

Watercress seeds should be germinated at about 100 seeds per tub, and then thinned by harvesting as the plants grow. There should be baby leaves by the fifth week and then the tub will support about a cup full of greens a day. The taller stems should be harvested first and the plant should recover each day.

Watercress can easily rot if the overpour water does not drain properly, so when they are about 3" tall, start pouring into the media, no longer over the plants. Also, when the leaves get too tight on top the plant can start to rot within. Harvest leaves in such a way that remaining leaves have some space from other leaves.

Watercress leaves can be used in salads and sandwiches. If you have extra they can also be added to soups and stews. They can also be boiled and served as a vegetable, but this loses some of their food value. They should be picked fresh and eaten within one half hour from being picked to retain full food value.

Cultivated Watercress - *Spinacia spinosa* is a bushy plant made up of dark green ruffled and pointed leaves. Watercress does best in spring and fall seasons and has a tendency to bolt in the hot summer months. Watercress can usually be kept from bolting in the summer by keeping the media moist. Also common Watercress can be replaced by New Zealand Watercress in the hotter seasons and climates.

Wild Watercress - *Tetragonia expansa* creates stems of leaves that can reach two feet long. It does better in the hotter summer season than common Watercress.

Peppercress - is a peppery flavored watercress that is used in gourmet cooking.

Trace mineral supplements should be added to the water of the plants as they ripen. This can be from a mineral supplement from a health food store, and we are selling Equinox Master Formula for this purpose. Some of the flavor is apparently due to trace minerals.

[Watercress Botanical](#)

Watercress Details.

Botanical: Nasturtium officinale

Family: N.O. Cruciferae

- [Description](#)
- [Constituents](#)
- [Medicinal Action and Uses](#)
- [Dosage](#)

---Parts Used---Leaves, flowers, seeds.

---Habitat---Europe and Russian Asia.

---Description---A hardy perennial found in abundance near springs and open running watercourses, of a creeping habit with smooth, shining, brownish-green, pinnatifid leaves and ovate, heart-shaped leaflets, the terminal one being larger than the rest. Flowers small and white, produced towards the extremity of the branches in a sort of terminal panicle.

The true nasturtium or Indian Cress cultivated in gardens as a creeper has brilliant orange-red flowers and produces the seeds which serve as a substitute for capers in pickles.

The poisonous Marshwort or 'Fool's Cress' is often mistaken for Watercress, with which it is sometimes found growing. It may readily be distinguished by its hemlock-like white flowers, and when out of flower, by its finely toothed and somewhat pointed leaves, much longer than those of the watercress and of a paler green. The Latin name 'Nasturtium' is derived from the words *nasus tortus* (a convulsed nose) on account of its pungency.

[\[Top\]](#)

---Constituents---A sulpho-nitrogenous oil, iodine iron, phosphates, potash, with other mineral salts, bitter extract and water. Its volatile oil rich in nitrogen combined with some sulphur in the sulpho-cyanide of allyl.

---Medicinal Action and Uses---Watercress is particularly valuable for its antiscorbutic qualities and has been used as such from the earliest times. As a salad it promotes appetite. Culpepper says that the leaves bruised or the juice will free the face from blotches, spots and blemishes, when applied as a lotion.

---Dosage--- Expressed juice, 1 to 2 fluid ounces.

Watercress has also been used as a specific in tuberculosis. Its active principles are said to be at their best when the plant is in flower.

[\[Top\]](#)

Arugula (*Eruca sativa*) is a green leafy vegetable widely used in gourmet salads. Its strong flavor adds punch to most dishes, but is usually too powerful to be eaten on its own. It is a slower producer than most salad greens and so one tub will provide a few stems a day. The flowers are also used in salads for color and flavor.

Arugula seeds should be germinated at about 100 seeds per tub, and then thinned by harvesting as the plants grow. Leaves should be harvested only when the leaves reach about 8 to 10 inches tall.

[Growing information](#)

Growing Information Arugula (arrugula) is a tangy mustard green, also known as Rocket, Mediterranean Salad, Rucola or Roquette in Europe, also as Gharghir by people in the Middle East. Arugula is now popular as a gourmet salad green.

VARIETIES

Arugula, Rocket, Roquette. For other greens see separate file [Mustard Greens](#). All are quick to mature (approximately 40-50 days).

SOIL

Arugula may be grown on a wide range of soil types. Loose fertile loams, and muck soils are best. Soils should provide good water holding capacity and good internal drainage, and a pH of 6.0-7.0. Since arrugula may be harvested late into the fall, soils should be chosen that allow harvest in moderately rainy conditions.

SEED TREATMENT

Use a fungicide treated seed whenever possible. Have germination checked before planting if germination value is not known or current. Pelletizing seed allows precision planting.

SEEDING

Arugula performs best under cool temperatures and is therefore grown from seed in early spring or late fall (plant as early in the spring as possible). Stagger plantings once or twice per week, planting only what can be harvested, bunched and sold during that interval. Arugula can withstand light frosts.

Transplant only for the earliest crops. Grow transplants about 4 weeks prior to the time they are needed using modular trays, allowing 1 to 1 1/2 square inches per plant.

SPACINGS

Rows should be 12-15 inches apart, with plants 6-9 inches apart in the row. Spacing depends on cultivar and crop being grown. Close spacings cover the ground quickly and reduce risk of soil contamination of the product from rain or irrigation splashing.

FERTILIZER

Nitrogen: 100-125 lb N/acre - split applications not necessary due to quickness of this crop.

Phosphorus: 100-150 (P₂O₅) lb/acre - apply all at time of seeding or transplanting preferably banded 2 inches to the side and 2 inches below the seed or plant roots.

Potassium: 50-150 (K₂O) lb/acre - broadcast prior to planting.

Sulfur: 20-30 (S) lb/acre - broadcast prior to planting.

These recommendations are intended to provide adequate fertilizer. For western Oregon soils. Nitrogen rates especially may need to be adjusted depending on crop planting date, weather conditions and soil type.

IRRIGATION

Arugula requires a uniform supply of water for tender growth. Frequent irrigations are preferred because of shallow rooting. A total of 8-12 inches of water may be necessary depending on seasonal variation, variety and planting date.

Soil type does not affect the amount of total water needed, but does dictate frequency of water application. Lighter soils need more frequent water applications, but less water applied per application.

HARVESTING, HANDLING, AND STORAGE

The University of California-Davis has a file on [Minimal Processing of Fresh Vegetables](#) that discusses film wrapping and other topics.

The crop is generally ready to harvest 6-7 weeks after seeding in the field. Yields are approximately 800-1000 cartons per acre.

Harvest is done by hand. The crop is cut, bunched and packed into cartons in the field, much like spinach. Keep the leafy items clean, and free of soil and mud. Ideally arugula has dark green, somewhat smooth leaves and a spicy taste. A strong taste and toughness develops if harvest is delayed and leaves begin to develop a furry underside. Continuous cutting of the young leaves stimulates further leaf production. If the crop becomes over-mature, the product becomes unmarketable.

Leafy items are extremely perishable and need to be handled delicately, and marketed rapidly. Cool the product quickly. Hydro-cooling or vacuum cooling are preferred. Protect the product from wilting or heating. It may be held temporarily at 32-34 F and 90-95% relative humidity.

PACKAGING

Arugula and other leafy greens are packaged in cartons containing 8-10 lb depending on the item. Consult buyers for preferred packaging, and container sizes.

ARUGULA PEST CONTROL

WEED CONTROL

The Pacific Northwest Weed Control Handbook has no control entries for this crop. Cultivate as often as necessary when weeds are small. Proper cultivation, field selection and rotations can reduce or eliminate the need for chemical weed control.

INSECT CONTROL

The Pacific Northwest Insect Control Handbook has no control entries for this crop. Proper rotations and field selection can minimize problems with insects.

DISEASE CONTROL

The Pacific Northwest Disease Control Handbook has no control entries for this crop. Proper rotations, field selection, sanitation, spacings, fertilizer and irrigation practices can reduce the risk of many diseases. Fields can be tested for presence of harmful nematodes. Using seed from reputable sources reduces risk from "seed-borne" diseases.

MUSTARD VARIETIES FOR GREENS

Brassica juncea and *Brassica rapa* subsp. *perviridis* mustards used for greens are Fordhook Fancy, Green Wave (long standing), Osaka Purple, Florida Broadleaf (most popular variety in the South), Tendergreen II (a smooth, round leaf hybrid), Tendergreen, and Southern Giant Curled (curled type used in processing). Very many other excellent varieties and types are available with different leaf textures and colors. Consult seed catalogues for various conventional and other ethnic types.

OTHER GREENS

Other greens grown and marketed in similar manner (but not necessarily related botanically) are:

Mache or Corn Salad (smooth-leaf types *Valerianella locusta*; hairy-leaf types *Valerianella erocarpa*): Blonde Shell-Leaved, Corn Salad, Large Dutch (all smooth-leaf types).

Sorrel (*Rumex acetosa*), a close relative to rhubarb, also called dock, sour dock, sour grass: Garden Sorrel.

Cress, several species: Curly-cress and Peppergrass (also known as garden cress or land cress) (*Lepidium sativum*); Watercress (*Nasturtium officinale*); Upland Cress (also known as creasy salad or creasy greens) (*Barbarea verna*). For more information, see Upland Cress from North Carolina State University.

Black Mustard (*Brassica nigra*), is less common. It may be used for greens or its seed is used for flavoring pickles or salads.

Mesclun (mescalun, mescaline, mesculine) mix greens: An increasingly popular mix of greens includes **lettuces** such as: Batavian, butterhead, looseleaf, romaine, and miners lettuce mixed with **other greens** such as arugula, chicory, corn salad, dandelion, mache, travissio, kale, tat-soi, chard, endive, escarole, mizuna, mustard tips, radicchio, sorrel, spinach, edible chrysanthemum, nasturtium leaves, orach, parsley, watercress, plantain, and purslane, along with **herbs** such as basils, borage, chervil, chives, fennel, and salad burnet; and **blossoms** of borage, calendula, nasturtium, violas, and violets.

Mechanical harvesters for mixed plantings of salad greens are now available. See Harvesting and Handling section, below.

VARIETIES FOR CONDIMENT MUSTARD

Three types of condiment mustard, yellow (known in Europe as white), brown and Oriental are grown in the U.S.A. The most common, about 90% of the crop, is yellow (*Brassica hirta*). A number of varieties and proprietary selections exist.

Tilney is used to make the standard yellow mustards to flavor American hot dogs. Other varieties such as Trico, White Mustard, Yellow/White Mustard, Ochre Kirby and Gisilba are also widely used to make yellow or white mustards with varying degrees of pungency and color.

Brown and Oriental mustards are *Brassica juncea*. Varieties of brown mustard such as Common Brown, Blaze, and Forge, are brown mustards whose seed is used in hot, stone-ground and "French"-style mustard. Oriental mustard varieties are Lethbridge 22-A and Domo. Seed coat color of these varieties differ. Common Brown has a distinctive brown seed coat while Forge, and Lethbridge 22-A have tan seedcoats or mixtures of tan and brown. Other varieties reported are Cutlass, French Brown and Burgogne.

Much of the condiment mustard seed used in the U.S. is imported from the prairie provinces of Canada. U.S. production is mainly in North Dakota. Mustards are considered an excellent rotation for wheat. Other production guidelines are outlined in the various sections below.

For more information on condiment mustards see: The Mustard Book by Jan Roberts-Dominguez. Macmillan Publishing Co. 1993.

SOIL

Important

Before planting Crucifer crops, consider the following important factors:

1. No crucifer crop, or related weed has been present in the field for at least 3 years, 4 years preferable. Crucifer crops include cabbage, cauliflower, broccoli, kale, kohlrabi, Brussels sprouts, Chinese cabbage, all mustards, turnips, rutabagas, radishes etc. Cruciferous weeds include wild radish, wild mustards etc. Also, crucifer plant waste should not have been dumped on these fields. This is no minimize problems from diseases such as Rhizoctonia and Fusarium root rots and Sclerotinia stem rot and white mold.
2. Soil pH should be 6.5 or higher. Soil pH over 6.8 is necessary to manage club root. The application of 1500 lb/acre of hydrated lime, 6 weeks prior to planting is recommended for soils with pH less than 7.5 for club root control.
3. Arrange to keep transplanted and direct-seeded fields separate to minimize spread of certain diseases that are more prevalent in transplanted fields.

Mustard greens may be grown on a variety of soils but it does best on a well-drained, loam soil well supplied with organic matter. Sandy loams are preferred for early crops. Adjust soil pH to 6.0 - 6.8 for maximum yields.

Condiment mustards, which are generally not irrigated, should be planted on soils with good water-holding capacity without being water-logged, and at locations which have a high probability of spring rains to avoid

risk of moisture stress.

Mustards germinate quickly when soils reach 45 F or warmer.

SEEDING

Use certified, or hot-water treated seed and fungicide treat seed to protect against several serious seed-borne diseases. Hot water seed treatments are very specific (122 F exactly, for 25 to 30 minutes; the wet seed then quickly cooled and dried). The seed treatments are best done by the seed company, and can usually be provided upon request.

Mustards seeds of the species *B. juncea* (brown mustard) number approximately 250,000 per pound, while those of *B. rapa perviridis* (spinach mustard) number about 240,000 per pound. Use only fungicide and hot water treated seed to insure good stands and to minimize certain seed-borne diseases.

Mustard greens: Approximately 3 to 4 lb of seed per acre are used, depending on variety and use. A common problem is planting too thick a stand. Spacing may be 4-6 inches in the row and 1 to 2 feet between rows.

If seeding for spring crop, seed as early as possible for the variety being used. For a fall crop, seed from early July through August. Plantings should be made at 1 to 3 week intervals depending on variety and use. Harvest date is approximately 50 days from seeding.

Mustard and turnip greens will maintain good quality for about 3 weeks. Collard greens can be harvested repeatedly for two to three months

Condiment mustard is usually spring planted as early as possible for the variety being used (generally March or April). Five to 7 pounds of seed are generally used per acre when planting with grain drills. Plant 1/2 to 1 inch deep for rapid emergence.

Large seed, an important quality factor in brown mustard, is influenced by growing conditions and plant populations. Choose the lowest plant populations commensurate with suitable yields, and moisture conditions should not be limiting for best seed quality.

SPACINGS

Greens may be planted in beds 70 to 80 inches wide accomodating 4 to 6 multiple rows per bed, or in single or double rows (double rows spaced 10 to 20 inches apart).

Condiment mustard is planted at spacings of 6-8 inches between rows. This spacing allows for early row closure which minimizes weed problems and allows for high seed yields.

FERTILIZER

The following are general recommendations only. It is advisable to use a soil test for each field that is to be planted. More complete fertilizer and liming recommendations for mustards and other cole crops may be found in *Broccoli*.

Nitrogen: 100-120 (N) lb/acre. Sidedress one half the N at planting, and one half at 25 days.

With condiment mustard produced in eastern Oregon, and based on information from Idaho, use 50-75 lb N/acre following green manure; OR 75-95 lb/acre on fallow ground; OR 100-135 lb/acre following wheat if the residue was removed; OR 140-150 lb/acre following grain where residue was plowed down.

Apply all P and K at planting:

Phosphorus: 80-120 (P₂O₅) lb/acre

Potassium: 60-120 (K₂O) lb/acre

Sulfur: 20-25 lb S/acre. Sulfur influences pungency of condiment mustard seed.

Boron: 1-2 lb B/acre, broadcast only. Do not band boron.

IRRIGATION

Maintain uniform soil moisture for tender growth and optimum nutrient availability. Soil type does not affect the amount of total water needed, but does dictate frequency of water application. Lighter soils need more frequent water applications, but less water applied per application.

HARVESTING, HANDLING, AND STORAGE

The University of California-Davis has a file on Minimal Processing of Fresh Vegetables that discusses film wrapping and other topics.

Yields of mustard greens for fresh market are approximately 150 cwt/acre.

Mustard greens are usually harvested by machine for processing and hand harvested for fresh market. If mustard greens are harvested for fresh market, it is necessary to remove any diseased or badly damaged leaves, and wash and cool the product as soon after harvest as possible.

Specialty leaf lettuces, spinach, and mustards for bag mixes have usually been harvested by hand, but

harvesters for this use are now available. Three are:

- Green Crop Harvester, made in England. Sole US distributors are C. and K. Anderson, Fresh Herb Co., 4114 Oxford Rd., Longmont, CO. The cost is \$20,000 (1998 prices) for a 4-foot wide model which hold the greens upright by chain-driven sweeps and cuts the greens with a reciprocating knife (like a hedge trimmer). A picture of the machine can be seen in Johnny's Select Seeds 1998 catalogue, page 87.
- Quick Cut harvester, an Italian, battery-powered, walk-behind machine with a 39", 48" or 54"-wide head and a band-saw cutter. Cost is \$11,000. Sold by Ferrari Tractor CIE, PO Box 1045, Gridley, CA 95948; and by David Washburn and Meg Anderson of Red Cardinal Farm, 9694 75th St. North, Stillwater, MN 55082.
- Enha Pro, a human-powered machine designed by Norbert Hufnagl, Field of Dreams, 117 Fredon Springdale Rd., Newton, NJ 07860. Cost is \$2,429 for a two-head unit and \$2,966 for a three-head unit.

Storage is not recommended, but if necessary the leaves may be held for up to 3 weeks at 32 F with 90-95% relative humidity.

Mustard seed used for condiment mustard is harvested by combining after the seed pods are dry, and seed has reached about 12-15 % moisture but before the pods begin to split. Seed must be further cleaned and packaged or stored in bulk for processing.

PACKAGING

Mustard greens are commonly packaged in 23 to 24-lb bushel baskets, crates, and cartons, 24 packages each; 30 to 35-lb (1.4 bushel and 1.6 bushel) wirebound crates; or, crates and cartons, 12-24 bunches.

PEST CONTROL FOR MUSTARD

THE PESTICIDES LISTED BELOW, TAKEN FROM THE PACIFIC NORTHWEST PEST CONTROL HANDBOOKS, ARE FOR INFORMATION ONLY, AND ARE REVISED ONLY ANNUALLY. BECAUSE OF CONSTANTLY CHANGING LABELS, LAWS, AND REGULATIONS, OREGON STATE UNIVERSITY CAN ASSUME NO LIABILITY FOR THE CONSEQUENCES OF USE OF CHEMICALS SUGGESTED HERE. IN ALL CASES, READ AND FOLLOW THE DIRECTIONS AND PRECAUTIONARY STATEMENTS ON THE SPECIFIC PESTICIDE PRODUCT LABEL.

USE PESTICIDES SAFELY!

Wear protective clothing and safety devices as recommended on the label. Bathe or shower after each use.

Read the pesticide label--even if you've used the pesticide before. Follow closely the instructions on the

label (and any other directions you have).

Be cautious when you apply pesticides. Know your legal responsibility as a pesticide applicator. You may be liable for injury or damage resulting from pesticide use.

Crucifer (Cole Crop) Weed Control

INSECT CONTROL

Proper rotations and field selection can minimize problems with insects.

Insect and Description	Control, Active Ingredient/Acre
Aphids, including Cabbage aphid <i>Brevicoryne brassicae</i>	malathion - 1.25 lb
Turnip aphid <i>Hyadaphis pseudobrassicae</i>	dimethoate - 0.25 lb
Both species closely resemble each other. Gray, mealy plant lice that form colonies on foliage.	endosulfan - 0.75 lb
	Pyrellin - 1 to 2 pt
	diatect - 1 to 3 lb formulation
	diazinon - 0.5 lb
	Provado 1.6 F - 3.75 fl oz product
	Admire 2F - 0.15 to 0.38 lb
	M-Pede, 1-2% solution, see label
Cabbage maggot <i>Delia brassicae</i>	Diazinon and other materials are available, consult labels for rates and proper use.
White, legless maggots that feed on roots, causing flagging and death. Adult is a small, gray fly that lays white, oblong eggs at bases of plants.	
Cucumber beetles <i>Diabrotica</i> species	cypermethrin - 0.05 to 0.10 lb

Yellowish-green, black-spotted beetles common to western Oregon. Adults feed on seedlings and foliage.

Cutworms (several species)	cypermethrin - 0.05 to 0.10 lb
-------------------------------	--------------------------------

Diamondback moth <i>Plutella xylostella</i>	malathion - 1.25 lb
Gray or brown moths that have white margins on forewings. When folded, the markings form a white diamond. Worms are pale, yellowish-green with finely scattered, erect black hairs.	Bacillus thuringiensis. See label for rate. Use a spreader-sticker to enhance control.
	Lannate - 0.45 to 0.9 lb
	diatect - 1 to 3 lb formulation
	Matth - see label
	MVP - 2 to 4 qt
	Success - 0.02 to 0.06 lb

Flea beetles, including Cabbage flea beetle <i>Phyllotreta cruciferae</i>	carbaryl - 1 lb
Small, shiny, steel-blue jumping beetle. Frequently attacks young plants and requires control measures.	malathion - 1.25 lb
	endosulfan - 0.75 lb
	cypermethrin - 0.05 to 0.10 lb

Imported cabbage worm <i>Pieris rapae</i>	malathion - 1.25 lb
Adult is white butterfly with black spots. Caterpillar is soft, velvety green with a faint yellow stripe on middle of back and a row of yellow stripes on each side.	Bacillus thuringiensis, see label for rates. Use a spreader-sticker to enhance control.
	endosulfan - 0.75 lb
	carbaryl - 2 lb
	Lannate - 0.45 to 0.9 lb

diatect - 1 to 3 lb formulation

Pyrellin - 1 to 2 pt

diazinon - 0.5 lb

Mattch - see label

MVP - 2 to 4 qt

Success - 0.05 to 0.09 lb

Confirm 2F - 0.09 to 0.12 lb

cypermethrin - 0.05 to 0.10 lb

Wireworms

Limoniuss spp.

Telone II - preplant

Brown, jointed larvae of
click beetles.

Telone C-17 or C-35 - preplant

DISEASE CONTROL

The Pacific Northwest Disease Control Handbook has no control entries for this crop. Proper rotations, field selection, sanitation, spacings, fertilizer and irrigation practices can reduce the risk of many diseases. Fields can be tested for presence of harmful nematodes. Using seed from reputable sources reduces risk from "seed-borne" diseases.

Fungicides registered for use on mustard, but not evaluated by University personnel in the Pacific Northwest, include Aliette, Microthiol Special, Telone, and Terraclor. Check labels for rates, restrictions, and diseases controlled.

POSTHARVEST HANDLING SYSTEMS: MINIMALLY PROCESSED FRUITS AND VEGETABLES

"Minimally processed" horticultural products are prepared and handled to maintain their fresh nature while providing convenience to the user. Producing minimally processed products involves cleaning, washing, trimming, coring, slicing, shredding, and so on. Other terms used to refer to minimally processed products are "lightly processed," "partially processed," "freshprocessed," and "preprepared."

Minimally processed fruits and vegetables include peeled and sliced potatoes; shredded lettuce and cabbage; washed and trimmed spinach; chilled peach, mango, melon, and other fruit slices; vegetable snacks, such as carrot and celery sticks, and cauliflower and broccoli florets; packaged mixed salads; cleaned and diced onions; peeled and cored pineapple; fresh sauces; peeled citrus fruits; and microwaveable fresh vegetable trays.

Whereas most food processing techniques stabilize the products and lengthen their storage and shelf life, light processing of fruits and vegetables increases their perishability. Because of this and the need for increased sanitation, preparation and handling of these products require knowledge of food science and technology and postharvest physiology.

Growth in demand has led to increased marketing of fresh horticultural products in lightly processed form. An industry dedicated to this type of food processing has been established, and the National Association of Fresh Produce Processors was recently formed.

Physiological Responses

Minimal processing generally increases the rates of metabolic processes that cause deterioration of fresh products. The physical damage or wounding caused by preparation increases respiration and ethylene production within minutes, and associated increases occur in rates of other biochemical reactions responsible for changes in color (including browning), flavor, texture, and nutritional quality (such as vitamin loss). The greater the degree of processing, the greater the wounding response. Control of the wound response is the key to providing a processed product of good quality. The impact of bruising and wounding can be reduced by cooling the product before processing. Strict temperature control after processing is also critical in reducing wound-induced metabolic activity, as shown in the respiration data of intact and shredded cabbage stored at different temperatures. Other techniques that substantially reduce damage include use of sharp knives, maintenance of stringent sanitary conditions, and efficient washing and drying (removal of surface moisture) of the cut product.

Microbiological Concerns

Fruits and vegetables are ecological niches for a diverse and changing microflora, which usually does not include types pathogenic to humans. Intact fruits and vegetables are safe to eat partly because the surface peel is an effective physical and chemical barrier to most microorganisms. In addition, if the peel is damaged, the acidity of the pulp prevents the growth of organisms, other than the acidtolerant fungi and bacteria that are the spoilage organisms usually associated with decay. On vegetables, the microflora is dominated by soil organisms. The normal spoilage flora, including the bacteria *Erwinia* and *Pseudomonas*, usually have a competitive advantage over other organisms that could potentially be harmful to humans.

Changes in the environmental conditions surrounding a product can result in significant changes in the microflora. The risk of pathogenic bacteria may increase with film packaging (high relative humidity and low oxygen conditions), with packaging of products of low salt content and high cellular pH and with storage of packaged products at too high temperatures ($>5^{\circ}\text{C}$ or 41°F). Food pathogens such as *Clostridium*, *Yersinia*, and *Listeria* can potentially develop on minimally processed fruits and vegetables under such conditions.

With minimally processed products, the increase in cutdamaged surfaces and availability of cell nutrients provides conditions that increase the numbers and types of microbes that develop. Furthermore the increased handling of the products provides greater opportunity for contamination by pathogenic organisms.

Microbial growth on minimally processed products is controlled principally by good sanitation and temperature management. Sanitation of all equipment and use of chlorinated water are standard approaches. Low temperature during and after processing generally retards microbial growth but may select for psychrotropic organisms such as Pseudomonads. Moisture increases microbial growth, therefore removal of wash and cleaning water by centrifugation or other methods is critical. Low humidity reduces bacterial growth, although it also leads to drying (wilting and shriveling) of the product. Low oxygen and elevated carbon dioxide levels, often in conjunction with carbon monoxide, retard microbial growth. Plastic film packaging materials modify the humidity and atmosphere composition surrounding processed products and therefore may modify the microbial profile.

Product Preparation

Minimal processing may occur in a "direct chain" of preparation and handling in which the product is processed, distributed, and then marketed or utilized. Many products are also handled in an "interrupted chain" in which the product may be stored before or after processing or may be processed to different degrees at different locations. Because of this variation in time and point of processing, it would be useful to be able to evaluate the quality of the raw material and predict the shelf life of the processed product.

Minimally processed products may be prepared at the source of production or at regional and local processors. Whether a product may be processed at source or locally depends on the perishability of the

processed form relative to the intact form, and on the quality required for the designated use of the product. Processing has shifted from destination (local) to source processors as improvements in equipment, modified atmosphere packaging, and temperature management have become available.

In the past, processed lettuce operations often salvaged lettuce remaining in the fields after harvesting for fresh market. It is now recognized that first-cut lettuce should be used for maximum processed product quality. After trimming and coring, piece size may be reduced with rotating knives or by tearing into salad-size pieces. Damage to cells near cut surfaces influences the shelf life and quality of the product. For example, shredded lettuce cut by a sharp knife with a slicing motion has a storage life approximately twice that of lettuce cut with a chopping action. Shelf life of lettuce is less if a dull knife is used rather than a sharp knife.

Washing the cut product removes sugar and other nutrients at the cut surfaces that favor microbial growth and tissue discoloration. Because of differences in composition and release of nutrients with processing, some products such as cabbage are known as "dirty" products. It is desirable to maintain separate processing lines, or thoroughly clean the line before another product follows cabbage. Free moisture must be completely removed after washing. Centrifugation is generally used, although vibration screens and air blasts can also be used. The process should remove at least the same amount of moisture that the product retained during processing. It has been shown that removal of slightly more moisture (i.e., slight desiccation of the product) favors longer postprocessing life.

Packaging, Modified Atmospheres, and Handling

Polyvinylchloride (PVC), used primarily for overwrapping, and polypropylene (PP) and polyethylene (PE), used for bags, are the films most widely used for packaging minimally processed products. Multilayered films, often with ethylene vinyl acetate (EVA), can be manufactured with differing gas transmission rates. For lettuce processed at source, a 2.5 mil 8 percent EVA co-extruded PE bag has been used. Products are often packaged under partial vacuum or after flushing with different mixtures of gases (oxygen, carbon dioxide, carbon monoxide, and/or nitrogen). Vacuum packaging and gas flushing establish the modified atmosphere quickly and increase the shelf life and quality of processed products. For example, browning of cut lettuce occurs, before a beneficial atmosphere is established by the product's respiration. For other products, such as fast-respiring broccoli florets, impermeable barrier films are used with permeable membrane "patches" to modify the atmosphere through the product's respiration. It is not yet agreed what are the ideal films and atmospheres for minimally processed products. In addition to different atmosphere requirements for different products, the specifics of the handling chains must be taken into account, especially their time delays and temperature fluctuations.

The modified atmospheres that best maintain the quality and storage life of minimally processed products have an oxygen range of 2 to 8 percent and carbon dioxide concentrations of 5 to 15 percent.

Carbon monoxide concentrations of 5 to 10 percent under low oxygen (<5 percent) conditions retard browning and reduce microbial growth, lengthening shelf life in lettuce and other products. With some

nonpermeable barrier-type PE films, an elevated oxygen level (25 to 50 percent) is used with carbon monoxide (3 to 10 percent) to maintain aerobic respiration during the handling period.

The following factors are known to be critical to maintaining quality and shelf life in minimally processed products: using the highest quality raw product, reducing mechanical damage before processing reducing piece size by tearing or by slicing with sharp knives, rinsing cut surfaces to remove released cellular nutrients and kill microorganisms, centrifugation to the point of complete water removal or even slight desiccation, packaging under a slight vacuum with some addition of CO to retard discoloration, and maintaining product temperature at 1° to 2°C (34° to 36°F) during storage and handling. Temperature maintenance is currently recognized as the most deficient factor.

Other techniques such as irradiation, chemical preservation (dips in ascorbic acid, calcium chloride, and/or citric acid), modification of pH, and reduction of water activity (with sugars/salts) may also control deterioration of processed products, mainly by controlling microbial growth.

Quality of Minimally Processed Products

The nature of the demand for minimally processed products requires that they be visually acceptable and appealing. The products must have a fresh appearance, be of consistent quality throughout the package, and be reasonably free of defects. Field defects such as tipburn on lettuce can reduce the quality of the processed product because the brown tissue is distributed throughout the packaged product.

In mixed salads, the quality of the total product is only as good as that of the most perishable component. This also applies to cleaned and washed spinach and other products where differences in leaf age or physical damage to leaves may yield a product of nonuniform perishability.

Quality assurance programs, long regarded as essential in the processed food industry, are difficult to apply to horticultural crops and the corresponding minimally processed products. Fresh horticultural products have not yet been subjected to the same sanitation, labeling, and shelflife requirements as other processed foods.



Mustard leaves are raised for use as a boiled vegetable dish. Mustard grows very well in hydroponics and a tub will supply two to three leaves per day. They can be used in salads or sandwiches or in soups and stews. The mustard greens have a rich flavor and are a widely accepted vegetable.

Mustard greens makes a great substitute for spinach and chard because the leaves do not accumulate oxalic acid. Therefore they do not rob the body of minerals.

Mustard seeds should be germinated at about 50 seeds per tub, and then thinned by harvesting to about 20 plants as they grow. Leaves should be harvested only when the plants reach about 8" tall.

Mustard or mustard greens is a cool weather plant that is generally grown for its tasty leaves by the home gardener. Hot weather tends to make the plant bolt and go to seed. The seed is what the commercial grower is after. This is what makes the condiment table mustard.

Diseases:Black rot.

Harvest:Mustard can be harvested several ways. Pick the larger mature leaves, leaving the smaller leaves to mature; pull up the entire plant; or cut the leaves down near the crown, allowing the plant to produce a second crop.



Spinach is a green leaf vegetable that is used fresh in salads or boiled and served as a vegetable. While spinach has a reputation for being excellent for health, it can be a mineral robber in the diet. This is because spinach can store calcium in its vacuoles (storage areas) in the form of oxalic acid. While this would appear to be a good thing, we all need calcium, the oxalic acid cannot be digested and actually robs the body of minerals already there.

The oxalic acid issue means that spinach should be eaten occasionally, or replaced by a more nutritious green such as quinoa leaves. Mustard greens and turnip greens are also good alternatives.

Spinach seeds should be germinated at about 100 seeds per tub, and then thinned by harvesting as the plants grow. There should be baby leaves by the third or fourth week and then the tub will support four to five leaves a day for the next month or so. The outer leaves should be harvested first for those plants you reserve for continued growth.

The Spinach leaves can easily rot if the overpoured water does not drain properly, so when they are about 3" tall, start pouring into the media, no longer over the plants. Also, when the leaves get too tight on top the plant can start to rot within. Harvest leaves in such a way that remaining leaves have some space from other leaves.

Spinach leaves can be used in salads and sandwiches. If you have extra they can also be added to soups and stews. They can also be boiled and served as a vegetable, but this loses some of their food value. They should be picked fresh and eaten within one half hour from being picked to retain full food value.

Common spinach - *Spinacia spinosa* is a bushy plant made up of dark green ruffled and pointed leaves. Spinach does best in spring and fall seasons and has a tendency to bolt in the hot summer months. Spinach can usually be kept from bolting in the summer by keeping the media moist. Also common spinach can be replaced by New Zealand Spinach in the hotter seasons and climates.

New Zealand Spinach - *Tetragonia expansa* creates stems of leaves that can reach two feet long. It does better in the hotter summer season than common spinach. New Zealand Spinach is not a true spinach, but is used in recipes in the same way.

Both spinach prefer a pH level from 6.0 to 7.0.

Diseases: Blight and Downy mildew.

Harvest: Leaves can be harvested, leaving the plant in the ground to put on new growth.

[Botanical information](#)

Spinach

Family: N.O. Chenopodiaceae

- [Constituents](#)
- [Cultivation](#)

---Part Used---Leaves.

---Habitat---The Spinach is an annual plant, long cultivated for the sake of its succulent leaves, a native of Asia, probably of Persian origin, being introduced into Europe about the fifteenth century.

---Constituents---Spinach is relatively rich in nitrogenous substances, in hydrocarbons, and in iron sesqui-oxide, which last amounts to 3.3 per cent of the total ash. It is thus more nourishing than other green vegetables. It is a valuable part of the diet in anaemia, not only on account of its iron, but also for its chlorophyll. Chlorophyll is known to have a chemical formula remarkably similar to that of haemoglobin, and it is stated that the ingestion of chlorophyll will raise the haemoglobin of the blood without increasing the formed elements. The plant contains from 10 to 20 parts per 1,000 by weight of chlorophyll. During the war, wine fortified with Spinach juice 1 in 50) was given to French soldiers weakened by haemorrhage.

According to Chick and Roscoe (*Biochem. Journal*, 1926, XX, 137), fresh leaves of Spinach are a rich source of vitamin A, a small daily ration (0.1 gram and upward) encouraging growth and lessening or preventing xerophthalmia in young rats on diets devoid of fat-soluble vitamins. Spinach grown in the open in winter, spring or autumn possesses no antirachitic properties that can be demonstrated by the methods employed. Spinach leaves when irradiated with ultraviolet rays from a Hg vapour quartz lamp become powerfully antirachitic.

Boas (*Biochem. Journal*, 1926, XX, 153) found that the fresh leaves of winter-grown Spinach added to an experimental diet caused an even greater improvement in the wellbeing of rats and in the rate of growth than was caused by the addition of cod-liver oil. The weight of the skeleton was not, however, proportionally increased. The conclusion was drawn by Boas that winter Spinach contains an amount of vitamin D which isnegligible compared with its content of vitamin A.

The leaves contain a large proportion of saltpetre. The water drained from Spinach, after cooking, is capable of making as good match-paper as that made by a solution of nitre.

[\[Top\]](#)

---Cultivation---Spinach should be grown on good ground, well worked and well manured, and for the summer crops abundant water will be necessary.

To afford a succession of Summer Spinach, the seeds should be sown about the middle of February and again in March. After this period, small quantities should be sown once a fortnight, as Summer Spinach lasts a very short time. The seeds are generally sown in shallow drills, between the lines of peas. If occupying the whole of a plot, the rows should be 1 foot apart.

The Round-seeded is the best kind for summer use.

The Prickly-seeded and the Flanders kinds are the best for winter and should be thinned out early in the autumn to about 2 inches apart, and later on to 6 inches. The Lettuceleaved is a good succulent winter variety but not quite so hardy.

The first sowing of Winter Spinach should be made early in August and again towards the end of that month, in some sheltered but not shaded situation, in rows 18 inches apart, the plants as they advance being thinned and the ground hoed. By the beginning of winter, the outer leaves will have become fit for use, and if the weather is mild successive gatherings may be obtained up to the beginning of May.

[\[Top\]](#)

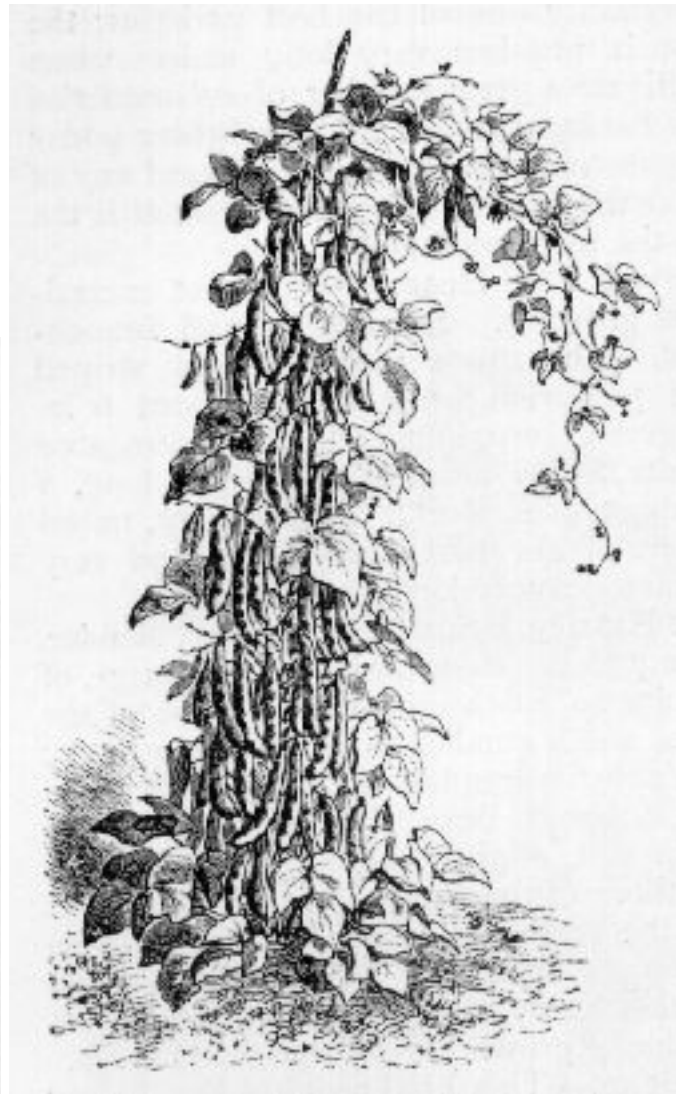
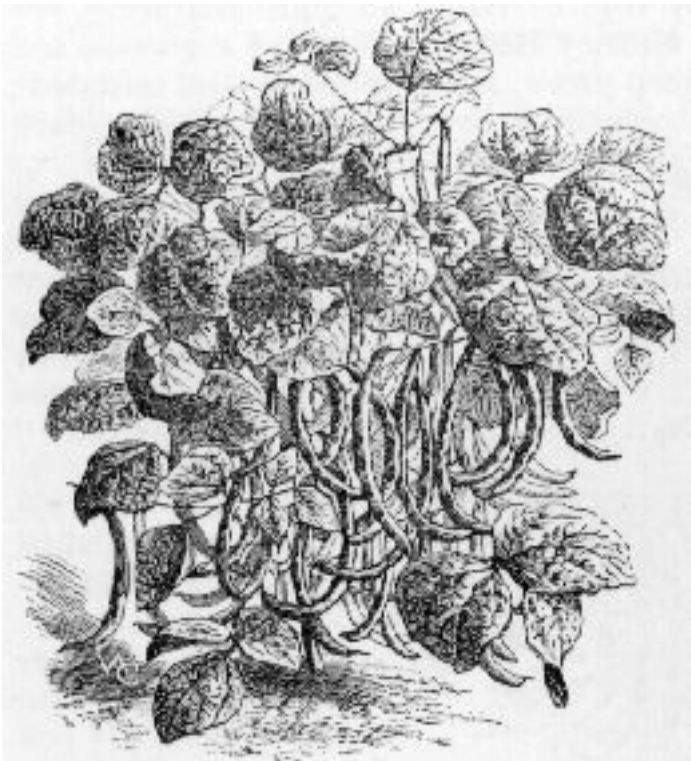

Beans are a very important part of the hydroponic diet. Once bean plants are established, they can continue to produce beans indefinitely. The bean plants will stop producing beans if some pods are allowed to fully mature. Then the plant "sees" its reproductive mission accomplished and dies. So it is important to make sure to pick beans before they are matured, or then allow them all to mature and then pick.

Beans can be picked green in the pod and eaten as a vegetable, or allowed to mature and harvested for their bean seeds which can be dried and stored.

For tub systems runner beans or beans that vine, are more suitable for long culture. If you harvest beans every day, there will be a heavier harvest.

Beans are planted under about 1" of media, and usually germinate in four to five days. In about three weeks they will need some sort of support to vine up to the top of the support. They grow best in pH from 6.0 to 6.5. They are planted 16 plants per tub, and then thinned to 8 per tub when 6" high. They are also switched to bloom nutrient at this time.

Bean productivity is almost unbelievable in hydroponic tubs. It is not unusual to pick an ounce of bean pods from a tub every day. This productivity will slow down in the winter due to day length and so a winter variety may be more suitable, or switch to pea pods.

Several beans are suggested for hydroponic culture. Most will taste similar in the pod stage, but have different flavors in the bean stage.

Beans have a special node module bacteria that can provide nitrogen for the plant if they colonize the roots. These nodule bacteria will not necessarily be in the hydroponic media and it may pay to inoculate the system with the bacteria. Once the bacteria is established they will reduce the need for nitrogen so the plant must be on low nitrogen nutrient such as Bloom in order to ensure flowering.

Trace mineral supplements should be added to the water of the bean plants as they ripen.

[Growing Beans and Peas](#)

Peas are a very important part of the hydroponic diet. Once pea plants are established, they can continue to produce peas indefinitely. The pea plants will stop producing peas if some pods are allowed to fully mature. Then the plant "sees" its reproductive mission accomplished and dies. So it is important to make sure to pick peas before they are matured, or then allow them all to mature and then pick.

Peas can be picked green in the pod and eaten as a vegetable, or allowed to mature and harvested for their pea seeds which can be dried and stored.

For tub systems peas that vine are more suitable for long culture. If you harvest peas every day, there will be a heavier harvest.

Peas are planted under about 1" of media, and usually germinate in four to five days. In about three weeks they will need some sort of support to vine up to the top of the support. They grow best in pH from 6.0 to 6.5. They are planted 16 plants per tub, and then thinned to 8 per tub when 6" high. They are also switched to bloom nutrient at this time.

Pea productivity is almost unbelievable in hydroponic tubs. It is not unusual to pick 1/4 to 1/2 pound of pea pods from a tub every day. This productivity will slow down in the winter due to day length and so a winter variety may be more suitable.

Several peas are suggested for hydroponic culture. Most will taste similar in the pod stage, but have different flavors in the pea stage.

Peas have a special node module bacteria that can provide nitrogen for the plant if they colonize the roots. These nodule bacteria will not necessarily be in the hydroponic media and it may pay to inoculate the system with the bacteria. Once the bacteria is established they will reduce the need for nitrogen so the plant must be on low nitrogen nutrient such as Bloom in order to ensure flowering.

Trace mineral supplements should be added to the water of the pea plants as they ripen. This can be from a mineral supplement from a health food store, and we are selling Equinox Master Formula for this purpose. Some of the flavor is apparently due to trace minerals.

[Growing peas](#)

[Types of Peas](#)

Go to: | [Seeding](#) | [Fertilizers](#) | [Harvesting, Handling, Storage](#) |

Peas in western Oregon are grown in the Willamette Valley. Production may be irrigated or non-irrigated. The non-irrigated production area is generally in the Cascade foothills around Silverton.

Although peas have been grown in western Oregon for canning, due to market conditions and processor requirements, all peas in western Oregon are now grown for freezing. Freezing and canning varieties differ in a number of characteristics. In general, freezers are darker green due to the presence of green color in the seed coat. Raw seed may either be wrinkled (freezers) or smooth (canners). Varieties may be also classified by sieve size, with small-sieve peas being important for freezing and becoming more popular in general. The development of dual-purpose varieties are making these distinctions less important.

More recently, modified-leaf varieties have become available. The afile type is a semi-leafless mutant where the leaflets have been converted to tendrils. Stipule leaves are still present. This plant habit makes possible an open plant structure that favors good aeration, a better growth habit, better light penetration, and improved color. A uniform, intense green color is especially important in freezer peas. The upright plant habit also improves harvest recovery and efficiency.

Scheduling plantings for orderly harvest is accomplished by the use of the accumulated heat unit (AHU) system. This is defined as the accumulated difference between the base temperature for crop growth and the mean of the daily maximum and minimum air temperatures. The AHU system information combined with selection of appropriate early and main season varieties, and with field selection based on elevation has been effective in pea production scheduling. Using a 40 F base, early varieties currently used require 1200 to 1300 heat units, mid-season varieties 1400 to 1500 heat units and late varieties 1600 to 1700 heat units to reach a 100 tenderometer maturity in the Willamette Valley.

VARIETIES

Processing: Processors will specify varieties for each planting period.

Some varieties grown in western Oregon are: Venus, Kodiak, Trident, Midget (small-seeded type), Signet, Mars, Bolero, and Dark Seeded Perfection types.

Fresh market: early: Oregon Pioneer; main season: Oregon Pioneer for early plantings, Oregon Trail for mid and late season plantings. Both are pea enation mosaic virus resistant, with Oregon Trail also being powdery mildew resistant. Both have some tolerance to red clover vein mosaic. These are replacements for the variety Corvallis. For trial: Charo, Renown, Sundance.

SOIL AND LAND PREPARATION

It is important to choose a field with uniform fertility, soil type, slope, and drainage to get a uniform pea crop. The best soils are silt loams, sandy loams, or clay loams.

Peas need a good supply of available soil moisture, but yields may be reduced by over-irrigating as well as under-irrigating. Peas grown on wet soils develop shallow root systems which cannot supply the plant's water requirements when the soil dries out later in the season. Root rot is often a problem in wet soils.

Determine corrective lime and fertilizer needs by a soil test. Adjust pH to 6.5 or higher for maximum yields.

Land should be plowed, harrowed, and a cultipacker used lightly to ensure a firm seed-bed. The land should be level in order to make harvesting more efficient. Care must be excersised in avoiding subsurface compaction since this contributes to limited aeration and rooting and predisposes roots to a number of root pathogens.

Peas are tolerant of cool soil temperatures, but sensitive to flooded or excessively wet soils associated with early spring plantings in western Oregon. Germination will occur at 40 to 85 F, ideally 50-75 F.

SCHEDULING PLANTINGS

Plantings may be made as soon as the soil can be worked in the spring. Peas in western Oregon are planted from late February through mid-May. Enation-resistant varieties may be planted throughout the entire planting season. Terminate the use of enation susceptible varieties by April 1 (see variety list and Disease Control section).

Processing peas are scheduled on the basis of heat units. Planting and harvest schedules are established by the processing company.

Fresh market peas and edible pod peas may be scheduled on the basis of heat units and by picking requirements for given plantings. In general, April plantings will require about 70 days to harvest, May plantings about 60 days and June plantings about 55 days. Plantings should be about 2 weeks apart in April and early May and about 1 week apart from mid-May on. Plant the amount of area would be picked over that period of time.

SEEDING

Pea seed numbers approximately 2000 per lb for standard varieties, to 3000 per lb for small seeded varieties. For processing, drill seed at a uniform depth of 1.5-2 inches into moisture, dropping 3 to 6 seeds per foot of row with rows 6-8 inches apart. Aim for a plant population of 350,000 for standard varieties

to 480,000 plants per acre for small seeded varieties (these tend to have lower emergence).

Avoid excessive overlaps and double planting along the edges of the field. This may cause uneven colored peas and lack of uniformity at harvest. The new small-seeded varieties must be planted shallow in order to obtain the best stands. These peas are less vigorous than the standard types, and for that reason they need to be planted where moisture is close to the surface, and in the more fertile fields.

Providing moisture is adequate and not excessive, a light rolling may be advantageous. Heavy rolling or packing is likely to reduce root growth, fertilizer uptake and pea root nodulation, and to increase the number of plants affected by root rot.

Inoculate with *Rhizobium* bacterium in a planter box treatment when planting on soils not previously planted to peas.

New research indicates that stand and seedling vigor can be greatly reduced by the presence of hollow heart (or cavitation) in the seed. This is a physiological disorder believed to be aggravated by premature combining or swathing of the seed crop. This disorder can affect seed quality of all varieties from all seed sources. Differences in severity by variety and seed source can be large. The range of seed affected was from 5% to 78% with a mean incidence of 33% in a 1986 seed sampling study, and 4% to 75% with a mean incidence of 30% in a 1985 study.

FERTILIZER

Good management practices are essential if optimum fertilizer responses are to be realized. These practices include use of recommended pea varieties, selection of adapted soils, weed control, disease and insect control, good seed bed preparation, proper seeding methods, and timely harvest.

Because of the influence of soil type, climatic conditions, and cultural practices, crop response from fertilizer may not always be accurately predicted. Soil test results, field experience, and knowledge of specific crop requirements help determine the nutrients needed and the rate of application.

The fertilizer application for vegetable crops should insure adequate levels of all nutrients. Optimum fertilization is essential for top quality and yields.

Recommended soil sampling procedures should be followed in order to estimate fertilizer needs. The Oregon State University Extension Service agent in your county can provide you with soil sampling instructions and soil sample bags and information sheets.

NITROGEN (N)

Rates of 20 to 30 lb N/A banded with P and possibly K at planting time are suggested. Peas have the

capacity to fix atmospheric nitrogen, and have been shown to use this nitrogen more effectively than applied N. The application of N at rates higher than those indicated may be detrimental to nitrogen fixation by the plant and yields.

Information on the application of N is given below in the sections on P and K.

INOCULATION

Pea seed should be inoculated immediately before seeding to insure an adequate supply of nitrogen-fixing bacteria when planting in soils not having been used for pea production previously. A fresh, effective, live culture of the correct strain of *Rhizobium* should be used.

PHOSPHORUS (P)

Phosphorus is essential for vigorous early growth of seedlings. Preferably P, N, and, where required, up to 60 lb K₂O/A should be applied in a band 2 inches to the side and 2 inches below the seed at planting time.

When banding equipment is not available 20 to 30 lb N/A and 40 to 80 lb P₂O₅/A can be drilled with the seed. Additional P₂O₅ and K₂O, when required, can be broadcast and plowed down prior to planting.

If the soil test* for P reads (ppm):	Apply this amount of phosphate (P ₂ O ₅) (lb/A):
0 - 15	120 - 150
15 - 60	80 - 120
over 60	40 - 80

*Assumes extraction procedures similar to those used by the OSU Central Analytical Laboratory. Specific information on soil test procedures is available from the Dept. of Crop and Soil Science.

POTASSIUM (K)

Potassium should be applied and plowed down before planting or banded at planting time as described in the above section on P.

Potassium should not be included with N and P when fertilizer is drilled with the seed. In a 2" x 2" band application of N, P, and K the K rate should not exceed 60 lb K₂O per acre. Additional K, where required, should be broadcast and plowed down prior to planting.

Seedling injury from banded fertilizers tends to be more serious:

- in drier soils
- in coarse textured, sandy soils
- where fertilizer band is close to seed.

Phosphorus fertilizers are less injurious to seedlings than N and K fertilizers.

If the soil test* for K reads (ppm):	Apply this amount of K ₂ O (lb/A):
0 - 100	90 - 120
75 - 150	60 - 90
150 - 200	40 - 60

*Assumes extraction procedures similar to those used by the OSU Central Analytical Laboratory. Specific information on soil test procedures is available from the Dept. of Crop and Soil Science.

SULFUR (S)

Plants absorb S in the form of sulfate. Fertilizer materials supply S in the form of sulfate and elemental S. Elemental S must convert to sulfate in the soil before the S becomes available to plants. The conversion of elemental S to sulfate is usually rapid for fine ground (less than 40 mesh) material in warm moist soil.

Sulfur in the sulfate form can be applied at planting time. Some S fertilizer materials such as elemental S and ammonium sulfate have an acidifying effect on soil.

Sulfur is sometimes contained in fertilizers used to supply other nutrients such as N, P, and K, but may not be present in sufficient quantity.

Responses to S fertilization may not occur for a period of at least 4 or 5 years on "red hill" soils which have a history of high S fertilization. These soils have a comparatively high ability to adsorb S and frequently have a history of high S fertilization through the use of S-containing fertilizer such as ammonium sulfate.

The S requirements of peas can be provided by:

1. The application of 20-30 lb S/A in the form of sulfate at or prior to seeding.
2. Applying 30-40 lb S/A as fine ground (finer than 40 mesh) elemental S the preceding year.
3. Applying coarser ground elemental S at higher rates and less frequently.

MAGNESIUM (Mg)

When the soil test value is below 0.5 meq Mg/100g or when calcium (Ca) is 10 times more than the Mg apply 10 to 15 lb Mg/A banded at planting.

Magnesium can also be supplied in dolomite which is a liming material and reduces soil acidity to about the same degree as ground limestone. Dolomite should be mixed into the seed bed at least several weeks in advance of seeding and preferably during the preceding year. An application of dolomite is effective for several years.

OTHER NUTRIENTS

Responses of peas to nutrients other than those discussed in this guide have not been observed in western Oregon. Peas have a comparatively low requirement for boron which should never be included in fertilizer banded with peas.

LIME

Peas are fairly sensitive to soil acidity and are responsive to liming of acid soils.

Lime application are suggested when the soil pH is 6.0 or below, or when calcium (Ca) levels are below 5 meq Ca/100g of soil.

If the SMP Buffer* test for lime reads:	Apply this amount of lime (T/A):
below 5.5	6
5.5 - 5.7	5 - 6
5.7 - 5.9	4 - 5
5.9 - 6.1	3 - 4
6.1 - 6.3	2 - 3
6.3 - 6.5	1 - 2
over 6.5	0

*Assumes extraction procedures similar to those used by the OSU Central Analytical Laboratory. Specific information on soil test procedures is available from the Dept. of Crop and Soil Science. The suggested liming rate is based on 100 score lime.

Apply lime at least several weeks before seeding and preferably the preceding year and mix with the surface 5 to 6 inches of soil.

A lime application is effective over several years.

Some soils may have a fairly high SMP buffer value (over 6.5) and a low pH (below 5.5). This condition can be caused by the application of acidifying fertilizer. In this case the low pH value is temporary and the pH of the soil will increase as the fertilizer completes its reaction with the soil. This temporary "active" acidity from fertilizer is encountered following recent applications of most N fertilizer materials. Acidifying fertilizers also have a long term acidifying effect on soil which is cumulative and leads to lower OSU SMP buffer readings.

Sandy soils to which fertilizers have not been recently applied sometimes record low pH and high SMP buffer values. In such cases, a light application of 1 to 2 T lime/A should suffice to neutralize soil acidity.

For acid soils low in Mg (less than 0.8 meq Mg/100g of soil) 1 T/A dolomite lime can be used as a Mg source. Dolomite and ground limestone have about the same ability to neutralize soil acidity.

Fertilizer Guide #3, "Liming Materials for Oregon," which is available from your local OSU Extension Office, provides additional information on lime.

IRRIGATION

Peas are produced successfully with or without irrigation depending on the area of production and cropping practices. Where center pivot systems are available, peas may be conveniently and economically irrigated, taking advantage of the large response peas exhibit to irrigation, however timing is important.

1. Do not irrigate peas before flowering unless the ground is very dry and germination would not otherwise occur, or the crop is severely wilted. Irrigation at this time may actually decrease yield.
2. Irrigate when flowers are first opening. This is when peas are most responsive to irrigation because root growth ceases and demand for moisture is high.
3. Peas do not generally respond to irrigation after flower petals begin to fall, and irrigation at this stage may increase disease incidence.

HARVESTING, HANDLING, AND STORAGE

In the Willamette Valley, pea harvest for processing may begin about June 1 and extend to September 30. The prime harvest period is from June 7 to September 20.

The processor determines time of harvest according to tenderometer reading, the number of other fields ready for harvest, weather, soil conditions, and the processor's need for quality. Generally, yields of shelled peas increase with increasing maturity, but quality decreases.

With mobile viners the crop is cut and swathed into windrows, threshed out by the mobile viners following swathers. Peas must be delivered to the processing plant soon after harvest, especially when the weather is hot, to avoid off-flavors. With the new pod stripping harvesters, no swathing is needed.

STORAGE (quoted from USDA Ag. Handbook # 66):

Green peas tend to lose part of their sugar content, on which much of their flavor depends, unless they are promptly cooled to near 32 F, relative humidity 90-95%, after picking. Hydrocooling is the preferred method of precooling. Peas packed in baskets can be hydrocooled from 70 to 34 F in about 12 minutes when the water temperature is 32 F. Vacuum cooling also is possible, but the peas must be prewet to obtain cooling similar to that by hydrocooling. After precooling, peas should be packed with crushed ice (top ice) to maintain freshness and turgidity. Adequate use of top ice provides the required high humidity (95 %) to prevent wilting. The ideal holding temperature at 32 F. Peas cannot be expected to keep in salable condition for more than 1 to 2 weeks even at 32 F unless packed in crushed ice. With ice, the storage period may be extended perhaps a week. Peas keep better unshelled than shelled.

Research in England showed that the edible quality of green peas was maintained better when the peas were held in a modified atmosphere of 5 to 7 % carbon dioxide at 32 than in air for 20 days.

PACKAGING

Fresh market peas are hand harvested and the pods are commonly packaged in 30 to 32-lb bushel wirebound crates, or 28 to 30-lb bushel baskets.

Squash are vine or ground crops that require lots of space and strong support. All forming squashes should be kept off of media by suspending or by separating with a piece of glass. A squash vine, well cared for, will grow for over a year and produce many squashes.

Seeds are started in the tub at least 1" below the media. The squash plants grow to six inches in height in a week or two, and a tub should be thinned to 4 to 6 plants when they reach 8" tall.

Squashes form flowers that must be fertilized, with pollen from male to female flower. This is usually done with a paintbrush, going from the center of one flower to the center of the other. The female flowers are recognized by a bulb behind the flower, and only those will form into squash. After used as fertilizing all male flowers can be picked and eaten in soups or salads.

When the squashes form, they will take some time to ripen. They should receive partial shade as they ripen and they should be picked only after they have changed color and sound ripe. A ripe sound when hit is sort of a hollow sound.

Trace mineral supplements should be added to the water of the plants as they ripen. This can be from a mineral supplement from a health food store, and we are selling Equinox Master Formula for this purpose. Some of the flavor is apparently due to trace minerals.

Squash, summer

Summer squash has a soft, tender skin and is commonly named straightneck, crookneck, scallop, and zucchini.

Planting: Planting should be delayed until all danger of frost has passed. Plant 3 or 4 seeds per hill, thinning the seedlings to two per hill.

Fertilizer: Squash requires moderate amounts of nitrogen and high amounts of phosphorous.

Nutrient Deficiencies: Blossom End Rot.

Harvest: Summer squash should be harvested while the fruit is still young and immature. Be sure to keep all overmatured squash picked to encourage plant vigor.

Squash, winter

Winter squash has a hard skin and is planted for fall harvest, before the first frost. Some of the more popular types are acorn, butternut, and banana.

Planting: Planting should be delayed until all danger of frost has passed. Plant 3 or 4 seeds per hill,

thinning the seedlings to two per hill. This plant seems to be particularly sensitive to excessive weeds, so proper weeding is a must.

Fertilizer: Squash requires moderate amounts of nitrogen and high amounts of phosphorous.

Nutrient Deficiencies: Blossom End Rot.

Harvest: Generally, winter squash should be picked only after the fruit is fully matured. The Yellow acorn squash is one exception. When the shell of the fruit is hard and the vines begin to die, it is time to harvest the winter squash.

Pumpkins

Planting: Although seed may be planted in the spring, plant seed for a Halloween pumpkin much latter. It takes 90 to 110 days from planting to harvest for the pumpkin to mature. If your garden area is not very large, consider planting the pumpkin patch on the edge of the garden where the long vines can flow out of the garden.

Fertilizer: A fertilizer with moderate amounts of nitrogen and high amounts of phosphorous is best suited for pumpkins.

Harvest: Pumpkins take 90 to 110 days to mature and will rot in the garden if left too long. Store pumpkins in a cool, dry place.

Melons are grown on vines that creep on the ground up to six feet

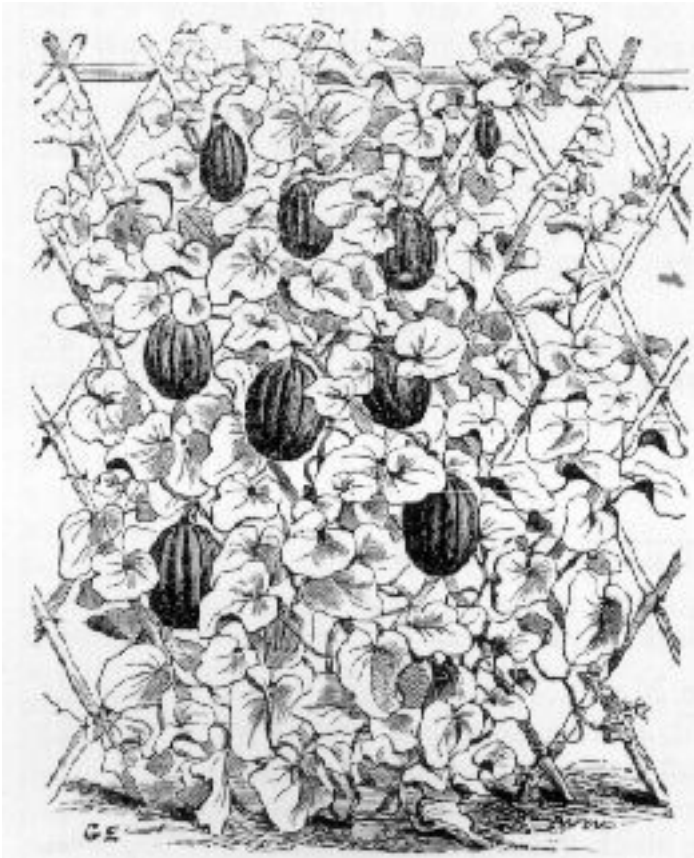

Melons are grown on vines that creep on the ground up to six feet. If you do not have enough area around a tub, you should plant the melon like a vine and tie to a support.

Melons need a night temperature of 55 degrees or greater, and grow best in a daytime temperature of 80 degrees or greater. Therefore, they should be planted to receive lots of sun in a warm place in the growing area.

Melons are a vine crop that requires a strong support. Larger melons such as watermelon can reach sizes of 22 pounds, and will require strong support. All forming melons should be kept off of media by suspending or by separating with a piece of glass. A melon vine, well cared for, will grow for over a year and produce many melons.

Seeds are started in the tub at least 1" below the media. The melon plants grow to six inches in height in a week or two, and a tub should be thinned to 4 to 6 plants when they reach 8" tall.

Melons form flowers that must be fertilized, with pollen from male to female flower. This is usually done with a paintbrush, going from the center of one flower to the center of the other. The female flowers are recognized by a bulb behind the flower, and only those will form into melons. After used as fertilizing all male flowers can be picked and eaten in soups or salads.

When the melons form, they will take some time to ripen. They should receive partial shade as they ripen and they should be picked only after they have changed color and sound ripe. A ripe sound when hit is

sort of a hollow sound.

Watermelon can offer a purified water when you are in an area where the water cannot be trusted. The watermelon often used as a source of purified water for ill patients and is said to have curative powers of its own.

Trace mineral supplements should be added to the water of the plants as they ripen. This can be from a mineral supplement from a health food store, and we are selling Equinox Master Formula for this purpose. Some of the flavor is apparently due to trace minerals.

Cantaloupe:

Cantaloupe or Muskmelon is a warm weather plant and will not tolerate any kind of cool or cold weather. As a matter of fact, fruit quality can even be effected by extended periods of cloudy weather.

Diseases: Fusarium wilt, Mosaic, **and** Powdery mildew.

Harvest: Harvest the fruit when the stem looks cracked and shriveled and the curl has turned brown. If the melon does not come off the vine with a slight turn, the fruit is probably not ripe.

Watermelon:

This warm weather plant needs a lot of room to grow and a long, dry growing season.

Planting: Plant seed only after all danger of frost has passed. If you live in an are of the country with a short growing season it may be necessary to start transplants in peat cups six weeks before planting in the garden. To get a jump on warming up the soil, black plastic mulch can be laid over the growing area. Watermelons need a lot of space and are planted six feet apart. If your gardening area is small, try planting them on a corner or the edge of the garden. The vines can spill over into the area surrounding the garden.

Diseases: Bacterial wilt, Fusarium wilt, Mosaic, Powdery mildew, **and** Stem anthracnose. **Nutrition problems:** Blossom end rot.

Harvest: If hot weather and the growing season appears to be coming to a close, remove all blooms and small melons. This will concentrate the plant's energy on the fruit that remains. Only experience will tell you when the watermelons are truly ripe; for sure the "curl" should be dead. An old method is thumping the melons. You should hear a low sounding thump and not a high pitched thump.

Tomato is an ancient vegetable that may be of Inca origin

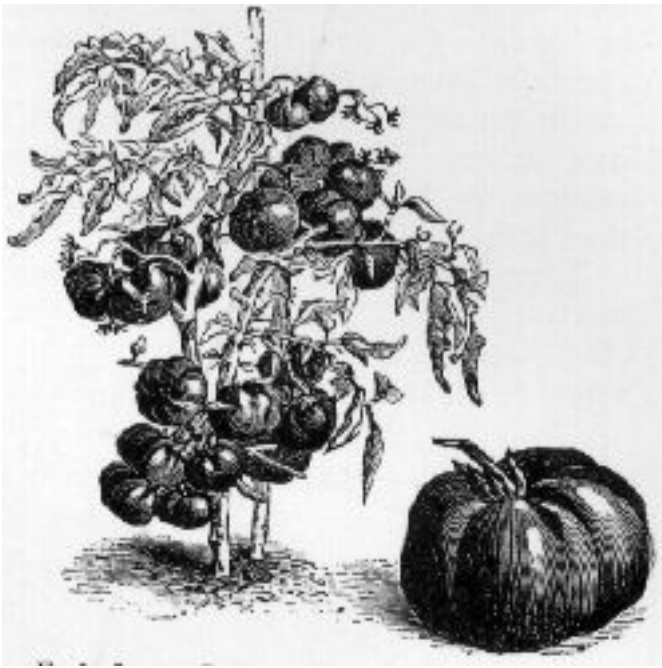

Tomato is an ancient vegetable that may be of Inca origin. It is now one of the most popular garden vegetables world wide. It forms a staple part of many diets, and tomato sauces, salsa's and ketchup's are some of the best selling food products.

Tomatoes can be grown hydroponically, and can be ripened on the vine to produce a high flavored

product.

Tomatoes are slow to germinate and slow to start producing fruit. Germination can take from 8 to 24 days (depending on the temperature) and it can take another 90 days until fruit forms.

Tomato plants can grow 25 feet long in hydroponic systems and produce for over a year. While tomatoes in the ground usually produce about seven pounds a year, a hydroponic plant can produce 32 pounds.

There are two type of tomatoes, determinant and indeteminant. The determinant plants are bushy and produce several tomatoes all at once. Indeterminant plants tend to vine and produce tomatoes as they vine, so they can produce tomatoes year round. Indeterminant plants are most often used in hydroponic culture.

As the plant grows, it will require support for the vines and fruit. Usually the plant is loosely tied with a string to a support trellis. As the plant grows, it will produce suckers in between the leaves at each node. To keep the plant growing upward, it is important to pinch out the suckers as they reach about one inch long. As the fruit starts to form, leaves under the fruit can be removed as no longer necessary. Keep leaves over the fruit to keep tomatoes shaded as they ripen.

Tomato plants will produce a stem with flowers, usually every third node on the plant. These tomato flowers are self pollinating, but they need to be vibrated every day as they are open to ensure they become pollinated. After the flowers die off, those that have been pollinated will start to form in the remaining stem of the flower. When the tomatoes get to be about one inch in diameter, pick off the smaller fruit and leave only three on each stem. This helps the tomatoes on the stem get larger and more flavorful.

Tomatoes are happiest at daytime temperatures of 25C and nighttime temperatures of 18C. Over 32C and there is poor fruit set.

Tomato flavors are from several things. For one thing, the type of tomato plant will determine a lot of the flavor. Most modern hybrid plants are designed to look nice and keep well, but not necessarily for flavor. Some of the better flavored tomatoes are the heirloom varieties, or old fashioned varieties. There are also many varieties worldwide, and these international varieties often have high flavor.

Flavor will be improved when the tomatoes are allowed to ripen on the vine. Many supermarket tomatoes are picked green and shipped to your local market, so the tomatoes were not allowed to ripen on the vine. Each tomato should be picked just before it is eaten.

Nutrients also affect flavor, and at this point you can experiment to find the best flavor recipes for your tomatoes. Nutrient can be reduced a few days before the tomatoes are to be picked. This starvation allows the tomato to build up more sugar and less nitrates. Also, a saltier solution will improve flavor be also starving the plant somewhat.

The flavor could be flat because of a high pH in the water. We add vinegar to the tomato water to keep the p/h at about 6.0 to 6.2. This can help add bite to the tomato.

Also, tomatoes are grown on tomato nutrient until they start to bloom, and are switched to bloom nutrient. This reduces the nitrogen to promote flowering and reduce green growth. With this partial reduction of nitrogen there should be less nitrates in the tomato, more Vitamin C and more flavor.

Tomato problems

Blossom end rot - Blossom end rot is a brown discoloration at the end of the tomato that begins to rot before the tomato ripens. It is usually a sign that the tomato is low on calcium, and calcium can be added by making a spray with calcium nitrate, or other calcium based product.

Cracking of splitting fruit - this is often caused by sudden changes, and often is from the tomatoes getting wet during the hot day. It can also be from rapid changes in the nutrient solution.

Tomatoes are grown by home gardeners more than any other vegetable. They are grown in gardens, on patios, and in flower beds.

Carefully check the pH of the soil, because tomatoes like a slightly acidic soil.

Planting: Plant tomatoes when all danger of frost has passed and the soil temperatures are warm. Although tomato plants can be grown from seed, they are usually grown from plants because of the long growing season needed for tomatoes. Plants are usually staked or placed around wire cages. Concrete wire or hog wire makes excellent cages. If the plants are purchased in peat cups, gently squeeze the cups to break the peat and set the cups below the soil line. Taller plants that are purchased will have a long stem with no foliage towards the bottom of the plant. Dig a small trench and lay the roots and stem in the trench horizontally, allowing only the foliage to remain above the soil line. This will serve to produce a very good root system and support for the plant. After setting out the new plants it is best to apply a plant starter solution. An organic method of achieving this is to apply a manure tea, consisting of water and composted manure. As the plant grows it will produce "suckers", which are small branches that grow where the main branches intersect the main stem. Suckers tend to take away from the vitality of the plant and causes small fruit. Some gardeners remove all suckers, while others remove all but the first sucker. Leaving the first sucker on the plant will cause the plant to have two main stems. As the plants grow, tie the branches to the stakes or wire with loose twine. Keep the plants mulched to hold moisture in the soil. Be sure to water properly during dry spells, as long dry periods can cause blossom end rot.

Fertilizer: /b Tomatoes are fairly heavy feeders and require a fertilizer with high amounts of nitrogen and phosphorous. Potassium needs are moderate.

Diseases:**Bacterial canker, Early blight, Fusarium wilt, Late blight, Mosaic, Nematodes, Payllid**

yellows, Septoria leaf spot, Spotted wilt, and Stem anthracnose.

Nutrient Deficiencies: Blossom End Rot.

Harvest: It is best to pick tomatoes as they are turning orange. This will keep the birds, who are also waiting for the fruit to ripen, from pecking holes in the fruit. The tomato will quickly finish ripening on a window sill in the safety of the house. As the first freeze of the year approaches, harvest all remaining green tomatoes and bring them in the house. Wrap the green tomatoes in some newspaper in a warm place and they will finish ripening without the aid of sunlight.

[Tomato Page](#)

[Tomato Growing Information](#)

Garlic (*Allium sativium*) are grown from cloves of a garlic bulb. The bulb divided into cloves and each clove is planted under 2" of media. The leaves look like grass and the plants grow to 18" tall.

Garlic grows best in pH from 5.5 to 8.0. They are usually grown from cloves of a shallot, and planted 1" deep. To harvest, bend the leaves down and allow them to dry out. Then braid the garlicks and they should remain for a few months if left in dark dry space.

Garlic is know for many medicinal properties, and is a standard part of the diet of many cultures. It is known to thin the blood and act as an antiseptic. It also adds tremendous flavor.

There is also research that shows that garlic grown with excess selenium can be used to reduce breast cancers.

Planting: Cloves of garlic are rounded on one end and pointed on the other. Gently press the clove into the soil with the pointed end slightly above the soil line.

Diseases: Downy mildew, Neck rot, Pink rot, and Smut.

Harvest: Harvest individual plants as needed fresh. Whole bulbs may be stored and individual cloves separated as needed.



Corn can be grown in hydroponic tubs, and is usually planted six per tub. The corn should be planted directly into the tub because it does not transplant well. The corn plants will produce about three ears of corn per plant, or about 18 ears per harvest. A harvest usually occurs within 8 to 10 weeks of planting. That means that the average production of corn is about one ear of corn every four days in each tub.

Corn is an ancient South American plant which was engineered perhaps from a grass called teosinte.

The corn is planted about one inch below the surface, and usually germinates in about six days. The places where corn does not grow should be replanted to ensure six plants per tub.

Hopi Blue corn has about 12% more protein than sweet hybrid corn, so if the corn is raised for nutrition, it makes sense to plant a Native American corn.

Corn is nitrogen hungry and usually kept on grow nutrient until after the top has tasseled and the silk has formed.

When the corn tassels, the pollen has to fall from above onto the leaves below and into the fold of the

leaf. If all the silk is pollinated the corn kernels should all form.

Corn pollinates the silk coming out of the corn from the tassels at the top of the plant. Ears of corn that are not fully filled out is a result of not enough pollination. Planting several short rows is better than one or two long rows. This will ensure proper pollination. In a very small garden you can take a tassel and go around tapping some of the pollen on each of the silks to increase the chances of pollination.

Corn can grow very tall in hydroponic culture. Expect the corn to grow to seven feet tall. Also, with corn, at least 50% of the plant is stalk and not edible. In hydroponics the corn is often a smaller percentage. There is a loss of nutrient in this process. However, corn stalks make a viable paper product and can be used to wrap food. They are also excellent in composting.

Hydroponic Nutrients: Corn likes a high nitrogen so it should be kept on Grow nutrient throughout the life cycle. For field crops apply fertilizers high in nitrogen and phosphorous with moderate amounts of potassium.

Diseases: Bacterial wilt, Corn smut, Mosaic, and Rust.

Harvest: Check an ear of corn by pulling back the shuck at the end of an ear to see if its filled out. Juice from a kernel should spurt out when poked at with a fingernail. Generally, when the silk turns brown and the ear is firm when squeezed it's time to harvest the corn.

[Corn Information](#)



Peanuts grow on a small bushy plant similar to a potato. The peanut plant blossoms form, then bury themselves in the media to form a peanut. A tub system will grow eight peanut plants and they will continue to produce peanuts for over a year.

The peanut is another Inca vegetable that has attained world wide popularity. In the 1800's an African American scientist George Washington Carver, developed over 300 uses for the peanut.

Peanuts are best grown from nuts still in their paper like wrappers. All peanuts sold are not still viable. Most have been roasted or salted. Raw peanuts are needed as a seed source. Peanuts germinate at 65 to 70 degrees F.

They grow best in pH from 6.0 to 6.5. They are planted 16 plants per tub, and then thinned to 8 per tub when 1' high. They are also switched to root nutrient at this time.

Hydroponic Culture A single tub of peanuts should produce about 1000 peanuts, or about 4 cups of peanuts. It will take 90 days before any peanuts are formed, and then the plants should continue to produce peanuts the rest of the year.

Peanuts need about 8" of media to grow under the plant. If the peanuts get in the standing water they will rot or taste moldy. It might be good to build a tub grower which is deeper than the 1' in the tub systems.

The spanish peanut seems to be the easiest to grow, but other types might do well also. The peanut is an essential part of the hydroponic diet because it provides essential fats that are missing in most other vegetables.



Radishes could be the easiest vegetable to grow in hydroponics. Depending upon the variety, both the radish greens and the radish roots are edible.

Radish seeds should be scattered into the tub, at about 100 seeds per tub. The seeds tend to germinate in just a few days and can be full grown radishes in less than a month.

Radishes should be started on Grow nutrient until the greens reach about 3 " tall, and then be switched to root nutrient.

There are summer and winter radishes, and these two crops should be switched during the year to keep radish production going yearround. The winter radishes tend to be larger and have to be in a deeper tub.

Radishes can be pulled as needed, and then new radish seed can be replanted as space is available. Radishes can go to seed if they get too hot, so you might need to provide partial shade during the hottest part of the summer.

Radishes can burst if they have been exposed to water and then rapid drying. Since this is likely in a tub overpour system, it might be wise to put a funnel in the tub and pour water deeper than the developing roots. Also, radish leaves are usually very soft in hydroponic culture and suitable for use in soups and salads.

If planted among greens, such as turnips or mustards, radishes will serve to deter insects from invading the greens.

Planting: The majority of radishes are grown in the cool spring and fall months, but there are some varieties which will tolerate the heat of summer. Allow enough space between plants to insure the roots

have enough space to develop. Radishes planted too close together will produce all tops and very small roots.

Diseases: not usually subject to disease.

Harvest: Radishes can be harvested whenever they reach an eatable size. Spring planted radish takes about four weeks. The summer and fall varieties take five and nine weeks respectively.

[Medicinal Uses](#)

Radish

Family: N.O. Cruciferae

- [Description](#)
- [Constituents](#)
- [Medicinal Action and Uses](#)
- [Other Species](#)

---Parts Used---Root, seed-pods.

---Habitat---Europe, especially Britain, and temperate Asia. A native of China, Cochin-China and Japan.

---Description---The name of this familiar garden plant is suggested by its colour, being derived from the Saxon, *rude*, *rudo*, or *reod* (ruddy), or from the Sanskrit *rudhira*, meaning blood. The genus is distinguished by its elongated pod, which has no longitudinal partition when ripe, but contains several seeds separated by a pithy substance filling the pod. The actual plant is unknown in a wild state, but is supposed to have come from Southern Asia, and may be descended from the wild *Raphanus* *Raphanistrum* of the Mediterranean shores, the long roots developing seeds sown in a loose soil, and the turniprooted kinds in a stiff soil. In the days of the Pharaohs, the Radish was extensively cultivated in Egypt, but apparently it did not reach Britain until A.D. 1548. Gerard mentions four varieties as being recognized in 1597. The leaves are rough and partly divided into segments, the outer one being larger and broader than the rest. The flower stem grows to about 3 feet in height, bearing medium-sized flowers that vary in colour from white to pale violet, with strongly marked, dark veins. Structurally, it resembles the turnip, as the swollen, fleshy portion is really a stem which gradually passes downwards into the real root. Many kinds are named, the best known being (1) turnip-rooted, both red and white, including the white and black Spanish kinds; (2) oliveshaped, including the white, scarlet, and French breakfast forms; (3) the long, tapering varieties, like Long Red and Lady's Finger. The flesh is white, crisp, and tender, not specially nourishing, but valued as an antiscorbutic because of its quantity of nitrous juice. When too large for eating raw, they can be steamed for half an hour and served like asparagus. They should be well washed, but never peeled except when preparing the juice for medicinal purposes; in dry weather the bed should be watered the day before they are pulled. The young, green, seed-pods may be used for pickling, alone or with other vegetables, and are considered a fair substitute for capers.

[\[Top\]](#)

---Constituents---Phenyl-ethyl isothiocyanite, a pungent, volatile oil, and an amylolytic enzyme.

---Medicinal Action and Uses---Radishes are an excellent food remedy for stone, gravel and scorbutic conditions. The juice has been used in the treatment of cholelithiasis as an aid in preventing the formation of biliary calculi. The expressed juice of white or black Spanish radishes is given in increasing doses of from 1/2 to 2 cupfuls daily. The 2 cupfuls are continued for two or three weeks. then the dose is decreased until 1/2 cupful is taken three times a week for three or four more weeks. The treatment may be repeated by taking 1 cupful at the beginning, then 1/2 daily, and later, 1/2 every second day.

The colouring matter is recommended as a sensitive indicator in alkalimetry.

---Other Species---

R. Raphanistrum (Wild Radish, or Jointedpodded Charlock). It was stated by Linnaeus that in wet seasons this abounds as a weed among barley, in Sweden, and being ground with the corn, it is eaten in barley bread, causing violent convulsive complaints, or an epidemic, spasmodic disease. Other authorities say that it is harmless, liked by domestic animals and bees. It is bristly, and has rather large, straw-coloured flowers.

R. Sibiricus, or Siberian Radish, has cylindrical pods.

R. caudatus, the Java, or Rat's Tail Radish, a native of Final, furnishes long, edible pods, purple or violet in colour. They should be used half-grown. The root of this species is not used.

R. maritimus is an indigenous, seaside variety.

R. Erucoides, of Italy, has pods with a beak of their own length, and a simple, biennial root, scarcely thicker than the stem.

R. Tenellus, another native of Siberia, flowers in Britain in June and July, having awl-shaped, jointed, two-celled, smooth pods.

[\[Top\]](#)

Bell peppers are a tropical plant that can live to be seven years old



Bell peppers are a tropical plant that can live to be seven years old. A bell pepper plant will produce 8 to ten peppers at a time, and as many as thirty peppers can be produced by a tub, enough to supply one or two a day.

Seeds are started in the tub at least 1" below the media. The seeds take a week or two to germinate, and grow very slowly until they reach about 1 foot tall. Bell peppers will grow at any number from six to ten plants per tub, and will begin to produce peppers in about the sixth week.

Bell peppers form flowers that later turn into peppers. The peppers form as a green bell shape, and can be picked green. As they ripen further they will turn yellow or red, depending upon the type. The red peppers have ten times the vitamin C as the green peppers, and so they are more nutritious fully ripened.

Hot pepper are grown just as bell peppers, but must be kept away from bell peppers or the bell peppers will become hot as well. They grow best in pH of 5.5 to 7.0. They need temperatures from 70 to 80 degrees F, and no less than 55 degrees at night. They need humidity over 50% or the blossoms will drop off plant and fruit will not form.

Planting: Plant this vegetable when all danger of frost has passed. Most gardeners set out plants, since growing the transplants from seed takes 8 to 12 weeks. Four or five plants should supply an average family.

Fertilizer: Nitrogen, phosphorous, and potassium requirements are low for peppers. Too much fertilizer,

Bell peppers are a tropical plant that can live to be seven years old

in particular nitrogen, can cause blossoms or young fruit to drop off of the plant. One tablespoon of Epsom salts around each plant at blossoming time will produce larger and also thicker walled peppers.

Diseases: Bacterial spot, Mosaic, Southern stem blight, Spotted wilt, Stem anthracnose, and Viruses.

Nutrient Deficiencies: Blossom End Rot.

[Medicinal Uses](#)

Pepper

Family: N.O. Piperaceae

- [Description](#)
- [Constituents](#)
- [Medicinal Action and Uses](#)
- [Dosages](#)
- [Adulteration of Pepper](#)
- [Other Species Uses](#)

---Synonyms---Black Pepper. Piper (United States Pharmacopoeia).

---Part Used---Dried unripe fruit.

---Habitat---In South India wild, and in Cochin-China; also cultivated in East and West Indies, Malay Peninsula, Malay Archipelago, Siam, Malabar, etc.

---Description---The best Pepper of commerce comes from Malabar. Pepper is mentioned by Roman writers in the fifth century. It is said that Attila demanded among other items 3,000 lb. of Pepper in ransom for the city of Rome. Untrained, the plant will climb 20 or more feet, but for commercial purposes it is restricted to 12 feet. It is a perennial with a round, smooth, woody stem, with articulations, swelling near the joints and branched; the leaves are entire, broadly ovate, acuminate, coriaceous, smooth, with seven nerves; colour dark green and attached by strong sheath-like foot-stalks to joints of branches. Flowers small, white, sessile, covering a tubular spadix; fruits globular, red berries when ripe, and surface coarsely wrinkled. The plant is propagated by cuttings and grown at the base of trees with a rough, prickly bark to support them. Between three or four years after planting they commence fruiting and their productiveness ends about the fifteenth year. The berries are collected as soon as they turn red and before they are quite ripe; they are then dried in the sun. In England, for grinding they mix Peppers of different origin. Malabar for weight, Sumatra for colour, and Penang for strength. Pepper has an aromatic odour, pungent and bitterish taste.

---Constituents---Piperine, which is identical in composition to morphia, volatile oil, a resin called Chavicin. Its medicinal activities depends mainly on its pungent resin and volatile oil, which is colourless, turning yellow with age, with a strong odour, and not so acrid a taste as the peppercorn; it also contains starch, cellulose and colouring.

The concrete oil is a deep green colour and very acrid.

---Medicinal Action and Uses---Aromatic, stimulant, carminative; is said to possess febrifuge properties. Its action as a stimulant is specially evident on the mucous membrane of the rectum, and so is good for constipation, also on the urinary organs; externally it is a rubefacient, useful in relaxed conditions of the rectum when prolapsed; sometimes used in place of cubebs for gonorrhoea; given in combination with aperients to facilitate their action, and to prevent griping. As a gargle it is valued for relaxed uvula, paralysis of the tongue. On account of its stimulant action it aids digestion and is specially useful in atonic dyspepsia and torbid condition of the stomach. It will correct flatulence and nausea. It has also been used in vertigo, paralytic and arthritic disorders. It is sometimes added to quinine when the stomach will not respond to quinine alone. It has also been advised in diarrhoea, cholera, scarlatina, and in solution for a wash for *tinea capitis*. Piperine should not be combined with astringents, as it renders them inert.

[\[Top\]](#)

---Dosages---Black Pepper, 5 to 15 grains in powder. Piperine, 1 to 8 grains.

The root of the Pepper plant in India has been used by the natives as a cordial tonic and stimulant.

B.P. dose of Pepper, 1 to 2 drachms.

Oleoresin, U.S.P.: dose, 1/2 grain.

Heliotropin is recommended medicinally as an antiseptic and antipyretic. It is obtained by the oxidation of piperic acid and is used in perfumery. From the time of Hippocrates Pepper has been used as a medicine and condiment.

---Adulteration of Pepper---Linseed mustard seed, wheat and pea-flour, sago, ground rice. At one time when the duty levied on Pepper was very high, fictitious peppercorns were made of oil-cake, clay, with a little cayenne added.

[\[Top\]](#)

---Other Species Used---

- [Piper trioicum](#)
- [White Pepper](#)
- [Long Pepper](#)
- [Piper Betel](#)
- [Piper Amalago](#)
- [Piper Pellucidum](#)

- [Piper Rotundifolium](#)
- [Piper Umbellatum](#)

Piper trioicum

Piper trioicum, nearly allied to *P. nigrum*, is also used in commerce.

The female plant does not ripen properly, and is deficient in pungency, but the Peppers on plants with hermaphrodite flowers on same spike are very pungent, and equal to the best Malabar Pepper.

[\[Top\]](#)

WHITE PEPPER

(Piper album)

From the same plant as *P. nigrum*, White Pepper is ripe fruit, partially deprived of its pericarp by maceration in water, then rubbed and dried in the sun. It contains albuminous seed, having small starch grains, taste and smell like Pepper, more aromatic than black and not so pungent. Same as the black, but containing more starch and less ash. Sold as whole White Pepper or broken White Pepper. The removed hulls are sold separately as Pepper hulls, and form a brownish powder, very pungent in smell and flavour and containing a large quantity of oleoresin of Pepper, but no piperine.

Sometimes the hulls are mixed with the broken White Pepper; this mixture has more oleoresin in it and less piperine.

---Medicinal Action and Uses---Teaspoonful doses taken several times a day are recommended to overcome the obstinate constipation of dyspeptics.

[\[Top\]](#)

LONG PEPPER

(*Piper longum*)

---**Part Used**---The dried, unripe spikes of *Pipers officinum* and *longum*.

---**Habitat**---Java, India, Philippines, the best coming from Batavia, and Singapore.

P. officinarum is principally used and is considered the best; both are gathered when green, when they are hotter than when quite ripe. In *P. officinarum* the fruit is a dark grey colour with a weak aromatic odour and a very fiery pungent taste. In *P. longum* the fruits are shorter and thicker and the constituents almost identical with *P. nigrum*. It contains piperine, a soft green resin, a burning acidity, a volatile oil which possibly gives it its odour; it is inferior to *P. nigrum* and most used as its adulterant.

[\[Top\]](#)

Piper Betel

---**Habitat**---East Indies.

The leaves are used to wrap round areca nut; rubbed with shell lime they are chewed by the Indians to sweeten their breath and strengthen the stomach. The trade in it forms considerable commerce. The Asiatic use of it amongst men destroys the teeth from the lime used with it. The women of the Malabar Coast, on the other hand, stain their teeth black with antimony, which preserves theirs to old age.

[\[Top\]](#)

Piper Amalago

Piper Amalago, or rough-leaved Pepper, a shrub growing up to 10 feet. It is called the small-grained Black Pepper, and grows on the hilly parts of Jamaica. The berries differ only in size from the East Indian Black Pepper, being only the size of mustard seed, good for seasoning, taste and flavour being the same as Black Pepper. It is picked when full-grown before it ripens, otherwise it loses its pungency and

grows soft and succulent. It is dried in the sun and often left on its stalks, which have the same flavour and pungency as the Peppers and are as easily ground in the mills.

---Medicinal Action and Uses---Leaves and tender shoots are used in discutient baths and fomentations and pounded for application to ulcers; root is warm and very useful as a resolutive and sudorific or diaphoretic, but best for infusions and decoctions; a good deobstruent for dropsy.

[\[Top\]](#)

Piper Pellucidum

Piper Pellucidum, or pellicoid-leaved Pepper.

---Habitat---South America and West Indian Islands.

---Description---An annual found growing on moist, gravelly banks, etc.

Has very small berries each containing a small seed like dust. In Martinico the leaves are eaten with lettuce, vinegar and oil as a salad and called 'Cresson,' but they are too strong and hot for most Europeans.

[\[Top\]](#)

Piper Rotundifolium

---Habitat---Jamaica and Martinique.

A herbaceous plant living in close, moist woods covering the trunks of old trees and stones.

---Description---Leaves greasy, bright green, fragrant, reviving odour; good aromatics and cephalics, retaining perfume several years; water distilled from them smells deliciously of the plants.

[\[Top\]](#)

Piper Umbellatum

---**Synonyms**---Unbelled Pepper. Santa Maria Leaf.

---**Habitat**---Jamaica.

This plant is a very common annual and found growing up to 4 feet high. Has large round leaves; the root is a warm, active remedy against poisons, and in many parts of the sugar colonies is made up into a syrup much used by the inhabitants for colds and catarrhs.

[\[Top\]](#)

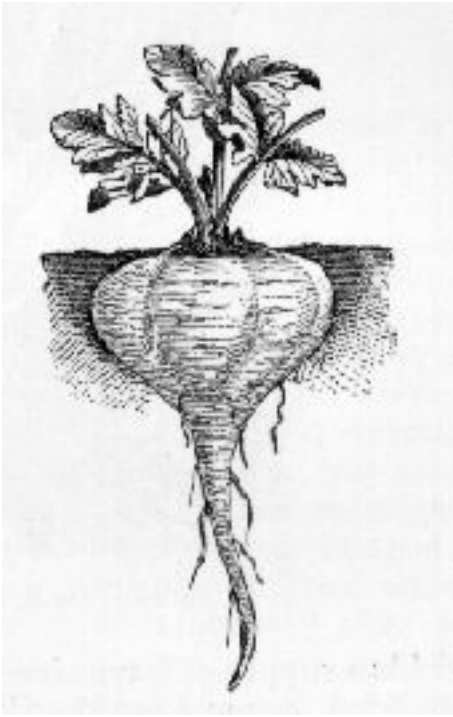

Parsnips (*Peucedanum sativum*) are a slow growing root vegetable. They grow throughout the year, and several have roots that are very long and must be grown in longer hydroponic tubs.

The parsnip grows best in pH for 5.5 to 7.0.

The sweet potatoes are grown from slips that form on a sweet potato. Plant a full sweet potato under 2" of media and watch for slips to form above the soil. Then twist the slips from the sweet potato and replant two plants per tub.

The seeds should be planted about 1/2" deep in the media and planted 100 per tub.

The plant should be started on grow nutrient and changed to root nutrient when the tops are about 6" high. Parsnips can be harvested after about 120 days of growing.

Planting: Areas of the country with mild winters should plant this vegetable only in the fall for a winter harvest. Cold weather and even a freeze improves the flavor of parsnips. Parsnip seeds are slow to germinate, so overnight soaking of the seed is recommended. You may want to consider marking the rows with radish seed. The faster germinating radish will have the advantage of breaking up any crusty soil while the parsnips are trying to break through the surface.

Fertilizer: Parsnips requires small amounts of nitrogen and moderate amounts of phosphorous. The use of fertilizers with plenty of potassium will encourage proper root development.

Harvest: Parsnips may be left in the ground through the winter, harvesting as needed. In the spring when the tops begin to grow once again, harvest all remaining roots or they will become woody and lose their

taste.

[Parsnip Production Guide](#)

Parsnip

Go to: | [Seeding](#) | [Fertilizers](#) | [Harvesting, Handling, Storage](#) | [Pest Control](#) |

VARIETIES (approximately 100 days).

Model (Smooth White). For trial: Hollow Crown, Andover (resistant to both brown canker, *Itersonilia perplexans*, and *Phoma* canker), Gladiator (resistant to *Itersonilia* canker).

SOIL

Deep, loose fertile soils that have good water-holding capacity and a pH of 6.0 or above are necessary for the development of long, straight roots. Well-drained sandy loams, peat, and mucks are ideal for parsnip production.

SEEDING AND SPACING

Parsnip seed numbers approximately 12,000 per ounce. Sow seed as early in the spring as possible at a rate of 3 to 5 lb/acre to a depth of 1/4 to 3/4 inches. Space plants within the row 2 - 4 inches apart and space rows at least 18 inches apart.

FERTILIZER

A soil test is the most accurate guide to fertilizer requirements. The following are general guidelines. Broadcast and disc, or band, at time of planting the following:

Nitrogen: 30-50 (N) 30-50 lb/acre.

Phosphate: 145-155 (P₂O₅) lb/acre.

Potash: 110-130 (K₂O) lb/acre as sulfate of potash

Sidedress with 25-35 lb N/acre about 6 weeks after seeding.

HARVESTING, HANDLING, AND STORAGE

Parsnips yield approximately 160-200 cwt/acre. Parsnips may be dug, topped, and stored in cold storage, in a cellar, or in an outdoor pit. They become sweeter and better flavored after a short period of cold storage. They may also be left in the ground over winter or until needed. Although parsnips can be harvested several ways, single or multiple-row harvesters can be custom built by Krier Engineering, 4774 Morrow Rd., Modesto, CA. Contact Mr. Alex Krier, 800-344-3218, for more information.

STORAGE (quoted from USDA Ag. Handbook # 66):

Store parsnips at 32 F and 98 to 100 % relative humidity. Parsnips have nearly the same storage requirements as topped carrots and should keep for 4 to 6 months at 32 F. Only sound, healthy roots should be stored -- never bruised or damaged ones. The main storage problems with parsnips are decay, surface browning, and their tendency to shrivel. The surface browning or yellowing is due to enzymatic oxidation of phenolic compounds. Refrigeration will retard both the discoloration and decay.

Parsnips may be subjected to considerable amount of freezing without serious damage. For example, roots exposed at 20 F for 3 hours showed little damage other than slight softening and discoloration when thawed over 24 hours at 70 F. However, they should be protected from hard freezing and should be handled with great care while frozen. Parsnips held at 32 to 34 F for 2 weeks after harvest attain a sweetness and high quality equal to that of roots subjected to frosts for 2 months in the field. Parsnips dry out readily in storage; hence, it is essential that the humidity of the storage be kept high. They will remain crisper and firmer, with less weight loss and better color, if stored at a relative humidity of 98 to 100 % rather than 90 to 95 %. In Canadian research, a jacketed type storage provided optimum conditions for parsnip storage. Ventilated polyethylene crate liners aid in preventing moisture loss. Waxing is not particularly effective in preventing wilting and may hasten browning.

Storage diseases are gray mold, parsnip canker, bacterial soft rot, and watery soft rot.

PACKAGING

Parsnips are commonly packaged in 25-lb film bags, or 12-lb cartons, holding 12 cello bags, 1 lb each.

PEST CONTROL FOR PARSNIPS

THE PESTICIDES LISTED BELOW, TAKEN FROM THE PACIFIC NORTHWEST PEST CONTROL HANDBOOKS, ARE FOR INFORMATION ONLY, AND ARE REVISED ONLY ANNUALLY. BECAUSE OF CONSTANTLY CHANGING LABELS, LAWS, AND REGULATIONS, OREGON STATE UNIVERSITY CAN ASSUME NO LIABILITY FOR THE CONSEQUENCES OF USE OF CHEMICALS SUGGESTED HERE. IN ALL CASES, READ AND FOLLOW THE DIRECTIONS AND PRECAUTIONARY STATEMENTS ON THE SPECIFIC PESTICIDE PRODUCT LABEL.

USE PESTICIDES SAFELY!

Wear protective clothing and safety devices as recommended on the label. Bathe or shower after each use.

Read the pesticide label--even if you've used the pesticide before. Follow closely the instructions on the label (and any other directions you have).

Be cautious when you apply pesticides. Know your legal responsibility as a pesticide applicator. You may be liable for injury or damage resulting from pesticide use.

WEED CONTROL (in the OSU weed management guide)

INSECT CONTROL

Proper rotations and field selection can minimize problems with insects.

Insect and Description	Control, Active Ingredient/Acre
Aphids	malathion - 2 lb
Plant lice (aphids) occasionally colonize on foliage.	diazinon - 0.5 lb
	Pyrellin - 1 to 2 pt
	Insecticidal soaps - see labels
Aster leafhoppers	carbaryl 4L - 1 to 2 lb
Carrot rust fly	No chemicals are registered for control at this time.
Mature larvae are straw colored, wiry, from 1/2 to 3/4 inch long. Worms burrow into and through edible roots.	
Cutworms and armyworms	Carbaryl 4L - 1 to 2 lb
Flea beetles	Carbaryl 4L - 0.5 to 1 lb

DISEASE CONTROL

The Pacific Northwest Disease Control Handbook has no control entries for this crop. Proper rotations, field selection, sanitation, spacings, fertilizer and irrigation practices can reduce the risk of many diseases. Fields can be tested for presence of harmful nematodes. Using seed from reputable sources reduces risk from "seedborne" diseases.

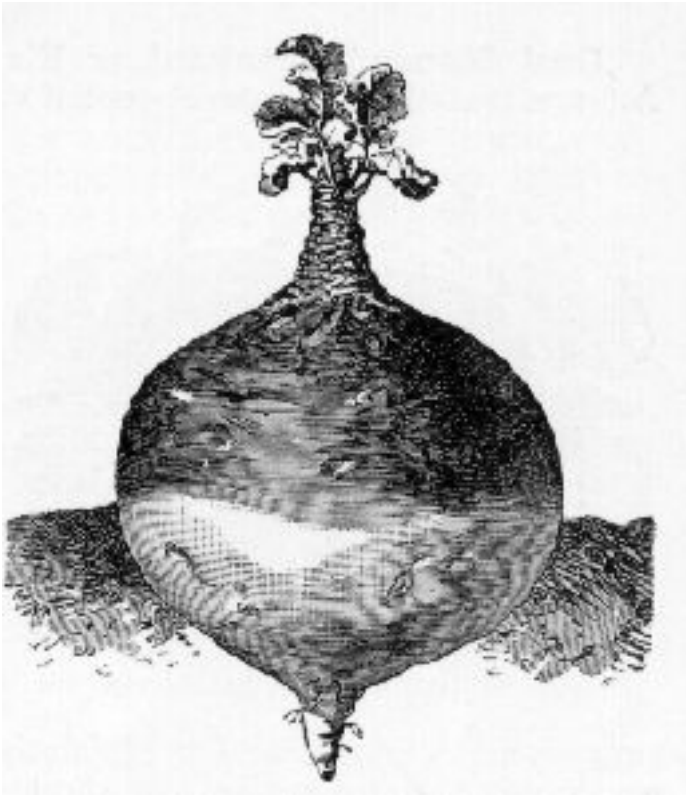

Turnips (*Brassica rapa*) are root vegetables that have edible top greens. They grow best in pH of 5.5 to 7.0. They are a warm weather vegetable that grow best in media temperatures of 80 degrees F or more.

Seeds are started in 1/2" deep media and plan to harvest about 40 turnips per tub. Plant about 100 seeds and thin when they get to be about 4" high. Use all thinned greens for salads or stews.

Start harvesting turnips and rutabagas when they reach 2" in diameter and then continue to harvest as needed until they reach about 4".

The plant should be started on grow nutrient and changed to root nutrient when the tops are about 6" high. If turnips are being grown for their top greens they should be kept on grow nutrient.

Turnips are grown for both their roots and their tops, which are cooked for greens.

Planting: This cool weather plant is grown in both spring and fall. If planting in the spring, be sure to plant the seed early for hot weather will make the roots bitter tasting and woody in texture. If you are growing the turnips for greens, there is no need to thin the plants. Turnips grown for there roots will need ample space between the plants to develop sizeable roots.

Diseases: Black rot and Leaf spots.

Harvest: Harvest turnip roots before hot weather arrives and before the roots become too large and woody.



Potatoes are tubers that grow on the roots of the potato plant. The vegetable is grown from seed in about three months. They grow best in pH from 6.0 to 6.5. They are planted 8 plants per tub, and then thinned to 4 per tub when 1' high. They are also switched to root nutrient at this time.

A single tub of potatoes should produce about twenty pounds of potatoes in a 90 day cycle. Potatoes can be harvested by reaching under the media and feeling for a larger tuber. The tubers must be at least 1" under the media and must be checked for any green tinge from being too close to the sun. Green potatoes must be thrown away as they might be poisonous.

To begin a potato plant, a small potato about the size of a hen's egg is planted. These starter potatoes can be started in a semi light room, with potato eyes set upright and sprouted. The sprouts are planted upright to begin towards green growth.

Potatoes are first grown with grow nutrient until they reach about 6" tall, and then should be switched to root nutrient. After about one month their should be blossoms formed on the plant, and at this point some potatoes should be ready. If the green parts start to fade in color before the potatoes are formed to full size, then add a bit of calcium nitrate to the water at 1/8 teaspoon per gallon.

When thinning potato plants, thin to four to six plants per tub. The potatoes will grow in the space below, and regrow after harvest if you remove the potatoes carefully without disturbing the roots.

Potatoes need about 8" of media to grow under the plant. If the potato tubers get in the standing water they will rot or taste moldy. It might be good to build a tub grower which is deeper than the 1' in the tub systems.

A single tub grower can produce 20 pounds of potatoes in a single growing season. They will be ready to begin picking when the blossoms start showing on the potato plant, and can be picked at any size. Flavor

seems slightly better when the potatoes are new or smaller.

Flavor and color and texture is more from the type of potato than any other aspect. A fresh potato raised on a trace mineral supplement usually has very fine flavor and texture.

Trace mineral supplements should be added to the water of the potato plants as they ripen. This can be from a mineral supplement from a health food store, and we are selling Equinox Master Formula for this purpose. Some of the flavor is apparently due to trace minerals.

The flavor could be flat because of a high pH in the water. We add vinegar to the potato water to keep the pH at about 6.0 to 6.5. Also, potatoes are grown on grow nutrient until they are 6" tall and then switched to root nutrient.

Potato problems

Potatoes can get a potato blight, but most diseases are soil born and not a problem in hydroponics. However, if a potato grows to close to the surface it can go green and this must be thrown away. It could be poisonous. Most potato diseases can be reduced by spraying with a peppermint spray or a compost tea. Occasionally nutrient water spray can also reduce diseases.

Molds and mildew - potato plants can get molds and mildew. Often the mold around the root is caused by excess moisture too close to the root. This can be remedied by making sure the water table is lower in the tub, or pouring nutrient in a place in the tub where it does not wet the roots. Also, mildew can build up in potato plants because of stale air, and so good air ventilation will help reduce mildew build up.

Irish Potatoes

Irish potatoes are generally a cool weather plant and is best suited for early spring planting. The tubers may be white, light brown, or red.

Soil Requirements: Potatoes are one of the few vegetables that prefer an acidic soil The pH should be below 6.0. Too alkaline of a soil could encourage the disease potato scab.

Planting: For early spring planting prepare the soil in the fall, when the soil is drier and easy to work with. Hill up the rows fairly high. The plants are grown from seed potatoes. These seed potatoes are cut into pieces about one to two ounces in weight, unless the seed potato are already small enough. Each cut piece should have at least one eye. Lay the pieces on some newspaper for one to two days to allow the cut pieces to heal, otherwise seed rot may occur. Heavy wet soils could also cause seed rot. Keep the dirt pulled up high around the plant to keep all developing tubers well covered. Another method of growing potatoes is to plant the seed potato 1 to 1 1/2 inches deep, covering with soil. When the sprouts break through the surface, start applying a straw mulch. Keep adding the mulch until it is about one foot deep or so. If any tubers are seen above the mulch, be sure to apply more mulch. Exposed potatoes can cause

the sun to turn the skin green. This green skin is poisonous and should not be eaten. Sometimes potatoes will bloom and produce a small green tomato-looking fruit. This fruit is also poisonous.

Fertilizer: Potatoes require moderate amounts of nitrogen. A good organic source is composted manure. Phosphorous and potassium requirements are on the high side. This will encourage proper root development. Cotton seed meal, bone meal, and potash are some beneficial ingredients for an organic fertilizer.

Diseases: Black leg, Early blight, Internal black spot, Mosaic, Rhizoctonia, Ring rot, Scurf, Soil rot, and Verticillium wilt.

Harvest: Small young potatoes can be dug up and eaten any time. They are great in a pot of green beans or eaten whole by themselves skin and all. When the foliage starts dying it is time to harvest all remaining potatoes. If you planted the potatoes in straw, just pullback the straw to reveal the prize, a nice clean potato. Lay the potatoes out to dry quickly and then store them in a cool, dry, dark place. Remember, sunlight will turn the potato skin green and should not be eaten.

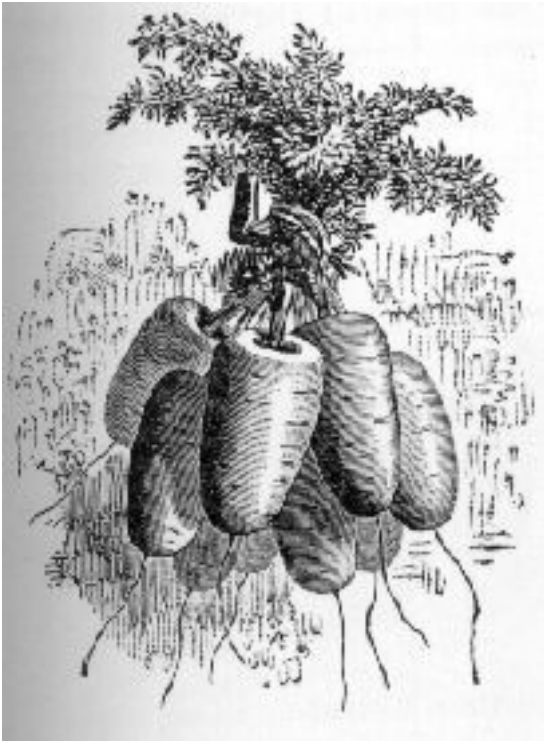

Carrot (*Daucus carota*) are planted about 100 per tub. The seed is very small and hard to evenly distribute on the tub, so you might have to start thinning the carrots after they start growing. It is important to grow a carrot that is short enough to fit in the depth of your tub.

Carrot seed takes about one week to germinate. Then the tops grow for the next month. When the tops are about 9" tall switch to tub to root nutrient. P>Carrots grow best in pH from 6.0 to 7.0. They grow best in temperatures between 40 and 80 degrees F. As the carrots start to grow roots, begin to use carrots thinning the tub as you go.

They can be harvested about six weeks after starting and then ongoing for the next month. Before winter, be sure to have a full crop in place and you can harvest carrots all winter.

Diseases: Leaf blight

Harvest: Start harvesting when they reach the size diameter you like. When planting in the fall, be sure to dig up any remaining carrots before a winter freeze goes down into the soil. This could cause the carrots to crack and spoil.

[Carrot Information](#)

The carrot is of the parsley family which includes about 2,500 species such as dill, caraway, coriander, fennel, anise, parsley, parsnip, and celery. The cultivated carrot belongs to the genus *Daucus* L. which contains many wild forms. These grow mostly in the Mediterranean areas and in Southwest Asia, but some representatives are found in tropical Africa, Australia, New Zealand and the American continents.

The cultivated carrot is a biennial plant that normally requires two growing seasons with a cool rest period between them. This will complete its life cycle from the planting of seed to the maturing of seed. However, in a single season (60 to 90 days depending on the variety and growing conditions) the carrot "root" is produced in suitable size for marketing. The carrot root not only anchors the plant and absorbs nutrients from the soil but acts as a storage depot for carbohydrates, especially starch and sugar.

Climate

Carrots grow best at mean temperatures between 60 and 70 F. During hot, bright, sunny days young plants may be badly injured or killed by the high temperatures that develop at or just below the soil surface. Prolonged hot weather later in the development of the plants may not only retard growth and depress yield, but may cause undesirable strong flavor and coarseness in the roots. Temperatures much below 50 F tend to make the roots longer, more slender, and paler in color than is typical.

Quality

Carrots for fresh market are generally harvested before reaching full maturity and are shipped immediately. Fresh-market carrots should have the following qualities:

- long (9 inches plus), slender, smooth, with small-diameter necks
- uniform deep orange or gold color (including the core)
- mild, sweet flavor
- vigorous, blight-resistant leaves
- high percentage of usable yield

Fresh-market carrots are more tender, milder in flavor and brighter in external color than carrots which are harvested for processing. The fresh-market carrots are especially good for carrot sticks while processing carrots are good for cooking and shredding. Wilted, flabby, soft, shriveled carrots or carrots with large green areas at the top are undesirable.

Varieties

Several hundred varieties exist, but carrots are sold more by shape and type than by variety. There are four main types of carrots:

Imperator -- long (9-10 inches), small shoulders, tapered tip; used primarily for fresh pack.

Nantes -- medium length (6 inches), uniform diameter, blunt tip; used for bunching, slicing, and mini carrots. They have good eating quality and are especially suited for local sales. They normally mature earlier than *Imperator* types.

Danvers -- large, medium long (7 inches), processing type; used for dicing and slicing. They require a long season (120 days) to develop tonnage and high sugar content.

Chantenay -- large shoulders, short (5 inches), usually with a large, distinctly colored core; used for dicing. These are older cultivars and usually not of the quality required by processors. They are now used primarily by home gardeners.

Seed Companies

Three midwestern seed companies were contacted regarding common varieties of carrot seed purchased and price quotes for these varieties. Green Barn Seed Company located in Deep Haven, Minn., said that the *Danvers 126* carrot is a good seller for dehydration. The price is \$2.70 for 4 ounces, \$9.00 for one pound and \$7.50 per pound for 20 pounds or more. The hybrids *Dominator* and *Prospector* are the most common fresh-market carrots, sold at a price of \$.235 and \$.17 per pound for 20 pounds or more seed purchased, respectively.

Jung Seed Company in Randolph, Wis., said that the *Red Cored Chantenay* is a popular seller for dehydration. The price for .5 ounce is \$1.45 or one pound for \$11.75. The hybrid *Lucky B* sells best at a price of \$54.95 for one pound. Jordan Seeds in Woodbury, Minn., said it sells varieties for the fresh market, and the most popular seller is *Nance* which sells for \$6.50 per pound.

Soil Requirements and Tillage

Deep sandy loams and muck soils are most desirable for carrot culture. Such soils are among the easiest

to work and permit good development of the edible roots. Silt loams are also extensively used. In irrigated districts where moisture can be accurately controlled, silt loams and even clay loams produce high quality yields of carrots. These heavy soils are not recommended in nonirrigated areas where soil moisture is not subject to precise control. Growing carrots on heavy soils is more difficult than on light ones, even when soil moisture is controlled. Cloddy, stony, trashy or very shallow soils are undesirable. Carrots do well in soils of pH 5.5 to 6.8, but tolerance of slight alkalinity applies only to native western soils.

Carrot roots are very sensitive to soil compaction. Rows next to the wheel track often have more forked and stubbed carrots than rows in the center of a bed, and usable yields are reduced. Therefore, limit movement of equipment in fields as much as possible. During the first three weeks of growth, stay off the field completely.

Some farmers grow carrots on raised beds. This allows the soil to drain better and warm sooner in the spring. It is of most benefit on heavy and poorly drained soils.

Fertilizer

A good nutrition program maintains moderate to high nutrient levels in the soil with annual additions of fertilizer based on a soil test. Soil should be tested at least every two to three years. Nitrogen does not accumulate in soil over time, so it should be applied annually. For an approximate yield goal of 350 hundredweight per acre, on medium soil organic matter level, 100 pounds of nitrogen per acre is recommended. The suggested method of application is to broadcast half and then sidedress half when plants are established. Phosphorus levels in Cass County are 10 parts per million (using the Olsen test), which translates to needing to apply 100 pounds per acre of phosphorus. Potassium levels in Cass County are 278 parts per million, which indicate that no additional potassium needs to be applied. Applying large amounts of potassium at one time may decrease quality.

Seeding Carrots

Plant carrots with a vegetable seeder equipped with a 2- or 3-inch scatter shoe or multiple-row shoe. The row should not be more than 4 inches wide because of difficulties passing the leaves through the harvester. Plant enough seed to obtain about 24 live seeds per foot of row for fresh-market carrots and 16 to 18 seeds for Danvers-type processing carrots.

Rows should be at least 15 to 20 inches apart. Closer spacing makes harvesting difficult and prevents air movement through the leaf canopy, which may result in increased blight infection. Plant carrot seeds 1/8

to 1/4 inch deep into moist soil. If soil is dry, irrigate the fields immediately after seeding. If irrigation is not available, plant seeds 3/8 to 1/2 inch deep. Make sure the seed is pressed firmly into the soil to obtain good soil to seed contact.

Approximately 2 to 3 pounds of carrot seed are needed per acre for fresh market cultivars and 1 to 2 pounds for processing cultivars. Always plant according to desired plant stand count, taking into consideration the germination rate and number of seeds per pound.

Rye or barley strips are often planted between every three to six rows of carrots to protect young carrots from wind damage. Remove windbreak strips when carrots are 4 to 5 inches high, either with herbicides or by tilling.

Harvesting

Fresh-market carrot harvest can begin in August and extends into mid-October. Carrots are mechanically harvested by undercutting the roots and elevating them out of the soil and into the machine by grasping the leaves. Thus, it is important to maintain healthy leaves until the carrots are harvested.

Handle carrots as carefully as possible after harvest to avoid damaging the roots. Injuries reduce shelf life and increase chances of decay. Fresh-market carrots are especially susceptible to injury because they are harvested before maturity to obtain the desired market-size roots. Fresh-market carrots can be stored for four to six weeks if held at 32 F and 95 percent to 99 percent relative humidity.

Harvest of processing carrots usually begins about September and extends into November. Because processing carrots are harvested when they are mature, they are less susceptible to injury and can be stored for four to five months under proper conditions (32 F and 95 percent to 99 percent relative humidity). Remove excess soil and rotten carrots, but do not wash carrots before storing them.

Insect Pests

Aster leafhoppers, green peach aphids and wireworms are the main insects that affect carrots.

The aster leafhoppers are the most important insect pest to be concerned about. The leafhoppers do no direct damage to carrots, but transmit aster yellows to carrots, celery, lettuce and weeds such as wild carrot, mare's tail (horseweed) and pineappleweed. Aster yellows is caused by a mycoplasma-like organism and can be controlled only by controlling the leafhopper and the weed hosts.

The adult aster leafhopper is light gray-green, is 1/8 inch long and is an active flier. The leafhopper overwinters in the egg stage on grasses and weeds and may also migrate from warmer regions.

Check fields for leafhoppers at least one or two times per week and treat if numbers exceed five to 10 per 100 sweeps with an insect net. Different varieties of carrots have different tolerances to aster leafhopper disease.

Green peach aphids are pests of many vegetable crops. Damage to carrots is less serious than to other crops because carrots are not subject to virus diseases and the aphids do not cause contamination problems as they do in leafy crops.

The green peach aphid adults are yellowish green and 1/16 inch long; the winged adults are black with green markings. They overwinter as eggs on peaches and other stone fruits and migrate to carrots in early summer. Aphid populations build rapidly, especially during warm, dry weather.

Check fields for aphids regularly and treat if necessary. Avoid excessive spraying because extremely high populations are often found in fields that are heavily sprayed with insecticides and fungicides. The aphids may develop resistance to insecticides and flourish where all natural enemies (insect predators, parasitoids and fungal diseases) have been eliminated.

Wireworms are sometimes a problem in fields that recently have been planted with sod or have had grassy weed problems. Adult wireworms (click beetles) are attracted to grassy weeds for egg laying, and the larvae live in the soil for two years, feeding on plant roots, including carrots.

Where wireworms are observed during tillage or where problems are suspected, treat with a soil insecticide before planting. It is not recommended to seed carrots into fields that have been sod up to two years previously.

Diseases

Alternaria leaf spot and Cercospora leaf spot cause similar symptoms on leaves and are difficult to distinguish in the field. Spots on leaves have a dark center surrounded by a yellow margin. The leaves curl when lesions appear on the edges of leaf segments. Both of these diseases can be controlled by regular applications of fungicides.

Storage rots are caused by a number of organisms. The most common is crater rot. To avoid storage rots, cool the carrots after harvest as quickly as possible to 32 F. Avoid mechanical damage to roots during harvest. Do not try to store carrots from poorly drained fields or fields that have suffered excess water damage during the growing season.

Weeds

Annual grasses and broadleaf weeds are the major weed pests in carrots. Most can be controlled with herbicides currently registered for use on carrots. However, a few resistant weeds are becoming serious problems. Mare's tail, pineappleweed and groundsel are somewhat resistant.

A good weed control program includes both pre- and post-emergence application of herbicides, crop rotation and cultivation.

Nematodes

Nematodes are parasites that live in the soil. They have not caused problems in North Dakota or Minnesota but have created problems in other vegetable producing states, such as Michigan. Northern root-knot, carrot cyst, root-lesion and pin nematodes are the most common parasites. The problem is especially severe in fields where carrots are grown continuously.

Soil fumigation has been the most effective means of nematode control in carrot production. If nematode problems are suspected, have soil and roots tested for nematodes.

Economics

**Production coefficients for producing
onions in the Southern Red River Valley,
North Dakota, 1993.**

Selling price (\$/ton)	\$50
Market yield (tons/acre)	15
Seeding rate (lbs/acre)	2
Seed cost (\$/lb)	\$10
Land value (\$/acre)	\$757
Debt-to-equity ratio	.34
Interest rate on debt capital (%)	9.5
Interest rate on equity capital (%)	5.5

Herbicide (\$/acre)	\$60.41
Nitrogen per acre (lbs)	50
Phosphorus per acre (lbs)	100
Trace minerals per acre (lbs)	1
Nitrogen cost (\$/lb)	\$0.113
Phosphorus cost (\$/lb)	\$0.18
Trace minerals (\$/lb)	\$13
Transportation (miles one way)	150

Economic and cash flow budgets for processed carrot production in the Southern Red River Valley, North Dakota, 1993.

	Profitability	Cash Flow
	----- \$/acre	----
Gross Return	\$750.00	\$750.00
Variable Costs		
Seed	\$20.00	\$20.00
Herbicide	60.41	60.41
Fertilizer	36.65	36.65
Fuel and lubrication	98.31	98.31
Repairs	40.36	40.36
Operating interest	12.15	12.15
Total Variable Costs	\$267.88	\$267.88
Fixed Costs		
Miscellaneous overhead	\$33.83	\$16.15
Machinery depreciation	108.67	xx.xx
Machinery investment	74.82	146.88
Land taxes	6.31	6.31
Land ownership	49.01	25.05
Total Fixed Costs	\$272.65	194.39
Total Listed Costs	\$540.53	\$462.27
Return over variable costs	\$482.12	\$482.12
Return to owner labor and management	\$209.47	xx.xx
Cash flow		
(debt service, family living)	xx.xx	\$287.73

*The **economic budget** is generated by charging market rates for all resources needed for production. It helps answer the question "Is this enterprise profitable?" The bottom line represents a return to labor and management.*

*The **cash flow budget** is an estimate of the out-of-pocket cash needed to run the enterprise, including not only direct costs but indirect cash costs such as principle and interest payments, insurance and taxes. It helps answer the question "Can I meet my cash obligations if I go into this enterprise?" Total cash expenses are subtracted from total cash receipts to calculate the net cash which is available for family living and other needs.*

Marketing

Carrots are a featured item in grocery store advertisements when supplies are good in quantity and quality. The best market seems to be in the winter months when used in stews and soups. Carrots need to be refrigerated and kept moist to keep from wilting.

Historical fresh-market grower prices from 1970 to 1991 indicate that the highest prices are received in December, January and February (\$7.00/hundredweight to \$21.00/hundredweight) with an average of \$10.70/hundredweight. Fresh market retail prices during the same time period ranged from \$.21 per pound to \$.52 per pound with an average of \$.29 per pound. Fresh-market carrots are usually packed in 1-, 2-, 3- or 5- pound plastic bags and then packed in 48- or 50-pound master bags.

Minnesota Dehydrated Carrot in Fosston, Minn. processes carrots for the human consumption market. The top-grade processed carrots are sold mainly to canning/soup companies, to be used in soups and stews. Also, the military buys a large portion of the dehydrated carrots to use in their Meals Ready to Eat (MRE) packages. The cull carrots are sold to be used in dog food.

United States Production Area

In 1991, California harvested the largest amount of carrots -- 56,000 acres. Florida followed with 9,000 acres, Texas and Michigan each harvested 6,800 acres and Texas harvested 6,300 acres. Minnesota harvested 1,800 acres. This acreage corresponds to a total of 1.6 billion pounds in California, 340 million pounds in Texas and 170 million pounds in Michigan.

Harvested acreage of fresh-market carrots were 77,570 acres in 1970. Acreage fluctuated up and down, peaked in 1989 at 101,900 acres and fell to 97,300 acres in 1991. This acreage corresponds to a yield of

1.1 billion pounds in 1970 and 1.9 billion pounds in 1991. The value of production for the fresh market was \$55.8 million in 1970 and increased to \$281.1 million by 1991. The average United States yield of fresh-market and processing carrots in 1989-1991 was 293 hundredweight per acre.

California, Washington, Michigan and Texas rank the highest in tons of processing vegetables produced in the United States from 1989-1991.

United States per capita use of carrots has increased from 10.4 pounds farm-weight in 1972 to 11.2 pounds in 1991. Of that total, the proportion of fresh, canning and freezing was 63, 10 and 27 percent, respectively, in 1972. The ratio changed in 1992 to 66, 9 and 25 percent, respectively.

United States cash receipts of carrots were \$70.2 million in 1970 and rose to \$273 million in 1990.

North Dakota Production

According to a survey of vegetable growers in the state which was presented to the North Dakota Agricultural Products Utilization Commission, there are 243 carrot acres in North Dakota. Cass County leads production with 230 acres, followed by six acres in Traill, four acres in Sargent, two acres in Burleigh, half an acre in Mountrail and Morton Counties, and two-fifths of an acre in Barnes County.

Imports

The U.S. imported 56 million pounds of carrots in 1970. The amount of imported carrots fluctuated but peaked in 1984 at 161 million pounds and at 137 million pounds in 1991. The imports average 6.2 percent of the total supply of fresh carrots in the United States.

Exports

United States exports were 51 million pounds in 1970 and peaked at 179 million pounds in 1991. The exports average 7.7 percent of the total use of fresh carrots in the United States.

For more information regarding seed companies contact:

The carrot is of the parsley family which includes about 2

Green Barn Seed Company

18855 Park Avenue, Deep Haven, MN 55391

#1-800-882-7552

Jordan Seeds

6400 Upper Aston Road, Woodbury, MN 55125

#612-738-3422

Jung Seed Company

Randolph, MN 53957

#414-326-3121

Onion is a root vegetable that is a staple part of many modern recipes. The vegetable is grown from seed in about three months. They grow best in pH from 5.5 to 7.0. They are planted 100 seeds per tub, and then thinned for food when they reach 6" in height. The onions remaining in the tub continue to grow when allowed the space.

Full grown onions will keep in the tub through the winter if their tops stay green. When the tops start to die fold the leaves back, let them dry, then harvest the onions. Onions will also keep for several months if left in a dark, cooler place. The tops can be braided into a bunch and stored by hanging in the kitchen or pantry. The tops should be completely withered or dried before the crop is stored.

Replanting from sets. Onions are also sold as immature bulbs that can be grown by replanting. The sets should be planted with the wider part of bulb set in soil and only the tip of the bulb showing above the media. Sets will be ready for harvest in about 2 months.

Onions are first grown with grow nutrient until they reach about 6" tall, and then should be switched to root nutrient. After they are switched to root the root should grow more than the top green growth. If the green parts start to fade in color before the onions have grown to full size, then add a bit of calcium nitrate to the water at 1/8 teaspoon per gallon.

When thinning onions, the final amount to leave in the tub depends upon the size of a mature onion. Walla Walla onions reach 6" in diameter in hydroponics and so only about 8 will fit in a tub. However, most onions are smaller and harvested sooner, so tub averages are about 20 to 40 onions raised to maturity.

Occasionally onions can bolt, or go to seed. This usually occurs in low nitrogen conditions or in high heat. If this is noticed right away, the bolting stem can be cut off and the plant may stay in root growth.

Onion flavors can be quite hot in hydroponic culture. The flavors of onions are very dependent upon onion type, and chefs usually use several types of onion in their cuisine. Most modern hybrid plants are designed to look nice and keep well, but not necessarily for flavor. Some of the better flavored onions are the heirloom varieties, or old fashioned varieties. There are also many varieties worldwide, and these international varieties often have high flavor.

Flavor will be improved when the onions are allowed to mature in the media. Onions hold their flavor through storage if they are properly dried.

Nutrients also affect flavor, and at this point you can experiment to find the best flavor recipes for onions. Nutrient can be reduced a few days before the final onions are harvested. When the final water provided for the maturing onions (one week before harvest) is pure filtered water, it will improve the final; flavor of the onion.

Trace mineral supplements should be added to the water of the onions as they ripen.

The flavor could be flat because of a high pH in the water. We add vinegar to the onion water to keep the pH at about 6.0 to 6.2. This can help add bite to the onion.

Also, onions are grown on grow nutrient until they are 6" tall and then switched to root nutrient.

Onion problems

Insects - Onions seldom get insect attacks, and are used in crops to repel insects.

Molds and mildew - onions can get molds and mildew. Often the mold around the root is caused by excess moisture too close to the root. This can be remedied by making sure the water table is lower in the tub, or pouring nutrient in a place in the tub where it does not wet the roots. Also, mildew can build up in onions because of stale air, and so good air ventilation will help reduce mildew build up.

USING CO2 SUCCESSFULLY

Carbon Dioxide (CO₂) is a colorless, odorless gas that is found in small quantities in the air, and is essential for plant life, without it plants could not survive.

Carbon dioxide is absorbed by the plants and during photosynthesis the CO₂ is split into its basic elements, carbon and oxygen. Small amounts of oxygen are used by the plant but most of the oxygen are released back into the atmosphere. The carbon is combined with water (H₂O) in the presence of light to form a sugar molecule. The plants then convert the sugar into carbohydrates. When the plant absorbs nutrients (primarily nitrogen from the roots) they are combined with the carbohydrates to form new plant tissue. This process is called photosynthesis. The entire process is only as good as its weakest link. If any of the required ingredients (light, CO₂, water and nutrients) are at a level below that which the plant can use for maximum efficiency, the plant will not perform at its full potential. In other words, if you inject CO₂ into a system that is not receiving enough light or nutrients the results will be disappointing. We here at Hydro-U recommend that CO₂ injection should only be done by experienced gardeners with a good working knowledge of their gardening system. Once a gardener is comfortable with the workings of their system and plant growth, CO₂ can be a great benefit, however there are a lot of variables involved with using CO₂ and beginners can really have their hands full, increasing the likelihood of a disaster (like total death of the entire crop).

There are several conditions that must be met for the plants to be able to use the increased CO₂ levels properly. The most important is lighting. Light levels must be very high (more than 20 watts per square foot) or there will be little or no increase in plant growth rates. The plants will like slightly higher temperatures than normal (approx. 3 - 5 degrees higher). The plants will also metabolize water and nutrients faster, so reservoirs may need a little more attention.

Plants can absorb and process very large amounts of CO₂. There is usually about 300 to 600 p.p.m. (parts per million) of CO₂ in the atmosphere. Most plants can use 1500 p.p.m. in optimum growing conditions. When using elevated levels of CO₂ the growth rate can be increased by as much as 100% to 200%. Most studies report increases in the 40% to 50% range.

The ideal situation would be to keep the CO₂ levels at optimum at all times. This would require constant injection of low levels of gas (constantly replacing what the plants are using). This is not practical in most situations as venting of the growing environment is often needed to control heat build up. In these cases CO₂ injection should be done immediately following venting.

The biggest problem that people encounter when using CO₂ is that they get carried away, they think that a little is good so a lot is better...**NOT!** When CO₂ levels approach 2000 p.p.m. most plants will die. High levels of CO₂ are also toxic to humans, primarily due to oxygen deficiency. Before injecting CO₂

the room should be vented to remove excess CO2 that might be left over from the previous injection, this prevents the build up of CO2 that could harm the plants.

There are several ways to get extra CO2, the two most common are using bottled CO2 and using CO2 generators. These are the automated ways to add CO2 to the growing environment. Getting precise control of the CO2 levels in your growing environment can be rather expensive, CO2 monitors are the best method, these monitors keep a constant reading of the C levels and automatically adds gas when needed. These monitors are fairly expensive so most people opt for a more inexpensive method (like timers).

There are also several "low-tech" ways to increase CO2 levels. Additional information about using all these methods follows:

Using Bottled CO2

There are several ways to introduce CO2 into the growing environment. Probably the most popular method is to use bottled gas. This type of CO2 injection consists of a CO2 tank, a pressure gauge (monitors how much gas is remaining in the tank), a flow meter (to monitor the amount of gas being released), a solenoid valve (turns the flow of gas on and off as needed) and a method of controlling the solenoid valve (a timer or other controller).

To insure that your garden is receiving enough (but not too much) CO2 from your bottled system, I have included the following charts (see below) that can be easily followed to determine how long you need to emit gas to bring the CO2 levels up to 1000 (first chart) p.p.m. or 1500 p.p.m. (second chart). Charts are supplied by Green Air Products.

Carbon Dioxide Flow Chart for Emitter Systems					
1000 PPM	(B) Flow in Cu. Ft. / Hr.				
(A) Cu.Ft.of Area	10	15	20	25 *	30 *
	(C) Time (in minutes)				
400	2.4	1.6	1.2	0.9	0.8
600	3.6	2.4	1.8	1.4	1.2
800	4.8	3.2	2.4	1.9	1.6
1000	6.0	4.0	3.0	2.4	2.0
1200	7.2	4.8	3.6	2.9	2.4
1400	8.4	5.6	4.2	3.4	2.8
1600	9.6	6.4	4.8	3.8	3.2

1800	10.8	7.2	5.4	4.3	3.6
2000	13.0	8.0	6.0	4.8	4.0

- A. The cubic feet of the enclosure is determined by the formula (L x W x H).
- B. Rate of flow as stated on the emitter regulator.
- C. The time required to charge the enclosure expressed in minutes.

* NOTE: It has been my experience that if you set the flow meter up above 20 Cu Ft / Hr it can literally freeze up due to the cold created by the expanding gas. It is best to inject the gas slower over a longer time. -The Professor

Carbon Dioxide Flow Chart for Emitter Systems					
1500 PPM	(B) Flow in Cu. Ft. / Hr.				
(A) Cu.Ft.of Area	10	15	20	25 *	30 *
	(C) Time (in minutes)				
400	3.6	2.4	1.8	1.4	1.2
600	5.4	3.6	2.7	2.1	1.8
800	7.2	4.8	3.6	2.9	2.4
1000	9.0	6.0	4.5	3.6	3.0
1200	10.8	7.2	5.4	4.4	3.6
1400	12.6	8.4	6.3	5.1	4.2
1600	14.4	9.6	7.2	5.7	4.8
1800	16.2	10.8	8.1	6.5	5.4
2000	19.5	12.0	9.0	7.2	6.0

- A. The cubic feet of the enclosure is determined by the formula (L x W x H).
- B. Rate of flow as stated on the emitter regulator.
- C. The time required to charge the enclosure expressed in minutes.

* NOTE: It has been my experience that if you set the flow meter up above 20 Cu Ft / Hr it can literally freeze up due to the cold created by the expanding gas. It is best to inject the gas slower over a longer time. -The Professor

Using CO2 Generators

Until recently CO₂ generators were used primarily by commercial growers, but with the advent of smaller, less expensive units, many hobby growers now use generators. CO₂ generators burn either propane or natural gas. They have a pilot light that ignites the gas when a timer has opened a solenoid valve to release the gas into the system (similar to a gas bar-b-que grill). The generators come in many different sizes.

Producing CO₂ with a generator is more cost effective than using bottled CO₂. The generators can produce approx. 26.1 cu. ft. of CO₂ per pound of fuel burned.

The generators work very well and are cheaper to operate than the bottled system, however, they burn the fuel so they give off a lot of heat as well as CO₂. This may or may not be a problem for you. If you live in a colder climate and you need to add heat to your growing environment than a generator might be just what you need. If you live in a warmer climate you may already be battling the heat and adding more might send you over the top. With devastating effects on your crop.

Another word of caution about CO₂ generators: If they are not working properly they can give off Carbon Monoxide (CO) instead of Carbon Dioxide (CO₂). **Carbon Monoxide is very dangerous!** It is deadly even in small doses (CO₂ is deadly too, but only in higher concentrations). You should only use top quality generators that have been built specifically for gardening and have been checked out by the manufacturer. When using generators make sure that the flame is burning blue, this means that there is complete combustion and the generator is putting out CO₂ and not CO. If the flame is burning yellow or orange there is a problem with the unit. **Turn it off immediately and do not use the generator until a qualified service person has fixed it!** Yellow or orange flames mean that the combustion is not complete and the main by product will be Carbon Monoxide instead of Carbon Dioxide.

OTHER METHODS OF ADDING CO₂

There are several ways to add CO₂ to your garden that do not require a lot of expensive equipment. These are not automated so require more "hands-on" attention. Controlling the amount of CO₂ is difficult at best with these methods, however there is little chance of accidentally adding too much CO₂.

Decomposing organic matter gives off CO₂ as a normal bi-product of decomposition. Use materials like leaves, sawdust, manure, hay, etc. This method of generating CO₂ is certainly inexpensive, with most materials being free, but it can be kind of gross. Besides being messy there is a possibility of disease and fungus forming in the decomposing material.

The fermentation process also gives off CO₂ as part of the natural process (that's what puts the fizz in beer). Mixing water, sugar and yeast together will cause fermentation to begin and for CO₂ to be generated.

Dry ice is solid CO₂ that is made by compressing the gas until it "freezes" into a solid mass. CO₂ is a rather unique substance in that it goes directly from a solid to a gas, which means that you can simply set a block of dry ice in your growing environment and it will slowly "boil" off CO₂ gas. Dry ice is probably one of the most expensive ways to produce CO₂ in your garden.

One pound of dry ice is equal to one pound of liquid CO₂ (bottled). One Pound of either is equal to 8.7 cu. ft. of gas.

If you drip vinegar onto backing soda you will produce CO₂ as well.

ADDITIONAL INFORMATION

If you would like to know more about using C in your garden there is an excellent book about it called "Gardening Indoors With CO₂" by George Van Patten.

There is a lot of good information about CO₂ equipment as well as other environmental controllers available at the following link. which is the website for GreenAir Products, which manufactures what most people consider the finest environmental controllers available for hobby gardeners.

Most Common Problems.

[Pests.](#)

These are the most common problems people encounter growing hydroponically:

Yellowing bottom leaves/older growth

The Nitrogen story:

Nitrogen is a transferable element (this means the plant can move it around as needed). If a plant is not receiving enough Nitrogen from the roots then it will rob Nitrogen from the older growth. In Hydroponics, usually the pH is too high and has locked out the available Nitrogen. Always check the pH before increasing nutrient level.

Save the plant: Leach! Check the pH, and adjust if necessary to 5.8 - 6.3. Check and maintain nutrient level. You may foliar feed (spray) with a pinch of CaNO₃ (Calcium Nitrate) in a Litre of pH balanced water for quick results.

Leaf tips curl up

This is usually a Magnesium deficiency caused by a too low pH level.

Save the plant: Leach, check and adjust the pH level. You also may foliar feed (spray) with a pinch of MgSO₄ (Magnesium Sulphate) in a Litre of pH balanced water for quick results.

Leaf tips curl under / leaf tip burn (browning)

The Nutrient level is too high.

Save the plant: Leach and decrease the nutrient level.

Leaching

Leaching should be done at every reservoir change and before countering any problem. This will rid the medium and root zone of toxic salt build up.

To leach, rinse the root zone with straight pH balanced water.

Use twice as much liquid as the hydroponic container would have held when empty.

Pests.

Almond Moth	Drosophila Fly	Midge
American Cockroach	Drugstore Beetle	Millipede
American Dog Tick	Drugstore Beetle (larvae)	Mimosa Webworm
Angoumois Grain Moth	Ear Mite	Mite
Ant	Earwig	Mosquito
Aphid	Elm Spanworm	Moth
Armyworm	Face Fly	Mud Dauber Wasp
Asparagus Beetle	Fall Webworm	Mushroom Fly
Aster Beetle	Fern Scale	Northern Fowl Mite
Bagworm	Firebrat	Oakworm
Bean Aphid	Fireworm	Oleander Scale
Bed Bug	Flat Grain Beetle	Oriental Cockroach
Bee	Flea	Palmetto Bug
Beetle	Flea (egg)	Parasitic Chalcid
Biting Fly	Flea (larvae)	Pear Psylla
Biting Midge	Flea Beetle	Pear Sawfly
Black Fly	Flour Beetle	Pharaoh Ant
Blister Beetle	Flour Beetle (larvae)	Pine Butterfly
Blister Mite	Flower Thrips	Plant Bug
Booklouse	Fly	Potato Beetle
Boxelder Bug	Flying Insect	Potato Leafhopper
Branbug	Flying Moth	Pre-adult Flea
Brownbanded Cockroach	Food Moth	Psocid
Brown Dog Tick	Fruit Fly	Psyllid
Brown Soft Scale	Fruittree Leafroller	Red Flour Beetle
Budworm	Gall Midge	Redhumped Caterpillar
Bug	German Cockroach	Rice Weevil
Cabbage Bug	Gnat	Rose Chafer
Cabbage Looper	Grain Beetle	Rose Chafer (larvae)
Cabbageworm	Grain Insect	Rose Slug
Cadelle	Grain Mite	Roseslug
Cankerworm	Grain Moth	Rusty Grain Beetle
Carpenter Ant	Granary Weevil	Saddleback Caterpillar
Carpet Beetle	Granary Weevil (larvae)	Sawfly
Carpet Beetle (egg)	Grape Leafhopper	Sawtoothed Grain Beetle
Carpet Beetle (larvae)	Greenhouse Thrips	Scale
Carrot Rust Fly	Green Peach Aphid	Scorpion
Caterpillar	Gypsy Moth	Sheep Ked
Cat Flea	Gypsy Moth (larvae)	Silverfish
Cat Flea (pupae)	Harlequin Bug	Skipper
Centipede	Heliothis Sp.	Sowbug
Cheese Mite	Hornet	Spider
Cheese Skipper	Horn Fly	Spider Beetle
Cherry Climbing Cutworm	Hornworm	Spider Mite
Chewing Insect	Horse Fly	Spotted Cucumber Beetle
Chewing Louse	House Fly	Spruce Budworm
Chicken Mite	Humpbacked Fly	Stable Fly

Chigger Mite	Imported Cabbageworm	Stink Bug
Cigarette Beetle	Inch Worm	Stored Product Insect
Climbing Cutworm	Indianmeal Moth	Striped Cucumber Beetle
Clothes Moth	Indianmesit Moth (exposed)	Sucking Insect
Clover Mite	Indianmeal Moth (larvae)	Sucking Louse
Cluster Fly	Insect	Tabanid
Cockroach	Jack Pine Budworm	Tarnished Plant Bug
Colorado Potato Beetle	Japanese Beetle	Tent Caterpillar
Common Cattle Grub	Lace Bug	Thrips
Confused Flour Beetle	Leafhopper	Tick
Corn Earworm	Leafminer	Tick, Deer
Cranberry Fireworm	Leafroller	Tick, Lime Disease
Cricket	Leaftier	Tobacco Budworm
Cross Stripped Cabbageworm	Lesser Grain Borer	Tobacco Moth
Cucumber Beetle	Lesser Mealworm	Tobacco Moth (larvae)
Cutworm	Looper	Tomato Hornworm
Darkling Beetle	Louse	Twospotted Spider Mite
Darkwinged Fungus Gnat	Louse (egg)	Vinegar Fly (complex)
Deer Fly	Maggot	Wasp
Dermeitid Beetle	Meal Moth	Waterbug
Diamondback Caterpillar	Meal Moth (larvae)	Webworm
Diamondback Moth	Mealworm	Weevil
Diamondback Moth (larvae)	Mealybug	Western Spruce Budworm
Dog Flea	Mediterranean Flour Moth	Whitefly
Dog Flea (pupae)	Merchant Grain Beetle	Wood Tick
Douglas Fir Moth	Mexican Bean Beetle	Yellowjacket
Driedfruit Beetle	Mexican Bean Beetle (larvae)	Yellow Mealworm

[Aphids](#), [Cabbage loopers](#), [Cutworms](#), [Flea beetles](#), [Leafminers](#), [Slugs](#), and [Snails](#).

Aphids:



Photo courtesy of University of Nebraska, Dept of Entomology

Aphids or Plant lice are most commonly green; however some species are black, pink, or yellow. They are small (only 2 tenths inch) soft-bodied insects, and some have wings. Clusters of aphids are commonly found on peas or on new green growth. They damage plants by sucking the sap out of the stems, curling and yellowing the leaves. While feeding they can inject poisonous saliva or organisms which can cause diseases. The insect secretes a liquid called honeydew which can grow mold fungus.

The cabbage aphid, *Brevicoryne brassicae*, is a small green aphid that feeds mainly on the brassica vegetables (mustard, cabbage, brussels sprouts).

The green peach aphid, *Myzus persicae*, is a lighter colored insect which feeds on over 300 species of plants.

Chemical Controls:

Diazinon, Malathion, or Thiodan insecticides are commonly used in gardens to control aphids. However, chemical poisons should never be used in hydroponic gardens where the products are food.

Hydroponic culture is different than soil culture, and chemicals may respond differently.

The first way to control aphids is to prevent them from coming into the garden.

Several things can be done to protect your food.

1) Growers can be placed above the ground and protected by wrapping any supports or feet with a sticky

tape or something like tanglefoot. This sets up a barrier to crawling insects, and they cannot get on your plants.

2) Yellow sticky cards can be placed about 1 foot above the crops. The cards will trap flying insects before they reach the crops.

3) Plants can be lightly sprayed with Prevent (nutrient water with a very small amount of Dr. Bonner's Peppermint Soap).

4) Plants can be inspected every day for any sign of aphids on stems or leaves. The younger aphids are often on the undersides of new green growth. Any aphids found can be squashed between fingers, or infected plants can be removed.

5) Walls or entryways to the growing area can be screened with insect barriers.

Beneficial Insects:

If the garden is isolated from the house or outside, there are three very good predators of aphids. They are ladybugs, lacewings, and wasp parasites. Beneficial parasites can be purchased and introduced to the garden.

Aphid information.

Aphids are actively spread from plant to plant by ants. Ants actually cultivate aphids and milk the aphids for their secreted honeydew. This behavior has fascinated scientists for centuries. Charles Darwin reportedly tried to duplicate the ants milking motions with a small brush, but was unsuccessful.

Aphids can reproduce by asexual production. A female can produce as many as 100 offspring without mating, and those offspring are all female. As my father would say, "What a revolting development".

If you ever see an aphid in your garden drop everything and handle the problem immediately. In my own experience, when aphids are left alone in a hydroponic garden, it will take about five days before they are completely out of control, and the whole garden will have to be destroyed.

Aphids are attracted to nitrogen rich and young plant parts. Their growth can be controlled to some extent by reducing nitrogen in the hydroponic nutrient. This option will also affect rapid plant growth.

What do do when aphids are spotted.

The first thing to do is to start inspecting the area around the spotted insect. Often where there is one aphid there will be many more. Look up and down the stem for any crawling aphids, and the under sides of leaves. Also look for young aphids, smaller and usually a lighter color than the adults.

If you have caught the infestation in the early stages, there may be only a few insects on the plant, and

they can be picked off and squashed between your fingers. If there are more than this it may be necessary to remove the plant.

Check the plants surrounding the area where the aphid was spotted. There may be other insects already colonizing new plants. If the aphid was introduced by an ant there may be many more scattered in the garden.

Remove any spotted aphids, if that is possible. If there are too many remove plants.

Once the extent of the damage has been evaluated and insects and infected plants removed, spray the entire garden with a nutrient spray mixed with Dr. Bonner's Peppermint soap.

Also look for any place where an ant can reach the garden, and reapply or reconstruct barriers. Also, make sure yellow sticky traps are well distributed in the garden.

Other impacts: Aphids can spread viruses and their honeydew can encourage sooty molds.

If you have an outside garden, there are several plants that attract aphid predators. Some are yarrow, wild buckwheat, white sweet clover, tansy, sweet fennel, sweet alyssum, spearmint, Queen Anne's lace, hairy vetch, flowering buckwheat, crimson clover, cowpeas, common knotweed and caraway.

Cabbage looper or Cabbage worm.

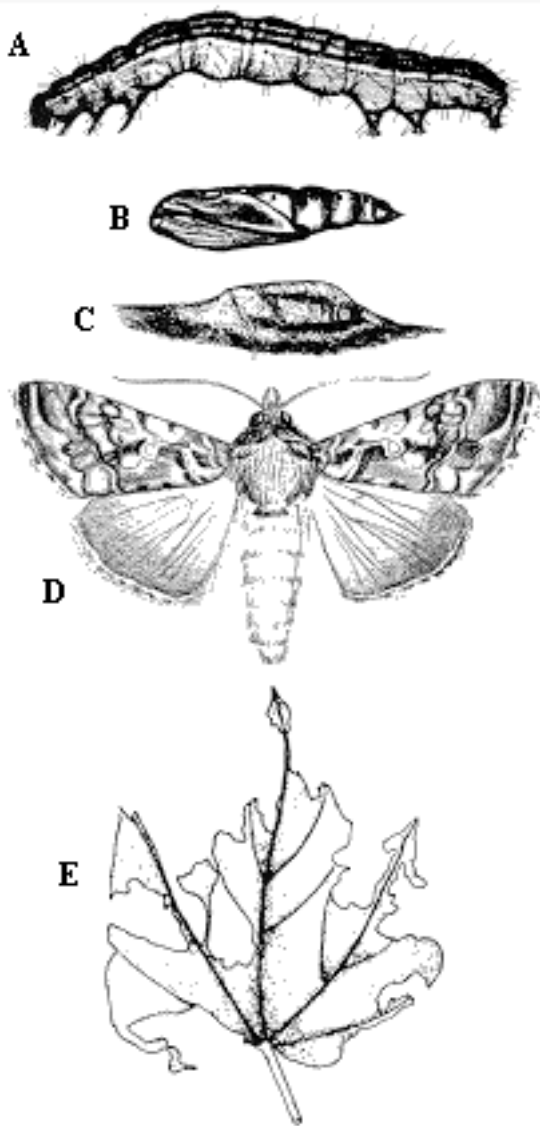

Cabbage looper. A, Larva. B, Pupa. C, Cocoon. D, Adult. E, Damage.

The Cabbage looper or Cabbage worm is a pale yellow, green, or brown caterpillar one inch in length. They often have light stripes going down the back and a yellow head. They chew large holes in leaves and eat their way into the heads of cabbage and collards type plants.

Host plants - The cabbage looper infests a large range of plants. Some cultivated hosts include: crucifers, cotton, potato, spinach, soybean, lettuce, celery, parsley, tomato, chrysanthemum, geranium, and carnation

Chemical Control: Use Diazinon, Malathion, or Sevin insecticides.

Organic Control: Use Bacillus Thuringiensis, or squash them by hand.

Cutworms.



Cutworms are dull colored gray, brown, or black caterpillars of night-flying moths. Some may have a few bristly hairs. They do most of their damage at night, hiding during the day curled up just below the top of the soil. The main destruction comes from the cutworms eating away at young plant's stems at soil level, basically chopping the plant down. Some varieties will climb the plant, feeding on leaves and fruit.

Several species are involved, but most injury is caused by those species that feed just above or just beneath the soil surface.

Cutworms spend the winter as partly to fully grown larvae in the soil or under trash or clumps of grass. They start feeding in the spring, continue growth until early summer, pupate in the soil, and emerge as moths during the summer.

The females each lay about 1,000 eggs on the ground or on foliage in grassy or weedy fields. After the eggs hatch, the young larvae feed on roots and foliage of grasses and weeds, hibernate, and attack whatever vegetation is present the following spring.

Chemical Control: Diazinon can be used prior to planting, tilling the soil two to three inches deep immediately.

Organic Control: Place a swivel stick right up next to young plants. That way the worm can not cut all the way around the base of the plant. Put a cardboard collar around the plant one inch deep or so. Scatter crushed egg shells or mulched oak leaves around the plants. Cultivating close to plants will help to destroy any worms just below the soil; and as usual, keeping a clean weed-free garden will deter the moth from laying its eggs in your garden.

Flea beetles.



This small (no more than one sixteenth of an inch) jumping beetle chews small round to irregular shaped holes in leaves, giving the appearance of the plants being peppered with fine shot.

Chemical Control: Use Sevin insecticide to get rid of the beetle.

Prevention: Keep garden clean. Also, interplanting with garlic or dusting with rotenone can aid in repelling it.

Leafminers.



Leafminers are small grub or caterpillars that tunnel their way through the upper and lower surfaces of plant leaves, eating leaf tissue as they go. This leads to either a blotchy or yellowish foliage color.

Chemical Control: Malathion gets rid of some types of leafminers.

Organic Control: Pick and burn the effected leaves.

Slugs.



Photo courtesy of University of Nebraska, Dept of Entomology

Slugs are gray to brown in color and some have spots. There are good slugs and there are bad slugs. Generally the good slugs live below the soil line and are carnivorous, feeding on wireworms, grubs, and other slugs. The good guys can be identified by a small shell on the end of their tail. The bad slugs on the other hand are above the ground creatures, preferring a vegetable diet. They feed on a variety of plants and leave a slimy little trail.

The traditional method is to purchase commercial slug baits, but there are several successful organic methods as well. Try pouring a small amount of beer in a shallow container, such as a saucer. The slug is attracted to the beer and drowns. Also, try cutting an orange in half and hulling it out. Lay this in the garden with a small stick underneath the orange to give the slug an entrance place under this cool shaded slug home. Check now and then to see if anyone has checked in and evict him...permanently. If you can't stand to crush the guy, then just sprinkle some salt on him. Salt and slugs don't mix. One last thing, mulch heavily with oak leaves. They don't like that

Though it is sometimes tough to keep in mind, slugs are not all bad.

"Most of the time slugs do beneficial things," said Jack DeAngelis, entomologist with the Oregon State University Extension Service. "They cycle organic matter, contributing to our rich soils. They are an important food source for other wildlife. But when they get into our gardens and landscape plantings, they can be quite damaging."

The northwest's maritime weather is perfect for slimy molluscs.

"The mild, damp climate west of the Cascade Mountains is ideal for slug development," he explained. "There are about 40 species of land slugs in the 48 contiguous states. In Oregon, there are about 10 pest species of slugs. Nine out of 10 of these pest species are exotic species, many accidentally introduced from somewhere else on imported vegetation or food. One pest species, the brown garden snail, was intentionally imported as a gourmet food item."

Slugs are hermaphrodites, DeAngelis said, that are all capable of laying eggs. "Most lay eggs in the soil, under leaves or wood in the late summer and fall until freezing," he pointed out. "Some lay again in the spring. Slug eggs will hatch in three to six weeks, depending on weather conditions and food supply."

Home gardens are Edens for slugs. Full of food, regularly watered with plenty of cover, the home landscape often provides the perfect place for slugs to feed, grow and reproduce. Telltale slime trails and scraped or rasped vegetation are sure signs of slug residence in your yard or garden. Slugs glide over a slime trail they produce. Their mouths hold a horn-like rasping organ, used to scrape plant tissues off into their digestive tract.

Year-round diligence is necessary to minimize the number of slugs in your yard. A balanced control program includes not only eliminating the slugs themselves, but also their food and hiding places.

DeAngelis offered some "least toxic" ways to reduce the slug populations in home gardens:

- Trap slugs under boards. Place scrap boards on the soil under plants and between garden rows.

Slugs seeking shelter under the boards can be collected each morning in a bucket containing soapy water.

- Drown slugs in beer. Slugs love yeasty odors. Take a coffee can or plastic yogurt container with a plastic snap-on lid. Cut a hole in it about a half to a third of the way up. Bury the can to the level of the hole. Pour about two inches of beer or yeasty water in the can or container. Cover to reduce evaporation and to keep out pets. Check and remove slugs daily and refill with solution.

- Use copper strips to blockade your garden patch. Copper barrier strips or screens are showing some promise as effective slug barriers. These materials are sold at lawn and garden stores.

Take care not to trap slugs inside your garden plot.

- Take advantage of slugs' natural enemies. Raccoons, opossums, snakes, mallard ducks, bantam chickens and some ground feeding wild birds feed on slugs.
- Eliminate yard debris. Mulches usually provide natural places for slugs to hide. Remove mowed or cut weeds, grass and spent perennials to help reduce slug refuges.
- Pick slugs off plants after dark when slugs are active. Dedicated slug slayers stalk their quarry by night with a head lamp or flashlight. Pick the slimy critters up (with tweezers if you prefer) and drop them into a jar of water with a little detergent or ammonia. Do not put salt on slugs, as adding salt to the soil makes it unsuitable for gardening.

Not the least toxic, but the easiest and most reliable method of slug control is placing poison slug bait around the garden, said DeAngelis. Metaldehyde is the most common active ingredient. Metaldehyde causes slugs to slime heavily, revealing their presence. Cereal-based metaldehyde baits tend to be more attractive to slugs.

"Be aware that poisoned slugs can recover from metaldehyde ingestion if they have access to sufficient water," he said. "Baits containing metaldehyde and carbaryl are considerably more effective, but are less common."

A third type of poison bait, containing methiocarb (Mesurol) is effective even under moist conditions, he said.

Follow label directions carefully when applying baits, he warned.

"Do not apply to crops to be eaten or those to be grazed by animals," cautioned DeAngelis. "Keep pets away. If pets have access to baits, substitute flaked baits or liquid for larger cereal chunk baits. Evening is the best time for application--just after a rain shower is best. Or apply bait on warm evenings after heavy watering. Late summer and early fall is a good time to bait because many slugs are about to begin egg laying."

Snails.



Snails are similar to slugs, but the main distinguishing feature is a large shell that they can draw up into if threatened. Snails come in a variety of colors including yellow, brown, gray, and black. They range in size from one fourth inch to a whopping ten inches long. The brown garden snail is one of the most destructive snails, feeding on young plants. Collecting snails in a bucket of salt water will exterminate the pest, along with all of the methods used for trapping slugs.

The Debate on "Organics" and "Hydroponics"

There is a huge popular debate about the value of "organic" fertilizers and methods, many people would like to apply "organics" to hydroponics. Currently accepted organic fertilizer components are dependent upon organisms in the soil to convert the "organic" materials into a useable form for plants.

In hydroponics we provide the minerals required for plant growth directly, completely eliminating the need for soil and soil-organisms. The result is much higher growth rates, yields and even crop quality than organic methods can achieve. This is not what some people want to hear, but it is the simple scientific truth - and practically all scientists and educators in the fields of agriculture and chemistry know it and will be the first to agree. In fact, the kinds of materials which are permitted for use under "organic" regulations are not of sufficient purity to be used for hydroponic culture.

We use only the most refined and pure ingredients to blend our hydroponic fertilizers, including food and pharmaceutical minerals. "Organic" regulations do not permit purified or refined ingredients to be used, all "organic" fertilizer ingredients must be in their natural, unrefined form - the result can be detrimental levels of impurities and toxins plus very poor solubility. "Organic" is a matter of bureaucratic definitions, not science. Organic is a method of farming, not a definition of the produce itself. There's no such thing as "organic produce," there's only "organically grown produce."

With this in mind it's important to recognize the reasons that "organically" grown produce is gaining such popularity. Consumers want to buy produce which is not tainted with hazardous chemicals or poisons. There is an increasing public demand for methods which are gentle on our delicate planet and which don't harm the soil, water or ecosystems. Hydroponic farming methods fit properly into this system of values if used appropriately. Hydroponics protects soil because it doesn't use soil. Less water is required for hydroponic culture and consequently more food can be cultivated with less water. The fertilizers we use for hydroponics are ultra-pure and leave no residue in the cultivated fruits and vegetables. Since hydroponic technologies are more efficient than soil methods, more people can be fed with less area and ecological impact.

THE ORGANIC HYDROPONIC DEBATE OPENING PANDORA'S BOX

As seen in the [Growing Edge Magazine](#)

During the 1980,s, Americans increasingly became more health-conscious. Cholesterol was ruled out and exercise became a part of our daily routines. Today this still holds true, but even more so. what we put into our bodies is carefully scrutinized, even our fruits and vegetables, which has made "organic a buzzword of the '90s. People are buying organic skin care products. "organic shampoos and even "organic clothing. Everybody seems to want "organic and hydroponic growers are quite aware of this. Why then, are there hardly any "Certified Organic hydroponic growers in the United States? Many go through a great deal of trouble to grow their crops "organically," but even though they follow most guidelines, they still cannot get the recognition or Certification necessary to sell their produce to most restaurants or natural food stores as "organic. What is it that is separating organic from hydroponic methods? Why can't these two technologies work together under today's American states' certification guidelines?...

WHAT'S ORGANIC, WHAT'S NOT?

We would think that this is an easy question to answer, but it isn't. In the United States there are numerous

different definitions of "organic," many of which differ significantly. Each state has its own regulations for labeling produce as organic." Additionally, there are 36 non-governmental organizations which can certify produce as organic. For example, California growers who wish to sell their produce as "organic" must register with the California Department of Food and Agriculture and pass their inspection. However, California growers can also obtain certification through the California Certified Organic Farmers (CCOF), which actually has higher standards for organic than the state has. The CCOF certification is optional, but produce with California state registration and CCOF certification may be offered for sale within the state as "certified organic." If the grower chooses not to seek CCOF certification, the produce can be offered for sale in California as "organic," but not "certified organic." Any produce grown outside of the United States can be sold as "certified organic" in the country if one of the 36 non-governmental organizations certifies it. In fact, produce from any state can be granted certification from one of the non-governmental organizations, even if it does not meet the organic standards for the state in which it is being sold. Pretty confusing! What this all means is that the "organic" label is a matter of bureaucratic definitions which can vary from state to state, and country to country. In order to bring some kind of standard into play, the U.S. Department of Agriculture (USDA) - along with state government regulators, non-governmental certifiers, consumers, industry interest groups, food processors and various special interest groups is writing a federally mandated set of "organic" standards. No state will be able to apply more stringent standards than those of the federal. Sometime this spring, the federal standards will be released for a 90 day comment and review period, and by the end of 1996 or early 1997, these standards will become law, or "Frankenlaw;" we'll have to wait and see. The basic objectives of "organic" practice include the following:

- * Avoidance of pesticides, by use of natural pest controls (also applied by many hydroponics growers).
- * caring for soil by recording nutrients and composting, and
- * moderation of nutrient application with reliance on the buffer action of humus derived from compost.

Soilless hydroponic cultivation moderates nutrient supply by the more exact measurements of soluble nutrient formulations, mixed to meet the optimum requirements of each plant species and growth phase. Many consumers select "organic" produce, believing that this is the only way to be assured of pesticide-free nonhazardous food. While "organic" farming methods do produce crops generally superior to and safer than those grown by agri-business practices modern hydroponic techniques can put forth equally safe food that in many cases offers advances in nutrition and taste over their soil-grown "organic" counterparts. But to the consumer, it's the label that counts, so an increasing number of growers throughout the United States are struggling to get organic certification in any way, shape or form. Meanwhile, this whole situation poses an enormous dilemma to hydroponic growers who also want organic recognition for their produce. The primary problem for organic hydroponic growers is in the formulation of the soilless nutrient solution. A secondary issue, which concerns the federal regulators, is in the way used hydroponic nutrient and media such as rockwool, are disposed of. Since "organic" is to a large extent a farming philosophy in support of a healthy environment, the federal concern is entirely reasonable. Although the latter factor has no bearing on the quality and safety of the produce itself, the impact upon the planet is a real driving force behind the issue of "organic" farming. If hydroponic growers can find a way to completely recycle exhausted water, nutrients and media, then the argument in favor of "organic-hydroponic certification" becomes much stronger, but there's still the issue of formulating a satisfactory organic hydroponic nutrient mix. Organic nutrient regulations prohibit the use of many mineral salts and highly refined substances, including food and pharmaceutical grade ingredients that are extremely important for successful hydroponic nutrient formulation. Only unrefined minerals can be used on "organic" crops and these often don't dissolve well or contain quantities of impurities, some of which are even relatively toxic, but "natural and therefore okay," according to organic standards- For example, mined phosphate may contain excessive amounts of fluoride, good for teeth in very small quantities, but harmful to humans in excess. Mined phosphate also can contain small amounts of radioactive elements such as radium, which releases radon, also not good for human health. Chlorides, too, are permitted for organic cultivation but though they are naturally mined, they can be bad for both plants and soil, especially if used in excess. Some soils used by organic farmers contain such toxic elements as selenium, which can accumulate in the plant tissues and produce. Amazing, isn't it? When refined, any impurities or toxicities such as those listed above are removed, but refined minerals make for non-organic produce. Blood meal, bone meal, fish meal and manures pose almost no potential safety hazards, but they don't dissolve very well; they must be broken down through

microbial action in the soil and therefore don't work well in hydroponic applications. There is also a problem that sometimes arises when using manures. The Western Fertilizer Handbook, an important guide for American farmers, points out that many gastro-intestinal illnesses can be traced back to manures used on organically grown crops. In the summer of 1995, a serious outbreak of salmonella poisoning resulted from an organic cantaloupe crop growing in soil fertilized with fresh chicken manure. The rinds of the melons had become contaminated and the bacteria caused serious intestinal illness for many consumers. Another point that can be made is that strict vegetarians or animal rights activists may be offended by the use of blood, bone, horn, hoof and feather meals to grow their food, but these are primary nutrient sources for organic farmers. As you can see, this issue is very complex and there are many points of view. Essentially though, "organic" farming is part philosophy and part methodology, but unfortunately defined bureaucratically.

WHAT'S HYDROPONIC; WHAT'S NOT?

If a plant is grown without soil and with a complete nutrient solution- that's hydroponics! It can be as simple as plants growing in sand, gravel or rockwool with a nutrient drip, or as complex as a complete waterculture system) such as NFT (Nutrient Film Technique) or aeroponics. No matter what method you use, the key to successful hydroponics is nutrients. Hydroponic crops are raised on a perfected mix of primary, secondary and micro-nutrients. The formulas for different crops and environments vary, but all have been defined from extensive experience with a wide variety of crops growing in many different environments throughout the world. Problems may occur where water quality is poor and where environmental extremes of high or low temperature and humidities place stress on crops; however, when a hydroponic facility is properly planned and installed, the resulting crops can be impressive. Data generated in Europe, Israel, Canada, Australia and the United States have defined precise combinations of minerals for a variety of crops. The data is so accurate that required elements are specified in mS (milisiemens) and uS (microsiemens), a system of measuring by electrical conductivity and calculating by atomic weight. Based on these findings, the Dutch research station at Aalsmeer has organized nutrient solutions into three classes: "A" refers to formulas that have been extensively tested and can be considered reliable. "B" signifies formulas that are fairly new but working quite well; some changes can be expected before upgrading to a class "A." "C" formulas are experimental; significant changes can be anticipated before upgrading to class B or A. Formulas are defined for a given crop growing under different conditions. For example, elements are specified for the nutrient reservoir, while a separate specification is made for the nutrients in the "root environment" if growing media is used, particularly rockwool. The root environment usually has higher concentrations of elements since minerals will accumulate in rockwool. To test the concentration within the media, the grower will squeeze some nutrient out of a sample of the media, do a basic conductivity and pH test, and sometimes send the sample to a lab for analysis. If the concentration of elements in the media rises above the recommended limits, the grower will have to adjust the formulation of the nutrient in the reservoir or run a rinse through the media to lower the nutrient concentration within the root zone. Another formula may be defined for non-recirculating nutrient, also called "run-to-waste," where nutrient is sent from the reservoir on a one-way trip through rockwool onto the ground. This method is falling into disfavor due to the pollution caused by the nutrient run-off and discarded rockwool.

HYDROPONIC PRODUCE AND HEALTH

In 1994 a test was commissioned by an investment group to determine the vitamin and mineral content of hydroponically grown crops in comparison to soil grown crops, both organic and nonorganic. Plant Research Technologies Laboratory in San Jose, California, analyzed tomatoes and sweet peppers; those hydroponically grown used General Hydroponics' "Flora" nutrients. The hydroponic produce showed a significant increase in vitamins and minerals beneficial to human health over the soil-grown produce. This data indicates the importance of a calibrated nutrient solution. The crops had been grown following the Dutch recommendation for hydroponic tomatoes and sweet peppers, and not only were they of higher nutritional value, the flavor was

reported to be outstanding. The hydroponic crops were further analyzed to search for chemicals on the EPA's "priority pollutant list," of which, none were found. American agribusiness is beginning to apply hydroponics on a significant scale. Large corporate facilities are showing profits and generating high crop yields with consistent quality at facilities in Colorado, Utah and Mexico. These installations mark an important point for hydroponic farming in the United States. If the investments prove profitable over the long term, then steady growth is going to continue, slowly replacing many field-grown crops in the marketplace. The British have been applying hydroponic farming to meet consumer needs for decades. Farming cooperatives grow tomatoes, cucumbers and salad greens on a very large scale. Van Heinegen Bros. produces three pounds of hydroponically grown tomatoes per year for every man, woman and child in the British Isles. In support of these enterprises, the British government runs a research facility which investigates improved hydroponic methods, disease and pest control and new plant varieties. The cooperation between government and farmers has led to improved crop production, quality and profits. Although hydroponically grown produce, while usually free of pesticide and other chemical hazards, does not generally meet the rather narrow definitions of "organic," it can offer superior flavor, nutrition, appearance, freshness and shelf life. Many small hydroponic growers are recognizing these market trends and cashing in on the huge demand for higher quality produce. Small growers find that gourmet restaurants and local markets are delighted to have access to superior quality produce, whether organically or hydroponically grown. Since "organic" is pretty much out of the question, an increasing number of hydroponic growers are promoting their produce as "pesticide-free." This gives the consumer the reassurance that their fruits and vegetables have been grown following the most important principal of "organically grown produce. One consequence of this dichotomy is that the term "organic agriculture" is declining in favor of the term "sustainable agriculture," which applies to both organic and hydroponic cultivation. Though many organic growers look down on hydroponic technology, the superior quality and freshness of locally grown hydroponic produce is in fact gaining market acceptance. A new niche is developing for small hydroponic growers, family farms, and even urban farms in areas that have traditionally been served by large corporate farms far away. The simple truth is that top quality organically raised produce can only be grown under fairly ideal conditions and only seasonally in most parts of the United States. This results in produce that is expensive and frequently unavailable or shipped from afar, causing quality to suffer. In the "organic model, good soil is enriched with compost, blood meal, bone meal, manures and a host of other natural amendments. These components break down slowly in the soil at a rate in harmony with the plants' growth; a microbiological process is required to make the nutrients available to the plants. These microbes include many organisms that are all in a symbiotic embrace with the environment and the plants. When done skillfully in the right environment with the right crop, this is nature and farming at its finest. But it differs sharply from the hydroponic model, where microorganisms are unnecessary for the plants to absorb the prepared nutrients. The nutrient absorption rate of a hydroponically grown plant is generally much faster than that of a soil grown plant, since in hydroponics, nutrients are instantly soluble and available, as is essential oxygen. Hydroponic plants are usually grown in a relatively sterile environment, and often with precise controls, from artificial lighting to extend growing seasons to exotic computer systems that enable the grower to actually tailor the environment to the crop wherein hydroponics becomes just one part of the entire system. In this type of setup, labor is reduced, yet plant growth rates, yields and quality increase. Many attempts have been made to create the perfect organic-hydroponic nutrient, but so far nothing matches the purified mineral salts used in formulating hydroponic nutrient solutions. We note that the European Economic Community (EEC) has established the category of "mineral organic" for foods grown with the required mineral nutrients to supplement an organic base of nitrogen. We previously touched on the fact that United States agricultural regulations are currently set and applied at the state level but practically all states prohibit the use of refined ingredients to cultivate "organic" crops; only mined minerals can be used. Surprisingly, this precludes organic growers from using pharmaceutical or food grade ingredients to formulate fertilizers. This could be a safety risk, but at least mined minerals will break down in the soil. Hydroponic growers, on the other hand, must use refined minerals because mined minerals dissolve poorly in solutions. As a consequence, it is not currently practical to formulate a top-quality "organic" fertilizer which will work well for hydroponic crop production, and meet U.S. standards. The Flora nutrients developed at General Hydroponics, for example, currently meet the EEC standards for the mineral component of the "mineral-

organic" category, but cannot be used in the United States to grow certified "organic" produce. A review of the standards for defining "organic" will soon be completed by federal regulators in the U.S. Department of Agriculture. There is some possibility that the USDA may eventually consider the European standards, opening the door for organic growers to use purified mineral nutrients and hydroponic growers to cultivate organically certified produce. It is not surprising that European regulations favor policies which promote the cultivation of produce with superior quality and flavor. Generally European consumers are accustomed to higher quality foods and will not purchase flavorless produce. The myth that only certified organically grown produce is of good quality, nutrition and flavor has been clearly dispelled by the many successes of hydroponic producers worldwide, but remains predominant in public perception. This trend will most likely continue; the only question is whether the United States will be a leader, or a follower.

Lawrence L. Brooke is the owner and founder of General Hydroponics in Sebastopol, California.

Author's Note: I've tried to describe a few of the problems hydroponic growers face when trying to compete with "organic" produce. I don't wish to leave readers with the impression that there's anything wrong with organic, or that hydroponic produce is always better. It can go either way depending upon the skill and ethics of the farmer. The main issue is for growers and consumers to understand that "organic" is a matter of definitions. Sometimes the organic produce is the best tasting and most nutritious available in the marketplace; other times the hydroponic produce is better. In the final analysis, organic farming has a low environmental impact on the Earth, and this is an important point from a philosophical view. Until hydroponic growers can find a way to recycle used Water, media and nutrients, the hydroponic method will not be equal to "organic" in these terms. On the other hand, if a consumer is comparing the flavor and nutrition quality of a crop. both hydroponic and organic methods are excellent.

Hydroponic Terminology

[Glossary Page of Terms.](#) Click for more Details.

[A](#) [B](#) [C](#) [D](#) [E](#) [F](#) [G](#) [H](#) [I](#) [K](#) [L](#) [M](#) [N](#) [P](#) [R](#) [S](#) [V](#) [W](#)

Select the first letter of the word from the list above to jump to appropriate section of the glossary. If the term you are looking for starts with a digit or symbol, choose the '#' link.

- A -

ACID

a sour substance: An acidic solution has a pH below 7

AERATION

Supplying soil and roots with air or oxygen.

ALKALINE

refers to medium or nutrient solution with a high pH: Any pH over 7 is considered alkaline

AMPERE (AMP)

the unit used to measure the strength of an electric current: A 20-amp circuit is overloaded when drawing more than 17 amps

[Back to Top](#)

- B -

BLOSSOM BOOSTER

fertilizer high in phosphorus (P) that increases flower yield

BOLT

term used to describe a plant that has run into seed prematurely

BURN

Leaf tips that turn dark from excess fertilizer and salt burn

[Back to Top](#)

- C -

CARBON DIOXIDE (CO₂)

a colourless, odourless, tasteless gas in the air necessary for plant life. Occurs naturally in the

atmosphere at .03%

CHLOROSIS

the condition of a sick plant with yellowing leaves due to inadequate formation of chlorophyll: Chlorosis is caused by a nutrient deficiency, usually iron or imbalanced pH.

CLONE

A plant produced through asexual reproduction including, but not limited to, cuttings, layering and tissue culture

CONDITIONING

to soak new Rockwool in an acidic solution to lower the pH from 8,0 to 5.5

[Back to Top](#)

- D -

DAMPING OFF FUNGUS

disease that attacks young seedlings and cuttings causing stem to rot at base: Overwatering is the main cause of damping-off

DISSOLVED SOLIDS

the amount of dissolved solids, usually fertilizer salts, that are measured in water in parts per million

DRIP SYSTEM

a very efficient watering system that employs a main hose with small water emitters. Water is metered out of the emitters, one drop at a time

[Back to Top](#)

- E -

ELECTRICAL CONDUCTIVITY (EC)

the ability of a solution to carry electrical energy as a result of the elements and compounds in the solution

[Back to Top](#)

- F -

FOLIAR FEEDING

misting fertilizer solution which is absorbed by the foliage

FUNGICIDE

a product that destroys or inhibits fungus

FUNGUS: DAMPING OFF FUNGUS

disease that attacks young seedlings and cuttings causing stem to rot at base: Overwatering is the main

cause of damping-off

[Back to Top](#)

- G -

GERMINATION

the process of causing the initiation and development of a plant from seed

[Back to Top](#)

- H -

HALOGEN

any of the elements flowering, chlorine, bromine, iodine and astatine existing in a free state: Halogens are in the arc tube of a halide lamp

HARDEN-OFF

to gradually acclimatize a plant to a more harsh environment. A seedling must be hardened-off before planting outdoors

HID

High Intensity Discharge (referring to light bulbs used in hydroponic gardens)

HOOD

reflective cover of a HID lamp: A large, white Hood is very reflective

HOR

the abbreviation stamped on some HID bulbs meaning they may be burned in a horizontal position

HORMONE

Chemical substance that controls the growth and development of a plant. Root-inducing hormones help cuttings root

HYBRID

an offspring from two plants of different breeds, variety or genetic make-up

HYDRATED LIME

instantly soluble lime, used to raise or lower pH

HYGROMETER

instrument for measuring relative humidity in the atmosphere: A hygrometer will save time, frustration and money

[Back to Top](#)

- I -

INTENSITY

the magnitude of light energy per unit: Intensity diminishes the farther away from the source

[Back to Top](#)

- K -

KILOWATT-HOUR

measure of electricity used per hour: A 1000 watt HID uses one kilowatt per hour

[Back to Top](#)

- L -

LEAF CURL

leaf malformation due to overwatering, over fertilization, lack of magnesium, insect or fungus damage or negative tropism

LUMEN

measurement of light output: One lumen is equal to the amount of light emitted by one candle that falls on one square foot of surface located one foot away from one candle.

[Back to Top](#)

- M -

MACRO-NUTRIENT

one or all of the primary nutrients N-P-K or the secondary nutrients magnesium and calcium

MICRO-NUTRIENT

also referred to a TRACE ELEMENTS ,including S, Fe, Mn B, Mb, An and Cu

MONOCHROMATIC

producing only one colour: LP sodium lamps are monochromatic

[Back to Top](#)

- N -

NFT (NUTRIENT FILM TECHNIQUE)

nutrient is fed into growtubes where the roots draw it up. A thin film of nutrient allows the roots to have constant contact with the nutrient and the air layer above at the same time.

NUTRIENT

plant food, essential elements N-P-K, secondary and trace elements fundamental to plant life

NUTRIENTS, SECONDARY

Calcium (Ca) and magnesium (Mg)

[Back to Top](#)

- P -

pH

a scale from 1 to 14 that measures the acid to alkaline balance of a growing medium (or anything): In general plants grow best in a range of 6 to 6.8 pH 6.3 is considered ideal. If the pH is not within the acceptable range nutrients may not be absorbed to maximum capacity

PERLITE

1. Sand or volcanic glass, expanded by heat, holds water and nutrients on its many irregular surfaces
2. Mineral soil amendment

PHOTOPERIOD

the relationship between the length of light and dark in a 24 hour period

PHOTOSYNTHESIS

the process by which plants use light energy to collect carbon dioxide from the atmosphere and convert it to chemical energy in the form of sugar

POLLINATION

the transfer of pollen from a stamen to a pistel. Often enhanced by environmental manipulation , plant movement through shaking or vibrating or the introduction of bees into the growing area

PROPAGATE

- 1 Sexual - produce a seed by breeding different male and female flowers
- 2 Asexual - to produce a plant by taking cuttings

PYRETHRUM

natural insecticide made from the blossoms of various chrysanthemums

[Back to Top](#)

- R -

RESERVOIR

any container of a variety of constructions which holds water in reserve for use

REVERSE OSMOSIS (R/O)

water that has had all contaminates and salts removed.

ROCKWOOL

inert, soilless growing medium consisting of thin strand-like fibres made from rocks

[Back to Top](#)

- S -

SECONDARY NUTRIENTS

Calcium (Ca) and magnesium (Mg)

SYSTEMIC

used in reference to a disease within the plant tissue, not initiated from the external cells. Also refers to materials and compounds which are taken up or absorbed by the plant and designed to fight disease

[Back to Top](#)

- V -

VERMICULITE

mica processed and expanded by heat. Vermiculite is a good soil amendment and medium for rooting cuttings

[Back to Top](#)

- W -

WETTING AGENT

compound that reduces the droplet size and lowers the surface tension of the water, making it wetter. Liquid concentrate dish soap is a good wetting agent if it is biodegradable

WICK

part of a passive hydroponic system using a wick suspended in the nutrient solution, the nutrients pass up the wick and are absorbed by the medium and roots

[Back to Top](#)

Glossary Page of Terms

Here is a partial list of terms that will be used when building our hydroponic projects. More will be added periodically.

[A](#) [D](#) [G](#) [J](#) [M](#) [P](#) [U](#)
[B](#) [E](#) [H](#) [K](#) [N](#) [S](#) [V](#)
[C](#) [F](#) [I](#) [L](#) [O](#) [T](#) [W](#)

A

Alternating Current (AC) - an electric current that reverses its direction at regularity occurring intervals. Homes have A.C.

Adobe - heavy clay soil, not suitable for container gardening or hydroponics.

Aeration - supplying growing mediums and roots with air or oxygen.

Aeroponic - growing plants by misting roots suspended in air. No medium is needed with this method and usually only small plants that need no support are grown this way.

Aggregate - medium usually grow rocks, gravel, or lava rocks that is all nearly the same size, and used for an inert hydroponic medium.

Alkaline - refers to soil or hydroponic nutrient solution with a high [pH](#) : Any pH over 7 is considered alkaline.

All-purpose (General-purpose) fertilizer - A balanced blend of N-P-K; all purpose fertilizer for soil and is used by most growers in the vegetative growth stage. Miracle-Gro and Peters is an example. They are not recommended for hydroponics.

Ampere (amp) - the unit used to measure the strength of an electric current; A 20-amp circuit is overloaded when drawing more than 17amps,

Annual - a plant that normally completes its entire life cycle in one year or less: Marigolds and tomatoes are examples of annual plants.

Arc - luminous discharge of electricity (light) between two electrodes.

Arc tube - container for luminous gases; also houses the arc.

Auxin - classification of plant hormones; Auxins are responsible for foliage and root elongation.

B

Bacteria - very small, one-celled organisms that have no [chlorophyll](#).

Beneficial insect - a good insect that eats bad insects that attack your plants.

Biodegradable - able to decompose or break down through natural bacterial action; Substances made of organic matter are biodegradable.

Bleach - Ordinary laundry bleach is used in a 1 part bleach to 10 parts water solution as a garden fungicide.

Use this solution to clean all your equipment between harvests to rid of any lingering contamination.

Bolt - term used to describe a plant that has run to seed prematurely which means that it bloomed because of heat or other reasons.

Bonsai - a very short or dwarfed plant.

Breaker box - electrical circuit box having on/off switches rather than fuses,

Breath - Roots draw in and breath oxygen, [stomata](#) draw in and breathe CO₂.

Bud blight - a withering condition that attacks flower buds.

Buffering - the ability of a substance to reduce shock and cushion against pH fluctuations. Many soil fertilizers contain buffering agents but it is much more critical to maintain the correct pH with hydroponics than with soil growing..

Bulb - 1. the outer glass envelope or jacket that protects the arc tube of an HID lamp 2. clove or bulb of garlic.

C

Calyx - the pod harboring female ovule and two protruding pistils, seed pod.

Carbon dioxide (CO₂) - a colorless, odorless, taste less gas in the air necessary for plant life.

Carbohydrate - neutral compound of carbon, hydrogen and oxygen; Sugar, starch and cellulose are carbohydrates.

Caustic - capable of destroying, killing or eating away by chemical activity

Cell - the base structural unit that plants are made of: Cells contain a nucleus, membrane, and chloroplasts.

Cellulose - a complex carbohydrate that stiffens a plant: Tough stems contain stiff cellulose.

CFM - Cubic feet per minute.

Chelate - combining nutrients in an atomic ring that is easy for plants to absorb.

Chlorophyll - the green photosynthetic matter of plants: Chlorophyll is found in the chloroplasts of a cell.

Chlorine - chemical used to purify water.

Chloroplast - containing chlorophyll

Chlorosis - the condition of a sick plant with yellowing leaves due to inadequate formation of chlorophyll; Chlorosis is caused by a nutrient deficiency, usually iron or imbalanced pH.

Circuit - a circular route traveled by electricity.

Clay - soil made of very fine organic and mineral particles: Clay is not suitable for container gardening.

Climate - the average condition of the weather in a grow room or outdoors.

Color spectrum - the band of colors (measured in nm) emitted by a light source.

Color tracer - a coloring agent that is added to many commercial fertilizers so the horticulturist knows there is fertilizer in the solution. Peters has a blue color tracer.

Compaction - soil condition that results from tightly packed soil: Compacted soil allows for only marginal aeration and root penetration

Companion planting - planting garlic, marigolds, etc. along with other plants to discourage insect infestations.

Compost - a mixture of decayed organic matter, high in nutrients; Compost must be at least one year old. When too young, decomposition uses nitrogen; after sufficient decomposition, compost releases nitrogen.

Core - the transformer in the ballast is referred to as a core,

Cotyledon - seed leaves first leaves that appear on a plant.

Cross-pollinate - pollinate two plants having different ancestry.

Cubic foot - volume measurement in feet: Width times length times height equals cubic feet.

Cutting -1. growing tip cut from a parent plant for asexual propagation 2. clone

D

Damping-off - fungus disease that attacks young seedlings and cuttings causing them to rot at the base: Over-watering is the main cause of damping-off.

Direct Current (DC) - an electric current that flows in only one direction

Deplete - exhaust soil of nutrients, making it infertile: Once a soil is used it is depleted

Desiccate - cause to dry up. Safari's Insecticidal Soap desiccates its victims.

Detergent - liquid soap concentrate used as a: 1. wetting agent for sprays and water 2. pesticide. Note: Detergent must be totally organic to be safe for plants.

Dioecious - having distinct male and female flowers.

Dome - the part of the HID outer bulb opposite the neck and threads.

Dome support - the spring-like brackets that mount the arc tube within the outer envelope,

Drainage - way to empty soil of excess water: with good drainage, water passes through soil evenly, promoting plant growth; with bad drainage water stands in soil, drowning roots.

Drip line - a line around a plant directly under its outermost branch tips: Roots seldom grow beyond the drip line.

Drip system - a very efficient watering system that employs a main hose with small water emitters.

Water is metered out of the emitters, one drop at a time.

Dry ice - a cold, white substance formed when CO₂; is compressed and cooled: Dry ice changes into CO₂; gas at room temperatures. For small garden rooms this may be an easy way to add CO₂.

Dry well - drain hole, filled with rocks

E

Electrode - a conductor used to establish electrical arc or contact with non-metallic part of circuit.

Elongate - grow in length.

Envelope - outer protective bulb or jacket of a lamp.

Equinox - the point at which the sun crosses the equator and day and night are each 12 hours long: The equinox happens twice a year.

Extension cord - extra electrical cord that must be 14-gauge or larger (i.e. 12-or IO-gauge).

F

Feed - fertilize.

Female - pistillate, ovule, seed-producing.

Fertilizer burn - over-fertilization: First leaf tips burn (turn brown) then **leaves** curl.

Fixture - electrical fitting used to hold electric components.

Flat - shallow (three-inch) deep container, often 18 by 24 inches with good drainage, used to start seedlings or cuttings.

Flat white - very reflective, whitest white paint available.

Fluorescent lamp - electric lamp using a tube coated with fluorescent material, which has low lumen and heat output; A fluorescent lamp is excellent for rooting cuttings.

Foliage - the leaves, or more generally, the green part of a plant

Foliar feeding - misting fertilizer solution which is absorbed by the foliage.

Fritted - fused or embedded in glass, Fritted trace elements (FTE) are long-lasting and do not leach out easily,

Fungicide – a product that destroys or inhibits fungus.

Fungistat - a product that inhibits fungus keeping in check.

Fungus - a lower plant lacking chlorophyll which may attack green plants; Mold, rust, mildew, mushrooms and bacteria are fungi.

Fuse - electrical safety device consisting of a metal that melts and interrupts the circuit when circuit is overloaded.

Fuse box - box containing fuses that control electric circuits.

G

GPM - Gallons per minute

General purpose fertilizer – See ALL-PURPOSE FERTILIZER.

Gene - part of a chromosome that influences the development and potency of a plant; Genes are inherited through sexual propagation.

Genetic make-up - the genes inherited from parent plants: Genetic make-up is the most important factor dictating vigor and potency.

H

Halide - binary compound of a halogen(s) with an electropositive elements.

Halogen • any of the elements fluorine, chlorine, bromine, iodine and astatine existing in a free state: Halogens arc in the arc tube of a halide lamp.

Hermaphrodite - one plant having both male and female flowers: The breeding of hermaphrodites is hard to control.

Hertz (Hz) -a unit of a frequency that cycles one time each second: A home with a 60 hertz AC current cycles 60 times per second.

HID-High Intensity Discharge.

Honeydew - a sticky, honey-like substance secreted onto foliage by aphids, scale and mealy bugs.

Hood - reflective cover of a HID lamp; A large, white hood is very reflective.

HOR - The abbreviation stamped on some HID bulbs meaning they may be burned in a horizontal position.

Horizontal • parallel to the horizon, ground or floor.

Hormone - chemical substance that controls the growth and development of a plant. Root-inducing hormones help cuttings root.

Hose bib - water outlet containing an on/off valve,

Humidity (relative) - ratio between the amount of moisture in the air and the greatest amount of moisture the air could hold at the same temperature.

Humus - dark, fertile, partially decomposed plant or animal matter: Humus forms the organic portion of the soil.

Hybrid - an offspring from two plants of different breeds, variety or genetic make-up.

Hydrated lime - instantly soluble lime, used to raise or lower pH.

Hydrogen - light, colorless, odorless gas: Hydrogen combines with oxygen to form water.

Hygrometer - instrument for measuring relative humidity in the atmosphere A hygrometer will save time, frustration and money.

I

Inbred - (true breed) offspring of plants of the same breed or ancestry.

Inert - chemically non-reactive; inert growing mediums make it easy to control the chemistry of the nutrient solution,

Intensity - the magnitude of light energy per unit: Intensity diminishes the farther away from the source.

J

Jacket - protective outer bulb or envelope of lamp,

Jiffy 7 pellet - compressed peat moss wrapped in an expandable plastic casing; When moistened, a Jiffy 7 pellet expands into a small pot that is used to start seeds or cuttings.

K

Kilowatt-hour - measure of electricity used per hour; A 1000- watt HID uses one kilowatt per hour,

L

Leach - dissolve or wash out soluble components of soil by heavy watering but can be beneficial to hydroponics systems to flush out excess fertilizer salts.

Leader - See [Meristem](#)

Leaf curl - leaf malformation due lo over-watering, over fertilization, lack of magnesium, insect or fungus damage or negative tropism.

Leaflet - small immature leaf,

Leggy - abnormally tall, with sparse foliage: Legginess of a plant is usually caused by lack of light.

Life cycle - a series of growth stages through which plant must pass in Its natural lifetime: The stages for an annual plant arc seed, seedling, vegetative and floral.

Light mover - a device that moves a lamp back and forth across the ceiling of a grow room to provide more even distribution of light.

Lime - used in the form of DOLOMITE or HYDRATED LIME to raise and stabilize soil pH.

Litmus paper - chemically sensitive paper used for testing pH.

Loam -organic soil mixture of crumbly clay, silt and sand.

Lumen - measurement of light output: One lumen is equal to the amount of light emitted by one candle that falls on one square foot of surface located one foot away from one candle.

M

Macro-nutrient - one or all of the primary nutrients **N-P-K** or the secondary nutrients magnesium and calcium.

Mean - average throughout life; HID's are rated in mean lumens.

Meristem - tip of plant growth, branch tip.

Micro-nutrients - also referred to as TRACE ELEMENTS, including S, Fe, Mn, B, Mo, Zn and Cu.

Millimeter - thousandth of a meter; approximately .04 inch.

Moisture meter - a fantastic electronic device that measures the exact moisture content of soil at any given point.

Monochromatic - producing only one color; LP sodium lamps are monochromatic.

Mulch - a protective covering of organic compost, old leaves, etc.: Indoors, mulch keeps soil too moist, and possible fungus could result.

N

Nanometer - .000001 meter, nm is used as a scale to measure electromagnetic wave lengths of light: Color and light spectrums are expressed in nanometers (nm).

Necrosis - localized death of a plant part.

Neck - tubular glass end of the HID bulb, attached to the threads.

Nutrient - plant food, essential elements N-P-K, secondary and trace elements fundamental to plant life.

O

Ohm's Power Law - a law that expresses the strength of an electric current: Volts times Amperes equals watts.

Organic • made of, derived from or related to living organisms.

Outbred - see hybrid.

Overload • load to **excess**; A 20-amp circuit drawing 17 amps is overloaded,

Ovule - a plant's egg; found within the calyx, it contains all the female genes; When fertilized, an ovule will grow into a seed.

Oxygen - tasteless, colorless element, necessary in soil to sustain plant life.

P

Parasite - organism that lives on or in another host organism: Fungus is a parasite.

Peat - partially decomposed vegetation (usually moss) with slow decay due to extreme moisture and cold.

Perennial - a plant, such as a tree or shrub, that completes its life cycle over several years,

pH - a scale from 1 to 14 that measures the acid-to-alkaline balance a growing medium (or anything): In general plants grow best in a range of 6 to 6.8 pH in soil and 5 to 6.5 for hydroponics

pH tester - electronic instrument or chemical used to find where soil or water is on the pH scale.

Phosphor coating -internal bulb coating that diffuses light and is responsible for various color outputs.

Photoperiod - the relationship between the length of light and dark in a 24-hour period.

Photosynthesis - the building of chemical compounds (carbohydrates) from light energy, water and CO₂.

Phototropism - the specific movement of a plant part toward a light source.

Pigment - The substance in paint or anything that absorbs light, producing (reflecting) the same color as the pigment.

Pollen - fine, yellow, dust-like microspores containing male genes.

Pod seed - a dry calyx containing a mature or maturing seed.

Pot-bound - bound, stifled or inhibited from normal growth, by the confines of a container: Root systems become pot bound.

Power surge - interruption of change in flow of electricity.

Primary nutrients - N-P-K.

Propagate - 1. Sexual - produce a seed by breeding different male and a female flowers 2. Asexual - to produce a plant by taking cuttings.

Prune - alter the shape and growth pattern of a plant by cutting stems and shoots.

PVC pipe - plastic (polyvinyl chloride) pipe that is easy to work with, readily available and used to make most of the gardens on this site.

Pyrethrim - natural insecticide made from the blossoms of various chrysanthemums: Raids' Pyrethrum is the most effective natural spider mite exterminator.

Rejuvenate - Restore youth: A mature plant, having completed its life cycle (flowering), may be stimulated by a new 18 hour photoperiod, to rejuvenate or produce new vegetative growth.

Root-bound - see POT BOUND.

S

Salt - crystalline compound that results from improper pH or toxic buildup of fertilizer. Salt will burn plants, preventing them from absorbing nutrients.

Secondary nutrients - calcium (Ca) and magnesium (Mg).

Short circuit - condition that results when wires cross and forms a circuit. A short circuit will blow fuses.

Socket - threaded, wired holder for a bulb.

Soluble - able to be dissolved in water.

Spore - seed-like offspring of a fungus.

Sprout - 1, a recently germinated seed 2. small new growth of leaf or stem.

Square feet (sq. ft.) - length (in feet) times width equals square feet.

Staminate - male, pollen producing.

Starch - complex carbohydrate: Starch is manufactured and stored food.

Sterilize - make sterile (super-clean) by removing dirt, germs and bacteria. A good sterilizer for hydroponic equipment is a 10 percent bleach to water solution.

Stroboscopic effect - a quick pulsating or flashing of a lamp.

Stress - a physical or chemical factor that causes extra exertion by plants: A stressed plant will not grow as well as a non-stressed plant.

Stomata - small mouth-like or nose-like openings (pores) on leaf underside, responsible for transpiration and many other life functions: The millions of stomata must be kept very dean to function properly.

Sugar - food product of a plant.

Super-bloom - a common name for fertilizer high in phosphorus that promotes flower formation and growth

Synthesis - production of a substance, such as chlorophyll, by uniting light energy and elements or chemical compounds.

Sump - reservoir or receptacle that serves as a drain or holder for hydroponic nutrient solutions,

T

Tap root - the main or primary root that grows from the seed: Lateral roots will branch off the tap root,

Teflon tape - tape that is extremely useful to help seal all kinds of pipe joints. I like Teflon tape better than putty.

Tepid - warm 70 to 80° F (21 to 270 C). Always use tepid water around plants to facilitate chemical processes and case shock,

Terminal bud - bud at the growing end of the main stem.

Thin - cull or weed out weak, slow growing seedlings.

Tonic life - the amount of time a pesticide or fungicide remains active or live.

Transformer - a devise in the ballast that transforms electric current from one voltage to another.

Transpire - give off water vapor and by products via the stomata.

Trellis - frame of small boards or PVC (lattice) that trains or supports plants.

True breed - see INBRED.

Tungsten - a heavy, hard metal with a high melting point which conducts electricity well: Tungsten is used for a filament in tungsten halogen lamps.

U

Ultraviolet - light with very short wave lengths, out of the visible spectrum.

V

Variety - strain, phenotype (sec strain).

Vent - opening such as a window or door that allows the circulation of fresh air.

Ventilation - circulation of fresh air, fundamental to healthy indoor garden. An exhaust fan creates excellent ventilation.

Vertical - up and down; perpendicular to the horizontal.

W

Wetting agent - compound that reduces the droplet size and lowers the surface tension of the water, making it wetter. Liquid concentrate dish soap is a good wetting agent if it is biodegradable,

Wick - part of a passive hydroponic system using a wick suspended in the nutrient solution, the nutrients pass up the wick and are absorbed by the medium and roots.

Conversion and Calculation Tables— and Some Explanation.

In order to help make communication and conversions between different growers in different countries easier, we felt that a conversion page would be useful. Now, growers can simply plug in the figures they have in order to convert between metric and U.S. measurements, or vice versa. Also, a handy calculation tool is included that will help growers figure generally how much their electricity usage will cost for different wattage lamps.

Please be connected to the Internet and [Click Here](#) to Start the Tables.

[Science Project Requirements.](#)

[Building and Using a Hydroponic/Aquaculture System in the Classroom.](#)

[Hydroponic Systems Grade Level: 9-12 Science projects.](#)

We receive many requests for information on Science projects. Mostly the objective is to compare plants that are grown in hydroponics with the same plants under the same conditions, grown in soil.

Following are our suggestions for a simple and cheap way to have a hydroponic garden.

Please do note that hydroponics works really well because the gardener provides everything the plants need. So by cutting down to the very basic needs for a hydroponic system we actually give the plants a disadvantage.

1. [Requirements](#)
 2. [pH balance Rockwool](#)
 3. [Set up the system](#)
 4. [Plant the seeds](#)
 5. [Mix nutrients](#)
 6. [pH balance the solution](#)
 7. [Flood and Drain the plants](#)
 8. [Maintain your nutrient solution](#)
 9. [A remark on light](#)
-

Requirements

When doing a science project on hydroponics, these are the very basic things you need:

1. A garden system
2. growing medium
3. A & B nutrient
4. pH kit
5. Seeds
6. A bucket
7. Piece of water hose,
attached to the bucket and to your tray

With hydroponics the gardener usually also provides the light. If you have a grow light, use it. If you don't make sure the plants get ample sunlight.

1. A standard 2 part nursery tray and a bucket can be easily rigged to a 'flood & drain' garden.

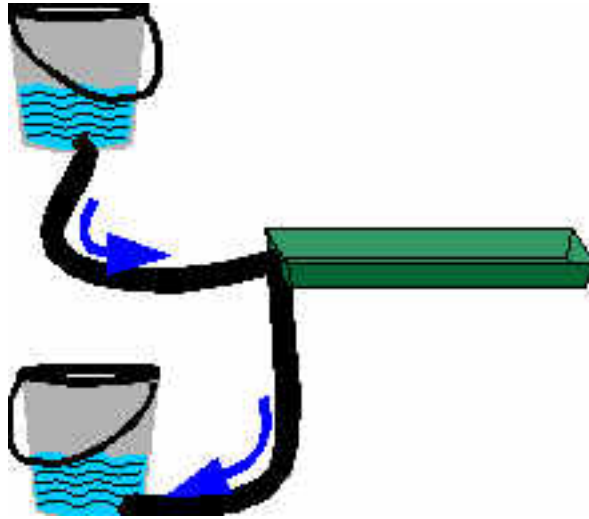

2. A hydroponics growing medium is completely inert. An

inert medium will not effect the pH of the nutrient solution. It does not provide anything but an anchor for the plant. Hydroponic growing mediums are less compact than earth so the roots get more air.

- The growing medium we suggest for a project is 'Rockwool'. Get one inch / 2.5 cm starter cubes.
3. Any commercially prepared standard 'hydroponic nutrient' should do nicely. [More information on nutrient 'recipes'](#)
 4. Plants will fail if their pH is too high or low. You need something to test the pH level of your nutrient solution and pH adjusters.
 5. Try an herb such as basil, it will grow and flower quickly. Leaf lettuce is another good plant to use because we harvest before it flowers. Stay away from tomato, pepper, cucumber because they take a very long time to fruit.

Preparation

The first step is to pH balance the Rockwool starting cubes. pH refers to acid or alkaline level of the solution. The pH scale goes from one to fourteen, with seven being neutral. Any reading above seven is alkaline, any reading below seven is acidic. Tap water tends to be a little on the alkaline side and since plants prefer a slightly acidic root zone, we must add a little acid to the water we feed the plants.

Fill a one litre container with tap water. Pour about one tablespoon of the water into a small clear container. With an eye dropper add two drops of pH indicator solution to the water sample. Now compare the colour of the sample to the colour chart on the bottle. It will probably be greenish (pH 7-8).

Next add two or three drops of 'pH Down" (phosphoric acid) to the litre of water, stir and do the test again. Repeat this procedure until the sample turns yellow, indicating a pH of about 6.0. If the colour of the sample turns brownish or reddish, you have added too much pH Down, so just add more tap water to raise the pH level again. Be careful not to get any pH Down on your hands. If you do, wash immediately with water.

Set up the hydroponic system

Put the garden in the place where it will remain. It is not easy to move when it is in use. Make sure the garden is on a sturdy, level surface where it can't be knocked over. When mounting on a window ledge make sure the ledge is *wider* than the garden.

Rockwool must not sit on a flat surface, there must be an air space underneath. Prop up, use ½" of Perlite or a standard 2 part nursery tray.

Attach the hose to the tray and bucket.

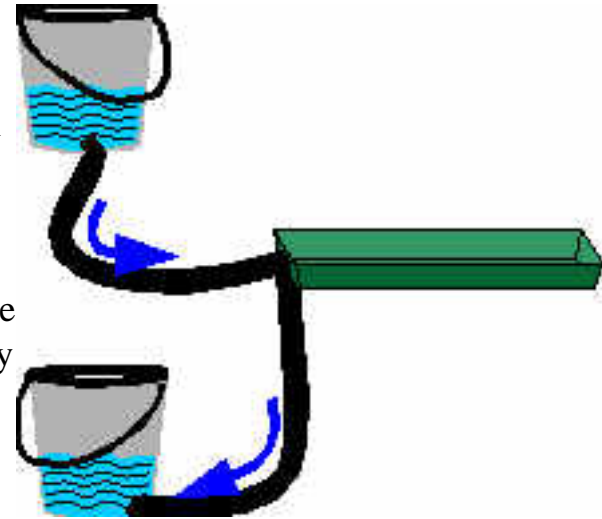

Plant seeds

Now you are ready to soak your one inch starter cubes in the pH balanced solution and put them on a plate or tray. It is now time to plant your seeds! Choose your seeds and insert one seed into the small hole in the top of each cube. If there is not a pre-made hole, make one about pencil width, a quarter inch / 0.75cm deep. Cover the hole with a bit of Rockwool so the seed has a dark place to sprout from. Take a small piece of saran wrap or plastic bag and cover the cubes to keep the moisture in. In a couple of days wet the cubes again with your pH balanced water.

Most seeds will begin to sprout in four to six days. Once they have sprouted, remove the saran wrap and moisten the cubes again.

Mix the nutrients

The nutrients are the plant's source of food so it is important that we do not give them too much or too little. The hydroponic nutrients supply all of the mineral elements that plants otherwise would get from the soil. Since your plants are still very young, mix the nutrient solution at *half* strength this time.

So use 2.5 ml of each the 'A' and 'B' nutrient per litre (Check the instructions on your nutrients.). Mix enough solution to fill your tray to $\frac{3}{4}$ rd of the height of the Rockwool cubes.

pH balance the solution

This process is identical to the procedure for preparing the seeding cubes. Always adjust the pH level *after* mixing the nutrients as they will also lower the pH a little.

Flood and Drain your garden

Raise the bucket above the garden so the nutrient solution will flow into the tray.

The tray should be flooded to $\frac{3}{4}$ of the cubes' height and drain immediately after. Make sure to *not* submerge the roots for more than 3 minutes.

Repeat this 2 to 3 times per day.

Maintenance of your nutrient solution

Plants use more water than nutrients, therefore top up the bucket with fresh water daily and *pH balance* the solution to 6.0 / 6.5.

Make a new solution each week. After the first week use $\frac{3}{4}$ strength nutrients, a week later you can start mixing a full strength solution.

This Flood and Drain technique exposes the roots directly to the nutrient solution. Erratic pH and EC (the amount of dissolved salts in the solution) is caused by the roots acting directly on the nutrient solution. Plants will benefit greatly by keeping these levels steady.

LIGHT

Remember that light is very important. If your plants don't have light, it doesn't matter what you give

them. [Read more about lighting.](#)

Building and Using a Hydroponic/Aquaculture System in the Classroom.

TYPE OF ACTIVITY:

- Construction Project
- Hands-on Activities

TARGET AUDIENCE:

- Life Science
- Biology
- Environmental Science

BACKGROUND INFORMATION:

Two helpful references related to this project:

1. Jones,L. (1977), **Home hydroponics and how to do it!** New York: Crown Publishers
2. Nicol, E. (1990), "Hydroponics and Aquaculture in the High School Classroom" , **The American Biology Teacher**, Vol. 52 No.3 March 1990.

LESSON / ACTIVITY

The following are the details for constructing a hydroponic / aquaculture system for your classroom. I have used the apparatus for the past six years in my class with excellent results. A 100 gallon aquarium serves as our fish farm. Teams of students monitor the change in biomass of the fish population, (usually Tilapia).They also maintain records of the amount of high protein floating fish food consumed. As aquaculturist they try to develop a feeding regime that will maximize the fishes growth.

Water from this tank containing the fishes' metabolic wastes is pumped every thirty minutes through a series of five hydroponic tubes filled with lava rock. Seedlings in Jiffy 7 peat pots are inserted into circular holes in the tubes. This soilless garden can support about forty plants. We have grown many varieties of lettuce, spinach, herbs, tomatoes, cucumbers, jalapeno peppers, as well as many types of flowers. In addition, climbing plants such as morning glories or four o'clocks or nasturtia are grown directly from the surface of the aquarium by inserting Jiffy 7 pots into floating styrofoam. These are supported so they arch across the ceiling.

Unless there is a need for a specific photoperiod, lights are left on for 24 hours. Growth is rapid in the system. A crop of leafy vegetables like spinach or soft leaved lettuce is ready for harvest in about four weeks. There is ample time to allow each student in each class to grow his or her own crop and perhaps time for some special individual projects at the end of the year. We usually celebrate the harvest with a pizza and salad party made from the classes own vegetables, of course. While in use the system can be used to visually demonstrate many important scientific principles from a variety of disciplines such as, animal and plant physiology, microbiology, and, of course, ecology.

The construction details are as follows. The hydroponic tubes are made from four inch diameter, thin walled drainage pipe. Each tube is five feet long and has circular holes 1-1/2 inches in diameter, cut every six inches with a keyhole saw. Jiffy 7 pots fit snugly into these holes. The tubes are filled with lightweight lava rock which provide excellent surface area for root support. Plastic pipe caps are glued to each end of the growing tubes. Inlet holes are drilled 1/4 inch from the bottom of each cap and tee shaped fittings are cemented into each hole. One half inch flexible tubing connects each tube to a submersible sump pump at the bottom of the aquarium. Overflow drainage holes are drilled 1/2 inch from the top edge of each cap. One inch diameter tees are cemented here and connected by plastic tubing. This returns any overflow to the tank.

A one-hour constant cycle timer activates the pump for approximately one minute, every half hour. When the timer goes off, the remaining solution will drain back through the pump through the fill line. A 24hour timer should turn the lights on and off at intervals that are appropriate for the plants being grown.

A thirty gallon aquarium or reservoir should be sufficient for this project. If you have a commercial plant growing rack, a pair of discarded aluminum crutches make a fine superstructure for light support.

Materials and Approximate Cost:

- 25 feet of thin walled plastic drainage pipe (\$20)
- 10 feet of 1(one) inch diameter flexible plastic tubing (\$10)
- 10 feet of 1/2-inch diameter flexible plastic tubing (\$6)
- 6 plastic tees 1 inch diameter (\$6)
- 6 plastic tees 1/2 inch diameter (\$5)

- 2 tubes GOOP cement (\$8)
- 1 submersible recirculating pump (\$80)
- 8 boxes of lava rock (\$40)
- 1(one) 24hour on/off appliance timer (\$7)
- 1(one) 1hour constant cycling timer (\$60)
- Total cost = \$242

Hydroponic Systems.

Grade Level: 9-12

Overview

In this activity, students work with different hydroponic systems. Students set up one or more hydroponic systems and collect data for a four week period to determine which system resulted in the best plant growth. Students learn about the role of different environmental factors on plants grown in the absence of soil. Such factors include pH, light, and aeration.

Key Questions

- Which factors affect hydroponic plant growth?
- Which hydroponic system is best for growing select plants?

Time Frame: 4 weeks

Materials

Depending on which hydroponic systems are selected, different materials will be needed. In all the methods below, the "nutrient solution" may be prepared by contacting your local hydroponics supply store (in your local Yellow Pages) and following instructions from the supplier. Another valuable source of information on hydroponics is the Hydroponic Society of America, P.O. Box 3075, 2819 Crow Canyon Rd. Suite 218, San Ramon, CA 94583; phone: 510-743-9605; fax: 510-743-9302.

Getting Ready

Read through the Materials section to determine what materials, space, and other items are needed before beginning the activity. The setup will depend on which hydroponic systems are chosen. Plan on groups of at least 4 or more members.

Classroom Activity

1. Divide the class into experiment groups and assign each group to build at least one hydroponic system of their choice or your choice (depending on materials available). If possible, have groups choose and construct one or more of the above systems which they believe will result in maximum plant growth. Explain that each group will present their results to the class at the end of the activity.

2. In each system students should germinate and grow several lettuce plants for 2 to 4 weeks. They should check plants and record observations on a daily basis over that time period. Each student should create a data sheet for daily recording of data. Examples of factors to have on a data sheet include:

- pH of the nutrient solution (use pH paper)
- Plant's general appearance (Does the plant appear a healthy green? Are there yellow or brown spots?)
- Number of leaves present
- Length of selected leaves since some plants have more of a bushy shape
- Plant height

3. At the end of the four weeks of observation, have students separate the leaves from the roots. It is best to set the leaves aside and allow them to dry before weighing. Dry mass is the best indicator of plant growth success.

4. Have the students analyze and graph results to determine which hydroponic system is the best for lettuce.

Wrap-up Session

Review the results of each hydroponic system with the students. The instructor can have the students share their results with each other by having them present the results to the class. Based on their results, can they now answer the key questions posed at the beginning of the activity?

- Which factors affect hydroponic plant growth?
- Which hydroponic system is best for growing select plants?

More Activity Ideas

Have the students design an optimal hydroponic system based on the results they have collected from this activity.

Background for Teachers

Prerequisites:

- Ability to follow detailed instructions
- Ability to keep a lab book, to record observations
- Ability to work in a group

Vocabulary:

- **Germination** - to sprout from a seed into a seedling
- **Vermiculite** - material used as heat insulation for starting plant seeds
- **Perlite** - small pieces of white volcanic rock used in commercial potting soils
- **Hydroponics** - cultivation of plants in water containing dissolved inorganic nutrients rather than soil

Skills:

- Collecting and recording data

Constructing a graph from a table of data

Concepts:

- Hydroponics
- Capillary action
- Gravity flow

References

AUTHOR(S): Albright, L.D. 1997.

TITLE: Ventilation and shading for greenhouse cooling.

WHERE: Proceedings of the International Seminar on Protected Cultivation in India, December 18-19, Bangalore, India. pp. 17-24.

AUTHOR(S): Albright, L.D. 1997.

TITLE: Specifications, functioning and maintenance of equipment for forced cooling of greenhouses.

WHERE: Proceedings of the International Seminar on Protected Cultivation in India, December 18-19, Bangalore, India. pp. 25-32.

AUTHOR(S): Albright, L.D. 1997.

TITLE: Greenhouse thermal environment and light control.

WHERE: In Plant Production in Closed Ecosystems, E. Goto et al. (eds.). Kluwer Academic Publishers, the Netherlands. pp. 33-47.

ABSTRACT: Greenhouse thermal environment results from the interactions among numerous factors: solar insolation; structural thermal characteristics; operation of heating, ventilation, and cooling systems; supplemental lighting; and properties of the greenhouse crop are among the most important. As greenhouse technology and sophistication evolve and environmental control becomes more complete, the importance of supplemental lighting increases. Luminaires contribute a sensible cooling load directly, and a latent cooling load indirectly by influencing transpiration. The objectives of this paper are to provide a general overview of greenhouse thermal environment, outline a methodology for greenhouse supplemental lighting control, and explore the interactions of supplemental lighting and the thermal environment. The approach used is based on modeling of greenhouse thermal processes, and simulations of supplemental lighting system control.

AUTHOR(S): Albright, L.D. 1996.

TITLE: Controlled environment lettuce-production modules.

WHERE: Proceedings of the 26th National Agricultural Plastics Congress and the American Greenhouse Growers Association Conference, June 14-18, Atlantic City, NJ. pp. 265-270.

AUTHOR(S): Albright, L.D. 1996.

TITLE: The importance of design and control of light in high-productivity controlled environment agriculture (CEA).

WHERE: Keynote paper, presented at the International Conference on Agricultural and Biological Environment (ICABE), August 15-19, Beijing, China. China Agricultural University Press, Beijing, China. 6 pp.

ABSTRACT: Of the numerous environmental parameters important for plant growth, light (PAR) is arguably the second most important (with the first being, thereby, temperature). Light is the basis for plant g-rowth, timing and quality. If CEA facilities are to move to a higher level of sophistication and

productivity, lighting systems must be designed as carefully as are heating systems and light must be controlled as carefully as is temperature. Commercial computer programs exist that can be used to design supplemental lighting systems to achieve uniformity of PPF. New algorithms are being developed that can control supplemental lights and movable shade mechanisms either by PPF level as a function of the stage of growth, or to achieve the same total integrated PPF each day. This presentation describes the importance of light control for consistent plant growth and recent work that shows the benefits of controlling light to a consistent daily integral. The report also describes computer programs that can be used for design and then control to achieve that goal. The technical details form the basis for a wider vision of the potential for Controlled Environment Agriculture.

AUTHOR(S): Albright, L.D., and H.I. Henderson, Jr. 1996.

TITLE: **Air conditioning greenhouses to increase effectiveness of carbon dioxide enrichment.**

WHERE: ASAE paper 964007. ASAE, 2950 Niles Road, St. Joseph, MI 49085-9659. 15 pp.

ABSTRACT: Greenhouse lettuce, and other crops, can benefit from supplemental lighting to enhance growth on dark days. When carbon dioxide is added during lighted hours, growth may be enhanced further. Unfortunately, heat added by lights may initiate venting and waste carbon dioxide. This paper presents a simulation model that suggests a modest degree of air conditioning may be economically beneficial in permitting carbon dioxide enrichment without venting to substitute for supplemental lighting to enhance growth. The simulations suggest the savings of lighting costs may compensate for operating a simple air conditioning system during days of moderate cooling load and limited solar input.

AUTHOR(S): Albright, L.D. 1995.

TITLE: **Controlling greenhouse ventilation inlets by pressure difference.**

WHERE: HortTechnology 5(3):260-264.

ABSTRACT: Computerized control of the greenhouse climate has increased the importance of air distribution and mixing. This report reviews the fluid mechanics of air flow through ventilation inlets and external pressures imposed by winds and applies the analyses to suggest methods of inlet control that improve traditional greenhouse ventilation. The suggested improved control has been implemented in a five-section research greenhouse on the Cornell University campus and has improved climate control significantly during ventilation. Potential pitfalls in implementing the improved control methods are discussed.

AUTHOR(S): Albright, L.D. 1995.

TITLE: **Greenhouse lighting control to a daily PPF integral, with energy and cost consequences.**

WHERE: ASAE paper 954487. ASAE, 2950 Niles Road, St. Joseph, MI 49085-9659. 22 pp.

ABSTRACT: A methodology is described and, from it, an accompanying computer model has been developed to calculate the yearly operating cost of a supplemental lighting system for commercial greenhouses based on reaching a prescribed daily integral of PPF. The model is sensitive to time-of-day rates (including application of those rates to weekends and holidays), weather, greenhouse characteristics, luminaire characteristics, and greenhouse location.

AUTHOR(S): Albright, L.D. 1994.

TITLE: **Predicting greenhouse ventilating fan duty factors and operating costs.**

WHERE: ASAE paper 944576. ASAE, 2950 Niles Road, St. Joseph, MI 49085-9659. 20 pp.

ABSTRACT: A methodology is described and, from it, an accompanying computer model has been developed to calculate the yearly operating cost of a mechanical ventilation system for commercial greenhouses having no installed evaporative (or other) cooling system. The model is sensitive to time-of-day rates (including application of those rates to weekends and holidays), thermal parameters, fan characteristics, environmental control set points, and weather.

AUTHOR(S): Albright, L.D. 1994.

TITLE: **Fan operating costs for controlled environment agriculture.**

WHERE: Proceedings of the 5th annual CAEP Agricultural Demand-Side Management Conference. Albany, NY. May 3-5, 1994. A Northeast Regional Agricultural Engineering Service Publication. Riley-Robb Hall, Cornell University, Ithaca, NY 14853. pp. 51-60.

AUTHOR(S): Albright, L.D., and A.J. Both 1994.

TITLE: **Comparison of luminaires: efficacies and system design.**

WHERE: Proceedings of the International Lighting for Plants in Controlled Environments Workshop. University of Wisconsin, WI. March 27-30, 1994. NASA Conference Publication CP-3309. pp.281-297.

ABSTRACT: The trust of this report suggests supplemental lighting design processes that might be used to achieve desired PAR levels and adequate uniformity over a lighted space. Measured PAR distribution patterns from eight commercially available 400 W HPS luminaires are used in three design examples, implemented through a commercially-available lighting design computer program. Results suggest that PAR uniformity within $\pm 10\%$ is achievable at intensities of 200 and 300 micromol/sq. m/s in greenhouses and plant growth chambers. When PAR intensity is significantly lower (e.g., 50 micromol/sq. m/s), uniformity is more difficult to achieve. This study suggests the desirability of developing computer data file standards for PAR, rather than vision lighting, for commercial luminaires, and obtaining a consensus data base of surface reflectance values for materials used in plant growth chambers and greenhouses. Results also suggest that luminaire selection can have a significant effect on lighting energy use and operating cost because of different numbers of various models of luminaires required to meet a design goal, not just luminaire-to-luminaire efficacy differences.

AUTHOR(S): Both, A.J., S.S. Scholl, L.D. Albright, and R.W. Langhans. 1998.

TITLE: **Comparing continuous lettuce production in nutrient film technique and floating hydroponics.**

WHERE: Proceedings of the 15th International Lettuce Conference and Leafy Vegetable Crops Workshop. September 23-26, 1998. Atlantic City, NJ. pp. 16-17.

AUTHOR(S): Both, A.J., L.D. Albright, and R.W. Langhans. 1998.

TITLE: **Coordinated management of daily PAR integral and carbon dioxide for hydroponic lettuce production.**

WHERE: Acta Horticulturae 456:45-51.

ABSTRACT: The interaction between daily integrated photosynthetically active radiation (PAR) and elevated aerial CO₂ concentration was studied during plant growth experiments with leaf lettuce

(*Lactuca sativa* L., cv. Vivaldi) in a controlled environment agriculture facility (greenhouse) using the nutrient film technique. Accurate control of all environment parameters (except relative humidity) and four identical greenhouse sections constituted the experimental setup. Supplemental lighting (high pressure sodium lamps) was used to provide additional PAR to the lettuce on days when too little sunlight was available to reach the required daily light integral. Two experiments with four treatments each were performed to investigate six integrated PAR/CO₂ concentration combinations:-- 11/1500; 12/1250; 13/1000; 14/750, 15/530, and 16/400 (mol per sq. m per d/ppm). Lettuce plants were grown for 24 days under these conditions after being grown in a growth room under optimum conditions for 11 days. Periodic harvests during the greenhouse growing phase provided shoot dry mass data. Shoot fresh mass and number of leaves per plant were determined at the final harvest: 35 days after seeding. Plant growth under the six different treatments was virtually identical and resulted in an average shoot fresh mass of 190 g with a dry matter percentage of 3.7%. The results of the described experiments show a flexible management strategy regarding daily integrated PAR level and aerial CO₂ concentration can be employed for the most economical lettuce production.

AUTHOR(S): Both, A.J., C.A. Chou, L.D. Albright, and R.W. Langhans. 1997.

TITLE: **A microwave powered light source for plant irradiation.**

WHERE: *Acta Horticulturae* 418:189-194.

ABSTRACT: A new high intensity electrodeless light source, powered by two microwave generating units, was evaluated and compared with fluorescent and air- and water- cooled high pressure sodium (HPS) lamps. Radiation measurements were taken in the following wavebands: 400-700 nm (photosynthetically active radiation or PAR), 700-800 nm (far red), 800-2,800 nm (near infrared) and 2,800-50,000 nm (far infrared), for all four light sources. The distribution of the radiation output of the microwave lamp over the various wavebands closely resembled the output of a water-cooled HPS lamp, although the microwave lamp was capable of delivering much higher light intensities. The relatively small amount of radiation emitted in the infrared waveband makes the microwave lamp a promising light source for plant irradiation in growth rooms (phytotrons).

AUTHOR(S): Both, A.J., L.D. Albright, R.W. Langhans, B.G. Vinzant, and P.N. Walker. 1997.

TITLE: **Electric energy consumption and PPFi output of nine 400 watt high pressure sodium luminaires and a greenhouse application of the results.**

WHERE: *Acta Horticulturae* 418:195-202.

ABSTRACT: The PPFi (instantaneous photosynthetic photon flux, in micromol/sq. m/s) output and electric energy consumption of nine different 400 watt high pressure sodium (HPS) luminaires were measured at six mounting heights from 0.5 to 3.0 m in 0.5 m increments. Differences in luminaire efficacy and PPFi distribution patterns were found, but too few luminaires were tested to reach statistically valid conclusions. The most efficient luminaire proved 25% more energy efficient than the least efficient luminaire. PPFi data from one of the luminaires tested was used to design a research greenhouse which required uniform PPFi distribution patterns at various PPFi levels.

AUTHOR(S): Both, A.J., L.D. Albright, R.W. Langhans, R.A. Reiser, and B.G. Vinzant. 1997.

TITLE: **Hydroponic lettuce production influenced by integrated supplemental light levels in a controlled environment agriculture facility: Experimental results.**

WHERE: Acta Horticulturae 418:45-51.

ABSTRACT: Bibb lettuce (*Lactuca sativa* L., cv. Ostinata) was grown in peat-vermiculite plugs placed in a recirculating hydroponic (NFT) system. Supplemental lighting was used to reach different PPFTarget levels in each of 35 treatments. A second order exponential polynomial was developed to predict DW accumulation for PPFTarget levels between 8 and 22 mol m⁻² d⁻¹. Little difference in DW production was noted between lettuce grown under daytime and nighttime lighting. Tipburn was prevented using a fan blowing greenhouse air vertically down onto the lettuce plants. Marketable (150 g FW) lettuce heads were produced in 24 days after transplant while receiving an average PPFTintegral of 17 mol/sq. m/d.

AUTHOR(S): Both, A.J., A.R. Leed, E. Goto, L.D. Albright, and R.W. Langhans. 1996.

TITLE: Greenhouse spinach production in a NFT system.

WHERE: Acta Horticulturae 440:187-192

ABSTRACT: Primed spinach (*Spinacia oleracea* L., cv. Nordic) seed was started in rockwool slabs in a growth room for eight days before the seedlings were transplanted into a controlled environment greenhouse equipped with five identical, but separate, NFT systems. The day and night temperatures in the greenhouse were maintained at 24 and 18°C, respectively, with the daytime starting at 06:00 and ending at 22:00 hr. A photoperiod of 16 hrs was maintained, to prevent early bolting, and different target daily integrated light levels (PPF, in mol/sq. m/d) were studied to observe dry weight production. HPS lamps were used as the supplemental light source. Thirty-three days after seeding a final harvest was performed. Using the expolinear growth equation, dry weight production can be predicted based solely on target daily integrated light levels. Total chlorine residuals in the nutrient solution higher than 1 ppm were observed to be toxic. Root disease (rot) in the plant crown was found to be caused by *Fusarium*. Several remedies, including three biofungicides and potassium silicate, were tried but none proved to be consistently successful.

AUTHOR(S): Both, A.J.; 1995.

TITLE: Dynamic simulation of supplemental lighting for greenhouse hydroponic lettuce production.

WHERE: PHD Dissertation, Cornell University Libraries, Ithaca, NY 14853. 172 pp.

ABSTRACT: During an eight month period, hydroponic lettuce growth experiments, consisting of 35 different supplemental lighting treatments, were conducted in five identical greenhouse sections in order to: (1) determine how supplemental lighting can be used to ensure consistent and timely year-round greenhouse lettuce production in New York State, and (2) provide greenhouse growers and researchers with a computer simulation program to study the effects of different daily integrated light levels, indoor temperature, and plant spacing on the growth and development of lettuce. The daily integrated photosynthetically active radiation (PAR) was kept constant during each of the treatments by supplementing the solar PAR with PAR from 400 Watt high pressure sodium (HPS) lamps. Among treatments, daily PAR varied between 4 and 22 mol/sq. m/d. The indoor greenhouse environment was computer controlled and carbon dioxide enrichment (up to 1000 ppm) was used during the light period, but only when no ventilation was needed to maintain the temperature set point. The temperature was maintained at 24 and 18.8 deg C during the light and dark periods respectively. During the first 11 days, the lettuce seedlings were kept in a growth chamber under fluorescent lamps. After transplant, the plants remained 24 days in the greenhouse. Maintaining a daily PAR of 17 mol/sq. m/d in the greenhouse

resulted in a marketable lettuce head with a fresh weight of 150 grams (nearly 7 grams of dry weight) at 35 days after seeding. Lettuce tipburn was prevented using an overhead fan which blew ambient air downward onto the lettuce plants. The computer simulation program predicts dry weight production based on environment conditions in the greenhouse and plant parameters extracted from the literature. The universal crop growth model SUCROS87 was adjusted and incorporated in the simulation program. Using long-term average daily solar radiation data collected for Ithaca, NY, the simulation model successfully predicted dry weight production compared to plant dry weights measured during growth trials which were performed at Cornell University. The simulation program will be a helpful tool for commercial lettuce growers and future research.

AUTHOR(S): Both, A.J. 1994.

TITLE: **HID Lighting in Horticulture: a short review.**

WHERE: Greenhouse Systems, Automation, Culture and Environment. International Conference. Hyatt Regency Hotel, New Brunswick, NJ. July 20-22, 1994. Northeast Regional Agricultural Engineering Service, Publication 72. Riley-Robb Hall, Cornell University, Ithaca, NY 14853. pp. 208-222.

AUTHOR(S): Both, A.J., L.D. Albright, R.W. Langhans, B.G. Vinzant, and P.N. Walker. 1992.

TITLE: **Research on energy consumption of HID Lighting.**

WHERE: Proceedings of the 4th National CAEP Agricultural Demand-Side Management Conference. Syracuse, NY. October 20-22, 1992. Northeast Regional Agricultural Engineering Service, Publication 65. Riley-Robb Hall, Cornell University, Ithaca, NY 14853. pp. 125-134.

AUTHOR(S): Chiu, A.J. 1996.

TITLE: **Computer control of shade and supplemental lights for greenhouse hydroponic lettuce production.**

WHERE: MEng Report. Department of Agricultural and Biological Engineering, Cornell University, Ithaca, NY 14853. 44 pp.

ABSTRACT: The purpose of this project was to design and test a computer-controlled shade and supplemental lighting system for hydroponic lettuce production. The code was based on a Pascal algorithm, written by Dr. Louis D. Albright, whose work was a computer simulation study of this study. The goal was to determine how well theoretical and actual computations agree, and to control a physical system to achieve prescribed daily light integrals. The system consisted of a PS/2 computer, interfaced to high pressure sodium lamps, a horizontal shade curtain, and a Li-Cor quantum light sensor. A limited number of experiments were completed to test the algorithm's performance. The first set of experiments involved the use of an event recorder and theoretical events. The second set of experiments, however, tested the actual operation of the luminaires and the shade cloth. Difficulties were encountered in tuning the system for accurate light control, because some code parameters and constants needed to be altered by empirical means. The daily integrated photosynthetically active radiation (PAR) was achieved by supplementing the solar PAR with that from 400 Watt high pressure sodium (HPS) lamps, and by deploying the shade cloth to limit solar PAR on bright days. Both the operation of the lights and shade were used to try to achieve the target PAR goal of 17 mols per square meter per day. Lettuce crops were not grown in the greenhouse area, since extensive studies have shown that an accumulation goal of 17 mols per square meter per day is the optimum light level for quality Ostinata lettuce production.

Therefore, it was assumed that if the system was able to maintain this desired daily PAR, then lettuce crops can be grown with this shade and lighting system. The control system was reliable for short-term experimentation, but long-term reliability has yet to be tested. Testing occurred during several days in the month of April. However, testing during the summer months, the period of greatest light insolation, still needs to be performed.

AUTHOR(S): Ciolkosz, D.E., L.D. Albright, and J.C. Sager. 1998.

TITLE: Microwave lamp characterization.

WHERE: Journal of Life Support and Biosphere Science Vol. 5:00-00. 18 pp. In Press.

ABSTRACT: The operating properties of the SAA microwave lamp, developed by Fusion Lighting Inc., were determined with reference to its usefulness in Bioregenerative Life Support Systems (BLSS). Lamp flux density in several wavelength ranges, spectral output, and temperature response (-10 to +40 deg C) were determined by mounting the lamp and sensors in a controlled environment chamber. Lamp intensity distribution was also measured using a swing arm apparatus with a 1m radius. A model was developed to characterize the intensity distribution of the lamp as a function of lamp geometry and output properties. The lamp was found to produce a spectral output similar to that of earlier models, but with a higher photosynthetic output per lumen and per input watt. Radiant energy output was measured to be 0.399 radiant watts per micromol/s PAR compared with 0.56 radiant watts per micromol/s PAR for high pressure sodium lamps. Total lamp output dropped approximately 0.4% for every degree C rise in ambient temperature, with little change in light quality. The intensity distribution of the lamp was found to produce a fairly uniform flux density (+/- 22%) in a 40 degree cone from lamp nadir. the advantages and drawbacks of this light source for use in BLSS are discussed.

AUTHOR(S): Ciolkosz, D.E. and J.C. Sager. 1998.

TITLE: Imaging of LED array flux densities.

WHERE: Journal of Life Support and Biosphere Science Vol. 5:00-00. 15 pp. In Press.

ABSTRACT: Arrays of light emitting diodes (LEDs) are being used in life science plant flight experiments and show promise for use in Bioregenerative Life Support Systems (BLSS). However, the small volume and short distances from the LED array necessary in these applications create several unique problems. The discrete LEDs are small and the spatial non-uniformity of the lamps near the array results in significant irradiance variation on surfaces near the array. These irradiance variations make it difficult to use traditional hand held sensors to measure the light levels under the array accurately. The usefulness of rear projection video camera imaging is investigated for the analysis of uniformity of irradiance from an LED array. Irradiance measurements were taken at a high mounting height from the array using both a 400-700 nm quantum sensor and a video camera. Additionally, video images were recorded at different mounting heights from the array. The rear projection imaging technique was suitable for analyzing the irradiance from LED arrays. Comparison of the readings from the video image and the sensor suggests that there is a non linear relationship between video image reading and sensor value ($R^2 = 0.884$). These data also show that the average photosynthetically active radiation level (PAR) does not change as mounting height varies, but that the spatial uniformity of the PAR does increase as mounting height increases. These results are consistent with geometrical analyses of the system.

AUTHOR(S): Ciolkosz, D.E., and L.D. Albright. 1997.

TITLE: Evaluation of whole plant transpiration as affected by greenhouse air movement.

WHERE: ASAE paper No. 974029. ASAE, 2950 Niles Road, St. Joseph, MI 49085-9659, USA. 18 pp.

ABSTRACT: Investigations were conducted to determine the degree to which evaporation of reverse osmosis treated water from petri dishes can be used to predict evapotranspiration in hydroponic greenhouses and, in turn, to evaluate airflow systems for their ability to induce evapotranspiration. The relationship between crop evapotranspiration and dish evaporation was found to be linear, with an R sq. (adj) of 0.592. Adding CO₂ concentration to the relationship improved the R sq. (adj) to 0.895. Severity of tipburn also evinced a relationship with dish evaporation rate, but as a step function. Dish evaporation rates greater than 2 cm per day resulted in the least tipburn on the crops. The crop coefficient, K_c, varied in a manner consistent to that of field crops, except for a sharp drop at the time of plant respacing. The pan coefficient, K_p, showed no noticeable trends with respect to time, and had an average of 0.215. Side by side comparisons of different air distribution systems suggested that air distribution has a large effect on dish evaporation (and, hence, plant evapotranspiration) and that unit heaters placed in a collision flow or shear flow configuration can achieve a greater level of uniformity of evaporation than use of overhead turbulator fans. The application of this information to the design of air distribution systems for greenhouses is discussed.

AUTHOR(S): Ciolkosz, D.E., L.D. Albright, and A.J. Both. 1998.

TITLE: Characterizing evapotranspiration in a greenhouse lettuce crop.

WHERE: Acta Horticulturae 456:255-261.

ABSTRACT: Tipburn, a physiological disorder of lettuce, has been linked to insufficient evapotranspiration (ET). Better understanding of ET in greenhouse lettuce crops may be useful as a management tool to control tipburn. A regression model is presented to characterize ET from greenhouse lettuce (*Lactuca sativa* L., cv. "Vivaldi") based on data from twelve crops grown in a nutrient film technique (NFT) system. Several CO₂ concentrations and daily light integrals were applied to the lettuce crops and the resulting daily ET integrals were measured. A regression model was derived for daily ET as a function of growth rate and the resulting daily and cumulative ET values were calculated and compared to measured values. ET rate was found to vary linearly with growth rate (R sq. (adj) = 0.63) but higher CO₂ levels were associated with lesser values of the slope of the relationship. Modeled and measured data were in good agreement even though relative humidity was not included in the model. An equation is presented that may be useful to calculate daily ET targets that must be achieved to prevent tipburn in hydroponic lettuce.

AUTHOR(S): Controlled Environment Agriculture Program. 1996.

TITLE: Controlled environment agriculture scoping study.

WHERE: Electric Power Research Institute Publication CR-107152. EPRI, 3412 Hillview Avenue, Palo Alto, CA 94304. 70 pp.

AUTHOR(S): Dalrymple, K. D. 1998.

TITLE: Study of the water-jacketed high pressure sodium lamp: bare lamp flux density experiments, reflector design, and placement within a growth chamber.

WHERE: MEng Report. Department of Agricultural and Biological Engineering, Cornell University,

Ithaca, NY 14853. 120 pp.

ABSTRACT: Horticultural lighting systems are used in growth chambers to produce high flux density, uniform lighting conditions for plant growth. However, infrared radiation (heat) generated by these lighting systems must be removed from the growth chamber for temperature control. Heat rejection via mechanically cooling growth chamber air can be costly. In water-jacketed lamps, water is circulated around the lamp as a mechanism for heat removal from the lamps. A water-jacketed high-pressure sodium (HPS) lamp made by Bhalla Lighting, Inc. was tested for light output. A photosynthetically active radiation (PAR) sensor was used to record flux density readings at varying angles from 0 to 90 degrees along a path 1.0 m from the lamp. Readings were taken along the front, sides, and back of the lamp. The inverse square law was used to convert the flux density data into lamp PAR intensity distributions. The light intensity distribution of the water-jacketed HPS lamp was compared to light intensity distributions of two non-water-jacketed HPS lamps. Tests were also conducted to determine if lamp efficiency was temperature dependent. Wattage through the ballast was measured for non-water-jacketed and water-jacketed lamp situations. Light output and wattage of the water-jacketed lamp were less than those of the non-water-jacketed lamps. Lamp intensity distributions were used to create a luminaire data file for use in Photopia, a reflector design software package created by Lighting Technologies, Inc. Water-jacketed HPS lamp and reflector designs were created using AutoCAD R13 and then tested in Photopia. The most suitable luminaire (lamp and reflector combination) was then used in Lumen Micro, another lighting program developed by Lighting Technologies, Inc., to generate a lighting plan for a plant growth room at the Cornell University CEA Demonstration Greenhouse Facility. The lighting grid was designed to deliver maximum light uniformity at the plant growth surface. The advantages and disadvantages of water-jacketed HPS lamps are discussed. Recommendations for further development of water-jacketed HPS lamps are made. Useful practical advice is given on the use of the water-jacketed lamp in the Cornell University CEA Demonstration Greenhouse Facility.

AUTHOR(S): Danish, W.E. 1994.

TITLE: **A growers' guide to lettuce crop production using nutrient film technique in controlled environment agriculture facilities.**

WHERE: MPS Project Report. Cornell University Libraries, Ithaca, NY 14853. 68 pp.

ABSTRACT: The purpose of this project is to provide a summary of the present level of technology in the production of lettuce in Controlled Environment Agriculture (CEA) and a step-by-step practical growers' guide to greenhouse lettuce crop production using nutrient film technique. The CEA research program began several years ago at Cornell to develop and demonstrate new technologies and cultural methods aimed at improving the profitability of horticultural crop production in controlled environments. CEA is not a completely new idea, but an optimization of all know elements affecting plant growth. When the usual environmental factors for crop production are optimized, temperature, water, and nutrients, the limiting factor to plant growth is light. Plants need light to grow, and in the North East growers must rely on supplemental lighting during the winter months to produce a finished crop in a reasonable time. Now, the cost of electricity is the largest component of variable costs. This guide leads growers through lettuce crop production using nutrient film technique. In order for CEA to be successful, the grower must be vigilant in adherence to the recommended principles shown here. Without the buffering advantage of a crop grown in soil, any mistake, however small, can be fatal to the lettuce crop. For all this trouble, the rewards can be great. The lettuce can grow from seed to a marketable 5 ounce

head in just 35 days by following directions.

AUTHOR(S): de Villiers, D.S. 1997.

TITLE: **Vegetable cultivar evaluation and crop selection for controlled environment agriculture and advanced life support systems.**

WHERE: MSc Thesis. Cornell University Libraries, Ithaca, NY 14853. 176 pp.

ABSTRACT: Cultivar evaluation for controlled environments is a lengthy and multifaceted activity. The chapters of this thesis cover eight steps preparatory to yield trials, and the final step of cultivar selection after data are collected. The steps are as follows: (1) Examination of the literature on the crop cultivars to access the state of knowledge. (2) Selection of standard cultivars with which to explore crop response to major growth factors and determine set points for screening and, later, production. (3) Determination of practical growing techniques for the crop in controlled environments. (4) Design of experiments for determination of crop responses to the major growth factors, with particular emphasis on photoperiod, daily light integral and air temperature. (5) Developing a way of measuring yield appropriate to the crop type by sampling through the harvest period and calculating a productivity function. (6) Narrowing down the pool of cultivars and breeding lines according to a set of criteria and breeding history. (7) Determination of environmental set points for cultivar evaluation through calculating production cost as a function of set points and size of target facility. (8) Design of screening and yield trial experiments emphasizing efficient use of space. (9) Final evaluation of cultivars after data collection, in terms of production cost and value to the consumer. For each of the steps, relevant issues are addressed. In selecting standards to determine set points for screening, set points that optimize cost of production for the standards may not be applicable to all cultivars. Production of uniform and equivalent-sized seedlings is considered as a means of countering possible differences in seed vigor. Issues of spacing and re-spacing are also discussed. In mapping crop response to growth factors, it is proposed that a first set of experiments examine daylength sensitivity and light intensity effects by holding daily light integral constant while varying photoperiod and light intensity. A second set of experiments would vary daily light integral at a fixed photoperiod appropriate to the crop to explore limits on productivity. Temperature would be varied in both sets of experiments. For most vegetable crops, comparison of cultivars of different maturity date requires discovery of the yield function over the harvest period, from which can be ascertained when productivity is maximum. At least three harvests timed to bracket the peak in productivity are advised. Arguments are presented that the most likely and feasible source of superior materials for controlled environments will be from breeding lines currently under evaluation. Fast screening procedures are proposed to ascertain plant characteristics other than yield performance when information is lacking. Set points for yield trials need to be those for production; appropriate set points cannot be determined without economic analysis of facility cost, labor cost, and cost of supplying inputs. To economize on space needed for yield trials, I have proposed use of opaque, reflective side walls between cultivars and sample harvest units to replace guard rows and accommodate staggered harvests. The cost of production index (COPI) is the single most important criterion for cultivar evaluation. For commercial CEA, final selection of cultivars requires market analysis additionally because the cheapest cultivar to produce may to be the best seller. For space life support, post-harvest processing costs need to be included with production costs. The value of superior quality and palatability in fostering well-being of colonists needs to be weighed against additional cost in providing it. Crop selection for space colonies is addressed in the introductory and penultimate chapters. It is argued that

crop selection should be guided from menu in addition to nutritional goals and minimization of cost.

AUTHOR(S): Goto, E., A.J. Both, L.D. Albright, R.W. Langhans, and A.R. Leed. 1996.

TITLE: Effect of dissolved oxygen concentration on lettuce growth in floating hydroponics.

WHERE: Acta Horticulturae 440:205-210.

ABSTRACT: Lettuce (*Lactuca sativa* L., cv. Ostinata) growth experiments were carried out to study the effect of dissolved oxygen (DO) concentration on plant growth in a floating hydroponic system. Pure O₂ and N₂ gas were supplied to the hydroponic system for precise DO control. The system allowed for DO concentrations above the maximum possible saturation concentration attainable when using compressed air. Eleven day old lettuce seedlings were grown for 24 days under various DO concentrations: sub-saturated, saturated, and super-saturated. There was no significant difference in fresh weight, shoot and root dry weight among the following DO concentrations: 2.1 (25% of saturated at 24°C), 4.2 (50%), 8.4 (saturated), and 16.8 (200%) mg/L. The critical DO concentration for vigorous lettuce growth was considered to be lower than 2.1 mg/L. Neither root damage nor delay of shoot growth was observed at any of the studied DO concentrations.

AUTHOR(S): Goto, E.; Albright, L.D.; Langhans, R.W.; Leed, A.R. 1994.

TITLE: Plant spacing management in hydroponic lettuce production.

WHERE: ASAE paper 944574. ASAE, 2950 Niles Road, St. Joseph, MI 49085-9659. 13 pp.

ABSTRACT: Three different spacing options were tested in a hydroponic lettuce production system. Two kinds of productivity and a growing area utilization efficiency factor were introduced to compare practical spacing management with idealized spacing management for individual days during a production period, and over the entire production.

AUTHOR(S): Langhans, R.W. 1994.

TITLE: Fluorescent and high intensity discharge lamp use in chambers and greenhouses.

WHERE: Proceedings of the International Lighting for Plants in Controlled Environments Workshop. University of Wisconsin, Madison, WI. March 27 - 30, 1994. NASA Conference Publication CP-3309. pp. 211-215.

AUTHOR(S): Lin, S.Y. 1995.

TITLE: Effects of seed hydration treatments, media moisture content, and inhibitors on spinach (*Spinacia oleracea* L.) seed germination.

WHERE: MSc Thesis. Cornell University Libraries, Ithaca, NY 14853. 66 pp.

ABSTRACT: The pericarp of spinach (*Spinacia oleracea* L.) seed plays a major role in germination. Excess water and inhibitors in the pericarp both may cause poor germination of seeds. This research focused on optimal seed hydration treatments, the optimum range of media moisture content, and temperatures on germination of spinach (cv. 'Nordic') seeds. The bio-effects of inhibitors leached from the seeds were also investigated. Data were logarithmically transformed and analyzed by analysis of variance and trend analysis. The spinach seeds were primed under dark conditions in 30% polyethylene glycol (PEG) solutions at 15 deg C for 1 to 4 days, and germinated again under dark conditions at 15, 20, and 25 deg C for 7 days. Germination performance was evaluated by final germination percentages, rate (T₅₀), and uniformity (T[90-10]). Interactions between PEG soak duration and germination temperature

did not reveal consistent trends. One day priming, which resulted in rapid germination and high germination percentage, is recommended because less PEG is used and less time is consumed in priming. In an alternative approach, spinach seeds were hydrated in reverse osmosis (RO) water at 10 or 15 deg C for 24, 36, and 48 hours. The shortest hydration time of 24 hours was recommended based on the improvement in uniformity of germination. Hydration treatments in water were superior or equal to priming with respect to rate of germination. Spinach seeds were sensitive to moisture during the germination stage, more seriously in wet conditions than dry conditions. The range of blotter moisture was adjusted between 11 ml and 21 ml RO water per container in the first study, but results indicated that amounts over 15 ml were too great for the spinach seeds to germinate well. Therefore, the range of blotter moisture was between 6 ml and 15 ml in the second study, and the results demonstrated 6 ml was still enough for good germination even though the blotters appeared dry. Seed germination performance indicated that the addition of 9 to 12 ml RO water was the most effective for good germination. Seven bioassay experiments were designed to investigate the effects of inhibitors in the spinach seeds. The seeds were soaked in RO water at 5 to 25 deg C for varied times--6 hours, one, and two days. After the seeds were soaked a certain time, the solutions were used to moisten broccoli ('Pirate'), and lettuce ('Ostinata', 'Summertime', and 'Empire') seeds. The effects of the leachate were evaluated by the final germination percentage and radicle growth of the broccoli or lettuce seeds. The results of these experiments do not show a clear relationship between soaking temperature and inhibitor removal. Overall, inhibitors leached from spinach seeds have a negligible or inconsistent effect on germination or root growth of lettuce or broccoli.

AUTHOR(S): Mathieu, J.J., L.D. Albright, K. Kurata, and E. Goto. 1998.

TITLE: Whole crop simulation model of water and nutrient uptake within a recirculating hydroponic system: a literature review. 2 pp.

AUTHOR(S): Reinhardt, W.W. 1994.

TITLE: Net energy analysis of vegetable crops.

WHERE: Presented at the 5th Annual CAEP Conference, May 3-5, Albany, NY. A Northeast Regional Agricultural Engineering Service Publication. Riley-Robb Hall, Cornell University, Ithaca, NY 14853. pp. 61-68.

ABSTRACT: This paper will define controlled environment agriculture (CEA) for the year-round production of fresh vegetables in New York State. The New York State Energy Research and Development Authority (Energy Authority) is supporting CEA development because it is a growing industry that will cause significant impacts on energy use and agricultural employment, while avoiding the environmental emissions associated with conventional vegetable production. CEA research at Cornell University (Ithaca, NY) is supported by the Energy Authority and the State's electric utilities. Researchers are investigating energy management opportunities in the operation of CEA facilities to minimize operating energy costs for growers and peak load growth for electric utility systems. Finally, this paper will evaluate and compare energy requirements to grow fresh vegetables in New York, using CEA techniques like those being developed at Cornell, with existing alternatives of field crops and greenhouse production grown off-season in the South and West, or greenhouse production grown in Europe.

AUTHOR(S): Rerras, N. 1996.

TITLE: **Neural network modeling of the greenhouse aerial environment.**

WHERE: MSc Thesis. Cornell University Libraries, Ithaca, NY 14853. 89 pp.

ABSTRACT: Use of neural networks to model multi-input multi-output processes is becoming a popular technique in modern control applications. In this thesis neural networks are considered for modeling the short term response of the greenhouse aerial environment. Different neural network architectures are considered such as multilayer feedforward networks and Elman recurrent networks. Their performance is compared using data from a greenhouse simulation model as well as actual greenhouse operational data. The methods are also compared to more conventional modeling methods such as autoregressive moving average exogenous (ARMAX) models. Suitable methods for implementation, training and testing are considered. Feedforward neural networks proved more suitable for greenhouse environment modeling than Elman networks. Feedforward networks also achieved better predictions than ARMAX models at the expense of longer training. Elman networks provided fairly good predictions but needed significantly longer training than feedforward networks. Neural network application in a commercial greenhouse environment is hindered by their need for computing resources. ARMAX models still present the most cost-effective alternative for modeling the greenhouse environment, due to their modest demands in computing resources. Neural networks are feasible, perform better, and will eventually become more attractive as advanced computing platforms become more affordable.

AUTHOR(S): Setiawan, A. 1998.

TITLE: **Applying pseudo-derivative-feedback algorithm to greenhouse temperature control.**

WHERE: MSc Thesis. Cornell University Libraries, Ithaca, NY 14853. 169 pp.

ABSTRACT: The Pseudo-Derivative-Feedback (PDF) control algorithm is applied to control greenhouse air temperature. A forced-air hot water heating system and a pad and fan cooling system are controlled by the PDF algorithm. Performance of the PDF control is compared to Proportional-Integral (PI) control through simulation with an approximated dynamic system model of the greenhouse air. The difficulties of time delays in a control system are discussed. The importance of recognizing the effects of time delays on control system performance for both PDF and PI control is demonstrated with a comparison between control systems with and without the time delay. Additional experiments with PDF, PDF cascade, and PI control are performed to compare the performance of each control scheme. The PDF cascade system controls both heating-system water temperature and greenhouse air temperature. Results of simulation and real-world experimentation show that PDF control has a better load handling capability than PI control. Changes in a final-control-element, FCE (e.g., variation in the temperature of the hot-water supply, or nonlinearity in the heating system valve), were best handled by the PDF cascade control system.

AUTHOR(S): Setiawan, A., L.D. Albright, and R.M. Phelan. 1998.

TITLE: **Simulation of greenhouse air temperature control using PI and PDF algorithms.**

WHERE: Proceedings of the first IFAC Workshop on Control Applications and Ergonomics in Agriculture, Athens, Greece. June 15-17, 1998. pp. 111-116.

ABSTRACT: Pseudo-Derivative-Feedback (PDF) control is compared to PI control through simulation using an approximated dynamic system thermal model of the greenhouse and through experiment results. The effects of time delays on control system performance for both PDF and PI control are demonstrated.

Results showed PDF control to have a better load handling capability than PI control. PDF control was exceptionally better than PI for systems without time delay and significantly better for systems with time delay.

AUTHOR(S): Spinu, V.C., L.D. Albright, and R.W. Langhans. 1998.

TITLE: **Electrochemical pH control in hydroponic systems.**

WHERE: *Acta Horticulturae* 456:275-282.

ABSTRACT: This paper reports an innovative method based on electrochemistry to adjust the pH in nutrient solutions used in hydroponics. The required quantity of H⁺ or OH⁻ ions is produced in-situ through electrolytic water decomposition. Because the direction and rate of electrochemical reactions can be easily manipulated by controlling the polarity and voltage applied between electrodes, the most important advantage of this method in comparison to traditional pH control using chemicals is the possibility to accomplish accurate and reliable pH control to within a narrow, preset pH range. Moreover, additional positive effects of improving the quality of added raw water such as alkalinity control, reducing the concentration of sodium, and water disinfection can be accomplished in the same electrolytic unit. Electrochemical technology offers possibilities to eliminate the risk of pH control failures due to overdoses and excludes the necessity of having reagent (acid and base) storage tanks and of handling these hazardous materials. Important savings of reagents, dosage and mixing equipment, storage tanks and improved environment and safety objectives can be realized. Available greenhouse space can be used more efficiently.

AUTHOR(S): Spinu, V.C., and L.D. Albright. 1998.

TITLE: **Electrotechnology for water conditioning: A simulation model.**

WHERE: *Acta Horticulturae* 456:283-290.

ABSTRACT: This paper relates some aspects of an innovative electrotechnological approach focused on improving water quality for horticultural use. Principal processes to condition water for plant growth (related to alkalinity; mineralization; sodium; pH and disinfection) are accomplished in a simple, low-cost, electrolytic unit, which can be affordable for individual growers. Installing such a water conditioning unit directly in a greenhouse achieves additional positive effects. One which makes this technology particularly useful in a greenhouse is the evolution of pure CO₂ as a result of bicarbonate ion decomposition. A simulation model has been developed using MS EXCEL worksheets to predict the dynamics of all important processes related to water treatment in the electrotechnological unit. This computer model establishes the relationships among (1) design parameters such as the type, number and geometry of electrodes, type of membrane, voltage level applied between electrodes, water flow rate through the treatment chamber; (2) raw water quality parameters such as: total dissolved solids (TDS), concentrations of principal ionic species (Na⁺, Ca²⁺, Mg²⁺, HCO₃⁽⁻⁾, SO₄⁽²⁻⁾, Cl⁽⁻⁾), alkalinity, hardness, pH, EC, temperature; (3) the same parameters for water after treatment; (4) regime and efficiency parameters (electrical current applied, electricity and energy consumed per cubic meter of treated water, current efficiency for TDS removal; and (5) quantities of by-products derived from the processes accompanying operation of an electrolytic water conditioning unit (O₂, CO₂, base solution). An analysis of the applicability and efficiency of this electrotechnological approach for improving water quality from the main natural water sources of Moldova was completed using this simulation model. The electrotechnology can contribute efficiently to the successful development of intensive horticulture in

Moldova and other regions of the world.

AUTHOR(S): Stevenson, C.L. 1993.

TITLE: **Consumer Preferences for Greenhouse Grown Bibb Lettuce: an Application of Conjoint Analysis.**

WHERE: MSc Thesis. Cornell University Libraries, Ithaca, NY 14853. 89 pp.

ABSTRACT: The purpose of this study is to analyze consumers' preferences for greenhouse grown bibb lettuce. Consumers' preferences are elicited using a decompositional method of preference structure measurement known as conjoint analysis. The research design includes the product attributes packaging, price, and pesticide-free. Results are analyzed at the individual as well as the market level. At the individual level, a main effects plus two-way interaction model is estimated for each individual. At the market level, a main effects model is used to determine whether purchase frequency of greenhouse grown bibb lettuce is related to consumers' preferences for the products' attributes. At the individual level, the results indicate packaging has a significant effect for 75% of the respondents; pesticide-free has a significant effect for 35% of the respondents, and price has a significant effect for 23% of the respondents. There is a large amount of heterogeneity in consumers' preferences for packaging at the individual level. However, the majority of consumers prefer the plastic bag and dislike the crisper. Consumers are split on their preferences for no packaging. More respondents have a significant interaction between packaging and pesticide-free than between packaging and price or between pesticide-free and price. With the exception of the interaction between pesticide-free and the plastic bag, there is a large amount of heterogeneity in the direction of the interaction effects. The interaction between pesticide-free and plastic bag is positive for 72% of the respondents for whom this is a significant interaction. At the market level, respondents in the frequent and moderate purchase frequency groups have the same preferences for the attributes used in the design. Respondents in the infrequent purchase frequency group are more price sensitive than the market average and have a greater than average preference for the pesticide-free attribute. Respondents who never purchase greenhouse grown bibb lettuce have a greater than average preference for no packaging and a greater than average disutility for the crisper. Based on these results, the product, as it is presently marketed in Binghamton and Vestal, is only the fifth most preferred product profile for the frequent and moderate purchase frequency groups and the fourth and sixth most preferred product profile for the infrequent and never purchase frequency groups. The product profile packaged in the plastic bag with the lower price level and the pesticide-free label is the most preferred profile for all purchase frequency groups. therefore, the results indicate the utility of the product may be increased by changing the packaging type.

AUTHOR(S): Thompson, H.C. 1997.

TITLE: **Air and root temperature effects on growth of lettuce, *Lactuca sativa*, in deep-flow hydroponic systems.**

WHERE: MSc Thesis. Cornell University Libraries, Ithaca, NY 14853. 89 pp.

ABSTRACT: Lettuce production is often limited geographically by boundaries where air temperature is outside the range possible for sufficient vegetative growth. This study, in particular, addresses air temperature ranges above the normal growing temperature for butterhead lettuce (*Lactuca sativa* L., cv. 'Ostinata'). The question of interest is whether lettuce can be produced in warm air environments by cooling the root zone. Conversely, we examine if cool air temperatures can be compensated for by

increasing root zone temperatures. The mechanism examined is control of temperature at the growing point. By creating a gradient of temperatures between air and root environment, we examine how the temperature at the growing point is affected, and, in turn, how the growth rate of that particular treatment is affected by the temperature gradient, and the temperature at the growing point. Lettuce seedlings were germinated in growth chambers and transplanted after eleven days into three hydroponic ponds in a greenhouse. The crop grew in the ponds until final harvest 35 days after seeding. Each greenhouse crop was grown at a constant air temperature. Daytime temperature set points were centered on 24 deg C, the optimum temperature for lettuce growth. Air temperature set points were 17 deg C (62.6 deg F), 24 deg C (75.2 deg F), and 31 deg C (87.8 deg F), and dropped 5 deg C during the night. Each of the three pond's nutrient solution was set to one of these daytime set point temperatures (17, 24, and 31 deg C) for each crop. After a crop's final harvest, a new crop was brought into a different greenhouse air temperature, and with the same three water temperatures randomized among ponds. The study consisted of six experiments. The first three experiments used each of the three air temperature set points, and the second three experiments were replicates of the first set. Harvests were taken on days 14, 21, 28, and 35 and dry weights measured. Temperatures at the growing point and at 1 and 2 cm depth in the soil plug were measured with thermocouples and an infrared thermometer. Analysis was done using a split-plot design with air temperature as the main treatment, pond water temperature as a sub-treatment, and harvest day as a sub-sub-treatment. Dry weight was used as response variable. Air temperature had a significant effect on the growth curves. Each air temperature produced a significantly different rate of growth regardless of water temperature. The main effect of water temperature on dry weight was significant. There was no statistical interaction between air and water temperature. The optimal temperature for lettuce dry weight production was 24 deg C air and 24 deg C water. The temperature at the growing point was not affected by the air/water temperature gradient for most of the growth cycle. We found control of growth rate through growing point temperature not possible, yet growth rate was influenced by air/water temperature gradient. Root temperature greatly contributed to final dry weight and quality of the crop. Growth curves were analyzed to find the date of harvest when differences among ponds within one air temperature treatment became significant. All curves showed that differences were notable by day 21 and significant in all treatments by day 28. A simple computer model was written to calculate final dry weight from air and water temperature set points.

AUTHOR(S): Thompson, H.C., R.W. Langhans, A.J. Both, and L.D. Albright. 1998.

TITLE: **Shoot and root temperature effects on growth of lettuce, *Lactuca sativa*, in a floating hydroponic system.**

WHERE: Journal of the American Society for Horticultural Science 123(3):361-364.

ABSTRACT: Butterhead lettuce (*Lactuca sativa* L., cv. *Ostinata*) was used to study lettuce production at varied shoot (air) and root (pond) temperatures. A floating hydroponic system was used to study the influence of pond temperature on lettuce growth for 35 days. Pond water temperature set points of 17, 24 and 31 deg C were used at air temperatures of 17/12, 24/19, and 31/26 deg C (day/night). Pond temperature affected plant dry mass, and air temperature significantly affected growth over time. Maximum dry mass was produced at the 24/24 deg C (air/pond temperature) treatment. Final dry mass at the 31/24 deg C treatment did not differ significantly from the 24/24 deg C treatment. The 24 deg C pond treatment maintained market quality lettuce head production in 31 deg C air. Using optimal pond temperature, lettuce production was deemed acceptable at a variety of air temperatures outside the

normal range, and particularly at high air temperatures.

AUTHOR(S): Wheeler, E.F., L.D. Albright, R.M. Spanswick, L.P. Walker, and R.W. Langhans. 1998.

TITLE: Nitrate uptake kinetics in lettuce as influenced by light and nitrate nutrition.

WHERE: Transactions of the ASAE 41(3):859-867.

ABSTRACT: A mathematical relationship was developed which shows environmental influences of light and nitrate nutrition on growth and nitrate uptake kinetics. Growth chamber experiments provided data for model development and validation. Ion-specific macro-electrodes determined nitrate depletion from circulating solutions in short-term kinetic tests. Lettuce (*Lactuca sativa* L., cv. Ostinata) was grown under three light levels and three nutrient solution nitrate contents which represented a range of adequate and inadequate environments. Larger, faster-growing plants should have a larger demand for nitrate and hence larger uptake rates than smaller, environmentally stressed plants. Results showed higher sustained levels of nitrate uptake by larger plants. Neither the severity of stress under which a plant was grown nor the plant size were the sole determinants of maximum potential uptake behavior, however. Increased light level was related to an increased ability to transport nitrate on a short-term basis. Increased light level was associated with increased maximum nitrate uptake rates (V_{max}) as described by the Michaelis-Menten relationship. The effects of environmental light and nitrate levels on nitrate uptake was incorporated into a power relationship where the maximum uptake velocity was determined in relation to the shoot growth rate.

AUTHOR(S): Wheeler, E.F., and L.D. Albright. 1995.

TITLE: Quantification of lettuce growth in relation to environmental stress.

WHERE: ASAE paper No. 954461. ASAE, 2950 Niles Road, St. Joseph, MI 49085-9659, USA. 25 pp.

ABSTRACT: The objective of this research was to determine how age, nitrate nutrition and light level influenced growth and associated nitrate uptake rates over the commercial production period of hydroponically grown lettuce. Three N levels were combined with three light zones for nine treatments of lettuce in one growth chamber. Light level was varied from 135 to 375 micromol/sq. m/s and nitrate-nitrogen level was supplied at 0.04, 0.4 or 4.0 mM. Plants do not respond linearly to light and nitrogen levels and these two environmental factors interact in ways difficult to interpret. Treatments were compared to each other through an Environmental Growth Factor (EGF). Shoot growth rate EGF ranked plants logically into more or less stressful environments. Low-light/low-nitrogen plants had the lowest EGF with values around 0.2, meaning their growth rates were about 20% of the high-light/ high-nitrogen treatment growth rates. Dry weight increase was best represented by an exponential polynomial having three empirical parameters. When coefficient values were graphed and differentiated by light and nitrogen levels, a relationship among the nine treatment parameters emerged. From the relationships, growth curves can be constructed by interpolation for lettuce grown between the specific light and nitrogen levels of this experiment. Biomass was partitioned to leaves and roots differently, depending on environmental conditions to which the plant was exposed. Root masses of low nitrogen-grown lettuce were particularly large, with root:shoot ratios approaching 1.0 under low light conditions. Root dry weight was influenced almost exclusively by the nitrogen level in which the plants grew. Shoot dry weights were more indicative of plant responses to the EGF.

AUTHOR(S): Wheeler, E.F. 1995.

TITLE: Nitrate uptake and plant growth as influenced by light and nitrate nutrition.

WHERE: PhD Dissertation. Cornell University Libraries, Ithaca, NY 14853. 340 pp.

ABSTRACT: Evaluation of the kinetics of nitrate uptake over a plant lifecycle, as influenced by environmental factors, would fill a gap in our current understanding of nutrient assimilation and assist in crop management. Many plant nutrient uptake models are purely empirical evaluations based on Michaelis-Menten enzyme kinetics, which appear to fit the observed kinetic data but do not accommodate the physiological mechanisms of nutrient uptake. Michaelis-Menten does show the strong dependence of uptake rates on the nutrient content of the solution surrounding plant roots. Since environmental conditions influence plant growth, and growth creates a demand for nutrients, nitrate uptake should be related to environmental conditions. This research resulted in the development of a Michaelis-Menten-based mathematical relationship which shows environmental influences of light and nitrate nutrition on lettuce growth and N uptake. A growth chamber was outfitted with three nutrient solutions where the major variable was nitrate content: Low N, 0.04 mM; Medium N, 0.4 mM; High N, 4.0 mM. The chamber had lighting zones representing High (350 micromol/sq. m/s), Medium (250 micromol/sq. m/s) and Low (150 micromol/sq. m/s). Each of the three N levels was present in each of the three light zones so that nine environmental treatments were positioned in the chamber. Environmental conditions are best related to a plant growth response. An Environmental Stress Factor (ESF) was proposed as a means to quantify how stressful a combination of environmental factors was compared to adequate or optimal conditions. Uptake rate was quantified into a predictive relationship for lettuce grown under a range of light- and N-level environments. Environmental conditions were incorporated into the V_{max} term of the Michaelis-Menten kinetic equation. A power curve relationship predicted the maximum uptake rate, V_{max} , once environmental conditions were specified. Lettuce maximum uptake rates (V_{max}) were fairly consistent across the majority of light- and N-level treatments. For Low N grown plants, the availability of adequate light allowed the plants to at least double their maximum uptake rates.

AUTHOR(S): Wheeler, E.F., J. Kossowski, E. Goto, R.W. Langhans, G. White, L.D. Albright, and D. Wilcox. 1995.

TITLE: Consideration in selecting crops for the human-rated life support system: a linear programming model.

WHERE: Adv. Space Res. 18(1/2):233-236.

ABSTRACT: A Linear Programming model has been constructed which aids in selecting appropriate crops for CELLS (Controlled Ecological Life Support System) food production. A team of Controlled Environment Agriculture (CEA) faculty, staff, graduate students and invited experts representing more than a dozen disciplines, provided a wide range of expertise in developing the model and the crop production program. The model incorporates nutritional content and controlled-environment based production yields of carefully chosen crops into a framework where a crop mix can be constructed to suit the astronauts' needs. The crew's nutritional requirements can be adequately satisfied with only a few crops (assuming vitamin mineral supplements are provided) but this will not be not satisfactory from a culinary standpoint. This model is flexible enough that taste and variety driven food choices can be build into the model.

AUTHOR(S): Wheeler, E.F., L.D. Albright, L.P. Walker, R.M. Spanswick, and R.W. Langhans. 1994.

TITLE: Plant growth and nitrogen uptake Part 1: Beyond the Michaelis-Menten relationship.

WHERE: ASAE paper No. 947506. ASAE, 2950 Niles Road, St. Joseph, MI 49085-9659, USA. 15 pp.

AUTHOR(S): Wheeler, E.F., L.D. Albright, L.P. Walker, R.M. Spanswick, and R.W. Langhans. 1994.

TITLE: Plant growth and nitrogen uptake Part 2: Effects of light level and nitrate nutrition.

WHERE: ASAE paper No. 947505. ASAE, 2950 Niles Road, St. Joseph, MI 49085-9659, USA. 14 pp.