



This is a digital copy of a book that was preserved for generations on library shelves before it was carefully scanned by Google as part of a project to make the world's books discoverable online.

It has survived long enough for the copyright to expire and the book to enter the public domain. A public domain book is one that was never subject to copyright or whose legal copyright term has expired. Whether a book is in the public domain may vary country to country. Public domain books are our gateways to the past, representing a wealth of history, culture and knowledge that's often difficult to discover.

Marks, notations and other marginalia present in the original volume will appear in this file - a reminder of this book's long journey from the publisher to a library and finally to you.

### **Usage guidelines**

Google is proud to partner with libraries to digitize public domain materials and make them widely accessible. Public domain books belong to the public and we are merely their custodians. Nevertheless, this work is expensive, so in order to keep providing this resource, we have taken steps to prevent abuse by commercial parties, including placing technical restrictions on automated querying.

We also ask that you:

- + *Make non-commercial use of the files* We designed Google Book Search for use by individuals, and we request that you use these files for personal, non-commercial purposes.
- + *Refrain from automated querying* Do not send automated queries of any sort to Google's system: If you are conducting research on machine translation, optical character recognition or other areas where access to a large amount of text is helpful, please contact us. We encourage the use of public domain materials for these purposes and may be able to help.
- + *Maintain attribution* The Google "watermark" you see on each file is essential for informing people about this project and helping them find additional materials through Google Book Search. Please do not remove it.
- + *Keep it legal* Whatever your use, remember that you are responsible for ensuring that what you are doing is legal. Do not assume that just because we believe a book is in the public domain for users in the United States, that the work is also in the public domain for users in other countries. Whether a book is still in copyright varies from country to country, and we can't offer guidance on whether any specific use of any specific book is allowed. Please do not assume that a book's appearance in Google Book Search means it can be used in any manner anywhere in the world. Copyright infringement liability can be quite severe.

### **About Google Book Search**

Google's mission is to organize the world's information and to make it universally accessible and useful. Google Book Search helps readers discover the world's books while helping authors and publishers reach new audiences. You can search through the full text of this book on the web at <http://books.google.com/>



# *Irrigation farming*

Lucius Merle Wilcox

LIBRARY  
OF THE  
UNIVERSITY OF CALIFORNIA.

*Class*

Thurs. 11. 1892





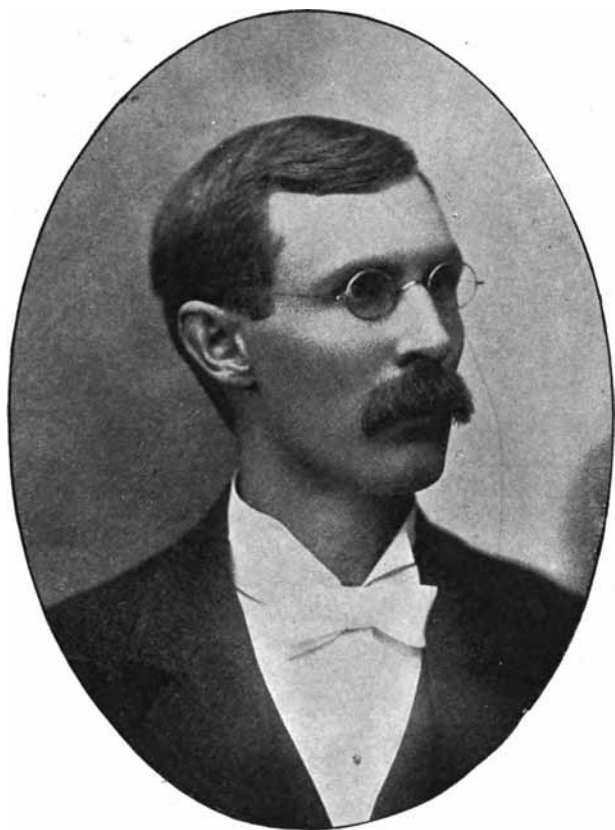

Yours truly  
Lucius M. Wilcox.

# IRRIGATION FARMING

A HANDBOOK FOR THE PROPER  
APPLICATION OF WATER IN THE  
PRODUCTION OF CROPS

BY

LUCIUS M. WILCOX

*Editor of the "Fork and Farm"*

REVISED AND ENLARGED EDITION

ILLUSTRATED

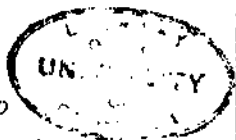

NEW YORK  
ORANGE JUDD COMPANY

1902





Yours truly  
Lucius M. Wilcox.

# IRRIGATION FARMING

A HANDBOOK FOR THE PROPER  
APPLICATION OF WATER IN THE  
PRODUCTION OF CROPS. : : : :

BY  
LUCIUS M. WILCOX

*Editor of the "Field and Farm"*

REVISED AND ENLARGED EDITION

ILLUSTRATED



NEW YORK  
ORANGE JUDD COMPANY

1902

10005  
1902

COPYRIGHT, 1902  
BY ORANGE JUDD COMPANY

GENERAL

## PREFACE.

---

**F**OR many years the author of this work endeavored to obtain specific information concerning the application of water for the production of crops on the edge of the Great American Desert, but was unable to secure any practical work bearing on the subject. Realizing that there were a million or more other deserving people similarly situated who desired just such instruction, the writer assumed the prerogative of inditing this simply compiled volume in the hopes that it might be acceptably received. From the time of its first appearance, in 1895, the author's anticipation has been more than realized, and it is with considerable satisfaction that this revised edition of the work is offered.

At this period in the grand enlightenment of the world through the medium of the printing-press all thoughtful readers have come to understand the importance of irrigation in the broadest sense of the term. Inasmuch as this science has become such an important factor in modern agricultural pursuits, and is becoming more or less essential in all parts of our vast domain, particularly in the western half of the United States, the author has considered it of such general interest as to justify the publication of the work submitted herewith. The necessity of revision has naturally arisen with the flight of years, for progress is the

v

order of the hour in all lines of industrial effort. In irrigation this fact is accentuated with each succeeding year, and to appreciate all the improvements of the times we must not hesitate to command all the best thought and experience of the men who have been successful in leading the waters captive to obey their will in developing the fullest fruition of the earth.

In treating upon so wide and diversified a subject as universal irrigation, I have endeavored throughout to make all points touched upon as explicit and comprehensive as possible, avoiding all useless verbiage, and handling the subject as understandingly as has come within the power of simple diction. While the text of the work is based largely upon personal experience, some of the deductions contained in these pages, especially regarding those in which the technical features are most prominent, are adapted from the observations of others proficient in their respective lines. I have relied somewhat upon the valuable knowledge of hydraulic engineers and scientists, and have utilized the best authorities attainable whenever technical matters had to be considered.

Upon careful perusal it will be seen that the strong position taken by the writer all through the work is the importance of consistent and scientific cultivation in connection with all irrigation operations. The one is quite as essential as the other, and the two combined are indispensable in attaining the most perfect results. "Till and keep tilling" is the most potent axiom of the twentieth century. I have deprecated shiftless methods as derogatory to the best success, and have condemned the practice as inexcusable as the wanton

waste of water itself. In all conclusions I have used the judgment afforded by twenty-five years' actual experience in the field, and if these lessons prove of any benefit to the agricultural masses far and wide I shall feel that this work has not been in vain, and that the labor has been worthy of its hire.

LUCIUS M. WILCOX.

DENVER, COLORADO, 1902.



# CONTENTS.

---

	PAGE
CHAPTER I.	
The History of Irrigation . . . . .	I
CHAPTER II.	
The Advantages of Irrigation . . . . .	13
CHAPTER III.	
The Relation of Soils to Irrigation . . . . .	22
CHAPTER IV.	
The Treatment of Alkali . . . . .	36
CHAPTER V.	
Water-supply . . . . .	47
CHAPTER VI.	
Canal Construction . . . . .	57
CHAPTER VII.	
Reservoirs and Ponds . . . . .	84
CHAPTER VIII.	
Pipes for Irrigation Purposes . . . . .	109
CHAPTER IX.	
Flumes and Their Structure . . . . .	123
CHAPTER X.	
Duty and Measurement of Water . . . . .	140
CHAPTER XI.	
Methods of Applying Water . . . . .	166
CHAPTER XII.	
Irrigation of Field Crops . . . . .	206



	<b>PAGE.</b>
<b>CHAPTER XIII.</b>	
Irrigation of the Garden . . . . .	250
<b>CHAPTER XIV.</b>	
Irrigation for the Orchard. . . . .	277
<b>CHAPTER XV.</b>	
The Vineyard and Small Fruits . . . . .	303
<b>CHAPTER XVI.</b>	
All About Alfalfa . . . . .	324
<b>CHAPTER XVII.</b>	
Windmills and Pumps . . . . .	352
<b>CHAPTER XVIII.</b>	
Devices, Appliances and Contrivances . . . . .	394
<b>CHAPTER XIX.</b>	
Subirrigation and Subsoiling . . . . .	419
<b>CHAPTER XX.</b>	
Seepage and Drainage . . . . .	438
<b>CHAPTER XXI.</b>	
Electricity in Irrigation . . . . .	448
<b>CHAPTER XXII.</b>	
Irrigation in Humid Climates . . . . .	455
<b>CHAPTER XXIII.</b>	
Winter Irrigation . . . . .	463
<b>CHAPTER XXIV.</b>	
The Common Law of Irrigation . . . . .	473
GLOSSARY OF IRRIGATION TERMS . . . . .	485
INDEX . . . . .	491

## ILLUSTRATIONS.

	PAGE.
Portrait of Author . . . . . <i>Frontispiece.</i>	
"A river went out of Eden to water the garden" . . .	xvi
Irrigation 5,000 Years Ago . . . . .	3
Irrigation Scene on the River Nile . . . . .	5
Grecian Tympanum Wheel . . . . .	8
Dividing Line Between Desert and Orchard . . . . .	17
Capillary Tubes of Soil . . . . .	31
The Newsom System of Water-supply . . . . .	55
The Jackson Level . . . . .	59
Target . . . . .	60
Drop and Reduction Box . . . . .	67
Curve of a Large Canal . . . . .	69
Canal on a Hillside . . . . .	71
Headgate of a Canal . . . . .	73
Top Sectional View of Land's Sand Gate . . . . .	74
Side View of Sand Gate . . . . .	74
Front View of Sand Gate . . . . .	74
Automatic Waste Gate . . . . .	76
Iron Outlet Gate . . . . .	78
Bear Valley Dam . . . . .	91
Sweetwater Dam . . . . .	93
Diverting Dam . . . . .	97
Cross-section of Hydraulic Reservoir . . . . .	104
Riveted Iron Pipe . . . . .	112
Spiral Iron Pipe . . . . .	113

	PAGE.
Vitrified Pipe . . . . .	115
Asbestine Pipe Machine . . . . .	116
Side View of Stave Pipe . . . . .	117
Cross-section of Stave Pipe . . . . .	118
Stave Pipe-line in Position . . . . .	119
Box Flume with Waste Gate . . . . .	127
Flume Across a Valley . . . . .	128
Truss Flume Across a Stream . . . . .	129
Method of Elevating a High-flume Trestle . . . . .	131
Bench Flume for a Large Canal . . . . .	133
The Great Flume Over the Pecos River . . . . .	135
Side View of Small Iron Flume . . . . .	136
End View of Small Iron Flume . . . . .	136
Cross-section of Large Iron Flume . . . . .	137
Flume on a Rocky Ledge . . . . .	138
Flume with Overhanging Support . . . . .	138
Divisor . . . . .	150
Foote's Measuring Flume . . . . .	151
Rectangular Weir . . . . .	153
The Current Meter . . . . .	157
Water Register . . . . .	159
The Stokes Measuring Gate . . . . .	160
Bird's-eye View of a Model Irrigated Farm . . . . .	167
Lateral Bulkhead . . . . .	169
Improved Steel Land Grader . . . . .	170
A Four-horse Grading Machine . . . . .	173
Diagonal Plow Furrows Across a Field . . . . .	178
Distributing Gates of Irrigation Canal . . . . .	182
Parallel Furrows for a Grown Orchard . . . . .	183
Double Furrow Orchard System . . . . .	185
Section of Vitrified Head Ditch . . . . .	188
The Basin System . . . . .	190

## ILLUSTRATIONS.

xiii

	PAGE.
Contour of Border System . . . . .	193
Irrigating with a Hose . . . . .	196
Irrigating a Hillside . . . . .	197
A Plan for Watering Rough Land . . . . .	199
Irrigating a Grain Field . . . . .	209
Irrigating a Crop of Potatoes . . . . .	237
Diagram of Garden . . . . .	251
Irrigated Garden . . . . .	252
Section of Tiled Celery Bed . . . . .	255
Diagram of an Orchard . . . . .	280
Nursery Irrigation . . . . .	299
Trellised Vineyard . . . . .	307
Alfalfa Plant in Full Bloom . . . . .	325
Flooding a Field of Alfalfa . . . . .	335
Stacking Alfalfa with a Ricker . . . . .	339
Ventilator for Alfalfa Stack . . . . .	340
Dodder Seed, Flower, and Plant . . . . .	349
Trocar Used for Bloat . . . . .	350
An Ideal Windmill and Reservoir Plant . . . . .	355
A Windmill Plant in Operation . . . . .	357
Wind Rustler . . . . .	365
Battle-ax Windmill . . . . .	366
The Merry-Go-Round . . . . .	368
Gause Pump and Points . . . . .	370
Irrigation Pump Cylinder . . . . .	370
Berlin Oscillating Pump . . . . .	371
The Low-lift Vacuum Pump . . . . .	372
High-lift Vacuum Pump . . . . .	373
Centrifugal Pump . . . . .	374
Hydraulic Ram in Parts . . . . .	377
Hydraulic Engine in Operation . . . . .	379
Harvey Water-motor . . . . .	380

	PAGE.
The Hurdy-Gurdy . . . . .	382
Air Compressor . . . . .	386
The Pneumatic System . . . . .	387
Inverted Sewer System . . . . .	395
Artesian Well . . . . .	398
Artesian Drilling Outfit . . . . .	399
Bucket Elevator . . . . .	403
The Apron Dam . . . . .	405
Huntley Dam . . . . .	407
The Witcher Canvas Dam . . . . .	408
The Van Horn Tap Gate . . . . .	409
A Home-made Spirit-level . . . . .	410
A Ditch Cleaner . . . . .	411
A Garden Hitcher . . . . .	411
Water-gate, Standing Position . . . . .	412
Water-gate, While Water is High . . . . .	412
Cistern and Liquid Manure Spreader . . . . .	414
The Corrugated Roller in Operation. . . . .	417
Diagram of Subirrigated Field . . . . .	423
Father Cole's System . . . . .	429
Greenhouse Irrigation . . . . .	431
Subsoil Plow . . . . .	435
Incorrect Drainage . . . . .	443
Correct Drainage. . . . .	444
A Steam Ditcher at Work . . . . .	446





**"A RIVER WENT OUT OF EDEN TO WATER THE GARDEN."**

*—Book of Genesis.*



## CHAPTER I.

### THE HISTORY OF IRRIGATION.

**T**HE magic science of irrigation is as old as civilization itself—in fact, it was in vogue during the semi-barbaric days of prehistoric times. The use of irrigation for the production of crops probably antedates Noah's deluge by several thousand years. The earliest writer of agricultural lyrics was Hesiod, a Greek epic author who lived a thousand years before the Christian era. He often refers to irrigation as practiced for ages prior to his time by the Chinese people, of whom he seems to have had considerable knowledge. In Plato's *Timæus* is an account of the sunken island of Atlantis. This account Plato obtained from his ancestor Solon, the lawgiver, who had visited Egypt, and in the city of Sais obtained the information from an Egyptian priest. Solon lived about 2,500 years ago, and, according to the story told him by the priest, there existed about 10,000 years before his time a large island in the Atlantic ocean opposite the Pillars of Hercules, otherwise the Strait of Gibraltar, which was divided into ten kingdoms and ruled by the descendants of Poseidon. The description of the island is very minute, and among other things also is described a very extensive and elaborate system of irrigating canals, constructed in such manner as to utilize every natural stream and completely surround the island. While



the history of Atlantis is by many regarded as a myth, there are too many facts actually in existence to warrant any such conclusion. According to this record, irrigation was in practical use fully 12,500 years ago. The English and French hydrographic engineers of the present age have found by the most careful soundings of the Atlantic ocean that the sunken continent of Atlantis has a physical existence, and that it also has the remains of great canals still defined upon its submerged surface.

Twenty-seven centuries before the Star of Bethlehem shone so brightly by night a clever Egyptian ruler named Menes turned the course of the Nile so as to carry the turbid waters well out upon the higher ground, upon the very site of the present operations of the English engineer Wilcocks. Menes invented the nilometer, still in use to-day for gauging streams. The first artificial lake of which there is any reliable record is Lake Moeris. The historians Herodotus, Diodorus, and Pliny have described it, on the testimony of the inhabitants of the country, as one of the noblest works of the time from its enormous dimensions and its capacity for irrigation for the benefit of mankind. According to them, it was about 3,600 stadia, or 413 miles in circumference and 300 feet deep. Modern travelers have considerably reduced the circumference and depth of this lake, making it measure somewhat less than fifty miles in circumference, but even with this curtailment it must have been a magnificent engineering work, worthy of the admiration of all the ages. It was constructed, some historians say, by King Moeris; others, by King Amenemhet in the

12th dynasty, 2084 B.C. In the 20th dynasty Seti was the ruling monarch, and is believed to have been the first man who acquired the knowledge of civil engineering and applied his learning particularly to hydraulics, for he introduced irrigation in the valley of the Nile by means of systemic engineering. He built a great reservoir in a natural catchment basin and constructed canals in one vast system. Seti was

no doubt the first person to sink an artesian well, for the Greek historians speak of this as "the well from which water flowed over the top." He used the well in supplying water to the great temple of Karnak. Sesostris, one of the most il-

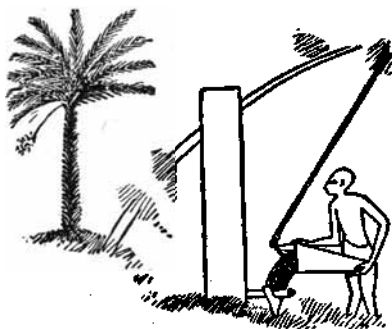

FIG. 1—IRRIGATION 5,000 YEARS AGO.

lustrious kings of antiquity, who reigned in Egypt 1491 B.C., had a great number of canals cut for the purpose of trade and irrigation, and is said to have designed the first canal which established communication between the Mediterranean and Red seas. The oldest monument at Thebes has a representation of a naked fellah under a dom palm tree drawing water from the Nile with a well-sweep or shadoof, a reproduction of which is shown in Fig. 1, and the fellah of to-day does it the same way, except that two or more usually work together on a large turn beam.

By the time that Moses, the great leader and law-giver, appeared to lead the enslaved children out of Egyptian slavery, irrigation had made great progress in a general way, for in the book of Deuteronomy we are told something of their agricultural methods in these words: "For the land, whither thou goest in to possess it, is not as the land of Egypt, from whence ye came out, where thou sowedst thy seed, and wateredst it with thy foot, as a garden of herbs. But the land, whither ye go to possess it, is a land of hills and valleys, and drinketh water of the rain of heaven." There are in Egypt sections of country that have been in constant use for over four thousand years, and still the soil shows no sign of wearing out, for such is the nature of the water of the Nile that the annual deposit of sediment more than recompenses the drainage by the immense crops. An illustration of such a farm will be seen in Fig. 2. The plats are laid off in squares divided by the irrigation furrows.

China is equally celebrated with Egypt for the great antiquity of its numerous canals. The Great or Imperial Canal is one of the most stupendous works of ancient or modern times. It is 650 miles long, and connects the Hoang-Ho and Yang-tse-Kiang rivers. It is available both for navigation and irrigation, and together with its numerous branches irrigates an immense area of country, thus affording millions the means of livelihood and support. Immense tanks, reservoirs, and irrigating canals appear to have been constructed in India many centuries anterior to the advent of Christ, and some of them are probably equally as ancient as the Egyptian canals. The Assyrians were

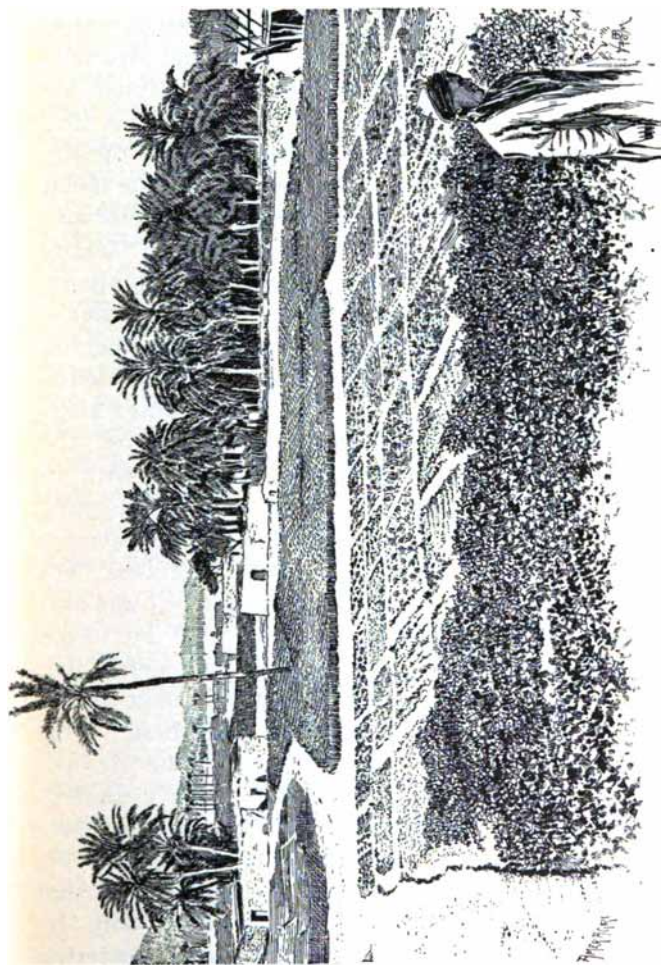

FIG. 2—IRRIGATION SCENE ON THE RIVER NILE.

equally renowned with the Egyptians from the most remote periods of history for their skill and ingenuity in the construction of hydraulic works. Through the foresight, enterprise, and energy of their rulers they converted the sterile country in the valleys of the Euphrates and Tigris into fertility, which was the theme of wonder and admiration of the ancient historians. The country below Hit on the Euphrates, and Samarra on the Tigris, was at one time intersected with numerous canals, one of the most ancient and important of which, called the Nahr Malikah, connecting the Euphrates with the Tigris, is attributed by tradition to Nimrod, King of Babel, 2204 B.C., while other historians assert that Nebuchadnezzar constructed it.

Among the ancient works at Babylon, with its fabled hanging gardens, was a lake 42 miles in circumference and 35 feet deep, to store the flood-waters of the Euphrates and distribute them for irrigation. The Nahrawn canal, taken from the Tigris river, was over 400 miles long, and varied in width from 250 to 400 feet, and from numerous branches on both sides it irrigated a very extensive area of country, while at the same time it was also available for navigation. With the destruction of Babylon the glory of the Mesopotamian Empire departed, the canals were neglected, and the country described by Herodotus as being prolific before all other lands in its production of rye, wheat, and barley has become so dry and barren that it cannot be cultivated, and is inhabited only by nomadic bands of Bedouins and the scurvy, wandering Arabians.

In the book of Ecclesiastes we read of the hidden

springs and sealed fountains of Solomon, from which the water was piped to the plains below. The remains of reservoirs in the neighborhood of Hebron, which the Jews are supposed to have constructed in the days of Solomon for the supply of Jerusalem, show that their designers were equally alive with most engineers of the present age to the great importance of an ample and constant supply of water. The Phœnicians, in the zenith of their power, were celebrated for their canals, both for the supply of Carthage with drinking water and for the purposes of irrigation. They were a very diligent people, and so imbued were they in the cause of irrigation that they made aqueducts through mountains of solid granite, hewing the way with hand chisels. Many of these prehistoric works still remain.

The Greeks, judging from the ruins of large aqueducts scattered throughout the country, appear from a very remote period to have paid the greatest attention to hydraulic science. Herodotus describes an ancient conduit for supplying Samos, which had a channel three feet wide and which pierced a hill with a tunnel nearly a mile long. Another masonry aqueduct near Patara crossed a ravine 200 feet wide and 250 feet deep. Virgil, that most charming of Roman poets, in referring to irrigation in his First *Georgic*, says:

“ What may I say of that industrious swain  
Who, like a soldier following spear with sword,  
The grain pursues just cast into its place.  
And rushes on it the adjoining heap  
Of soil that is illy rich, then leads the stream

And following streams upon the planted grain ;  
And when the burnt-out field with dying growths  
Is hot, behold, he brings the saving wave headlong,  
Down through its slanting path; its falling calls  
From rounding rocks a murmur hoarse, and cools  
With scattering rills the parched and thirsty fields."

The Grecians were an inventive people and to them

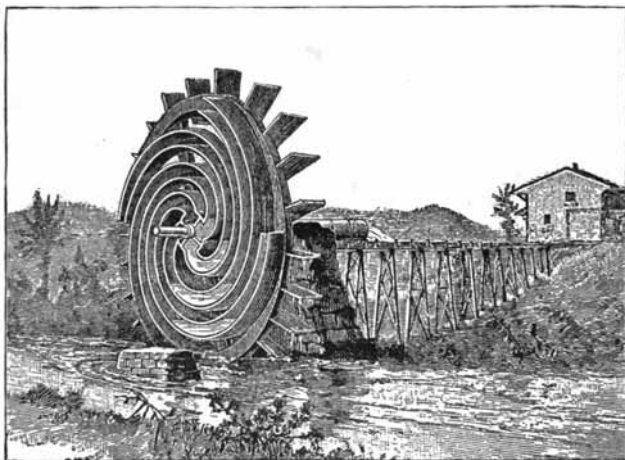

FIG. 3—GRECIAN TYMPANUM WHEEL.

are ascribed great improvements in the way of mechanical contrivances for raising water. Principal among these is the tympanum wheel, afterward adopted by the Egyptians, as shown in Fig. 3.

In the reign of Emperor Nero, Rome was supplied by no fewer than nine large conduits, having an aggregate length of 255 miles, which delivered over 173,000,000 gallons of water daily. Afterward the supply

was increased to 312,500,000 gallons daily. Most of the Roman works were constructed for the supply of cities with drinking water, and such were built in all countries under Roman control. That of Claudia was 47 miles long and 100 feet high, so as to furnish the hills. Martia's was 41 miles, of which 37 were on 7,000 arches 70 feet high. These vast erections would never have been built had the Romans known that water always rises to its own level.

Julius Cæsar, in his efforts to conquer the world, carried the irrigation idea into Great Britain, and his subservient soldiery constructed many miles of artificial watercourses, or, rather, superintended the work, which was done manually by the people whom they had enslaved by conquest. When Constantine was sent to the Bosphorus to found the great city which bears his name he detailed certain numbers of his army for canal work, and they built many permanent irrigating works.

The Spaniards are the best irrigators in the world; they have been applying water artificially for over 3,000 years, and have thoroughly familiarized themselves as to its uses, adaptability, application, etc. Modern travelers tell us they have the best-constructed works of any people, and many of these works were made prior to the Moorish occupancy. The solid masonry, the handiwork of men living before the advent of the Christian epoch, is still extant and in actual use. What was done with irrigating science during the dark ages we know but little.

Coming down to more modern times, and looking at the western hemisphere through the murky vista of



the years, we find that irrigation has existed as an aid to agriculture for many centuries antedating the advent of the Caucasian. Arizona is full of the remains of ancient towns and irrigating canals, and in Taos, Santa Fé, Valencia and Grant counties, New Mexico, the existing ruins of similar structures point to a dense population existing at some remote period under some form of organized government. The remnants of this nation or nations are found in the Pueblos of Acoma, Cochita, Isleta, Jemez, Laguna, Moqui, Nambe, Picuris, Zuni, and others of New Mexico, and the Chihuahuas and Tequas and others along the Rio Grande in Texas. The writer has stood upon the ruins of La Gran Quivera and traced for miles with his eye the grade of a great irrigating ditch. Ruins of ancient towns have also been found along the Pecos river in Texas. There are few streams in Arizona and New Mexico where traces of ancient works cannot be found. Earthquakes and wars with savage neighbors brought about the destruction of most of these works. The Spanish marauders under Cabeza de Vaca, and later on under Coronado, helped to bring about further decay. In Peru, the land of the Incas, and throughout Mexico and Central America, the early Spanish explorers found such magnificent irrigating works that their astonishment was very marked. The elaborate appliances for irrigation were neglected and allowed to go to ruin. The now existing works do not compare in magnitude to the ancient works. Parts of Arizona and New Mexico were at some remote period densely populated and then abandoned. Quite extensive systems of irrigating canals of prehistoric

origin have been found on the Colorado river, and parts of them have been adapted to the modern canals. At the Casa Grande and in the Salt River valley of Southern Arizona these canals may still be seen. Thirty-five years ago an engineer at field work near Riverside, California, was running the level for a proposed ditch. He could not establish the grade satisfactorily, so he went again to the stream and reconnoitered for a new start. He was surprised to find an old acequia—so old, in fact, that its banks were scarcely discernible—and by carefully following its course he was still more astonished to discover that it had brought him to his original objective point, and on these lines the new canal was laid. The grade was all that could have been wished for.

Among the old irrigation works are those in the vicinity of San Antonio, Texas, begun under the direction of the Spanish padres about 1715. With the erection of the Spanish missions began the cultivation of the soil in Southwestern Texas. According to local tradition the worthy padres were expert in rounding up the unfortunate natives and getting an unlimited amount of work out of them in the construction of mission buildings and irrigating ditches. The pay for services rendered was usually bestowed in the form of religious instruction, administered willy-nilly, and occasionally augmented by an extra inquisition, if the forced piety and humility did not agree well with the unwilling convert.

The pioneer Mormons who settled in the fertile Salt Lake valley in 1847 saw the necessity of irrigation, and to their untiring efforts and attendant success

is due much of the credit for the impetus given our more modern methods of artificial crop-watering. It took them two years to get their first canal into working order, and the work was done under the pressure of uncertainty and with many hardships and privations. In 1870 the Greeley Union Colony was established in Northern Colorado on a barren plain, and an experimental system of ditching was begun in imitation of the irrigation fields existing in Utah. It was about this time that the California Arcadians took up the great art of supplying plant food with "the waters led captive," and at once irrigation sprang into new life and came seemingly in the nick of time to redeem America's arid wastes "and make the desert to blossom as the rose."

## CHAPTER II.

### THE ADVANTAGES OF IRRIGATION.

**S**OME one has spoken of irrigation as the "wedding of the sunshine and the rain." A great many people hearing the word irrigation experience the same sensations that they do when Madagascar or Wiju is spoken of. They have a feeling that it is something a great distance off—hard to reach—intangible. They read about it as they like to read "Arabian Nights" or "Hans Andersen's Fairy Stories," and it leaves on their minds about the same impressions of wonder, magnificence, and untruth as do the stories named. To them the very word "irrigation" puts their reasonings to flight, and they imagine that the art of applying water to cultivated lands is some complicated and wonderfully intricate process not easily understood or attained by mortal man. The fact of the matter is, as the author proposes to show in the succeeding chapters, that irrigation is as simple as child's play, and may be accomplished by the most commonplace day laborer in the fields. In enumerating a few of the advantages attendant upon irrigating methods, we will cite the facts that irrigation reclaims arid wastes; makes a prosperous country; causes the desert to blossom and overcomes the destructive effects of the parching southern winds; insures full crops every season; improves land at each submergence, and

consequently does not wear out the soil; produces support of dense population; multiplies the productive capacity of soils; destroys insects and worms and produces perfect fruit; creates wealth from water, sunshine, and soil; makes the farmer independent of the rainfall; will redeem 100,000,000 acres of desert lands in the United States alone; yields large returns to investors; adds constantly to the security of investments; will yield support for 50,000,000 of increased population in America; makes the production of choicest fruits possible, and prolongs the harvest period of various crops if so desired; affords a sure foundation for the creation of wealth; lessens the danger of floods; utilizes the virgin soil of the mountain regions; is now employing more than \$1,000,000,000 of capital; insures two or more crops annually in the lower latitudes; will increase threefold the value of lands having rainfall; keeps off the early approach of Jack Frost; improves the quality and increases fully one-eighth and oftentimes one-fourth the size of fruits, vegetables, and grains; makes farming profitable in waste places and forever forestalls the inroads caused by the ghost of drouth; and will finally solve the great labor question and fortify against the alarming increase of city populations.

The farmer who has a soil containing an abundance of all the needed elements, in a proper state of fineness, cannot but deem himself happy if he have always ready at hand the means of readily and cheaply supplying all the water needed by his soil and growing crops, just when and in just such quantities as are needed. Happier still may he be if, besides fearing no

drouth, he has no rainfall to interrupt his labors or to injure his growing or harvested crops. And happier still may he be when he realizes that he need have no "off years," and he knows that the waters he admits to his fields at will are freighted with rich fertilizing elements usually far more valuable to the growing crop than any that he can purchase and apply at a costly rate—a cost that makes serious inroads upon the profits of the majority of farmers cultivating the worn-out or deteriorated soils in the older states year by year. Fertilizers are already needed for the most profitable culture on many farms in Iowa, Minnesota, Eastern Kansas, and Nebraska, in Missouri, and in all states east of those named.

In proof of this assertion the writer can best be qualified in his statement by mentioning the fact that there is an oat field in Saguache county, Colorado, that up to 1894 had produced twenty-three consecutive crops, each of which averaged forty bushels to the acre through all the years. The yield of the twenty-third crop averaged sixty bushels, which would indicate that the fertility of that field was keeping up remarkably well without rest or rotation. This unusual result was made possible by means of irrigation alone, and there is no doubt much truth in the theory that the irrigating waters from the mountains contain great quantities of mineral fertilizing elements in solution. Even by shallow plowing and the most shiftless methods of land preparation a Mexican farmer named E. Valdez, of Chromo, Colorado, produced twenty-five consecutive crops of wheat on the same soil, and without manure or change of seed in the interim. This

peculiar result was made possible only by the use of irrigating waters, applied as they were regardless of scientific principles or any defined method whatever. The yield the last season was forty-five bushels to the acre, as heavy as any throughout the quarter of a century of constant croppage.

Irrigation farming has peculiar characteristics. It is a higher and more scientific industry than rain farming; it succeeds best by what is known as intensive culture, or what is better described as scientific culture. The soil to be at its best should be carefully prepared, and cultivation ought to be minute and thorough. To make such agriculture pay, such crops must be raised as will yield the greatest value to the acre. The irrigated lands are better adapted to the growth of orchards, vineyards, gardens, potato fields, hop-yards, tobacco and cotton plantations, and whatever extra work may be required to cover the land with water will be repaid tenfold from the first crop that is taken off. In traveling in the far west, over long stretches of parched and dusty plains or through mountain gorges, the writer has often seen fields, orchards, vineyards, and gardens all dressed in living green. The life, vigor, and fruitfulness were in surpassing contrast to the general aspect. And why this contrast? Because of the tapping of mountain streams, fed by crystal springs or banks of perpetual snow, and turning a portion of their waters upon the lands. From great eminences the course of these life-giving waterways made by the hands of man could be traced by the eye, until they were lost in the dimness of distance. There was no need being told where were the irrigating

ditches. The eye of a novice could mark them with accuracy as they wound about the foothill slopes, dotting the landscape with patches of emerald, where lone settlers and busy towns were located. An illustration of this condition is given in Fig. 4, showing the



FIG. 4—DIVIDING LINE BETWEEN DESERT AND ORCHARD.

course of an irrigating ditch dividing the unbroken prairie and a newly set orchard.

It is in the horticultural pursuits that the highest degree of perfection as the patrimony of modern irrigation is to be realized. Under any system of irrigation where a constant supply of water is to be had the hor-



ticulturist can plant with almost a certainty of gathering a crop. Untimely frosts, insects, and fungous diseases are often to be contended with, but it is a great consolation to feel sure that drouth cannot prevent the starting of trees, plants, and seeds in springtime, or cut short a growing crop. Neither are floods likely to overflow, except on low bottoms, and these are not the best places for the most profitable orchards. One field or a small portion of it can be watered without the rest being deluged or even sprinkled, if desired.

It is the writer's desire at this time to direct the attention of horticulturists and farmers generally in the "rain belt" to the benefits to be derived from an artificial supply of water to their crops. Some may scout the idea and say it is not practicable—that it will not pay to go to so much expense for the little use to be made of the water; but in all seriousness it may be said that it will pay, and there are many places east of the arid regions where irrigation is now considered by those who have long tried it as almost indispensable. There is scarcely an acre of ground under cultivation in North America that would not produce more and better crops if there were at hand an abundant water-supply. There are seasons now and then in which the rains come just right and irrigation might not be needed even once, but they are rare. Usually there are several dry spells during each year that cause serious injury to the crops, and were irrigation possible all harm from this source might be prevented. A very little water at the right time would make all the difference with the crop and turn into success what otherwise would have been a partial or total failure. The

work already put upon the land would be saved, as well as seeds and plants. Satisfaction and plenty would take the place of disappointment and scarcity. If eastern pomologists would only adopt irrigation there would be no good cause for having weakly plants and trees, or for the premature dropping of leaves. The buds would develop early, and be plump and vigorous. There would be no winter-killing of trees and plants because of their feeble condition. Many things are considered tender that are so in some places only because of their inability to make sufficient growth to fortify against the evaporating influences of the winter.

It would not be reasonable to expect that any of the many systems of irrigation can be applied to all sections of our country, or to every farm in any section. Neither is it always practicable that all of a large farm should be placed under irrigation, except in rare cases. But where there is now, or may be created, a supply of water that can be drawn upon in time of need for at least a small part of the farm, it is a great mistake not to make use of its benefits. There are special crops, such as asparagus, celery, and the strawberry, which need an amount of water that is not required by most others, and which could be grown much more cheaply than at present if aided by irrigation. In this connection it might be well to add that statistics show that in all rainy countries—that is, where the farmers depend upon the rains to make their crops—the seasons of drouth and the seasons of too much rain constitute three out of every five, giving the farmer three bad crops to two good ones. As a matter of fact, the in-

trinsic advantages of irrigation concern and are within reach of the farmer of the humid region quite as much as his fellow in the arid climate; and in many, if not in most, cases his water supply will cost him less, and when once applied will never be given up. There can be no doubt that when the available waters of the humid region are examined in regard to the supplies of plant food they are capable of giving to lands irrigated with them, they will be found to be nearly, if not quite, as valuable in this respect as those of the arid region.

Another suggestion along this line presents itself right here: As there is no material difference in the cost of cultivation of an acre yielding ten bushels of wheat and another acre yielding sixty bushels, it must be evident that the man who gets only ten bushels pays six times as much as does the man who produces sixty bushels. The profits to be derived from "the new agriculture," as irrigation has aptly been called, comes not alone from the annual return from the watered acres, but from the constantly increasing valuation of the land itself. Many individual instances could be cited, especially in regions devoted to fruit culture, where the returns are almost fabulous. Lands which were worth from two to ten dollars an acre have by the expenditure of from ten to twenty dollars an acre in the construction of irrigation works become worth \$300 an acre and upward. The same lands set out with suitable varieties of trees and vines have sold within five years of planting at \$1,000 or more an acre. So valuable are irrigated lands in Spain that they sell for \$720 to \$880 an acre, which is ten times the price of

the unirrigated, and the same ratio of values prevails elsewhere.

In summarizing the manifold advantages that the irrigation blessing has brought to humanity through all the ages of persevering man, and anticipating those benefits that are to be commanded by "the nations yet to be," we may conclude that irrigation means better economic conditions; means small farms, orchards, and vineyards; more homes and greater comfort for men of moderate means. It means more intelligence and knowledge applied to farming, more profit from crops, more freight and more commerce—because special products of higher grade and better market value will be enhanced. It means association in urban life instead of isolated farms. It means the occupation of small holdings. It means more telephones, telegraphs, good roads, and swift motors; fruit and garden growths everywhere; schools in closer proximity; villages on every hand, and such general prosperity as can hardly be dreamed of by those who are not familiar with the results of even the present infancy of irrigation in America. It can hardly be doubted that in time the lessons conveyed by history, as well as by the daily practice and results of irrigation in the arid region, will induce the dwellers in the regions of summer rains to procure for themselves at least a part of the advantages which are equally within their reach, putting an end to the dreadful seasons when "the skies are as brass and the earth as a stone," and the labors of the husbandman are in vain.

## CHAPTER III.

### THE RELATION OF SOILS TO IRRIGATION.

**I**T was the blind poet Milton who said, "Fame is no plant that grows on mortal soil." He might have added that famous plants are to grow on irrigated soil. The nature, condition and situation of soils compose a most important factor in successful irrigation, and should especially be understood by every person who essays to apply water by artificial methods. In the first place, it may be well to understand that primarily soil is rock disintegrated, dissolved, or pulverized by the action of the air, water, and ice, aided chemically by the various salts and acids present in the soil, and fertilized by decayed vegetation, animal excretions, and chemical agents.

**Classes of Soils.**—Nominally there are two distinct classes of soils—the sedentary and transported soils, which embrace the drift and alluvial soils. Specifically soils are distinctive according to their physical characteristics, and may be classified as gravel, sand, clay, loam, marl, lime, salt, peat, muck, or humus. Pure sand consists almost entirely of small grains of silica or quartz, and is not a plant food. Plants cannot use it. It is insoluble in water and in acids, and has no adhesive tendency; hence, acting as a divider in the soil, it makes the land easy to work and facilitates the passage of roots in search of food, and

also allows the assimilation of irrigating waters. The amount of sand in the soil varies from eight to more than ninety per cent. It absorbs very little moisture or other fertilizing material in the air, but retains heat much longer than does any other soil constituent. From these facts, then, it is evident that a sandy soil will be loose, easy to work, dry, warm, and free from baking, but peculiarly apt to suffer from drouth when irrigation is not available, and lose valuable plant food by leaching, especially if the subsoil be sandy or gravelly.

**Clay Soils.**—Clay is a compound of silica and aluminum. It is very seldom found pure, but contains potash, lime, ammonia, etc., mixed with it, and some of these unite with it to form double silicates, which are exceedingly valuable on account of the potash, lime, or ammonia which they furnish to plants. Clay is not a plant food. It is not taken up by plants except by a few of the lower orders, but the impurities in it—lime, potash, etc.—are absolutely essential to vegetable growth, and these at once become soluble under the influence of irrigating waters. Red clays always contain iron, and most clay soils are rich in potash, thus adding to their availability as plant food, and rendering them peculiarly adapted to such plants as require a liberal supply of compounds. Clay gives body to the soil and absorbs moisture readily. It absorbs heat much more readily than sand does, but has not the same power of retention. A clayey soil, then, is usually rich in phosphoric acid, potash, ammonia, etc., holds moisture well, and is adapted to withstand drouth, but is difficult to work and apt to

bake after having been irrigated in summer, and is cold and wet in spring and fall. The amount of clay in soil varies from ten to ninety per cent., but the quantity of pure clay in heavy soils rarely exceeds thirty per cent. The clay soils of the far west are locally called "adobe," because it is of such soil that the adobe bricks are made by the native Mexicans and used in their simple architecture. While adobe soils are more difficult to work they are well adapted to irrigation, and it is on them that the best results are often obtained by western irrigators.

**Gumbo and Loam.**—Gumbo soil is a term applied to a class of heavy soils prevalent in the south, having a greasy feeling and a soapy or waxy appearance. The particles that compose the soil are very small, less than one one-hundredth of an inch in size, and there is but very little true sand present. These soils are always rich in alkali, particularly the potash compound. It is this potash that gives it the soapy appearance and greasy feeling. They fail to scour the plow because of the absence of sand and the extreme fineness of the particles. No cheap chemical can improve these soils, but continual cropping gradually causes an improved condition by the gradual removal of the excess of potash. They are especially adapted for grass and hay crops. Gumbo is more impervious to water than most soils are, and as a rule requires much less irrigation. Loam soils comprise those molds ranging between sand and clay and possessing more or less each of these two constituents. They constitute what may be termed the happy medium, and are really the most desirable kinds of earth on which to ply the irrigator's

art. The term loam is a most indefinite characterization on account of the various constituents which it contains. For instance, a heavy clay loam has but from ten to twenty-five per cent. of sand; a clay loam is twenty-five to forty per cent. of sand, and the sandy loam is from sixty to seventy-five per cent. of sand, while the light sandy contains from seventy-five to ninety per cent.

It has been demonstrated by practical experiments that one hundred pounds of sand will absorb twenty-five pounds of water; one hundred pounds of loam, forty pounds; one hundred pounds of clay loam, fifty pounds; one hundred pounds of clay, seventy pounds. This explains why some soils always appear drier than others, why some soils will stand a drouth so much longer than others, and why, after an irrigation, some soils become like a thick paste while others are dry. Sandy soils usually break up loose and mellow when dug, forked, or worked in any way; black land is stiff, breaks up in hard clods when worked either too wet or too dry, and requires more cultivation both before and after plants are put in it than does sandy soil.

**Humus.**—The humus is the organic portion of the soil, resulting from decayed vegetable matter. It is of a dark brown or black color, the blacker the better. A good example is well-rotted leaf mold. The chief constituent of humus is carbon, but it contains all the other compounds found in plants, and by its gradual decay these all become available as plant food in the most desirable form. Humus is the chief source of nitrogen in the soil. A black soil rich in humus is sure to be rich in nitrogen. The remarkable fertility



of virgin soils is largely due to the nitrogenous humus which they contain. Of all soil constituents, humus has the greatest power to absorb and retain moisture, and to draw moisture from the subsoil by capillary attraction, and it is in this power that is manifested its valuable utility immediately on the application of irrigating waters. It also possesses in a high degree the power to absorb ammonia from the air, and by its dark color it adds warmth to the soil during the day, while by cooling quickly at night it assists in causing dew to be deposited upon the soil which contains it. Humus also improves the texture of the soils, by making clay soil more friable and sandy soil more compact and retentive. The amount of humus in fertile soils is quite variable, but usually runs from three to seven or eight per cent.

**The Acids.**—In all soils we find two essential acids, known scientifically as humic and ulmic. The first is the acid in the humus, or vegetable and animal matter in the soil. As animal life is built by vegetable matter, it must eventually turn back to vegetable matter. Ulmic acids are those that exude from the roots of some plants. We should remember that nitrogen is the costliest of all plant foods and the most difficult to retain in the soil, and plants must have it, for it corrects this humic acid in the plant as well as in the soil. The ulmic acids are seldom in sufficient quantity to do harm. But the humic acids when shut off from the proportions of nitrogen or potash—both alkalis—become too concentrated, or the dead microbes become poisonous to plant life, as the great French chemist Pasteur would have it. Now humic acid has

the same effect both in plant life and in the soil—for all nature was torn off the same bolt. If the soil is very wet for two or three weeks and is well filled with vegetable matter, although the plant is overgrown, it becomes sick just as much as a horse with colic. But keep the soil so the air can penetrate it and neutralize these acids, and the more of this vegetable matter the better and heavier the plant will fruit. One strong point in favor of irrigation is that it neutralizes these acids and brings them more surely under the control of the scientific cultivator, so that they may be more fully utilized in the structural growth of the plant.

**Color and Texture.**—The color of soil depends exclusively on its composition, humus forming nearly a black soil, while sand gives a light yellow, and iron oxide produces a red color. The darker soils, other things being equal, have the highest absorptive power toward solar heat. This is shown when muck is applied to the surface of snow in the spring. We have often found in the rich valleys of the Rocky Mountain region a dark, chocolate loam interspersed here and there by deposits of a lighter and more chalky nature, all being, however, extremely rich in gypsum and salts that are valuable in the production of fruits, cereals, and vegetables. Investigation shows that one acre foot in depth of a fairly good agricultural soil contains four thousand pounds of phosphoric acid, eight thousand pounds of potash, sixteen thousand pounds of nitrogen and lime, magnesia, soda, chlorine, sulphur, and silica—all of which are more fully rendered available in maturing plant life when irrigation is brought into practice upon them.

It has long been recognized by practical men, as well as by many of our scientific investigators, that the texture of the soil and the physical relation to moisture and heat have much to do with the distribution and development of crops. Years ago Johnson went so far as to say, in "How Crops Feed": "It is a well-recognized fact that next to temperature the water-supply is the most influential factor in the product of the crop. Poor soils give good crops in seasons of plentiful and well-distributed rain or when skilfully irrigated, but insufficient moisture in the soil is an evil that no supplies of plant food can neutralize."

Recent investigations point to the conclusion that the mechanical arrangement of the soil grains determines its fertility more than the chemical properties it may possess. Experiments show that the greater the number of soil grains in a given space the greater the amount of air space, because the small grains, being light, arrange themselves more loosely than the larger or heavier ones. In a good wheat soil, when dry, there is at least fifty per cent. of air space—that is, in a cubic foot of soil one-half of the space is occupied by the soil and one-half by the air. But during the process of irrigation the interstices become filled with water, and by too copious or too prolonged an irrigation the soil becomes saturated, which excludes the air from the soil—air so necessary to plant growth. A porous subsoil removes the water of saturation and assists in preserving the moisture adhering to the particles of soil. The latter is the most favorable to the growth of crops. In determining the condition of moisture in the soil in the practical application of water, it is only

necessary to take out a handful of earth a few inches below the surface. If the earth is of sufficient moisture to ball in the hand irrigation at that time is not needed. This is a simple and inflexible rule.

**Temperature.**—The relation of soil to heat is largely dependent upon the relation of soil to moisture and the amount of moisture contained in the soil. It takes more heat to raise the temperature of a pound of water one degree than to raise the temperature of a pound of soil the same amount; so that the more moisture there is in a soil the more material there is to be heated, and this added material is more difficult to heat than the substance of the soil itself. The temperature of the soil will depend also upon the amount of evaporation of the soil. It has been shown that from this cause alone the temperature of the sandy soil may be much cooler at midday than the temperature of the clay soil. If the soils had been dry this would have been just the reverse, and the substance of the clay is more difficult to heat than the substance of the sand. It has been shown that the mean temperature of a sandy soil is lower than that of an adjacent clay soil, while the sandy soil is drier than the clay soil. These are conditions of a lower temperature and a drier soil, which are used in greenhouse culture to force the ripening of a plant; while the higher temperature and the greater moisture content of the clay soil are conditions used in greenhouse culture to produce a leafy development and to retard the ripening of the plant.

**Gravity.**—The relation of soils to water resolves itself into two lines of investigation—the forces

which move the water and the conditions which determine the relative rate of flow. The forces which move the water within the soil are gravity and the tension or contracting power of the exposed water surface. The approximate extent of the water surface can be calculated from the mechanical analysis of the soil. The surface tension and effect of manures and fertilizers on the surface tension can be found by the ordinary method of the rise of liquids in capillary tubes, using as a solvent pure water, or extracts of the soil, representing as nearly as possible the ordinary soil moisture. The different fertilizing materials have a very marked effect on the pulling power of the water. The same class of substances may differ widely in their effect. Kainit, for instance, increases the surface tension of pure water, but nitrate of potash lowers it very considerably.

**Nutritive Dissemination.**—The absorption of nutritive matter by the soil is a phenomenon of universal occurrence and widest significance as influencing the conditions of plant growth. Its manifestation is among the most common processes of nature; yet not till within the past half century was it fully recognized or appreciated in its bearings on plant nutrition. Solutions, as a result of our modern irrigating methods, are known to part with their solid constituents on passing through any considerable quantity of soil. They are thus disseminated more evenly throughout the top-soil, and are left there on deposit, as it were, to be drawn upon by the growing vegetation, and hence it is that irrigation improves the mechanical condition of soils and makes them the more readily sub-

servient to the agriculturist. Some authorities claim that soils which have been cropped until the soluble ingredients, organic elements, and humus have been materially decreased retain less water and dry out more readily than when there is a larger amount of organic matter present in the soil. This depletion, however, may easily be obviated by the scientific application of fertilizers, the growing of nitrogenous plants, or by crop rotation.

**Capillary Action.**—In concluding our observations on this important topic of soils the matter of cultivation must not be overlooked. The success of irri-



FIG. 5—CAPILLARY TUBES OF SOIL.

gation cannot be made complete without cultivation, and it is a fault too commonly observed among irrigators that they are inclined to depend too much upon irrigation and not nearly enough upon cultivation. The retention of the moisture when once supplied to the soil by means of irrigation may be largely controlled by keeping the topsoil well pulverized, so as to break up the capillary tubes, as shown in Fig. 5, *a* being the surface, *b* the capillary tubes, and *c* the subsoil. The more recent scientists all agree that the soil is full of small tubes, through which the moisture from below finds its way to the surface and escapes. If these tubes can be closed the water will not evaporate so readily. This

is done by loosening the topsoil, not by stirring it to such a depth as to injure the roots of the plants, but in a manner so as to break the tops of the tubes and throw a covering of loose soil over the ground, and at the same time destroy the robber weeds which not only use the moisture but take away plant food as well. This loose soil is a mulch—a blanket which prevents loss of moisture and protects against the direct rays of the sun. There are, of course, certain kinds of cereal crops, such as wheat and oats, which by ordinary planting do not admit of cultivation, and these from necessity naturally require a larger quantity of water than do the cultivated or hoed crops. This subject of cultivation, as well as that pertaining to the fertilizing elements of irrigating waters, will be treated in succeeding chapters.

**Addition of Silt.**—In most irrigated countries, and especially in the Rocky Mountain region, the principal irrigation of crops is done in the spring or early summer. At this time the water is usually filled with some sediment or silt, which is loosened through erosion by the rapid melting of snow at the higher elevations, and the rush of water to the various rivers from which canals for irrigation are taken out. This sediment is of especial value to land in most instances if the water is properly or evenly applied. When water is conducted to the surface by gentle flooding it runs slowly and allows the sediment to settle on the land in greater quantities and more evenly than by any other means, thus giving greater productiveness to the land. This fact is especially shown by the enormous and continued productivity of the soil on the banks of the Nile,

which are flooded by the annual overflow, leaving a large deposit of sediment.

If the soil is of such texture that it will bake when water is applied to the surface, or the slope should be too great, furrows are made with a roller or furrower at such an angle to the slope of the land as to give the water the proper fall to prevent erosion of the surface soil and to facilitate the deposition of the sediment. By these methods the soil is enriched annually with little or no additional expense, and the crops are increased accordingly. Care should be taken, however, lest the crop be irrigated too freely in the early spring while the water is cold. The soil is thus likely to become chilled, which at least retards the growth of crops. Under such circumstances a farmer may think the soil is thin and poor, but this deduction results merely from lack of experience.

Large amounts of fertilizing material thus naturally find their way to the soil in the water used, tending to counteract the drain on the land due to the removal of crops. As a result of a five-month study of the water of the Rio Grande, a stream which carries excessive quantities of silt, it was estimated that in using one acre-foot of the muddy water in irrigating, 955 pounds of potassium sulphate, fifty-eight pounds of phosphoric acid, and fifty-three pounds of nitrogen were added to each acre. A thirty-bushel crop of wheat usually removes twenty-eight pounds of potash, twenty-three pounds of phosphoric acid, and forty-five pounds of nitrogen. It is also true that considerably more than one foot of water is generally applied to the land each year in irrigating. It would seem to be



utterly impossible to exhaust the soil irrigated with such water. Aside from this there is the humus coming in the form of leaf mold and decayed vegetable matter, which is considered the most valuable element of all in improving the natural soils of the west.

**Manure on Irrigated Soil.**—After being assured that a great surplus of fertilizing ingredients is yearly deposited on the land by the irrigating waters, the reader might conclude that the application of barn-yard manure would be quite superfluous. It has, however, been conclusively proven in practice that even in the case of wheat, which may remove only half the nitrogen yearly deposited by some rivers, the crop is very considerably increased when the land receives a moderate dressing of barn-yard manure every three or four years, while it is often impossible to successfully raise vegetables unless barn-yard manure is freely employed. It is claimed by some that these good effects are due to the improved mechanical condition of the soil and its increased power for holding moisture, and doubtless these facts may have something to do with the result, but it is probable that the real explanation is to be found in the action of soil ferments. Nitrogen may exist in the soil even in excess and yet not be in a form available for plants to feed upon. The same may be said of other fertilizers.

It has been demonstrated that nitrogen in the soil is reduced to nitric acid by means of living bacteria, which are multiplied by fermentation, and this occurs most rapidly in decomposing barn-yard manure. How bacteria perform this useful work is not fully understood, but it has long been noticed that a dressing of

barn-yard manure produces fertilizing results much greater than could be expected from the quantity of plant food contained therein. Chemical analysis often discovers quantities of plant food in the soil which seem amply sufficient to produce remunerative crops and yet the soil is practically poor. It would thus seem that nitrogen may exist in the soil in an inert form in large quantities and not be available for plant food until subject to the decomposing effects of bacteria. It has also been found that these bacteria multiply and work most actively quite near the surface of irrigated soil. This accounts for a phenomenon frequently experienced in various irrigated districts. Where it has been necessary to scrape off the surface of the soil in order to make it level enough to irrigate, the land so scraped remains comparatively infertile for a number of years. It is advisable to apply barn-yard manure to irrigated soils by means of a manure spreader so as to break up all large lumps. If these are placed in the dry soil in their entirety they become fang-burned and prove a great detriment to the succeeding crop, and it may require several seasons of excessive irrigation to disintegrate and render them available. To secure best results from manure it must be well incorporated in the soil by plowing under or harrowing in.

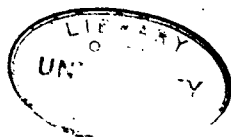

## CHAPTER IV.

### THE TREATMENT OF ALKALI.

**T**O THE average western farmer alkali is the greatest bugbear with which he has to contend in his tillage operations. The soils of the older eastern states are not troubled in this way, and are too often deficient in alkaline salts, for no soil is productive when these ingredients are entirely lacking. Chemically considered, alkali is one of a class of caustic bases—soda, potash, ammonia, and lithia—the distinguishing peculiarities of which are solubility in alcohol and water, the power of uniting with oils and fats to form soap, neutralizing, reddening several yellows, and changing reddened litmus to blue. Fixed alkalies are potash and soda. Vegetable alkalies are known as alkaloids, and volatile alkalies are composed largely of ammonia, so called in distinction to fixed alkalies. The principal compounds or salts of the alkalies with which soil is impregnated are Glauber's salts or sulphate of soda, washing soda or carbonate of soda, and common salt. In much smaller proportions are found sulphate of potash, phosphate of soda, nitrate of soda, saltpeter, and even carbonate of ammonia. A majority of the last five are recognized fertilizers. The most injurious of the three principal salts is the carbonate of soda. Its property of combining with vegetable mold, otherwise known

as humus, and forming with it, when dry, a black compound, has given the name of black alkali lands to those of which it is the principal saline constituent. In time of drouth these can readily be distinguished by the dark rings left on the margin of the dried-up puddles. As Glauber's salt and common salt do not possess this property, the soils impregnated with them remain chiefly white and are known as white alkali lands.

**Formation of Alkali Salts.**—Alkali is a natural element of the earth, the same as other minerals. When the rocks on the mountains pulverize and the sediments wash down on the plains, they bring the alkali along and deposit it in the soil. The same alkali salts are formed everywhere in the world, but in countries having abundant rainfall they currently wash through the soil into natural drainage, while in regions where rainfall is deficient, the scant moisture carries them down only a little way into the soil, from which they rise to the surface by the evaporation of water, and are thus accumulated at or near the top of the soil. It is right there that nearly all the damage is done. The water in the depths of the soil is rarely strongly enough impregnated to hurt the roots of plants directly. The alkali is all through the soil, but is usually worse within a few inches of the surface. It rises to the surface with each wetting of the ground, in the same manner as a wick. Different wicks will raise water or coal oil to different heights, according as they are closely woven or loose, like candle wicking. The close wick will raise the fluid higher in the end, but it will raise to the highest point more slowly than

with the loose wicking. Just so in the soils. The close ones will raise the soil water from a greater depth than will the loose, sandy ones, but the latter will bring it up quicker to the full height to which it can rise.

**Soils Containing Alkali.**—Alkali is always worse in clay soils than in sandy ones. This is because it rises to the surface from a greater depth. In the arid country the rains often wet the soil only a few inches deep, and the alkali forms at the bottom of the moisture and makes hard cakes called hard-pan—for hard-pan is only a soil full of alkali packed hard. We rarely come in contact with alkali in sandy soil, and if it should prevail in such soils it would do no special harm. The action of the weather for ages has caused it to leach out as rapidly as it formed.

The vineyards of the Hacienda de los Hornos, in Cohahuila, Mexico, are planted in stiff adobe soil which by the alkaline efflorescence has become as white as paper. A vineyard which has existed for several years is marvelously vigorous, and there is no appearance that this condition will change. At Viesca, Cohahuila, the clay soil of the public square seems as if it were covered with snow. It produces, nevertheless, magnificent trees and rose-bushes. From this it would seem that the relation of alkali to soils is often misunderstood, and is considered more injurious than it really is to the growth of vines, shrubbery, and trees.

**Effects of Alkali.**—There are, however, many tender garden and field crops that are badly injured even by the white alkalies that we have seen under such peculiar conditions in Mexico. While the corro-

sive action exerted by the alkali salts upon the root crowns and upper roots of plants is the most common source of injury, there is another kind of damage which manifests itself, mainly in the heavier class of soils thus afflicted, when the soluble salts consist largely of carbonates of soda and potash. This is the great difficulty, or almost impossibility, of producing a condition of true tilth, in consequence of the now well-known tendency of alkaline solutions to maintain all true clay in the most impalpably divided or tamped condition, that of well-worked potter's clay, instead of the flocculent condition it assumes in a well-tilled soil.

**Waters Carrying Alkali.**—There are some classes of water which it is not advisable to use for purposes of irrigation. Thus it was at one time proposed to use the waters of Kern and Tulare lakes in California for irrigation, but careful investigation showed that these waters were strongly alkaline and that their continued use would deposit on the surface a sufficient coating of salt to render the lands sterile. The beds of these lakes are coated with a deep stratum of alkali. Similarly some artesian waters, and even the waters from some flowing streams, like the Salt Creek in Southern Arizona, for instance, would result in the production of alkali.

Alkali is chiefly the result of defective irrigation by permitting evaporation of sub-surface water, thereby leaving alkali on the surface; but the largest proportion of damage is brought about by the rise of the sub-surface water-level by lateral soaking from high-line canals, and the trouble is greatly aggravated and extended by the extravagant use of water.

In irrigating light soils very small streams of water should be used; otherwise, if the drainage is good there is danger of washing out the soluble fertilizing elements, leaving only the coarse mineral constituents, and rendering the soil less fertile and productive. This precaution is especially necessary when using the clear, pure water from springs or artesian wells, which carries ordinarily little of the rich fertilizing sediment characteristic of streams which flow for long distances through alluvial regions. In the employment of the latter, if well charged with sediment, the use of a large irrigating head is frequently advantageous, as it gives an opportunity for a uniform settlement of the sediment while the water is entering the soil.

**Remedies for Alkali.**—The remedies for the improvement of soils surcharged with the neutral alkaline salts, the texture of which is very compact and adhesive, are thorough tillage, the leaching out of the alkali by irrigations combined with either natural or artificial drainage, and frequent irrigation of the soil, assuring the intermixture of the surface deposit of alkali with the lower strata of soil, and thus diluting it and partially neutralizing its injurious presence. As shown in the preceding chapter, cultivation also checks evaporation, and hence currently lessens the deposits of alkali on the surface. A loose, dry top-soil acts as a cushion of earth and air, intercepting the continuity of the upward passage of moisture along the lower plane of cultivation.

The writer has more recently been asked by a number of correspondents to give an opinion regarding the suitability of stable manure and other fertilizers as

absorbents of the alkaline salts. Under the impression that alkali land is poor in plant-food, many farmers have tried such methods with varying degrees of success. As a rule, these applications are not only useless but even harmful. From their very mode of formation, alkali soils are exceptionally rich in plant-food, so that the addition of more can do no good. In case stable manure is used on black alkali ground, a pungent odor of ammonia is given off whenever the sun shines, and plants otherwise doing well are thus injured or killed. When well plowed in, stable manure will often prevent to some extent the rise of alkali by diminishing evaporation, but its usefulness in that respect is readily replaced by good tillage. The main benefit obtained is the addition of humus to soils that have been whitened by alkali action.

Potash salts, especially kainit, are wholly useless and add to the alkali trouble. Potash is always abundantly present in alkali lands, even in the water-soluble condition. Nitrates also are always present in alkali soils in sufficient amounts for plant growth and sometimes in excess. Phosphates may be useful, but will rarely be needed for some years. Green manuring, on the other hand, is a very desirable improvement on all alkali lands, and for this purpose such crops as alfalfa, alsike, pea-vines, salt-bush, and soy-beans, or even buckwheat, can be utilized. Of all grain crops for white or black alkali land there is nothing so good as barley, with rye next in order and then oats, wheat being most unsuited of all. We have never tried the new Russian grain speltz, but believe from its habit of growth that it will stand close to barley as an alkali



tolerant. In the semi-tropic regions, where frosts are not severe, the imported Australian salt-bush, botanically known as *Atriplex semibaccata*, has proven eminently satisfactory as a resistant, at the same time proving a desirable browsing forage for live stock.

**The Flooding System.**—The most effective means of getting rid of ordinary white alkali is by washing it out of the land. This can be accomplished by digging open ditches at a lower level than the surface of the land to be treated, and carrying them to the nearest natural outlet. Then by running water over the land into the drains without allowing it to stand long enough to soak into the ground and carry the dissolved alkali with it, most of the alkali that has accumulated at the surface will be removed. By repeating this treatment a few times land can be practically freed from alkali, unless it is exceptionally bad. Another plan is to use the blind ditcher, a machine much like the old ox plows used in Illinois and Iowa thirty years ago to make blind ditches along the prairie sloughs. This implement is calculated to run ditches from four to six inches lower than the plowed ground, every sixty or eighty feet across the tilled ground, to serve as drains. Another plan, and to our notion the most practicable one suggested, as well as the most expensive, is to underlay alkali land with vitrified sewer pipe. This will last a lifetime and will certainly get away with the alkali.

In many cases the over-irrigation of bench or slope lands has caused first the lower slopes and then the bottom lands to be overrun with alkali salts, although before irrigation was practiced these lands were exempt

from them. In some portions of the San Luis valley, in Southern Colorado and elsewhere in the west, this trouble has become most serious, fertile lands long under successful cultivation being rendered useless by thousands of acres, unless an expensive system of underdrainage is undertaken. One plan which can be operated early in the spring, before the regular irrigating season, has been tried quite successfully and is described in a few words: An eighty-acre tract is divided into plots or rooms  $8 \times 32$  rods by means of dikes, such as described in the Mexican border system of applying water. This should be done in the fall so that they will be solid in the spring. The formation in the San Luis valley is first a surface soil of two feet over two feet of clay and gravel, then eight inches of quicksand overlying the hard-pan, which is from eight to eighteen inches thick. Below this is forty feet of dry sand.

As soon as the frost is out, and while water is plenty, turn a large head into an upper corner border at the supply ditch. When it is filled, open a passage into the next border, and so on until it reaches the waste ditch at the lower end of the field. In the waste ditch drill an inch hole down to the hard-pan and put in a stick of giant powder which will blow out a hole as large as a barrel. A more simple and safer method in making these escapements would be to use a post-auger. When the water, black with alkali, reaches the waste ditch it immediately runs through these holes and is lost underneath in the sand. Keep the water running as long as it is discolored. Some of the worst land in the valley has been reclaimed in this

way. After flooding, good judgment must be used in working the ground before it bakes. Two floodings will cure the most obstinate case and a fortnight is usually required to thoroughly flood eighty acres.

**Chemical Antidotes.**—When the quantity of alkali is small the evil effects resulting from its presence may be mitigated by the application to the soil of chemical antidotes. A cheap antidote for most alkaline salts is lime. In some cases neutral calcareous marl will answer the purpose. When the alkali consists of carbonates and borates, the best antidote is gypsum or land plaster. These materials should be sown broadcast over the surface and harrowed in to a moderate depth prior to irrigating. The usual amount of gypsum to apply is from 400 to 500 pounds to the acre. A California professor once became so inoculated with the gypsum doctrine that he applied 3,600 pounds to the acre and was satisfied that the process proved to be altogether too expensive, although it removed 75 per cent. of the alkali by using the gypsum in connection with the flooding method. Gypsum is the only cure for the disastrous black alkali so fatal to plant life.

**Eradication by Vegetable Growth.**—It may often happen that all of the foregoing recommendations will prove ineffective, and to many cultivators they may be inaccessible. The most simple and natural remedy to absorb the alkaliferous elements in the soil, as has been found from the writer's own experience, is by growing them out with certain neutralizing crops. If these do not entirely eradicate alkali in one season they should be continued year after year until the

desired result is obtained, and during this period a rotation of the specific crops may be resorted to if so desired. Sugar-beets are no doubt the best things for this purpose, although any of the long-rooted crops will do nearly as well. Potatoes will not answer at all. Any of the sugar-canes are beneficial, but the more gross feeders or the leguminous plants are better. Nothing is better probably than alfalfa, the great nitrogenous forage plant of the west, or its cousin esparcet, as these shade the ground, and their deep roots absorb nearly all the water and dissolved salts, while on the whole they reduce evaporation to the minimum. Other recommended crops are carrots, turnips, cabbages, hops, pea-vines, and sowed corn. In orchard planting such trees may be set as the peach, pear, quince, apple, and prune; and small fruits and the grape—but for the latter cuttings must not be used, and the topsoil must not be too strong with alkali. It is said that the olive will grow in the black alkali.

**Planting Trees in Alkali Ground.**—We are frequently asked if there is any way to plant trees on alkali soil so that they will live. As we have said before, alkali soil packs very closely, a great deal more so than soil not impregnated with this salt. If made wet it runs together like soft mortar. If a hole is dug in alkali soil the walls will be as smooth as it is possible to conceive earth to be, showing the disposition of this soil to pack too closely for young tree life, while the tree planter may lose his labor, not even saving the holes he dug. Our experience has been, after digging the hole for the tree the usual depth and the usual way, to take a quarter of a stick of giant powder and

put it down a foot deeper in the bottom of the tree hole and blow up the packed earth by exploding the same; and at the bottom of the hole put a layer of pure gypsum, place the tree roots on the gypsum, take clean chaff straw, soil and gypsum, about eight pounds of the latter and half soil, and half clean straw, and fill up the hole made for the tree. Do not in this case use the top-soil to fill the hole, as would be best to do if there were no alkali. When the tree is planted, take an old fruit can, put it in the fire to spring it apart, and then place it around the body of the tree above the crown roots and at the surface of the ground, the can to be so placed that the top may come even with the ground's surface, and should be filled with gypsum. The best kind of pear trees to plant in alkali soil are Beurre Hardy, Winter Nelis, and Trout. The Bartlett does not do so well.

## CHAPTER V.

### WATER-SUPPLY.



**I**N CALCULATING on engaging in an irrigation enterprise of any kind it is well to remember that we must first catch our rabbit before we can cook the stew. No one should attempt irrigation without first having determined the extent and continuity of the water-supply, and where a vast amount of money will be needful in carrying out the enterprise, as in the construction of large works, the services of a practical hydraulic engineer should be secured by all means, and his report should be rendered before entering upon the scheme. To get at the source of all water-supply, we must accept the well-recognized scientific fact that the waters upon the earth and the clouds in the air are forever in reciprocal motion. The waters are lifted and ascend into the heavens, the clouds are drifted away over the land and discharge their moisture upon the land, and life is supported thereby. The amount of water which is taken out of the ocean by evaporation each year is very great. About thirty-five or thirty-six inches of water rise by evaporation from the surface of the earth annually. This rainfall on the entire earth would make a sheet as large as the surface of the earth and about three feet in depth. It would fill Lake Superior six times every year.

**Evaporation and Run-Off.**—When the rain falls upon the surface of the earth, a part is evaporated and carried away in the clouds, a part sinks into the soil to be slowly evaporated, and a very large part is carried away by vegetation itself. Plants drink water and transpire it into the air in very large quantities. That which is not evaporated from the earth's surface sooner or later, or transpired by plants, is gathered into the rivers; we call that which ultimately flows out to sea the "run-off" water; and that which is evaporated and which drifts away in the air we call "fly-off" water. These are two very common, simple terms. In calculating the requirements of modern irrigation, the best authorities hold that the water supply for a given acre should be sufficient to cover it twenty-one inches deep during the course of an irrigating season of 100 days. Some experts place the maximum as high as twenty-four inches, which is an estimate that is certainly liberal enough.

Other conditions being equal, the drier the soil the greater its absorptive powers. An ordinary rain falling upon a dry, cultivated field will be almost entirely absorbed, but if the ground is already charged with moisture nearly all the rain will run off the surface and be carried away through the ordinary drainage channels. The per cent. of the total rainfall which joins the run-off in humid climates is therefore much greater than in arid regions unless other conditions modify the results. In general, therefore, the proportion of the total rainfall which may be depended upon for filling reservoirs in arid and semiarid climates is much less than in humid sections. The rapidity of

precipitation is an important factor in the calculation of the relative percentages of rainfall and run-off. A mild rain continued through many hours will give but little run-off, while the same amount falling in one-fourth or an eighth the time will give a greatly increased run-off. Unfortunately the climatic conditions are such in nearly all the arid portions of the world that what little rain does fall comes in the form of hard, driving storms. On the great plains of America it is by no means unusual for a two-inch rain to fall in as many hours, while instances are of yearly occurrence in which four inches or more fall within one hour. Under such conditions almost all the water runs off, except in the most sandy places.

The most important of all the conditions affecting the run-off is the character of the ground upon which the water falls. A loose, porous soil will absorb a large portion of a rainfall, as will also a sandy surface, while a close, compact soil sheds the greater part of it. An area composed principally of a close-grained shale, and soil resulting therefrom, which generally has a compact clay subsoil, has inferior absorptive properties, while one composed principally of sandstone and sand will allow but little water to run away. The flood plains of rivers frequently have little power of absorption. In times of overflow a thin layer of a fine-grained sediment is deposited, which is partially cemented by an organic mucilage produced by the decomposition of mineral matter of one kind or another. This material is almost entirely impervious to water, a thin layer of it being sufficient to prevent downward percolation, no matter how sandy the soil below may



be. Illustrations of such conditions are found in many places along the valleys of the Arkansas, the Rio Grande, and other western streams, particularly those which rise at great elevations and have a strong velocity throughout their upper courses and a low velocity farther down stream.

**The Surface Supply.**—We are safe in claiming four distinctive sources of water-supply, which may in turn be divided into two classes. These are the streams, natural lakes and reservoirs, underflow or phreatic waters, and the deep subterranean or artesian basins. Of these the most practicable and available are the living waters of the natural streams. In the older irrigated states, where the legislators have framed laws for the appropriation of running waters, the control thereof is usually placed with an executive officer, generally called the State Engineer, who virtually has under his charge and supervision the control of the running waters. He gauges the streams, keeps a record of their flow, and doles out the canal rights in accordance with the statutes. First come, first served is the rule, and ditch charters which are granted by him are issued in consecutive numerical order, until the full carrying capacity of the stream is allotted, when further issuance of charters ceases.

In the most successful irrigating watercourses taken from the perennial streams, the headworks are almost invariably located well up on the river, to command sufficient level in order, if possible, to tap the stream where the water is clear and not laden with silt. By thus locating the intake it is usually possible, owing to the greater slope of the country, to reach the high

lands or watersheds of the area to be irrigated with the shortest possible diversion line, or that portion of the canal's course which is necessary to bring the line to the neighborhood of the irrigable lands. This is usually expensive and unproductive of immediate benefit, as it does not directly irrigate any land. The disadvantages of locating the canal headworks high up on the streams are serious. The country having an excessive fall requires rough hillside cuttings, perhaps in rock, and the line is, moreover, intersected by hillside drainage, the crossing of which entails serious difficulties. But along the great Rocky Mountain foothills this objection has been entirely disregarded, and the English or High-line canal flows through the rock-ribbed South Platte cañon a distance of over thirty miles before it reaches the open country, where the first water is delivered to patrons. When taking out a ditch in a flat country, as is often the case, the work is much more simple and not nearly so expensive. These conditions are often observed in the prairie districts at great distances from the mountains.

The other classification of surface waters is that of the catchment area or reservoir order, and is a source of supply that may be termed artificial. Holdings of water by this plan may be obtained without resorting to the streams, by providing dams at suitable places for catching the storm or run-off freshets coming from rainfall on a vast watershed lying back of and at an elevation above the reservoir site itself. In selecting such sites, however, two or three cautions must be observed. In no case should the water be stored in main channels. Suppose there is a ravine running

down, with side ravines cutting into it and with many laterals, and with a tract of five or ten square miles above, which acts as a catchment area for waters which run down in flood or storm times. Now, if we attempt to catch the waters in the main channel, the works must be strong enough to hold and control all the water which may ever flow there. The great storms will only come once in a while, say five, ten, twenty, thirty or forty years apart, but when they come they will sweep everything before them, unless enormous works are constructed which are unnecessary to hold the waters of ordinary years. In taking water from streams build cheap diverting dams, with a few sand-bags or something of that sort, to keep the water back and turn it out into a side channel. It is the result of experience in Mexico, Spain, and India that the storm waters, when stored, must be impounded in the lateral basins.

**Mud and Silt in Reservoirs.**—There is another difficulty about the storage of storm waters which can be avoided by the plan suggested. Storm waters are always more or less impregnated with mud, and if these roily waters are stored in the main channels the reservoirs will soon fill up and destroy the catchment by the mud and silt, brought down from above, accumulating in the bed; but if the water is diverted into a lateral or supply channel, the flow can be checked, by methods which are well known, so as to deposit the mud and silt largely, and carry the purer waters around into the reservoir. These conditions must be carefully observed if success is to be attained in the storage of storm waters. Experience shows that it is

more economic, and that a greater area of the world is irrigated by the storage of storm waters than is irrigated by well waters. Storm waters are very rich, carrying with them many elements of fertilization, and are very valuable.

**Underflow, Phreatic and Artesian.**—These are all definitions of subterranean waters. Underflow waters may consist of either the phreatic—those waters underneath that have come from the surface—or the artesian, which are almost invariably deep-founded, and owe their depth to the earth's stratifications, through which they have percolated from higher sources, either open or hidden, and generally in either case at great distances from the artesian channel proper. These waters are necessarily not nearly so available as the more readily attained surface supplies, and are to be developed only in urgent cases and in the places where a surface supply is not accessible. Underflow waters are sometimes brought to the surface by the gravity process. This is possible in the sandy beds of many western streams a greater portion of the year. Phreatic waters usually abound within 100 feet of the surface and are raised chiefly by pumps, while the deep artesian have an invisible power, which forces the water to the top in ever-flowing streams. Later chapters in this work will bear upon these subterranean waters more fully.

**Tunneling for Water.**—In California where fruit crops form the main agricultural pursuits, the rather expensive plan of tunneling the high mountains for water supply has been successfully carried out in many places. The work has been done mostly by organized

companies with plenty of capital, the object being to make salable the adjacent tracts of foothill lands, which for several reasons are best adapted to fruit culture. These tunnels are opened by means of diamond drills operated with the power of compressed air supplied by an air-pump, at the opening of the drift. As a rule the tunnels are less than 1000 feet in length, and are run in such way as to tap the various shelving stratifications of formation, which carry more or less quantities of pure water seeking its level from the higher mountains. The plan is practicable in supplying a satisfactory head of water to fill an ordinary ditch, but before such a heavy undertaking is commenced the services of a geologist or hydraulic engineer should be called to determine the nature of the mountain's interior, especially as to the amount of water it may contain. There is no use of going to the expense of running an adit until the hidden water supply is fairly well approximated. All mountains do not contain water, and this fact is very essential in undertaking such an enterprise as described.

**The Newsom System.**—A simple gravity system for tapping the underflow of hillsides or dry streams with considerable pitch has been invented and patented by Prof. Eli Newsom, and a sample plant is in successful operation near Parker, Colorado, twenty miles south of Denver. This system gives a constant flow of water, much as described under the foregoing caption on tunneling, but the plan is necessarily much cheaper, and with a sufficient supply of water it ought to be able to irrigate from twenty to forty acres quite readily. Professor Newsom's device consists of an artificial reser-

voir or fountainhead from which radiate a number of collecting tubes. From the fountainhead outward through a trench or tunnel extends a discharge pipe to the surface of the ground below the normal water-level. This pipe has an enlarged head with a strainer, and the whole idea is quite clearly elucidated in Fig. 6, shown

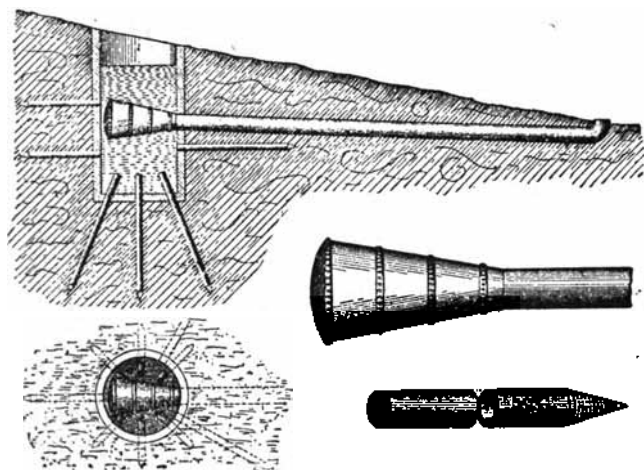

FIG. 6—THE NEWSOM SYSTEM OF WATER-SUPPLY.

herewith. By this plan underground waters gathered in a well within reasonable distance of the surface and situated higher than the land to be irrigated can be easily diverted and applied in a never-failing supply. In winter the water can be diverted through a waste way or can be reservoired wherever desired.

**Water Witchery.**—Ever since the writer can remember he has been conversant with the methods of certain men who claim to possess the occult power of

locating a stratum or underflow of water by means of a forked stick, held in such a way that it is expected to dip at a point over the underlying waters as the operator passes along on the surface. This is called "water witchery," and is at best a very problematical practice, scarcely worth the time that one might devote to it, and certainly not always worth the fees that may be charged. The way to put a water locator of this sort to a practical test is to place stakes at the points where his forked willow may show the downward tendency, indicative, as he will say, of the water underneath. Let several stakes be driven at different points. Then blindfold the water prospector, lead him around in a circle several times, and if his magic wand will repeat the dipping actions as before, and the two sets of stakes agree, some dependence may then be placed in the operation, but the test will be more apt to fail and the deception will at once be apparent.

## CHAPTER VI.

### CANAL CONSTRUCTION.



WATER is king, and the most important adjunct to the greater requirements of irrigation is a good canal system. The gravity supply of water is by all odds the best that can be employed, and the farmer who has a good ditch in perfect working order may consider that he has a fortune lying at his threshold. In laying out a system of ditches for a farm, use care and time. Think it over well, and it may be economy to employ a hydraulic engineer to run levels and determine grades. No large canal system should be undertaken without consulting an expert engineer. Each farm to a certain extent requires a ditch system adapted to its peculiar topography, soil, and crops. See to it that the water can get off the land as well as on it. Remember at all times that drainage is quite as necessary to successful irrigation as the water-supply itself. The matter of grade for a ditch is one which depends so much upon circumstances as almost to preclude rules. It is safe, however, to make the grades as light as possible to avoid "silting up" or settling. Cutting may be called perpetual motion, for if once begun it seems never to stop. The ditch gradually gets lower and lower until the water cannot be got out of it at all, and it must either be abandoned or have falls built in it to keep the flow



near the surface. As far as possible keep the grade uniform, as changing the grade tends to cause both cutting and silting. A ditch for irrigation on a farm should always be much larger than the actual demands require. In Spain their hundreds of years' experience has taught them to make their ditches very large. They could thus irrigate their lands quickly and be done with it. The ditches were far less likely to break and could be easily crossed by wagons or farm implements. During sudden showers they could carry off the drainage water from immediately above them and thus avoid many a washout.

**Laying Out.**—The laying out of ditches is the province of the engineer or surveyor, although the more intelligent farmers may do much of their own work and thus save considerable expense. Something of a knowledge of leveling must be had in order to do the work, but sufficient may soon be acquired to permit of much home work being done. Every man who has much ditch building to do should have a cheap grade level and target, which should not exceed \$25 in cost, while a very good outfit can be bought for \$12. The writer has used the Jackson very satisfactorily. This instrument is shown in Fig. 7, while the target or flag is given in Fig. 8.

If but little work is to be done a carpenter's common spirit-level fastened onto a sixteen-foot strip of board will answer very well. Instructions for running grades are sent with each instrument. The first operation is to begin at the selected head and take a series of long sight levels down the course of the river to ascertain its approximate fall. These levels should be

taken with two rods to save time, the locator making a sketch and estimating roughly his distance at the same time. Having gone down the river far enough to satisfy himself as to its fall, he turns at right angles as nearly as may be and continues to level hillward across the valley until he records the elevation assumed as the head of the works. He will now be able to fix

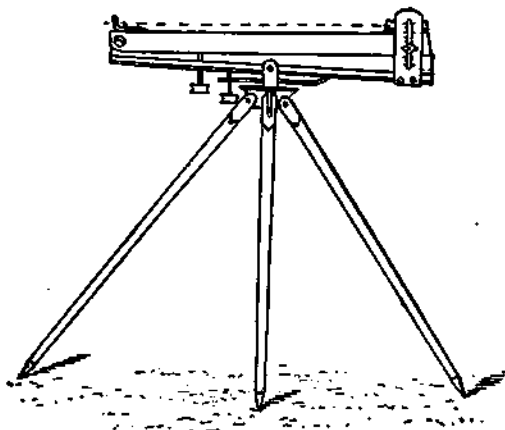

FIG. 7—THE JACKSON LEVEL.

the location of any chosen grade upon the line of his cross levels according to his estimated distance, and is therefore also in a position to estimate approximately the rate of his grade. He knows from his sketch and estimated distance what area of the valley is behind him on the up-stream side bounded by the river, by the canal, and by the line of his cross levels.

The next operation is to turn again at right angle and continue leveling down the valley more or less upon

the line of the canal, still approximating the distance and going up or down if he thinks it worth while or necessary to rectify position from time to time, according to the distance estimated and the grade assumed. Having gone as far as it is intended to build the canal, he should turn at right angles across the valley back to the river and take his last line of levels. Throughout the operations described, as many good bench marks as possible should be established for future reference. The taking of these levels being done, he should finish his track survey of the river-bank up the stream to the point at which his first line of cross levels originated. Having established the objective point in this way, the matter of running the transit to the target and placing the grade stakes is very simple, and any schoolboy ought to be able to locate the grade line correctly.



FIG. 8.  
TARGET.

In case a surveyor is not engaged and the spirit-level is to be employed the procedure is very simple. Take a pine plank two by six inches by sixteen and a half feet, surfaced on all sides, the edges of which should be reduced to a true, straight edge. Exactly midway of the stick, on one edge, fasten a carpenter's spirit-level with such accuracy that when the plank is set on edge on a level surface the instrument will indicate a level. To locate a ditch with a fall of one-fourth of an inch to the rod, attach at the extreme end of the plank, on the opposite edge to the level, a block of wood one-fourth of an inch

thick. Beginning at the highest point on the land to which the water is to be conducted, drive a stake so that its top will be six inches above the surface of the earth. On the top of this stake place the end of the straight-edge to which the quarter-inch block is fastened, the block resting on the stake. Drive the next stake one rod from the first stake, toward the source of the stream, at such a point that the second stake is driven so as to project six inches above the surface of the earth. With the straight-edge resting on both stakes the spirit will thus indicate a true level. Obviously a ditch dug between these two stakes, at a uniform depth below the top of each stake, will be one-fourth of an inch deeper at the lower end. Proceed thus until the top of the last stake is six inches above the surface of the water in the stream. Be careful not to reverse ends of the straight-edge level, but keep the end to which the block is fastened down-stream. The line indicated by the stakes is the ditch line, and the bottom of the ditch should be at a uniform distance below the top of each stake. These instructions are only available in small work, such as an ordinary farmer might require in an individual way, and cannot apply to the work of excavating a great canal, which should be surveyed in the scientific manner.

**Ditching Methods.**—With regard to excavation and costs, the smaller ditches may be constructed by hand shoveling, by plowing, and by scraping, or by plowing with a large double-mold-board plow; the larger ditches by plowing and scraping, or by grading or ditching machines. Hand-work is of course most expensive, but it will be necessary in some places.

Some plowed ditches are the cheapest, but they are only temporary, and in the end more expensive. Scrapers will cover the greatest range of work and will fairly represent the average cost. The modern thing in scrapers is the wheeled affair. Work done with ditching machines is very satisfactory and far cheaper than any other work. Not every farmer can afford to buy a machine to do his own work alone, but when farmers become associated in the putting down of wells and the construction of reservoirs and ditches, then it will pay to buy machines, for on a large piece of work they will soon pay their cost.

**Cost of Construction.**—Classifying irrigating canals and ditches according to their widths, it has been found that for those averaging less than five feet in width the expense of construction, including headworks, flumes, etc., is \$481 a mile; for those five feet in width and under ten feet, \$1,628 a mile, and for those ten feet or more in width \$5,603 a mile. The greater number of the irrigating systems of the country have been constructed under such conditions that the owners cannot give even an approximate estimate as to what they really cost. Many of them have been built by the efforts of a few farmers acting originally in partnership, and have been enlarged from year to year as more land was brought under cultivation and population increased. Farmers, as a rule, do not keep account of the amount of labor or money expended on such works, and in cases where they own the irrigating ditches they do not take into consideration the labor expended upon the ditches at times when the farm work is not pressing. When contractors figure

on the cost of building a canal exclusive of the rock work they usually calculate the expense of excavating at from ten to fifteen cents a cubic yard of earth removed. The actual cost of this work has of later years been reduced, by means of the big grading machines, to the minimum of three or four cents a cubic yard. In arriving at the cost of canal construction in various parts of the west the government officials have compiled the following tabulated computation :

AVERAGE COST PER MILE OF CONSTRUCTING IRRIGATING  
CANALS AND DITCHES

STATES AND TERRITORIES	<i>Under 5 feet in width</i>	<i>5 to 10 feet in width</i>	<i>10 feet and over in width</i>
General average . . .	\$481	\$1,629	\$5,808
Arizona . . . . .	471	1,674	5,274
California . . . . .	895	5,957	15,511
Colorado . . . . .	860	1,181	5,358
Idaho . . . . .	208	810	1,320
Montana . . . . .	335	800	2,900
Nevada . . . . .	300	1,150	
New Mexico . . . . .	310	681	6,666
Oregon . . . . .	260	1,060	1,800
Utah . . . . .	468	1,025	3,072
Washington . . . . .	385	1,225	2,571
Wyoming . . . . .		887	3,694
Sub-humid region . . . . .	308	447	1,884

Since the foregoing estimates were made up and following the publication of this book in 1895, the cost of ditch work has decreased very materially, so that future estimates must be on a much lower scale. For instance, on ordinary ditches the large-sized drag-scrappers will deliver one-sixth of a cubic yard in one load. With good teams and proper management, one yard every six minutes, or ninety yards a day, can be removed. In scraper work the cost of excavating

ninety cubic yards would be \$4.12, or 4.6 cents a cubic yard. In handling sod four-horse plows are necessary to break the surface. This material is very difficult to handle, and the increased expense and small output brings the cost up to five or more cents a cubic yard. In heavy gumbo or cemented gravel, if plowable at all, the cost of scraper work is generally increased to as high as eight or even ten cents a cubic yard. As before stated, in making canals the recently perfected graders are more desirable than scrapers. These machines consist of a plow which breaks up the surface, raises the soil and throws it on an elevator, which delivers it at the side of the ditch. The great amount of turning is avoided and the work is more rapidly done. Dry sand is the most difficult material in operating these graders, for, lacking adhesion, it does not rise readily upon the mold-board of the plow and fall upon the carrier. Experts, however, handle large quantities in a day, and find the cost considerably less than removing the same amount with scrapers. Fine disintegrated rock is equally as difficult to handle as sand. Wet sand is more readily removed, as it holds together better. These graders do good work in sod. In moist clay or loam additional horse-power is necessary. The same is true in adobe and gravel soils, but as the machines are strong enough to stand a strain of twenty-four horses, work can be done which is impossible under any other method.

The foregoing estimates cover ditches ranging from 2 feet wide at bottom, 8 feet at top, and 2 feet deep, to 16 feet wide at bottom, 32 feet at top, and 4½ feet deep. Larger ditches can be built with the graders at

slightly increased cost, for they can then be used as wagon loaders, and the earth hauled to any desired point. A large ditch 18 feet wide at bottom, 30 feet at top, 4 feet in depth, with a four-foot additional embankment, with a capacity of 6 feet in depth, 36 feet at surface, and 18 feet at bottom, having a cross-section of 162 square feet, with a current of two miles an hour, would, in twenty-four hours deliver sufficient water to cover 940 acres 1 foot deep. A mile of such a ditch could be built by three men with six teams in eighteen days at a cost of about \$400. By ordinary methods such a ditch would cost several times this amount. A ditch 8 feet at bottom, 20 feet at top, and 3 feet deep would cost approximately \$200 a mile. A lateral 4 feet at bottom, 12 feet at top, and  $2\frac{1}{2}$  feet deep, carrying  $3\frac{1}{2}$  feet in depth of water, can be built at from \$75 to \$100 a mile, and a small ditch 2 feet on bottom, 8 feet at top, and 2 feet deep, can be constructed with these graders for about \$50 a mile. These figures have been calculated somewhat lower by the manufacturers of ditching machines, but we believe the estimates made herein are more conservatively correct than those of the makers.

**Form and Capacity.**—To get the greatest possible velocity the ditch should be in the form of half a pipe or a pipe split in half lengthwise. This would require the width of the ditch at the top to be exactly twice its depth in the center. In other words, it would be as wide at the top as the length of the diameter of the pipe, and one-half diameter deep from the center to any point of the sides or bottom. A ditch of this form offers less friction surface in proportion to its



cross-sectional area than any other form, and also keeps the depth of the water in the ditch nearly half its width. The diameter of a pipe we will say is 4 feet. Its circumference would be, therefore, 3.1416 multiplied by 4, equal to 12.5664 feet; when it is halved lengthwise half the circumference would equal 6.2832 feet.

To get the greatest velocity and quantity of water to flow in a rectangular canal it should be of such form as to cause the water in it to flow exactly one-half as deep as wide, because the velocity of flow in such a canal is proportional to the square root of the hydraulic mean depth, and the hydraulic mean depth is at its maximum when the breadth of the water is just twice its depth. Fanning says that the variation of velocity, with varying depth, is nearly as the variation of the square root of the hydraulic mean depth.

**Grades and Slopes.**—The grade is one of the important things to be considered in canal construction. Ditches running from twenty to over one hundred miles have widths from twenty to eighty feet, some being built with and some without berms—the grades ranging from one foot to seven feet a mile. The steeper grades are not common and are for short distances only. The average grades for main ditches, carrying from two to six feet of water, are from one and one-half to two and three-fourths feet a mile. Such low grades will answer only for the larger ditches carrying large volumes of water, and where the ratio of volume to resistance or friction on the sides is large. In smaller distributing ditches, where the volume is smaller and the resistance proportionately much greater, a steeper

grade must be allowed. The location of the well or reservoir on or near the highest point fixes the point of radiation of the ditches, their lines being located according to the grades secured and the lay of the land to be served. The aim will always be to keep the

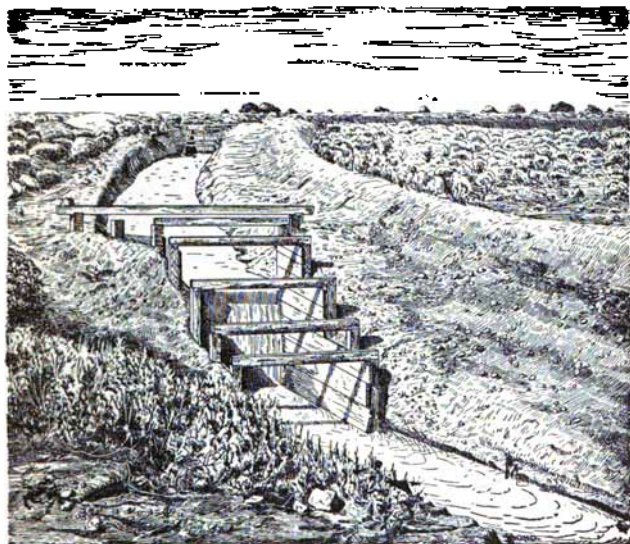

FIG 9—DROP AND REDUCTION BOX.

water up as high as possible, for it is useless to sacrifice grade or make a ditch run at a greater grade than is necessary. It is an easy matter to let the water down, but a difficult thing to raise it.

A method for dropping the grade of a ditch when the pitch becomes too great is shown in Fig. 9. This

is a drop box for the fall and is often made a reduction box as well. It is useful in places where the water-supply is lessened by serving customers farther up the line, or when the volume of water becomes less from any other cause. Another plan is the use of the inclined flume. By keeping the water grades up, a broader area is kept within the range of service. Grades of from two to five feet a mile will be ample to secure good delivery from the smaller main ditches, while the laterals will require steeper grades, which in many cases may be confined to the approximate level of the field, except on hillsides or quite abrupt slopes, in which case the grades will be carried around the slope as contours.

As to side slopes, the usual ratio is one to one in cuts of common material, with sometimes one-half to one in harder material and one-fourth to one in rock. For outside slopes of embankments the usual ratio is one and one-half to one, and for inside slopes of banks usually two to one, except in crossing ravines with the bank, when the inner slope may be two and one-half or three to one, owing to the depth of bank below the grade line. In a flat country where the bottom of the canal is kept as near the natural surface as possible, and embankments are built on both sides, the side slopes may be as flat as three to one from the bottom of the cut to the bank without any berme. Many fair-sized canals even up to twelve or sixteen feet wide, and carrying three or four feet of water, have been made without any berme and seem to have stood well.

**Curves and Friction.**—The more earth surface and the greater number of bends the water comes in

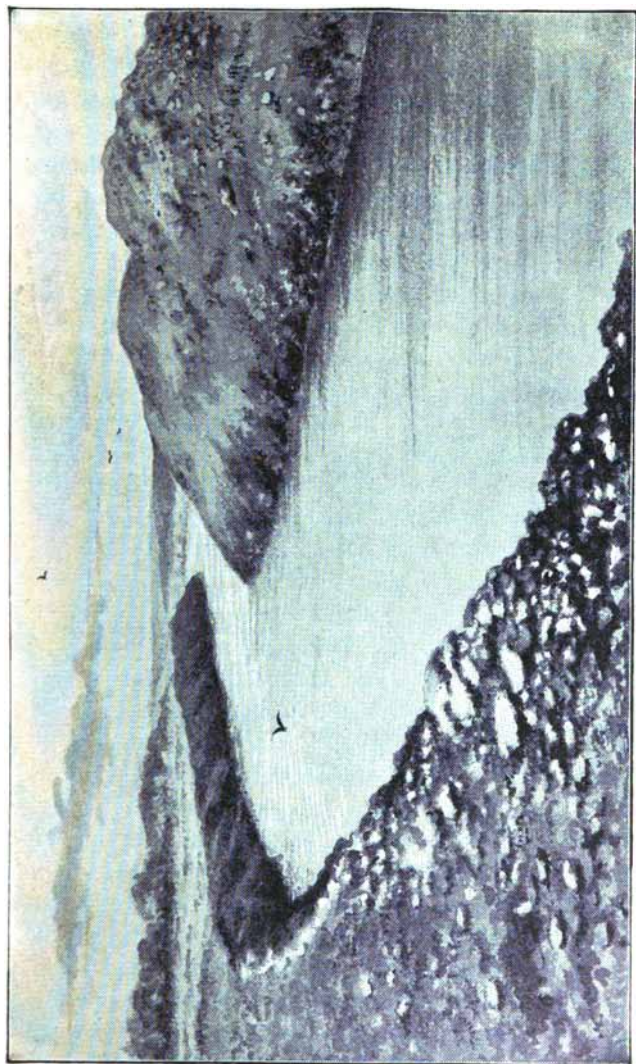

FIG. 10—CURVE OF A LARGE CANAL.

contact with in flowing in a ditch, the greater the friction will be and the less the velocity and quantity of water. Therefore to obtain the greatest velocity and quantity of water the ditch should be as straight as possible. If bends are necessary they should not be abrupt, but as gradual as possible. A very good example of an easy curve is shown in Fig. 10.

For a steady flow the grade should be the same the entire length of the ditch, or as nearly so as circumstances will permit. The sides and bottom should be regular and smooth, and clear of stones, weeds, etc. The weak spot in every canal is most apt to be found at the curves and angles, and these must be protected. Where, as is the case in some sections, there is plenty of stone, the water-line at the curves may be partially protected by riprapping, but this involves a large amount of labor. Where there are no stones other means must be used. Willows are oftentimes planted to give bank protection. Where gravel may be had a shore line may be covered with it, thus forming a natural water-break. In some cases it may be best to construct a breakwater of plank sharpened and driven into the bank, or laid to posts set in the bank. The steeper the bank the greater, of course, will be the displacement of the earth by water's action. In Fig. 11 is seen a canal on the hillside.

**Headgates.**—The best mechanical effort in building a canal should be expended on the headgate. This should be located within a few hundred feet of the intake at the river with a fore bay of only moderate grade intervening. The old-fashioned headgates were built of lumber and were not usually sufficient to with-

stand the tearing force of freshets in the stream. Iron gates came later and were fairly successful in withstanding the attacks of storms, but they often caused more serious damage to the lower bank of the fore bay

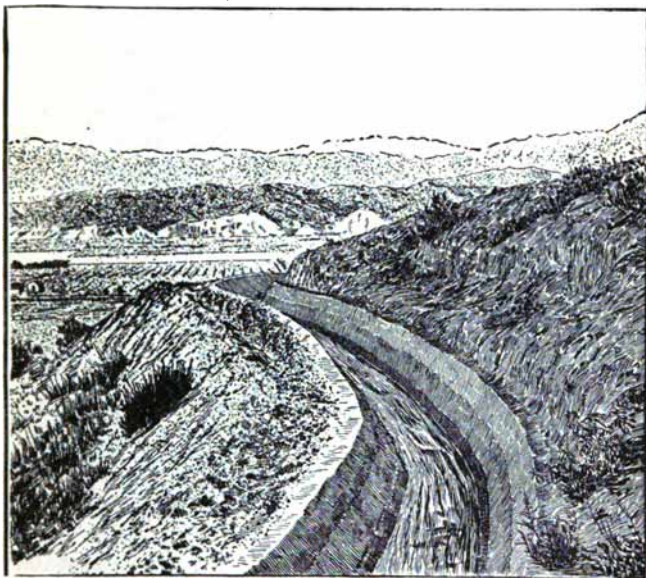

FIG. II—CANAL ON A HILLSIDE.

and oftentimes led to its entire destruction. The gate should be placed at a point convenient to discharge water back to the river through the waste and sand gates. The use of piling is necessary in soft ground, although some builders continue to put in mudsills and depend upon stone anchorage to keep the structure in place. The writer would advise wings to be put in on

each side of the gates, where there is no rock in place, and these wings should extend in either direction and especially on the lower side, if the surface of the land be flat for a distance of from fifty to one hundred feet.

We have often seen headworks left standing alone in the middle of a torrent of water after a heavy storm, and have noted that the damage of the washout might have been averted had wings of piling or masonry been put in. The superstructure should be built of heavy timber and provided with a windlass. It is a good plan for large canals to have the gates arranged in stalls, each working independent of the other. A gate of modern construction is shown in Fig. 12, the lower end in view with water passing through. It fortunately is anchored in rock walls and is not supposed to wash out, nor does it need the protection of wing pilings.

In Scott's Bluff county, Nebraska, the Nine Mile canal has its headgate 900 feet below the intake, which is at a seepage basin formed by damming up a channel in a river at the side of an island. The dam is located above the mouth of the canal, while the channel or basin is left open with the idea that the backwater from the river will flow in at the lower end of the island, and in this way there will be but little sand with which to contend. The plan has many features to recommend it, but it could be adopted only in the situations favorably located as to the island and with a moderate fall of the stream at the desired point.

**The Drop-Head.**—The later practice with many of the best engineers in locating the intake of canals is to provide the drop-head instead of the old-fashioned

diversion dam. This system was worked out on the theory that it is useless to undertake the expense of raising water above its natural level in order to divert it from the bed of the stream, for it is more simple to

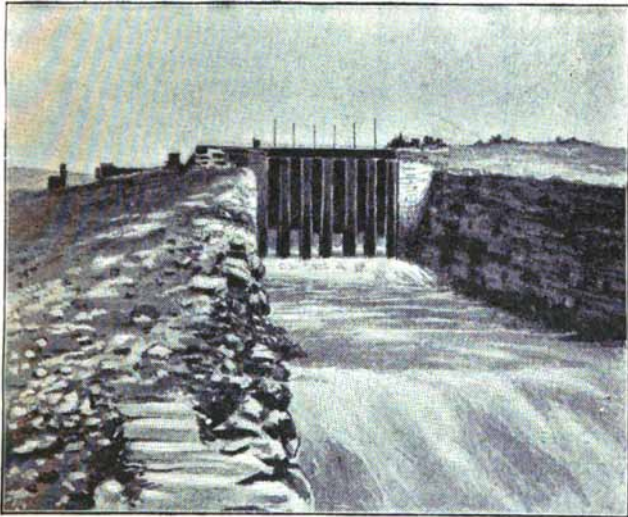

FIG. 12—HEADGATE OF A CANAL

have it flow out by its own gravity and volition. To do this a gallery is opened alongside and parallel with the stream, and the water is thus allowed to flow over and into it. This gallery is the real intake of the canal and is built of heavy planking with double floor, laid on mudsills set in concrete, so as to remain firm and fast. The river side of the gallery is faced with an apron, over which the water flows into the gallery, the floor of which is a foot or so lower than the bed of the



stream. The headgate is located a short distance lower down the canal, as in the case of bulkheads.

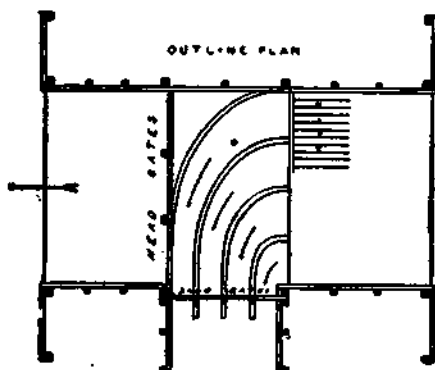

FIG. 13—TOP SECTIONAL VIEW OF LAND'S SAND GATE.

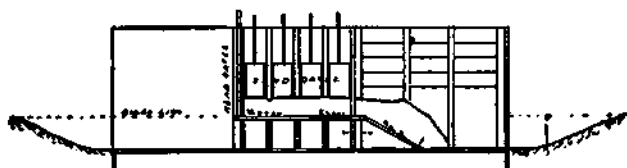

FIG. 14—SIDE VIEW OF SAND GATE.

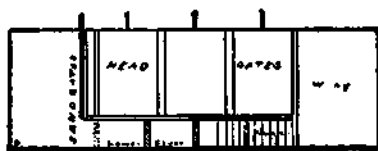

FIG. 15—FRONT VIEW OF SAND GATE.

**Sand Gates.**—Quite as essential as the main gate itself is the sand gate of a canal, by means of which silt, sand or detritus may be caught and drawn off

at the headworks without flowing into and filling up the bottom of the canal proper. Many devices have been invented in the hope of diverting sand from a ditch, and the best of these no doubt is Gordon Land's sand gate, sectional plans of which are presented in Figs. 13, 14, and 15.

**In the Land Invention**, the flume contains both the headgates occupying the full width, and the sand gates, which are on the lower side of the canal. There are two floors above the headgates, and the flume is set so that the upper floor is on the proper grade of the canal. Just at the flume and for a short distance above, the bottom of the canal is about two feet below the grade. The sand gates, which may vary in number, according to the width of the canal, are on the lower side, and each of these gates is connected with the canal by a separate channel until it reaches the side nearest to the discharge. These channels are curved and properly fitted. Each one of these forms a separate funnel, and the gates are kept constantly raised because, as in the case of nearly all canals, the natural stream under riparian rights is entitled to the flow of some of its full tide at least. The sand is pulled from the far side of the canal, which is the chief advantage. The planks forming the sand funnels are set edgewise and thus support the floor of the main watercourse above.

**Waste Gates.**—The safety-valve of a canal is its waste gate, and there are many styles in use. That which we will describe herewith is known as Nelson's automatic waste gate, and is described as follows, as well as shown by sectional drawing, Fig. 16.

The gate (1) is built of two-inch plank securely bolted to four gate standards  $2 \times 8$  inches and of length equal to the depth of the canal for which it may be designed, and as many gates, each three to four feet wide, may be placed in the principal frame, termed

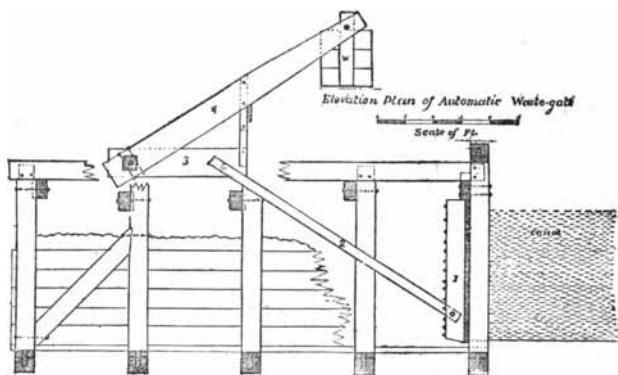

FIG. 16—AUTOMATIC WASTE GATE.

wasteway, as the magnitude of the anticipated flood water may require. The gate is hung on substantial hinges at the top to a horizontal beam  $4 \times 12$  inches, as shown in the figure. Near the bottom the gate is supported by two levers (2), which are four inches square, placed between the gate standard, through which a round bolt is placed, as shown in plan. Both gate standards and the ends of levers are lined with cast plates to prevent the bolts from being pressed into the wood, to allow the gate to move with the least possible friction. The opposite ends of the levers (2) join in a single lever (3), likewise with a bolt joint and cut plates. These levers (3) are connected with two levers

(4) by being placed upon the same axle, and also connected with a triangular brace (5).

At the end and between the top levers (4) is suspended upon an axle a weight box (W), in which is placed rocks or other heavy material to counterpoise the pressure of water in the canal, against the surface of the gate. When the water pressure becomes greater than the counterpoise by reason of increased depth of water in the canal, the gate swings open in an outward direction from the canal, and levers 3 and 4 are forced back till the weight box goes past the center or perpendicular over the main axle just enough so as to nearly counterbalance the weight of the gate and levers 1 and 2, so that the gate is floating loose on the surface of the freely escaping water with nothing to obstruct it, and no opportunity for drift or silt, to lodge. The gate is turned open to its full capacity and stands nearly at right angles to its position when shut. As soon as the flood has receded and the water in the canal has lowered to its normal stage, the gate lowers accordingly, when the weight is moved forward and receives its former power and closes the gate.

The forces acting through the system of levers as arranged, and holding the gate shut when the water in the canal is at normal height, or not exceeding the height to which the gate has been adjusted, are reduced in the same proportion as the water pressure against the gate is reduced when opened. Between each set of gates is placed a beam or cap lengthwise of the wasteway, supported on posts to which are fastened the boxings in which the main axle revolves. This axle is made from timber six inches square, banded at each end, and

also has a steel or iron rod one and one-fourth inches in diameter passing through the center, with ends projecting and resting in the boxing. The levers 3 and 4

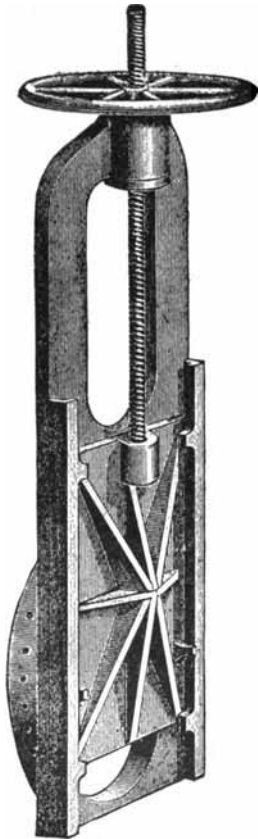

FIG. 17.

IRON OUTLET GATE.

are bolted to the main axle. Between levers 4 is placed and fastened with bolts a set of X braces to prevent the levers from becoming displaced by wind or other causes, thus making the structure firm and rigid.

**Ditch Outlets.**—The outlets or culverts through the canal banks to the main lateral should be set before the bank is built and with reference to the supply laterals. The size of the outlet will be governed by the amount of water to be delivered to the lateral. The outlets may be made of plank or vitrified sewer pipe, the latter being especially good but in most cases not so readily obtainable. The earth should be well tamped about the box or pipe in order to make a water-tight joint.

Regarding gates, these should be set at the inner end of the outlets, and a plank wall built from the top of the bank leading out over the water to a point over the gate, in order that the gate

may be lifted. In construction the gate is most simple, any carpenter or farmer being able to build one. A tight-fitting slide over the end of the box or pipe outlet is all that is necessary to shut off the water. The gate may be raised or lowered by a stick of 2 x 4 bolted to the front of the gate and leading up through slides or guide holes in the end of the walk. Simple means may be provided for fastening the gate either up or down. The pressure of the water against the gate will keep it in position and preserve a tight joint if the sliding surfaces have been properly dressed or surfaced. Grooves should be provided in the sliding supports so as to make sure that the gate will return to its seat when it is desired to lower it. Modifications of detail are many and will suggest themselves to any one as the conditions of the work or the setting may require. One of these is a cast-iron lift gate working in an iron frame with grooves, as seen in Fig. 17.

**Evaporation and Seepage.**—Evaporation is greatest during warm or windy weather, greater in shallow than in deep water, and greater in running than in still water. The evaporation of a canal during June, July, and August will rarely exceed three to four inches a day. During the remaining months the average will be about one inch, making for the year from three to five feet of loss by evaporation. To the loss in this must be added the loss by seepage or filtration either into the earth or through the banks. The amount of seepage through the banks will depend not only upon the character of the soil of which they are made, but also upon the solidity with which they are thrown up. So with seepage into the earth. If the soil is of soft loam,

sand, or gravel the percentage of loss will be greater than if the subsoil be of clay or hard-pan. Careful measurements made in a number of cases show that with canals having a good grade and not more than ten to fifteen miles in length, nearly fifty per cent. of the water diverted into them at the head is lost before the point of distribution is reached. The matter of filtration or seepage will be dwelt upon more fully later on in this work, as it bears upon irrigation systems other than that of canals.

**Cementing Canals.**—Seepage loss may be almost obviated by cementing the bottoms and sides of canals, and in very sandy or gravelly soils this measure becomes absolutely imperative. At first most of this work was done by lining the surface with stones, usually cobbles or small bowlders with faces roughly smoothed, and then plastering cement over them and filling all the interstices. This has been done with very many large canals in the southern part of California, and, as may be imagined, it is a very expensive process, especially when the canals are very long and remote from the sources of supply of the stone needed. In California, however, where some of the most expensive stone and cement lining has been done in the past, it has been found that just as good work can be done and effective results obtained without the use of stone and with only a thin crust of cement. The method followed is first to completely saturate the bottom and sides of the canal, which settles the earth thoroughly in place, and then the coating of Portland or hydraulic cement is put on with a thickness of three-quarters of an inch. It has been found that this layer is durable and abundantly

able to withstand all the strain that will be put upon it. The cement is mixed with clean sand in the proportion of one barrel of the former to four barrels of the latter. For a canal carrying 3,500 cubic inches of water, with a bottom 8 feet wide and sides 4 feet high, it requires 2,000 barrels of cement for 7 miles of length. The work of laying the cement is done very rapidly and thoroughly. Along the edge of the canal a small pipe is laid, through which a steam-pump forces the water which is used in keeping the earth wet and in mixing the mortar. At regular intervals are placed piles of sand and barrels of cement. A mixing-box on wheels with a trough running down into the canal is run on the top of the bank, and the plasterers take from this and cement the sides. This is moved along as fast as needed, thus saving the use of wheelbarrows. Following comes another mixing-box on wheels in the bottom of the canal, and from this the mortar is taken to cement the bottom. The work should be allowed to stand for a time so as to thoroughly dry before water is turned in.

**Building the Laterals.**—In constructing the supply laterals leading from the main canal to the farm, the walls should be built up so that the bottom of the lateral may be higher than the surface of the ground. This is vital to the economic use of water. The laterals can be constructed in the loose soil on the farm for the reason that the water is desired to soak into the ground. The laterals may be changed every time water is put on the land, for the reason that always as soon as possible after irrigating, the ground should be cultivated, thus obliterating the lateral and preventing the soil from



baking. There is nothing so good in the long run for building ditch laterals as the common plow and scraper. Make the ditch bottom as wide as the scraper even for the small laterals, if they are to be permanent. The first plowing should be at least three times as wide as the finished ditch, so the earth may be thoroughly broken up and no smooth or grass-covered surface left for the bank to rest upon. On a side-hill the plowing should extend well down the lower side. Under an extensive canal system a water consumer's land may lie a mile or two distant from the main ditch. In a case of this kind the laterals must be of a permanent character. This work may require as much skill and judgment as the construction of the canal itself, and should be well done. When the ditch is completed let a very little water in for the first few days and shut it off every afternoon. The high embankments will settle and are reasonably sure to crack, and the earth must then be tamped into the cracks. The ends of flumes will need tamping and puddling. The coarse gravel in the banks will leak like a sieve and will require many a shovelful of fine earth to fill up the interstices. In a few weeks, however, all will be settled in place.

In laying out a supply lateral leading from the main canal it is important to have it large enough to carry at least double the average amount of water it will contain. The water supply will vary greatly in a season, and it is a matter of much importance to be ready to use all the water available. In constructing such a watercourse it is a good plan to throw out four furrows with a sixteen-inch plow—two each way. Then throw out and deepen the lateral with a round-

pointed, long-handled steel miner's shovel. Such a ditch, three-quarters of a mile in length, was once plowed out in half a day, and four men shoveled it out in a day and a half. Gullies or intervening water-courses can be flumed with lumber, or, better still, dammed or diked with earth. In these instructions it is presumed that the main ditch has been built to a given elevation, so as to make the laterals available in conducting the water across the highest end or side of the field or farm, from which it can be best conducted onto the greatest area of the land. Do not depend upon the eye in determining the location of any permanent lateral. The surface of the land is very deceptive, and water will often seem to run up hill to the unobserver. Much depends upon the natural contour of the land in locating the laterals. On land with a fall of 18 inches to 100 feet laterals should be made each 60 feet apart, the water being passed from one lateral to the next, thus irrigating the intervening land between the laterals. These field laterals can be plowed out each season with a 14-inch lister or buster, and the process is described more fully later on in the chapter devoted to the methods of applying water.

## CHAPTER VII.

### RESERVOIRS AND PONDS.



THE fortunate irrigator who has a reservoir of his own has his water-supply constantly on tap—the reservoir may also appropriately be called the farmer's savings bank. An irrigation system depending upon storage, when the storage works are judiciously constructed, is the most reliable of all. The reservoirs can hold the waters of a wet year for use in a dry one, and in the possible sequence of several dry years the smaller stored supply gives several months' warning to irrigators, so that water can be husbanded and made to perform a larger duty than usual in order to tide over a period of scarcity.

The problem of water storage for irrigation is a very different one from that for the domestic supply of a city. In the first place, it is important that water for domestic use be as nearly as possible free from mud and organic impurities, while for irrigation such impurities are not only no objection to the water but often materially add to its value by enriching the soil to which it is applied. Waters held in reservoirs and intended for irrigation purposes are often rendered much warmer than the flowing waters of streams, and are therefore more beneficial to plant growth when drawn off and applied. The reservoirs must also be credited with having a salutary effect on the atmosphere of the arid

region, and countless numbers of them scattered here and there over the lands would greatly increase the humidity, and bring about a marked meteorological change for the better. In Western Kansas, for instance, a small fraction of the precipitation during the year would make a lake one-fourth of a mile square and five feet deep for every section of land. This could be utilized easily for irrigation.

A grand system of reservoirs in arid America would greatly reduce the dangers of floods and render immunity from the horrors of deluge that every year come to the settlers along the lower Mississippi. The ancients understood this principle, for, in order to remedy the inconvenience of the torrential period, when the country was flooded, and of the subsequent drouth for five months, the Romans covered their African provinces with a network of hydraulic structures. From the summit of the mountains to the sea all the rains that fell were seized upon, led here and there in channels, and distributed over the fields. In the smallest mountain ravines stone dams were built to retain water. In the valleys they arrested its progress down-stream. By this means the Romans prevented great floods descending the mountains at times of heavy rains, and retained a larger part of the precipitation in the higher reservoirs until such time as the water thus preserved was needed. At the entrance to each large valley was a system of works which assured not only the watering of that immediate region but conducted flowing streams through many channels, so that the surrounding earth could absorb what was required. At the entrance of each large stream on a

plain a dam was built, generally to retain the waters and prevent their sudden invasion of the plain before they were required.

**Location of Reservoirs.**—In the selection of reservoir sites regard must be had to several considerations—the area and character of land to be irrigated and its distance from the proposed reservoir ; the area of the watershed, the drainage from which is to fill it ; and both the maximum and minimum annual rainfall of the watershed. If the quantity and value of the land to be watered and the capacity of the reservoir are great as compared with the available water to be stored, it may be advisable to build a reservoir of sufficient capacity to contain much more than the minimum annual run-off, so that the discharge of wet years may be saved for use in time of drouth. If storage reservoirs are to be constructed, a great degree of engineering skill is required. The character of the construction of the dam will differ in every case with the nature of the foundation and the availability of structural material. Some of the greatest reservoir dams ever built have been constructed for purely irrigation purposes, and have required more skill in their design than have any built for city water-supply or other hydraulic uses. The basin selected must be such as will store the greatest amount of water with the greatest economy of construction. It is manifest that inasmuch as reservoirs cannot be excavated within reasonable conditions of cost, they must be natural basins. In many cases these will be existing lakes, and while many such will require dams at their outlets in order to regulate by gates the outflow of the water, there are

some which can be controlled by tapping below the level of the natural discharge. Such reservoirs will be most economical as outlets, only they will have to be constructed and guarded by bulkheads, and the natural evaporation surface will not be enlarged.

Reservoir sites may be divided into two great classes: Natural lakes or depressions, and reservoir sites on drainage lines. Such sites have two important advantages—the dams are not endangered by the enormous floods that are bound to occur on streams, and an opportunity is afforded for disposing of the rock and silt from the storm waters stored before they reach the reservoirs.

In the location of small individual ponds no great engineering skill is required, and the construction is at once a very simple and easy task, especially where only an earth excavation is required, on flat land or in a draw. If a place can be found from which the water will naturally run in several directions, all the better, because more land may then be reached at less cost. Where there is a good clay subsoil, not porous, and the soil above has in it considerable admixture of clay, a first-class reservoir may be constructed out of the soil.

In treating the construction of reservoirs we shall endeavor to take up the subjects separately, so that the reader may not be confounded as to instructions that may apply to a work of lesser importance than that intended. Large reservoirs are a menace too often to public safety and mark the danger-line in irrigating works, so that no serious mistake should be made in building them.

**Laying Out Reservoirs.**—As we have said before, reservoirs should be built on as high ground as possible. Never select a place for a reservoir where the bottom is more than four or five feet below the point of delivery, for all surplus water below this point does no good, and a dam must be built just so much stronger to hold this extra head. The pressure on the dam is no greater where the flowage is large than where it is small. It is the height of the column of water at the dam that must be figured on. High dams when not properly built are unsafe. Surface is the one thing most desirable in locating a reservoir. Get an idea of the size to be attained before the work is begun, and at the same time make a calculation as to the capacity of the proposed basin when completed.

The size having been determined, the staking out follows. If the reservoir is to cover a given area, the whole banks will be within the area, and the foot of the outer slope will bound the given area. If the area is to exclude the bank, the foot of the inner slope will bound the area. If the water is to cover a given area, then the high-water line as the point half-way down the bank therefrom will bound the given area, or the area may be bounded by the center line, either of the whole bank or of the top of the bank. These conditions do not of course obtain where the natural sides of a ravine or cañon are to form the greater portion of the reservoir's contour. Usually these considerations will not be of much importance, but in the case of joint ownership or of contracting for the construction they may be important, and should then be clearly understood and carefully specified.

**Construction.**—One of the first things to be done after the site is secured is to make provision to draw off the water. In building a large reservoir with an earth embankment, wooden boxes or cribs of timber (although sometimes employed) are not to be recommended for permanent use, as they soon decay, are very difficult to replace, are a source of weakness to the reservoir, and do not admit of easily inserting a gate which can be freely operated. Stone culverts laid in cement are more costly and substantial as a rule, but require a special gate, which may give trouble. Iron piping, of which there are several kinds in the market, is perhaps the most suitable, and by its use one can purchase the standard low-pressure water-valves such as are in use in city waterworks, that are guaranteed to give satisfaction. In laying the pipe care must be taken to provide a safe and continuous bearing beneath it, otherwise the load imposed by the earth above will cause portions to settle and so loosen the joints.

It is necessary, too, to dig one or more cross trenches from the pipe and pack them full of concrete, clay, or good earthen puddle, bringing the same up two or more feet above the pipe so as to arrest any leakage along the outlet pipe. The surface upon which embankments are to rest should be plowed and the roots of bushes and weeds removed to the outer toe of the slope, after which the ground is again plowed and a trench dug along the center of each proposed embankment. When this much is done water should be applied. The abundant use of water is of prime importance in all works of this nature. Allow



water to run into the trench until full, then begin to form the base of the embankments. As the contents of the scrapers, carts, or wagons are dumped on the fill, have them thoroughly sprinkled, using, if no sprinkling cart is handy, a large barrel or plank box with a piece of perforated pipe for a sprinkler, controlled by a flap valve faced with leather.

As the fill rises more water is turned into the trench, so that the whole base presents the appearance of two low, wide embankments, with a canal full of water between them. By building with water in the center practically the same results are secured as with a core of puddle clay, concrete, or masonry, without the serious disadvantage of a joint on each side of such a core, which often proves fatal to the structure. By the other way there are no distinct joints, since the water in the trench percolates quite a distance on each side, and then these half embankments are watered by sprinkler, and packed by the passage of teams into a mass nearly as compact as that done under water. Another suggestion to those inexperienced in such work may be made in relation to the sorting of the materials. In nearly every case in practice the contents of the bank of the pit differ, running from fine to coarse and from porous to impervious, and successful practice requires the placing of that which is the best adapted to retain water next to the edge of the water, or on the inner half, while the rocks, larger gravel and heavy substances in general are ranged from the outside toward the center on the outer half. It is the rule of practical builders of earthen embankments to make the width of the base line three times the height, and this kind of construc-

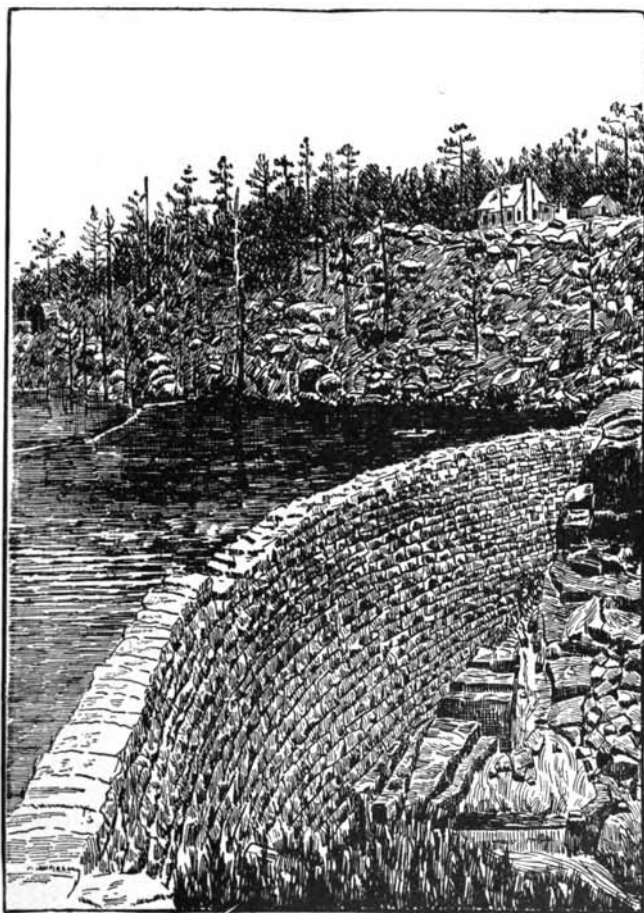

FIG. 18—BEAR VALLEY DAM.

tion, if properly put up, will stand any natural pressure that may come upon it from the impounded waters.

In storing water for irrigation it is advisable to make the slopes, particularly the inner one, more flat, and to protect them, where they are likely to be washed, by riprapping with rock, or slag, or lining with lumber. In works of lesser magnitude pebble-stones placed along the water-line will serve the purpose just as well.

**Masonry Work.**—In constructing a dam entirely of solid masonry no definite rules can be given, as the circumstances governing all cases will in no two instances be alike, and we can only give the method by which a substantial dam of this sort has been constructed. Let us take for example the Bear valley reservoir in Southern California. Into the solid rocks of a gorge the dam is abutted and is built in a curve arching inward, forming the arc of a circle, with a diameter of 335 feet, illustrated very graphically in Fig. 18. Its dimensions are, on the top, 300 feet from the abutments, 60 feet from the bed-rock of the creek in the highest point, and conforming to the mountain slope on either side. The foundation is 17 feet in width, running up to 3 feet on the top, which is covered with huge blocks for coping. The whole is built of vast granite blocks, which were quarried near the margin of the lake and floated to the wall on scows, while a derrick built on a raft placed them in position. The best quality of Portland cement was used for laying them, and all the interstices were filled with *beton*, which was thoroughly tamped into place, until the whole structure is one homogeneous mass. There are 3,304 yards of rock work, on which 1,300 barrels of

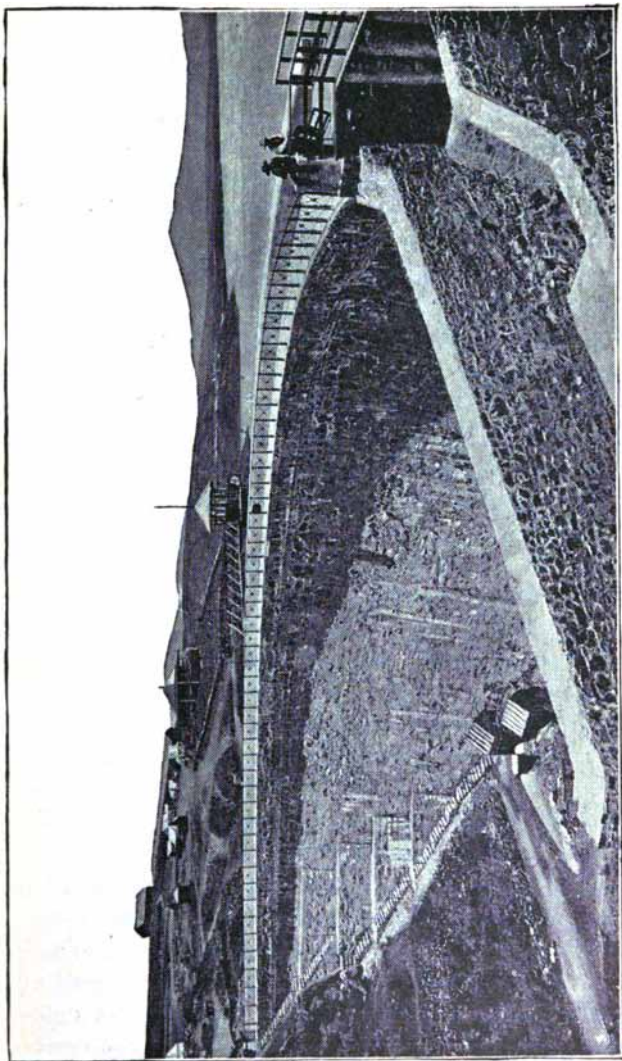

FIG. 19—SWEETWATER DAM.

cement have been used. The cement was the most expensive portion of the work. Beneath the dam is a stone culvert for the outlet. This is closed by a gate 21 x 24 inches, capable of discharging 8,000 inches of water, which runs into a weir, where the flow is measured in inches. This gate and weir control the flow of water. On one side of the dam a spillway over solid rock is provided for the overflow of the surplus water. This is some four feet lower than the crest of the dam and affords ample discharge for the superabundant water.

The Sweetwater dam, built across the mouth of a cañon a short distance above National City, California, and shown in the full-page photographic reproduction, Fig. 19, is one of the boldest pieces of engineering in the world. The dam is constructed as a crown arch, and is the largest of its character in the world. It is of solid granite and Portland cement, 46 feet thick at the base and 12 at the top. It is 90 feet high at bed-rock, 76 feet long at the base and 396 feet at the top. The reservoir covers 700 acres, and has the enormous storage capacity of six billions of gallons. The water is discharged from the reservoir by means of a main pipe 36 inches in diameter, and then by smaller pipes. Much of the land under this system is high and rolling, but the head is sufficient to carry the water to the highest portions. The dam gathers the rainfall from 186 square miles, and the capacity of the reservoir is sufficient to hold a two years' supply for 10,000 acres.

**Cost and Capacity.**—In calculating the cost of a reservoir it is necessary to fix the value of a defined volume of water for irrigation purposes. For conven-

ience take a volume of water of one million cubic feet. If this amount is applied without loss in transportation, as through pipes, it will irrigate on an average twenty acres of land for one season when used very carefully. Assuming one-half of this area to allow for unavoidable loss by absorption, evaporation, and the loss by the ordinary practice of irrigation, the area value of one million cubic feet of water will be considered as ten acres. On this basis of ten acres for one million cubic feet, the cost of a reservoir built entirely on the surface of nearly level ground from excavation made within the area enclosed, without borrowing or wasting material, has been calculated. The price assumed for earthwork is twenty cents a cubic yard, which for banks 20 feet high, with a long haul, is a fair price. The size calculated is 1,283 feet by 641.05 feet, holding 23,500,000 cubic feet of water. The cost is \$37,617, which at 7 per cent. per annum interest would be equal to an annual charge of \$2,633, or \$112.21 for a million cubic feet, without any allowance for maintenance. This, at the area value of ten acres for a million cubic feet, would irrigate 235 acres at a cost of \$11.22 an acre, which represents the total cost for all time to come.

At some sites it might be necessary to pump water, and under the conditions likely to be met in practice, where the work will be done in isolated localities and confined to 90 or 120 days' work in the year, while the interest on the cost of the plant will have to be charged for a whole year, the cost will average about fifteen cents a million cubic feet to the foot raised, or about \$15 to raise that amount of water 100 feet. This esti-

mate is made on the basis of coal costing \$5 a ton, and an average engine of 50-horse power. If the water is pumped during the whole year the cost will be reduced to two-thirds of this amount. With a depression having natural sides in place, and where not more than one-fourth of the circumference would have to be constructed, the cost would be proportionately less.

**Damming a Stream.**—The chief cause of failure in dams of all kinds is the faulty construction of the foundation. Dams should be made of timber or stone. For a safe and simple form of timber dam the foundation should be rock or a hard-pan of gravel, and the mudsills on the lower tier should be bedded in broken rock, pounded down firmly with a fifteen-pound sledge. The sills are saddled, and the cross-ties laid upon them are notched to rest upon the saddles, and two-inch pins should be put through both of the logs. Where the foundation is shelving rock, one-and-a-half inch iron pins should be put down into the rock at least a foot, to prevent sliding. But the sliding force is almost neutralized in this form of dam by the weight of water which lies upon the sheeting.

The tiers of timber are built up, saddled, and notched. A plank sheeting is put down to the solid foundation above the first sill, and the end is spiked with eightpenny spikes firmly. The sheeting is filled to the foundation as close as possible, and hydraulic cement concrete is bedded in front of it to make a tight joint. No leaks will ever trouble a dam founded in this way. The rafters should be strong enough to bear any weight of water which the stream may carry doubled. If the highest flood known is five or ten

feet above the usual level, it is easy to estimate the strength of the rafters required and then double the number of them, putting them no more than two feet apart if the sheeting is of one-inch board doubled. An apron should be put on the dam to receive the overflow.

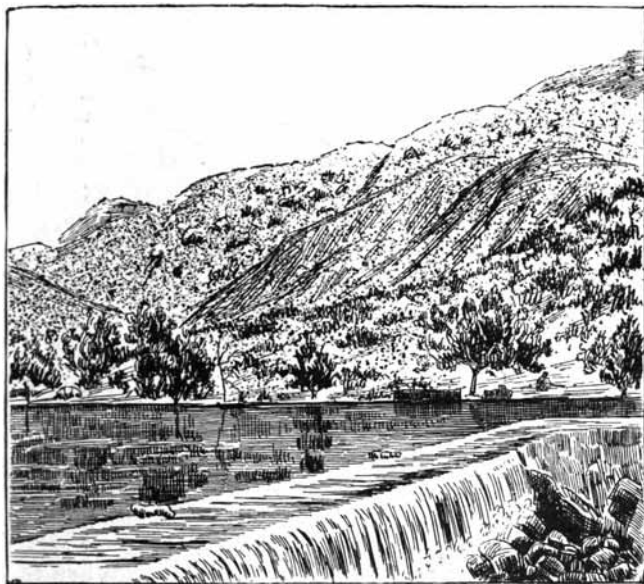

FIG. 20—DIVERTING DAM.

A masonry dam should be built on a foundation of concrete, laid on solid rock over piles driven close together, and both sides protected by sheet piling. The piles should be left to protrude into the concrete foundation. Except for waterworks, or an irrigation conduit, there should be no outlet in the bottom of the



dam ; but the work should be of the most solid character. A waste channel for overflow should be made on the top large enough to carry off any possible flood, and the ends of the dam should be carried up with solid masonry as high as may ever be needed to prevent the cutting out of the ends by floods. A large dam should be constructed, regardless of expense, to secure safety in every direction, and the small details of construction are very often the most important parts of the work.

**Storage Ponds.**—These are classified as those artificial embankments that are made on the flat surface of the ground, and are used mostly in connection with a pumping plant. In staking out, it will be best for the convenience of graders to drive stakes on the outer and inner base-lines of the proposed bank. If the land on which the reservoir is to be built be of fresh sod it will be necessary to plow up or remove all of the sod from the ground on which the embankments are to be constructed, otherwise there would remain a seam through which the water would escape from the reservoir, as sod is not a suitable material upon which to build embankments, nor should it be used when building them up to their required heights. When the outlines of the embankments are established and the sod removed, then plow within lines of the proposed embankments, and with a scraper draw the earth from the inside of the reservoir, with which to form the walls. These should be not less than five feet in height, measuring on the outside, and very wide or thick at the ground level. The walls should be so carried up that the slope from the inside will be very

gradual, not abrupt, for the reason that if the walls are nearly perpendicular wind waves will destroy them, hence the advantage of making the walls very sloping from the inside. The outer walls may be made more perpendicular, because there is no influence from the outside to injure them.

Having built the walls by using the earth from the inside of the reservoir, and with everything ready for puddling the earth to hold water, the first thing in order is to plow all of the land over the whole bottom surface of the reservoir four or five inches deep, then with a harrow or drag, or other suitable implement, reduce the earth to a very fine pulverization, and after this shall have been thoroughly done the next thing is to puddle. Turn the water into the reservoir and begin to puddle at one edge, puddling carefully along this edge until the earth shall have been reduced to mortar, and continue to work toward the other side until the entire bottom of the pond is completed as far up the embankment as can be worked to good advantage. It may often happen that puddling is out of the question owing to the porous condition of the bottom. If the soil is sandy haul into the basin several loads of any kind of clay obtainable and mix this thoroughly with the earth. Fresh manure, or even sawdust, may often be employed to just as good advantage. Very often it is only necessary to run muddy water into it and allow the sediment to find its way into the loose sand. Of course the more clay that is carried in the muddy water the more effectual will be the puddling. This method has proven successful in a very leaky lake which was excavated in an

old creek bottom and almost entirely in coarse loose sand.

In constructing these surface storage basins the dimensions are best when fifty by one hundred feet, or one hundred by two hundred feet, etc., rather than of square form. A pond that is fifty by one hundred feet and containing five feet of water will irrigate twenty-five acres, and the whole plant, including a first-class wind engine, should not cost over \$250. It is a good rule to have the pond of such size that it would not be necessary to empty it oftener than once or twice a week. That would make the supply of water at hand the main factor in determining the size of the pond. It might readily be figured out in this way: One gallon contains 231 cubic inches. A space 23.1 inches high, covering ten square inches, equals one gallon, and one square foot, or 144 square inches, 14.4 gallons. Now divide the number of gallons which can be pumped in three days' steady wind by 14.4, and the result will be the number of square feet necessary for the bottom of a pond two feet deep, and one-half that number will be sufficient for one four feet deep.

**Cementing.**—To make a pond perfectly impervious for all time and give the best satisfaction in the end, line it with paving pitch or Portland cement. If the latter, the preparation can be applied the same as described in the preceding chapter on canal construction. The best coating for such work is a composition of hot clean sand mixed with hot paving pitch, to which has been added a percentage of crude oil residuum, and the whole mixture applied hot, say at

about 300 degrees, and spread much in the same way as the asphalt coating is applied upon streets. This mixture could be used while hot as a mortar and spread with a trowel or with a flat shovel. If spread smoothly and evenly while hot, and with as much pressure as possible to make it compact, it would soon set and form a coating that would give more or less with the settling of the ground, that would be absolutely water-tight and that would not deteriorate under the changes of temperature. The paving mixture itself comes in barrels of some 550 pounds and could be furnished at \$25 a ton. The sand, free from any loam, could always be secured at or very near the pond, and the whole mixed at the job and applied as fast as mixed. It would be safe to estimate that the paving pitch for this kind of work would not exceed three cents a square foot should the entire coating run an inch thick when laid. Treated in this way a pond will not leak, and the only loss of water will be from evaporation, which varies from 50 to 100 inches annually. This loss reduces the amount for irrigation or other purposes that can be depended upon by about 30 per cent. The more humid the section the less the loss.

**Gates and Spillways.**—In all large reservoirs it is necessary to provide a conduit or culvert to convey the water to the supply ditch leading from the reservoir. This may be built of masonry work the proper size to carry the amount of water the ditch will accommodate, and should be laid up with water lime or cement. As we have said, this should be built the first thing before the walls of the reservoir are commenced.

The gate should always be put on the inside end. A very simple and easy gate to operate, say up to eight or nine feet surface, is what is called the paddle gate. The end of the sluice that the gate goes on should be made as follows: Extend the bottom into the pond eight or ten inches, pull the top back so the sides will describe an angle of fifty-five degrees to the bottom line, make the face straight and smooth, put two pieces of 3 x 6 timber on top of the wall and let them run back under the dirt work. Cut the paddle or gate about two inches larger than the aperture. Bolt two cleats near the ends and let them extend four inches above. Then bolt on a handle or lever in the center three by four inches, and eight feet long; bolt a roller crosswise to the cleats and handle close down to the top of the gate, and make some convex boxes in the timbers on top of the wall to receive them. Put some strap iron over these gudgeons so the water will not lift the gate out of place. Put a pulley in the top end of the handle and set a post on the top of the embankment. Fasten one end of the rope to the post and pass it through the pulley and back to the post. The action of the water will always close the gate, and to open it take hold of the loose end of the rope, and pull back and snub it to the post.

If the reservoir is so situated that it will catch any amount of surface or storm water it must be provided with an ample spillway large enough to take off the surplus water, so that in no emergency can the water rise over the crest of the dam; and the spillway must be provided with large and ample aprons, so the momentum of the water pouring over the spillway will

not cut out the bottom below the dam and undermine it. More dams are lost from the action of the water on the lower side than on the upper side.

The first step to be taken in building storm reservoirs is to build a substantial wasteway. This should be built of timber bents boarded up with two-inch plank. Make a water-tight bottom under the wasteway. This can be done either with lumber or brush. If made of brush, cut willows and tie them in bundles six or eight inches in diameter; the length of the whips should be ten or twelve feet. Tie two bands around them three or four feet apart. Commence with the brush at least thirty feet below the center line of the dam and lay the bundles butt end down-stream, close together in tiers at least six feet wider than the wasteway. Then commence with another tier, putting them back three feet up-stream, and so on, until they reach into the reservoir fifteen or twenty feet above the center line. Put onto the brush a light coat of gravel so as to fill up all the cracks, and then erect the bentwork on this bottom. Plank up the sides with two-inch plank and fill in between the sides of the bentwork level with gravel, and put plenty of gravel on that part of brush above the bentwork.

**A Hydraulic Embankment.**—A novelty in the way of reservoir construction is that of the great dam built by a local water company at Santa Fé, New Mexico. By means of a gigantic hydraulic plant, the sides of a cañon were torn down and the detached material thus obtained was carried through a fourteen-inch main and deposited on the embankment under a pressure of 140 pounds to the square inch. The action

of the water both cemented and puddled it there. Immediately above the site the banks of the stream separate so as to include a reservoir of a somewhat oval shape 1,600 feet long and 500 feet in average width, and of an average depth of 30 feet. As shown by the cross-section in Fig. 21, the dam is 85 feet in high at the middle of the stream and is 300 feet wide at the bottom. Its entire length is over 1,000 feet. Its careful construction and the precautions taken to render the dam impervious to water are shown by the cross-section.



FIG. 21—CROSS-SECTION OF HYDRAULIC RESERVOIR.

Under the upper half of the dam the excavation is made to bed-rock; parallel strips of bed-rock surface are broken fresh, and concrete ribs built thereon parallel with the center of the dam. In these concrete ribs, in the composition of which the very best hydraulic cement is used, triple sheet piling is embedded and carried up into the puddle. The entire upper half of the dam was puddled and spread in thin layers, and each day a herd of goats was driven onto the bank and kept moving the entire time. There is three feet thickness of quarry-broken riprap on the upper side to protect the dam from action of the waves. Where the creek channel passes under the dam a semi-circular arch rests on bed-rock to carry off any sudden

rise which might have occurred during construction, and also to provide room for the pipes to the basin below. This arch is built solid, full of concrete near the upper end, at the same time walling in the pipes. From the opening to the arch and extending upward there is a well for the purpose of taking the supply at any desired level, thus relieving any strain at the conduit, and serving also as a manhole.

**Silting of Reservoirs.**—One of the most common drawbacks to water storage in large reservoirs is the constantly accumulating mass of sand and silt settling at the bottom, and modern science is as yet deficient in completely eradicating the trouble. It has been proposed to sluice out such material by providing large openings from the reservoir and occasionally allowing a great volume of water to rush out and carry the collected material with it. This method has been successfully employed in diverting dams for keeping open the approaches to the headgates of canals. It is also extensively employed in cleansing reservoirs in Spain. Experience has shown, however, that only a comparatively small area is cleaned by this method, reaching on a steep grade for only a moderate distance above the scouring sluices. For clearing a reservoir several miles long it is manifestly inadequate and must be supplemented by something else. Another method of counteracting the tendency of the reservoir to fill is by enlarging its capacity. This method is not always possible. Where feasible it is always expensive, and so far from being a solution of the problem, merely postpones the date when some means must be adopted for cleaning out the impounded silt. It may, however,



in some cases be advisable, where the expense is not too great, to raise the dam higher and thus increase the velocity of the water used in sluicing out the silt. This will increase the efficiency of that means of cleansing the reservoir.

The removal of the accumulated débris by the ordinary methods of excavation is clearly out of the question. No community in the world can afford to pay for an acre-foot of storage capacity for the purpose of irrigation any sum approaching the cost of an acre-foot of excavation by ordinary methods. A plan is suggested, however, which might be applied, and when properly adapted to the topography and hydrography of the locality would be effective at reasonable expense: A small water supply is to be obtained at considerable head over the reservoir site, either by diverting the stream at a distance above the reservoir or by storing waters in a small reservoir on the stream or some of its tributaries and carrying them in pipes or flumes above the upper edge of the reservoir to the vicinity of the dam. At points along the side of the reservoir which are topographically favorable, preferably upon ridges jutting out into the lake, hydraulic giants are to be provided to act under the head of water furnished by the pipe-line. Large sluiceways are to be provided near the dam, and at such times as the reservoir happens to be empty these sluiceways are to be opened to their full capacity and the deposited material hydraulicked out, as in hydraulic mining. The material, being mostly fine and freshly deposited, would wash easily and rapidly and be carried by the stream out of the reservoir through the sluice-gates. This water need not be

wasted, but could be diverted below for purposes of irrigation.

Such works and methods would, of course, be expensive, but on the other hand their effectiveness is unquestionable and it is believed to be by far the most feasible method yet proposed for cleaning a large reservoir. The tendency of an economical use of this method would be to keep the reservoir open in its lower part, where it is deepest, and allow the shallow portions along the edges and at the upper end to remain filled. This would contract the relative area of water surface and diminish evaporation, which would in a measure compensate for the destruction of storage capacity. The use of the three methods—first, the employment of one or more large scouring sluices; second, the enlargement of the reservoir to the practicable limit; and, third, the construction of works and the adoption of hydraulic operations—would in many cases insure the perpetuity of great storage reservoirs in this country within practicable limits of expense. Certain it is that some efficient method or methods for this purpose must be employed. Where feasible, storage reservoirs can be constructed in side cañons or other basins having no considerable natural drainage tributary to them, the water being carried through artificial conduits from the streams, the waters of which it is desired to store. Where this can be done the danger of filling the reservoir with silt can be easily averted. Sand boxes can be constructed along the supply ditch and be easily operated in such manner as to effectually clear the waters of the load of solid matter. Inasmuch as the surplus waters are discharged

in sudden floods of enormous volume, and in order to impound them or any considerable percentage of them by this method, not only must strong diversion works be provided for diverting them, but a conduit must be constructed of enormous capacity. Modern sand gates and silters are described in the foregoing chapter.

## CHAPTER VIII.

### PIPES FOR IRRIGATION PURPOSES.

**P**EOPLE who have plenty of money and little water will find that the employment of pipes will enable them to use whatever water they have to the best advantage. The use of pipe-lines for conveying water, in the place of ditches or flumes, has increased much since the introduction of certain cheaper forms of pipe. In the west pipes of wood banded with iron are extensively used, as are also pipes of spiral, riveted, or welded iron or steel. The latter combine great strength with lightness and economy. Where waters can be forced under heavy pressure the use of surface pipe-lines of light pipe will find a broad field of usefulness and should receive such consideration as its merits deserve, especially where the work of constructing ditches or flumes is of any special magnitude. A large pipe-line is intended to take the place of a main ditch or flume and not of the distributing laterals. The advantage of a pipe-line over a ditch lies in the fact that the water supply is not reduced by seepage or evaporation, and the duty of a reservoir is thereby increased. The area of surface occupied by the pipe-line is not nearly so great as the space occupied by the ditch and embankments, and thus the area subject to cultivation is increased. The cost of maintenance is less, for a pipe-line will need but

little attention, whereas ditches, however well they may be made, will require an annual overhauling. The advantage over a flume lies in the fact that evaporation and leakage are done away with. It is here assumed that a pipe connects with a well or fountainhead, as otherwise there could be no pressure upon the pipe and it would stand in relation to delivery on a plane with the ditch or flume. If the line is accommodated to the surface and there is any inverted or downward bend in the pipe, there should be a valve set at the lowest point to provide for the emptying or draining of the pipe during cold weather, or for repairs. The pipe may be laid on or near the surface on low supports of such form and material as circumstances may suggest. The matter of grade is of little importance, for the water being forced will run up hill as well as down, and a pipe may be laid to the natural grade of the surface and deliver water on a level with the fountainhead.

**Pressure of Pipes.**—For the purpose of considering the pressure we will divide the classes of pipes into three kinds: low-pressure pipes, medium-pressure pipes and high-pressure pipes. By low-pressure pipes we mean those which are not required to withstand any greater pressure than that occasioned by the gravity flow of water through them, with the addition of a few feet if necessary. We will designate as medium-pressure pipes those which are able to withstand a pressure of fifty pounds to the square inch with safety, and as high-pressure pipes those which can safely resist a pressure of 120 pounds to the square inch. Pipes made of riveted sheet iron or steel No. 16,

vitri-fied clay or cement, are classified as low-pressure pipes; those made of riveted sheet iron or steel No. 14, or of wooden staves banded with wrought iron, are classified as medium-pressure pipes; and those made of sheet iron or steel No. 12, or of cast iron, are classified as high-pressure pipes. While these classifications correctly separate the different kinds of pipe into classes on the basis of their ability to resist pressure, still there is also a difference between the various kinds of pipe belonging to each class. In low-pressure pipes sheet-iron or steel is the strongest, vitri-fied clay the next strongest, and cement the weakest. In medium-pressure pipes sheet-iron or steel is the stronger and wooden pipe the weaker, while in high-pressure pipes cast-iron is stronger than sheet-iron or steel pipe. The judgment or skill of the person in charge must always be exercised in choosing a pipe suitable for each case, as no inflexible rule can be laid down which does not vary with the conditions met.

**Grades of Iron Pipe.**—There is virtually no difference in the prices of iron and steel piping. Wrought iron is more rigid, making a pipe less likely to become dented or flattened by external pressure, and more porous, which allows the particles of asphalt coating both to enter and become assimilated, as it were, with the iron; on the other hand, it is less strong to resist an internal pressure, and is likely to scale while being bent, which may prevent a perfect coating. The greater strength of steel can seldom be utilized except under high pressures, on account of its liability to collapse, but its smooth surface without scales or other defects is an advantage. As toughness

and malleability are more to be desired than great tensile strength, it is customary to specify that the plates in either iron or steel shall be annealed; in other words, heated to a cherry red in a close oven and then slowly cooled, or what is better, cooled in lime or oil.

In this country riveted pipes come in sheets three to three and one-half feet in width and of various lengths. These sheets after being sized and punched

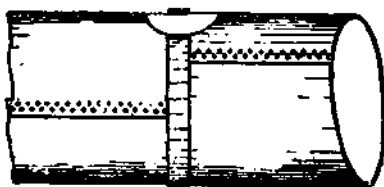

FIG. 22—RIVETED IRON PIPE.

in multiple punching-machines are bent around rollers to the required size, taking care that the grain of the iron or steel shall lie around the pipe. These short cylinders are then double-riveted along the straight seam, using a good quality of Swedish or Norway iron. By means of traveling cranes and numerous supports seven or eight of the short lengths are afterward continuously riveted, making a section of completed pipe of from twenty to twenty-five feet long. A section of this pipe may be seen in Fig. 22.

Only one row of rivets is inserted in the end or round seams, and the joint is made by expanding one end by means of specially devised machinery, by accomplishing the same object in riveting, or by making an equal number of large and small cylinders so that the end of the smaller can be driven into the end of the larger and riveted.

Spiral iron pipe, shown in Fig. 23, is made in much

the same way, and some advantages are claimed for it by manufacturers.

**Laminated Iron Pipe.** In California twenty years ago the irrigators used plain sheet-iron pipes, which soon corroded so badly that they were worn-out completely and had to be taken up. The life of a sheet-iron pipe depends on its coating, and without some protection against oxidation the shell of the pipe will soon be consumed by rust. Wrought-iron laminated asphalted pipes are made of two shells of sheet iron. These shells are made of one sheet of iron eight

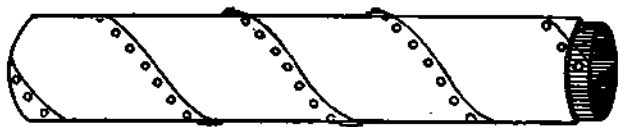

FIG. 23—SPIRAL IRON PIPE.

feet long, rolled and lapped one inch, and united by a composition solder. They are half the thickness of iron that would be necessary for the ordinary sheet-iron pipe. The inner shell is telescoped into the outer shell while immersed in hot asphalt especially prepared, giving a thickness between the sheets one-sixteenth of an inch or more if desired, thus making an impassable barrier to corrosion from outside or inside. The outside and inside coatings are also substantial. This produces a solid shell eight feet long with an inner surface free from all excrescences. The pipe is also made double, of one sheet, by rolling a sheet that is twice the width of the single sheet until the edges will lap with a thickness of iron between them. The



lap is riveted. This is dipped in asphalt, but it cannot have the intermediate lamina of asphalt, which is the main advantage of the laminated over the single sheet-iron pipe. Both these descriptions of pipes are jointed end to end, an inner sleeve being fixed in the shop. In laying, the end is dipped in hot asphalt and an outer sleeve is also dipped and pressed on by a clamp over the joint until the asphalt is set. Bends and branches are of cast iron, as in the ordinary sheet-iron pipe, and the joints are made with cement.

**Steel Pipe.**—Owing to freight charges cast-iron pipe is practically barred in the western countries, and the steel pipe is fast superseding it as well as all forms of iron pipe. The present price of steel is rather less than that of iron, and since steel suitable for this class of work is twenty per cent stronger than the best wrought-iron there is no good reason why this large saving in cost should not be made. The claim that wet soil corrodes steel more rapidly than it does iron does not seem to be substantiated by experience. Since there are so many grades of steel and there is so great variety in the methods of production, it is necessary in order to secure a uniform suitable product that the specifications be unusually specific and stringent, that the material be inspected at the mills, and that the appropriate tests be made in order to obtain the desired grade. Steel pipe is made up substantially in the same way as described under foregoing headings.

**Vitrified Clay Pipe.**—The materials employed and the mode of manufacturing clay pipe do not differ essentially from those of pressed brick. Suitable clay mixed with loam is first ground dry, then moistened

and toughened, in which state it is placed by machinery into the pipe molds and subjected to a pressure of at least 350 pounds to the square inch. After being pressed the lengths are allowed a week or longer to dry, when they are removed to the kiln, stacked vertically with the spigot ends down, kiln-burned for four or more days, and, when properly burned, very gradually and slowly cooled. The glassy coating which modern clay pipes possess is due to the sprinkling of salt over the heated pipe in the kiln at the close of the burning. Owing to the application of common salt and to the high temperature used in burning, common clay pipe is now termed salt-glazed vitrified pipe. Fig. 24 shows a joint of vitrified pipe. In laying this kind of pipe the joints are fitted in the collars, and these are made to rest on solid ground or are placed upon blocks of stone or wood. The lengths are usually two feet and the pipe is calculated to stand the pressure of a dray team with heavy load passing over it. A common sort of clay or cement pipe is made the same as the vitrified, but is not glazed and is not so lasting. To make this pipe porous, sawdust is mixed with the clay and is burned out during the baking process.

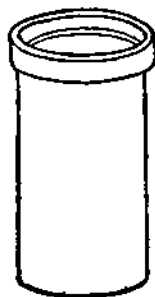

FIG. 24.  
VITRIFIED PIPE.

The matters which principally require attention in vitrified and cement pipes are leaks at joints, removing roots from the inside of pipes, replacing cracked pipes and doing the necessary earthwork, with the addition of replacing worn-out pipes in the case of the latter.

The cement pipes being softer and more porous than the vitrified are more subject to these troubles, and consequently their cost of maintenance is much greater. An average cement pipe will last not to exceed eight years, but the vitrified kind will last a lifetime, and is certainly much cheaper in the end.

**The Asbestine System.**—This is a method of piping devised by a California man named E. M. Hamilton, and is used exclusively in sub-irrigation.

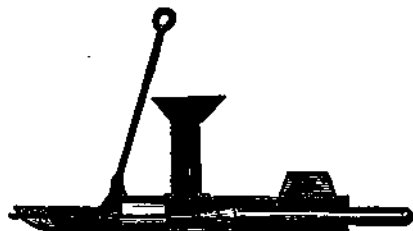

FIG. 25—ASBESTINE PIPE MACHINE.

It consists of a continuous pipe made of a combination of Portland cement, lime, sand and gravel, laid at a depth of two feet or so below the surface of the ground, parallel to

the rows of trees or vines in an orchard or vineyard. In these pipes on the upper side is inserted a nipple opposite each tree or vine, one-eighth of an inch or so in diameter, through which the water finds exit. Each plug is surrounded by a length of larger stand-pipe setting loosely on top of the distributing pipe, open at the bottom and reaching to the surface of the ground, for the purpose of keeping the dirt away from the outlet and rendering it accessible at all times for inspection. The pipes are connected with mains leading from a reservoir. The water finds its way through all the outlets, filling the stand-pipes and slowly percolating to the roots of the plants. The

trenches for this system should be dug two feet deep and sixteen inches wide, and the pipe itself is laid by a patented machine shown in Fig. 25, which also illustrates the manner of laying.

The material used is Portland cement, dry-slaked lime free from lumps, and perfectly clean sand. The proportion is seven parts sand, one part cement, and one part lime. One barrel of cement and one of lime with a proportionate amount of sand will make 350 feet of two-inch pipe. The stuff is mixed as the work progresses and is put into the hopper of the machine

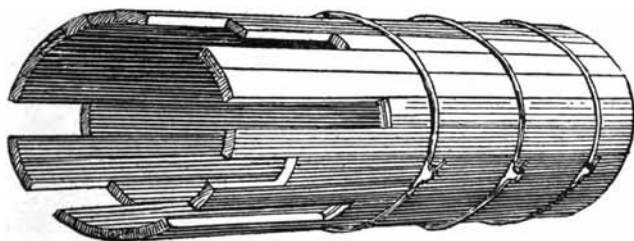

FIG. 26—SIDE VIEW OF STAVE PIPE.

by the shovelful. The operator works the lever forward and back, and as he does so the whole machine moves along a notch at a time, and leaves the completed string of pipe in its wake.

**Wooden Stave Pipes.**—For low pressures and large diameters wooden stave pipe is to be recommended. It supplies a long-felt want between the grade pipes such as vitrified clay and cement, and the pressure pipes such as riveted steel or wrought iron. Sectional views are given in Figs. 26 and 27.

The walls of the pipe are formed of longitudinal staves braced together with iron or steel bands. These are shaped to cylindrical forms and on the edges to true radial lines, so that when put together they form a perfectly cylindrical pipe. The flat edges of the

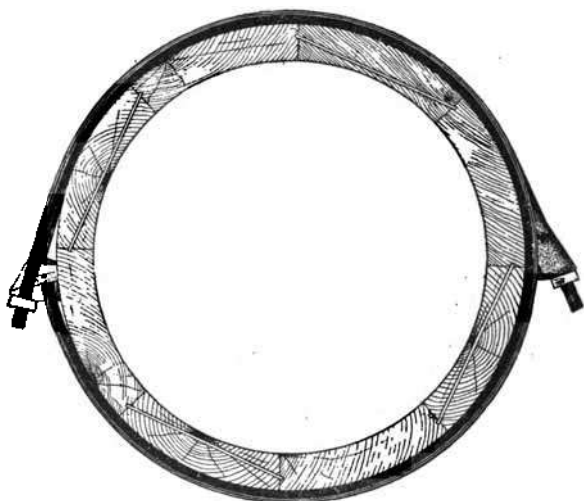

FIG. 27—CROSS-SECTION OF STAVE PIPE.

staves are essential to enable the empty pipe to resist the pressure from the overlying earth. To join the ends of the staves a thin metallic tongue is inserted, which being a trifle longer than the width of the stave, cuts into the adjoining ones. This joint is very tight and easy to make. The confining bands are of round or flat iron, or steel, of from three-eighths to three-fourths inches in diameter. As shipped from the fac-

tory they are straight and provided on one end with a square head and on the other with a thread and nut. They are bent on the ground on a bending table and coated with mineral paint, or asphalt varnish, and are

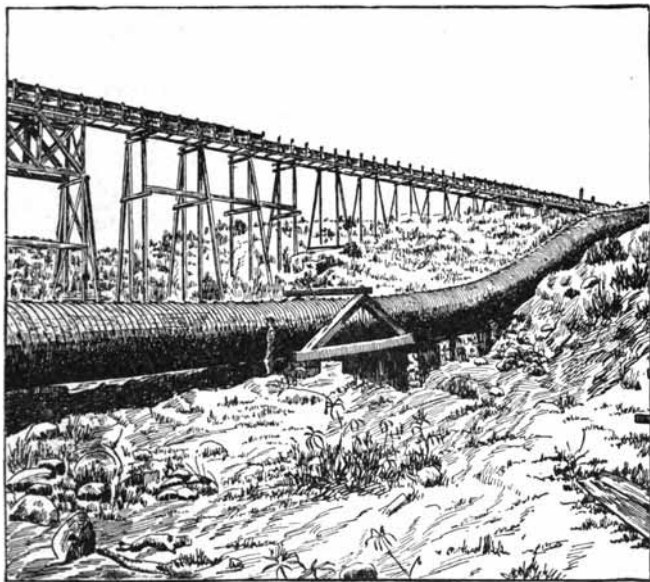

FIG. 28—STAVE PIPE-LINE IN POSITION.

cut about six inches longer than the outside circumference of the pipe, on which they are slipped loose. The ends are joined by means of a closed iron screw, which fits close upon the pipe and provides a shoulder for the head and nut. These bands are placed at varying distances apart, according to pressure which the pipe is required to bear. The staves break joints

so as to form a continuous pipe, which leaves no obstruction to the flow of water. The beauty of this system is that it is made on the ground, and the workmen do not have to be especially experienced.

It is always economy to purchase the staves already dressed, and thereby save in freight charges. In contracting for such materials, the specifications should call for sound, well-seasoned, close and straight grained lumber, free from all knots, worm-holes, season checks, sap-wood, splints, or other like defects, and cut from live trees. In piping, ranging in diameter from eighteen inches to three or four feet, the staves are usually prepared from carefully selected 2 x 6 joists, and this joist when dressed will make a staff about five and five-eighths inches along its outer arc, and about one and nine-sixteenths inches thick.

In laying the pipe the trench is usually excavated at least eighteen inches wider than the outer diameter of the pipe, to provide standing room for the workmen ; the number of staves needed to form the pipe are placed in piles along the trench and a foreman with five workmen form a gang. The tools used by a gang are a twelve-pound sledge, an oak driver banded on one end, four two-pound hammers, two chisels, four crank wrenches, two inside forms of coiled gas-pipe, and two outside U-shaped forms of the same material. A completed line of staff pipe with an abandoned flume just above it is pictured in Fig. 28. In this instance the pipe was laid above ground, as can just as well be done in countries where the winters are mild. The capacity of a thirty-inch staff pipe is computed on thirty inches diameter as follows :

<i>Grade or fall in feet per 1,000 ft.</i>	<i>Discharge in gallons per 24 hours</i>	<i>Grade or fall in feet per 1,000 ft.</i>	<i>Discharge in gallons per 24 hours</i>
0.10	3,380,000	8.0	19,900,000
0.15	4,160,000	5.0	25,700,000
0.20	6,120,000	8.0	32,500,000
0.50	8,030,000	10.0	38,900,000
0.80	10,200,000	15.0	46,000,000
1.0	11,400,000	20.0	51,400,000

Since the conception of this book the author has learned of an entirely new material for the construction of water-pipes, which is manufactured in Los Angeles, California. The materials are wood fiber paper and asphalt. The paper is reeled off while passing through melted asphalt at a temperature of over 400 degrees, wound around a cylinder and subjected to great pressure, making it very hard. It is constructed in sections of seven feet. These pipes are made with diameters as much as thirty inches, and experts have said that they possess all the essentials for a first-class water-main and submain. The material from which these pipes are made imparts no flavor or odor to the water, does not corrode in any kind of soil, is absolutely impervious to moisture, is practically imperishable, and is not affected by electrical currents which, as is well known, will often perforate and destroy pipes of any thickness made of iron. The cost is fully one-half less than metal pipe, and being very light there is great saving in its transportation. Sections of this asphalt pipe have been immersed in water for six months, carefully weighed before and after immersion, without detecting the least increase in weight, thus showing clearly that it is impervious to moisture.



The joints are connected by means of collars, which fit closely over and around the ends when united.

**Cost of Pipes.**—To determine the capacity of any pipe it may be well to remember that twice the given diameter increases the capacity four times. The factor of first cost to the pipe, while it is undoubtedly the one requiring the least labor to determine, is also the most difficult to arrive at with exactness. Being subject to commercial laws of supply and demand, transportation, competition, etc., this item is so variable that exact estimates can only be given for the present, which may not be at all reliable for the future. It will therefore be our aim to present estimates of cost which may be taken as a fair average and will be relatively correct as between the different kinds of pipe. With this in view the following table has been prepared, which covers the sizes and kinds of pipe heretofore principally used in the construction of piped irrigation systems :

Diam. in inches	Sheet-iron or steel pipe No. 16, B. W. G.	Sheet-iron or steel pipe No. 14, B. W. G.	Sheet-iron or steel pipe No. 12, B. W. G.	Cast-iron pipe Class B or me- dium	Vitrified clay pipe	Wooden pipe	Cement pipe
6 . . . . .	\$0.82	\$ .41	\$0.52	\$0.721 $\frac{1}{2}$	\$0.161 $\frac{1}{2}$	..	\$0.12
8 . . . . .	.42	.51	.62	1.041 $\frac{1}{2}$	.23	..	.20
10 . . . . .	.53	.60	.85	1.42	.38	..	.28
12 . . . . .	.63	.68	.98	1.64	.41 $\frac{1}{2}$	..	.32
14 . . . . .	.69	.76	1.17	2.20	.55	\$0.74	.38
16 . . . . .	.82	.98	1.25	2.68	.68 $\frac{1}{2}$	.94	.45
18 . . . . .	.91	1.00	1.48	3.37	.821 $\frac{1}{2}$	1.08	.53
20 . . . . .	1.00	1.14	1.68	3.97	.961 $\frac{1}{2}$	1.23	.60
22 . . . . .	1.05	1.20	1.85	4.62	1.21	1.32	.68
24 . . . . .	..	1.46	2.00	5.83	1.37 $\frac{1}{2}$	1.40	.80



## CHAPTER IX.

### FLUMES AND THEIR STRUCTURE.



FLUMES are boxes or troughs used to convey water where ditches are impracticable, or needlessly expensive either to construct or to maintain. Where a ravine, valley, or any considerable depression crosses the line of a ditch the water may be turned into a flume, carried over the depression, and then discharged into another ditch on the further side. It may be advisable to carry the water in a flume over loose sandy soil, where the loss by percolation would be so excessive as to render a sufficient delivery from an open ditch either difficult or impossible. Special forms of sheet-iron or other sheet-metal flumes are much used in mountainous sections because of their lightness, tightness and economy, and the facility of erecting them in difficult places. As usually constructed flumes are merely wooden boxes open at the top and of such size and strength as is necessary to carry, and support the water supplied. Many in the west are of great size and strength, and traverse great distances and at great heights. The grades may, if necessary, be somewhat lighter and the size smaller than those of the ditches supplying them, because of the lesser friction and the greater facility of flow. The volume of water to be carried will regulate the size the same as in the ditches, and the grade will in the same way regulate the carrying capacity by

increasing or decreasing the mean velocity of the current. The flume box may be made of two-inch plank, selected as free from loose knots or cracks as possible. If a small box is needed for laterals a single plank of fourteen to eighteen inches will do for the bottom and similar ones for the sides. The supports may in many cases be a single line of heavy fence posts, which may be had in lengths as great as twelve to fourteen feet. The butts set two or three feet into the ground and well tamped give a good foundation. When greater heights than ten to twelve feet are met, a trestle of timber posts properly footed, braced and anchored should be used. The planks before being spiked together may be painted along the edges in contact with a coat of very thick paint. This will not only aid in making a water-tight joint, but will preserve the wood at the joint. After the completion of the flume go over all of the joints with a coat of thick paint or tar, applied with an old stiff brush. A small leak may often be stopped by filling the crack with stiff clay or mud.

**Curves and Grades.**—Where flumes are used and practicable, they are set on a heavier grade than canals—thirty to thirty-five feet to the mile is a good rule—and are of proportionally smaller area than canals with lesser grade. They should be constructed in straight lines if possible. Curves where required should be carefully set out, so that the flume may discharge its maximum quantity. In the ordinary style of construction, sills, posts, and ties support and strengthen the work at every four feet. The posts are mortised into the ties and sills. The sills extend at least twenty

inches beyond the posts, to which side braces are nailed to strengthen the structure. Where flumes are not supported on trestles, but rest on an excavated ledge, it is desirable still to use the stringers, which should be placed just outside the posts, so that water leaking from the sides will drop clear of them. Main supports, such as trestles, are placed eight or more feet apart. Planking should be of pine, redwood, or hemlock. The cross-section of a flume should be no narrower than the bottom of the ditch, for if not built in this way there would necessarily be a contraction that would check the free flow of water. This leads to the question of velocity. The best flumes are built with a vertical drop of from two to four feet at the upper end of the structure and these drops have come to take the place of the inclined aprons, which were formerly much in vogue. There should also be a similar drop at the lower end of the flume to make a water cushion, by which the velocity is broken and washing out is prevented. Most engineers agree that the more velocity a flume has without dropping the grade the better it will be, provided arrangements are made to take care of the water at the discharge. If a flume is narrowed in toward its discharge the sides should be raised proportionately, in order to provide the proper carrying capacity and at the same time prevent slopping over.

**Construction.**—There are wooden and iron flumes, each built in various forms. In building wooden flumes they are so superficial at best that they should be well made and no expense should be spared in their construction. The best material only should be used, and the writer has found seasoned and surfaced lum-

ber preferable to unseasoned stuff. It is best to tar or creosote well-seasoned lumber, and painting or tarring green material is to be discouraged, as it only induces decay and brings on disappointing results. Tarring may be done in vats before construction, or it may be done afterward by using mops or brushes. We would advise in the latter case the application of boiling hot tar on the inside only and after all joints, seams and crevices had been carefully caulked with oakum. The boxing of flumes is generally of three different forms. In the first the floor is built directly on stringers and the planking floor placed at right angles with the longitudinal axis of the flume or the flow of the water. The second style is to lay floor beams on the stringers, bracing them at intervals so as to bear the water pressure. The standards and floor beams are boxed in and bolted to the outside braces, the whole forming the foundation for the sheathing or boxing. The third form, employed more generally on large flumes, consists in framing the floor beams and stringers in cross yokes to receive the boxing.

A very good representation of a flume provided with a waste-gate is portrayed in Fig. 29. It is customary to place a waste-gate in each flume, because the structure furnishes a cheap mode of introducing an escape, and furthermore it is desirable to be able to empty the canal immediately in case the structure should need repair. Where flumes are built on trestles the latter are usually supported on piles, though in cases where the bed of the drainage is of sufficiently firm nature, they rest simply on mudsills. Suitable drains and wings must be provided at both ends of the

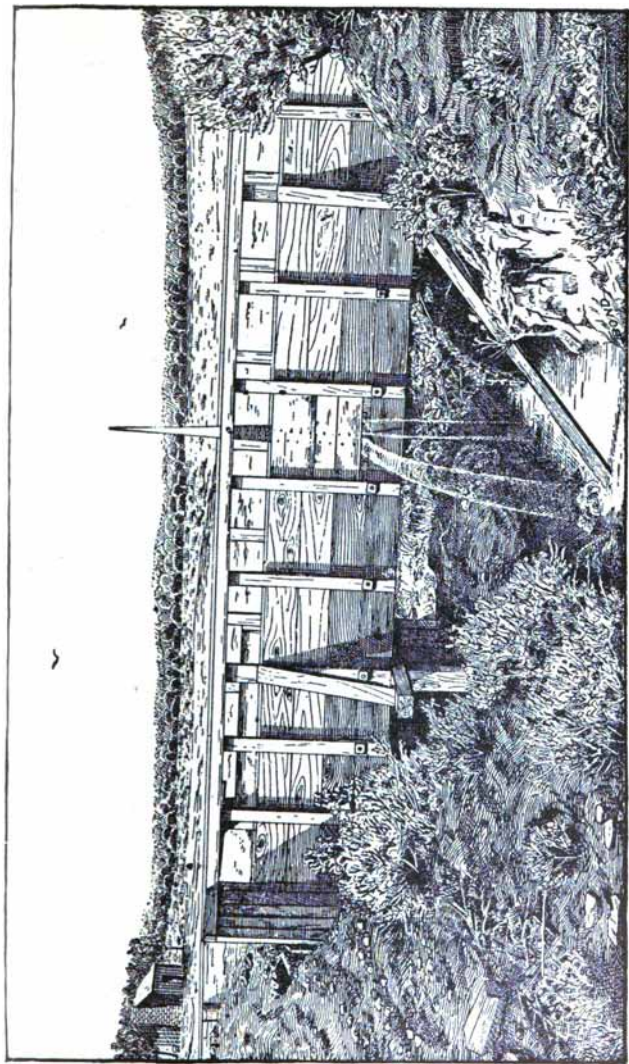

FIG. 29--BOX FLUME WITH WASTE GATE.

flume. Where bench flumes are constructed it is best to make the bench twice as wide as the flume in order that there may be a footway alongside. In such flumes the foundation is simply mudsills and cross-beams.

In sheathing a wooden flume it is best to use large

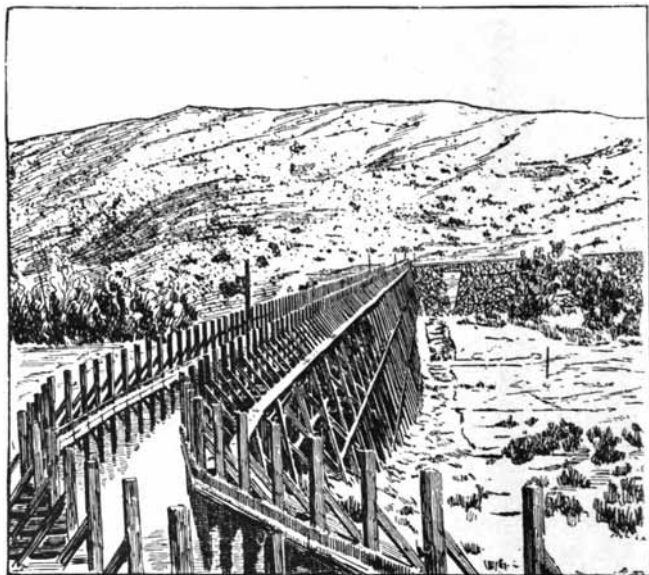

FIG. 30—FLUME ACROSS A VALLEY.

wire nails or cut spikes for the floor, but the sides should be fastened with bolts through inside cleats at the joints. If nails are used in the side planking they will rot out and it will be found impossible to keep the planks on.

The weak spot in every flume is at either end where

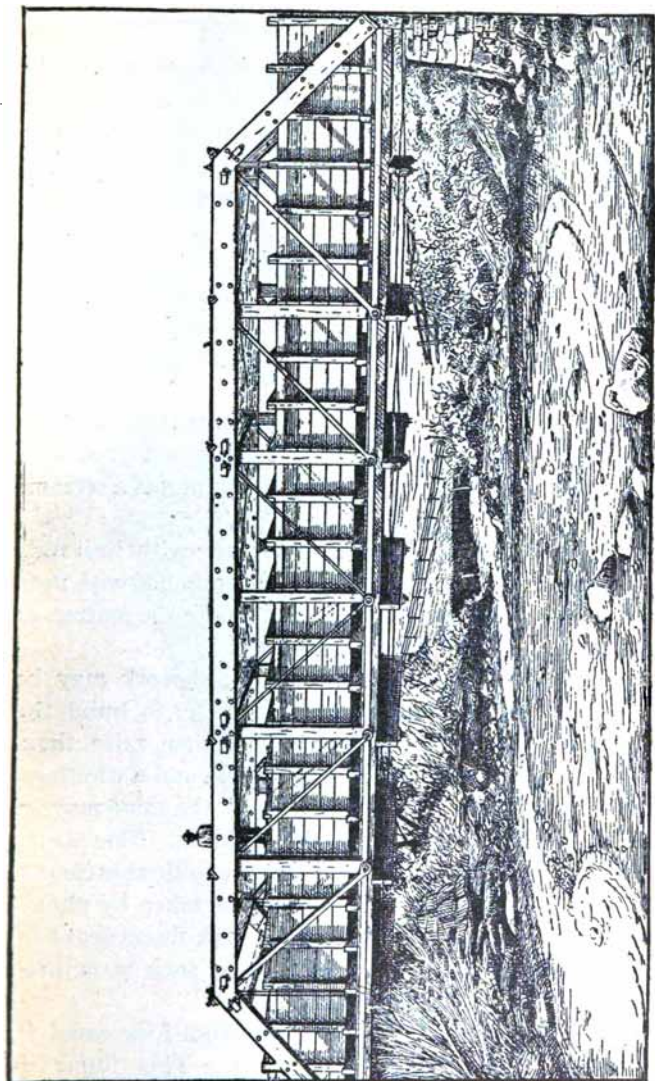

FIG. 31—TRUSS FLUME ACROSS A STREAM.



the woodwork joins upon the earth or terreplein, as the case may be. There the earth should be carefully puddled at the apron and the whole surface from side to side of the ditch, and the sides as well, should be tamped and retamped. Retaining walls or riprap at the sides and embracing the flaring wings may be employed, but in any event the tamping must be thoroughly done and the work gone over time and again if needs be in order to prevent the possibility of washing out. This tamping will be necessary if either the drop-box or the inclined apron be used.

The bracing of a flume is an important matter, especially with deep flumes. A good system of side bracing is depicted in the bridge flume across a stream, and shown in Fig. 31.

Cross-section braces are often made with iron rods running through the side posts and tightened with nuts and washers. Any builder can arrange the matter of the bracing to suit himself.

In very high flumes a lofty trestlework may be required. If this is the case it is better to build the bents in sections on the ground and then raise them into position by means of tackle-blocks and a windlass, or by using a steam hoisting drum if the same may be readily obtained without much expense. The *modus operandi* of hoisting these great trestle sections is clearly illustrated in Fig. 32, which is a scene taken by photograph during the construction of a high flume near San Diego, California. As a general rule such structures as this are not practicable.

The great bench flume on the High-Line canal in Colorado is illustrated in Fig. 33. This flume is

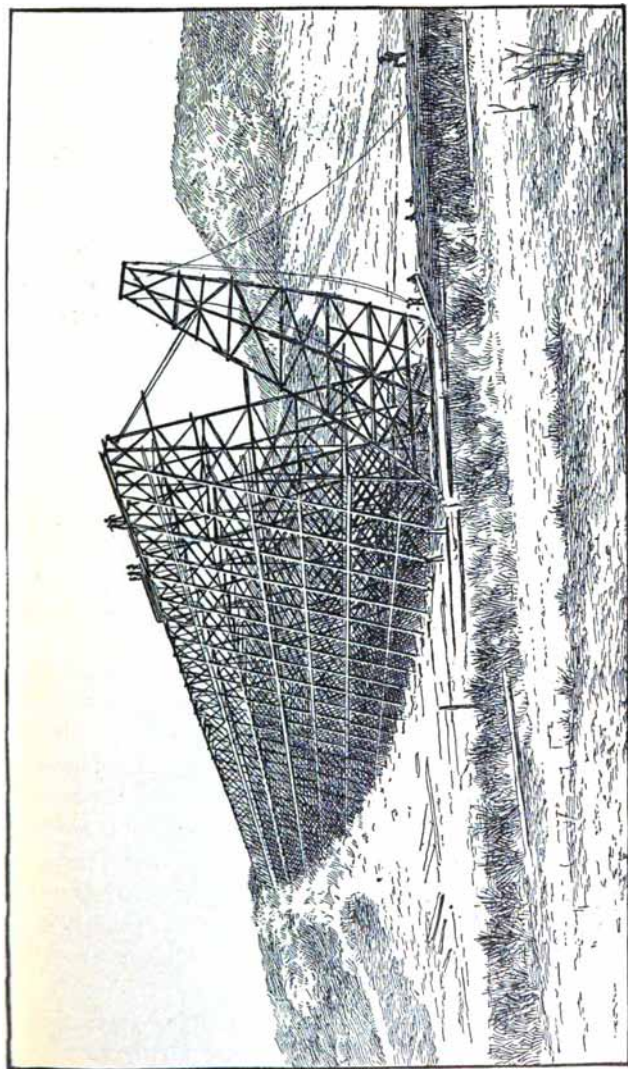

FIG. 32—METHOD OF ELEVATING A HIGH-FLUME TRESTLE.

twenty-eight feet wide, seven feet deep, and is set on a grade of from five to eight feet to the mile, its total length being 2,640 feet and its capacity 1,184 second feet. The timbers supporting the flooring are sufficiently heavy and abundant to render the work substantial, while the sills supporting it are well braced and framed. The side braces supporting the uprights are peculiarly and expensively housed by letting them into iron castings or shoes at either end. These shoes, bolted to the woodwork of the flume, cannot be said to have increased the life of the structure, as they have caught rain or leakage water and have thus added greatly to the deterioration of the wood.

**Fluming Across a River.**—Another notable flume is shown in Fig. 34. It is a wooden flume across the Pecos river in New Mexico. The bottom of this great flume is 40 feet above the river-bed, it is 25 feet wide in the clear, 8 feet deep, 475 feet long, and rests on substantial trestlework with spans 16 feet in length. Across the river-bed this flume is founded on cribs drift-bolted to the solid bed-rock of the river and filled with rock. The abutments of this flume at its junction with the canal, which runs on top of the terreplein, consists of wooden wings set back a distance of 12 feet into the earth, well braced, and supported on anchor piling and filled with earth. The planking of these wings is two inches in thickness. The flume rests on five sets of 12 x 12 timbers forming each bent of the trestle, and these are well cross-braced. On them rests a cap piece 12 x 12 inches, and on this are ten longitudinal stringers 16 feet in length, extending from one bent of the trestle to the other. These stringers are

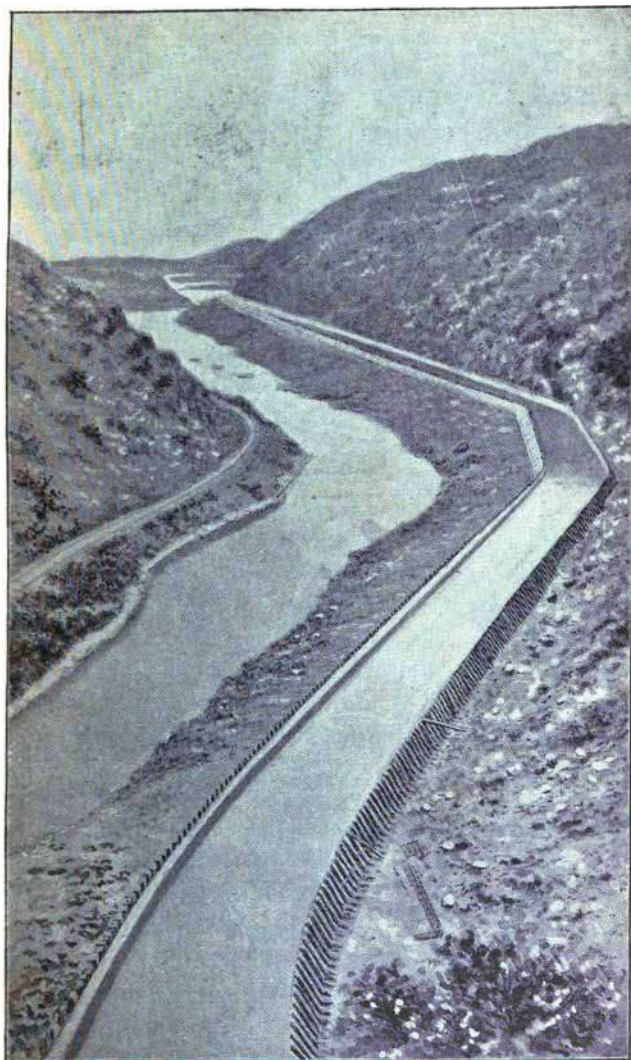

FIG. 33—BENCH FLUME FOR A LARGE CANAL.

6 x 12 timber, and on them are nailed 2-inch floor planking placed at right angles to the current. The side bracing of the flume consists of 6 x 8 scantling 8 feet in length, though at present these are planked for a depth of only 5 feet, giving the flume that available depth. These pieces are placed 4 feet apart between centers and are braced by short struts at each bent of the trestle.

**The Arc Stave Flume.**—A comparatively new idea is the arc flume which is being used quite extensively throughout the Rocky Mountain region west of the Continental Divide and along the Pacific coast. This flume is semicircular in shape, and is formed of redwood or pine staves bound with steel bands, fastened to tie-beams across the top. The staves are quarter-sawed from 2 x 6 inch sticks. The tie-beams are 4 x 4 inches, so that when built the flume is a stiff, water-tight, half-round trough, supported at intervals of eight feet by wooden saddles. No nails are used in the flume, and it is easily and cheaply adjusted to any condition of humidity by means of nuts at the ends of the iron bands, much like those used for the circular stave pipes. The Mount Nebo Irrigation Company in Utah is using this system. The reservoir is over six miles long, and holds more than a billioncubic feet of water. The dam is 44 feet high, 330 feet long, and 110 feet wide at the bottom. A tunnel 140 feet long, through solid rock, some distance away from the dam, furnishes an outlet for the reservoir. In conducting the water down Currant Creek Cañon a large flume crosses on high trestlework, and some distance below where it was necessary to cross

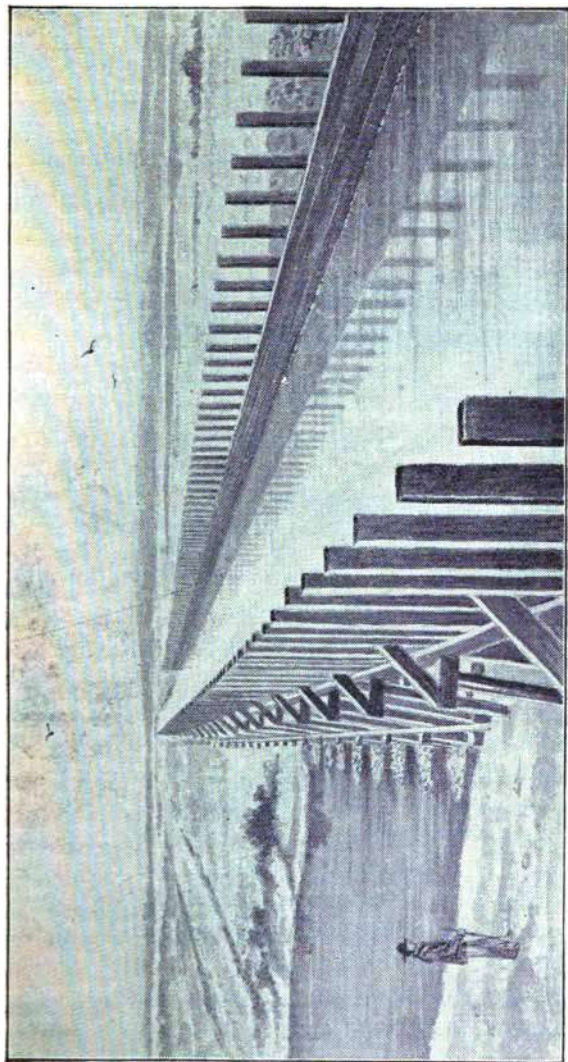

FIG. 34—THE GREAT FLUME OVER THE PECOS RIVER.

the cañon again, the water is conducted through an arc pipe-line 2,000 feet in length. There is nearly one and a half miles of this pipe and flume, and so well was the work done that when the water was turned in to the full capacity scarcely a leak was seen anywhere.

**Iron Flumes.**—One of the greatest objections to the use of wooden irrigating flumes is the alternate

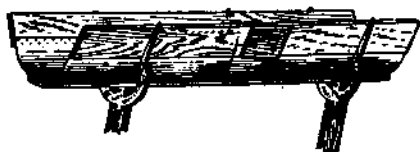

FIG. 35—SIDE VIEW OF SMALL IRON FLUME.

shrinking and swelling of the wood and the consequent warping and distortion of the structures. To overcome this difficulty, and at the

same time to provide a durable substitute, easy of transportation and erection, M. H. Laybourn, of New Windsor, Colorado, has designed and patented an iron flume, which is illustrated herewith.

Galvanized iron is used for the trough of the flume, which is supported in various ways, according to the exigencies of the case, but generally by means of cast-iron brackets placed on timber supports. Fig. 35 shows a small flume, supported on single posts. In this, as in other cases, the upper edge is stiffened by means of a board or plank, which also provides

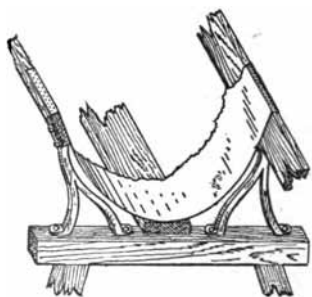

FIG. 36—END VIEW OF SMALL IRON FLUME.

a means of fastening the flume to the bracket. Fig. 36 shows a larger flume half-circular in section, supported by a bracket at each side resting on horizontal timber. In both these cases the board beneath the flume may be omitted, but it aids in erection, and adds stability to the structure. The smaller sizes do not have riveted connections between joints, and therefore, especially in

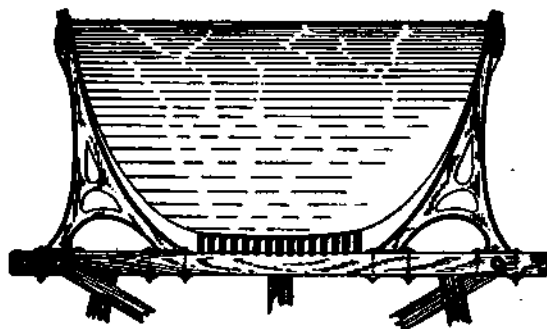

FIG. 37—CROSS-SECTION OF LARGE IRON FLUME.

the use of the single post support, may be easily moved from one locality to another.

The general shape of the flumes in section is parabolic. Where depth is restricted and the volume of water to be carried is large, the type shown in Fig. 37 is adopted, the sides being parabolic and the bottom circular. In this case the bottom of the flume is supported throughout its entire length by plank or timber on edge let down into the sill of the trestle to conform to the shape of the flume.

In case it is desired iron may be substituted for the timber supports. Figs. 38 and 39 show how admi-



rably this form of flume may be adapted to a rough country by resting one end of the sills on a precipitous rock wall and supporting the other on timbers, or by means of rods and eye-bolts driven into an overhanging cliff.

Either galvanized iron, black iron, or asphalted

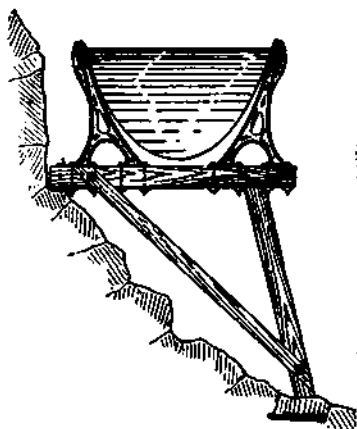

FIG. 38—FLUME ON A ROCKY  
LEDGE.

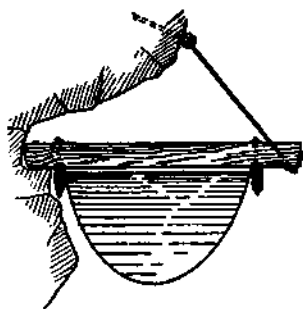

FIG. 39—FLUME WITH OVER-  
HANGING SUPPORT.

sheet iron may be used for the trough. All the metal used in constructing the flume is, or may be if desired, shipped with it, so the erection is very easy.

**Siphons.**—These are often used to convey a ditch under instead of over a depression in the earth, and may aptly be called an inverted box flume, into which the water flows at the upper end and is discharged at a somewhat lower level on the other side of the ravine or gulch. The same materials as are used in flumes may be employed, and the only extra precaution required is to

have them well bolted or provided with braces, that are keyed as tight as possible. Iron bolts or hasps are best. Cast-iron pipes of sufficient diameter or sheet-steel tubes may be used with favorable results. It should not be forgotten, when deep and wide depressions are to be crossed, that the Great Architect of the Universe, in providing that water should rise to its own level, has done away with the necessity for tall and costly trestles. The Moors, whose works still remain as a witness of their constructive skill, understood the use of this beneficent provision, and employed it in works that would not disgrace an engineer of the present time.

## CHAPTER X.

### DUTY AND MEASUREMENT OF WATER.

**I**N order to determine the amount of land which can be served by the flowing water of an irrigating season and by the storage of water of the non-irrigating season, it is necessary to ascertain the quantity of water which should be used in serving a definite area of land. This is called by irrigation engineers the duty of water, which, by the way, is affected by the amount of rainfall, the artificially supplied water being complementary to it. It is also affected by latitude, altitude and other climatic conditions. It is further affected by the character of the soils, and finally depends largely upon the kind of crops raised.

In the storage of water, in order to determine the amount which can actually be conserved for useful purposes, it is necessary to ascertain the extent and the rate of evaporation under different conditions of latitude, altitude and general climate. Local condition, character of the soil, slope of the land, cultivation, humidity, evaporation, precipitation, drainage and capillary action are so widely at variance in different localities that there is small hope of getting any formula which will admit of extended application. Crops differ with respect to moisture requirements. For example, oats and wheat will require more than rye and barley,

and buckwheat, amber cane and corn still less than the other grains.

In Colorado, water rights vested on a basis of the low duty assigned to water ten years ago have, in instances, deteriorated lands and reduced their productiveness by a surfeit in application; while on adjoining lands, through an enforced economy, a higher duty, better condition of the soil and greater productiveness have resulted. Unskilled labor has a penalty of twenty-five to fifty per cent. attached to it in the application of water, and unfortunately this class is too prevalent in the irrigating fields, in many cases no other being obtainable. An abundant water-supply tends to carelessness in its application and consequent waste. On the duty of water depends the financial success of every irrigation enterprise, for as water becomes scarce its value increases. In order to estimate the cost of irrigation in projecting works, it is essential to know how much water the land requires. In order to ascertain the dimensions of canals and reservoirs for the irrigation of given areas, the duty of water must be determined.

**Numerical Expression.**—Before considering the numerical expression of water duty the standard units of measurement should be defined. For bodies of standing water, as in reservoirs, the standard unit is the cubic foot. In the consideration of large bodies of water, however, the cubic foot is too small a unit to handle conveniently and the acre foot is the unit employed by irrigation engineers. This is the amount of water which will cover one acre of land one foot in depth, and that is 43,560 cubic feet. In considering

running streams, as rivers or canals, the expression of volume must be coupled with a factor representing the rate of movement. The time unit usually employed by irrigation engineers is the second, and the unit of measurement of flowing water is the cubic foot a second, or the second foot as it is called for brevity. Thus the number of second feet flowing in a canal is the number of cubic feet which passes a given point in a second of time. The cubic foot a second is the unit of measurement usually adopted in the distribution of water from or by the large canals of Colorado. A quantity of water equivalent to a continuous flow of one cubic foot a second, during the irrigating season of one hundred days, will usually irrigate from fifty to sixty acres of land. It will often do more than this. Another unit still generally employed in the west is the miner's inch. This differs greatly in different localities and is generally defined by state statute. In California one second foot of water is equal to 50 miner's inches, while in Colorado it is equivalent to 38.4 miner's inches. In the following arrangement are given a few convertible units of measure :

- 1 second foot = 450 gallons a minute.
- 1 cubic foot = 7.5 gallons a minute.
- 1 second foot = 2 acre feet in 24 hours—approximated.
- 100 California inches = 4 acre feet in 24 hours.
- 100 Colorado inches = 5½ acre feet in 24 hours.
- 1 Colorado inch = 17,000 gallons in 24 hours.
- 1 second foot = 59½ acre feet in 30 days.
- 2 acre feet = 1 second foot a day or .0333 second feet in 30 days.

A miner's inch is supposed to define the quantity of water flowing through an aperture an inch square, but as in some parts the pressure adopted is that of a four-

inch head, while in other places the head is six inches, there is evidently abundant room for variation, even in the determination of the capacity of a single inch. When, again, a number of inches came to be measured at once, it became possible either to adopt an aperture one inch high and the specified number of inches in length, or to take the square of the whole number of inches as giving the dimensions of the orifice, in which case there is another great cause of variation. The State Engineer of Colorado has calculated that the miner's inch has been .026 cubic feet, or, roughly speaking, a fortieth of a cubic foot, which is equivalent to a flow of nearly nine gallons a minute, and this is now generally adopted, though as a matter of fact, in more southerly states where water has been scarce, the miner's inch has only meant one-fiftieth of a cubic foot.

**An Irrigation Head.**—The proper wetting of the whole ground requires what is known as an irrigation head. To irrigate ten acres with a miner's inch of water needs from fifteen to thirty inches of flow at a time, depending upon the porosity of the soil. A single inch flowing constantly and used in that way would not irrigate over two acres at the best, and generally not over one-half an acre properly. But the flow of a single inch without any reservoir to accumulate it may be used in another way so as to produce fair results on from ten to forty acres, according to the nature of the soil, the amount of rainfall and the kind of trees—for it is only for trees that it can be used to advantage. It would hardly pay to make trenches around grape-vines on any large acreage, and although

some berries, vegetables, and other small stuff may be raised, it generally takes too much work and time to water a large area of them in that way.

The farmer who sees a severe drouth broken by a three hours' flow of water hardly understands that every acre of his farm has received in an inch of irrigation no less than 100 tons of water, or 100 acres has had 10,000 tons of water poured over it. The quantity of water on a single acre by such irrigation will be not less than 130 cubic yards. A little wetting of this character places more than 1,000 tons in twenty-four hours on every acre, or 100,000 tons on a 100-acre farm. Now an average irrigation requires a five-inch layer of water over an entire field, while some crops, oats for instance, often demand a solid covering of ten inches. When using windmill irrigation in a small way it may be well to roughly approximate an acre of garden or orchard as requiring 1,000 barrels of water for an ordinary wetting, but in this the greatest economy is necessary, and it is best to apply the water by the rill or row method. The following figures will give an idea of the amount of water necessary to properly irrigate a definite area of land in a humid climate, such as that of the central and eastern states: There are 6,272,640 square inches to an acre. One inch of water or a stream one inch wide and one inch deep, flowing at a rate of four miles an hour, will give 6,082,560 inches in twenty-four hours. Such a stream will therefore cover nearly an acre one inch deep in twenty-four hours. This would require about 25,920 gallons or 823 barrels of water.

**Advantage of Large Heads.**—A full head of

water divided into four canals flowing a mile an hour will run two and a half miles in the same time if carried through one canal. The seepage of a full head of water distributed through four canals is three and a half times as much as when held in one body. The evaporation is six times as much when divided into four parts as when held in one body. This comes from the fact that a small stream becomes much more heated than a large one. The small one runs slowly, while a heavy body flows fast. Then there are four surfaces instead of one exposed to sun and wind. The waste of water running through four canals or ditches is very great. If a fifty-inch flow of water will cover one-quarter of an acre an hour 100 inches will cover three-quarters of an acre in an hour, 200 inches two acres in an hour, and 400 inches five acres in an hour. The difference in irrigating five acres an hour and irrigating one-quarter of an acre in an hour is that the former requires two strong men while in the latter case a boy only is needed. A full head will irrigate evenly, but a small stream will soak the upper end, while the lower end is yet dry. Some writers have thought to remedy this matter by giving each canal its water in bulk by the hour instead of a small constant flow. The canal running full capacity so many hours a given length of time would thus give each user a full head for all the hours of his time. Furthermore, a man when he knows he is going to get a good head of water in time of scarcity will clean out his ditches and be fully prepared for the water when it comes. To do this, however, in most of the western states would require the substitution of new laws



governing the rights of appropriation from public streams.

**The California Standard.**—The most economic users of water, in America at least, are the Californians, as their necessities are reduced on account of a limited water-supply. At Riverside they use an inch of water to five acres, and some an inch to three acres. But this is because they charge to the land all the waste on the main ditch and because they use thirty per cent. of the water in July and August, when it is the lowest. But this is no test of the duty of water; the amount actually delivered on the land should be taken. What they actually use for ten acres at Riverside, Redlands, etc., is a twenty-inch head of three days' run five times in the year, equal to 300 inches for one day, or one inch steady run for 300 days. As an inch is the equivalent of 365 inches one day, or one inch for 365 days, 300 inches for one day equals an inch to twelve acres. Many use even less than this, running the water only two or two and one-half days at a time. Others use more head, but it rarely exceeds twenty-four inches for three days and five times a year, which would be seventy-two multiplied by five, or 360 inches, a little less than a full inch for a year for ten acres. In summing up, we may say that the duty of water in Southern California may be put at an average of one inch to eight acres, and the cost of water at a first charge of \$35 to \$60 an acre for the right, and a further charge of \$1.50 to \$2.50 an acre per annum for the water whether used or not.

**Evaporation.**—Throughout the arid region of the United States the conditions which determine the

amount of evaporation are exceedingly variable, and it ranges from a probable minimum of 20 inches to a probable maximum of 105 inches per annum. If water, therefore, be stored in artificial lakes, where evaporation is but 20 inches a year, a very small amount of water is thus lost, but if it be stored where the evaporation reaches the amount of 100 inches a year the water loss is very great. It is to be remembered that in the actual application of water unnecessary slowness of flow induces increased evaporation and absorption, and hence it is that in the flooding system the quick head sharply applied gives the best results.

On the average all cultivated plants will exhale each day a quantity of water equal to the dry growth of the plant for the year. The time of growth varies from seventy-five to one hundred and fifty days, but in general the plant requires for good growth about one hundred times as much water as the yearly growth when dried. This is equal to eighteen inches in depth, which therefore may be called the absolute duty of water. To this must be added one-third for seepage and evaporation. But to calculate more readily the Colorado irrigators will usually estimate that twenty-one total acre inches are sufficient for a season's water-supply for ordinary crops, and the writer is inclined to favor this estimate as being about right.

The duty of water is constantly increasing in nearly every portion of the country where irrigation is practiced. To-day in Colorado some engineers and canal companies are making the standard of duty nearly double what it was formerly. But the crops grown, the system used and the means of applying water, all

cut a very important figure. As we have already indicated, where flooding takes thousands of gallons the furrow system only requires hundreds, and subirrigation tens of gallons for a similar area.

**Measurement of Water.**—There are also many different standards of measurement of water for irrigating, and so many different conditions under which it is applied, that one is apt to become confused and will decide that there is a good deal of technicality about it that is perplexing and intricate. As before stated, the units of measurement are the miner's or statutory inch, cubic and acre feet, or by the gallon. With engineers the cubic foot per second is the standard unit, and the quantity is determined in large volumes by the rate of flow in the sectional area of the channel and in the smaller volumes by the flow over a measuring weir. The theoretical capacity of a channel as determined by formulæ is almost always in excess of the actual capacity as determined by experiment, by a varying percentage dependent upon the following conditions: First—Sinuosity or aggregate degree of curvature. Second—Sharpness of bends or degree of curvature. Third—The uniformity and symmetry of cross-section. Fourth—The character of the frictional perimeter of the sides and bottom. The simple theory of flowing water in channels is not a difficult matter of understanding, but it is the modification of this theory by the various coefficients of friction that leads to misunderstanding.

To properly estimate the flow of water in canals and its distribution through headgates a number of devices have been invented, and these include such things as nilometers, current meters, hydrometric sluices,

division boxes, modules, weirs and water registers. A measuring device is not always necessary, especially where one has his own private water-supply, but in taking water from public canals it is always more satisfactory to have an arrangement by which the actual intake of water may be determined, and the Colorado statute now prescribes this requirement.

**A Miner's Inch.**—As before specified, a miner's inch may vary considerably, as it is rated with a pressure of from four to six inches. We should say that a safe calculation may be made with a five-inch pressure as a medium of computation. A flow of water through such an inch aperture is called a miner's inch. To find the number of gallons in miner's inches, multiply the given number of miner's inches by 14.961, pointing off five decimal places. The result gives the number of gallons discharged per second. To find the number of miner's inches in gallons, divide the number of gallons flow or discharge per minute by 8.9766. The result will be the number of miner's inches sought. One miner's inch will flood ten acres a year 1.45 feet deep, 14.49 acres a year one foot deep, 18.11 acres a year nine inches deep. A continuous miner's inch will irrigate one acre of garden or orchard nicely.

**Divisors.**—It often occurs that in taking water from a ditch two consumers will use one sluiceway or box, in which event a divisor is required. In using a divisor there is no unit of measure, and none is needed. In its most common form the divisor consists of a partition dividing the channel into two portions in proportion to the respective claims. This, in effect, assumes that the velocity is uniform across the whole

cross-section, which is not the case even in a uniform channel, and is much less so in one irregular or in poor repair. Such a division is to the disadvantage of the smaller consumer. The nearer the velocity is uniform across the whole channel the better this method of division. Accordingly, means are frequently taken, by weir-boards or otherwise, with this object in view, but generally with indifferent success. A screen would

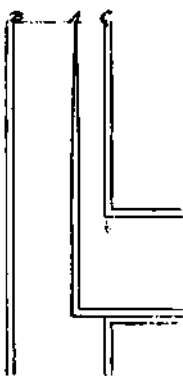

FIG. 40—DIVISOR.

accomplish this one object better, but the objections to its use are too many in most places to render it practicable. Fig. 40 represents one of the most common forms of divisors. The partition board (*A*) is movable, and may be placed at different distances from the side (*C*), so that the user can vary the proportion of water which he receives. A cleat of some kind is often used to prevent the board from being moved beyond a certain limit. Where the ditch is wide and shallow there is sometimes a simple truss used with a depending cleat. Sometimes a wire or chain restricts the movement. In these cases it is usually assumed that the amount of water going to the side channel is in proportion to the distance the movable partition is from the side, and the ratio is the same to the distance across as the volume is to the volume in the whole ditch.

**Module or Measuring Boxes.**—The measuring box has for its object the proper apportionment of water to each consumer, so that he may depend upon

receiving a definite quantity from the main ditch. The method of measurement gaining in favor in the west is by means of a hydrometric flume. One of the most ingenious and satisfactory for use on small dis-

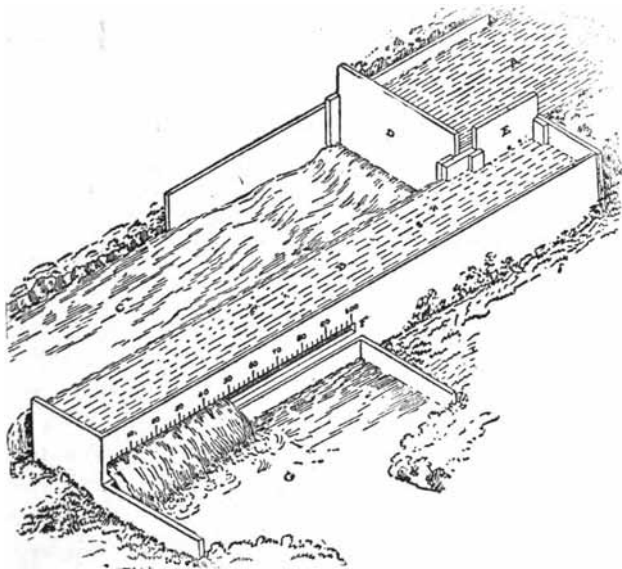

FIG. 41—FOOTE'S MEASURING FLUME.

tributaries is that invented by Mr. Foote. The chief fault of this apparatus is the fact that it measures water by the inch instead of by the second foot. This unit of graduation can of course be changed. Its merit consists in the circumstance that it renders it possible to maintain very nearly a standard head, as shown in Fig. 41. It consists of a flume placed in the main lateral (*A*), and a side flume (*B*), in which

is constructed the measuring gate, while opposite to it is a long overfall (*C*), the height of which is used to maintain a standard head above the measuring slot. Such a weir is cheaply constructed and easily placed in position, and costs but a few dollars for a small service head. It needs no oversight or supervision, as it can be locked until a change of volume is desired. The irrigator himself can with his pocket-rule demonstrate to his entire satisfaction that he is getting the amount of water in inches for which he is paying.

**Weirs.**—To determine the flowing capacity of small streams, ditches or laterals the rectangular weir, such as is illustrated in Fig. 42, may be employed, thanks to the ingenuity of James Leffel, of Ohio. The illustration represents a weir dam across a small stream. When it is convenient to use a single board, as is shown in the sketch, one may be selected sufficiently long to reach across the stream, with each end resting on the bank. Cut a notch in the board sufficiently deep to pass all the water, and in length about two-thirds the width of the stream. The bottom of the notch (*B*) in the board, also the end of the notch, should be beveled on the down-stream side, and within one-eighth of an inch of the upper side of the board, leaving the edge almost sharp. A stake (*E*) should be driven in the bottom of the stream, several feet above the board, on a level with the notch (*B*)—this level being easily found when the water is beginning to spill over the board. After the water has come to a stand and reached its greatest depth, a careful measurement can be made of the depth of water over the top of stake (*E*), in the manner illustrated. Such measurement gives the true

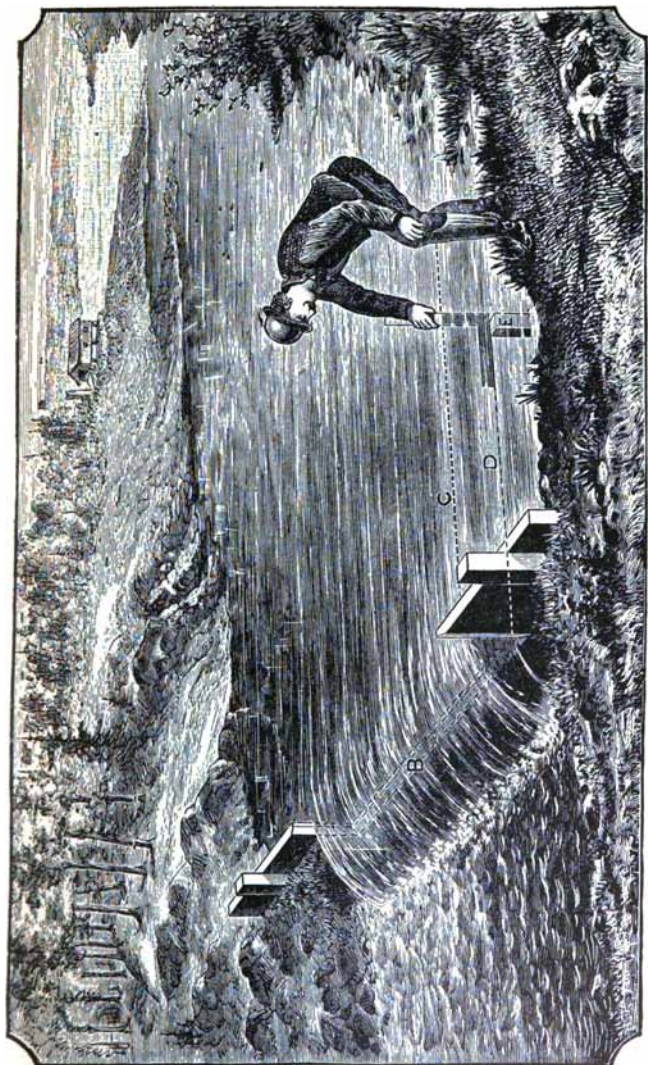

FIG. 42—RECTANGULAR WEIR.



depth of water passing over the notch, because if measured directly on the notch the curvature of water in passing would reduce the depth. The line *D* is a level from the bottom of the notch (*B*) to the top of the stake (*E*), while the dotted line *C* represents the top of the water, and the distance between the lines from the top of stake gives the true depth or spill over the weir-board. The lines in the sketch have the appearance of running over the top of the board, when in fact they pass behind it, but for the purpose of illustration the reader is supposed to look through the board and the post. The surface of the water below the board should not be nearer the notch (*B*) than ten inches, that the flow will not be impeded. Neither should the nature of the channel above the board be such as to force or hurry the water to the board, but should be of ample width and depth to allow the water to approach the board quietly. If the water passes the channel rapidly it will be forced over the weir and a larger quantity will pass than if allowed to spill from a large body moving slowly.

**Weir Table.**—The table on the opposite page may be of service where the delivery is such that it can be measured over a rectangular weir, as described under the foregoing caption.

To use the table, measure the depth of water in inches over the weir. From the depth so measured find in the table the miner's inches flowing for each inch of width in the weir opening. The width of the weir opening in inches multiplied by miner's inches in the table gives the miner's inches flowing over the weir. Multiply the miner's inches by .02 to obtain the cubic

feet a second or .04 for the acre feet a day, or by 0.5 for the acre inches a day, or by 4 for the acre feet in 100 days, or by 9 for the gallons a minute.

THE CALIFORNIA WEIR TABLE

Depth	Miner's inches	Depth	Miner's inches	Depth	Miner's inches	Depth	Miner's inches
1 $\frac{1}{8}$	.01	3 $\frac{7}{8}$	2.56	7 $\frac{1}{8}$	7.04	12 $\frac{1}{4}$	15.27
1 $\frac{1}{4}$	.04	4	2.89	7 $\frac{3}{8}$	7.29	13	15.72
1 $\frac{3}{8}$	.07	4 $\frac{1}{8}$	2.81	7 $\frac{5}{8}$	7.40	13 $\frac{1}{4}$	16.18
1 $\frac{1}{2}$	.12	4 $\frac{1}{4}$	2.93	8	7.56	13 $\frac{1}{2}$	16.64
1 $\frac{5}{8}$	.17	4 $\frac{3}{8}$	3.07	8 $\frac{1}{8}$	7.78	13 $\frac{3}{4}$	17.10
1 $\frac{3}{4}$	.22	4 $\frac{1}{2}$	3.19	8 $\frac{1}{4}$	7.98	14	17.57
1 $\frac{7}{8}$	.27	4 $\frac{3}{4}$	3.33	8 $\frac{3}{8}$	8.13	14 $\frac{1}{4}$	18.04
1	.33	4 $\frac{7}{8}$	3.47	8 $\frac{1}{2}$	8.30	14 $\frac{1}{2}$	18.52
1 $\frac{1}{8}$	.39	4 $\frac{7}{8}$	3.51	8 $\frac{3}{4}$	8.48	14 $\frac{3}{4}$	19.00
1 $\frac{1}{4}$	.46	5	3.75	8 $\frac{7}{8}$	8.67	15	19.48
1 $\frac{3}{8}$	.54	5 $\frac{1}{8}$	3.89	8 $\frac{7}{8}$	8.88	15 $\frac{1}{4}$	19.96
1 $\frac{1}{2}$	.63	5 $\frac{1}{4}$	4.08	9	9.05	15 $\frac{1}{2}$	20.47
1 $\frac{5}{8}$	.69	5 $\frac{3}{8}$	4.18	9 $\frac{1}{8}$	9.23	15 $\frac{3}{4}$	20.97
1 $\frac{3}{4}$	.77	5 $\frac{1}{2}$	4.32	9 $\frac{1}{4}$	9.42	16	21.47
1 $\frac{7}{8}$	.86	5 $\frac{3}{4}$	4.47	9 $\frac{3}{8}$	9.62	16 $\frac{1}{4}$	22.47
2	.95	5 $\frac{7}{8}$	4.62	9 $\frac{1}{2}$	9.81	17	23.50
2 $\frac{1}{8}$	1.04	5 $\frac{7}{8}$	4.77	9 $\frac{3}{4}$	10.00	17 $\frac{1}{4}$	24.54
2 $\frac{1}{4}$	1.13	6	4.92	9 $\frac{7}{8}$	10.19	18	25.58
2 $\frac{3}{8}$	1.22	6 $\frac{1}{8}$	5.08	9 $\frac{7}{8}$	10.39	18 $\frac{1}{4}$	26.65
2 $\frac{1}{2}$	1.32	6 $\frac{1}{4}$	5.24	10	10.59	19	27.74
2 $\frac{5}{8}$	1.42	6 $\frac{3}{8}$	5.39	10 $\frac{1}{4}$	10.99	19 $\frac{1}{4}$	28.83
2 $\frac{3}{4}$	1.52	6 $\frac{3}{4}$	5.54	10 $\frac{1}{2}$	11.39	20	29.95
2 $\frac{7}{8}$	1.63	6 $\frac{7}{8}$	5.71	10 $\frac{3}{4}$	11.80	20 $\frac{1}{4}$	31.07
3	1.74	6 $\frac{7}{8}$	5.87	11	12.22	21	32.21
3 $\frac{1}{8}$	1.86	6 $\frac{3}{4}$	6.04	11 $\frac{1}{4}$	12.65	21 $\frac{1}{4}$	33.36
3 $\frac{1}{4}$	1.97	7	6.20	11 $\frac{1}{2}$	13.08	22	34.52
3 $\frac{3}{8}$	2.08	7 $\frac{1}{8}$	6.37	11 $\frac{3}{4}$	13.50	22 $\frac{1}{4}$	35.70
3 $\frac{1}{2}$	2.19	7 $\frac{1}{4}$	6.53	12	13.94	23	36.90
3 $\frac{3}{4}$	2.31	7 $\frac{3}{4}$	6.70	12 $\frac{1}{4}$	14.38	23 $\frac{1}{4}$	38.10
3 $\frac{7}{8}$	2.43	7 $\frac{7}{8}$	6.87	12 $\frac{3}{8}$	14.82	24	39.32

**Gauging Large Streams.**—Frequently it is impossible to construct even a temporary weir on account of the large quantity of water the stream carries. Measurement must therefore be made by other methods, one of the simplest of which is to ascertain the mean velocity of the stream in feet per minute. Next ascertain the area or cross-section of the stream in square feet. Having learned these two quantities their prod-

uct will give the required amount afforded by the stream. The velocity can be estimated by throwing floating bodies into the stream, these bodies having nearly the same specific gravity or weight as the water. The time of their passage can be accurately rated in passing a given distance; it must be remembered, however, that the velocity is the greatest in the center of the stream and near the surface, and that it is least near the bottom and sides. It is usually best to ascertain the velocity at the center, and from this the mean velocity can be estimated, as it has been accurately and reliably ascertained by experiments that the actual mean velocity will be 83 per cent., or about four-fifths of the velocity of the surface. The cross-section may be estimated by measuring the depth of the stream at a number of points at equal distances apart, the depth being measured at each of these points and all of these added together, and multiplying their sum by the distance in feet between any two of the points. In driving these stakes or points, the first one on each side should be half the distance from the edge of the water to the stake that any one of the other spaces will measure, the two end or half spaces together amounting to one whole space. Having obtained the cross-section of the stream in square feet, and also the mean velocity of the stream in feet per minute, the product of these two gives the quantity of water that the stream affords in cubic feet per minute.

**The Current Meter.**—The current meter now so generally used to ascertain with precision the velocity of currents in rivers, irrigating canals, and smaller streams gives the mean velocity of a given filament of

the stream of any required length. A float observation gives only the velocity of a given small volume of water which surrounds the float, and as different portions of the small filament have very different longitudinal velocities, it requires a great many float observations to give as valuable information as may be obtained by running a current meter in the same filament for one minute. The current meter method is the most accurate for obtaining subsurface velocities ever devised. The river current meter used on the geological surveys in the west by the United States

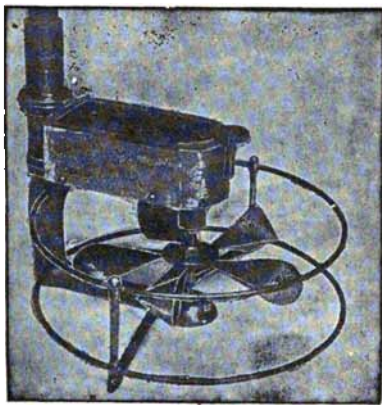

FIG. 43—THE CURRENT METER.

government surveyors is the invention of J. S. J. Lallie, who manufactures them in Denver, and is shown in Fig. 43.

In order to ascertain the velocity of a stream or ditch, lock the gears in the meter and note reading at the pointers, which will be the first reading. Place the meter in the stream or ditch, and at the same instant the gears are unlocked start a stop-watch. Then the meter should be slowly moved from the top to the bottom of the stream at least three times. At the end of these movements the gears are locked, the watch is

stopped and the second reading is made, and these, together with the time, noted down. The difference between the first and second reading is divided by the time, which gives the revolutions per second. The revolutions per second multiplied by the ratio will give the velocity of the stream in feet per second. In the computations the following formula is used: Total number of revolutions divided by the time equals the revolutions per second. Total distance divided by the time equals the velocity in feet per second which the meter moves through the water. Velocity in feet per second divided by the number of revolutions per second equals the ratio.

**The Water Register.**—This is a device used in measuring the water that flows in specified currents, such as rivers, canals, or flumes. Fig. 44 gives a very good idea of its mechanism.

It consists of a dial divided circumferentially into spaces corresponding to the days of the week and the hours and minutes of the day. Beginning at the circumference and going toward the center of the dial it is divided into a scale of feet and inches. The dial is turned by clockwork, making one revolution in seven days. Pressing against the dial is a pen filled with a specially prepared ink which does not dry in the pen. This pen is one of two arms attached to a revoluble shaft, the other arm being in the form of a segment of a gear. This segment meshes with a small pinion secured to a shaft carrying a grooved pulley. Over the grooved pulley a cord is passed, carrying at one end a float which rests upon the water to be measured and at the other end a weight which nearly counter-

balances the float, keeping the cord tight. As the water rises and falls the float rises and falls with it. This fluctuation causes the cord to revolve the grooved pulley over which it passes; the small pinion being fixed on the same shaft as the pulley revolves with it, communicating its motion to the segmental gear, which

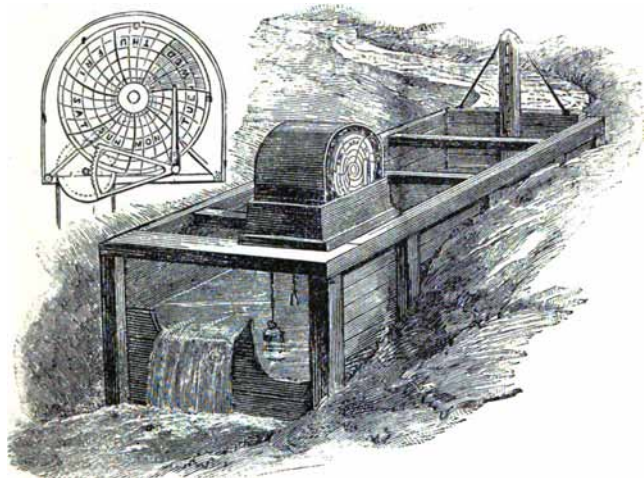

FIG. 44—WATER REGISTER.

being attached to the same shaft as the pen, both will revolve together; and the pen, being in contact with the dial, will trace a mark upon it, leaving a graphical record showing the days, hours and minutes in one direction, and feet and inches in another.

**The Stokes Measuring Gate.**—This is a newly patented device by Mr. Stokes, of Montrose county, Colorado, and is a really useful contrivance for determining just how much water a consumer is receiving

from a ditch company. It is self-registering and is said to be absolutely accurate. The design is shown in Fig. 45. It is not a headgate, but is to be used as a meter, and is placed in the main ditch below the head-gate or in private laterals below the tap-gates. The gate is placed in a frame or box in the ditch, so that the water flows through the aperture created when the slide is raised. In measuring the flow the slide is

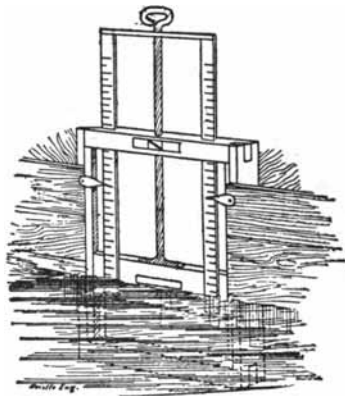

FIG. 45—THE STOKES MEASURING GATE.

lowered into the water until the flange on the side is at the level of the surface. The amount of water is then indicated on the scales. The water must stand steadily at the flange and flow freely away below the gate. These conditions may be secured in a ditch of any grade by the use of a weir-board if necessary. In order to turn out a given quantity of water into a ditch or lateral all that is necessary is to raise the slide until the indicators point to the required amount and then

raise the headgate until the water-level stands at the water-line on the slide. In actual use the velocity of the water is not a factor in the measurement, the velocity of each ditch being brought automatically to a constant by the slide, which creates a fixed pressure for all quantities of water.

**A Simple Method of Measuring Water.**—Select a place in the stream with as even grade as possible having uniform banks and free from rubbish, such as stones, grass or brush. It is desirable to have an even fall of the stream and a nearly uniform current throughout its entire width and depth. The stream should have a straight course for twenty to fifty feet. The cross-section multiplied by the velocity or rate of movement will give the approximate amount of water flowing in the stream. The cross-section is found by measuring the depth at regular intervals across the stream. The average of these is obtained by adding them together and dividing by the number of measurements taken. The average depth then multiplied by the width will give the cross-section. To find the velocity, measure off a convenient distance, say, twenty feet of the stream, where the channel is straight and its bed even. Throw a chip in the stream ten feet above the upper mark. The float will attain the velocity of the water by the time it reaches the first mark. When the float passes the upper point the time is noted by the second-hand of a watch. The float is followed down-stream until it passes the lower mark at the end of the twenty feet, when the time is again noted.

Suppose it took ten seconds for the float to travel the twenty feet, then in one second the stream would



flow one-tenth of twenty feet, or two feet. Therefore, the velocity of the stream is two feet a second. This, multiplied by the cross-section, will give the approximate discharge, or the amount of water, flowing in the stream. Suppose in the case given that the cross-section was eight square feet, then the discharge would be two, the velocity, multiplied by eight, the cross-section, which equals sixteen cubic feet a second. This is not the exact amount flowing in the stream because the water flows fastest near the surface and in the center. The float naturally takes the velocity of the swiftest portion of the current. The velocity is retarded at the sides and bottom by friction. If a more exact measurement is required the result if multiplied by between .80 and .90, according to the roughness of the bank and amount of obstruction in the channel, will give the amount of water flowing in the stream near enough for ordinary purposes. For example: using .80 as a factor in the previous case, we have .80 multiplied by 16 or 12.80 cubic feet as the actual discharge. The judgment of the operator must be exercised in the use of this factor. Ordinarily with common dirt banks a factor of .85 will be nearly correct. By the use of this simple but efficient method any water consumer may ascertain for himself whether or not he is receiving the quantity of water to which he is entitled.

**A California Weir System.**—It often happens that there is great trouble in the canal system in dividing the water equitably among a number of irrigators, patrons of the ditch. Consumers are expected to bear their proportion of loss by seepage and evaporation

between the head of the main canal and their respective gates. This loss is a varying one, being so great on a hot day that if each gate is set to take its quota without shrinkage, the man at the end of the system seldom has enough water to drink. The West Highlands water company in San Bernardino county put in a system of weirs which will completely avoid this difficulty. Their main ditch is one mile in length, with six lateral branches, each the same length. At the head of the first lateral the ditch expands into a large cemented basin having two outlets, one opening into the main, the other into the lateral. In each opening is set an iron gate of ample width and height, and having a sliding door which may be opened sidewise to any given width and fastened at that point. Both gates are exactly on a level. The weir at the head of each succeeding lateral is an exact duplicate. Five weirs suffice for the six branches, the fifth one serving for two, being at the last point of the division. The distribution of the water is so arranged that but one consumer has water in a certain lateral at a time. Under this arrangement the zanjero or ditch walker, starting at the head of the main line with, say, six hundred inches of water to be divided equally among the six laterals, goes to the first weir and sets the gates in the ratio of five for the main to one for the lateral, and so on, the gates in the last weir being set equally open. Measurements to ascertain the amount of water are made on the open weir basis. Under this arrangement it will be seen that any decrease and likewise any increase in the flow is equitably divided among all parties on the system.

**Capacity of Pipes.**—To give a comprehensible exhibit of pipe capacity and discharge, the following table has been compiled :

CARRYING CAPACITY—GALLONS PER MINUTE

SIZE OF PIPE	1 inch fall per 100 ft.	2 inch fall per 100 ft.	3 inch fall per 100 ft.	6 inch fall per 100 ft.	9 inch fall per 100 ft.	1 foot fall per 100 ft.	2 feet fall per 100 ft.	3 feet fall per 100 ft.
3 inch	13	19	23	32	40	46	64	79
4 "	27	39	47	66	81	93	131	163
6 "	75	105	129	189	234	268	364	450
8 "	153	216	265	375	460	527	750	923
9 "	205	290	355	509	617	712	1,008	1,240
10 "	267	378	468	655	808	926	1,310	1,613
12 "	422	596	730	1,033	1,273	1,468	2,076	2,554
15 "	740	1,021	1,262	1,818	2,224	2,464	3,617	4,467
18 "	1,169	1,651	2,023	2,860	3,506	4,045	5,704	7,047
24 "	2,396	3,387	4,155	5,874	7,292	8,309	11,744	14,466
30 "	4,187	5,920	7,252	10,557	12,680	14,504	20,516	25,277

**Some Simple Rules.**—A miner's inch of water is equal to nine gallons a minute.

Doubling the diameter of a pipe increases its capacity four times.

A cubic foot flowing a second of time is equal to fifty miner's inches, or 450 gallons a minute.

A cubic foot of fresh water weighs 62.5 pounds and contains 1,728 inches, or 7.5 gallons.

27,144 gallons of water will cover one acre one inch deep.

225 gallons a minute, or 25 miner's inches, will be sufficient to cover one acre one inch deep in two hours and one minute.

A simple method to determine what a windmill pump is discharging is to measure the actual delivery with a gallon measure for one minute and multiply by

sixty. Divide the gallons per hour by 38 to obtain the acre inches per month, or by 13 for the acre inches in three months. These results are not mathematically accurate, but will be found close enough for ordinary computations. They make no allowance for seepage and evaporation.

A safe rule for finding the capacity of a cylindrical cistern is to take the dimensions in inches, square the diameter, multiply by the depth, and then by .0034, which will give the contents in United States standard gallons. Thus to find the capacity of a cistern twenty-five feet in diameter and one foot deep, multiply:  $300 \times 12 \times .0034 = 3672$  United States standard gallons.

To measure flowing water in ditches, canals, and rivers multiply the area by the mean velocity of its flow in feet per second, and the product is the volume in cubic feet; divide the number of cubic feet by 1.57, and the result will be the number of the miner's inches.

## CHAPTER XI.

### METHODS OF APPLYING WATER.



THE methods of irrigation in vogue are as varied as the topography of the country. So much depends upon the proper application of water that the practice of irrigation often results in failure unless it has received careful consideration and study. The amount of water a crop should receive, the time in its development to obtain the best results, the methods of applying water to different crops, together with that skill in accurate and economical manipulation which comes through practice and experience, are some of the important considerations.

It has been found that practically a 70 per cent. saturation of the soil will give the best results. Speaking in a broad way, a soil will retain its own bulk—not its own weight—of water, some soils more and some soils less. Now if fully saturated, and wheat, rye, orchards and vineyards are planted, they will not grow. But if the soil is given 70 per cent. of the water which it can take up, so that there is circulation of water and air within the soil, then the plants can take their almost infinitesimal drinks of water and grow with the greatest rapidity. The soil carries this water up to the plant and the plant uses part of it and evaporates it into the air.

Evenness of distribution is important. For instance, if there is twice the amount of water on one

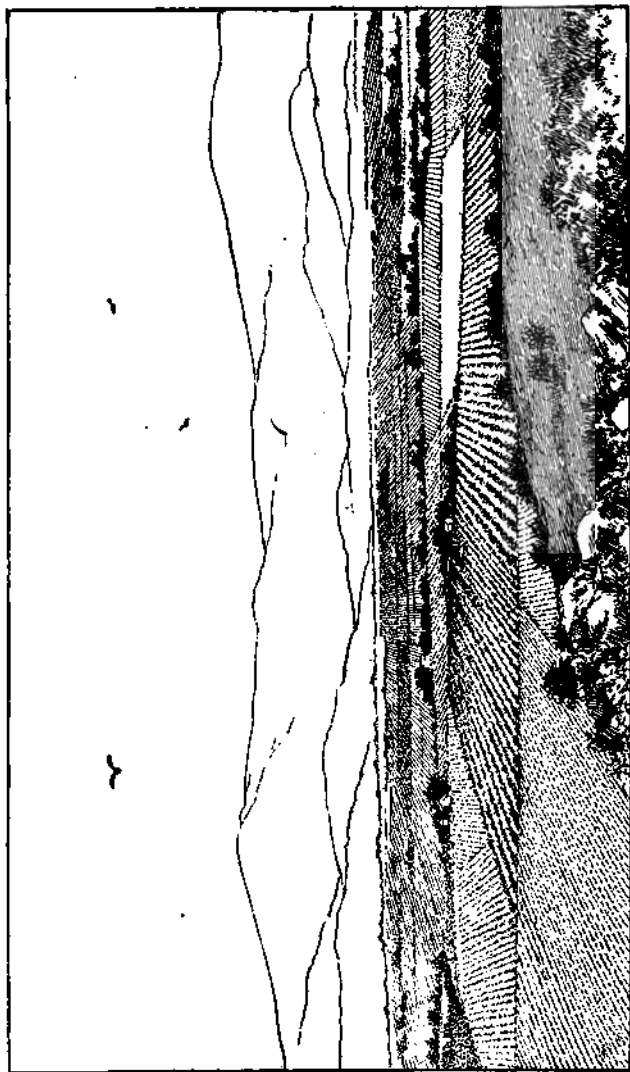
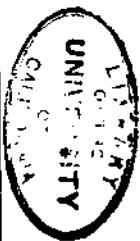

FIG. 46—BIRD'S-EYE VIEW OF A MODEL IRRIGATED FARM.



place that there is in another, the ground will dry unevenly, and the dry patches will be too dry before the wet spots are dry enough to plow, for in irrigating orchards, or any crop that requires cultivation, the plow or cultivator must follow as soon as the ground is in good working order. A bird's-eye view of a well-planned irrigated farm is given in Fig. 46. It will be observed that the land lies on a gentle slope, over which water may be spread with easy gradient and in equal ratio to all portions. The various plats may or may not be fenced, according to the owner's judgment, and in most cases fences are obsolete except for pasturage.

In the use of water it may be estimated that 1,000 gallons of water a minute will irrigate an acre an hour of row crops, such as potatoes, corn, etc., and it requires two men to handle this amount of water properly, as it is equal to ninety miner's inches. An inch of water nominally will cover an acre of land. The cost of irrigating an acre will vary all the way from 75 cents to \$1.50 for a season of 100 days. Water-rates in Colorado, where water is rented, are usually \$1.50 an acre per annum, and this rate is fixed by the county commissioners. It is a good rule, in the arid region at least, to have the water running constantly on some portion of the farm, although this is not an inflexible rule on account of the wastefulness which it entails. Old irrigators never shut off the water when a shower comes up. In all irrigating work it is well to imitate nature as nearly as we can. It will be well to remember in this connection that the soil must be adapted to the way, which on the other hand is itself not adapted to all soils.

**Subsidiary Canals.**—Where the supply canal is large and the banks thick, it is well to divert the water from it in only one place. A shallow subsidiary canal may be made parallel with it, into which sufficient water is allowed to flow to supply the laterals. It is very easy for a stream to get beyond the control of the

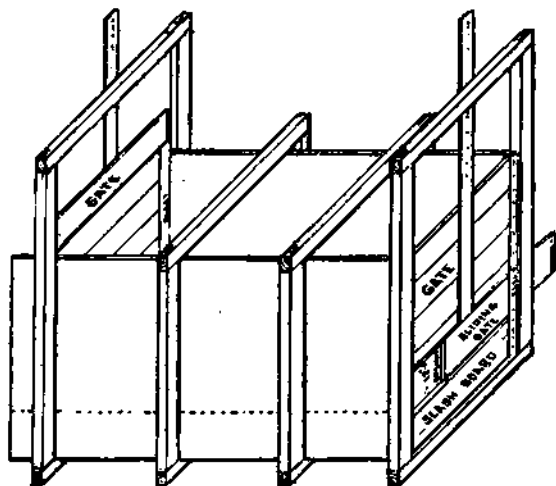

FIG. 47.—LATERAL BULKHEAD.

irrigator, and he must watch the aperture in the canal bank closely and take measures to prevent this. In the most primitive forms of irrigation the shovel is relied upon entirely for regulating the flow of water; but a step in advance is made by putting in wooden boxes at such places, with a simple gate board sliding between upright cleats. In this way the exact quantity of water desired may be diverted, without danger



that too much will force its way through. One advantage of these subsidiary canals is that it catches up the leakage of the main canal and utilizes it for immediate use, and at the same time avoids the discomfitures of seepage waters on the lands to be irrigated. Sometimes these secondary canals are cemented, and they are useful in governing the water for the furrows by means of bulkheads. These bulkheads may best be fixed permanently in position, and if supplied with sluice-

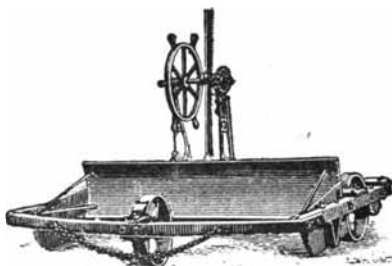

FIG. 48—IMPROVED STEEL LAND GRADER.

gates they are ready for use at all times, and will last for years. Fix these boxes in the lower bank of a subsidiary ditch at the head of the laterals—and they may also be used in the laterals for

the furrows just as well. A very good arrangement of this sort is described in Fig. 47.

**Preparation of Land.**—Little inequalities in the surface of a field give the irrigator more trouble in the flooding system than do large hills. They are too small to have any provision made for them except such as may be extemporized with the shovel while the water is running. When the surface can all be brought to an even grade, work is greatly lessened, water is economized, and the spotted appearance of the crop is avoided. Grading fields on any large scale has hitherto been impracticable, because no machine was made

specially adapted to it. One now invented and manufactured by B. F. Shuart, of Oberlin, Ohio, solves the problem. A good idea of this land leveler is gained from Fig. 48.

Hesper Farm, near Billings, Montana, on which this machine was first put to service, was graded by it so perfectly that the water when turned from the ditch spreads over the surface by the mere force of gravity, with a uniformity of effect which reduces the task of irrigation almost to recreation. On this farm one man handles 250 inches of water and has time to spare. Grading land practically dispenses with the incessant and exhaustive use of the shovel, incident to irrigating under ordinary conditions. On a well-graded farm the irrigator in applying the water has little need of his shovel, except for opening and closing again the banks of the ditches where he turns out the water. The even grade also makes it possible to run the water farther, and thus reduces the number of laterals necessary, and increases the head of water which can be used to advantage. Fifty inches is the head ordinarily used on Hesper Farm. With this machine one man with a team can grade from three to five acres a day on an average.

There are now other levelers in use, such as illustrated in Fig. 49, propelled by four horses, which will grade from twenty to twenty-five acres a day, and leave the surface in fine condition for seeding. In these the cutting blade is a 2 x 8 inch plank, twelve feet long, shod with a plate of steel six inches wide, one-half inch thick, and the length of the plank. This is suspended by coiled springs, is raised and lowered by

levers, can be adjusted at various angles, and loads and dumps automatically on uneven surfaces. The wheels on which the supporting platform rests are sixteen inches in diameter, fourteen feet apart, and the cutting blade occupies exactly the same relation to the soil that the bit of a plane does to the wood. It shaves it off and sweeps the loose earth along until a low place is encountered, when it slides out from under the blade and fills the cavity. The very same reasons that make this valuable to the farmers of the arid regions commend it to the husbandman of the humid states, for his fields are just as uneven, they encounter more moisture in a year than the irrigator ever applies, and crops suffer exactly in the same manner from the uneven application of moisture.

**Importance of Grading.**—Leveling should be the first step toward cultivating by irrigation. If one is going to use water, common sense will suggest that provision should be made for using it properly, so as to get the full benefit. Thousands of acres have been practically ruined by overwatering, or, in other words, by watering without leveling. Days and weeks of time are spent by farmers struggling to put water on the high places, drowning the lower parts and skimping the higher levels. A good watering should put on the ground enough to cover the whole surface at least three or four inches deep. It is evident that if one portion is over three inches higher than others, there is too little water covering the high spots and far too much flooding the sags. As soon as the earth fails to absorb the water it begins to dissolve the *alkaline salts* and bring them to the surface.

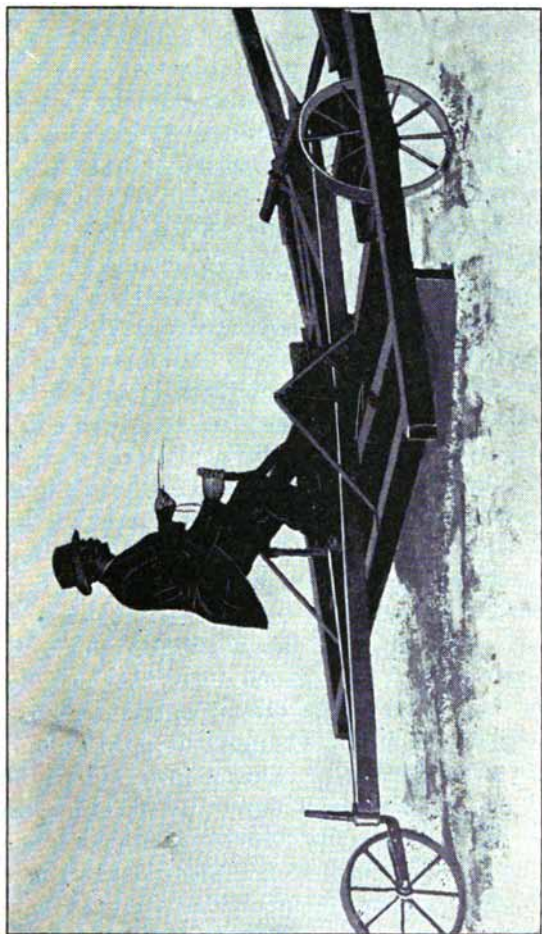

FIG. 49—A FOUR-HORSE GRADING MACHINE.

It is highly important to level all land so that the water will run freely across at uniform depth and velocity. Leave no low places anywhere, and especially see that no water stands at the foot of the field to make mud holes. A farmer near Springville, Utah, who planted fifteen acres of sugar-beets, started to level the land, and had completed five acres of it when the seeder came along, and so it was planted just as it was—in the usual way. The fifteen acres had precisely the same treatment. The five leveled acres yielded twenty tons to the acre on an average. The ten other acres produced but twelve and a half tons an acre. If the ground is watered uniformly and is properly cultivated it will make a fine seed-bed. If level and fine when the seeds are planted, they are all covered at the same depth, all will germinate under the same conditions, and the capillary attraction in the soil does its perfect work. The tender rootlets find nourishment and moisture, and make rapid growth. The plant that is well started makes vigorous aftergrowth, and the harvest finally tells the interesting story of increased product.

The laterals should be carried to the highest vantage-ground possible and should be opened at convenient points to allow the water to pass out upon the ground, and in this way it covers the field in seeking its level. The method of making laterals, especially as to the necessity of having them raised above the natural level of the ground, is described in Chapter VI.

**Time to Irrigate.**—Generally all ditches in the temperate zone should be ready to receive water by the

20th of May. The first water is turned upon the pasture, meadow, or orchard, just as it may be required. One year in the thirty that we have farmed in Colorado we commenced on the 24th day of May to irrigate, to germinate the grain that had been sown. We irrigated three times that season. We commence generally from the 10th to the 25th of June to irrigate the small grain crop. The matter of leaving water turned on is regulated largely by the condition of the soil. While some land will soak full of water in from ten to twenty minutes, another kind of soil may require as long again to soak. We turn the water on and let it stay until the ground is thoroughly wet and soft as deep as it was plowed—eight to ten inches—then the water is let out of the ditch a little further on, and so on until the field is all irrigated.

Every crop tells when it wants water. The grasses, clovers, and small grains have a language that cannot be mistaken. Whenever their green color becomes very dark and sickly turn on the water. When corn wants water it tells the fact by its leaves being curled up in the morning. Salsify needs but little if any water after it is well under way. Carrots cannot bear an irrigation by flooding after they are half grown. If covered with water the crowns decay. All species of the cabbage family require a good deal of water. In other words, they like wet feet, and are very particular how the water is applied. All plants in a dry climate should be pushed in their early stages of growth by a judicious application of the proper amount of water and frequent cultivations, at no time letting them stand, or go back from want of water and proper

attention. Plants in general need much less water than is usually applied by almost every one. They do far better and suffer much less with two inches on the surface applied two or three times during their growth than they do with twelve inches on the surface applied five or six times in a season. It is a sad mistake to put on too much water.

The determination of the proper time to irrigate and the amount of water to apply must lie for the most part with the farmer himself. The humidity or dryness of the atmosphere, as well as the position and condition of the soil, are to be well considered, and common sense is a better guide than is philosophy. If trees are allowed to get too dry the sap of the stalk commences flowing back to the roots, accompanied by falling of the leaves, and water is often turned on too late to save them. On the other hand, if too much water is applied it stimulates a too rapid growth, and the probability is that if not cut back and thoroughly hardened in the fall, they will be found in the spring to be entirely dead, or standing simply an outside live shell with a black and dead heart. Any one can easily learn just about the degree of moisture in soil necessary for the healthy growth of a plant, and the nearer uniform the condition of the moisture the more vigorous and healthy will be the plant.

The best time to irrigate is early in the morning before the sun acquires very great power, or in the evening when it is about to go below the horizon. A good time to water land is when a cloud comes up and a shower is expected. In nine cases out of ten the shower does not give all the water needed, so the work

will not be uselessly expended. Irrigation should not be done in the open when the sun is shining hot, as there is great danger of scalding the plants. If we have a good head of water in the ditch we prefer to begin irrigating at four o'clock in the afternoon, and often keep up the work as late as midnight, especially on moonlight nights. At the Utah station the temperature of plats irrigated nights was slightly higher than those irrigated days. The yield of grain was slightly greater on the plat irrigated in the daytime, due probably to the checking of the growth of the foliage. The total yield, or the yield of straw and grain, was some fifteen per cent. greater on the plats irrigated at night, and the ratio of straw to wheat was therefore much greater on the plat irrigated at night. Straw to bushel of grain when irrigated nights, 120 pounds; when irrigated days, eighty-nine pounds.

**The Flooding System.**—As already mentioned, the land must be prepared and made as near even as possible, by scraping down the knolls and filling up the low places so that the water will spread evenly. If it does not spread in this way the irrigator must follow it out with his shovel and conduct it to the neglected spots. The application of water to crops by the method of flooding is the quickest and cheapest, and hence is almost universally used for grass, meadows, and grain crops. On those soils which bake and crack badly flooding is injurious, unless the plants stand close enough together to shade the ground well. Water coming directly against the crown is unfavorable to the growth of many plants. It has often been noticed that millet, rye, oats, and other crops will be larger



and more thrifty a short distance from a ditch bank, where they receive all their moisture by seepage, than they will farther out in the field, where irrigated by flooding though kept sufficiently moist. Most gener-

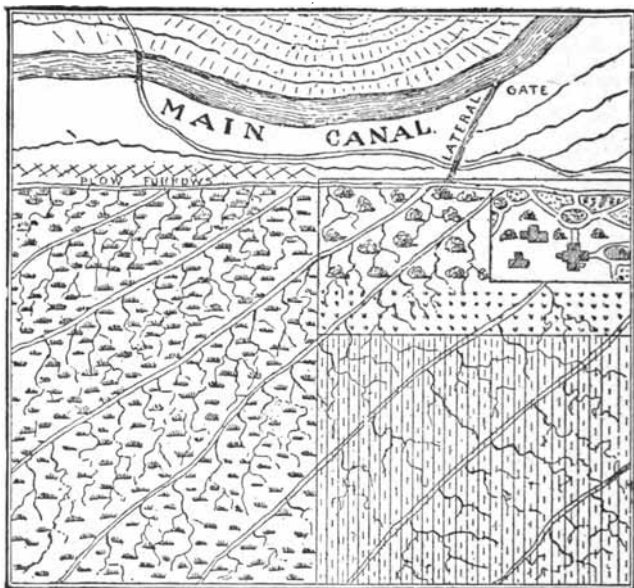

FIG. 50—DIAGONAL PLOW FURROWS ACROSS A FIELD.

ally in the spreading of water over farms—particularly those that have not been properly graded as described—plow furrows are run diagonally across fields, as outlined in Fig. 50. This system is the most practicable to use in flooding land. The furrows which distribute the water are run in such direction,

required by the lay of the land, as will give them only a slight descent. A hoofful or shovelful of earth thrown in the furrows at the entrance keeps them closed. When the land needs water the little gate or sliding board at the canals is raised as far as needed to let in the required amount of water. This is raised or lowered as may be necessary in the course of irrigating a field.

The lateral being filled with water, the irrigator opens the upper ends of the plow furrows by taking out a shovelful of earth. The little furrows then become filled. The water seeping through or running over the sides gently trickles along over the surface and soaks into the ground. Flowing thus from each side the waters soon unite between the furrows, and thus the moisture becomes uniform and general. The farmer may remove all obstructions by clipping off a bit of dirt at intervals from the sides of the furrows, and flood his land till the water will everywhere cover the surface. In this way he can in an hour or two give an entire farm what would be equal to a heavy soaking rain. These floodings are often given about the heading-out time, and the result is the production of heavier and more perfect grain. The water should be put on as rapidly as possible with no let-up—the quicker the better. It should not be allowed to stand in pools anywhere, because standing water stops all the pores in the soil, cutting off the air from the roots and, as it were, taking the life out of them for some time. Flooding requires more water than many other methods, but at the same time much less labor is needed, and it may be called the lazy man's system.

**The Dammer.**—An inexperienced farmer frequently attempts to force water over too great distances in irrigating a grain field by the flooding system. The plow furrows or diagonal laterals, instead of being from 50 to 100 feet apart, may be three times the distances, and in irrigating with a small flow it is difficult to cover all the intervening space. When the laterals have been made in the grain fields with a ditch plow, it is customary in some localities to run over them with an implement called a dammer, usually drawn by one horse, although a spiked team is often employed. The dammer consists of a large shovel attached to handles resembling those of a plow. As the horse travels, the shovel collects the loose dirt in the bottom of the double furrow, and when the driver raises the handles it is deposited in a heap to form a dam.

These dams are spaced from 40 to 75 feet apart, depending somewhat on the slope of the furrow. The object of these earth dams is to create a check, and, throwing out the water, permit it to overflow the lower bank. This being accomplished, the dam is broken and the unused portion of the water, together with the flow of the irrigation stream, is temporarily checked by the next lower earth dam. Little piles of manure or dirt may be placed in the furrows for the same purpose. These manure dams are not water-tight, but are made so for a short time by covering the up-stream face with two inches of earth. Much water is often allowed to run to waste by locating the field furrows on inclines too steep. In irrigating from steep furrows more dams are required and the water is all distributed from one point, whereas, on medium slopes,

it may be distributed from several points between dams.

**Furrow or Rill System.**—It is best to irrigate gardens and orchards by the furrow method. An even greater difference comparatively in the quantity of water used obtains in the furrow irrigation of fruit trees and vines than in the case of cereals. To such an extent does this prevail that not only do districts differ, but, of two neighbors who cultivate the same fruits in contiguous orchards, having exactly the same slope and soil, one will use twice or thrice as much water as the other. Judging as far as possible from conflicting testimonies, the cardinal principal appears to be just the same. As we have endeavored to show, it is desirable to have the lateral taken out of the main canal at a point higher than the grade of the ground to be irrigated. A practical example of this diversion of water is to be seen in Fig. 51, where a distributing gate diverts the canal water through a lateral to the furrows of an orchard. In garden and orchard work the character of the furrow is governed largely by circumstances, and the kind of planting will largely govern one's actions in laying out furrows. From a general head furrow smaller ones are run at right or obtuse angles into the plantation. A grade of one inch to the rod is usually sufficient, and an orchard should be set with this end in view. In the west we prefer to have the trees set closest together in the north and south rows, so that one tree shades another from the two o'clock sun, which in winter especially is very damaging to young trees. Always set orchard or small fruit rows to conform to the proper irrigating

grade, as this precaution will save much subsequent trouble.

A new furrow in orchards or vineyards should be plowed every time an irrigation is to occur, for the closely following cultivation which is the most impor-

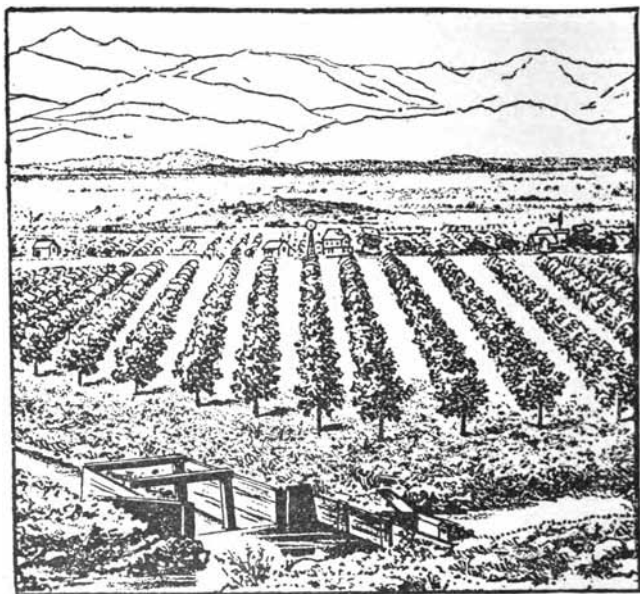

FIG. 51—DISTRIBUTING GATES OF IRRIGATION CANAL.

tant part of this work will close over and obliterate the furrows. Make a furrow on each side of the trees and give an irrigation that is calculated to carry the water well down into the soil—lower than the roots if possible, and for this reason the writer advises sub-soiling before the planting is done. The first year after plant-

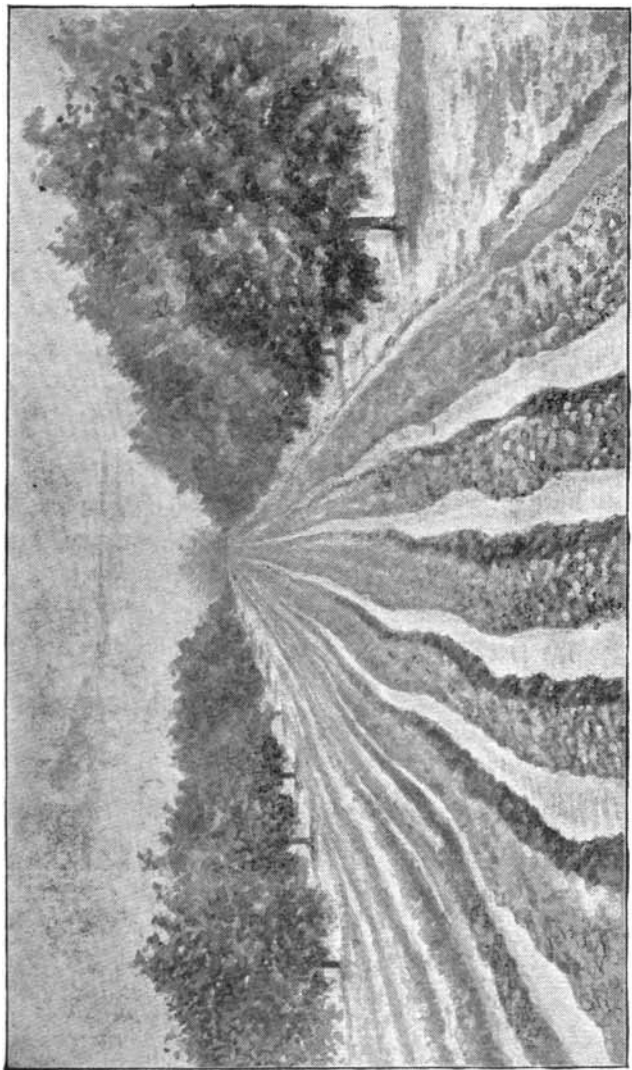

FIG. 52—PARALLEL FURROWS FOR A GROWN ORCHARD.

ing, the rill may be run within a foot of the trees, but the water should never be allowed to touch the trunks. Some horticulturists set out small fruits in rows four or five feet apart longitudinally with the trees, while others put such plants as raspberries and blackberries in the tree rows themselves. The advantage of the latter plan is that it affords more shade to the cane fruits, but at the same time they are more apt to receive less water than they need, as cane fruits require more water than is given to trees. By planting in the open between the tree rows cane fruits may be irrigated more frequently, and this can be done independently of the trees themselves.

As trees grow older year by year their furrows should be carried farther away from the trunks, a good rule being to keep them in a vertical line with the outer tips of the branches. With full-grown trees the irrigating should be done with several parallel intermediary rills, as pictured in Fig. 52.

This system is much in use in the citrus groves of Southern California. When the orchard is steep then plant—not in straight rows, but lay out ditches with a fall of one-quarter of an inch to every rod, and plant the trees along the ditches on the lower side. Professor Blount of New Mexico lays out his orchards on a grade of one inch to one hundred feet east and west, and on a level north and south. He admits water at the northwest corner of his quincunx plantation, and by double furrows his trees are irrigated on all sides, as displayed in Fig. 53, and by which means his root-lets are uniformly watered.

In all furrow operations it is best to allow the water

to trickle gently through them until the land is well moistened at a spade's depth between the furrows. Before allowing to dry, hoe back the earth into the furrows, and cultivate as soon as the land will admit. By irrigating in this way evaporation will be reduced,

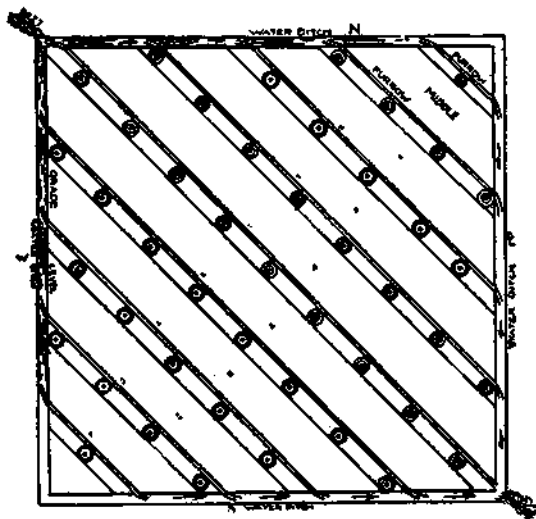

FIG. 53—DOUBLE FURROW ORCHARD SYSTEM.

water will be economized, the earth will be moistened to a depth of at least two feet, and one irrigation of this kind will last as long as two or three by flooding.

**A Caution Against Erosion.**—If the water is allowed to rush down the furrows so rapidly as to become turbid by picking up the finer particles of soil, these particles will be deposited farther down the furrows as the volume of the stream becomes smaller and the current becomes less on account of the absorption



of a part of the water in the soil traversed. This deposit of fine particles is apt to act as a cement to the furrows and prevent proper absorption of the water. It is possible by the very rapid use of water to cause it to flow through the entire length of the furrows without effectually irrigating the soil. The novice at irrigation is almost sure to be surprised at the action of an irrigating stream in the furrows in a soft, plowed field. If the stream is very small, it may entirely disappear in the first rod or two of the furrow. If the stream is too large, it may carry away a considerable part of the soil from the first few feet or few rods of the furrow, and, as already stated, flow through without accomplishing the purpose of effectually moistening the land.

A properly regulated stream should flow through a furrow without becoming very turbid at any point, and should progress continuously, though slowly, throughout the length of the furrow. After it has flowed for a time, varying with the nature of the soil from a few to many hours, the land should be so thoroughly irrigated as to make it, especially if newly plowed, too soft to walk over without miring. Where the soil is of open or porous structure and contains considerable vegetable material, this thorough irrigation may take place by the furrow system without greatly changing the loose and flocculent nature so desirable for the rapid growth of vegetation. This is the acme of irrigation. Not every soil will retain this open structure, even under the most skilful handling of water. With many soils it is found that the effect of the artificial application of water is much like that of an exceedingly heavy and dashing rain, solidifying the

soil by breaking down the open structure. It may be said that, as generally applied, irrigation is apt to leave the soil compact and in condition to become very hard as it dries.

**Underground Flumes and Stand-pipes.**—In Southern California, where water is scarce and most economically applied, the preferred orchard system is that of the underground lateral to convey the water to the place of its application. The scheme is to have the water delivered by underground cement or iron pipes at the highest point of each ten-acre lot. This delivery is ordinarily made by a cement hydrant or pipe, opening into a flume made of wood, brick, or vitrified pipe, extending entirely across the plot to be irrigated. If it be trees or vines that are to be irrigated, there will be from two to eight furrows plowed between the rows at right angles with the flume and extending in the same direction with the grade of the land. Flumes made of redwood either V-shaped or square are largely used, and opposite each furrow and opening directly into it an auger-hole in the plank is bored, which is covered with a galvanized iron gate set in a slide, the whole thing being cheaply provided but very effective.

The water having been turned into a flume from the hydrant, the slides over the apertures are adjusted so as to allow exactly the amount to escape that is desired. Slow saturation is the desideratum rather than sudden flooding, and by using these gates the flow may be adjusted to a nicety and the water then left to itself, no watching being necessary, and no constant labor with the shovel, as when water is applied from

open ditches. Sometimes a substantial flume of brick is laid in place of one of wood, and a square vitrified pipe with openings in the side is also highly thought of. A section of this terra-cotta head ditch is presented in Fig. 54.

Into this flume is turned from the ditch an irrigating head of 20, 25 or 30 inches of water, generally about 20 inches. This is divided by the holes into streams of from one-sixth to one-tenth of an inch,

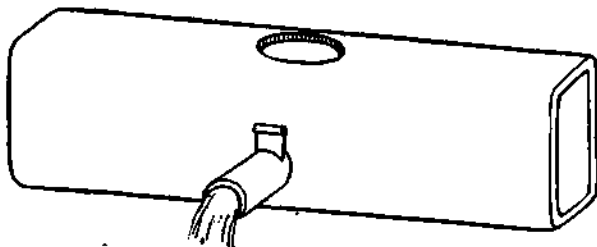

FIG. 54—SECTION OF VITRIFIED HEAD DITCH.

making from 120 to 200 streams. These are run across the tract in small furrows leading from each hole. From five to seven furrows are made between two rows of trees, two between rows of grapes, one furrow between rows of corn, potatoes, etc. It may take from fifteen to twenty hours for one stream to get across the tract. They are allowed to run from eighteen to seventy-two hours. The ground is thoroughly wet in all directions and oftentimes three or four feet deep. As soon as the ground is dry enough, cultivation is begun and kept up from six to eight weeks before water is used again. For trees a year

old one furrow on each side of the row will do, for two years old two furrows, and so on.

In many places the outlet from the underground head flume is through a series of stand-pipes. An improved measuring penstock consists of a four-inch iron stand-pipe resting on a six-inch vitrified service-pipe. At the summit of this measuring stand-pipe is a sliding gate on which is a scale so arranged that the amount of water flowing through it can be measured by simply reading the scale. A valve inside the stand-pipe is operated by a screw attachment and admits the proper amount of water, while it can be locked by a simple device. Outside the stand-pipe is a pressure-gauge which shows the head of water on a measuring slot with a glass face. This contrivance is used in measuring the patron's apportionment of water, and in this fact alone does it possess any advantage over the simple opening in the head flume for the escape of water.

**The Basin System.**—This method consists in making a small basin around trees, filling it two, three or more times with water as fast as it soaks away. These basins vary in size according to the amount of water one has. Where the supply is small they are often not more than two feet across, and even smaller for young trees. Where there is more water, many make them 10, 12, and even 15 feet across. Some make them square, others round, while others make them oval or rectangular. The plan is well shown up in Fig. 55.

In many cases the formation of these basins is very stupid. That trees treated in this way do anything, only proves that they would do better in other ways,

and does not prove that such is the correct way to irrigate them. For instance, allowing the water to touch the trunk of a tree is radically wrong. In the center of the basin should be left a mound of dry soil around the trunk of the tree, at least two feet in diameter, and three or more would be better. Instead of

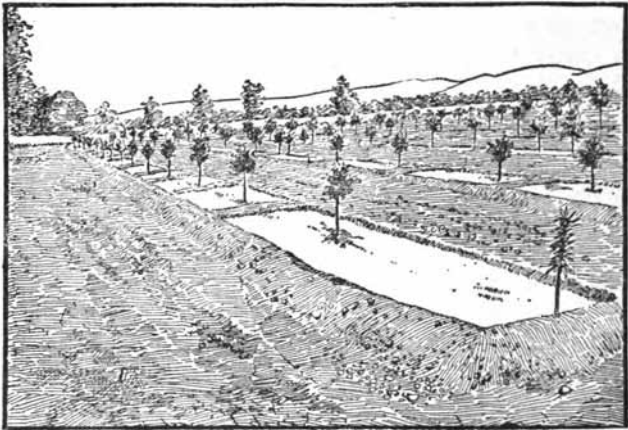

FIG. 55—THE BASIN SYSTEM.

heaving up earth on the lower side and making a pond of water, of which the pressure will puddle the bottom and prevent the access of air to the roots, by covering it with a hard, tight crust, the basin should be made in the form of concentric rings; or, where the hill is too steep in crescents, one above the other, and leading one into the other. The basins may be filled by hose, watering-carts, or by pipes, but the writer considers the plan scarcely worthy of adoption.

Another plan to convey water to the roots of trees

is to set a length of sewer pipe, or a two-foot box six or eight inches square, into the ground two or three feet from the trunk. Into this box water is poured until it is filled, or it may be conveyed in a hose and allowed to run for some time, so as to give the roots a good soaking. It is better to have three or four of these boxes placed around a tree, so as to distribute the water more evenly in the ground. This contrivance is seen along village streets where shade trees are grown.

**Borders or Checks.**—This is a cumbersome method of field irrigation in practice by Mexican farmers, but which is gradually going out of use. Each border includes a few rods only, and the borders are from six to twelve inches high, which would indeed interfere sadly with the use of machinery. The plats are filled with water, which is quickly run off from one to the other after a thorough saturation of the soil. If, however, the land is well leveled, five or ten acre patches instead of a few square rods may be enclosed with borders or ridges, which would be the improved American plan on a Mexican basis. These acres can be enclosed with borders made in such a way as not to interfere with implements. The borders can be made into gentle swells, eight, ten, or twelve inches in the center, and the base twenty feet. The object is to secure quick and thorough irrigation. Some have called it the checkerboard system, but it is the only one that native farmers know, and those crops that they attempt to grow are indeed very prolific.

**The Contour System.**—In California, where this plan is in vogue, it is in reality a modification of

the Mexican borders. The land to be irrigated is divided into compartments or checks, each of which is entirely surrounded by embankments of earth. The principal embankments follow contour lines, the vertical distance from one contour levee to the next being uniform, which is not always the case in the Mexican fields. The contour interval usually selected is six to nine inches, rarely so great as one foot. It depends in all cases upon the surface slope of the ground to be prepared for irrigation, and should be less than six inches if the ground is sufficiently flat to permit such an arrangement without making the individual checks too small.

For ground on a slope that would require levees more than one foot apart in elevation some other method of irrigation should be adopted. The strips of land between the contour levees are subdivided by cross levees into compartments of convenient size, which are generally called checks. Their area should vary according to the volume of water, a good rule for porous soils being not to exceed one-fourth of an acre for each second-foot when a large head of water is available and to make half an acre a second-foot the limit for a small supply. As after the Mexican fashion, water is supplied to the several checks in turn from highest to lowest in each series between cross levees. The irrigating lateral which leads from the supply canal is usually carried in the direction of greatest slope, cutting the several contour levees nearly at right angles.

Irrigation commences by turning a full head of water into the upper check upon one side of the irri-

gating ditch, as outlined in Fig. 56. This should be filled in from one to six hours. In the full check water should barely cover the highest portion of the ground, but stand six inches to one foot deep in the lowest portion of the check, according to the contour interval. The contour levee should have its top about

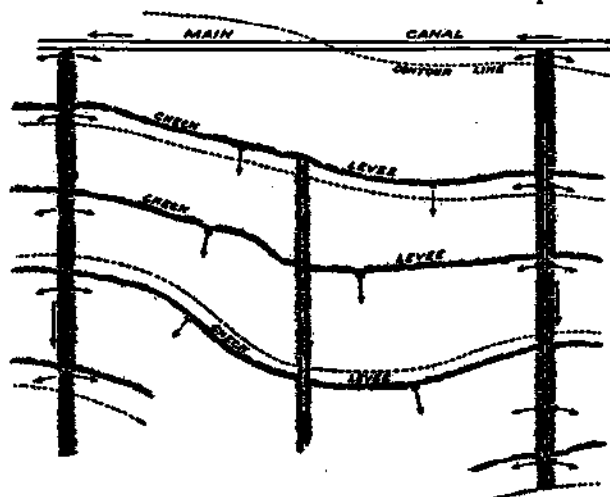

FIG. 56—CONTOUR OR BORDER SYSTEM.

half a foot above the water surface of a full check. When the upper check is entirely submerged, gates are opened from the irrigating ditch into the next lower check, those admitting water to the upper check are closed, and one or more gates in the contour levee between the two checks are opened to permit the surplus water from the first to drain into and assist in submerging the second one. This will require less time to fill than the first, because the supply of water from the ditch



is augmented by the run-off from the upper check. The irrigating ditches frequently replace cross levees, so that water can be admitted to a check from both sides at once. When the average time required to fill checks on sandy soils exceeds three hours, it may generally be assumed that water is wasted. Either the checks are too large or there is not enough water turned in. Heavy soils, however, do not take up water rapidly, and, aside from requiring more time to absorb water, they do not permit its flow to subsoils so readily as do sandy soils, consequently more time may be allowed to fill a check in clayey soil without undue waste. Twenty-four hours should be regarded as the permissible limit.

Checks are occasionally very large. One was seen in service having an area of sixty acres, but in this instance the land was exceptionally level. The water supplied to it was reported to have been as great as 250 second-feet. Such areas in one check are never advisable and are merely temporary features of a growing system. Eight to ten acre checks are large, and those of two to five acres are generally preferred.

Embankments around the checks may be either permanent or temporary. The latter are rare. Permanent check levees are made of two types, either with very steep sides and narrow tops, so as to occupy as little space as possible, or very broad and flat, so as not to interfere with farming operations. The flat embankment becomes a part of the cultivated area and generally is the most productive part of the irrigated field. It is constructed by scraping up material from a broad area on both sides if the ground is nearly level, or from

the lower side only if the ground is comparatively steep. The cost of preparing land for this method of irrigation in permanent checks ranges from \$2.50 to \$5.00 an acre, the cost of the necessary distributing canals, ditches, and structures from \$3.00 to \$5.00 an acre. These figures, of course, may be greatly exceeded if the ground has too great a slope or is very much broken by hog-wallows, or swales and ridges. The only work required of attendants is the opening and closing of gates and the guarding of the check levees. When ground is well prepared for this method of irrigation and the supply of water is abundant, the cost of each application of water will range from three to thirty cents an acre.

**Sprinkling.**—In Florida most of the irrigation is of the sprinkling order and is best described by George W. Adams, of Thonotosassa, who says: "I have a twenty-five horse-power horizontal boiler and a 12 x 7 x 10 duplex pump, with six-inch main pipe and three-inch laterals at the main and running down to one and a half at extreme ends. My trees are twenty-one feet apart each way. I have a hydrant in the center of every sixteen trees. I use the McGowan automatic sprinklers, connecting the sprinkler with hydrants by a one-inch wire-wound rubber hose fifty feet long. I use twelve of the sprinklers at one time and could use more just as well, each sprinkler staying in place thirty minutes, each one covering a space of from fifty to seventy feet, according to the amount of pressure given them, and discharging about 1,000 gallons. By this process I have a genuine rain, either a light one or a powerful one, at pleasure. If I wish to

throw water over the tops of the trees, I use the nozzle instead of sprinkler. I run the pump from 7 A.M. to 6 P.M. without stopping, using less than one-half cord of wood in eleven hours. I find no bad results from applying the water in the hottest sunshine, but would if I applied it through an open hose. I think the sprinkler method of applying water requires less help



FIG. 57—IRRIGATING WITH A HOSE.

than any other I have seen, and is without any danger to fruit or trees. The fireman can manage the sprinklers within reasonable distance of the pumping station. For other portions only one man is ever needed and it is light work for him."

While using the hose in irrigating fields with an underground pipe system to supply the water costs more at the beginning, it often proves less expensive and much more satisfactory in the end. A field irrigated in this way is illustrated in Fig. 57.

**Hillside Methods.**—In irrigating hillsides great

care should be exercised lest much of the best soil as well as the manures applied be washed away. With slopes at all pronounced, great care should be taken to draw the irrigating furrows across the slopes in such



FIG. 58—IRRIGATING A HILLSIDE.

direction as may insure a proper flow without the danger of washing. No definite rule can be given for this, but a little experience and training of the eye, to judge of the proper declivity to insure a safe flow of water, will soon tell the careful cultivator in what direction to run his irrigating furrows, if the water be applied

in that manner. A study of Fig. 58 gives one a practical idea as to how these furrows may be run and manipulated. Flooding from one furrow to another is a very simple matter and requires only a little experience on the part of the irrigator.

It is, of course, understood that the furrow must have some fall in order that the water will flow through it, but it should be very little. On an easy grade the ground washes less, and when a check is put in a ditch that is almost level the water will flow over its sides for considerable distance and so gently that it will scarcely wash the steepest hillside, whereas if the laterals run down the hill, as many farmers arrange them, the water when dammed flows over for a short distance only, and pours out all in a body, washing very heavily. Some farmers persist in running their carrying ditches for steep lands around the hill, while the laterals run straight down the slope. It is the plan of some to run the main carrying ditch down the hill, as it may be protected with boxes and gates at the places where the laterals turn off, but the latter should circle around the hill with just fall enough to carry the water. It is a foolish idea to lay off laterals with the fences. If more attention were given to this matter irrigation would be a simple and easy thing. Potato rows and other crops that are not flooded but irrigated in furrows should also be run with the lay of the land.

To raise a hoed crop on a steep field requires great pains and ingenuity. If the surface is not wavy as well as steep, the rows can be run diagonally, as described, across the slope, so as not to give too much fall, which would make the bottoms wash away and

lower the water surface, so that the rows are not moistened underneath. Some farmers run the rows directly down a steep slope, and in irrigating let a tiny stream trickle down the rills for a day or two, thus succeeding in having the moisture penetrate the rows. To make the water enter so many rows at once requires a very level head ditch, or the greatest pains and ingenuity in the way of checks to effect that end. The idea of tiny rills under these circumstances is best exploited by putting in lath funnels at the top of each row, as described elsewhere in this work. In an irrigated country there is natural prejudice to hillside farms. Still, if the soil is a stiff clay it may be irrigated by flooding without tearing to pieces, even if rather steep; but in this case it is next to impossible to spread the water so evenly and thinly that the soil can absorb all that is applied. Hence usually a large part of that used runs off into hollows and draws, and is lost to the user.

Along the line of many irrigating canals, large tracts of land are often found which have a decided fall or are rolling. Where this occurs in large tracts, the expense of terracing is generally too great for the average farmer, and a system whereby the distribution of water can be assured suited to the contour of the ground must be devised. On land sloping similarly, as

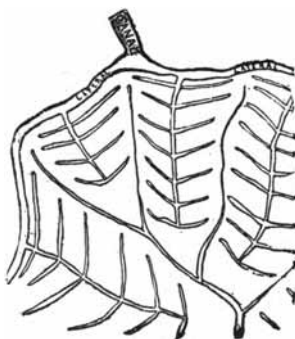

FIG. 59—A PLAN FOR WATERING ROUGH LAND.

shown by Fig. 59, the water enters the distributing ditches at the upper left-hand corner, and, dividing, flows through these into the still smaller ditches, from which it is turned laterally into furrows. Little dams or temporary obstructions of earth check its flow from point to point. After water flows out upon a field, any surplus can be caught by small trenches shown in the figure as trending diagonally toward the right-hand lower corner. From these trenches the water can be turned upon the lower fields, so that the excess or seepage is not wasted, but is employed on the less elevated tracts. In cases of inadvertent pitch, as sometimes occurs in furrows for street irrigation, the danger of washing can be controverted by putting in permanent sunken sluices. When it is necessary to irrigate a tree along such a sluiceway the water can be led out in a sufficient quantity by boring an auger-hole in the bottom of the sluice two feet or so above the tree. When water is not needed to irrigate the tree in this way the hole can be plugged.

**Backsetting.**—In Western Kansas a primitive system of subirrigation by damming a stream in a flat country and forcing the water through the adjacent lands by percolation is somewhat relied upon, but will not become generally adopted. The water is dammed and simply forced out through the banks into the ground, and in this way subterranean moisture is afforded the surface soil to produce good crops. The plan is rather too expensive in dam building to make it very popular, and the operator having no control over the seepage tide would soon find his ground waterlogged and too wet for ordinary farm crops.

**Fall and Winter Irrigation.**—In many sections of the west the system of fall irrigation has been practiced with good success. After the crops are all harvested the water is turned on and the soil is given a thorough soaking. Subsoiling greatly enhances the value of winter irrigation, which furnishes moisture for the starting of plant life in the early spring, and causes the weeds and other remnants of the cropping season to more easily decay and act as a top-dressing or fertilizer. The land is also put in good condition for plowing early in the spring. But very few crops should be irrigated from the time of planting till after the plants have had several days' growth. Fall irrigation supplies moisture sufficient to start the crops and gives them a vigorous growth of a few weeks before irrigation is necessary. It is better for young plants to have the moisture come from beneath than from the surface, especially in the early spring, when water for irrigation is several degrees colder than that stored in the soil by irrigating late in the fall.

We have found in Colorado that irrigation may be applied advantageously before the regular cold days of winter set in, and this practice is adopted generally by successful cultivators where water can be had at that time of the year. The late irrigation is useful after a dry fall, and is especially to be commended in the preparation for crops which require the maximum amount of moisture, and for orchards, or where the water-supply is likely to be short the coming season. It places the land in the condition of a storage reservoir for the succeeding season, and experience has shown that the soil that has received a thorough irrigation in the fall

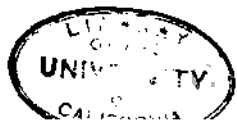



or early winter has great advantage over ground that has not. This is true when land is fall-plowed, and the water may be applied either by rills or by flooding. Let it be a good deep soaking. Orchardists are generally adopting this plan for their trees, and thus the evil effects of winter drying are circumvented.

**Foreign Methods.**—In China a very primitive way of irrigating is in use. A Chinese farmer's estate is usually a sandy plain with slopes from one end to the other. His first step is to divide it into counter-parts by raising low walls or partitions of clay. They are usually a foot and a half thick and two feet high. Where it is difficult to get clay he constructs the wall of the stones he finds in the soil, or of broken bricks and tiles, and stops up the crevices with clay or even mud. Any form of soil excepting sand is used in this manner. He even gathers the ooze bared by the low tide with which to build the walls. In each little compartment he builds a ditch in front of the lower wall, and at the corner of the compartment he lowers the wall somewhat for the water to flow from one check to the next adjoining, very much as is done by the Mexicans. When it rains the compartments fill, and the entire field looks like a lot of panes of glass; the water soaks slowly into the soil and keeps the ground moist enough for agricultural and horticultural purposes for several months. For the irrigation of rice lands, which have to be submerged, the lands are divided into small patches at large levees, so that the appearance is that of a beautiful system of terraces, near a bountiful supply of water, which is raised to the upper level by chain-pump and treadmill process with coolie power.

In places where there is a scarcity of water the men and women carry, suspended from a yoke across their shoulders, two large buckets with long spouts, and sprinkle rows of vegetables copiously. Sometimes the water for this purpose is carried in buckets a considerable distance. Liquid manure is applied in the same way.

The irrigation of Egypt is now conducted on a scientific basis. The whole country is cut up into canals, and there are immense irrigating works in the delta which, during the inundations of the Nile, require hundreds of thousands of men to manage them. An immense dam extends across the Nile near Cairo, which raises its waters into a vast canal through which they are allowed to flow out into subordinate canals over the great delta. There are some steam-pumps used in Egyptian irrigation, but by far the greater part of the country is irrigated now as it was in the days of the Pharaohs. This is by means of the shadoof and sak-iyeh. All over Egypt may be seen men naked to the waist standing knee-deep in water with a basket-work bucket hung by ropes between them. With a swinging motion they scoop the water from the river into this bucket and swing it up to a canal on a higher level, whence it runs off into the fields. The water is often drawn from this canal into a higher ditch in the same way, and thus by a series of planes it is conducted so that none is lost. After the water is taken out of the great canals it is spread over the fields in little ponds, and the flat fields are often divided into small squares by means of embankments of earth one foot in height which run around them like fences, and

which can be opened or closed to regulate the height of the water within them. The rising of the Nile begins in June, and during the summer much of Egypt is one vast lake. It remains so through September, and subsides toward the latter part of October. It is at this time that the water is conducted into this vast network of canals, and is carefully carried over the cultivable lands.

In Spain the system for irrigation of meadow lands most commonly applied in the northern provinces is by inclined channels or the system of spiked channels. The distribution channels are devised nearly in the sense of the greatest slopiness of the grounds. The irrigation channels connect with them and spread out from right to left. A rapid sectional change takes place in the distribution channels at the point where they separate into branches with the irrigating channels, which by having a gradually narrowing section from their parting point down to the end, pour out the water by getting inundated.

Another contrivance is also combined with this distributive system, which consists in collecting channels, called *azarbes*, dug on the natural lines of junction on the meadow ground, terminating in an outlet channel. Sometimes when the extent of the meadow is not considerable, or when the quantity of water available is but small, the collecting channels are changed into new feeding channels for the supply of other lands situated farther down. They level off the ground so that the water can flow over it easily, without leaving standing pools and mud, or washing out the ground and forming gullies. They prepare their lands so that

the water will flow over them easily and safely. They also construct their lateral ditches very well, and when they are through with the water the supply is turned off. They never waste it. They have only a few small reservoirs.

In Australia much of the interior land is irrigated mostly through the medium of billabongs or lagoons that are oftentimes supplied from natural streams during the rainy season. The water is applied to the lands much the same as we apply it. In other countries along seashores a system known as warping is customary. By this mode the tides are received through an embankment or dike and retained until the sediment or warp is deposited. Subirrigation is a system that is practiced in all countries, including our own, and as it is of much importance as to detail the writer will treat it in a special chapter later on.

## CHAPTER XII.

### IRRIGATION OF FIELD CROPS.

**T**HE application of water is the one thing important in all irrigating operations, and must receive the most careful study and consideration. Every man must be his own preceptor to a great degree, and it is only the general rules that will be useful to him. The mechanical part of the science of irrigation is easily learned and quickly understood by the novice. There is a branch of the science, however, not so quickly mastered, because not fully understood by practical farmers—the quantity of water which any given grain or vegetable requires. No fixed rule as to quantity can be given because the nature of the soil, lay of the land and the season all tend to modify the amount required. The relative amount, however, can be ascertained with a fair degree of certainty. Experience shows that it is easy to exceed the quantity required by the crop, and that every excess is injurious. Extravagance is the common fault, so much so that the most successful irrigators are invariably those who use the least water. Cultivation, too, is a primary factor to the attainment of the fullest success in the magic art, and on this account the writer is constrained from time to time to digress from what may seem to be the real text of the subject.

The irrigator will find that new land requires more water the first year than the second. Grain is irrigated two, three, or four times, according to circumstances. As we have said before, the best results are secured by using a moderate quantity of water. A Mexican irrigates four times and gets twenty-five bushels of wheat to the acre. An American irrigates three times and gets thirty-five to forty bushels. Another farmer irrigates twice and gets fifty-five bushels to the acre. An ordinary laborer irrigates fifteen to twenty-five acres in a day, though much more can and is often done, while thirty to fifty acres are irrigated by some farmers.

**Wheat.**— This crop should never be sown on low land—not even second bottom—but always on high land, plateaus, or mesas. Where drainage is naturally good a deeply mellow soil is not the best, as some advocate. A good seed-bed is absolutely essential, but the surface in rainy sections should be left quite rough for winter wheat, because it prevents the roots from being broken and dried out when the heaving of the soil in the early spring takes place; and the ground should never be rolled where spring wheat is sown, in arid climates especially, because the heavy west winds will cut the crop entirely off.

It is always best to germinate sown wheat if possible without resorting to the expedient of irrigating it up, as is sometimes done by careless farmers. The ground should be in good moist tilth before the seeding is done, and if the rains have not been of sufficient quantity to supply the necessary moisture the field should be given a good flooding of from six to ten

inches in depth. After a good harrowing the seed may be planted with a press drill, using from 60 to 75 pounds to the acre. The use of the press drill obviates the employment of a roller, which is really superfluous where the crop is to be irrigated. It is an object to have the grain germinate as quickly as possible in order to outstrip the weeds. Here in Colorado we plant wheat early in April and it comes up inside of thirty days. If there is good moisture in the soil no water is needed until the last week in May, and some men make it a rule not to irrigate the first time until the grain is five or six inches high. One good reason for not irrigating a grain crop earlier than the twentieth of May is because early in the season the water is cold and consequently chills the crop. Another objection to irrigating before the plants cover the ground is that flooding bakes the soil and prevents a free circulation of air. There is still another important reason. When the soil is moist near the surface the plant does not send its roots down as deeply as it would if the supply were stinted, and hence has not abundant supplies from which to draw. A month after the first irrigation the crop may need water again, if there have been no rains in the interim, but this matter can be determined by an examination of the soil. The second irrigation will require not more than half the water given in the first application. It is a great advantage to keep the plants growing steadily during the early period of growth.

Some irrigators are in favor of giving a third wetting—not a very heavy one, however—just as the grain is heading, claiming that this practice makes larger

berries and a grain yield of more specific gravity. Overwatering at this time may cause rust, and great discretion must be used as to the water at this period.



FIG. 60—IRRIGATING A GRAIN FIELD.

If the ground is moist it is not necessary to give the heading irrigation. Fig. 60 shows the process of flooding a wheat crop from a field furrow, the irrigator throwing in a diverting check of earth to flood the field laterally.



If the first irrigation is late and there is a good deep compact subsoil, one irrigation will usually make a crop, and we would rather have one twelve-inch irrigation than two six-inch ones. The surface can be covered with six inches if the incline is steep, and on such a surface it is best to irrigate light and often, as by running heavy heads for a considerable time the plants may be washed out. On the upper bench lands of the west, when fairly level, two irrigations are all that is needed, and with only one after three years of cultivation there is no danger of a complete failure of the crop.

Professor Blount, who is the best authority in the world on wheat growing by irrigation, advocates the cultivation of wheat by the ridge system. He says: "Wheat in ridges with furrows between will pay many times over all the extra cultivation and expense. The ridges should be twenty inches apart, running north and south, so that the sun may get in upon the roots during the later growth. On these ridges, which are two and one-half inches high, choice selected grain should be planted by hand—if planted early there is generally enough moisture in the soil to germinate every grain. Winter wheat wants but little water after November. Spring wheat needs the first irrigation about the time it is undergoing the process of stooling. The cultivation may be done with one horse and a small plow with guards to keep the dirt from covering the growing grain, or it can be done with a hoe. The furrows between should be kept open and clean so that the water when applied may run below the top of the ridges all the time and do its work

among the roots, and never on the surface. This plan requires only nine or ten pounds of seed to the acre and the yield will be just as great. It must be understood that wheat planted in this way will tiller in such manner as to increase the yield."

Before passing the subject the author desires to again express the caution about irrigating a seed-bed too prematurely in the season. It must not be forgotten that the first watering should not be given until the young grain covers the ground fairly well. Flooding the land while the wheat is very young and tender has a tendency to bake the ground, especially with the adobe soils, of which so much of our western land is composed. When the grain covers the land properly, the sun's rays do not strike the surface and it remains moist for a considerable length of time. Then again the last application should be given when the grain is in the dough. If applied later than this, it does little or no good.

To facilitate irrigation it is well when the grain is sown in the spring to use a corrugated roller, so that the rims of the machine will make parallel irrigating trends five or six inches deep in the field at the one operation of rolling to firm the seed-bed. These rollers are much used in Western Colorado, but for the reason that they are difficult to manufacture from wood in a home-made way they are not employed nearly so generally as they would be if cast in iron so as to be more weather-proof. These rollers should be weighted from 500 to 750 pounds, and it will usually require a spiked team to operate them. A description of this valuable implement will be found in the chapter

on "Devices and Appliances," with an illustration showing the machine at work.

In lieu of one of these implements it is advantageous to use a horse marker, something after the style of the old corn marker. Take a straight log some six or eight inches in diameter and twelve feet long. With a two-inch auger bore holes for the teeth two feet apart. Make the teeth a foot long, having them flat and about as broad as a man's hand. Turn the flat side forward. Be sure to set the teeth so that they slope backward. This will prevent the seed being torn out of the ground. The extra labor in going over a field with such a marker will save a vast amount of work when irrigating time comes, as the water will follow the small furrows made by the teeth and at the same time seep from one to the other, so that the ground will all be watered and there will be no sun-baking at the surface.

**The Depth of Soaking.**—In the absence of some methods of surface corrugation we will presume that the irrigator knows how to make the old-fashioned ditches through the grain fields. The water being turned into these ditches, all that is necessary to do is to put checks in them in succession so that the later check will make the water overlap at least ten feet the land wet by the flow from the preceding dam. Dams are now nearly always made by means of canvas nailed to a pole or board wide enough to rest well on each bank, and which is fully described in this work under the chapter on "Devices and Appliances." If the current is not very rapid, but little earth is needed on the canvas, as the weight of the water on the lower up-

stream edge will hold it against the down-stream pressure. Some use two of these canvas dams alternately for each ditch that may be running, and an active man with a sufficient head of water can run three ditches abreast, while others are using only one for each ditch, as the check can be put into a running ditch by cutting the bank, placing the pole between the cut and stepping with the edge of the canvas up-stream, holding it there until some dirt can be shoveled on the lower edge in the water. It might be said that such ditches as we use in wheat-fields of fair or usual fall will run about a cubic foot a second, or, in other words, full water rights for 160 acres will supply three ditches which will water six acres. This will be about eleven inches deep. This is more depth than is usually needed for one irrigation.

If the land is plowed deep, say ten inches, the land cannot be covered evenly with less head. It will take at least six inches to wet the top soil, as it has first to be wet in order to have the water flow over it readily. When water is put on a loose, dry surface it creates a wet mush, and the water will immediately penetrate as deep as the soil is loose. Such soil will contain a much greater per cent. of water than a compact, moistened subsoil. Assuming that the water is allowed to run for two hours, as it ought to to reach any considerable distance from the dam on comparatively level land, and all the time it is settling into the subsoil, which we will say is to the depth of two feet, this soil will take another six inches of water, making about a foot in all to wet the land three feet. All this will be supersaturated, and in a few days it will reach

the depth of four feet. In this way it will be seen that it will take about two weeks to get over eighty acres. Generally speaking, the best growth is obtained when the grain appears to suffer before it is irrigated the first time.

In clay soil the largest yield of both wheat and straw was once obtained in an experimental way by saturating the ground with nearly twenty-seven inches of water during the season. On this soil there was a decrease of crop when either a greater or less amount of water was used. This maximum yield was brought about by the use of nearly twenty-seven acre-inches, which is equivalent to a cubic foot a second for nearly twenty-seven hours. On clay soil containing more sand the yield of wheat increased as the water increased up to forty inches. The largest yield of straw was produced with sixteen inches of water, and in actual usage no practical irrigator would think of requiring more water than this. It seems preposterous in actual practice to apply such a needless quantity as forty acre-inches in one season, and even twenty-seven inches seems entirely beyond the requirements of common sense.

When much moisture—rain or irrigation—is applied to the growing crop the bran of the grain is made thicker and the flouring elements inferior. The least possible amount of moisture necessary to mature wheat makes the grain superior for milling purposes. This applies not to wheat alone, but all grain and forage plants as well. Too much water invariably dilutes or diminishes the feeding value of all plants. In arid climates all kinds of wheat become hard and flinty, so

much so that the miller finds it necessary to thoroughly wet the grain before grinding. This wetting process makes the bran tough, so that it is removed by means of the rollers almost entire.

**Wheat by Subirrigation.**—The preparation of the soil for a crop of subirrigated wheat should begin ten months before sowing the seed. If peas were raised as a hay crop on ordinary far-western mineralized land the year previous, the grower would secure the double benefit of a large amount of cheap forage and an increased yield of wheat. In the subirrigated district of the San Luis valley, in Southern Colorado, where this system prevails more extensively, perhaps, than any other place in the world, the land is flooded in the early spring while water is abundant and carries sediment for enriching and settling the soil and germinating weed seeds. When the weeds are three to six inches high, plowing is begun with four horses abreast and a double plow, turning the soil from four to seven inches deep. No harrowing is necessary and very little is done except where weeds spring up on the summer fallow, which is seldom the case. The land is left without further care until the following fall or spring, when vitrioled wheat is drilled in at the rate of sixty pounds an acre. The drill is set to run three inches deep, or as deep as is necessary to put the seed in moist soil. As soon as convenient after drilling the field is ditched for the subbing.

If not previously done, a head ditch is made along the highest side of the field to receive the water from the supply lateral and distribute it to the irrigation trenches. These latter are made in parallel lines from

the head ditch to the extremity of the field and at such distances apart and of such size as the condition of the land determines. Generally, however, they are made from five to sixteen rods apart, leaving an equal number of acres in each land. Having made all the ditches necessary and received a supply of water, a small stream is turned from the head ditch into each irrigation trench, and regulated from time to time until the supply just equals the amount of seepage, leaving no water to overflow on the field or to waste at the ends. The flow of water is continued in the trenches from one to four weeks, or until every part of the field shows moisture at the surface. Water may then be shut out of the field entirely. Should the season bring a few showers no further application may be required. The need of water may be tested at any time by brushing away the surface soil in any part of the field that looks suspicious. Reasonably moist soil should be found at two inches depth.

**Oats.**—The secret of raising oats successfully—as with almost all spring-sown crops—is found to consist in the quick germination of the seed, a rapid and healthy growth during the first stages, allowing no backset, and careful attention to the cultivation and irrigation. Oats require more water than does any other grain crop, and in very dry spells they may be irrigated in the earlier stage of growth every two weeks. The general treatment is the same as for wheat, only that greater quantities of water are usually needed. It is well to plant early, so as to get the benefit of snows and rain, that the seed may germinate of its own accord. When six inches high the principal

wetting should be given, and an acre foot is not too much water to apply at this time in the arid region, especially on sandy soil. Some people irrigate almost continuously from the time the crop commences to head until the grain begins to turn. The claim made is that the practice checks the first stand and forces the grain to root, stool and head more abundantly. The only objection to such copious irrigation is that it conduces to the smut or ergot evil.

**Barley.**—Barley is an easy crop to raise, yet a little disagreeable on account of its beards. It grows quickly and matures early, and requires but half the water for irrigation usually given to oats, and considerably less than wheat. On an average it will produce many more bushels to the acre than will wheat, and brings a better price. For the best success the land should be plowed moderately deep in the fall, then pulverized thoroughly in the spring, and the seed put in early with a drill. Spring plowing will do, but not quite so well as fall plowing. Irrigation is quite essential while the grain is filling and during the early ripening period. One and a quarter bushels of seed on rich land is a sufficiency to sow, and a good seed-bed is quite as necessary as any irrigation that may be given it.

Black barley is said to have many advantages. It yields more to the acre than any other barley. But this is not its only good feature. It can be grown with less irrigation than can wheat, other barley, or oats. If sown early and watered plentifully until the first of July it will then head out and yield a fair crop without further irrigation. This has at least been our experi-



ence with this grain. The straw does not grow as long as other grain, but notwithstanding dry weather the heads will usually fill.

We have noticed that farmers are often inclined to slight the barley crop, and when water is short give it to other fields. One peculiarity of barley is that it does not show to the eye the need of water until it may have suffered beyond redemption. When barley grows with a shortage of water it retains its natural color, but fails to grow long straws and stools but little. It throws all its strength into forming heads, and these begin to show at scarcely eight inches above ground. Water applied at this stage will carry these heads on to ripeness, but will not produce much more growth of straw, no more stooling, and the heads will have but few full kernels.

Barley prefers an open, warm soil, tending to clay rather than sand, with good drainage. The Californians of later years have come to the conclusion that barley is best of all the grain crops as tolerant of alkali. Professor Hilgard has maintained that while sugar-beets and wheat will resist from 18,000 to 20,000 pounds of alkali to an acre, barley will withstand 32,000 pounds within a depth of three feet. Barley does better on rich soil and thrives well on land the first year after treating with stable manure, but, of course, in this latter case the crops require much more care in the irrigating and considerably more water. When well fed and watered the growth is enormous, and the probability is that some of it will lodge. Still, lodging does but little damage. The heaviest yields we have ever seen were from stands badly lodged.

One in particular lodged quite badly and went down flat, but the last few inches of the stalk turned up enough to keep the heads off the ground, and though difficult to cut and bind, the grains were plump, well filled out, and the yield was enormous.

**Rye.**—Of all the cereal crops rye will need a lesser quantity of water and will take care of itself where other things will fail. With a reasonable amount of moisture for germination rye will often get along with but one light soaking any time during its half growth, but if the plants are lagging and seem inclined to dwindle they may be irrigated at any time, and once a month with a medium wetting would do no harm.

We have found that in the absence of adequate rains land to be sown to winter rye should be flooded with five inches of water before plowing the ground preparatory to seeding. As soon thereafter as the ground is in order, plow and follow with a harrow or other suitable implement to pulverize all clods. The ground will then be in excellent condition to seed, which should be done with a press drill, preferably run northeast and southwest. No more water is required until just before freezing-up time, when a flooding equal to three or four inches of water should be given the rye fields. Generally this is done about the last week in November in Colorado. Again in the spring, as soon as frost is out of the ground, give another flooding of three or four inches. Once more only, and just when the first indication of heading is seen, give the last flooding of three inches, which completes the irrigation. These rules will apply to winter wheat as well.

**Corn.**—The preparation of the soil before planting has more to do with the outcome of the crop than any other operation. Corn roots have the habit of growing downward as well as branching. They are deep and broad feeders, in consequence of which the soil must be made loose and mellow to a considerable depth to secure full development. Land for corn should be plowed to an average depth of ten inches or more for this and another very important reason. Those familiar with the conditions of irrigation know with what rapidity a compact soil loses moisture. Land should always be well irrigated before plowing, if not sufficiently moist. As irrigation restores the soil to its former compactness, it should never be applied upon soils freshly plowed and prepared for planting, unless required to germinate the seed. There are advantages claimed for spring plowing. It enables the farmer to control moisture in making the operations of irrigating, plowing and planting continuous. Irrigating to germinate seed after planting should never be practiced, as much of the seed becomes ruined, and feeble growth takes place, which can seldom if ever be overcome by cultivation. Usually two waterings are sufficient during the growth of a crop, and often one irrigation is preferable. If the soil contains sufficient moisture in the spring to start the crop to a thrifty growing condition, and growth seems not to be retarded for want of moisture, watering can be delayed until the tassels begin to appear, at which time drouth would cause great injury to the crop.

The mistake is often made in the use of a large head of water while irrigating corn and in attempting

to get it properly distributed over large areas and through long rows. Much of the land thus watered becomes too wet, while other portions receive an insufficient supply. In neither case can the best results be expected. Another very serious objection to irrigating with a large head of water is that the water generally contains much insoluble earthy matter, which is ever being deposited as sediment. Waterways become coated and moisture fails to penetrate to the roots of plants along their course. To irrigate properly the furrows must be well made and as nearly free of obstructions as careful methods will permit. The slope of the land will determine the distance it is practicable to run water for uniform results. No greater quantity should be turned into each furrow than will flow with uniform rate. Seepage is slow at best and it usually takes many hours to secure the proper amount of moisture to the soil to prove of lasting benefit. In irrigating corn no great quantities of water are necessary, as is the case with root crops. While irrigation at the proper time is often essential to the right development of the corn product, the crop is impaired by excessive watering, and hence there is no more certain way of retarding growth and maturity than by the careless application of water. Better not irrigate at all than to use water lavishly. After the grain glazes there is no further need of water to mature the crop. Caution is advised in irrigating corn on sandy land that the stalks are not washed out at the roots and thus tumble over.

One of the most successful methods of growing corn by irrigation is to plow irrigating-furrows three

feet eight inches apart, using a single shovel-plow for the purpose and plant the corn in the small ridge left on the side of the furrow, using an ordinary hand corn-planter for small tracts. Always plant on the same side of the furrow in the cross of the mark and ridge. Never plant corn in drills if it is to be cultivated. It is a waste of time and labor, as the hoe will surely have to be used in order to keep the weeds down. On the other hand, if the corn is check-rowed nothing but a two-horse cultivator will be needed to keep the field perfectly clean. Before the corn comes up, harrow thoroughly, twice being usually sufficient. This is better than cultivating, and leaves the ground smooth and in excellent condition.

In planting large areas the two-horse planter may be used, and should it be necessary to irrigate the crop up, a small furrow may be made at one side of the row for that purpose. Corn ground should not be allowed to become so dry as to cause the leaves to curl, as some farmers persist in doing and advise others to do. Keep the ground moist. The matter of thorough cultivation should not be overlooked, as is too often the case. As a rule corn should be cultivated four times during the season. It should be borne in mind the more thorough the cultivation the more satisfactory will be the result. Care should be taken not to disturb the roots during the last cultivation or after the spur roots begin to form. It has been said that a handful of salt placed around the hills at the time of tasseling will prevent the ravages of the boll worm in the end of the ears.

**Egyptian Corn.**—Plow the ground into ridges

three or four feet apart, run the water through deep furrows, then level the ridges down and with a disc harrow stir the soil perfectly and cut it fine. Then when it is completely level plant with a double-row corn planter. A single one will answer, of course, but the better is the double-row planter with the check-row attachment, letting a boy work the handles as fast as he can conveniently, so as to drop four or five seeds in a place, and not more than eighteen or twenty inches apart in the rows. The planters make the rows three feet eight inches apart, which is convenient for cultivation. The disc harrow which is used for ridging and cultivating is perhaps one of the best cultivators, although any cultivator which can be used for corn will serve the purpose. The ground being well watered before planting, the seed should germinate and make a growth of at least eight or ten inches before any cultivation is needed. Then throw a slight ridge, or, with the disc set to leave a good center furrow, throw a ridge on either side of the corn, but not letting it bury the corn. Leave it with this cultivation until it is eighteen inches high, without further watering. Then in the furrows which have been made by the cultivator give the ground a thorough soaking, and as soon as possible afterward go through with the cultivators. Then there is no objection to hilling the plant somewhat. This will be the only cultivation necessary to complete the growth of the crop. If planted before the first of May, it ought to be ready for harvesting in August. After the corn has been removed, another thorough watering between the rows will put the ground in excellent condition for another cultivation,

which will insure a rapid growth of suckers from the root of the plant. It will throw up a mass of new growth, which will not mature grain, but which will make from two to four tons of fine forage to the acre. Kindred crops such as Jerusalem corn, Kafir corn, sorghum, dhourra, Milo maize, imphees, teosinte, and other non-saccharine forage crops which have become quite popular of late years in the arid region, may be irrigated and cultivated substantially the same as Egyptian corn. When sorghum is grown for syrup it needs a good deal of irrigation up to a certain point—that is, when it has commenced its active growth, after which water should be applied sparingly; otherwise the sap will be diluted and impaired in quality. No water should be given within a month of cutting. Broom corn needs but little water if the cultivation is conscientiously done. At the time of the heading out of the panicle, however, water should be given plentifully to force a good growth of brush and produce a smooth, long, and straight fiber. Of course when excessive drouth is prevalent all these crops must be irrigated more frequently, say once a month, in order to induce a steady growth. The various millets should receive the same treatment virtually as prescribed for broom corn.

In raising millet at the higher altitudes in the Rocky Mountain region, care must be taken not to irrigate more than is absolutely necessary to keep the crop from drying out.

**Beans.**—The ground should be plowed at least eight inches deep. A sandy loam is much preferable to a heavier soil. After the ground is plowed it should be

thoroughly irrigated. When sufficiently dry plant the beans in rows twenty-eight inches apart, three or four beans to every foot. Irrigate as soon as three or four leaves appear, which will be within a week after they come up. As soon as dry thoroughly cultivate. Irrigate again about the time that they are in bloom, and give one or two light irrigations afterward, thoroughly cultivating the ground after each irrigation. We have found that the best method of irrigating is by ditching with a single-shovel plow and irrigating in every other row alternately. The water should not be permitted to come in contact with the plants. Beans should be planted as soon as danger of frost is past. The preparations for irrigation may be made with the first cultivation, and the space between the rows should be utilized for the watercourse. Irrigation should take place in ordinary dry weather at least once every ten days, and the crop needs plenty of moisture, especially while the plants are in blossom. If after the blossom is complete the weeds show a preponderance of growth, threatening to choke the progress of the crop, a shallow cultivation should be given, and this will terminate the work for the season. After the pod has fully formed there will be less necessity for water, and as a rule the bean requires no irrigation after the legumes are half grown, for the crop is then made and the harvest certain. The best way to harvest is with a machine working something like a horse-rake. Threshing secures the beans. For field varieties we prefer such sorts as the Mexican, Red and White Kidney, Lima and the Marrow, rather than the Navy, which, however, is largely produced by some growers.



**Peas.**—This crop may be planted for either grain or forage, and in a general way the handling of the crop is not materially different from that for beans. Planting should be done by the first of April, and unless the season is an exceptionally dry one, irrigation about the first of July, or just at the blossoming period, is all that is demanded. For grain the peas may be sown in drills, or broadcast. Forty pounds to the acre in the former case and sixty-five in the latter are about right. If broadcasted the seed should be lightly plowed under. For forage growth alone it is best to sow broadcast two and one-half bushels an acre of the smaller Canadian field pea, and three to three and one-half bushels of the Marrowfat. Then cross-plow the seed under not less than four inches deep. Add to these one bushel of oats an acre, and after the seed is well put in mark out the field furrows about the same as for grain. It is always best to irrigate when the peas are in blossom, and then, when they are past the bolling stage and the pods are green enough to dry and hold the grain, cut them with a mowing-machine, throwing each swath out of the way. For hay do not allow the ground to dry, as prolific growth of vine is what is desired. Some years it will take four or five irrigations, while other years three will be found sufficient. The great secret in raising pea hay is in curing it. For small crops the best way is to cut the vines with a hand scythe, and let them lay as cut for twenty-four hours; then take a fork and make them into large cocks, which should remain undisturbed for a period of two weeks, by which time they are well cured. Never open them. When they are ready to stack simply turn

the cocks over one day before drawing them in, as the bottom of the cock will be found to contain enough moisture to make them mold in the stack if not dried before hauling. Peas put up in this way will be as green in January and February as they were in the previous June and July.

**Rice.**—In growing this crop by irrigation in the south it is best to select a tract of level land, which should lie so that it may be surrounded by a low levee, for the purpose of retaining the water on the field. It is plowed into beds fifty feet in width, thoroughly pulverized, and put into condition to receive the seed. Eighty to ninety pounds of rice to the acre is sown with a seeder in the latter part of March, or in April, sometimes as late as June, though the late-sown rice is not so apt to make a good crop as the earlier sown. After seeding, the ground is thoroughly harrowed, that all the seed may be well covered; then the harrow is followed with a roller, in many instances, to crush down clods and lumps, and make a good, smooth seed-bed. When the young rice has grown to four or five inches in height irrigating is begun, usually by pumps, putting on an average of two inches of depth of water over the whole field, but not enough to cover the young plants. As the rice grows the water is increased in depth, following the growth of the rice with the water, until there is a depth of six to ten inches over the whole field. This depth is maintained until the rice is headed out, and the grain formed and grown well out of the milk; in fact, until the dough stage, as it would be called in wheat. At this time the water is drawn off the land, and by the time it has dried out so

the binder can be run, the rice is ripe and ready to cut. It is cut with the ordinary self-binding harvester, is shocked up in shocks of twenty-five to thirty bundles each, these shocks well capped with four bundles broken down at the band, and then left until well cured and ready for the separator.

**Flax.**—This is one of the neglected crops of the United States, but it is coming into favor more commonly here in the west. The crop requires but little moisture, and if furnished early in the season insures a yield. Flax may be sown any time in May, for good results, though as late as the middle of June is not objectionable if the ground at that time is found to contain enough moisture to germinate the seed and promote plant growth. Not less than forty-five pounds of seed should be sown on an acre, while fifty pounds will give better results in most cases. The yield of flaxseed varies all the way from eight to twenty-five bushels to the acre. It should be sown in drills nine inches apart, or if broadcast the corrugated roller may be profitably employed. As the crop is grown mostly for fiber, the value of which depends greatly upon the length and fineness of the stems, it should be kept growing steadily, and may be irrigated every three or four weeks with light heads calculated to sink deep into the soil, so as not to coax the roots toward the top. After the plants are three-quarters grown withhold the water and thus give the fiber a chance to ripen properly before cutting.

The plant while growing is very tender, and extreme care must be used in irrigating. Water must not be allowed to stand on the land after an irrigation

or the plants will scald. Use the smallest amount of water possible for irrigation. The plants will stand fully as much dry weather as oats, and a few showers of rain at the right period might make a full crop without irrigation even in the arid regions. It should be cut as soon as the majority of the bolls show a light brown color and the seed itself the same color, not waiting for the straw to turn, for the seed will shell if left until the straw ripens. Almost any harvester can be used, but do not use the binding attachment. It is better to have a man follow the machine, putting about a half dozen gavels in a shock with the heads up, and if the work is properly done these small shocks will soon settle and withstand any amount of rain without heating or sprouting.

Leave the bunches in the field until ready to thresh and then haul directly to the machine without stacking, using a hay-rack upon which is placed a wagon or stack cover to catch the loose seed. A good yield of flaxseed under irrigation should be fifteen bushels an acre, although here in Colorado we have produced crops averaging twenty-eight bushels an acre. The ground should be left level and smooth after sowing, so that the straw may be cut as low as possible. If the land could be watered directly after cutting it would make a quick second growth and excellent fall feed. Some people have thought that flax culture could not be successfully practiced on the high plateaus of the arid region for the reason that the woody substance of the straw could not be rotted so as to make the fiber in condition to hetchel, but quite to the contrary this is the country to perfectly put the straw in condition

to work the fiber out of it. A ditch can be made leading to a bed in which to place the straw so as to turn on water, and when at the right stage the water may be drawn off and the fiber worked at the will of the grower. The climate is such that the fiber can be air-dried in the open.

**Hemp.**—Irrigation very much improves this crop as it does flax. The land is laid off into beds three feet wide, with spaces of a foot between each plot. The seed is sown on these beds after the entire field has received a good preparatory soaking. The spaces between the beds are reserved for cultivating and irrigating. After the seed has germinated a good irrigation is given through the furrows, and the water is best applied when run slowly, so that it will seep through the beds from each side. Every ten days the field should be irrigated until within a fortnight of the flowering period, when watering should cease. If irrigated during the flowering the pistillate flowers are weakened in fertilization and there will be a decreased seed crop. As soon as the pollen has been shed the staminate stalks should be pulled out, so as to give more room for the ripening of the seed. It is quite necessary through all hemp culture to keep the soil well moistened, but not so saturated as to be classed as too wet.

**Cotton.**—But few crops need so little water as does cotton, the only essential point being to keep the soil in a moist condition. Plow high ridges or beds four and one-half feet wide, much the same as for hemp, but provide the irrigating furrow lengthwise in the middle, using a small shovel-plow for this purpose.

Give the beds a good preparatory irrigation. Sow the seed an inch deep in opened drills and press down firmly after depositing the seed. If the bed has had a liberal soaking, as described, but one more irrigation usually is required, and this should be given as the plants begin to boll. The plowing is done in February and the sowing takes place in March.

**Hops.**—This crop will grow on a great variety of soils, but the deep alluvial river bottom mixed with clay will produce the best quality and greatest quantity. While hop roots must have moisture, and in friable lands will go deep in search of it, wet lands are not the best and are even unsuitable. Hops are perennial, and when set in kindly soil the roots will go down several feet and will draw moisture from very great depths in any weather, unless prevented by a hard subsoil. To secure the best results it is absolutely necessary to select soil that is naturally drained, or that which is thoroughly underdrained before planting. A yard set 6 x 6 feet will give 1,031 hills to the acre. Take the sets from the pruned runners and cut them in pieces so as to have three pairs of eyes to each piece. Plant these pieces at the proper distances, being careful to place them three or four inches deep. Thus when the land washes level the crown will be under the ground. The first move toward cultivating a crop is the pruning. This should be done early. All runners should be removed and the crown cut back, when found growing above the surface. Heavy pruning is not desirable, especially on light soil. Neither is it well to omit pruning altogether in any year. Irrigation can be done by flooding, or by

furrows, the latter being the better plan, and once every three or four weeks will suffice. The water should run for twelve hours at a time, and a good wetting just as the buds are forming is very beneficial. No water should be put on after the 15th of August, as the crop is then guaranteed.

**Tobacco.**—The soil should be carefully prepared before time to transplant from the frames. Irrigation furrows between the three-foot rows should be made deep and must be in readiness so that the water may follow closely upon the setting out. If the soil is moist the plants may be set and the damp earth firmed. If the soil is dry a puddle should be made for the roots, and a small irrigating stream should be allowed to trickle past until the plants take new root. Transplanting is done the same as with cabbages or tomatoes, and the modern plan, where the acreage is large, is to use the transplanting machine drawn by a team. This machine has an automatic jet of water for each hill as the plant is set, and is a great labor-saving device. Frequent cultivation is necessary, but water should be applied very cautiously. Too much water causes the tobacco to “french” and become worthless. If not enough water is used the plants will soon wither and parch, thus becoming of no use as a crop. The tops should be pinched out after the plants reach a height of thirty inches. This topping process will be followed by a crop of suckers equal in number to the leaves on each plant. These must be removed twice, at least, before the tobacco is ready for cutting. One irrigation during the middle period of growth is usually sufficient for tobacco, providing the cultivation

has been carefully attended to. If the soil is exceptionally dry and warm, however, irrigation may occur every ten days after a month from the transplanting, but no moisture to the root is needed after the plants are topped. In arid America the leaves need artificial sprinkling to produce salable fiber. The ordinary fruit tree sprayers may be used and the plants given two or three light showers in the early evening after the plants begin to ripen. This will supply the deficiency in air moisture and cause the fibers to thicken and become more solid.

**Potatoes.**—Here is something that requires scientific irrigation. The ground intended for an irrigated crop should be a smooth piece, having sufficient slope to make the water run freely between the rows. It should be plowed eight inches deep, or more, and then harrowed and dragged until the soil is firm throughout and thoroughly pulverized on the surface. Lay off the ground in rows three and one-half feet apart with a corn marker, or a small shovel which will make a shallow furrow, the rows running the same way the ground slopes, if it is not too steep. A slope of seven to ten feet to the mile gives good results. The distance apart in the rows depends upon the variety. If the Early Ohio, which grows the smallest vines of any variety, be used I would advise planting ten inches apart in the row. If the Peach Blow, which grows the largest vines of any variety, be used, I would advise a distance of twenty-one inches apart. The rows should be from three feet to three feet six inches apart. The closer you have the rows, and yet be able to work with horses conveniently, the better,



because the more compact the mat of tops of the vines the better the ground will be protected from the direct rays of the sun—so that, after irrigation, the moisture may be retained in the ground, as the potato delights in a cool, moist soil. Cover by throwing up from each side a good slice with a two-horse stirring plow. This will cover the potatoes to a good depth and leave them in ridges for irrigation. We always make it a point to give the prepared ground a good flooding before planting unless the heavens have wept copiously to moisten the ground. We plant in Colorado from May 20th to June 10th. For seed we prefer the half-cut tuber, although this is a matter of one's own judgment.

When the sprouts appear above ground we go over the patch with a slant-tooth drag to loosen the soil. There is no danger of injuring the plant in this way. We are not able to say just when potatoes should be irrigated. In that, as in size of seed, no rule will hold good. Some varieties require more water than do others, and some soils require more than others. Water applied too soon will often turn the vines yellow and permanently check their growth. On the other hand, if the ground is very dry at the period when potatoes are setting, as we term the formation of the young tubers, it often happens that no after application of the water will remedy the matter, and a short crop is the result. As a general rule, it is much better for the crop that the vines should attain a good degree of growth and be well in blossom before water is applied, but there is no fixed rule as to this. When the ground gets very dry and hot, and the vines turn dark-colored

and cease to grow, water becomes a necessity at no matter what season, unless the crop has already or nearly matured.

If the spring has been cold and very backward, and the subsoil is still lacking in warmth, it will be found fatal to the potato plant to apply water, even if the soil is very dry. It has been found that soils that are heavily manured will take water at an earlier date in the spring without injury to the plant than will poor, thin soils; also by reason of the undecayed manure applied, it is necessary to use water sooner than on unmanured soil. One good watering will often mature a crop of potatoes, but if the growth of vines is heavy and shades the ground well, two, or even three, waterings will increase the yield, and can in no ordinary case injure it. Each application of water should be followed immediately with thorough cultivation until the vines are too large or the tubers too near grown to permit of it. Nothing is so damaging to a growing crop as to leave the furrow or gutter in which the water has run to bake and dry in the sun. Even when the advanced growth of the vines and tubers will not permit it near the base of the hill, cultivation may still continue with profit as long as the furrow is in sight in the middle of the row.

In watering, it is best not to try to run water through too long rows. As a rule it is best not to have the rows over 40 rods in length. If the ground is very steep, of course, the water will run quickly through, but it will have to run longer than in a row with less fall, to give it time to soak in; and if the rows are too long, by the time the water is through and the lower

end is wet enough, the upper end will have had too much. If the ground has too little fall, the least clod will clog up the rows and flood the surface. See that there is a free opening at the lower end of each row, or the water will back up in row after row for rods, and flood and ruin the crop. In sandy soils water should not continue to run more than three or four hours, while in tenacious soils the irrigation may continue eight or ten hours at a time.

After once irrigating it is very important that the ground should never be allowed to become dry, thus stopping the growth of the potato. For if we permit the growth of a potato to stop, and by irrigation it again starts to grow, it will either increase irregularly in size or set a second crop, thus giving a large number of small potatoes or a crop of ill-shaped ones. The irrigation is usually discontinued about the first of September, although if it is a dry fall a later irrigation may be needed. A potato field under irrigation is the subject of Fig. 61.

Around Greeley, Colorado, where potatoes are so successfully raised, though they may appear to need water, the farmers are careful not to irrigate them until after the young tubers are set. The reason for this is obvious. When irrigated immediately before setting, a greater number of potatoes will be formed than the plant can properly support, few of them becoming large enough for market. When the tubers are allowed to form first and are irrigated afterwards, fewer potatoes will form in each hill, but a large crop of marketable tubers is the result. Keeping the ground mellow by thorough and deep cultivation is important. If the

ground is dry, irrigate some time before beginning to set. If kept too wet, a large amount of tops and few potatoes will be produced.

Never flood the potato field nor allow the water to reach the crown or stem of the plants. Always bear in mind that it is the roots and not the tubers that are to be watered. By the time the plants are four or five inches high the roots are several times that long and no



FIG. 61.—IRRIGATING A CROP OF POTATOES.

more deep cultivation should be given them. Use some form of cultivator that will keep about two inches of the surface thoroughly pulverized. As said before, it is advisable on sandy loam as soon as planting is done to harrow with the row, using bull-tongues set to run as deep as possible next to the row, the outside ones being set shallow. As the potatoes begin to grow reverse the shovels, running the outside deep and the inside ones shallow, so as not to disturb the roots. The

more recently invented weeders are considered better than the harrow, as they are lighter, the teeth are finer or closer, do not injure the tops, and as they require but one horse much tramping on the ground is prevented. They destroy all weeds in the rows, thereby saving considerable hand-work. It is better to avoid irrigating during hot sultry weather, for if the soil is allowed to become too dry the potato plants are weakened. When irrigated at such time the conditions conducive to fungous diseases, such as blight and rust, are bound to prevail.

Since the first appearance of "Irrigation Farming" some of the older and more experienced spud growers in the famous district around Greeley, Colorado, where as many as 20,000 carloads of marketable potatoes are grown in one season, have changed their views regarding the proprieties of irrigation. Experience and practice are entirely different now. As the growers began to apply manure in quantities to the land in order, primarily, to increase the fertility and the resulting yield, they made some discoveries: First, that the plants needed more water or the manure would burn them, and, further, that with richer soil and more plant-food, rendered soluble and available by water and cultivation, potatoes could stand more irrigation and earlier in the season, not only without injury but with material and perceptible benefit. Now they apply twice the amount of water they formerly thought either safe or necessary. At one time in the history of potato farming near Greeley the growers calculated that if it became necessary to irrigate potatoes to bring them up the chances were about even between total failure if

they did not put on the water and a practically complete failure if they did so.

The moment the growers get done planting nowadays, if the ground is too dry to germinate the seed, and if the prospect of copious rainfall is not extremely favorable, no one fears and very few hesitate to furrow out the ground and turn on the water at once. If the seed is in fair condition it is the uniform experience that the young plants will push themselves through the earth in an astonishingly short time and grow vigorously after they come up. Two irrigations were formerly considered sufficient under ordinary circumstances as to the rainfall to mature an average crop and three irrigations under the conditions of extreme drouth. As the country grows older and improved methods of cultivation supersede the first primitive efforts, as the soil increases in humus by liberal coatings of manure, or by the turning under of masses of green alfalfa, rich in nitrogen and other plant-foods, more and more water is necessarily required to produce the best results.

In many instances the potatoes are irrigated from four to eight times, and when there is sufficient supply of water the growers do not hesitate to run water down the potato rows once every week from the time it first becomes necessary or advisable to irrigate until the growth of tubers and vines is completed. It must be understood, however, that this condition prevails only when the soil is well drained, thoroughly enriched with manure or alfalfa, and cultivation is thorough. The strong point in the whole business is to keep the ground at an even, moist temperature. In very dry

seasons this subject of moisture becomes a good deal of a worry and water has to be doled out sparingly. In certain localities around Greeley large reservoirs have been constructed to supply sufficient irrigation, and farmers living under these reservoirs are fortunate in being so advantageously situated. With short water the need of cultivation becomes more imperative and must be conscientiously carried out.

**Sweet Potatoes.**—The most successful growers find it best to plant the seed in hotbeds about the last of March. The seed will yield two and three sets of plants, which are transplanted in the open ground from the first of May to the first of July. Seed potatoes weigh from two ounces to one pound, and the transplanting is done when the plants are eight to twelve inches long. The field is plowed twelve inches deep and the rows are thrown up three and one-half feet apart, and the plants are set eighteen inches apart in the row. This requires 8,500 plants to an acre. The irrigating water follows closely upon the work of transplanting, and in ten days another irrigation may be given with a good head of water, which is let on for five or six hours. Irrigations continue at intervals of two weeks or oftener, according to the condition of the weather, until the tubers are half grown, when irrigation is discontinued. Do not put on too much water, and it should not come up more than two-thirds the height of the ridges, if it can be helped. The ground is not disturbed during the growing season by cultivation, but the weeds are hoed off close to the ground once or twice during the season.

In harvesting, a furrow is plowed on one side and

close up to a row of potatoes, then the return furrow on the other side throws the tubers out and they are picked up by hand. After the transplanting is done the roots go directly down to the hard surface of the under soil, and the potato grows in an upright position from that point. The Bermudas are the largest variety, and the Nansemonds are the smaller ones, while a most popular market variety is the Jersey Sweet.

**Sugar-Beets.**—The seed-bed should be thoroughly pulverized, to kill the young weeds, just before planting. As soon as the ground is warm the seed should be planted two inches deep, in drills from sixteen to twenty-four inches apart. If hand-planted, ten to fifteen pounds of seed to the acre is sufficient. If drilled in, use fifteen to twenty pounds of seed. Any good garden drill will do, and grain drills can be used by closing some of the openings. The earth should be pressed close to the seed by a following wheel with a two-inch tire, on the principle of the press drills. The depressed seed row acts as a catch-basin for any slight rainfall, and at the same time shelters the seed from drying winds. Rolling the whole ground has proved injurious, as it brings all the soil moisture to the surface to be swept away by the dry wind. Seed drilled on ridges remains dry in the arid climate until the furrows between are filled with irrigation water. Cultivation tends to uncover the tops of beets growing on these ridges, and the uncovered portion is unfit for sugar.

If the ground be so dry that the seed must be irrigated it should not be flooded, for thereby many seeds will be washed away and the sprouting seeds



force their way with difficulty through the resulting caked surface. Shallow irrigating furrows should be made midway between the rows, and the water will reach the seeds by seepage. These furrows can be made at the time of drilling by an attachment like a corn-row marker, which could also be used separately after drilling. If the ground is moist enough to bring up the seed, the irrigating furrows need not be made until the operation will kill many sprouting weed seeds. Further cultivation can be done with a hand hoe or the many forms of garden and horse cultivators. The soil should be kept mellow. The more cultivation the more sugar. Hilling is not necessary, as good varieties of sugar-beets grow very little root above ground. When the beets have from four to six leaves they should be thinned to single plants four to eight inches apart in the row. Thin to four inches in very rich ground and to more than eight inches in very poor ground. The long roots of the beets gather so much moisture from the subsoil that they require less irrigation water than do the shallow-rooted grains and grasses. During the fall the beet requires a dry surface soil to increase its saccharine content, and will thrive, getting all the moisture it needs from the summer irrigated subsoil. Stop the irrigation early. Guard against seepage from surrounding land, and, above all, avoid such an excess of water as to flood the ground or accumulate in pools on any portion of it. Irrigators of sugar-beets learn to use less water each year.

The foregoing instructions apply to beets grown for the sugar factories. Producing them for live stock

demands more frequent wetting and a forced habit of growth throughout. We have relied upon from four to seven irrigations in a season of subsoiled land, and have had the most flattering success when the water was applied at least every fortnight from the first of June.

**Turnips, Beets, and Carrots.**—These may be irrigated at any time, the only care necessary being to keep the ground mellow and in good tilth. Field turnips for live-stock feeding should be sown broadcast about the first of August. Set out the irrigating furrows every six or ten feet, according to the porosity of the soil, and have them run at an easy grade. Wait long and patiently for the seed to germinate before irrigating for that purpose. Never flood turnip, parsnip, or carrot ground, as the water would rot the crowns; undersoaking is the thing. Give frequent irrigations until the root has fully formed. After the plants are large enough to shade the ground irrigation is scarcely necessary, and it might prove an injury and cause decay.

Such roots do best on black, loamy soil, containing much decomposed vegetable mold, but like most crops will grow anywhere and yield in proportion to land, cultivation, and general conditions. The soil should be thoroughly pulverized, leveled, and rolled before sowing. Deep plowing is not necessary, and some successful growers merely loosen the surface with garden cultivators. Seed may be sown broadcast or drilled in rows about fifteen inches apart. Two or three pounds of seed will plant an acre. A slight covering is sufficient, and some growers cultivate lightly

after sowing and marking out irrigating ditches for turnips as closely as twenty inches apart if sown broadcast. When sown in drills clean cultivation by shallow plowing or harrowing will increase the yield and make more uniform roots. Weeds must be kept down to insure good results. Irrigation by the furrow system is no doubt best unless there is some method of sub-surface water in use. Small plants require moisture but will not stand much water, and therefore should be irrigated very sparingly. It is a good idea to run the water through the small ditches just long enough to moisten the surface on each side. Too much water will cause the soil to bake or become soggy, and shorten the yield in proportion to the excess of irrigation. The writer believes that in field culture of turnips better results will be realized by the use of the corrugating roller instead of plowing out the furrows in the old-fashioned way.

**Canaiigre.**—This is a species of dock-weed coming into great popularity in the southwest on account of the tannic acid contained in the roots. The tubers must be planted in the early fall, much the same as potatoes. With rain or irrigation in the fall the leaves appear and a new crop of roots is formed. The irrigation should begin by October 1st, and the soil should be kept moist through the winter and up to May 1st, after which no more water is needed until August 1st, the harvest taking place late in September. Deep cultivation should be practiced after each irrigation, and between times if the land requires it. With most lands five irrigations should be given the year's crop and at least as many cultivations. An average yield

is anywhere from fifteen to twenty tons to the acre, and the crop is gathered with a potato digger.

**Meadows.**—Grasses may be irrigated at almost any time during the season. The best native hay grasses, the blue stems, poas, timothy, fescues, grama, etc., produce stems just underneath or at the surface of the ground. Wherever these underground stems or rootstalks are broken, other stems and leaves will grow. If these grasses are not thick enough, a thorough harrowing in the spring before the water is turned on answers the double purpose of breaking up the rootstalks, causing the sod to thicken, increasing the yield and leaving the ground in the best condition for absorbing water. Native meadows should be supplied with comparatively large amounts of water in the spring before the stalks begin to shoot, if the rainfall has been insufficient. No water should be given any hay crop for some length of time before it is to be cut. This allows the plant to store up larger amounts of nutrition, and the ground is firm and in good condition for cutting and curing the hay. Alfalfa and other clovers, where more than one crop is to be harvested in the season, should be quickly and thoroughly irrigated soon after the previous crop has been removed. One irrigation is usually sufficient for each crop. The same treatment should be given native meadows which are to be used for pasture. The stubble is easy to irrigate, and in this condition the plants need moisture to enable them to put forth a new growth.

In England meadow irrigation is quite commonly practiced. In many places a tide of rainwater is turned into stockyards having descending surfaces, the

water running through the manure and carrying the fertilizing material into a large pond at the lower side of the yard. The pond thus serves as a reservoir for the water, which has gathered the best elements of the manure it passed through in flowing to the pond. At the farther side of the pond a plug of wood four to six inches thick and four feet long is inserted in a pipe under the water, the pipe extending four to six feet into a small watercourse in an adjoining pasture. This watercourse has only a little descent, sufficient to let water flow along it. After heavy showers the plug is drawn, and the water and manure it contains let through the pipe into the pasture, where it is applied both in irrigating and fertilizing. The result is a very large crop of grass.

There is no crop grown in the Rocky Mountain region in which the use of water becomes an abuse as in the irrigation of hay meadows or vegas. The extravagant application of water in such irrigation has become an evil, the extent of which has become almost proverbial. Over a large part of the country where meadows are irrigated for the production of hay, it is the common practice to turn the water on the land just as early in spring as it can be run through the ditches, ordinarily about the middle of April, and it runs continuously until about the middle of July, being turned off only long enough before mowing to allow the land to dry out, so the water will not interfere with the work of haymaking. This time varies in different places from one day to two weeks before mowing begins. Some farmers turn the water off the meadows the day before they begin to cut the grass,

and depend upon the land drying rapidly enough so the moisture will not interfere with curing the hay. Others even go so far as to run the mowing-machine right along under a few inches of water.

Various reasons are given for turning the water on the meadows as early as possible in the spring. The water draws the frost out of the soil, softening the land so the grass can make an early start and produce larger growth than if held back naturally by the cold weather. Where the soil is covered with alkali the white incrustations of salts interfere with the growth of grass and keep the land cold by reflecting the sun's rays. If the water can be run over the land enough to wash off the alkali or dissolve it and carry it into the soil, the grass thickens up and makes a good crop. Whatever the reason, it is evident that ranchmen, as a rule, believe in irrigating native hay land as early and as long as possible, and all use the most water when the largest amounts can be obtained from the streams, which is during May and June. The writer is not in accord with this practice, and has never advised such extravagant procedure.

In preparing to seed the land for a meadow the ground to be irrigated should not only be fine in texture before seeding, but it should also have a smooth, even surface to facilitate irrigation. Enough time may be thus saved in a single season's irrigation to pay the extra expense of careful leveling. The better the condition of the soil the less the quantity of seed required and the greater the certainty of a perfect stand and satisfactory vega. It is a mistake to expect the best or even good results from a single kind of grass.

No fewer than four or five varieties should constitute the mixture to be sown, especially for pasture, and, as a rule, the greater the number the better the stand. Since each grass has a different time of maturity a number of kinds will be more likely to furnish a succession of green, succulent pasture throughout the season than a few. Some grasses start earlier than others in the spring and some hold out longer in the fall. The best pastures in the west contain a dozen kinds of grasses and clovers, and supply continuous grazing during the season, though frequent irrigation is required. For pastures under irrigation the following mixtures are recommended :

<i>For upland :</i>		<i>lbs.</i>	<i>For low, moist lands:</i>		<i>lbs.</i>
Kentucky blue-grass . . . . .	80		Red top . . . . .	50	
Perennial rye grass . . . . .	35		Perennial rye grass . . . . .	40	
Red top . . . . .	30		Creeping bent . . . . .	20	
Orchard grass . . . . .	15		Meadow fescue . . . . .	20	
Tall fescue . . . . .	15		Timothy . . . . .	10	
Red clover . . . . .	10		Alsike clover . . . . .	25	
Alfalfa, or alsike . . . . .	10		White clover . . . . .	10	
White clover . . . . .	15				
	<hr/>		Total . . . . .	175	
Total . . . . .	160				
<i>For marshy lands:</i>			<i>For light, sandy soil:</i>		
Red top . . . . .	70		Kentucky blue-grass . . . . .	40	
Perennial rye . . . . .	50		Red fescue . . . . .	30	
Creeping bent . . . . .	25		Tall oat grass . . . . .	25	
Alsike clover . . . . .	30		Smooth brome . . . . .	25	
	<hr/>		White clover . . . . .	10	
Total . . . . .	175		Total . . . . .	130	

Each of the mixtures given contains enough to sow five acres. The new *Bromus inermis*, or Hungarian brome grass, which has been creating considerable interest throughout the west during the past few years, is more valuable for pasture than for hay, and does not require nearly so much irrigation as the other intro-

duced varieties, such as are named in the foregoing table. Its great fault, however, lies in the fact that it is not sufficiently hardy to avoid winter-killing in exposed positions, especially during the first winter, and for this reason its utility remains somewhat in doubt.



## CHAPTER XIII.

### IRRIGATION OF THE GARDEN.

**T**HERE is no part of the farm that ought to receive more attention in the way of cultivation and irrigation than the garden, and it is here that the most flattering results may be obtained as the reward for one's labor. The first thing to be done after securing a suitable location is to thoroughly break and pulverize the soil. As irrigation is an essential element of success, the garden spot should be harrowed, leveled and rolled, so that water can easily be carried to all parts equally. After many years of careful observation and experience, the writer is constrained to say that it is a better plan to have the garden laid out in the form of a parallelogram, with the narrow and highest end abutting on the lateral. In this way the water may easily be taken from the ditch, and if the rows of crops run the entire length of the patch there will be no difficulty from applying water to one crop at the expense of another.

Fig. 62 gives the diagram of a well-laid-out garden after the style of these suggestions. The lateral is represented by *a*; *b* shows the measuring-box or flume, *c* the head-flume or box at the head of the furrows, and *d* shows the gates or checks at the head of each row. If possible to do so, it is always best to flood the land before preparing the ground. Then when dry enough to work, prepare and plant at once, and the

seed will always come up before it needs watering again. For radish, peas, lettuce, and turnips it is best to prepare the ground level and flood. Have the rows straight and the proper distance apart for cultivation and irrigation. Plant

the early varieties adjoining each other, so that the land can be used a second time during the season. The object should be to get as much as possible from a small patch instead of using too much land and thus neglecting the entire garden. Lettuce, radishes, peas, beans, and turnips are short-lived vegetables. Their days are soon numbered, and the space they occupied, as early products, can be used a second or third time during the

season. They should therefore be planted in such manner as to leave the unoccupied land all in one plot. The scene in Fig. 63 gives a good idea of a garden under irrigation.

**Asparagus.**—A light sandy loam is preferable. Plow very deep, turning under a heavy coat of manure. Run two or three times for a deep furrow in which

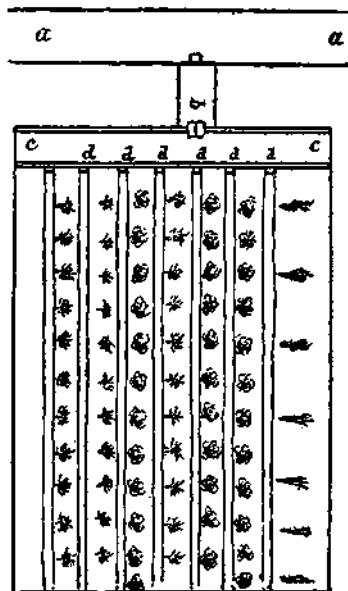

FIG. 62—DIAGRAM OF GARDEN.

to plant. Set the roots down four to six inches below the even surface of the garden and draw the soil back into the furrow. One or two rows across the garden will be all that is needed for family use. If more than one row, make them four feet apart and set a foot to eighteen inches in the row. Set early in the spring. To irrigate, run a furrow with a light plow a



FIG. 63—IRRIGATED GARDEN.

foot or so from the row, and water well without permitting the water to leave the furrow. As soon as the soil is dry enough, run the cultivator down the rows to fill the furrow and keep the soil from baking. Repeat the process as often as water is needed and cultivate frequently. The writer sets two-year-old roots, using the Colossal and Palmetto varieties. We find it

advisable to hoe the soil gradually up to form a ridge two feet wide over the plants, thus leaving a furrow of equal width between the ridges. In this way the roots of the plants are covered by a great depth of soil, and as the surface of the ridge to the depth of twelve inches is loose and dry, no attempt is made by the roots to push their way upward. When the young shoots start to grow they have to push through a considerable space of loose soil on the ridges, and they can be cut at a point seven or eight inches below the surface as soon as the tips appear above ground and before they begin to get green. Asparagus is rather partial to water, and irrigation may go on every ten days or two weeks during the cutting season, while once a month thereafter will suffice.

**Celery.**—The writer never had knowledge of a garden crop that needs more water than does celery. It does best in a soil that is naturally moist and is supplied with an abundance of vegetable matter. The market gardener generally raises two crops of celery—early and late. The early crop is usually disposed of during the late summer and fall months, while a late crop is stored for winter and spring use. For an early crop the seed is sown about the first of March in a moderate hotbed, in drills two inches apart. The soil should be made very rich and the bed well watered, to give the plants a good start.

When the plants have grown to a fair size, they are usually transplanted into a cold frame. However, this practice of transplanting celery is rapidly disappearing. Experience has proven beyond a doubt that celery so treated will produce a larger per cent. of plants that go

to seed, and therefore become worthless. The plants, while in the seed-bed; should be shorn off at least twice, in order to make them stocky and form a quantity of fibrous roots. When the plants have attained the proper size—that is, from three to four inches—they should be transplanted into their permanent bed, which must be well fertilized with short and well-rotted manure, in rows five feet apart, and the plants set eight inches apart in the row. After transplanting the plants they should be given a good soaking by running the water down the rows, and if the weather is dry they must be irrigated at least once every week or ten days and cultivated after each irrigation. Some growers are more extravagant than this and irrigate as frequently as three times a week. In six weeks from setting, the plants will be large enough to be handled or banked. This is best done by throwing up a furrow on each side of the row, and pulling the earth close to the plants with a hoe. Then commence at one end of the row and gather up all the leaves, holding them with one hand and pushing the soil close to the plants with the other. This operation must be repeated several times. When the plants are desired to be bleached they must be banked up to the tips of the leaves. Late celery is handled in much the same manner as the early, differing from it only in three or four points. The seed is sown six weeks later in a well-prepared bed out of doors, and as it is intended for winter and spring use, it must not be banked up as much as the early crop, for if it is bleached when stored away it will not keep.

The Sabula Celery Company, of Iowa, has been

trying a novel experiment for the irrigation of its celery field, which is proving a big success in every way. The irrigating is done by means of rows of tiling laid in the ground about a foot below the surface. The tiling cannot be placed together snug enough to be water-tight, and at every coupling the water forces itself through the joints. Rows of tiling are laid every twelve feet, and these are supplied by a long ditch furnished with a number of gates which regulate the

water - supply, the ditch being filled by a large pump, and a piece of land that would ordinarily take three or four men three days to irrigate may now be

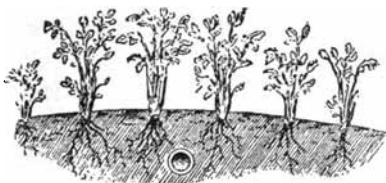

FIG. 64—SECTION OF TILED  
CELERY BED.

done in that many hours with the help of these men. A drop of two feet on two acres is given the tiling, and the lower end is securely closed, which gives the water considerable back pressure. A section of this tiling is given in Fig. 64.

Of late years some gardeners are adopting what is known as the new celery culture. By this method the crop is planted closely, and no carting or handling is required, for as the plants struggle for light they naturally assume an upright position. The light is excluded below and the self-blanching kinds become white and tender. With so heavy a crop on the ground a great deal of water is necessary. One gardener plants 6 x 6 inches each way, which gives a hundred and seventy thousand plants to the

acre, and the irrigation given is two or three times a week.

**Beets.**—These need rich garden soil with plenty of humus. Sow from March 15th to April 15th. For first early the Egyptian is all right, the Eclipse coming next in order, the Blood Turnip variety still later, while the mangel-wurzel, for stock feeding, comes last in planting order. We do not believe in the practice of irrigating the seeds before they germinate. Table beets may be given more irrigation than is allotted to the sugar-beet, and for early growth they may be irrigated every fortnight during rainless seasons. Cultivation the second day after irrigation is quite as essential as the irrigation itself. The soil should be kept as mellow as possible, and it is well to have the rills located six or eight inches away from the plants, so that water may not come in contact with them, as flooding is considered injurious.

**Radishes.**—This popular relish crop may be produced in greatest perfection by irrigation. Light sandy loams well enriched are best. The first crop should be planted by March 15th, and others at frequent intervals thereafter. Long scarlet varieties are preferable for this planting. For general summer use the early, round, dark red are good, and for fall and winter we sow the Chinese Rose. It is best to plant the seed in rows from sixteen to eighteen inches apart, and give an abundant amount of water at all stages of growth. No root crop requires more water than does the radish, and once a week during dry periods is not too often to irrigate. Cultivate the same as for beets.

**Carrots and Parsnips.**—Sow the seed a half

inch deep, or even deeper on very light, sandy soils. The rows should be from sixteen to eighteen inches apart. Give frequent irrigation until the roots are fully formed. These wettings may be from four to seven days apart, according to the natural condition of the soil. Stop the irrigation as soon as the plants are large enough to shade the ground, as there is then danger of rotting the roots in the ground and thus ruining the crop. In no instance allow the plants to become flooded after they are half grown, as this would surely so injure the crowns as to spoil the crop. This rule must also be observed in irrigating salsify, the general conditions of which are the same as those of carrots. With the oyster-plant, cultivation is of more value than is irrigation, and in any event make it a rule not to irrigate after the plant is half grown or well under way.

**Turnips.**—The seed of the turnip may be sown as early in the spring as the ground can be worked. For fall and early winter use grow the White Dutch, for winter use and early spring the White Egg. The seed and turnips can be grown the same season. Finely pulverized new soil is the best. Sow broadcast the first of August, drag the ground with a light harrow, then make irrigating furrows every six feet. Wait long and patiently for the seed to germinate before irrigating for that purpose. Never flood the turnip ground—undersoaking is much the better. The best success is the result of careful preparation and close attention.

**Horseradish.**—This root flourishes in deep, rich, moist soil which can be kept so by an irrigation every



few days. It is grown or propagated from sets or pieces of small roots cut at least four inches long, with the upper end square and the lower end slanting. The ground is well manured, deeply plowed, and thoroughly harrowed or otherwise put in good condition, then marked out in rows from two to three feet apart. In these the root pieces are planted, fifteen or eighteen inches apart. The planting is done by making a hole with a long, slim dibble or planting-stick, or with a small, light iron bar, and dropping the set, square end down, into it, so that the top end is left a little below the surface. Then press the soil firmly against the set. Keep the cultivator or wheel hoe going till the top growth renders further working unnecessary. The sets should be planted out in May or June. Catch crops of beets, lettuce, and spinach can be planted along with the horseradish and harvested before the horseradish has made much headway. Irrigation every week until the sets take new root is advisable, and the growth may be pushed. After the plants are well established they will require less water. When its roots once get into the soil they live and thrive until forcibly exterminated by being rooted up. But if allowed to grow at its own free will without cultivation, the plant degenerates rapidly and becomes, in a few years, scarcely fit for table purposes, for which it is now used.

**Onions.**—There are two methods of applying water to onions—by flooding and by furrows. Some men object to flooding, but the writer has no objection to charge against it so long as it is done in the right manner. For flooding, the ground may be laid off in

beds from ten to fifteen or even twenty feet in width and ten rods long. The size of the beds will be governed somewhat by the water-supply. The beds should be level, and it is better to have them level lengthwise, and they may have a slight incline. If the beds are level lengthwise the soil can be wet to any desired depth. Water may be turned on until it stands an inch deep all over the bed, which would be equivalent to a rainfall of one and one-half to two inches, or it may be turned on to a depth of six inches, according to the requirements of the case. If the bed has an incline the lower end should be left open, allowing the water to pass off, else that end will receive a great deal more water and the ground will become packed.

The soil should have moisture enough at the time of planting to germinate the seed. If the ground contains an abundance of moisture when the seed is sown it may not be necessary to irrigate for a month after the plants are up, but the proper time to apply the water must be determined by each individual case. The first application of water in the spring should be light, as the soil is then loose and absorbs water much more rapidly than it does later in the season. As soon after irrigating as the soil begins to dry, and before it has had time to bake, it is run over with the wheel hoe, just skimming the surface, followed with the cultivator teeth. It then lies in this condition until dry enough to require another irrigation, and so on through the season. This leaves the soil loose and mellow after each irrigation, and thoroughly exposed to the chemical action of the atmosphere. During the heat of the

season the crop will need irrigating once a week, and sometimes twice, depending a great deal upon the character of the soil. Toward the latter part of the season it is unnecessary to be so particular about stirring the soil after each irrigation. When the first tops begin to fall down irrigation should cease.

For furrow irrigation the onions are planted on level ground, the same as when irrigation is not practiced. The rows should be about fourteen inches apart. Run a Planet Junior cultivator between each row, and the peculiar shape of the teeth will leave a small furrow, at the same time not throwing enough soil on either side to interfere with the plants. Through each one of these furrows run a very small stream of water, just sufficient to keep running but not large enough to overflow the banks. This water passes off and must have an outlet, and should run in the furrows until it has soaked the soil to the center of the rows for about six hours. After the ground is sufficiently dried it is cultivated in the same manner as described in flooding. We are rather in favor of the furrow system, which is the only one to use in "the new onion culture," or the transplanting method. In doing this transplanting the water should follow in the furrow, and a slight ridge for the sets is preferable. It might be well to know that onions grown with too much water are apt to yield scullions, and the bulbs will be of inferior quality and prove poor keepers. In no case would we advise irrigation oftener than once a week.

One of the best onion growers in the Arkansas valley of Southern Colorado gives the following as his

method of raising onions: Prepare the land by fertilizing with forty or fifty loads of well-rotted manure to the acre, then disk and cross-disk until the manure is well pulverized and worked into the surface of the soil. Then plow moderately deep and harrow until the soil is in fine tilth. Use a marker consisting of pieces 2 x 6 and eight feet long cut into six pieces sixteen inches long, each beveled on one end. When the two are put together in the shape of letter V, so the opposite ends will be ten inches apart, the six pieces will make three V's. Take a plank 2 x 10, fifty-six inches long, and nail the first V in the center. Then nail the second one twenty-two inches from point to point; then on the opposite side nail the third, making the three V's abreast. Take a pole suitable for a tongue fifteen feet long, beveled slightly at the large end, and bolt in the center of the middle V. Do not bolt too tight, but leave a little play. Put braces on each side of the tongue, extending three feet up the pole. Six inches from the front end of the tongue put in a pin for the neck-yoke to rest upon. Eleven feet from the neck-yoke pin bore a hole for the doubletrees. For the first time through set stakes, so as to make a straight furrow. When ready to start, the driver stands on the marker, so as to weight it down. If the man's weight is not enough, put on extra weight until the plank is level with the surface of the ground. It will then make perfect ridges.

The next time through let one horse walk in the outside furrow. One marker will follow in the same furrow, and will be a gauge so that all will be alike.

Use a one-wheel seed-drill and run it on top and in the middle of the ridge. This will leave rows twenty-two inches apart and will require three pounds of seed to an acre. To cultivate use a single-shovel plow with a six-inch shovel. Nail a block on the under side of the beam, so as to use the fenders of a corn cultivator to keep dirt and clods from covering the young onions. Bolt the fenders so that they will cover one-half of the shovel. This will cultivate and leave the furrows open for the next irrigation. Cultivate after each irrigation to obtain best results. Hoe the plants as often as grass and weeds may appear on the top of the ridge. To use the marker the soil should be a little drier than for vegetation. After drilling in sufficient rows follow with irrigation. Do not fill the rows so that water will run over the top of the ridges. Let the water run long enough to sub to the seed. In six to eight days irrigate again. In fourteen to eighteen days the onions should be peeping out of the ground. The marker can also be used for beets, radishes, lettuce, spinach, and carrots.

**String Beans.**—A sandy loam is better than a heavier soil for this crop. The garden beans should be planted in rows twenty-eight or thirty inches apart, and they are to be drilled in on ground that has been previously well irrigated if not damp enough already. By this we mean when the earth will ball in the hand. The first irrigation will be proper when three or four leaves appear on the young plants. An irrigation of three or four hours' duration once a week throughout the season will not be too frequent, and especially a good one at blossoming time should be given. Cultivate

thoroughly after each irrigation. The harvest period may be prolonged by planting at stated intervals.

**Peas.**—As a matter of fact, this crop requires about the same treatment as do beans. The rows should, however, be three feet apart, and the writer prefers to plant on the north side of the ridge, half-way between the bottom and top. The pea will require plenty of moisture during the growing season, particularly at the period of bloom, which is a good rule for all the legumes. Mellow soil is quite a consideration, and this is a natural sequence with irrigation where cultivation follows. Peas may receive moisture every six or seven days, and will flourish under such care.

**Tomatoes.**—This great crop of commerce responds profitably to careful irrigation. Select a sandy soil and make it fertile by working in from twenty to thirty loads of well-rotted manure, which is necessary if large and smooth fruit is desired. Poor soil will produce a large percentage of rough and deformed fruit. Plow the ground ten inches deep and work it down smooth with an Acme pulverizing harrow. Shallow furrows should be plowed with an eight-inch plow four feet apart. Take up the plants by running a sharp spade under them, cutting out in blocks. Having made the bed quite wet, no difficulty will be experienced in handling the plants, as the soil will readily adhere to the roots. For very large tracts it will pay to use a transplanting machine.

The plants are placed in the bottom of the furrows four feet apart, and soil pulled around them with a hoe and well firmed with the foot. Plants treated in this way will grow right along, as if they never had been

moved. The remainder of the furrow may be filled up by running a one-horse plow the opposite way alongside the plants, which will also leave a furrow for irrigating. Water should then be turned on and allowed to run until the ground is well soaked up to the plants. The ground must be kept free from weeds by a narrow-bladed cultivator. When plants begin to set fruit use the one-horse plow again, this time running on each side of the row, which forms a ridge and keeps the fruit out of the water. We have found three irrigations on the very driest soil sufficient up to the fruiting period. Too much water will raise a heavy growth of vines and interfere with the ripening of the fruit. When the plants need water they will turn dark in color. They need water oftener after the fruit begins to ripen, to keep up the size and weight.

One drawback to the culture of tomatoes under irrigation is a disease known scientifically as *oedema*, which is a swelling of certain parts of the plant, brought about by an excess of water stretching the cell walls, making them very thin and the cells very large. The excess of water may be so great that the cell walls break down, and that part of the plant dying, exerts an injurious influence in adjacent parts. In an ordinary rainy season the irrigation of the tomato plant should be a secondary consideration. In ordinary moist land a good wetting just after transplanting and again in ten days, with subsequent cultivation, are usually quite sufficient. Too much water is a bad thing for tomatoes. Peppers require exactly the same methods.

**Cucumbers.**—For this crop a warm location is

best. All vines that belong to the Cucurbita family must not be irrigated much while the plants are small, or serious damage may be done to the crop. The ground should be laid off by running shallow furrows about five feet apart. It is best to irrigate the ground before the seed is planted if there seems to be a deficiency of moisture rather than to apply water after the seed is sown, and unless the soil is naturally a dry one it will not require any more water until the second or rough leaf is formed, when another light watering will be necessary. This will push the plants along a great deal faster than if the ground is kept very wet. When the plants begin to run and set fruit an irrigation should be given every ten days or two weeks. While fruit is forming the irrigating can hardly be overdone. The water must never run so as to come in direct contact with the plants, or the ground will bake around the stems, and may possibly injure the plants by stopping up the pores and excluding the air. Cultivation is not in good form after the vines begin to interlock.

The following plan for growing cucumbers for the factory is given by a grower near Denver: "We plant in rows about eight feet apart. We first prepare the ground making it as fine as possible. Then it is laid off in rows, and furrows about eight inches deep are plowed and filled half full of well-rotted manure. The soil is then raked back and fined again. Then we draw a line and drop the seed about two inches apart, pressing them into the earth about an inch. If it rains before the seed comes up we go over the rows with a rake to prevent a crust from forming. After



they have put out the second leaves they are thinned to eight inches apart in the rows and then irrigated. If the bugs bother we use tobacco dust. The tillage is all done with a plow and no hand-work is given except to pull the weeds out of the rows. From the time when the plants begin to run and set fruit we give an irrigation every ten days or two weeks, and after the picking season opens we irrigate every other day. The cucumbers are always gathered early in the morning or late in the evening. We have never failed to have a good crop."

**Cabbage.**—Plant early varieties in rows two feet apart and eighteen inches in the row. Late kinds should be set three feet apart in two-foot rows. Manuring is quite essential, and if neglected in the preparation of the ground, liquid manure may easily be supplied through the furrows and the plants will respond readily by putting on a healthy growth. In transplanting, the water should follow the work, and another irrigation should be given the succeeding day; then lapse a day and irrigate again. Allow two more days to go by and give still another but lighter irrigation. All this is done to assist the plants to put forth new roots and also to prevent wilting down. In irrigating cabbage it is essential not to allow the water to flood the plants under any circumstances. If the work of preparation and planting is properly done the water will run through the furrows between the ridges, and from their termination will run from one furrow to another, until all the field is finally covered. It is the small running stream long drawn out that counts, and after a cabbage patch once receives a good wetting

subsequent irrigations need not be so prolonged or copious. After the heads of the cabbage plants are half formed no water whatever should be given, on account of the excessive use of water having a tendency to cause the growing heads to burst. After the heads are fully formed the stalks may be split partially down the side three or four inches, which retards further expansion.

**Cauliflower.**—Set out and treat the same as cabbages and the work is done. Irrigation is carried on exactly the same as for the cabbage crop, and liquid manuring may be applied in the same way. We have found Henderson's Snowball the best early variety. Then in order of maturity come Extra Early Dwarf Erfurt and Long Island Beauty, with the World Beater coming last. If there is any deviation from the cabbage practice of irrigation, more water than that ascribed for the cabbage may be given.

**Watermelons.**—In Colorado this is often a field crop. The best soil for the melon patch is a sandy loam. This should be heavily manured. Melons of all kinds need an abundance of humus in order to thrive best, and this should be supplied in the form of stable manure. If manure is plentiful, scatter it thickly over the whole field; if rather scarce, economize by manuring in the hills. Usually the ground is plowed, pulverized, then furrowed eight feet each way and the seeds planted about half-way up the sides of the ridges. It is better for the starting of the crop if rains afford moisture enough to germinate the seeds; but in case of severe drouth, water is sometimes run in the rows before planting, and perhaps more frequently after

planting. Sod ground has advantages in the matter of irrigation, as the soil is full of grass roots and exceedingly porous, thus taking up water readily from the bottom of the furrow, and the moisture finds its way to the plant from below by capillarity. Cultivation should be commenced as soon as the plants show above the ground, and continued at frequent intervals until the growth of the vines makes it impracticable. Three irrigations usually suffice if the soil be well cultivated, but many growers irrigate four to six times, making the water take the place of cultivation. The best melons are produced with two or three irrigations and frequent stirring of the soil so long as possible. As long as the vines show a frosty appearance in the sunlight they are thrifty and are not suffering for water. In no instance should irrigation be given to the melon crop after the fruit is half grown, as the last days of the melon's existence in the field are needed for the chemical action that is going on in changing the juices into saccharine by the crystalizing process of the sun and the action of the air. Flooding is forbidden, as it bakes the ground around the younger plants and induces decay in the older ones.

**Cantaloupes.**—Lay out the rows the first week in May and plant the hills eight by eight feet, putting in long hills longitudinally with the irrigating furrows. Some growers turn the water right on, having given no irrigation before the seeds are planted. The plants should be irrigated very thoroughly for half a day, when two leaves are formed, then with a shovel-plow cover the water in the original furrow so as to retain the moisture in the soil. Then take a one-horse five-

shovel cultivator and tear up the middle ground both ways across the field, so as to get the best of the weeds. Take a hand hoe and loosen the soil around the hills. Irrigate again in two weeks, beginning the work at four o'clock in the afternoon and allowing the water to run until nine or ten o'clock at night. The young plants are very tender, and cold water is likely to check their growth, but if applied late in the afternoon the chill of the water is greatly overcome by the heat of the ground. It is best to furrow on one side only so as not to give too much water, and plant on the northern slope of the hill. When the plants go to vining the hilling-up is done, care being taken not to allow the plow to run deep, as there is thus danger of cutting the roots, in which event the vines would suffer severely. Irrigation should continue at intervals of every nine or ten days throughout the season, and more water is given after the blossoming period than before, so as to continue the formation and encouragement of the fruit buds—thus making the vines more prolific by continuing the bearing season. The vines require more water during the fruiting period, and larger and better crops will be the rule when plenty of water is applied at this time.

In recent years it has been found best to cultivate more and irrigate less. A small stream should be used in irrigating and should be allowed to run down the furrows about six hours. The stream should be regulated according to the fall of the land, so that the water will soak out each way a sufficient distance by the time it reaches the end of the furrows, thus avoiding waste of water. An inch of water is enough for each

furrow of forty rods. The cantaloupe may be given too much water, but the plants should be kept growing rapidly by a moderate application and a great deal of cultivation until the vines cover the ground. When the fruit is ripening the supply should be limited in order to make the fruit of the best quality and to have it ripen quickly. Irrigations may be given during the picking season when necessary, and should not cease when the melons begin to ripen, as some have said. The most important work of growing cantaloupes comes after the crop begins to ripen, and experience alone will teach growers the proper condition at which the melons should be picked, the best way of packing, and the easiest and best method of getting them to the cars and loaded in good condition. Cantaloupes thrive best on sandy loam, although clay loam with some sand will grow melons of good quality. The virgin soil of our western prairies will produce the best quality, providing the ground is well worked and thoroughly soaked. It takes more water, however, than older land. Three years is long enough to plant melons on the same ground. It should then be planted to some fertilizing crop, and alfalfa is splendid for this purpose.

**Pumpkins.**—For a pumpkin patch choose a light soil. A sandy piece of bottom is just the thing, the richer the better, though comparatively poor soil will do. After plowing and harrowing lay off in check rows ten feet each way. At each check dig a small hole and put in one or two forkfuls of manure, or throw out a double furrow with the plow and then put the manure in the checks. The pumpkin is a

coarse feeder and does not need the manure to be thoroughly rotted. Cover the manure with three or four inches of earth, making a perceptible hill. Sow four or five seeds in each hill as soon as danger of frost is over. When in second or third leaf, thin to two plants in a hill; and if the ground is rich they may, with advantage, be again thinned to one, when danger from the striped bug is over, about the time the plants begin to run. They should be cultivated alternate ways every two weeks immediately following irrigation; thus they will very soon completely cover the ground, and so keep the weeds down themselves. No irrigation is needed after the pumpkin is half grown unless the season is unusually drouthy. Squashes, eggplants, and gourds are handled practically in the same manner. It is a good rule to recollect that these vines require but comparatively little water until in blossom, and the greater amount of irrigation should be applied from that time until the fruit has grown to half size or over.

**Sweet Corn.**—Sweet corn should be cultivated and kept free of weeds, but irrigation must be delayed if possible until the corn is in tassel. As soon as the tassel begins to appear on the most forward stalks the water should be turned in and irrigation made thorough. The best method of irrigation is the furrow system. This should be carefully arranged so as to prevent the water running directly around the roots or stalks. A healthy, well-developed tassel makes a good crop of corn, hence care should be taken to prevent it from becoming stunted or killed from lack of water, also to keep the water from running around the stalks.

Quick growth will prevent this and also act as a guard against the invasion of worms in the ears. The common rule is not to irrigate corn until the leaves appear wilted in the morning. Though the leaves may curl during the day, as long as they come out bright and fresh in the morning it is best not to supply more water. Corn roots lie near the surface, so deep irrigation is not necessary. The water should be run through the rows quickly and turned off. As soon as in a condition to work, the surface should be cultivated to prevent rapid evaporation.

If irrigated too early the corn will turn yellow, grow up in small, sickly stalks, and bear poor ears. Again, if watered in the heat of summer the tassels may die and no corn can form. When too frequently irrigated the roots will not spread and collect nourishment from the soil. Healthy stalks will withstand drouth, resist worms, and produce abundantly. The only way to raise good stalks is to plant the best seed on well-plowed and thoroughly pulverized soil. A new and very good method is to plant corn along the sides of previously irrigated furrows. The seed should be planted as soon after irrigation as the soil will permit, and ordinarily need not be watered again until well up. Keep down the weeds by constant cultivation. Many growers do not allow the headgates of the ditches open before the corn comes to the tassel. There are others, however, who do not believe that such precaution is necessary. They hold that water may be run down the furrows whenever it seems to be required. The best corn growers in the west have harvested ninety bushels an acre from fields irrigated but once in



a season. If a farmer or gardener expects big crops of corn he must conform to the nature of the plant and bear in mind that with this crop cultivation is superior to irrigation.

**Peanuts.**—These require a warm, sandy soil. They are planted in rows two and one-half feet apart and fourteen inches in the rows. The nuts are shelled and planted two or three in a hill. Cultivation is about the same as for potatoes. The Spanish nuts grow upright, similar to potato vines, while the large Virginia nuts have vines running upon the ground, similar to sweet potatoes. The upright vines should be hilled slightly with a small garden plow, while the others require flat cultivation. They will need to be irrigated about once every ten days and kept clean of weeds until they commence to bloom, when they will need to be kept pretty well hilled up; and if the vines grow upward too much to take root, it would be well to put a shovelful of soil in the center of each vine, that is, on top of the center, so as to hold it down to the ground. The peanut does not need to have its blossoms covered, as many people suppose. The crop can be allowed to remain in the ground until the first hard frost without injury. There are different varieties, but the most profitable is the Virginia nut. They are both red and white, and the latter is the nut to grow for profit. The Spanish nut is very prolific and the best for eating. It is very small and never sold on the market except for confectioners' use.

**Lettuce, Spinach, and Parsley.**—These relishes are subject to the same general methods of cultivation and irrigation. The writer has been growing them



by the border system. The beds within the borders should be rectangular, and flooding is the only method of irrigation in such cases. It is well to have a wetting given preliminary to sowing the seed. Irrigation is not needed again thereafter unless the plants show signs of wilting from drouth. Then on a dark day or late in the afternoon give a quick flooding of an inch or so and run the water off as quickly as possible, as no great depth of moisture is required by such crops, which are mostly surface feeders. If lettuce is to be grown for seed occasional irrigations may be applied throughout the summer.

**Rhubarb.**—To have rhubarb or pie-plant do its best, a rich, medium heavy, sandy loam is required not less than two feet deep. It must be heavily fertilized previous to setting the roots with well-rotted manure thoroughly incorporated with the soil. If one desires to set a large patch, it is perhaps cheapest and best to raise the plants, but where only 50 or 100 roots are wanted they can be bought. Early spring is the best time to plant. For commercial purposes it should be planted so as to admit of horse cultivation each way, but when wanted for private use or where ground is limited the roots can be set as close as two feet apart each way and worked by hand or wheel hoe. In setting, the crown of the plants should be three inches below the level of the surface, so that when the ground becomes settled after irrigation, which should follow immediately, it will be just right.

To give the roots a good start, no stalks should be picked the first year, and only a few of the strongest the second, and none after the first of August in any

year. This is to allow the roots to form new buds for another season's crop. Generally the plants will start in spring after raking off the mulch without irrigating, but as soon as the ground becomes well warmed the water should be applied in rills for three or four hours and continued weekly thereafter throughout the cutting season, with a good terminating wetting shortly after the first of August to aid in the formation of buds. When the ground is frozen a coat of coarse stable manure should be applied to prevent frost from penetrating too deeply, thereby securing somewhat earlier cutting in spring. The roots should be divided every three or four years. Rhubarb pays best in early spring, and accordingly many gardeners are forcing it under glass. Some dig up the roots in fall and plant under greenhouse benches, while others plant roots in hotbeds or cold frames, but perhaps the best method is to plant roots eighteen inches apart each way, and in strips of four rows, so as to allow of a six-foot frame being placed over them. These beds must be heavily mulched to keep from freezing, when on or about the middle of February hotbed sash can be placed over the frame and the bed handled as a cold frame.

**Roses.**—A rosebush needs water. Watering once a month will never produce an abundant crop of rose petals. The bushes seldom get more water than is good for their digestion. A garden hose thrust near a bush and the water allowed to flow freely for an hour or two every day will furnish enough moisture for the roots. Of course, when the delicate young plant is first set out this generous way of giving the

bush a foot-bath must not be attempted. Young plants require some protection at night until their tissue stems have changed to woody fiber. On occasional days they may need some shelter from a too ardent sun. The soil about the rosebush needs occasional loosening. Virgin soil needs but little fertilizing aid, as a general thing, but a bucketful of barnyard manure spread over the ground and often flooded with water never harms a growing plant. It does rosebushes but little harm to cut off the tops of the more thrifty growing stems, and this plan generally results in a better crop of roses, but too much trimming and pruning is bad. We would not advise irrigation of the rose or any other bush, tree or shrub after the middle of August, or the first of September at the very latest.

## CHAPTER XIV.

### IRRIGATION FOR THE ORCHARD.

**A**S IN garden irrigation, it is advisable to so arrange or lay out the tract that those crops which require the least water will receive the least, and *vice versa*. In other words, do not mix everything in planting, so that the trees will have to be irrigated every time the small fruits are watered. We regard this an important precaution. However commendable impartiality may be as a maxim of irrigation, it will be found unsafe when applied to the details of water distribution. Plant the cherry trees, for example, where they will get the least irrigation. Next to them the pears and apples, although the latter will need considerable water the first season after planting. It is safe to say that a well-established orchard would not ordinarily require more than three good irrigations during the year. Some would do with less, but this would be about the average.

As to the manner of running water, we would say that our experience leads us to prefer a head of water just sufficient to send a moderate stream gradually along the rows. This enables the moisture to penetrate the soil more thoroughly than a rapid current would do. If practicable, water should be run on both sides of the row. This is especially desirable in the case of forest or other trees on land that receives little or no cultivation. On most grounds water is usually

run along several rows at the same time. Now and then soil is found that will admit of rapid irrigation, or, as it is sometimes called, sending the water along with a rush. But this is the exception. Of course, where water is scarce and one is limited to a certain time in its use, the best that can be done is to use it as circumstances will permit. When the water has run its course turn it off. Do not let it soak and flood the ground.

In orchard irrigation it is a good rule never to apply water so long as the subsurface soil—say at a depth of six or eight inches—will ball in the hand ; and this is a test that should often be resorted to during the growing season. The yield may be largely increased by the judicious application of water. That the fruit may also be increased in size and made more attractive is equally certain. At the same time judgment is required for the best results. Indeed, positive harm may be done by untimely irrigation, not only to tree and plant, but to the land as well. Incessant watering without regard to the condition of the soil or the needs of the plant will often force a growth of wood at the expense of the fruit product and the fruit flavor. It may likewise cause a growth to be made which the succeeding winter finds immature and unable to withstand its tests. This will almost certainly be the result with any tree or plant that has a tendency to make a strong or succulent growth. Whenever late frosts are feared turn on the irrigation water in the orchard, and unless the frost is very heavy no damage will be done to the fruit. Irrigate not later than the latter part of August or the first days of September, so as to give the

wood a chance to ripen. When water can be had irrigate once more in November or December, for the winters in irrigating countries are generally very dry, but never use more water than is needed to keep the soil moderately moist during winter.

It has been observed in actual experience that water should not be required ordinarily to run in the furrows more than sixty rods, although eighty rods may do under certain conditions of soil, slope, and supply. Any greater length of flow might cause the first or upper part of the furrow to become cold, a condition to be avoided by all means, as the growth of any tree, shrub or vine is naturally checked when the ground becomes chilled, a condition found to ensue when cold water is allowed to run over the roots. In warm weather the water will evaporate quickly. We have noticed during hot days in irrigating that it would take water in a good even furrow about sixteen to eighteen hours to cover a distance of sixty to eighty rods, and in that time the ground at the head of the row would be very cold and growth much checked before the last part of the row was thoroughly irrigated.

The length of time that water should be allowed to run in orchard furrows must of course be governed by the nature of the soil and lay of the land. We usually let a small stream run twelve hours. Water is regulated by small boxes made of lath, which are cut in pieces two feet long, nailed so as to make a funnel one inch square. A box is put in the head ditch at each furrow. If the soil is very dry or loose two boxes may be used for each furrow. It is necessary to put the boxes at the bottom of the lateral on account of floating

trash and to get pressure. As the trees grow older and larger the soil must be soaked deeper, and when loaded with fruit they need irrigation at least every two weeks until the fruit is gathered. Do not be afraid that a

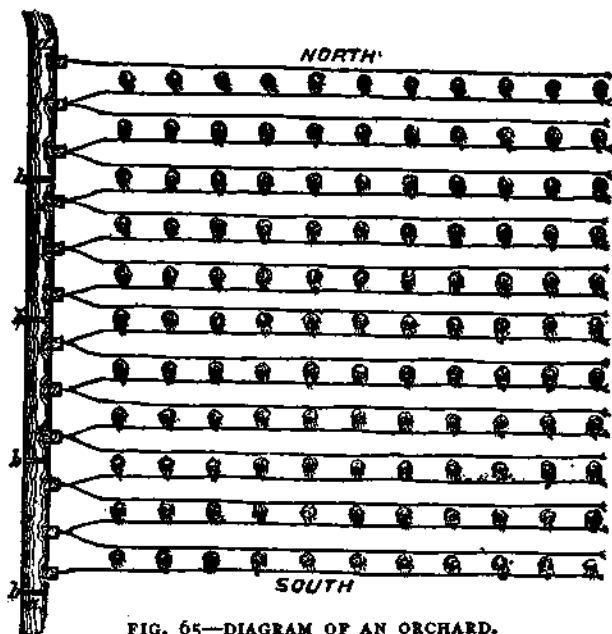

FIG. 65—DIAGRAM OF AN ORCHARD.

tree loaded with fruit will not ripen in the fall. So long as the fruit is on the trees do not stop watering, but soak the whole surface to a good depth.

**Planting.**—A good idea of an irrigated orchard may be gleaned from the diagram of Fig. 65. At *a* is the ditch, *b* are the checks in the ditch, and *c* the head-gates of the furrows.

Plow and subsoil repeatedly, so as to thoroughly pulverize to a depth of twelve to eighteen inches. When planting upon lawns or grass-plots remove the sod for a diameter of four or five feet, and keep this space well worked and free from weeds. Dig the hole deeper and larger than is necessary to admit all the roots in their natural position, keeping the surface and subsoil separate. Cut off the broken and bruised roots and shorten the tops to half a dozen good buds, except for fall planting, when it is better to defer top-pruning until the following spring. If not prepared to plant when the stock arrives, heel in by digging a trench deep enough to admit all the roots, and set the trees therein as thick as they can stand, carefully packing the earth about the roots and taking up when required. Never leave the roots exposed to the sun and air, and puddle before planting. Fill up the hole with surface soil, so that the tree, after the earth is settled, will stand about as it did when in the nursery; but dwarf pears should be planted deep enough to cover the quince stock, upon which they are budded, two or three inches. Work the soil thoroughly among the roots, and when well covered tamp firmly. Set the trees as firmly as a post, but leave the surface filling light and loose. No staking will be required except with very tall trees. Never let manure come in contact with the roots. As soon as planted water thoroughly.

Apple trees can be planted twenty-eight or thirty feet each way, or twenty-four by thirty-six feet, and a pear, cherry, plum, or peach planted between the apple trees in the thirty-six foot space. Raspberries, gooseberries, and currants can be planted in the rows be-



tween the trees, as they require about the same irrigation. Strawberries can be planted in rows four feet apart between the tree rows. Some will say this makes a ragged looking orchard. It does if the trees and bushes are never trimmed, and were planted with no order or system. In transplanting trees it is well to have the ditch water follow in a furrow close to the tree row, so that no time will be lost in moistening the ground and starting the young tree on its new life. A newly set orchard will require more water the first year than any succeeding year, and the writer has made it a point to irrigate every fortnight the first year until September, when all water is shut off.

If the soil is well prepared the work of setting trees can be well performed and with very little trouble. Have the ground moist from fall or winter irrigation, and let the plow go as deep as the horses can pull it, then follow with a subsoiler, if possible. Measure and stake off in both directions. Run a light furrow crosswise of the field. Then with the turning plow lay off in the direction the water is to run, going up and down until a ditch is made as deep and wide as the plow will turn the earth. When this is done very little shoveling will be required to make ample room for the roots of any ordinary tree. By setting the tree at the junction of these cross-furrows very little trouble will be experienced in making the rows line up in all directions.

To distribute the trees place them in a wagon with straw packed around the roots and wet; then drive through the orchard and take out one tree at a time as fast as needed. In the light, fluffy, or chocolate soils

of the arid west trees should be set from two to four inches lower than they stood in the nursery. While one man holds the tree in place and spreads out the roots, another shovels in the fine top-soil until the roots are covered. This is firmed with the foot and more earth thrown in until a mound is formed around the tree. When two or three trees have been set a small stream of water is turned in through a lath funnel in the head ditch. In this way the water runs slowly down the furrow, finds its way around both sides of the mound and soaks thoroughly the earth in which the roots are embedded. In a few days the ground on each side will be dry enough to work, when a furrow should be thrown inward from each side, filling the large furrow, forming a mulch which will hold moisture a long time and leaving a small furrow on each side for after irrigation. The best implement for this is a six-inch Diamond plow and one horse, but if such a plow is not at hand the ground can be cultivated until level with a double shovel or other cultivator. Then furrows may be opened on each side just before the next irrigation.

**Cultivation.**—The tendency of many inexperienced orchardists is to irrigate too frequently and too much at times when water is plentiful, and to endeavor to make this take the place of cultivation. This is a practice very destructive to the growth of all kinds of fruit trees, especially in heavy soils. The tendency of the soil after each irrigation is to sun-bake, and thus prevent a free circulation of air through it. It is for this reason that cultivation almost immediately after the water is drawn off is requisite to successful orchard

growth under irrigation. Often a thorough stirring of the soil is as good, if not better, than an irrigation. Seasons also differ. During some the rainfall is sufficient to carry trees well into the summer without irrigation. If summer and winter mulching is practiced, less water is required, because a good mulch arrests evaporation and preserves an even temperature around the tree. In fact, we have known orchards with a good mulch and thorough cultivation to pass through the season with but one watering. Occasionally the soil is sufficiently moist to permit of this without a mulch if the cultivation is good. But these instances are, of course, the exception, and will not do for a guide in any general sense.

The writer cultivates his orchard mostly with a double shovel five times a year, allowing no grass or weeds to grow, as they greatly aid in harboring mice. We do not grow corn or small grain in the orchard, as these crops take the substance of the soil needed for the trees, which are certainly of sufficient importance to have the benefit of the entire ground. Melons can be grown without detriment. Put no crop in the orchard after the third year. Mulching to delay blooming is not a success. The California plan is to plow the orchard twice annually, the first time as early as February, and again in April. Plow away from the trees the first time and toward the trees the second time. They keep up the cultivation almost constantly throughout the summer, whether irrigation is given or not. Some men use a chisel tooth cultivator, while others use a gang plow. The duck-foot cultivator is a very common implement and gives good satisfaction.

while some men go so far as to employ the one-horse weeder, in connection with other tools. Sandy soils do not require so much plowing as does a stiff soil, and for the latter the rolling cutter has been recommended. Old-fashioned farmers still use the drag harrow.

The author deprecates the use of whiffletrees in an orchard, and uses the patent steel harness, that is devoid of these dangerous things, in orchard cultivation. It is well to observe the flat system of cultivation, and to harrow or scarify the land both ways after each irrigation. By this method the land is easily kept free from weeds, and evaporation by capillary attraction is prevented. New irrigating furrows should be marked out with a shovel plow or a ditcher just before each irrigation; throw the earth back again after irrigation so as to better retain the moisture that has been given. It is well to remember that irrigation can better be dispensed with than can cultivation.

In our western orchards a stratum of hard-pan consisting of a bed of tenacious clay nearly or quite impervious to water is often found a few feet below the surface. If we can make a reservoir of this, putting the water at the bottom where it is protected from the influence of the hot sun and dry wind we have approximated the ideal condition of subirrigation and its attendant capillary action. If we can get the water from underneath without breaking up the dust mulch and prevent the tremendous evaporation which takes place from a saturated surface until cultivation arrests it by restoring the dry-earth mulch, we will accomplish the desired result of putting the water into

the land instead of upon the land. To obtain the best results from irrigating an orchard the furrows should be very deep between the rows. This may be difficult to do in a very dry time. One plan is to go through with an ordinary plow and make a furrow in which to run the water. Turn in a small stream and let it run until the ground is somewhat soaked. A half day's rain is very beneficial in such cases. Then take a coulter plow, called by some a "bull tongue," attach two horses to it and run it down to the beam. An ordinary coulter is about eighteen inches long and two horses can very easily pull it at the depth given. Two furrows between the rows of trees so treated will be about right, but in some soils one may answer. A big stream can be run in such furrows without causing the soil to wash. The second plowing can be done while a small stream is running. A large subsoil plow drawn by a heavier team would serve the purpose so much the better instead of running several streams near the surface in each row space. Such a trench as this will accommodate a good head of water, and if this is allowed to run several hours the roots of the trees will be sufficiently irrigated to last several weeks. This plan seems to be gaining favor in later years.

**The Plowsole.**—There is also found in nearly all orchard soils, especially in irrigated districts, an artificial, shallow hard-pan produced by the repeated action of steel tools in compacting and smoothing the soil particles when in moist condition, just as a mason's trowel smooths and firms mortar to form plaster. When the plowing and cultivation is of uniform depth, this hard-pan becomes a permanent feature. Varying

depths of working the ground are better, but a hardened layer at some depth generally results. It may have been made when the present orchard lands were grain fields or the pasture grounds of vast herds wallowing over them in wet seasons. The existence of the artificially compressed layer or of a natural hard-pan just beneath the tilled surface is manifest to the irrigator by lack of penetration of the water. After running a short time in furrows prepared for the purpose, the resistance proves too great for the water to sink to a depth where it can be of use to the root system, and it wets the surface soil from furrow to furrow, where the need of moisture is least and evaporation is greatest.

It is estimated that in summer 60 per cent. of irrigating water thus applied is lost. Some practical and economical method of subirrigation would prevent this loss. A California man has invented a point or hook to run beneath the line of draft at the bottom of the furrow. This attachment is fastened to the point of the share in front and any blacksmith can make it. This tool will cut through the somewhat impervious layer of soil and make a direct way for the water to enter the lower stratum to be saved and utilized. Dependent upon the nature of the soil, the plow may be drawn by two, three or four horses. In ordinary ground two good horses will draw it at a depth of thirteen inches, where loose soil is usually found beneath the layer of hard-pan. Water running in such furrows immediately over the channel cut through the hard-pan wets below first, and after flowing some time moistens the surface beyond the furrows.

This plow was used within five and a half feet of the trunks of ten-year-old trees on two sides of them, snapping off roots up to an inch in diameter. Irrigation followed in these furrows, and water could sometimes be found by digging in the bottom of the furrows eighteen feet ahead of the point where it disappeared. When the end of the furrow was reached, which was somewhat behind the time of the ordinary surface furrows adjoining, the owner thought that this water was well placed, but was doubtful whether the good was not offset by the damage to tree and crop by the root-cutting. The next irrigation was in another direction. Two surface furrows were made near the rows of trees, as usual on each side of them, and one in the middle of the row spaces with the subsoil furrower, eleven feet distant, and one with the same implement on either side of it, about eight feet from the trees. Few roots, and mostly small ones, were cut in this operation. For six months this treatment was applied and results were satisfactory. There was no unusual dropping of fruit, even in that part of the orchard where the plow ran within five and a half feet of the trees, and they were heavily laden with fruit of normal size. A regular subsoil attachment following right behind the plowshare could be used instead of the hook in front, or a common subsoil plow might be employed to follow in the furrow and cut through the hard-pan.

**Apples.**—This king of fruits may be irrigated in many ways, and a liberal quantity of water is advisable. We have noticed one thing about growing apples under irrigation. By giving them plenty of water when they

are attaining full size, or are nearly full grown, they receive more sap and attain fully one-eighth more weight or specific gravity, compared with similar fruit of the same size. The color of the apple is also greatly improved in this way, and it puts on a polish that could not be attained without irrigation. The characteristic of polishing nicely is noticed principally in the Ben Davis and Jonathan varieties. If the early spring season has been dry the orchard should be irrigated just as soon as the canals are carrying water. If no other circumstances arise it may be deemed advisable to irrigate again every month until the last of August, when water should be discontinued from all fruits. Young trees will take more water than older ones, and a wetting at the time the fruit buds are appearing is quite essential. Give no water at the time of blossoming. After the fruit is half grown it can be forced to greater size by copious irrigations. The apple attains one-tenth of its final size during the last month of maturity. Russian varieties have thick, leathery foliage which cannot readily transpire, and for this reason but very little water should be given at any time.

Of course it must be understood that the management of an orchard in the fall must depend largely on the dryness of the season, the age and fruitage of the trees, as well as their variety and general condition. While young trees not yet in bearing, or those not carrying a load of fruit, may need no water after the 15th of August, it may be quite essential to give waterings to trees heavy in fruition to more thoroughly develop the fruit itself and aid in the picking. It has



often been observed at harvest time that the apples do not come off easily and do not feel right in the hand. Under these circumstances to postpone the picking and irrigate the orchard may require four or five days' time. In twelve hours there will be a noticeable difference; in thirty-six hours the apples will gain in color, plumpness, and size. When picking is resumed the apples will come off nicely and be larger and more highly colored. The gain may be at least ten per cent. This last irrigation affects cherries, plums, and grapes as much or more than apples, and we always irrigate heavily while they are ripening. The keeping qualities are also better.

**Pear.**—This valuable fruit will succeed in most kinds of soil, but flourishes best in rich loamy, or heavy red clayish, or sandy soils. The latter is especially adapted to it if it carries the oxide of iron, an element quite common in many of the mountain districts of the far west. The best kinds to plant for permanent orchard are the standard sorts budded on pear stock, which, if well cared for, should stand for two hundred years. The planting should be sixteen or twenty feet apart. Dwarf pears are best budded on the quince, although this practice forces their blooming period and places them in more imminent danger of spring frosts. Generally speaking, the same amount of water is required as for the apple and plum, and the same general rules, particularly as to cultivation, should be followed. The fruit should never be allowed to become thoroughly ripe on the trees.

**Quince.**—The quince is a valuable fruit that

should find a place in every orchard. In many respects it is superior to pears for home use and is very good for marketing. There are but a few varieties from which to select. The Orange is probably the best to plant. The Portugal is a fancy variety because of its crimson appearance when cooked. Two choice varieties, known as the Van Deman and Santa Rosa, have recently been introduced. A deep, rich soil, free from too much moisture is the most suitable for the quince. It does not require much irrigation. If over-irrigated the trees will become sickly, and the leaves will take on a yellow, deadly color. The trees should be pruned so as to insure good crops and fine specimens. The irrigation furrows should be opened so as to give a downward tendency to the roots. The closest cultivation is to be given and the greater quantity of water for a season should be applied after the fruit is half grown. The quince may be planted in the apple orchard and irrigated in the same way. A pound or two of common salt should be scattered around each tree in the spring.

**Plum.**—This crop is best grown on heavy loam soil or heavy clayish sandy soil, but will generally get along on any kind of soil. Close planting of different varieties together is advisable on account of the necessity of complete pollenization. Native American kinds make the best stock to bud upon. The plum may well succeed the apple for position in an orchard, as it requires as much water, applied in virtually the same way. The wild sorts may often be found growing along perennial streams, with roots constantly in the moisture, and these trees are always reliable for bear-

ing year after year. An even tenure of moisture throughout the growing season would seem to be a normal condition for success with plums.

**Prunes** are becoming a great crop in many of the irrigated portions of Western America, and these localities will some day produce a sufficiency of dried fruit to drive the foreign article almost entirely out of the market. The best California experience is to begin the preparation of the soil for a prune orchard some time previous to planting. It is desirable to thoroughly and deeply plow in the fall, exposing the surface to the air during the winter. Wherever there is hard-pan it should be well broken up. In many instances the soil is fertilized, and in all cases it is well stirred and evenly harrowed. The proper preparation of the soil is a matter of much care and study. The square system is generally preferred in planting, the object being to economize the ground as much as possible, at the same time giving proper consideration to the facility of future care and having an eye to the appearance of the orchard. In the square system the land is laid off in lines crossing each other, trees being planted at each crossing. They are placed twenty feet apart, so that 108 trees are included in an acre. By the quincunx system, which is similar to the square except that the rows are doubled and a tree planted in the center of each square, 199 trees to the acre are provided for, but this is generally with a view to the future removal of the center trees. By the hexagonal system six trees form a hexagon and enclose a seventh, 126 being planted to each acre. The triangular system is similar to the square except

that a line is run diagonally across and a tree planted alternately, forming a triangle.

The prune needs all the strength of the soil. There is none to be spared for weeds. It needs the moisture and the vitalizing forces of the air about its roots. Thorough cultivation and pulverization secures this. The ground is deeply plowed in the spring, except near the tree rows, where the work must be more shallow. Harrowing follows plowing, and then a cultivator or weed cutter is run through the orchard three or four times in the course of the year. The object is to leave a perfectly level and soft surface. The prune bears heavily and thus requires an ample supply of moisture. Prunes will make from forty to sixty, instead of one hundred and twenty, to the pound when liberally supplied with water. The best results from applying water are those obtained during the latter half of the fruit's development.

**The Peach** is the popular crop with those who are situated so fortunately as to grow it. A high, sandy, well-underdrained soil is best for the peach, and much "puttering around" in the soil preparation can be commended. Leave nothing undone in preparing the planting ground. The trees should stand fifteen to eighteen feet apart and should never be older than one year from the bud. All branches should be removed at time of planting, allowing nothing to stand but the straight trunk, which should be cut back to three feet. A northern exposure, or locations exposed to cool breezes night and day in early spring, and where the frost remains in the ground late in the spring, are natural advantages. The soil should

always be cultivated and nothing but hoed crops should be grown in the orchard. After the trees come into bearing nothing should be grown, as they will need all the substance.

Cultivation should begin with the opening of spring, and be kept up until the fruit is plucked. The shortening in of all new growth, and cutting away of all dead and injured wood, must be carefully attended to. During the first year the irrigation should be given in furrows along each side of the row, and some growers even go so far as to make borders around the trees, with earth piled against the trunks so as to prevent contact from water. The water is turned on only as often as the condition of the soil demands. Great injury is often resultant from indiscriminate use of water in peach culture. In irrigated countries the majority of orchardists will turn on the water when the top-soil looks dry, whereas if they would but examine the earth at the roots they would find it damp enough. During the second year it is the custom of some growers to make one border between the rows, and irrigate the entire intermediary space in this way. This is done by one of the best peach growers in the west. After a good soaking a thorough harrowing and leveling down is given. The furrow would answer just as well and would require less water. Mature trees should be well watered from the time the fruit is set until September 1st, after which the irrigations are withheld until December, when the trees are again watered to go into winter quarters. On no account should water be applied at or near the blooming period, as the tendency would be to blast the prospects of a

good yield. With too much water, that is, when the irrigations are too frequent, the leaves of the trees will often turn yellow, owing to the depletion of chlorophyl caused by overirrigation. Modern growers of peach trees north of the 38th parallel have adopted the plan of laying down their trees in winter and covering them with earth, root, stem and branch, keeping them buried until blossoming time in the spring. Wetting the roots at burying time assists in bending the tree down.

Unlike the apple, the peach should not be irrigated at time of plucking, unless the trees are actually suffering for moisture, and this precaution applies particularly to fruit intended for shipment. One grower of our acquaintance having a very fine orchard of Muirs which he was drying thought he would check the ripening of the fruit by thorough irrigation. At the time the water was applied the peaches were of very fine quality and withstood handling well. Within thirty-six hours after the irrigation was completed, however, there was the greatest change imaginable in this fruit. A very slight touch would rub off the skin, the wound would immediately turn black and rapid decay set in. The previous fine and delicate flavor was gone and the fruit when dried shriveled to almost nothing. The frequency of the application will depend almost wholly on the character of the soil and whether the trees are bearing a crop of fruit or not. Suppose a tree which is three years old well supplied with foliage, and consider the amount of evaporating surface the foliage possesses. Is it not apparent that it will make an enormous drain on the soil in a dry atmosphere?

Now suppose this tree four years old and developing a crop of fruit. It will of necessity require more than three times as much moisture for the perfect development of the fruit and wood combined as it did for the wood growth alone.

**Apricots** should be planted, pruned, cultivated, and irrigated the same as the peach. Alkali soil is not a detriment to the apricot if not too strong and often gets the blame that belongs to irrigation. Young apricot trees, after bearing their first crop, should be pruned at once, and the lateral branches only should be shortened in. If irrigation is employed, then water and cultivation must be applied immediately in order to start the tree growing, so that it may develop fruit buds for the next year's crop. If the tree has borne very heavily and the wood growth has been light, better not prune at all, but do not neglect cultivation after the crop is gathered. As this tree gets older it needs scarcely any pruning.

**The Cherry.**—This fine pit fruit is most often planted on very light soils, fifteen to eighteen feet apart, and is at home on ridge land. Trees may be planted in apple orchards, but the irrigation system should be distinct from that of the apple trees. Mulching is not recommended, as it induces the roots to take on an upward tendency, which is to be discountenanced in all irrigated fruits. Cherry trees drop blossoms and fruit sometimes because of a deficiency of lime in the soil; sometimes drouth may cause them to drop, and if the trees have been growing strongly by too much irrigation, unripe wood may have had something to do with it. In the latter case lime worked

into the soil would have an influence for the better. Much good may be done in a dry season by irrigating the trees every ten days after the blossoming period and up to the ripening of the fruit. Once thereafter is usually all the water they will need in the season. Irrigations should generally be of quick duration, so that the land shall not become soaked or water logged. Great caution is advised in applying water to cherry trees of Russian origin, and they actually require but slight moisture to grow and fruit at their best. This from the fact that they come from the high and dry steppes of Russia and naturally need but little water.

**The Orange.**—The orange tree requires an abundance of moisture, and its need of more water is indicated by the curling of its leaves; but excessive irrigation gives rise to diseased conditions, manifested by gum, yellowing of the leaves, and other troubles. The system of irrigation mostly practiced consists in running the water in finely divided streams through furrows three feet apart between the rows of trees from a head ditch, using about twenty inches at a time for ten acres, and continuing the irrigation until the ground is wet to a depth of three or four feet. The irrigation should always be followed by cultivation as soon as the conditions of the soil will permit, and cultivation be continued at intervals for six or eight weeks before another irrigation is given.

The first year of planting very little irrigation is required. In some orchards, after the trees are set out a furrow is run alongside the row with a plow, then water is run down, and a basin made around each tree. This basin is allowed to fill, then it is dammed



up and the water run to the next. When the water has disappeared the ground is leveled to prevent the too rapid evaporation of moisture. This system is continued until the tree becomes at least four years old. After that the orchard is checked off into squares, which are filled up. In the same way a furrow is run down the rows on either side, and the water running in this furrow will soak through. But this practice is not so good as the one that allows the water to soak in the squares, as when the water runs down it will carry with it the necessary fertilizing elements from the trees nearest the ditch. Trees are irrigated during the season as late as October, or even later, without any injury. Four or five wettings of an orange grove in a season are usually sufficient.

There are seasons when oranges drop badly, and some growers ascribe it entirely to hot winds. It is doubtless true that extremely hot weather finds the trees partially dormant, and the damage is wrought on the young, tender oranges before sap starts to flowing freely. The most universal remedy recommended is water, and in so far as it is used to put the tree in good condition, is doubtless effective, although fertilization of the soil may be the thing most needed. The water should be applied two or three weeks prior to the hot or cold weather, or, in other words, the trees should at all times be kept in strong growing condition. To accomplish this, water in abundance down deep in the ground is necessary. Superficial surface irrigating is of but little avail. Those irrigators who apply water in small quantities every week or two, merely running the rill in the furrow till it reaches the lower end, are

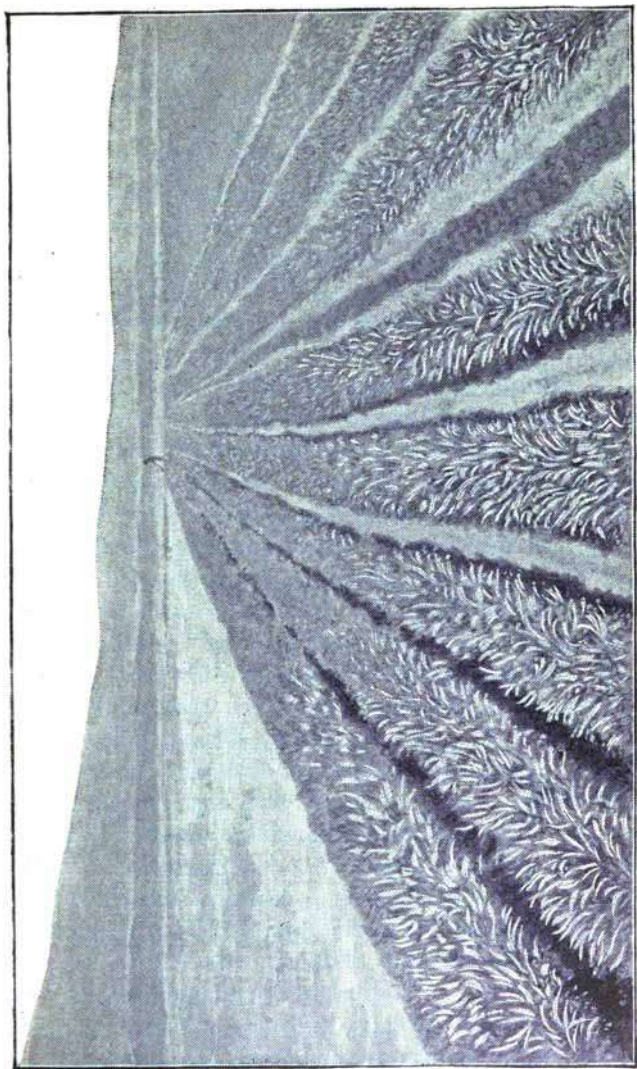

FIG. 66—NURSERY IRRIGATION.

the ones who scarcely ever have a crop, whether the weather is hot or cold, or of the best condition. The most successful growers plan to irrigate every six weeks, running the water eight or ten hours in each furrow. On heavy soil this would not be sufficient, but on sandy loam will probably answer. Following the irrigation, cultivate deeply and thoroughly. It is quite satisfactorily demonstrated in California that puffy oranges are due to uneven or insufficient irrigation.

**Lemons and Limes.**—The highest and driest part of the orchard is the most appropriate place upon which to plant the lemon or the lime tree. It requires a point almost free from frost, and if planted in any other place will probably be a failure. After selecting the proper location the soil should be well broken, so that the roots can utilize the elements of the subsoil. The trees should be planted about twenty-five feet apart and to a depth of two and a half feet, according to the size of the tree. Before planting be sure to cut all particles of damaged roots away. Water should be run around the tree a short time to settle the soil before the last few shovelfuls of earth are put in. The time to plant varies according to the place, but March and April are the months generally conceded by growers in the citrus districts to be the best months. The general ground plan of the lemon grove should be the same as that described for the orange, and application of water is made in much the same way.

**Nuts.**—There is probably as much variation in the irrigation of nut-bearing trees as in a regular orchard plantation. In giving instructions for the irrigation

of such trees we have no great amount of material or precedence upon which to work, but must depend on judgment gained by the natural habits of the trees themselves. The chestnut, for instance, growing naturally on the highest and driest ridges of the Appalachian range, will not require such damp situations and moist feet as the American butternut, the habitat of which is along the sides of streams in the mountains. The most valuable nut tree in America to-day is no doubt the black walnut. It must have deep, rich soil, twelve or fifteen feet to standing water, in a suitable location and with abundance of water for irrigation. The English walnut does not endure too hot or too cold weather. The trees must not be nearer than fifty feet each way and no crops must be raised on the land while the trees are growing. When they are grown they will need all that the richest soil can supply. In full bearing there should be 200 pounds of nuts to the tree, and they must be irrigated when filling or they will not yield well. The almond is as delicate as the peach, and requires quite as skilful irrigation. Care should be used to keep the water from the trunks of the trees. To guard against this it is advisable to ridge the soil around the young trees the first year, running the water a foot or so distant, the second year nearly the same, and the third year at least two feet from the trunk. Irrigation should not be too copious and water must not be allowed to pond near the trees. More trees are lost from this negligence than from all other causes, especially in the case of clay soils. Pecan culture is becoming quite an industry in Texas and other portions of the southwest. The trees do

best when planted on alluvial bottoms, and they will require much the same treatment as the almond, the only difference being in their ability to take more water. The filbert will not suffer especially from liberal irrigation, and the hickory and beechnut can be supplied with more water than is necessary for most trees.

## CHAPTER XV.

### THE VINEYARD AND SMALL FRUITS.

**G**RAPES are among the most variable of fruits even in their wild state, in which climate, soil, shade, humidity, and perhaps natural hybridization have originated such a multiplicity of forms that it is often difficult to distinguish the original types and to refer the different forms to their proper alliances. There are many varieties that thrive well on heavy black loamy sandy soils, some do splendidly on the adobe or clayey soils, and many do all that is possible on red clayish sandy soils. The former and the latter are adapted to the successful cultivation of more varieties than is the adobe.

**The Best Soils.**—The soil best suited to the grape, however, is a loose, porous one, not very wet and not underlaid with water. Whether the soil is sand or clay is not so important as its porosity and ability to quickly lose its excess of moisture after an irrigation or a drenching rain. Grape-vines should not be planted closer than eight feet, and after the first year no crop should be grown between the rows. If the vineyard is large, roadways should be left to haul into it manure and to haul out of it the grapes. The lack of success in cultivating the grape on adobe soil is caused by excessive irrigation—too much water on the surface keeping the soil cold, and invariably

turning the leaves yellow. When there is a porous subsoil grapes do better on an adobe soil. A soil that contains much alkali is not good for grapes. What would be called a sandy soil with a porous subsoil has so far proved to be the best, and the soil should be rich enough to raise a good crop of corn. Constant evaporation of water from the surface of the soil keeps it cold. A warm soil is what makes a good grape. Grapes can be raised with but little water, but the fruit will be small and the bunches imperfect.

**Planting.**—Nearly all the vines sold by nurserymen are from cuttings. Some growers use but a single bud, which requires but a short piece of the vine. Care should be taken to have the soil in good condition—well pulverized, and containing sufficient moisture. The cutting should be placed near the surface with the bud turned up. In order to retain the moisture in the soil it is desirable to use mulching, for without moisture there can be no rooting. The use of a single bud is better adapted to the nursery than to field growth. In the use of long cuttings some use only the growth of the last season, and some use a single piece of the vine having a portion of the older growth as well as the new. But the first named is the more usual practice. The length of cuttings is usually eighteen to twenty inches. Cuttings can be taken from the vines any time after the fall of the leaf, and before the spring flow of the sap begins, but before January 1st is better than after. Keep them dormant until the time comes to set them out in the vineyard, by placing them in a shallow trench, top down, on the north side of a building. Cover the butts with loose earth and place

over that some straw and boards. Take care that the trench is in moist but not wet earth, as too much moisture causes the cuttings to decay. There is as much need of deep and fine working of the soil, pressing it around the cuttings, and for careful culture during the growing season, as there is for the treatment of fruit-tree seedlings or root grafts. In planting a vineyard the vines are placed eight feet apart each way, except in the case of raisin grapes, when space must be provided to spread trays on which the grapes are to be dried. Such plantations are made with the vines 7 x 10, or 8 x 10, or even  $4\frac{1}{2}$  x 11 feet. There is a great variation in the distances. When planting the vines all dead roots should be cut off and the top cut back to two buds or eyes. The holes for planting should be large enough to allow the roots to be spread out in a natural position and the earth should be packed carefully around all the roots. If the soil is not moist when the vines are planted, they should be irrigated at once, or, what is better still, the ground should be well soaked by flooding or otherwise before the planting is done.

**Cultivation.**—Grape-vines the first year after planting should be cultivated the same as corn, using first a two-horse corn cultivator straddling the rows and afterwards passing between them, working the land four times during the season, and also using a hoe near the vines. It pays a large per cent. on the investment to keep the ground mellow and clean. When the ground is kept mellow a harrow is a good tool with which to kill small weeds, using it between the periods of cultivation. Do not attempt to practice



economy by planting some other crop among the grapevines. What is planted may do well, but the vines must suffer. Grapes the second year after planting need the very best care and cultivation that can be given them, for this is the year the canes grow that bear the first crop of fruit. During the growing season of that year great care should be taken to preserve from two to four canes for bearing fruit the next year, by tying them up to stakes or training them on wires.

In trellising posts may be set either in winter or spring, and one wire stretched eighteen inches from the ground, on which to fasten shoots during their growth—one extended each way. By fall these arms will be from six to ten feet long and should be cut back to within three or four feet of the ground. The next spring three more wires should be stretched, twelve inches apart, above the lower wire. The vines should then be tied horizontally along the lower wire, the same as the season before. After growth commences pinch off the buds so that the shoots will be from ten to twelve inches apart. As these grow, train them perpendicularly and tie them to the wires above. No fruit should be allowed to set that season above the second wire from the ground. As these shoots grow pinch them back during the season, after they get above the top wire of the trellis. Laterals will then grow and part of them can be pinched off. A well-appointed trellised vineyard is to be seen in Fig. 67.

One of the best tools with which to cultivate is a one-horse plow with five shovels. A one-horse harrow will also be a very useful aid. The vineyard does not need to be cultivated very deep, but often. The

third and after years, vines must be well cultivated—not less than four times, and six would be better. It will also be necessary to hoe them several times during the season.

**Irrigation.**—The amount of water used and the time for using it depends entirely upon the quality of

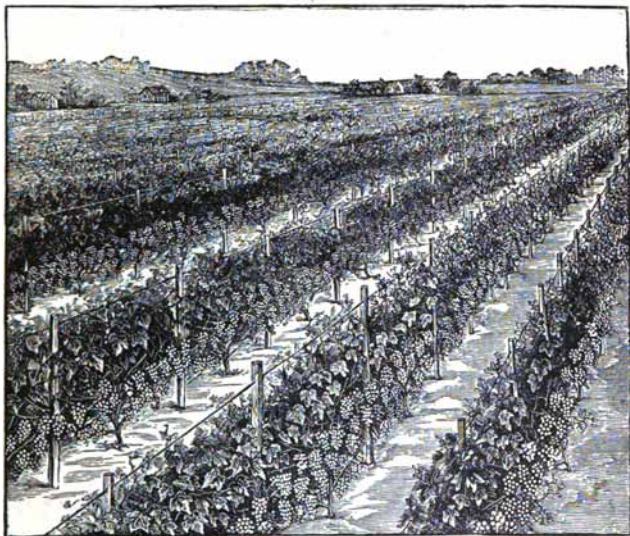

FIG. 67—TRELLISED VINEYARD.

the soil. Give a good soaking about once in two weeks, not oftener. When you do irrigate, irrigate thoroughly or not at all. The second season once in three weeks will be enough. In all cases follow the watering with the cultivation, as described, and do not think of giving the one without the other. After the

vines are bearing heavily they may be watered more liberally. However, even then no more than two irrigations are recommended for compact soils. And even in the lightest and sandiest soils irrigations at periods less than ten days are not practicable. On these light and sandy soils, however, irrigation must be much more frequent than on heavier ones.

The European varieties are especially susceptible to over-irrigation. They are not slow in calling a halt where too much surface water is applied. The vines grow fast and appear to be doing well under repeated irrigations; but the fruit is practically a failure. Where there is any moisture in the soil from fall irrigation or winter rains it is advisable to delay irrigation till the fruit is forming, and then apply the water but once or twice at the most. Never irrigate during the opening of the flower, the least possible during the days before, and by preference irrigate when the fruit begins to enlarge. For inexperienced people, it is more prudent to irrigate in trenches passing near the plants, and not by flooding the whole surface of the ground.

One must introduce in the soil alternately much air and little water. Take as a guide for cultivating, the state of the soil; and for irrigating, the condition of the plant. These very simple principles are not generally understood by those who have not practiced irrigation—they give too much water and too little cultivation, and, above all, give them at improper times. Subsurface irrigation is well adapted to grape culture, as the roots all penetrate to great depth. Where underground pipes are laid near the roots of

the vine, they will in a measure overcome the bad effects of over-irrigation, and carry away much of the surface surplus water. In fertilizing grape-vines the best method is to place the manure on the soil between the vines in rows, and let its strength penetrate to the roots.

**Foreign Grapes.**—There are many warm valleys throughout the Rocky Mountain region, south of the fortieth parallel and west of the Continental divide, where the foreign, European, or California varieties of grapes thrive splendidly under irrigation. It is always quite essential to select land with thorough drainage, and if possible with a slope to the south. Plant the ground so that the rows for irrigating will not be over ten rods in length. Make the rows eight feet apart, and set the plants six feet apart in the row. Different localities must experiment to some extent to find the varieties best adapted to the particular soil and climate. Scorria and decomposed granite can always be chosen as soil well adapted to these fruits. For sheltered localities Muscat, Malaga, Purple Damascus, Rose of Peru, Black Farrar, Black Spanish, Black Hamburg, Flame Tokay, Cornichon, and Sweetwater are suitable. Thompson's Seedless and the Sultana also do well. In localities having frost in winter the vines must be covered. After early frost comes prune off all the vines, leaving only three or four stalks to the plant and from two to three buds to the stalk or vine, always leaving new wood. It is best not to irrigate much the latter part of July and August until the grapes begin to show signs of coloring; then irrigate again, and they will fill out much better and ripen more evenly. Work is

needed in the vineyard before and after the bunches or clusters are formed, pulling out the suckers and pinching back the vines, which draw heavily on the sap that should go to the wood-bearing fruit.

As a general résumé of this entire grape subject, the author would like to repeat a few cautionary remarks. If two-year-old vines of domestic or foreign varieties are well irrigated at the time of planting and once every two weeks afterward it is quite sufficient the first season. The next year once in three weeks is ordinarily quite enough, but keep up cultivation, as it is better than an irrigation. After this three good irrigations during a season is usually quite enough, and vines will do much better than if irrigated every week. Very frequently vines seem to become stunted and the leaves will fall off prematurely. Some people think the vines are then diseased, but the trouble is too much water. Do not let the water stand around the vines more than half an hour during irrigation. If this is neglected there will very likely be trouble, especially with some varieties. In all the irrigation operations it is advisable to direct the water as deeply into the soil as possible in order to create the downward tendency of the roots, especially in the earlier growth of the plants. The deep-trenching system described in the orchard chapter will prove invaluable, but caution must be taken to observe that the underground has perfect drainage.

**Raspberries.**—Any land that will produce good crops of corn or wheat is suitable for raspberries, and, unlike strawberries, they are benefited by a good deal of shade. Prepare the ground thoroughly and manure

liberally. Ground bone is a specific fertilizer for the raspberry. Keep the soil loose and free of weeds throughout the season, cutting down the suckers with a hoe or cultivator, and leaving only three or four canes to a hill or single row for fruiting. Aim to plant an assortment, so as to lengthen the fruiting season. The red varieties should be planted for field culture in rows six feet apart and the plants three feet distant in rows, thus requiring 2,400 plants to the acre, or four feet each way if to be cultivated in hills, requiring 2,700 plants to the acre. It is best to place two plants in each hill, taking, of course, double the number. In garden culture plant three feet apart each way and restrict to hills. As soon as planted cut back the canes to within a few inches of the ground, and plants set in autumn should have the soil mounded up over them to protect them from frequent freezing and thawing. In spring the earth should be leveled down again. In pruning the bearing canes cut them back one-half their length on an average, but all of the same height from the ground. The red raspberry requires a good deal of moisture, and if planted in shady places irrigation need not be so frequent as when occupying dry positions. Raspberries can be planted between the rows in an apple orchard, and in this way they would necessarily receive the same amount of irrigation and cultivation. It is quite essential to irrigate raspberries as soon as the canes are planted, and if an even moisture is kept in the soil throughout the growing season the plants will continue to thrive. It is not advisable to irrigate during the week of blossoming, and water must be withheld after the first of September. We

make it a rule to irrigate raspberries after each picking, as this seems to hasten the maturity of the fruit and develop larger and more salable berries. Black raspberries do not demand as much shade or irrigation as do the red varieties. In October the canes should be laid down and covered with earth for the winter, and it is advisable always to irrigate the entire plantation before the canes are uncovered in the spring, particularly if the ground is dry at the time.

**Blackberries.**—These canes should be laid down in the fall before all the leaves have fallen, for if delayed until later the canes are likely to snap and break. Irrigate generally the same as for raspberries, and give heed to plenty of water during the fruiting period. A safe rule at this time would be to irrigate the rows once a week and keep off the water just as soon as fruitage is over, in order that the wood may harden preparatory for winter. Too much water during the warmer days of summer is likely to encourage the tendency to rust, and this is a matter that must be guarded against by the careful irrigator. Dewberries are a species of vine blackberries that may be treated the same as the cane fruits, only that they are capable of taking more water throughout the season, but may require less, as their foliage is calculated to shade the ground in such a way as to prevent loss of moisture by evaporation. The dewberry will generally take care of all the water that may be given it in moderate doses, and the actual condition of the soil should govern the number of irrigations.

**Gooseberries.**—This fruit is not grown so commonly as it might be, and may be called the neglected

child of the garden. Prepare the soil in the spring by deep plowing—digging is even better. Turn it over to the depth of two feet by first opening a trench, say two feet wide, across the patch. Spread on the surface of the ground well-decomposed manure, not less than three inches deep, while six inches will do better. Then turn it all over into the trench already opened. Do this until the whole of the ground is well cultivated to the depth of two feet, then plant out the bushes four feet apart each way and keep them well cultivated all through the summer. In the fall give a good top-dressing of well-rotted stable manure. Let the winter snow come on it to leach down to the roots. When spring opens turn it all into the ground, and the foundation is laid for producing good gooseberries. During winter prune the bushes vigorously. Have one main trunk if possible, and a head composed of about six branches. Pinch out the growth during summer where it is not wanted, and prune back in winter fully one-third of the summer's growth. The object is to let plenty of light and air into the head of the bush. This will prevent every sign of mildew. If these directions are followed, always bearing in mind to stimulate by annually manuring and thinning out the fruit, berries can be produced of the Whitesmith, Crown Bob or Lancashire Red varieties that will be one and a half inches in length. Two or three good irrigations during the fruiting season should be given, and once a month prior thereto ought to be sufficient.

**Currant** culture should be carried out in much the same way. The actual water required does not differ at all from that demanded by the gooseberry, and the



cultivation of the ground is identically the same. After three years old, all old wood should be cut from the currant bushes, and thus the bush be renewed from year to year. Besides, new growth should be continually shortened-in during the growing season to stimulate production of side branches. Even the laterals should be nipped in a few inches. This will form a strong bush and increase the fruit. There should be an abundance of moisture at fruitage, as it will greatly aid fruit development in size, yield and general appearance. For lack of better sorts the writer is growing the old-fashioned Red Dutch with marked success, but the war upon insects is no small part of the labor involved.

**Cranberries.**—The first requisite is level land in order to flood with water. An adequate supply of fresh water must be at hand on a higher level which can be used for this purpose. The land is first dug over and all the roots taken out, so as to subdue all vegetable growth, which would interfere with the growth of the cranberry plants. The ground is smoothed perfectly level and then is sanded to the depth of four to five inches. The plants are set sixteen inches apart each way. Under such conditions they grow somewhat slowly. This seems necessary to secure best results. A strong, rapid growth means rank vines and little fruit. The vines are of creeping habit similar to the strawberry, making runners that strike root at intervals and throw up fruit branches. Some growers prefer to plant in rows two or three feet apart with trenches between. The object of the sand is to more effectually smother all other vegetation than the cran-

berry vines in the bog and to induce such growth as will give the largest crop of berries. The bogs so treated do not reach full bearing until the fifth year, though there is quite a little fruit borne the second year and more each succeeding one. The expense of establishing such a bog is reckoned at from \$300 to \$500 an acre, and bogs that are well established will last for twenty-five years and longer.

Constant attention is required to keep the bog clear from other growth until the vines cover the ground, and hand-weeding after the first year is all that can be done. The varieties most generally grown are Early Black, Late Dark Red, Cape Cod Beauty, Chitman Bugle, and the McFarland. The usual price for plants among growers is \$3.00 a barrel, and four to five barrels of plants are required to set an acre. Root cuttings are generally used, and root much more quickly than stem cuttings. Of course, entire plants can be set out, but this is unnecessarily expensive where a large area is to be planted. After the bog is established the work is chiefly of light character. An important point in the establishment of a bog is the selection of sand suitable to cover the ground. This should be coarse and of porous nature, which will let the water through readily. If it has some gravel all the better, but it should contain no soil.

By irrigating cranberry bogs two advantages are assured. The vines are protected from the heaving of frost in winter and from the depredations of worms, which are very destructive in spring. Although irrigation is essential in growing cranberries to perfection, good drainage is also necessary and the ordinary system

of drainage is by open ditches. A brook or ditch in most cases supplies a meadow with water, which runs or is lead through. The water is dammed at the lower end of the bog and allowed to back up, thus completely covering it in a few hours. The usual time for flooding is from the last of October to May, and eighteen to twenty-four inches of water is sufficient. Where the vine worm is destructive it is well to flood the ground for twenty-four hours the latter part of June, and other irrigations may be necessary throughout the summer season. Weeds and marsh grass growing among the plants are a great detriment and will soon run them out.

Harvesting time varies with growers in different localities. Berries picked in August are bitter and will not keep so long as those picked later. In order to have the best cranberries, they should not be harvested before the middle of September. Then they will keep well into spring. Before the pickers take the field, lines of twine are usually stretched across the bog so as to make parallel rows about a yard wide. One picker is assigned a place in each of these rows and must pick the berries clean. Pickers seldom earn more than \$3.00 a day by hand-picking, and one must work steadily and rapidly to earn \$2.00. Rakes are not liked by many growers. After the picking is over the berries are screened and sorted. This sorting may be done by hand or by a separator. The latter saves time and labor, but bruises many of the berries, injuring the keeping qualities. The yield of a well-made bog reaches 200 or more barrels to the acre.

**Capers.**—These Asiatic shrubs are not grown much

in America, although their culture here, especially in the arid regions under irrigation, is practicable, and will some day become quite general. The shrub is multiplied by seeds, cuttings or layerings. Plant in the same way as for the grape-vine, but in holes less deep and with shorter cuttings. Sow the seeds in February, or earlier if the climate permits, anywhere in the garden, as lettuce and cabbage seeds are sown, then later on dig out and transplant. Irrigate at once, and again in a few days if the plants show signs of faltering. Replace, the first year, all that may die. Plant in squares from four to five feet distant. Weed very much the first year, and less the following years. Prune the plants each year by cutting the branches nearest the trunk. If in a country where it does not freeze, prune in the fall; if in a country where the winters are severe, trim the branches at eight inches in the fall, cover up with earth before cold weather, and in the spring uncover the plants and trim shorter. Manure now and again, and by preference use bone powder. Irrigate only when the plant suffers and shows the need of water.

**Strawberries.**—If one wishes to experiment in a small way on the efficacy of irrigation, a strawberry bed is a good thing upon which to practice. Strawberries do well on a variety of soils, but as a rule the deep, moist, loamy soil will yield best results. Boggy or swampy spots, however, should be avoided. It is the common experience that light, warm soils yield the earliest and highest flavored berries, and heavy soils the later and larger ones; but the size of the berry depends more upon the supply of available moisture, and

immense fruit can be produced on loose, open soils by free irrigation and the application of plenty of manure. Yet the heavier soil, both because of its usually superior fertility and retention of moisture, is preferred for the strawberry.

Plants for setting out are secured by taking off the small growths rooted from runners. The strongest plants are those nearest to the parent plant. They may be set out either in the spring or fall, or at any time when the ground is warm and in good condition. At planting shorten the roots to three inches, and be sure the plants do not become dry while the planting proceeds. It is advisable to carry the plants in a bucket that has water in it. If plants have been received by mail or express, they are invigorated by soaking in water a few hours before planting.

**Preparing the Soil.**—The first essential for success in strawberry growing is to plow or dig the soil at least ten inches deep, and during the fall or early winter months work in deeply as much composted cow and hen manure as the soil will hold. Have the surface thoroughly pulverized and graded in the spring so that the water will flow slowly in the ditches. The spring plowing should be shallow. There are various ways of laying out strawberry plantations. Some give flat cultivation and plant in single rows two and a half or three feet apart. Others make low ridges two and a half to three feet wide, while between the ridges is a furrow for irrigation which also serves for a passage when the beds are being weeded or the fruit gathered. It is best to arrange these furrows so that the water runs down one furrow and back in the next, the fall

of the land not being as the furrows run, but from the first to the last. Before planting, the water should be run on, so as to see that the irrigation is so arranged that it just reaches to within two inches of the edges of the ridges.

**Planting and Cultivating.**—The plants should be set out a foot apart on the south side of the ridges, two inches above the water-mark, so that the water will not run over the crowns. They then draw up the moisture through the roots by capillary attraction, and the surface of the beds does not bake as it would do by flooding. The fruit is not damaged by muddy water. In transplanting, it is best to have the roots spread out fan-shaped, and the soil should be well packed around them, which we consider of great importance. Plant, if possible, on a cloudy day; but if this cannot be done, the plants must be irrigated at once. Run the cultivator through the patch once a week. A good irrigation every two weeks is usually sufficient during the first season, and when the runners begin to grow train them so that plants will be six inches apart, which gives a narrow row. After the desired space is covered keep the runners cut off. Shading is a great help to newly set plants, especially to those set in late summer or early fall, but of course this is impracticable in the case of extensive planting. Keep the cultivator going and do not allow the plants to suffer for water. As the runners begin to grow, let the inside shovel on the cultivator draw them lengthwise of the rows. As soon as the ground freezes in winter, cover the entire patch with coarse straw, or light barnyard manure, as free from weed seed as may

be. This mulch is to be allowed to remain until the plants show signs of blooming in the spring, when it is to be raked from the rows to the spaces between. Furrows for watering are then to be opened on one or both sides of each row.

**Irrigating.**—The preliminary work of the first year is all that is required in the way of cultivation, and the second year's irrigation need only be sufficient to keep the soil in moist tilth until the critical period of fruitage, when a good deal of irrigation is necessary, but the soil must not become soaked. The fruiting season may be prolonged from four to six weeks by having made a good selection of early and late plants. After the fruit is set use less water on the early varieties and more on the late. It is a good rule to irrigate immediately after the bed or a portion thereof has been picked, as the supplied moisture will be largely instrumental in more perfectly developing the unripened fruit, and bring it to more complete fruition. It is a good plan, in the spring, to remove the winter mulch from the crowns of the plants only, allowing that portion covering the furrows to remain. Irrigation waters passing under this mulch will have a beneficial effect in fertilizing the soil and assisting plant nutrition. After the crop is gathered the mulch may be removed. Some growers go so far as to run a mowing-machine over the patch, set as high as possible, to cut off the tops of leaves and all the new weeds, after which the rubbish is all raked up together and drawn off. Then cultivate through the center of the paths, apply a coat of well-rotted manure all over the ground, harrow and cross-harrow with weights on the drag,

and then flood the water all over the lot and allow it to soak for two days. When again dry cultivate often and irrigate enough only to keep the surface moist. This is done to encourage the new fibrous roots to grow and form new fruit crowns for the succeeding year's crop. The old crowns soon die under this treatment. The winter care is the same as that of the preceding season.

**Subirrigation.**—It is about twenty years since a patent was granted for a system of perforated tiles laid under the surface for watering land, but it was found that the common drain-tiles would answer the same purpose in every respect. There is no doubt that for strawberry culture this mode of irrigation would pay exceedingly well. Tiles are laid in precisely the same manner as for draining, but not so deep and not so far apart. It depends on the nature of the soil how much water is to be supplied, and much pressure is not necessary. With as much as twenty-five pounds to the inch, which is equal to a head of fifty-five feet, the probability is that the water would be forced above the surface and flow on the top. This is not desirable, but only to keep the subsoil moist enough to supply the crops in a dry time. Rows of tiles twelve feet apart have been found sufficient in a light sandy soil, and in a clay it would doubtless be necessary to provide drainage for the surplus, or the distribution must be very carefully made. A small head, three feet for instance, is quite enough to secure the even distribution of the water. As in drainage, the water-supply is carried to the small tiles in larger ones, estimated as to size by the area to be supplied. In fact, it is simply



drainage reversed, and thus everything about it is reversed precisely, the feeding source being equivalent to the outlet of the drains and the discharge corresponding to the collecting tiles in the drains.

**Irrigating from Water-Mains.**—In describing an experiment with irrigation in Eastern Kansas, B. F. Smith, of Lawrence, says: "I laid iron pipe on top of the ground along the roadways through a strawberry patch of two and one-fourth acres. Three hundred of the five hundred feet of pipe used is common inch iron, and two hundred feet is half-inch galvanized iron pipe. At intervals of about one hundred feet are water-cocks, or faucets, for attaching a three-fourths inch rubber hose. This hose, being one hundred feet in length, enabled me to reach the entire berry patch. Beginning at the first faucet I watered all within reach of it, then moved the hose to the second faucet, and so on, till the whole patch was watered. At the commencement of the experiment I used a nozzle in the manner that we water our lawns, but soon discovered that the better way was to dispense with the nozzle, and let the water run out on the rows of berries from the end of the open hose. Water was applied at the rate of about a gallon to every twenty inches in length of row. This amount of water thoroughly soaked the rows, but not the entire space between the rows, which is not necessary to the well-ripening of berries, as the water-supply is wanted among the roots. Then, to have watered the two-foot space between the rows would have taken double the amount of water, with no addition of fruit.

"The irrigation was all done at night. The time taken to go over the patch was twenty-eight hours,

and the cost to apply the water was ten cents an hour. I used 16,000 gallons of water the first application and 10,000 gallons the second application. There was an interval of a week between the waterings. The water company charged fifteen cents for 1,000 gallons. The piping and hose cost \$60; water, \$5.25; application to the plants, \$5.60; total, \$70.85. I got the water-plant ready to work May 19th. Up to this time I had picked the patch over three times, and in my estimate of the crop by those pickings I would have got about seventy-five crates off the patch, but with the use of water I gathered two hundred and twenty-five 24-quart crates of berries. In fact, one hundred and fifty crates might be placed to the credit of my irrigation experiment. One hundred and fifty crates at \$2.10 a crate, the average of the crop, figured up \$315. Subtracting the water expense, \$70.85, we have to the credit of the experiment \$244.15."

## CHAPTER XVI.

### ALL ABOUT ALFALFA.

**A**LFALFA is the greatest forage plant the world has ever known, and should be a special crop with every irrigation farmer. It is known scientifically as *Medicago sativa*, its botanical name. In the Spanish language it is alfalfa, while the French, Swiss, German, and Canadian people call it lucern. It is a leguminous perennial, and properly belongs to the pea-vine family. It is often miscalled a grass. Its term of existence has not been authentically established, but it will last the average age of man, and instead of depleting the soil it has a way, through its root nodules, of constantly replenishing the soil with the nitrogenous fertilizing elements of the atmosphere.

2 The writer once met a venerable padre of Old Mexico, who said his alfalfa patch had been planted over two hundred years, had never been reseeded during that time, and had yielded four crops of hay regularly every year. The history of this most wonderful plant is somewhat shrouded in mystery, but the Grecian historians tell us that it was brought from Media, in Asia, to Greece, in Europe, during the reign of Darius, about five hundred years before Christ. Its culture extended to Rome, thence to the south of France, where it has been a favorite forage plant. It grows

wild with great luxuriance on the pampas of Buenos Ayres. It was brought into Mexico by the early Spanish Conquerors, and from thence found its way,



FIG. 68—ALFALFA PLANT IN FULL BLOOM.

about the middle of the present century, to the Pacific coast country, now Southern California.

It did not reach Colorado, where its growth has attained a state of perfection, until 1862, when a small quantity of seed was brought from Mexico by Major

Jacob Downing, who planted it in a dooryard in Denver, and from whence it spread until to-day it covers many thousands of acres in the Rocky mountain region, and extends out on the great plains as far east as "the Father of Waters." A single stool of the plant is honestly portrayed in Fig. 68, and the illustration is not exaggerated.

**Turkestan Alfalfa.**—The United States Department of Agriculture has of late been taking great credit upon itself for introducing Turkestan alfalfa in this country, and this claim may have some significance with those who do not know that Professor Blount imported seed of the plant to Colorado twenty years previously. After having observed the performance of this variety for several years, the writer is not satisfied that it is any better than our old-fashioned *Medicago sativa*, which is to-day putting more money in the pockets of general farmers than any other known forage plant. There may be some peculiarities about Turkestan which are in reality not advantages. From what we have observed the seed may germinate much quicker and the plants start into growth earlier under the same conditions than common alfalfa. The plants are probably more leafy, but I do not believe they grow more rapidly, nor have a stronger and more vigorous root system. The stems are said to be more slender and less woody, the plants making more nutritious hay of finer quality than the average grade of common alfalfa, for the reason, perchance, that the latter has not been sown properly, and in this connection it might be well to add that this is a very common fault when it comes to quality in the hay. There can

be no doubt that Turkestan will withstand drouth under the same conditions as well as ordinary alfalfa, but at the same time it is apt to succumb more readily to winter-killing.

In concluding our remarks regarding some of the characteristics of Turkestan alfalfa, the writer desires to append the following portion of a communication received in 1901 from a friend in Nebraska:

"I have tested this alfalfa as carefully as any farmer could. I sowed the seed adjoining a piece of common alfalfa and thought I had a bonanza. The second year I cut it when in bloom the same as the common variety, thinking to get seed from the second crop. Not a bloom or seed did I see that fall, and only a six-inch second growth. I blamed a dry spell for the short growth and the failure to seed, notwithstanding the fact that the adjoining plat of common alfalfa went booming right along and made a third crop. In the second year from sowing I was very careful to cut it during a wet spell. This time we got a little better second growth, but it was not half as high as the common variety with no seed. I do not believe this imported variety will ever produce seed on the second crop. During the season of 1900 I determined to let the first crop go to seed, and did succeed in getting a few specimens."

**Alfalfa Soils.**—There is a good deal of misapprehension afloat regarding this or that kind of soil being unsuited to alfalfa culture. As a matter of fact, the soil itself cuts but very little figure in the success of the crop so long as contaminating influences do not come in to lay injury upon it. Any soil will do, so

long as it has a porous substratum for proper drainage, and so that there is no accumulation of surface water to injure the crown and root of the plant. Corn land is just the thing for alfalfa—any soil that is of a friable character answers every need of the plant. And carefully seeded, protected, and cared for in a common-sense way, failure will scarcely result, and winter-killing need not be feared, as the plant is much more hardy than red clover. Bench land is preferable to bottom land, and sandy loam is more desirable than clay, though some clay soils answer well for alfalfa, but the plants are longer in becoming established. Alfalfa should not be sown on sod for the reason that so valuable and permanent a crop should never be laid on a surface rough and difficult of irrigation. Where there is a loamy soil "old land" is best upon which to sow alfalfa, and should be plowed deep, and if not to be irrigated, should be subsoiled. With sandy land over very porous subsoil, where irrigation is not practiced, good success often results from seeding on sod. On land of this nature thorough surface preparation without subsoiling will probably give the most satisfactory results.

**Preparing the Land.**—In starting alfalfa the first point claiming consideration is the selection and preparation of the soil. The plowing should, if possible, be done in the fall, and in the arid regions the use of the subsoil plow is almost an imperative necessity. In the spring, before seeding, the land should be carefully graded to a surface so even as to obviate the necessity for the irrigator ever to step into the growing crop to force the water with a shovel. Who-

ever neglects to do this will, when too late, have abundant and unceasing cause to repent his folly. The labor and cost of grading land at the outset are infinitesimal compared with the aggregate labor and loss incurred in irrigating rough, uneven land twice or thrice each season for an indefinite term of years. In leveling the land for the economical distribution of water by the flooding system, the writer has preferred to use the Shuart land grader, and has completely leveled ten acres a day with this indispensable machine.

After grading, and immediately before sowing the seed, the land should be flooded. A good irrigation at this stage serves a threefold purpose. First, it reveals the high spots, if any remain, and these should at once be worked down and irrigated. As soon thereafter as the ground will bear working, the seed should be sown. Secondly, irrigation before seeding insures the prompt and complete germination of the seed. This is a point of vital importance, for without a dense and uniform stand of plants it is not possible to make a high quality of alfalfa hay. If the stand is thin on the ground the stalks will be coarse, woody, and indigestible, and in curing the leaves will dry and fall off before the stems are sufficiently cured. But if the stand is thick the stems will be fine and the foliage will be so abundant that the curing process can be effected evenly and without perceptible loss of leaves.

**Seeding.**—Of the different modes of seeding with alfalfa, the most common method, when the conditions are favorable, is to scatter the seed over a surface



which has been finely pulverized and not crusted, the sowing being done very early in the spring. The crumbling of the soil after a night's freezing partly or wholly covers the seed, none of which is buried so deep as to prevent germination. The seed is protected with an oily covering or sac, and is not injured by freezing. With spring rains enough to keep the surface moist nearly all will grow. But in most cases all the required conditions for success with this mode of seeding cannot be depended on. The soil well fitted the previous autumn may have become so crusted by an open winter as to prevent the seed from becoming covered by the crumbling soil, or an early drouth may be fatal to the young alfalfa. Farmers who are familiar with the seasons will decide whether to adopt this mode of seeding, or use a later mode by harrowing. Covering the seed by harrowing prevents a part from growing by burying too deep, but the loss of seed in this way is less than many suppose. It is true that alfalfa seed will not grow if buried over an inch in heavy soil, or an inch and a half in a light one. With a light harrow not more than half the seed will be buried too deep, and often not more than a third, and if the soil surface has been well pulverized all the rest will grow. The writer has seen old-fashioned farmers "brushing in" broadcasted seed, and the plan worked all right. In his own experience the writer has always used the modern press drill, with the tubes set at various distances apart, according to the purposes of the crop, whether for pasture, hay, or seed. The variance is from four to nineteen inches. The drill should be run the same way the land slopes, so that irrigation

may follow the drill ways, which is a convenient way of applying the water on the field. Contact of water in irrigation does not injure the plants if the water is not kept on too long at a time and sun-scald is guarded against. Oats or wheat are often put in as a nurse crop, and many contend for this practice, which is condemned by others. The oats are mixed with the alfalfa seed and all sown together. The roots of the grain hold the alfalfa in place during irrigation, and the subsequent quick growth of the grain serves to shade the tender alfalfa shoots from the blistering effects of the noonday sun. In any event, care must be taken that the seed is not planted too deep, thus preventing free germination. Hence, shallow seeding with the drill is advised.

The amount of seed to be sown to an acre will be governed largely by circumstances. Primarily the range is from twelve to thirty pounds to the acre. More is required in broadcasting than in drilling, and for fine hay the stand should be much thicker than when only a seed crop is desired. The amount of grain put in when sown with alfalfa is but a trifle less than the usual demand. When seed alone is the desideratum, the drill should be employed and the tubes set from fifteen to nineteen inches apart, and only twelve to fifteen pounds of seed should be placed on an acre. A good "catch" is more desirable usually than the actual number of pounds to the acre, but a good rule for a common crop would be from fifteen to twenty pounds, and one using this quantity will not go astray in his expectations. It is very difficult to reseed thin patches, as the older growth is so rank that it tends to

choke out the younger shoots. We have found that wherever implements may be used for covering the seed, the work should be followed by a plank drag to smooth and compact the surface. Great care should be exercised, in the selection of seed, to see that the grains are plump and healthy, and that it is scrupulously clean. If there are many shrunken seeds reject the whole lot, for if they sprout at all they will produce only puny, worthless plants. By all means avoid seed that may contain the dodder seed, as this enemy is very fatal to alfalfa.

**Grain with Alfalfa.**—Usually the best grain crop to sow with alfalfa is the second crop of barley—that is, on good fertile soil that has brought a bumper crop of barley and is followed by barley again. Under ordinary conditions the second crop will not be of half the weight in straw and grain as the first crop, and this permits the young alfalfa plants to get a better supply of sun, air, and moisture. In most cases a grain-alfalfa field is irrigated twice, first when the grain is six or eight inches high and fairly well covering the ground, then just before it begins to head out, and if the grain can be cut and hauled off the meadow by August 25th it will be excellent for the alfalfa to give it a third light watering. Usually it is not advisable to irrigate heavily or after the first of September. It will then have ample time to dry out before heavy freezing of the soil, and the young plants will not winter-kill by root freezing or heaving, as will happen in the case of late irrigation. The eastern farmer who literally looks to the heavens for moisture is given to sowing grain and grass seed with a drill. This does

not work in the irrigated mountain states. Sow the grain first. Should it not be permissible to seed with barley, preference should be given to wheat or speltz as a nurse crop over oats. The latter grows too dense on the ground and the blades are too close to afford light, sunshine, and air to the young and tender plants. Grain is better sown with a drill than broadcast.

The form of seeding seems like a trivial matter, but there is good reason why all grain should be drilled in where irrigation is practiced. Young grain in an ideal condition is that which has sprouted and grown quickly, reaching a height of six or eight inches with good root development at the earliest possible moment, so as to get the grain up to the point where the abnormal evaporation of moisture ceases. Broadcasted grain which receives the customary harrowing is never deeply fixed in the soil. Much of it is on the surface, and unless the weather following seeding be wet and cloudy is likely never to sprout. That which is one-half inch under the surface will start growth after that which is two or more inches deep. Again, the shallow-rooted plants do not have a good chance to become established until after those of deeper planting, with the result of deeper growth and development and uneven ripening. All of these conditions are unfavorable to grain production in irrigated sections. On the contrary, in case of drilled grain, the seed is deposited at uniform depth of from two to four inches, depending upon the set of the seeder, is covered with a uniform depth of soil, is subjected to the same amount of moisture, and is bound to germinate more evenly than broadcast grain. At every subsequent stage of develop-

ment the conditions tend to a greater degree of uniformity, so that the drilling in of grain is strongly advocated. The only reason for broadcasting is perhaps that it can be done more speedily and expeditiously. After the grain is drilled in do not harrow until after the alfalfa seed is sown.

**Irrigating.**—The critical time with alfalfa is the first six weeks of its growth. Flooding during this period is quite certain to give the plants a backset from which they seldom fully recover before the second, and sometimes not before the third year, and it is not often in the arid states that rain falls with sufficient frequency to dispense with the necessity for irrigating the plants while small. By soaking the earth from thirty-six to forty-eight hours before seeding, however, the plants will make vigorous growth until they are ten to twelve inches high, after which they may be irrigated with safety. After the plants are up and show well, the first trouble will be the growth of the weeds, which may, if left alone, almost entirely smother the alfalfa. As soon as the weeds seem to be getting the start of the alfalfa, run the mower over the ground, cutting the whole growth down and leaving it just where it fell for a mulch, and if nothing happens the alfalfa will show up first and will make its next growth very quickly, and cover the ground to the exclusion of all else. The writer has received more complaints from friends and subscribers in the east regarding the weed nuisance than from all other difficulties combined, and as a general caution we would advise the use of the mowing-machine, with the sickle-bar set rather high, whenever the weeds seem to be getting the better of the

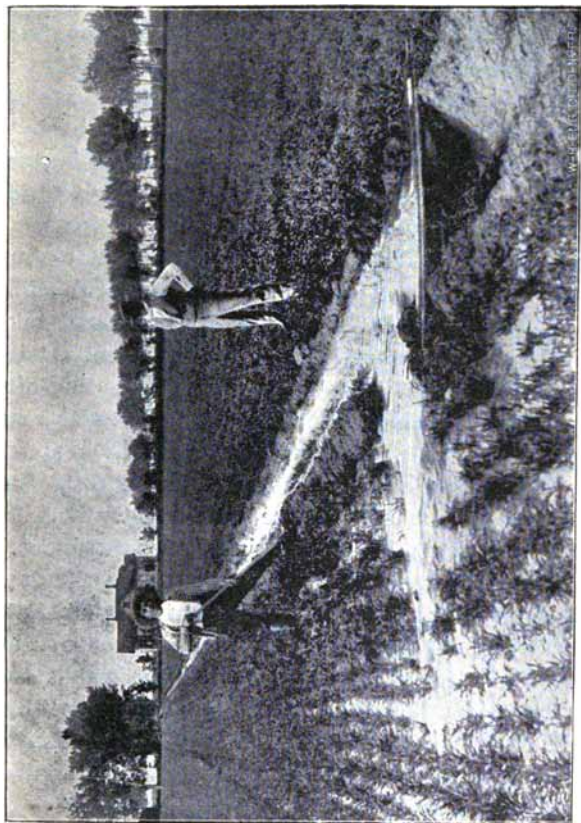

FIG. 69—FLOODING A FIELD OF ALFALFA.

young alfalfa. This will improve the alfalfa by making it more stocky, and stooling out is an advantage at this time. It will also insure more certainty against winter-killing, and will be found advantageous from every point of view.

After alfalfa has become established, a single copious irrigation after each cutting will ordinarily be found sufficient. Irrigation before cutting is undesirable, because it leaves the earth so soft as to interfere with the movement of machinery and loads. It also makes the stalks more sappy, and while they will retain the leaves better there is more difficulty to be experienced in the curing at harvest time; and taken all in all, we much prefer to irrigate after each cutting. Here in Colorado we cut alfalfa three times and often four times in a season, hence the stand gets as many irrigations. Some people irrigate very early in spring-time, before the crowns have awakened from their hibernal rest, but this practice is not right. The chill of the water in very early spring is not conducive to quick growth and may often retard the plants in getting an early start. We do not irrigate prior to the first cutting unless the season is particularly dry and the plants seem to actually demand the water. We irrigate late in the fall and apply a top-dressing of light barnyard manure, which is found to be of great service in several ways. The flooding of a newly cut alfalfa field is shown in Fig. 69.

**Harvesting.**—It must be said of alfalfa that in cutting it for hay a good deal of skill should be employed by the husbandman, or the results may be disappointing. Alfalfa contains six per cent. less water

than does red clover, at the point of blooming, but at the same time it seems to require a more thorough curing process to fit it for the stack or mow. The knack to be acquired is that of curing the hay sufficiently to insure it keeping sweet in the stack without becoming so dry as to shed its leaves in the handling. This cannot possibly be accomplished by curing fully in the swath. A method much practiced is to rake the alfalfa while still quite green into windrows, where it is allowed to cure somewhat more, and finally to rake it into moderate-sized cocks, in which it is allowed to stand until ready for the stack. This process makes very nice hay, but where a large acreage is to be taken care of it is too slow and expensive. Alfalfa may be cured in the windrow with entire success, but it is important when cured in this way that there be ample facilities for putting it into stack very rapidly when ready, otherwise it will become too dry and much of it will be lost in the handling, especially if it has to be carried from the fields on wagons. Alfalfa should be cut on the first appearance of bloom. The old-fashioned "go-devil" is now made in the way of an improved table rake, and the ricker which supplements it at the stack forms a very satisfactory arrangement for gathering the hay crop. By means of these rakes the hay is taken from the windrow by horse-power, and conveyed to the stacks in jags weighing two hundred to four hundred pounds, where it is delivered to the ricker, and by the latter is landed into the middle of the stack. The only hand-work required is the distribution of the hay after it is placed upon the stack. Five men and five horses with two rakes and the ricker



easily put thirty tons of hay a day into stack, at a cost of about thirty-five cents a ton. The great drawback to these rakes is that they can be used to advantage only on short and level hauls. The process of this method may be seen in Fig. 70.

Colonel Lockhart, a leading alfalfa grower of Fowler, Colorado, has simplified the gathering of cut alfalfa in the field by throwing away wagons, "go-devils," and all contrivances except a drag arrangement of his own invention. This is composed of nine boards of Texas pine an inch thick, six inches wide and sixteen feet long. These are placed parallel, leaving six inches of space between each, and all are fastened across the ends with a 2 x 4 laid flat and loosely bolted to the boards. To this is hitched a team of horses, and on it nearly a ton of hay can very easily be hauled to the stack. The drag is hauled alongside a cock of hay. Two men with pitchforks turn over the hay onto the drag, which when loaded is hauled to the stack and dumped onto the sweep which carries it to the top of the stack. The drag will run over all ditches and obstacles, and is the best thing of its kind yet devised.

To facilitate the work of harvesting alfalfa, it is well to have parallel roads thirty rods apart running through the fields. These roads may be protected from irrigating waters by ditches on either side, so that the roadway at no time is flooded. This arrangement allows the alfalfa to be stacked at close proximity, and the plan will be found very convenient. In stacked alfalfa more or less combustion takes place, and it is best to provide ventilators, which may be of headless

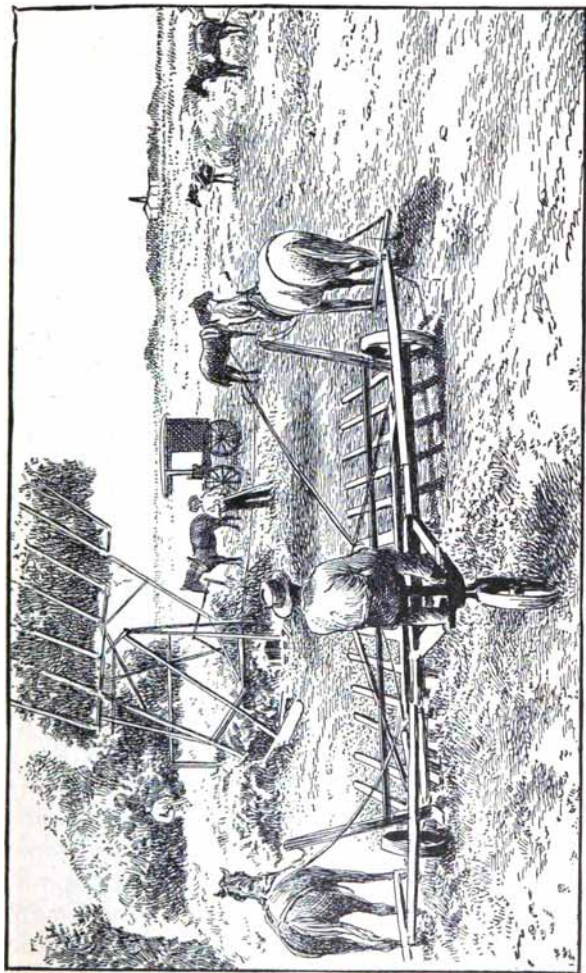

FIG. 70—STACKING ALFALEFA WITH A RICKER.

barrels set on end in the center of the rick; or rails and boards may be employed, a very good plan being that depicted in Fig. 71.

This ventilator is made of two 1 x 3-inch strips nailed three inches apart by crosspieces, so as to form a sort of open box. If a board roof is not desired, the top of the stack may be anchored with fence wire cut in suitable lengths, and these burdened with weights

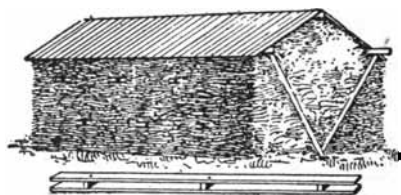

FIG. 71—VENTILATOR FOR ALFALFA STACK.

at each end, so that they will dangle at the sides of the stack. These weights are to prevent the wind from blowing the hay to kingdom come, and are just the thing

for the rainless region. Stack covers with brass string-eyelets are also good weather protectors, and will pay in the long run.

**The Seed Crop.**—There is a little knack in taking alfalfa seed that all irrigation farmers should understand. In cutting the seed do not let it stand till dead ripe, as one-third will rattle off and waste. Cut when the head is handsomely brown and the stalk not quite dead. There will then be scarcely any waste and the seed will be as plump. Many people in gathering alfalfa seed waste at least one-fourth by allowing it to stand too long before cutting. Cut with a mower or reaper—a mower is preferable. Some attach a drag apron and throw off in bunches of medium size and in windrows. Do not handle it much after it is put in the windrows,

as all this tends to rattle the seed out of the legumes, and much of it will be lost in this way. Stack in convenient piles, or into one great stack, as may be preferred, after it is dried thoroughly, and let it go through the sweat at least three weeks before threshing. If placed in large stacks care should be taken to put in stack ventilators, so that the gases will escape without danger of burning, which has a tendency to injure the seed. If threshed in an ordinary machine all the teeth on the cylinders must be used, and it often pays to run it through twice. An alfalfa huller is very necessary to get the best results, and seventy-five bushels is a big day's work. Stock will generally eat the haulm or leavings. The first crop is best calculated for seed, unless perchance it be too rank, when the bolls will turn brown prematurely and the seed itself may not be worth saving. Insects may injure the first crop, in which event the second will have to be depended upon. If hay is hauled from the field on a hay-rack place a wagon cover at the bottom to catch all the loose and falling seed. We usually allow the swaths to remain from three to five days before hauling in the hay, but this is incident upon the almost constant days of sunshine and cloudless skies that we enjoy here in the far west. Seed alfalfa must never be raked, and we deprecate even placing it in cocks. The less handling the better, in avoiding waste. An average yield of seed is all the way from eight to thirteen bushels to the acre when grown under irrigation. In very large areas only half the first crop may be reserved for seed, taking the other half from the second stand. When alfalfa is grown for seed it needs but very little irriga-

tion, probably not more than half the amount that is given to the hay crop.

**Fertilizing Elements.**—Plowing under green alfalfa as a manurial agent and soil restorative is becoming recognized in the west as a very essential agency in preventing soil deterioration. It is therefore a very useful plant in following out a line of crop rotation. As a green manure or soil renovator, alfalfa is hardly equaled by any other plant. It is very rich in phosphoric acid, potash, and lime, and gets a goodly portion of nitrogen from the air, leaving much of this in the soil by means of its large roots. Aside from this, when used as a green manure there is a great deal of humus added to the soil, both by the matter turned under and by the roots. The large, long roots open the subsoil to a great depth, serving much the same purpose as the subsoil plow. The writer once saw an alfalfa root at Las Vegas, New Mexico, that measured thirty-two feet in length and had been secured by some laborers while digging a well in an old alfalfa patch. When once well rooted a stand of alfalfa seems as impregnable as the gates of Hercules, but a stout and sharp sward-plow and four draft-horses will turn down the growth at the rate of two or three acres a day if properly handled.

The extraordinary demand made upon available plant-food in the soil by a crop of alfalfa is something not fully comprehended by all growers of the great legume. These demands are especially noticeable in the case of nitrogen and potash, crops often collecting over one-quarter of a ton of each from an acre in a season. It is universally admitted that the mineral

constituents of plants, such as phosphoric acid, potash, lime, etc., are derived solely and entirely from the soil. In the case of nitrogen, certain leguminous plants, such as alfalfa, clover, and peas, have the power of assimilating large amounts from the atmosphere when sufficient phosphoric acid, potash, and lime are present in the soil. Therefore, while it is quite possible that alfalfa, being a deep-rooting plant, could secure nitrogen from the soil, the probability that it also secures a large quantity from the air enhances its value as an agricultural plant—firstly, because nitrogen is the basis of the compound protein, the most valuable part of the food product; and, secondly, because nitrogen is the most costly element in all fertilizing compounds. When alfalfa is grown and its products are properly utilized upon the farm, it cannot be considered an exhaustive crop, but rather as one fulfilling the proper aim of rational agriculture, which is to transform into produce the raw materials at our disposal in the atmosphere and soil. It has been estimated that the market value of an acre of turned-under green alfalfa is all the way from fifty dollars to eighty dollars, and the experiments along this line have been very carefully made by scientific gentlemen.

**Alfalfa in Rotation.**—With proper rotation with alfalfa as a base, land can be farmed indefinitely with no outlay for fertilizers and without summer fallowing. The object sought in rotation is to produce the greatest possible value and at the same time keep the land in good condition. A farm is assumed to be divided into four equal plats and the following shows the crops to be raised for four years from the sod. A supply of

early and late water is assumed. First year—Plat 1, oats; plat 2, wheat; plat 3, potatoes or corn; plat 4, potatoes or corn. Second year—Plat 1, oats, seed to alfalfa; plat 2, potatoes, plow deep; plat 3, wheat; plat 4, wheat. Third year—Plat 1, alfalfa; plat 2, wheat; plat 3, wheat, seed to alfalfa; plat 4, potatoes, plow deep. Fourth year—Plat 1, turn under alfalfa and plant to potatoes; plat 2, wheat, seed to alfalfa; plat 3, alfalfa; plat 4, oats or wheat. After the fourth year raise two crops of potatoes after alfalfa.

Wheat may follow wheat once. Wheat should never follow oats. Oats had better follow wheat than oats. Alfalfa should be seeded in the spring with wheat or oats and should remain two years after the seeding year. Potatoes should follow alfalfa and may follow potatoes once. The following shows another rotation worked out on this plan, with the exception that alfalfa does not always remain on the ground two years after the planting: First year—Plat 1, wheat; plat 2, wheat; plat 3, oats; plat 4, oats or barley. Second year—Plat 1, wheat, seed to alfalfa; plat 2, potatoes, plow deep; plat 3, potatoes, plow deep; plat 4, oats, seed to alfalfa. Third year—Plat 1, alfalfa; plat 2, wheat, seed to alfalfa; plat 3, potatoes; plat 4, alfalfa. Fourth year—Plat 1, potatoes; plat 2, alfalfa; plat 3, wheat, seed to alfalfa; plat 4, potatoes. Fifth year—Plat 1, potatoes; plat 2, potatoes; plat 3, alfalfa; plat 4, wheat. Sixth year—Plat 1, wheat, seed to alfalfa; plat 2, potatoes; plat 3, alfalfa; plat 4, wheat, seed to alfalfa. Seventh year—Plat 1, alfalfa; plat 2, wheat, seed to alfalfa; plat 3, potatoes; plat 4, alfalfa. The particular plan of rotation adopted by any farmer

will, of course, depend largely upon the character of the water-supply.

**Feeding Value.**—Alfalfa hay is forty-five per cent. better than clover, and sixty per cent. better than timothy. To secure a good milk ration by the use of timothy hay, protein must be supplied from some other source, in order to secure a ration that will give a sufficient amount of that material without entailing a loss of carbohydrates and fat; clover hay, however, is a fairly good ration in itself, and can be economically used without the addition of any other compounds; alfalfa hay, on the other hand, requires the addition of large amounts of both fat and carbohydrates in order to be profitably utilized as a milk ration. This fact renders alfalfa more serviceable than its valuation would indicate, since, in the management of farms either for dairy purposes or for grain farming, an excess of carbohydrates is secured, which in the great majority of cases is wasted. Under ordinary conditions two and a half pounds of protein, four-tenths of a pound of fat, and twelve and a half pounds of carbohydrates can be profitably fed daily to a cow of one thousand pounds live weight. One ton of alfalfa hay, containing 35.3 pounds of digestible fat, 280.1 pounds of digestible protein, and 770.7 pounds of digestible carbohydrates would furnish sufficient protein for one hundred and twelve days, fat for eighty-eight days, and carbohydrates for sixty-one. Therefore, in order to feed this amount of alfalfa economically and profitably, fat sufficient for twenty-four days and carbohydrates for fifty-one days must be added from some other source, such as cornstalks, green fodder corn, or



ensilage, wheat straw, oat straw, root crops, etc. Two tons of a mixture of equal weights of field cornstalks and alfalfa would furnish food sufficient for one hundred and thirty-six days, without noticeable loss of any of the digestible compounds. Four tons of a mixture composed of one ton of alfalfa hay and three tons of corn ensilage, or green fodder corn, would furnish food sufficient for one hundred and thirty-six days without any appreciable loss. Alfalfa, therefore, furnishes a feeding material rich in protein, which can be substituted for such waste products as wheat bran, cotton-seed meal, etc., usually bought in order to profitably utilize the excess of carbohydrates.

There is no way in which more net profit may be secured from an acre of good alfalfa than by pasturing young hogs upon it. One acre should sustain ten to fifteen hogs from spring to fall. If they weigh a hundred pounds each when put on the alfalfa, they should make another hundred pounds. One thousand pounds at five cents is fifty dollars, and there is no expense to be deducted. Six hundred pounds of pork from an acre of corn would be a good yield, and then the expense of cultivating and harvesting and feeding would make a big hole in the net profit. Pork making from alfalfa is one good road to success. Alfalfa hay is used largely in fattening sheep and lambs which get no other ration. Fowls eat it greedily, and it can be relied upon the same as green food, by steaming the hay. Horses can live on alfalfa the year around.

**Diseases and Enemies.**—Some of the alfalfa fields of a humid climate are affected with root rot, which causes the alfalfa to die in almost perfect circles

during June. Cool weather checks the dying until the next June, when a ring of alfalfa dies on the margin of the circle. Its annual spreading indicates a fungous trouble. The disease spreads slowly, about fifty feet each year, and its advance is not stopped by plowing around the diseased spots. Hence the fungus must attack the healthy plants for some time before there are any visible signs of disease. The disease attacks the crown and upper portion of the root, no fungus being found below sixteen inches from the surface. The fungus is identical with the cotton-root rot. Salt, kerosene, and other remedies have been found to be partially effective, but no sure cure or preventive has yet been found.

In other humid climates some farmers have found that the plant is affected with leaf spot. This disease is found in nearly every place where alfalfa is grown in the moist Atlantic states. Usually it does not attack the plant until the second year's growth, when the plant is able to survive the disease. Sometimes, however, it completely destroys seedling plants. The disease shows itself as minute dark-brown spots of irregular shape upon the green or discolored leaflet. The center of each spot forms a pustule. In this are developed the spores, which are set free by the breaking of the epidermis. The disease readily survives the winter, and may develop year after year in the same field. In serious cases, covering with straw and burning will stop the disease. It may be held in check by frequent cuttings.

Dodder is an enemy that has given alfalfa more or less trouble out west. It is a small annual parasitic

plant with yellow or reddish-yellow twining stems, which wind themselves around the stems of alfalfa, clover, or similar plants, near the ground, taking its nourishment from its host. It has small, colorless, scale-like leaves, and produces clusters of ten or more flowers, each of which contains four small grayish seeds which are about half the size of the alfalfa seed. These fall to the ground, where they remain until the next season, when they germinate. The young dodder plant cannot live long in the ground, and unless it finds a host plant, soon dies. Where it is abundant the plants upon which it feeds assume an unhealthy appearance, and finally die. Dodder can be killed by cutting the hay before the dodder blossoms, or by burning it, or by plowing the crop under and cultivating the land for a year or two in corn, potatoes, or other plants which have stems so large that dodder does not live upon them. The plant itself is an annual, and if it is not allowed to go to seed it will die of its own accord. To keep it from seeding, then, is important, and this can be done by running the mowing machine when the alfalfa is half grown, and allowing the hay to wilt on the ground, or it may be raked off, as desired.

The workings of this pestiferous parasite are illustrated in Fig. 73, reproduced from the *American Agriculturist*. From the seed (*e*) a vine grows and clings to the alfalfa stem (*b*) by the sucking root (*c*), through which the dodder thereafter feeds upon the alfalfa sap, the ground roots dying and the vine turning yellow. The slight purplish flowers (*d*) are borne in clusters (*a*). The small dodder seed (*e*) can be removed by a

sieve with twenty meshes to the inch. The vine can be killed by a copperas or sulphate of iron solution.

Another enemy is the alfalfa worm, which acts much like the army worm in destroying leaf, stem, and branch. The midge also burrows into the seed bolls and works great havoc, and a clover-blossom worm

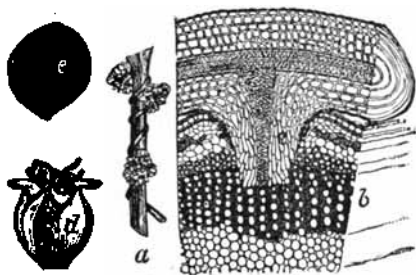

FIG. 73.—DODDER SEED, FLOWER, AND PLANT.

finds its way into alfalfa and works some injury. Flooding an affected field with water will usually do away with the worms.

**Hoove or Bloat.**—The only objection which has been raised against alfalfa as a forage plant is its tendency to cause bloat in ruminating animals. In its component parts there is nothing in alfalfa which would necessarily create hoove, and the only way by which it occurs is when the animal eats too greedily and overgorges itself by taking in greater quantities than it can digest, when gas accumulates and tympany of the first stomach is the inevitable result. It is held that alfalfa grown without irrigation will not cause bloat. Neither will esparcet, which is a plant similar to alfalfa. A

number of preventives have been introduced to alleviate the sufferings of an animal with the hoove, but the trocar is the surest alternative and is usually applied as a last resort. Fig. 74 shows how the instrument may be used.

The veterinarians have a rule for inserting the trocar. They span with outstretched thumb and middle

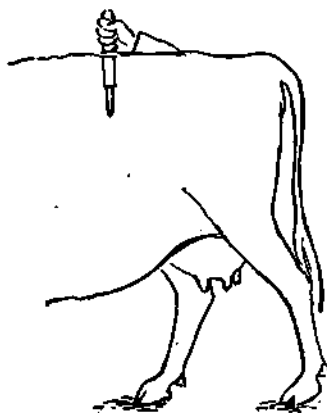

FIG. 74—TROCAR USED FOR BLOAT.

finger for a point at right angles with the chine and hip joint on the left side, plunging the trocar in a downward and inward direction fully six inches, when it should tap the stomach and allow the gas to escape. By planting the trocar at a point equidistant from the hip bone, the last rib and the lateral process, many a valuable animal has been saved when other expedients have failed. The hollow

probang passed into the stomach might give relief, so might a drench of a tablespoonful of hyposulphite of soda, or a rowel in the mouth; but when these fail resort to the trocar and cannula, and the suffering ruminant is saved.

**The Alfalfa Sandwich.**—As a means of utilizing the straw on the farm to best advantage, the plan of mixing it with alfalfa is to be commended. There is great merit in the mixture of green alfalfa and dry

straw for cattle or horse feeding, and those who have given it trial say that the combination of two parts of alfalfa to one of straw in alternating layers makes as valuable fodder, pound for pound, as does alfalfa alone. By this method the worthless straw stack may be converted into valuable feed and manure, and returned to the soil that produced it. The variety of straw used is of little consequence, as wheat, oats, or barley are one and the same apparently after having absorbed the juices and substance of the alfalfa. Cattle will devour every particle of the sandwich, allowing none to go to waste, and some farmers contend that the feed is improved by the addition of straw. One advantage in this system lies in the fact that the alfalfa can be put into stack while almost green and the straw will serve to cure it by absorbing its juices and color. This plan might be called the dry silo, and when properly put up forms a most valuable forage.



## CHAPTER XVII.

### WINDMILLS AND PUMPS.

**D**EVICES almost innumerable are being tested and employed for placing water on land, where canals cannot be utilized or are inadequate. Wind and water power are of course the cheapest forces for this purpose, where they can be relied upon. Hence the marked improvement in windmills and water-wheels.

Pumping water for irrigation has now become so common that the demand for the various kinds of pumps during the past few years has increased very materially. About ten years ago it was almost impossible to purchase a really serviceable pump for irrigation purposes. Such as were then found in the market were designed for water-works plants. Of these perhaps the most efficient was the Holly system. These installations were strong, durable, and costly, and could raise water to the height of 300 feet with apparent ease; but for every 1,000 gallons pumped the cost was from two to four cents, and if used to irrigate the soil the cost would be from \$10 to \$24 an acre annually. It is needless to add that machinery of this character is entirely out of place in the arid region.

The first outlay has to be small, hence western irrigators and those who design the machinery for the west have been studying how they can raise a given

quantity of water and deliver it on the surface in the simplest, cheapest, and most efficient way. To better accomplish this task, the records of all ages in the ancient art of irrigation have been gleaned afresh for new ideas of things that are old. Not content with modern mechanism and with the steam-engine of our day, they have gone back to the more simple contrivances of an earlier period. The old water-wheel, with its skin buckets, rough pin gearing and long sweep, propelled by oxen, has been modernized. Pharaoh himself, if alive again, would admit that western irrigators have made great improvements on the old water-wheels of his realm.

Draft-horses have replaced the Egyptian oxen, and well-designed steel buckets attached to a revolving chain have reduced the friction of the roughly made wooden gearing. The old-fashioned Dutch windmills, which our grandfathers considered veritable Eiffel towers and which still dot the landscape of New England, only interest the artist now. The genius of the American machinist and engineer have made the skeleton of the modern wind-engine to appear like reeds, yet as strong as steel, and the twenty-foot wheels are as readily adjusted as an eagle's wing. The lifting capacity of the windmills is of necessity small, but when one considers the tens of thousands in use, and the small cost of operation and maintenance, the work they perform is enormous. A mill having a ten-foot wheel and exposed to a wind of ten miles an hour will produce one-eighth of a horse-power, while a twenty-two foot wheel in the same wind would produce one horse-power. In other words, if there was no loss by



friction, leakage, etc., a twenty-two foot wheel would raise 200 gallons from a well ten feet deep, which, if kept running continuously at that speed, would irrigate, with the aid of a reservoir, about twenty-five acres of land.

Presuming that all the low lands along the valleys can be irrigated by the use of canals, the question of upland irrigation becomes one of great importance. Admitting that the water-supply is sufficient for the apparatus in use, we will suppose that a farmer desires to irrigate five acres of land, with a possibility of ten, from a one hundred foot well. To assure success for the larger amount of land not less than a fourteen-foot windmill should be purchased. A sixteen-foot would be better. With either of these sizes, and a storage reservoir, it will not be best to guarantee that over eight acres can be irrigated, although there can be no doubt that with the proper use of the water—keeping the mills constantly in use, wetting down the land and completely saturating the soil to the depth of six feet or more, and carefully utilizing all sources of supply—ten acres can be irrigated from this depth by mills of either of these sizes; but only by the best of management, favorable conditions and great care in the handling and distribution of the water, will a fourteen-foot mill irrigate the last amount given. In any event, a storage reservoir at the well is quite essential, and by its presence it is safe to say that all the way from fifteen to forty acres may be irrigated, by employing various mills that may raise water at any distance from ten to one hundred feet.

It is best, in arranging to put in a windmill plant,

to place it on the highest advantageous point on the farm, for the twofold purpose of commanding every passing breeze and of carrying the water that has been raised to its final destination by the gravity process.

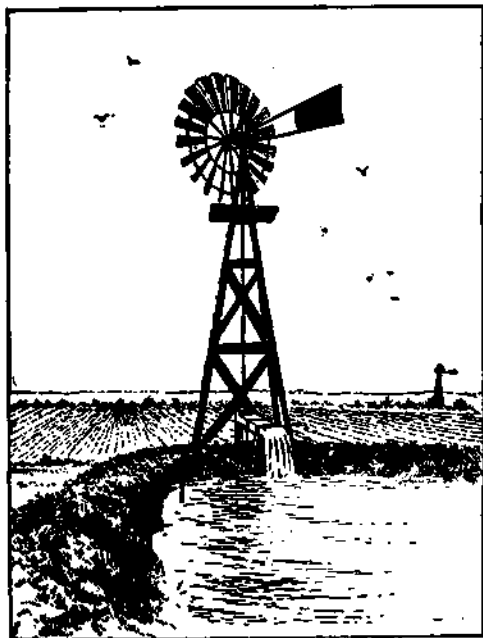

FIG. 75—AN IDEAL WINDMILL AND RESERVOIR PLANT.

There are so many methods of raising water by pumps that the writer despairs of fully covering all of them, and must only be expected to touch upon a few of the most practical ones now in use. An ideal reservoir and wind-engine pumping plant is shown in Fig. 75, and a windmill plant in operation in Fig. 76.

**Buying a Windmill.**—In selecting a windmill the first point to look at is the age and standing of the firm making the article. There is no class of machinery that should be investigated with more care than a windmill. Examine the machine offered and see that it is well built. See that the ironwork is heavy and substantial, the wheel well braced, the journals well babitted, the fans securely fastened to the arms, and that the vane or tail is supported by means of a truss brace. In fact, see that it is not a sham, made to sell and not to work. It must be safe to stand through the heaviest storm. Its strength and apparent construction for durability should be the standard of its worth. The lowest machine in price is not often the cheapest machine to buy.

A first-class windmill should, with a fair amount of care, do good service for twenty to twenty-five years with a very small amount of expense for repairs. Some of the oldest manufacturers can refer to their work that has been in constant service for a longer time than that mentioned. Remember that the tower, pump, tank, etc., that go to make up a complete outfit, all cost as much for a poor, unreliable mill as for a good one. A modern idea is to have an all-steel plant, and this is quite an item for the consideration of those living in the arid regions, where the climate is exceedingly severe on all woodwork. Be sure to get a mill strong enough to do the heaviest work in a light wind, and do not expect a ten-foot wheel to do the work of a fourteen-foot wheel.

There are innumerable designs in patented windmills, and the buyer will have to use his best judgment

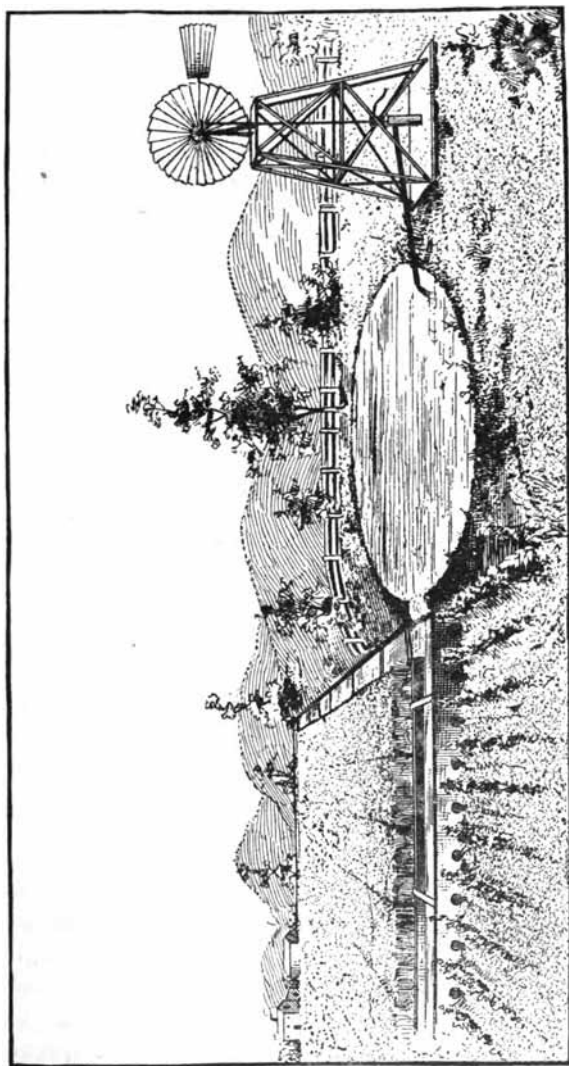

FIG. 76—A WINDMILL PLANT IN OPERATION.

in selecting one best adapted to his peculiar purpose. Of side-vane governor mills, the Corcoran and Eclipse are excellent examples. Of centrifugal kinds the Halliday and Althouse are good examples, the latter being folding and rudderless. The Buchanan is a good example of a special form of wheel dependent for its regulation on the tendency of the wheel to follow in the direction it turns as the velocity and wind-pressure increase. The Stover mill has a solid sail-wheel, with vanes so regulated that it may be reefed, stopped, or otherwise controlled to go slowly in heavy winds. The Perkins mill has a solid wheel with metal vanes, and an automatic rudder, which also acts as a self-regulator. This, like many of the more recent mills with metal vanes, as the Aermotor, Dempster, Currie, Gem, Crane, and Ideal, is back-gearred. The Aermotor is one of the most popular of this class of modern windmills with steel vanes. The Leffel windmill has metal vanes made on a helical curve, and depends for regulation on the fact that the center line of the wheel-shaft stands off from and parallel to the plane of the rudder. Others of the modern type of metal-vane wheels are the Cyclone and the Woodmanse. The Advance is of the automatic-regulating rudder type, and has both steering vane and governing rudder. The Carlyle is a special type, having a rudder arranged to reef the sail in storms, and so attached by an adjustable cam as to cause the center of gravity of the rudder to rise as it falls toward the wheel. The Dempster also has a vaneless wheel for the use of large ranchmen in the open country.

**Erecting Windmills.**—One thing of importance

in this connection is to elevate the tower sufficiently high to place the lower curve of the wheel at least ten feet above all obstructions, such as trees, buildings, hills, etc., that the mill may have a free current of air from all directions. Mistakes are often made in placing mills too low, so that the wheel is below the ridge of barns or tops of trees near by. This not only prevents the mill from receiving the full force of the wind, but subjects it to varying currents that tend to toss the mill about from one point to another and prevent it from doing the work properly—and in strong winds the effect is sometimes damaging. It is better economy to erect a mill too high than too low, as frequently the upper current of air is moving sufficiently to run a mill while it would not run in the lower current. Again, the upper current is more steady at all times, and will run a mill at more uniform speed, with less strain, and with greater satisfaction to all concerned—a little extra material for the tower in the start should not be taken into consideration if it is to effect the workings and safety of the mill for years to come. The most important point of a windmill tower is the anchorage. Probably the best way is to dig holes four feet deep, and fill them with stone laid in water-lime or cement; in this is embedded, to serve as an anchorage, a two-inch bar of iron, with one end flattened and holes punched in it for the tower-bolts. If it is not convenient, posts may be used with pieces spiked across the bottom for anchors; this is the method generally employed. Wooden towers should be well painted every five years. It is not well to enclose a tower with siding. It offers a greater grasp for the wind and adds

but little strength. It is well, however, to enclose the lower sections to form a pump-house. This adds greatly to the strength and appearance.

Such is the popularity of the steel wheel that wherever it has been introduced it has driven the wooden wheel out of the field. The modern steel tower stands straight, stiff, and supreme. It is twice as strong, weighs only one-third as much, and presents less than one-sixth the surface of a wooden tower to the sweep of a storm. It will not decay, and when galvanized is proof against rust. Nothing short of a tornado or cyclone can blow it over. The steel wheel is in keeping with its tower. The fans being made of steel and bent into curved shapes, produce more power by far than a straight wooden slat. This being the case, smaller wheels may be used than if made of wood, for the same amount of work. The wheel being geared so as to require three revolutions to make one stroke of the pump also increases the power. Back-gearing enables the wheel to run at a natural and a more rapid rate of speed.

It is well known that more power can be derived from a fast-running wheel of any description than from a slow one. Economy in buying is extravagance in using. In raising a tower it is best to employ some one who has had experience in that line. Have four hundred or five hundred feet of rope, double tackle-blocks, besides poles for shores to raise it high enough for the blocks to take hold, and guy-ropes to steady it until fastened to posts. Have the posts set, and if on a steel outfit be sure that they are perfectly level or the mill will not be plumb. Steel towers must be raised with

the main castings attached, and the wheel and vane put on afterward, although they may be put on before raising if there is sufficient help. In wooden towers the frames should be raised alone and the castings hoisted into place by means of a gin pole and ropes. Also be sure that the tower is level before fastening to posts. Care must be taken in setting the posts, that they are exactly the right distance apart. Where tanks are desired, it is best to buy them from regular dealers who also furnish instructions for putting them up.

**Care of Windmills.**—A windmill in daily use should be oiled at least every two weeks. This, in icy weather, is no desirable task. Several methods have been introduced to overcome this difficulty. Large storage cups are used by some. One or two firms use what is called a tilting tower. This tower supports a mast pivoted in the center. On one end of this mast is placed the wheel, while the other end is weighted to the weight of the wheel. When oiling is needed the foot of the mast is unlocked and the wheel drawn to the ground. The latest plan introduced to overcome the necessity of oiling is to have all bearing parts made of graphite, which is a composition of brass and black lead, the latter in itself a great lubricator. The makers of these bearings claim that they will last from twenty to twenty-five years. All bolt work on a frame and about the gearing should be carefully watched, and where joints become loosened they should be tightened promptly, as in this way serious loss may often be averted.

**Power of Wind Engines.**—The velocity of the wind and the diameter of the wheel determines the



power. An eight-mile velocity of wind an hour gives a force equal to one-third pound to a square foot, and a fifteen-mile wind gives a force of one pound to a square foot; a twenty-mile wind gives a force of two pounds to a square foot, and a twenty-five-mile wind gives three pounds, while a thirty-mile wind gives a force of about four and one-half pounds to a square foot of wheel surface. Thus it will be seen that the force of the wind increases or decreases in the ratios of the squares of the velocities. A fifteen-mile wind gives a force a little more than three times as great as an eight-mile wind, and just twice as great as a ten-mile wind, while a twenty-mile wind is nearly twice as great as a fifteen-mile wind. The mean average velocity of the wind throughout the United States is a little less than eight miles an hour. In certain sections, as along the sea-coast and throughout the plains and table-lands, the velocity is much greater, while in other sections it is less than the general average. It is, as a rule, safe to figure on eight to ten hours' work out of the twenty-four for the windmill, when the wind velocity will be eight to fifteen miles an hour. At certain seasons, and again in some localities, the velocity will equal fifteen to twenty miles an hour for eight to twelve hours or more out of the twenty-four.

Pumping windmills of the solid wheel type are usually adjusted by regulating their governor, so as to govern when the velocity of the wind reaches fifteen miles an hour. This is to avoid injury to the pump by preventing too rapid action of the pump valves. Back-gearred mills are an exception to this rule, being geared back for the purpose of reducing the number of

strokes of the pump in proportion to the revolutions of the wheel, so as to utilize the greater force of the wind obtained by higher velocity than fifteen miles, and are adjusted to govern at a considerable higher velocity than ungeared mills.

Twenty-seven thousand one hundred and fifty-four gallons of water will cover an acre one inch in depth. One horse-power, with good machinery, will raise this amount of water one foot high in ten minutes; or ten horse-power will raise it in one minute. One horse-power would put one inch of water on one acre, elevated twenty-five feet above the source, in four and one-sixth hours. Ten horse-power would do the same for ten acres. Now from this we get the rule that, for one inch of water on one acre of land, we must figure one horse-power for ten minutes for each foot in height the water must be raised. It may be more explicit to add that one horse-power is defined as the combined pulling strength of four ordinary horses. In theory a horse-power is equal to 33,000 pounds lifted one foot high in one minute of time.

**Capacity of Windmills and Reservoirs.**—The only question with people in general adopting windmill irrigation is one of proper storage and handling of the water. The double reservoir system will be necessary. The figures given for sizes of reservoirs are for holding the water for twenty-four hours continuous pumping; but larger reservoirs should be made of from one to two acres in extent, carrying from 8 to 10 feet of water.

Extra reservoir required to reserve overflow after twenty-four hours' pumping should be of one and two

Size of mill, in feet		Diameter of pump cylinder, in inches	Depth of well in feet	Length of mill stroke, in inches	Number gallons of water at each stroke	Amount of water per hour, in gallons	Amount of water in 24 hours, in gallons	Amount of land that can be covered one foot deep by mills working for 300 days in the year at the rate of fifteen hours per day, acres covered	Size of reservoir capable of holding water for twenty-four hours continuous pumping, on estimate given. Reservoir 4 feet deep; banks 16 feet base, 5 feet high—interior size.
10	8	80	10	11	8,660	87,840			
10	6	50	10	11	2,580	61,920			
10	4	75	10	9	1,890	81,660			
12	11	30	12	41	7,500	180,000	108 acres	90 by 75 feet	
12	8	50	12	31	6,800	151,200	86 acres	90 by 60 feet	
12	6	75	12	11	2,700	64,800	37 acres	60 by 40 feet	
12	4	125	12	9	1,890	81,660	18 acres	50 by 30 feet	
14	12	90	14	61	10,680	254,660	146 acres	125 by 80 feet	
14	10	50	14	41	7,260	174,240	100 acres	90 by 75 feet	
14	8	75	14	29	4,620	100,860	63 acres	75 by 50 feet	
14	6	125	14	11	2,940	71,560	40 acres	65 by 40 feet	
14	4	175	14	1	1,660	40,320	23 acres	50 by 30 feet	
16	5	300	16	11	1,700	47,660	25 acres	50 by 35 feet	

acre sizes, holding from 8 to 16 acre feet of water. Large reservoirs of one and two acre sizes, 8 feet deep; banks 9 feet high, base 45 feet. A square acre is 209 feet on each side. A two-acre reservoir would be 209 x 418 feet.

**The Wind Rustler.**—A queer and simple contrivance this, and quite common in Western Kansas. One of these odd arrangements to attract the curiosity of the modern Don Quixotes of the plains is but poorly illustrated in Fig. 77. In this machine the fans are eight feet long and three feet wide, with their broad-sides placed so as to catch the prevailing north and south winds. The box is a trifle over eight feet square, with the axle of the wheel resting on the top and sides. The lumber had to be hauled fifty miles, and yet the whole plant cost the maker but fifty dollars. The

water was raised forty-five feet and irrigated five acres. Such a mill may give good service where only a small quantity of water is required, or where the mill is not surrounded—nor likely to be—by trees or other obstructions which shut off the winds; but for irri-

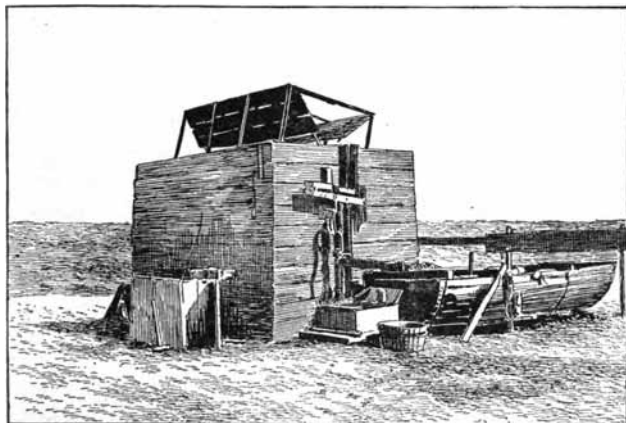

FIG. 77--WIND RUSTLER.

gating considerable tracts, or if trees or buildings are near by north or south, results will scarcely be satisfactory.

Another plan for a wind rustler is used in Nebraska. Four tall posts are set in the ground at proper distances apart. A wooden windlass revolves in boxings attached to the top of each pair of posts. The fans are made of boards set into auger-holes in the middle of the windlass. A small iron crank at one end of the windlass operates the pump.

**Battle-Ax Windmills.**—In its simpler form this is a home-made contrivance which consists of a tower for the support of a horizontal axis and crank, to which arms are attached bearing fanlike blades at the extremities, which have a real or fancied resemblance

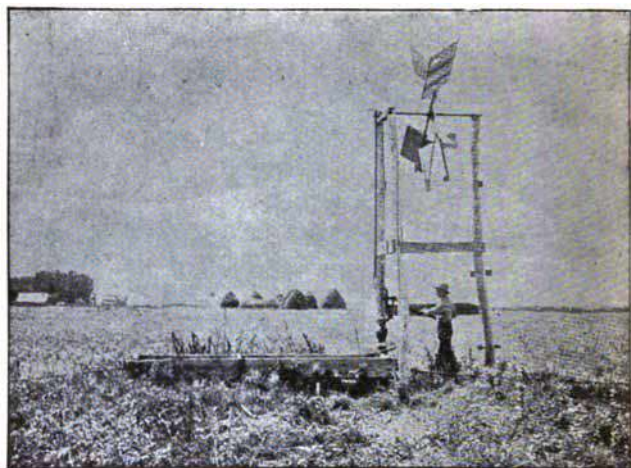

FIG. 78—BATTLE-AX WINDMILL.

to a battle-ax, and which is shown in Fig. 78. When viewed from the side an optical illusion is produced, and these revolving blades seem to be slashing wildly at space in opposite directions. However, they fight their way through, and are victorious mills, worthy of praise. Like the Jumbo wind rustler, the Battle-Ax mill has its axis set in the direction of the prevailing wind—that is, north and south. The axis may be made of wood, rounded to fit in wooden bear-

ings, or it may be of wood, but with metal ends or bearings. It may be gas-pipe shafting, or, as is not uncommon, the axis of a buggy or wagon. This is the fundamental part, and to it are attached the four, also six, eight, or many fans, as the case may be. The Jumbo itself cannot exceed the Battle-Ax in simplicity, cheapness, or power, but the Battle-Ax is presumably the superior in all respects. These mills are simple, cheap, of easy construction, and are quite efficient. In size they run from 8 to 10 feet, the more common sizes, up to more powerful mills, 16 feet in diameter.

**The Merry-Go-Round.**—The Merry-Go-Round is a realization of an attempt to devise home-made mills of unlimited size and strength. The larger ones are of rare occurrence, but are seen in several parts of the far west. The smaller ones are mounted on towers, the larger ones on the ground, as shown in Fig. 79. The former are the more common and look like elevated water-tanks, for which they are often mistaken. The fans revolve around a vertical axis, and surrounding all is a series of movable shutters, which come together and form a sort of closed cylinder when the mill is out of gear. When in action they are partly opened, admitting air to the fan on one side and excluding it from the other.

We have in mind one Merry-Go-Round which is 24 feet in diameter, and carries numerous swinging door-like fans of light wood, 6 feet high by 4 feet wide. The fans are free at one edge, and, like a flag floating from the mast, they swing edgewise against the wind, this being the line of least resistance. The moment the center is past each fan in turn swings back against

the immovable arms and exposes its 24 square feet of surface to the impact of the wind. Half the fans are thus continually in the wind and half out of it. Such a mill, well made, might be an engine of strength, but careful work and well-considered plans are necessary

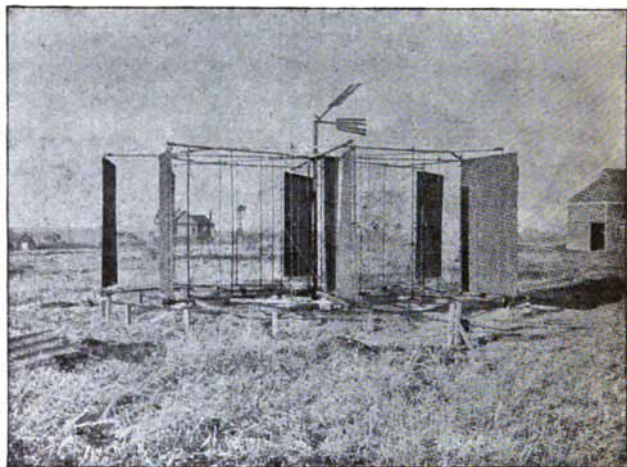

FIG. 79—THE MERRY-GO-ROUND.

to avoid resistance and loss of power. This is probably the cheapest and most efficient mill for its weight that can be built. This mill costs \$4.75, exclusive of home labor, pumps an 8-inch stream, and irrigates 10 acres. The mill shown in Fig. 79 is a more elaborate mechanism, as it is 40 feet in diameter and 12 to 14 feet high. It runs on a circular steel-rail track, and is connected by cog-wheels to a tumbling shaft, which drives the pumping machinery.

**Pumps.**—There are four distinct types of pumps—the plunger or piston pump, which includes the windmill, steam, and many devices of power pumps; the vacuum, the rotary, and the centrifugal, besides elevators which raise water by means of flights attached to an endless chain. The plunger pump, of necessity, moves the water more slowly, as it only travels at the speed of the piston. The plunger pump also is designed especially for handling clear water—grit, sand, and foreign material cut the pistons and barrel of the pump. While these pumps will move the water slowly, they will move it a long distance, or against heavy pressure when properly designed. The pumps of next greatest capacity are the rotary pumps. Of these there are many designs. They handle water much faster than do plunger pumps, but as it is essential that the working parts of these pumps should fit closely, there is necessarily great friction and corresponding loss of efficiency, and hence they are short-lived, especially when pumping water that is muddy or gritty. The pumps of greatest utility for low lifts are the centrifugal pumps. These are built with no close-fitting parts and no valves; consequently there is no friction on the parts of the machinery, and they are not affected by sand, mud, or gritty water. Hence, for irrigation, where the lift does not exceed fifty feet, centrifugal pumps are recognized by all hydraulic engineers as the most efficient and durable, the cheapest and best. The vacuum pump is an entirely different principle, having no movable parts, except a small automatic shifting-bar in the yoke to operate the valves. These pumps are made with a pair of cylin-



ders working alternately as the atmospheric pressure is removed from them, thus allowing the water to rush in and discharge itself. They are useful only for small lifts, and theoretically are not calculated to raise water more than twenty feet. Some are submerged, while others are placed on the surface over the well.

**Various Pumps.**—One of the best piston pumps for windmills is the Gause, which is very effective when



FIG. 80—GAUSE PUMP  
AND POINTS.

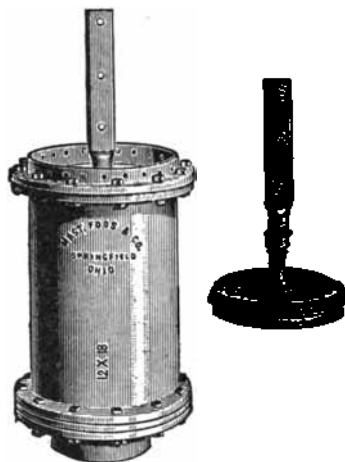

FIG. 81—IRRIGATION PUMP  
CYLINDER.

operated in connection with the point system, as shown in Fig. 80. This pump is largely used in Western Kansas. In many of the piston pumps for wind power it is advisable to use an irrigation cylinder in the well.

The Buckeye is porcelain lined, and it is said to be very efficient. The simplicity of this barrel is to be seen by a glance at Fig. 81. Another piston pump is the Frizell, and there are many more of equal merit and efficiency. One of the best pumps is the Allweiler—known to the trade as the Berlin—and for very deep wells and the wind engine it is to be commended. It is an oscillating force-pump, and is illustrated in Fig. 82. These pumps will draw water from twenty to twenty-eight feet, and will force it up from one hundred to three hundred feet, according to the size of the pumps. These pumps are worked by a lever which may be placed in either a vertical or horizontal position by hand as well as by steam or windmill power. They were awarded the highest diploma and medal at the Columbian Exposition. One of these pumps was put in as a public experiment at Goodland, Kansas, and raised a four-inch stream one hundred and eighty feet, furnishing enough water to irrigate fifteen acres. The whole plant cost three hundred and eighty dollars, including forty dollars for the reservoir.

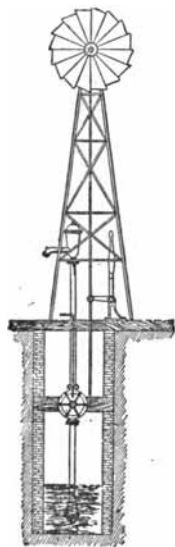

FIG. 82—BERLIN  
OSCILLATING PUMP.

In rotary pumps there are several good styles. The Wonder pump is quite popular when worked with a gasoline engine and belt power. It is very simple in construction and operation, having no valves. It does

well with tubular wells and will readily lift three hundred gallons a minute.

The Lambing pump, made in Denver, is rapidly coming to the front. It is a rotary force-pump and has a capacity of from two hundred to six thousand gallons a minute, according to the size. The writer

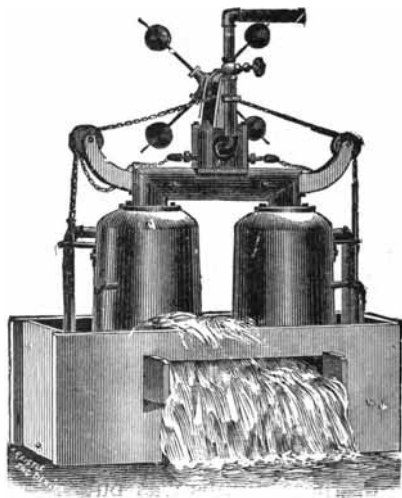

FIG. 83—THE LOW-LIFT VACUUM PUMP.

has seen the smallest Lambing run by a water-wheel raising two hundred and fifty gallons a minute forty feet above the stream. The water-wheel was supplied from a power ditch and the pump took up the water that was discharged from the wheel. A water motor or a turbine would have answered in the same way.

**Vacuum-Pumps.**—These clever contrivances are used quite extensively in the west and in the rice-fields

of the south. There are two kinds shown in Figs. 83 and 84. The one shown in Fig. 83 is the Huffer patent and is calculated to lift water twenty feet or less and discharge it at the pump on the surface of the ground. The other is the Rogers patent and is made for deep wells—not to exceed one hundred feet, however. It has a stand-pipe for taking the water at the pump, which is set in the well just above the water-line, and carrying to the surface, where it is discharged. The mechanism is simple, consisting of two vertical cylinders attached to a single suction-pipe below and connected above by a sliding steam-valve contrived for automatic movement, allowing steam to enter the cylinders alternately, where it is condensed, creating a vacuum

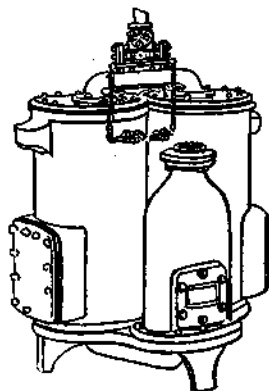

FIG. 84—HIGH-LIFT  
VACUUM PUMP.

into which the water rises by the pressure of the atmosphere, escaping from one cylinder while the other is filling, thus giving a continuous flow varying from fifty to three thousand gallons a minute, or a three hundred and thirty inch stream under a four-inch head for the largest sized pump. Other forms of vacuum pumps are the Pulsometer, Nye and Swan, the latter, however, working by steam and hot air combined, requiring high-pressure boilers and an air condenser, and making in all a rather expensive plant. We are not exactly satisfied thus far with the operation

of these vacuum-pumps, and would rather place dependence upon the duplex compound pumps with condensers. In these pumps the steam works expansively, first in the high-pressure cylinders, and then, by exhaust, into the opposite low-pressure cylinders, the high and low pressure cylinders being tandem on the cylinder, and the condensers returning hot water to the boiler and saving valuable fuel.

**Centrifugals.**—These pumps are worked by stationary engines and are quite generally used by sewer

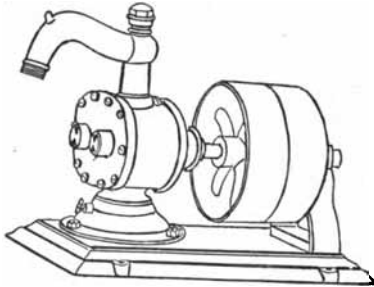

FIG. 85—CENTRIFUGAL PUMP.

contractors. They are good for low lifts, and will throw sand and gravel readily. On a twenty-foot lift a No. 1  $\frac{3}{4}$  Van Wie pump will irrigate ten acres of land and require a two horse-power engine. A No. 2 pump will supply twenty

acres, requiring three horse-power. No. 3 pump, forty acres, with six horse-power engine. No. 4 pump, eighty acres, with ten horse-power engine. No. 6 pump, 160 acres, with twenty horse-power engine. No. 8 pump, 320 acres, with forty horse-power engine. The writer once saw an ordinary ten horse-power threshing engine drive a No. 8 pump, raising water enough—4,500 gallons a minute—to irrigate 320 acres of land easily. The exterior view of a centrifugal pump is shown in Fig. 85.

**The Propeller Pump.**—The basic principle of this pump is that the water is lifted by screws, somewhat similar to propeller screws, termed “runners,” each consisting of two half-circular inclined blades fastened to a shaft at intervals of three to five feet, and of slightly less diameter than the casing, so as to revolve freely within the well-casing, with a boxing for the shaft placed immediately underneath each of the runners. The boxing is held in position by a set of spring blades, termed “guides,” set lengthwise of and engaging the well-casing, and thereby held firmly in position, and so arranged as to interrupt the whirling motion imparted to the water as it is thrown upward by the spiral action of the runners, and to turn the water back in the opposite direction, thereby delivering it into the revolving blades of the runners in a direction opposite to that in which the runners are rotating. By this method the whirling motion of the water is utilized and the capacity of the pump largely augmented without increase of power. With this pump water may be raised from several hundred feet below the surface by extending the shaft and runners down the well-casing the desired depth, it being necessary, however, to always have the lower runner submerged in water.

As the shaft rotates the lower runner lifts the water up to the runner above it, and that one to the next, and so on until the water is delivered to the surface, or above the surface if desired, the distance depending upon the size and pitch of the runners, the number of runners, and the speed at which they are run. No increase of speed is required for additional depth,

because more runners are added as the depth is increased. This compounding of the runners increases the efficiency of the pump, for whatever number of pounds pressure is exerted on the water by one runner in lifting it at a given rate of speed is repeated by each of the runners. For example, if one runner running at a given rate of speed gives ten pounds pressure to a square inch, then two runners would give twenty pounds; three, thirty pounds, and so on. For this reason water may be elevated higher above the discharge with this pump than can be done with a centrifugal. These pumps are provided with ball-bearings so arranged as to hold the shaft and runners suspended in the well, and to carry the entire weight of all the movable parts of the pump, and also the entire weight of the column of water, thereby making a great saving of power. For extreme deep lifts, cone roller-bearings are used in place of the ball-bearings. One of these pumps in fourteen hours raised 1,190,000 gallons of water, 100 feet through a 10-inch casing with a thirty horse-power engine. Another pump raised 190 miner's inches 50 feet with twenty horse-power.

**Hydraulic Rams.**—These machines have been very much improved of late years, and are now quite extensively depended upon for domestic and irrigating water-supply in the west and south. The principle on which the hydraulic ram works is simple and easily understood. A hydraulic ram consists of three parts—two valves and an air-chamber. In Fig. 86 will be seen the working parts of a ram exposed to view. *J* is the air-chamber; *P*, delivery pipe; *N*, overflow; *A*,

drive pipe connection; *B*, base; *M*, spring supply pipe; *O*, check-valve.

The chamber is bolted onto a frame which forms, at one end, an entrance into the ram for the supply of water, and connected at the other end with the outside, or impetus, valve. This frame also contains, placed at

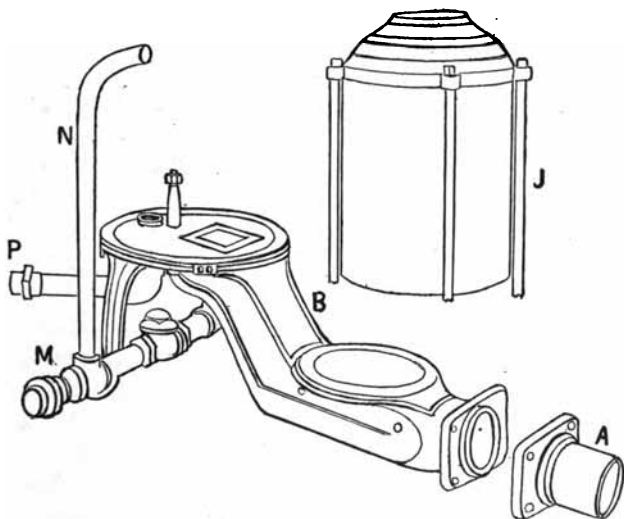

FIG. 86—HYDRAULIC RAM IN PARTS.

right angles with the supply passage, outlets for the water discharged to the reservoir. There is an opening just above the supply-water passage into the air-chamber through its valve. The outside, or impetus, valve is so arranged—by bending upward the end of the supply passage—that when it is closed, by being forced or held up against its seat, no water can escape;



and when it falls down of its own weight, or is held down, the water can flow freely from the ram. This is all there is to a hydraulic ram, and as there are but two valves to wear it will last a lifetime.

The operation in forcing the water is as simple as the means. The water is brought to the ram through a supply pipe laid on an incline. Through this the water flows downward and out at the impetus valve until it has acquired power, by its velocity, to throw the valve up and close it. The momentum, or force, of this falling stream of water continues, and it finds an outlet through the valve in the air-chamber, which opens. The water continues to pour into the air-chamber until the pressure of the air is equal to that of the head of water. This closes the air-chamber valve and confines the water which has been let in. At the same time the impetus-valve opens of its own weight, as the pressure of the water in the supply pipe has been overcome by the pressure of the air in the air-chamber, and the water commences to waste as before. While the water is wasting at the impetus-valve, the expansion of the air in the air-chamber forces the water out through the discharge pipe. This operation will continue as long as the working parts keep in good condition and the water supply lasts.

The supply must be from four to twelve feet higher than the location of the ram, and from twelve to one hundred and fifty feet distant from it. In locating a ram, not only the fall and distance must be taken into consideration, but some means of draining the waste water from the ram must be provided. If the ram must be located in a pit to get the desired fall, a drain must

be provided, starting from the bottom of the pit. If it is not practicable to locate the ram the desired distance from the supply, a number of coils may be made in the pipe. In this manner a ram may be located directly under the supply, and will work equally well. The supply must determine the size of the pipe to be used. Never use a ram that is too large for the supply. If the supply pipe is not kept full the ram will

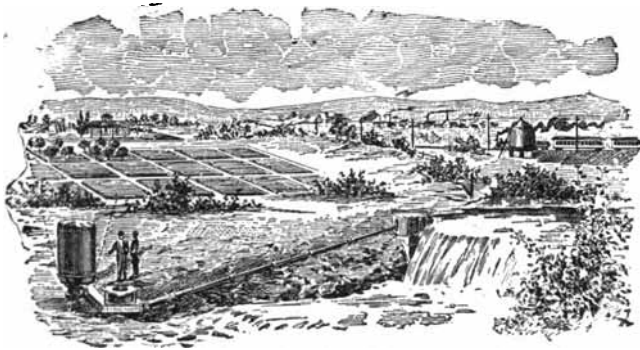

FIG. 87—HYDRAULIC ENGINE IN OPERATION.

not work to advantage, and will eventually stop and give trouble. Fig. 87 illustrates a ram operating under very favorable circumstances.

The water can be discharged to an elevation several times the fall of the water from the reservoir to the ram, the greatest fall causing the discharge of the greatest amount of water at a given height, or a given amount of water to a greater height. Or, in other words, about one-seventh of the water furnished to the ram may be raised to a height of four times the height of the supply, one-fourteenth to eight times the height of

the supply, one-twenty-eighth to sixteen times the height of the supply, and so on. The manufacturer of Rife's ram gives the following rule for ascertaining how many gallons may be delivered in an hour: Multiply the number of gallons the ram will receive through the supply pipe a minute by the feet in fall. Multiply the product by forty, then divide by the number of feet the water is to be elevated above the ram. The result will be the number of gallons delivered in an hour.

**Water-Motors.**—In large streams of steady current the Harvey water-motor, an outline of which is

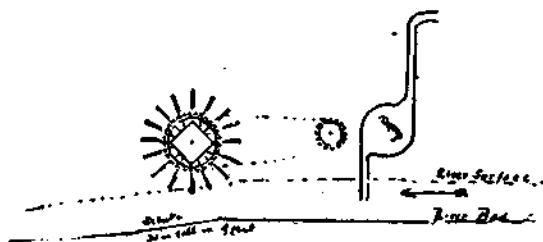

FIG. 88—HARVEY WATER-MOTOR.

given in Fig. 88, is considered quite a success in lifting water for irrigation. By the use of wing dams in the stream the force of the current operates directly upon the wheel at the lower point of the dams, and in this way power is created for running a centrifugal pump. The wheel is a combination of an undershot and breast wheel hung on a swinging frame, and is balanced by a counterweight. Its gearing is a sprocket-wheel, so that it can be raised or lowered with the varying rise or fall of the river without any readjustment of gear-

ing. Mr. F. H. Harvey's wheel at Douglas, Wyoming, is ten feet in diameter, fourteen feet long, and secures sixty horse-power, operating a  $3\frac{1}{2}$ -inch pump, which delivers one hundred gallons of water a minute to a height of sixteen feet. The same power is sufficient to operate a five-inch pump, which would raise seven thousand gallons a minute. The cost of the wheel compared with what it accomplishes is but a trifle. Labor and material, including the pump on the Harvey plant, amounted to \$1,200. As much of the work was experimental, it was necessarily slow. A like plant can be put in for \$800, and most of the work can be done by the farmer. The daily expense of operation is merely nominal, and it requires no attendance except to oil the machinery occasionally.

**The Hurdy-Gurdy.**—This is a late improvement which is best illustrated in Fig. 89, which shows the runner only and does not include the gearing. This wheel is of the impulse and reaction class especially adapted to high heads and mountain streams. This cascade wheel has been placed under heads as high as seven hundred feet, and is capable of utilizing head pressures as high as 2,000 to 2,500 feet. The water is admitted to the wheel by means of nozzles projecting one or more jets, which strike the circular ridge dividing the water into equal portions, passing into the buckets, the buckets alternating to the jet, the arrangement giving ninety per cent. of efficiency. The gearing of this wheel is easily applied to rotary or centrifugal pumps, and water is raised in this way. The turbine class of water-wheels operates upon a different principle. Turbines are submerged entirely under the

water, which gives them their power upon a different place, they receiving this power from the pressure and reaction of the water. A more primitive affair having the same object in view is the common water-wheel often seen in the west. Every one knows of the stern-wheel steamboats that navigate shallow streams. These

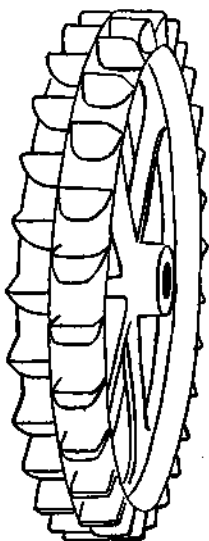

FIG. 89.  
THE HURDY-GURDY.

afford an instance of the kind of wheel to be used—simply a large one with paddles or floats on the end of the arms, by which the current of the stream turns the wheel; and by means of proper gearing the motion is conveyed to a pump, by which the water of the stream may be raised through pipes to reasonable height and distance. A stream nine feet deep and one hundred feet wide flowing four miles an hour will exert a very great power. A common float or paddle-wheel twenty feet in diameter working in a stream of this kind will make four revolutions in a minute, which by cheap gearing may operate a pump with sixty strokes a minute, this being more

than ample to raise water sixty feet in sufficient quantity to irrigate twenty to forty acres of land. The cost of such a wheel would be quite small, not over \$50. The wheel should be submerged over eighteen inches in the water, which will be the width of the floats. If more power is desired, the floats may be increased in

width. It will be the square feet of area of each float submerged at one time that will be the measure of the power in a uniform current.

The current, or bucket, wheel is quite an institution in many large streams, and it is a good thing where the current is steady and strong. By attaching buckets to its arms or sweeps, sufficient water can be raised to irrigate small tracts close to the stream. The turning of the wheel by the current at the same time fills the buckets, which are emptied at a certain height into a trough or flume, and in this way the water is carried to the land.

**Gasoline Engines.**—Very effective pump power can be gained by the use of the portable gasoline engine, which consists of base, cylinder, piston, connecting-rod, crank-shaft, and fly-wheels. The *modus operandi* and the development of power is as follows: In starting up, on the first outstroke of the piston a mixture of air impregnated with the proper amount of gasoline is drawn into the cylinder, passing through the valve chambers. On the instroke of the piston, this mixture in the cylinder is compressed into space between the cylinder-head and the piston. The combustible mixture is then ignited by the most reliable, safe, and simple device possible—a short iron tube closed at the outer end and connected to the interior of the cylinder, enclosed in a chimney and heated by a burner; and the air being expanded by the heat involved, an impulse is given to the piston. When the piston has reached the second outstroke the exhaust-valve is opened and remains open during the second instroke of the piston, and the products of combustion

are expelled through the exhaust-pipe, which is conducted to the outer air.

It has been found that the cost of a twenty horse-power gasoline engine is about \$1,450, and a thirty horse-power about \$2,000. The cost of running the first will be about forty cents an hour, and the second sixty cents. The amount of water raised will depend upon the lift, the kind of pump used, and the general arrangement of the plant. Assuming a lift of ten feet, a twenty horse-power engine should lift about five hundred inches, and a thirty horse-power about seven hundred and fifty inches. For engines to raise one or two inches continuous flow the expense would be somewhat greater in proportion. The cost of operating these engines in localities where seventy-four degree gasoline can be obtained in quantities at ten cents a gallon, is one cent for each exerted horse-power per minute.

**Hot-Air Engines.**—These are constructed almost wholly for pumping purposes, the motive power and pumping apparatus being combined in one machine inseparably connected in one frame. As its name implies, the power is furnished by the heating of air, which being forced into a cylinder when cold, expands with the application of heat; and the alternate heating and cooling of the air as it passes in and out of the cylinders furnishes the motive power. The hot-air engine is not adapted to heavy work, such as the steam-engine. After fire has been applied for a short time, and the air in the chamber has expanded, it is necessary before the engine will start to turn the balance-wheel. This requires the strength of a man, but

after turning the wheel once around the engine can take care of itself, and any child old enough to place a shovelful of coal in the fire-box of a stove, and who can be trusted to handle a fire can then operate the engine an entire day.

The cost of operating is small, and wood, coal, or cobs can be utilized. A kerosene oil attachment is always furnished. When oil is used the flow is self-regulating, and after starting the engine it requires no further attention for eight or ten hours. A special pump is necessary, which is furnished with the engine. The hot-air engine makes from 80 to 160 strokes a minute, and its capacity ranges from a few gallons to one-tenth of an acre foot a minute, equivalent to two-tenths of an acre foot a day of twenty-four hours, limited by the height of lift which varies from a few yards to 500 feet. The price of the hot-air engine, including pump, etc., is from \$300 to \$600, according to size of cylinder, the former price being for a six-inch and the latter for a ten-inch cylinder. As the six-inch cylinder is as small as should be used for deep well pumping, it is readily seen that the cost has prevented more general introduction of this device for pumping water on the farms of the west.

**Compressed Air.**—Modern science is actively at work endeavoring to employ air in raising water from wells, and two or three feasible plans have already been devised. One is the Chapman process, illustrated in Fig. 90, which shows the apparatus as devised for a well. By means of the proper machinery the injected air causes the well to flow. Air is forced down the small pipe, comes up in a cone shape, filling the well-



pipe and carrying the water with its force. It also lightens the water column and causes the water to flow through the pipes in torrents.

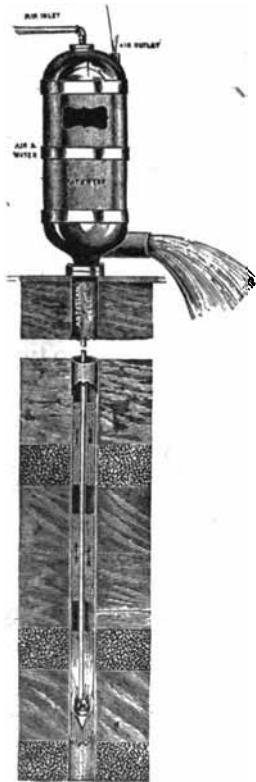

FIG. 90.

AIR COMPRESSOR.

It is suitable to be used in wells of any depth, and any number of wells at any distance apart can be operated from one engine. It is claimed that by this system more water can be raised than by any other, but to the writer's mind this claim is not wholly clear. Another scheme is Merrill's pneumatic system, by which water may be elevated from as many sources as may be desired. Fig. 91 represents two sources, with wind and gasoline engine power, arranged to use separately or in combination. The plan is said to be entirely practicable. In the cut, *A* is the compressor; *B*, the air-pipe leading to the well; *C*, the injector in the bottom of the well; *D*, a similar arrangement in the other well; *E* is the discharge pipe, and *F* is the bank or reservoir. The same power can be utilized, by gearing and belts, in doing a great

amount of work, such as churning, grinding, etc. One man can attend to the whole outfit, and if the

water-lifting arrangement is not as yet wholly complete, Yankee ingenuity will soon make it so, as the principle is all right.

**Repairs of Windmills.**—At least once a year a windmill pumping plant should be overhauled and put in repair. First the pump should be repacked, if the valves leak. The check-valve must be absolutely

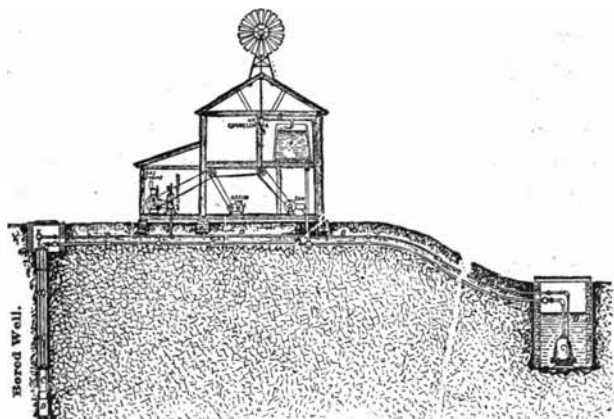

FIG. 91—THE PNEUMATIC SYSTEM.

water-tight. Not a particle of water must run through when the valve is shut. If it does the pump-pipe will become empty and the water will not start for a time, nor will it start at all without priming if the check-valve is above the water-level in the well. The piston-valve must be renewed when worn, otherwise but part of the water is raised with the stroke, and when the wind is light the windmill will run without raising any water; this would be dangerous, for at a certain speed

the mill will pump just fast enough to freeze water in the pump, when an increased wind will smash things. Put both valves in perfect order. As for the windmill, if a solid wheel, see that the brake is adjusted so that it will hold the wheel motionless when out of wind. If the brake has too light pressure, a change of wind, if the wind is light, will turn the wheel slowly without acting on the vane, and it will pump slowly and freeze the water. The main things are tight valves, so that water will be pumped when the windmill turns, no matter how slowly; a small vent to let the water back after pumping ceases—small enough so it will not allow water to run out fast enough, when pumping slowly, to cut off the flow from the spout—and a tight brake to hold the wheel perfectly motionless when turned out of wind. If wooden tanks leak from shrinkage the evil can soon be remedied by throwing in a quart or so of bran, which will soon fill the crevices and stop leakage.

**Cost of Lifting Water.**—The cost of furnishing the power by means of steam varies according to the amount to be furnished and the cost of fuel. It requires the same labor to attend a five horse-power boiler and engine as it would require for a fifty horse-power outfit. It will probably average twenty-five to thirty-five cents for each horse-power for the operation of any plant of ten to twenty-five horse-power capacity. Say it costs thirty cents; then the cost of putting one inch of water on twenty-four acres a day would be three dollars for a twenty-five foot elevation, or twelve and one-half cents an acre. Or, in other words, a two-inch flow on each acre could be obtained for twenty-

five cents if produced by steam. A centrifugal pump, driven by a gasoline engine, would accomplish the same result at an expenditure not to exceed eight or nine cents. This engine needs no attention. It uses but one gallon of gasoline for each horse-power in a day of ten hours. Wind engine power costs so little that the total annual expense of operation is merely nominal. A good windmill plant with a reservoir large enough to irrigate ten or fifteen acres need not cost to exceed three hundred dollars originally, and such an installation would last for years.

**Capacity of Pumps.**—The quantity of water a windmill will lift into a reservoir during an average of eight hours' run a day depends entirely on conditions. If a mill of a given capacity has to lift the water from a considerable depth, it cannot raise as much as if the water is lifted only a few feet. For this reason, in the latter case a larger sized pump may be operated by the same force exerted on a smaller size, when the water is taken from a considerable depth.

Theoretically, one horse-power will raise a five-inch column of water one hundred feet, a six-inch column seventy feet, and an eight-inch column forty feet; additional horse-power will elevate the water in direct proportion. A ten-foot mill will develop one-half of one horse-power; a twelve-foot mill three-fourths horse-power; a fourteen-foot mill one horse-power, and each additional two feet in diameter of wheel develops practically one additional horse-power up to a thirty-foot mill, which develops eight horse-power. The cost of the mill ranges from forty dollars for the smallest size, up to four hundred dollars for the largest.

A five-inch pump geared to run forty-eight eight-inch strokes a minute will discharge 1,860 gallons of water an hour; a six-inch pump geared in the same way will discharge 2,760 gallons an hour, and an eight-inch pump will discharge 4,860 gallons an hour. A reservoir one hundred feet square by four feet will contain 40,000 cubic feet, or about 300,000 gallons of water. A five-inch pump discharging 1,860 gallons an hour will in one-third of a day, or eight hours, discharge 14,880 gallons. In twenty days of eight hours each—this is assuming that the windmill runs one-third of the time—297,600 gallons of water will be secured, practically filling the 300,000 gallon reservoir. During the six months from April to September, inclusive, there are nine periods of twenty days each. Therefore, the reservoir can be emptied and refilled nine times during the six months, resulting in an aggregate of 2,700,000 gallons of water for irrigation purposes, equal to 360,000 cubic feet. This is sufficient water-supply to irrigate ten or eleven acres of ordinary soil nine times during the season, which would be the maximum number of wettings. A steam-pumping plant with a fifty horse-power engine will raise 7,500,000 gallons of water to a height of ten feet every ten hours. This amount of water will cover twenty-three acres to the depth of a foot in the period mentioned. The cost of the plant will approximate \$3,000. It will require one man to operate it, and about one ton of coal daily to keep it in operation. In many places wood is so abundant and cheap that coal is not needed to be used, while in numerous localities straw or cobs may be burned, thereby reducing the cost of

fuel to a minimum. A four-inch centrifugal pump, with a gasoline engine of two and one-half net horsepower, will raise 9,000 gallons of water an hour twenty-five feet vertically, and it can be operated twenty-four hours a day, or less, as desired.

**Pumping from Quicksand.**—It is easy and economical to secure a supply of water by means of pumps placed along the banks of our ordinary prairie streams. A well can be sumped to give a moderate amount of water at comparatively small expense, but an attempt to pump enough water to cover 300 acres or so a day would be undertaking a very difficult task. A trough, or long well, seems to be quite feasible, and would be practical if it could be secured to a sufficient depth; but it is quite difficult to dig a well in the quicksand over five or six feet deep made in this shape. There are, however, three different kinds of wells which can be placed in quicksands. The most substantial and costly is the sinking of a rock wall. This is a very expensive job. The next best is a circular well of sufficient diameter to give a required amount of water, which may be termed an open brick wall. It should be built of vitrified brick, with the back filled with gravel. No cement or mortar whatever is needed, but an opening of from one-fourth to one-half inch should be left between the ends of the bricks. This space will allow the water at all stages to come in through the sides of the wall, as well as up from the bottom. In sinking a solid rock wall all water is necessarily shut out from the sides, leaving only the bottom from which water can come in.

If a well can be secured with four feet of lift with

which to start, by the time the pump has been running a short time the water will have been lowered to a level of twelve to fifteen feet, and if the bottom of the well is located in gravel strata, as it should be, chances are good that a well ten feet in diameter will supply two twelve-inch pumps. One four-horse gasoline engine costing about \$250 will operate these two pumps. The two pumps would cost \$100, the pump-jack and walking-beams \$100 more, making \$450, or, for a safe estimate, \$500 for the plant after the well and water-supply have been secured. It is a difficult matter to estimate the cost of the material for such a well. With hard brick at \$10 a thousand, a well ten feet in diameter and twenty feet deep can be put in for \$500, making a complete plant capable of supplying two twelve-inch pumps, or 422,640 gallons in twenty-four hours. It is estimated that this would cover from sixteen to twenty acres of ground every twenty-four hours, with a first cost of from \$1,000 to \$1,200. These plants could be duplicated about 1,000 feet apart until the necessary amount has been secured to supply the land under the ditch.

This is one of the most practical ways of securing water along insufficient streams, although a cheaper well can be made with what is called perforated casting. This casting, made of galvanized sheet steel and thoroughly riveted together, is pressed down into the sand and the sand subsequently baled out from the inside. After it has been carried down to the desired depth the bottom is filled with gravel or rock to prevent the sand from rising. The pump can be lowered into these tubes, leaving them in an almost open body

of water, as the castings are perforated with inch slots the entire length. The greatest difficulty in putting them in would be the encountering of boulders or rock in the sand, which would cause loss of labor on a well, as the pipe would have to be pulled up and removed to another point.

Another satisfactory well which is very substantial and will last a lifetime is that which is known as the Cook tubular well. This is made by sinking a series of pipes, eight or ten inches in diameter, down to a gravel stratum through the quicksand. This gravel affords good pressure, which will raise the water up to or a little above the original water-level. When these points are put down into the gravel and four or five of them are connected to one powerful pump, about 1,000 gallons a minute can be pumped from them from one year's end to another. Many portions of our western territory must sooner or later depend on pump-water for irrigation along its valleys and rivers during the middle of the summer. Owners should put installations at their places sufficient to supply their farms without the use of the river.



## CHAPTER XVIII.

### DEVICES, APPLIANCES AND CONTRIVANCES.



HERE are innumerable devices in use in irrigating operations, some of which may be of home-made construction, and these the author will describe but briefly, after having given the details for a city sewerage system as applied to irrigation operations near several western cities. We include this reference to sewerage in this chapter not because it properly belongs herein, but from the fact that space forbids a separate chapter devoted to it and there is no other place in which it might properly appear.

In irrigation work the operator needs first of all things a pair of heavy rubber boots and a long-handled, round-pointed shovel. These might well constitute his entire working outfit, and with a simple knowledge of irrigation, as we have endeavored to present in the preceding pages, he is ready to do a day's work in any field requiring the magic touch of the vivifying waters.

**A Sewage System.**—The rich fertilizing elements of the city sewers may often be carried out upon garden tracts, and there applied to the best possible advantage. The writer will describe the system in vogue at Trinidad, Colorado, which may answer for all. This sewer is constructed of eighteen-inch vitrified pipe laid to a grade of two-tenths of a foot in one

hundred feet to the mile, the sewer having a velocity of 2.58 feet a second of time when running full. The sewer, unfortunately, had to cross the Las Animas river, which was accomplished by the means of an inverted siphon made of sixteen-inch cast-iron pipe having a masonry catch-basin at either end, as shown in Fig. 92. The siphon carries a current having a velocity of 4.68 feet a second when running full, a rather high velocity being necessary to keep it from choking. A masonry chamber is built at the mouth of the outlet, from which the sewer is conducted to various reservoirs. There are automatic flushers at



FIG. 92.—INVERTED SEWER SYSTEM.

the head of each lateral, so that the sewage is well diluted by the time it reaches the final outlet, very little solid matter remaining. The sewage might just as well be delivered into open ditches from the siphon catchment, and these could serve as head ditches at the land to be irrigated, provided, of course, the grade would be sufficient. In winter the surplus sewage might be conducted to various reservoirs, where it could be stored or allowed to seep away as desired.

In selecting ground for a sewage farm account must be taken of the relative elevation of the land, and of the town, manufacturing establishment, or residence from which the material comes. Whenever possible, as a matter of economy, the farm should be selected

with reference to the sewage reaching it by gravity. If, however, the location does not admit of such procedure, pumps may be utilized, although this frequently will entail considerable additional expense in first cost of plant as well as in the annual outlay for operation and maintenance. In some cases, where land can be reached by gravity by going considerable distance or can be covered by pumping within a short distance, carefully prepared estimates, taking into account all the elements of first cost, as well as the annual cost of maintenance and operation, may show that it is cheaper to deliver the sewage a long distance by gravity than a shorter distance by pumping.

Formerly it was also considered important to select a sewage farm with reference to the surrounding inhabitation, because there was prejudice against such farms on account of the assumed liability to effluvia nuisance. This objection has much less weight now than it formerly had, because experience has fully demonstrated that with proper management a sewage farm is no more objectionable on account of bad smells than any other form of farming.

For best results the top-soil of a sewage farm should be of permeable character, with a gravelly or sandy subsoil. If it is compact clay the sewage cannot enter, and the only purification attained will be that due to coming in contact with the soil by flowing over it. It is possible to so treat sewage and prepare a farm as to attain a very high degree of purification even with clay soils, but the chance of doing this at commercial profit is exceedingly small. If not naturally level or of very uniform slope, a sewage farm for best results

should be leveled, so that the sewage may flow equally over every portion. It should also be laid out with distributing channels having a proper inclination, in order to deliver the sewage readily to all parts of the farm. Formerly it was considered necessary that the carriers be lined with earthenware, concrete, or other impervious material, to prevent the sewage sinking into the ground during its passage along them, but now the more ordinary practice is simply to make earth ditches with flat slopes. As to the best size of the field for irrigation, everything depends upon the quantity of sewage to be disposed of and the character of the soil. Any ordinary crop can be grown by this system.

**Artesian Well Machinery.**—The success of artesian wells in some sections is phenomenal, and they prove a valuable acquisition in irrigation advancement where artesian basins exist not too far from the surface. A very good well, suitable for irrigation purposes, is to be seen in Fig. 93.

The cost of an artesian well not over five hundred feet deep ought not to exceed one dollar a foot, including casing, and contractors will do the work for this sum. The cost of sinking generally increases more rapidly than the depth, so that except in cases of easy boring, or great supplies of water, it will not pay to attempt deep wells for irrigation purposes. The temperature increases with the depth, which is an advantage if the water is to be immediately applied, but the water is also more mineralized, which is a disadvantage, or not, according to the character of the solids present.

There are three systems of well-boring employed in artesian work. For shallow wells the spring-pole is the cheapest means as well as the slowest, and is often resorted to by a farmer desiring to dig his own well at small expense. A more pretentious outfit is such an one



FIG. 93—ARTESIAN WELL.

as is shown in Fig. 94. In this machine the band-wheel is turned by a belt from the engine. When drilling elliptic gears revolve, which raise and lower the drill as the hole is deepened. A hand-wheel having a worm is turned to unwind a rope on the drum that lowers the drill. The elliptic gears are engaged

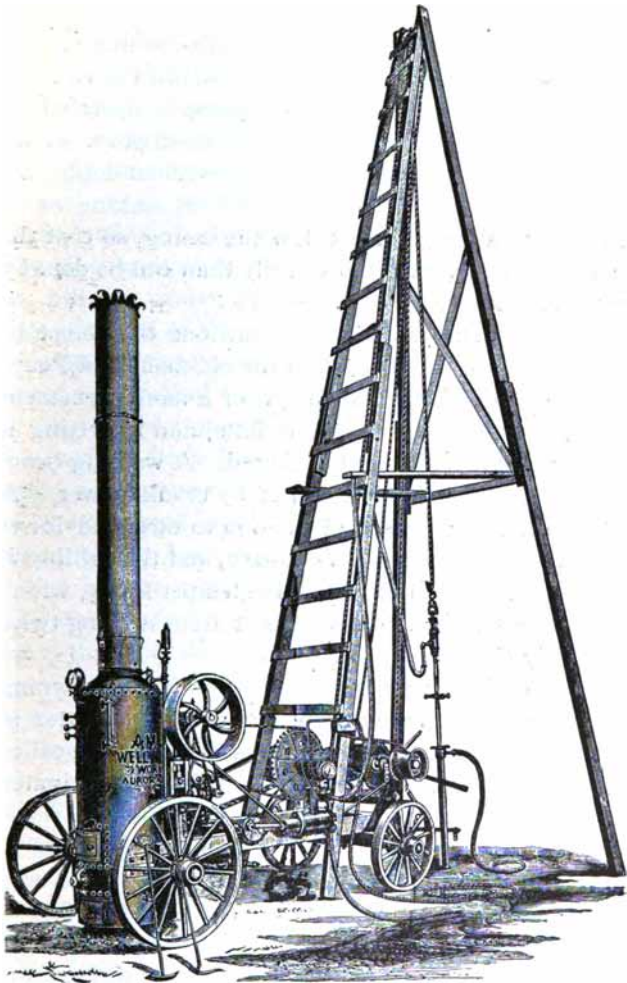

FIG. 94—ARTESIAN DRILLING OUTFIT.

to the machinery by a friction clutch, which can be engaged or disengaged while the machinery is running or the tube is being rotated. A pump is operated by steam, which forces water down the tubing to wash out the cuttings. Expansion drills are, without doubt, the best thing that can possibly be used for sinking wells, as they cut a large hole below the casing, so that the casing can be inserted more easily than can be done by any other means.

The most substantial outfit, and one that must be used in very deep borings, is the old-fashioned Pennsylvania oil derrick. This rig is of a more permanent character than the portable machine, and in setting it up the posts must be well anchored. A walking-beam is necessary, and this is operated by crank power. A bull-wheel must be set in position to raise and lower the tools, a sand-pump is necessary, and the drilling is done by a man who attends to the temper-screw, which rotates the drill-bit and prevents it from striking twice in exactly the same place.

**The Uphill Siphon.**—Sometimes farmers owning water in reservoirs are desirous of using the water in places which would necessitate what would be called "draining uphill." Provided the land to be irrigated lies lower than the surface of the water in the reservoir, this can be performed without any great effort by using the principle of the siphon. A tile-layer once agreed to drain a pond which at that time was full of water, by laying the tile-drain from the pond over the hill, no attention being given to the grade of the drain, nor to the fact that the hill was three feet higher than the water in the pond. He laid his line of tile about

three feet deep through the hill, or about on a level with the water in the pond, covering the tile thoroughly as he went along until he arrived at the pond. To the surprise of many, the water, which was two feet deep in the pond, all ran out. Another similar proceeding is related of a drain made by a mole ditcher, which is forced through the soil by a capstan. The plow or mole was set in at the pond and run over the hill, the water following behind. Strange as it may seem, all of the water was taken out of the pond. The drains were practically siphons, and when completed were full of water, so that they acted as siphons as long as the water-supply lasted. When once empty their action ceased and could not be brought about again unless the drains were filled with water, which of course could not be done. These examples and others which have come under our notice, show that under certain conditions tile-drains can be made to operate very much as tight pipes. We observe, however, that for all-round drainage purposes tiles must operate freely, without being forced, except for flushing in flood-times, when we may expect to see tile lines crowded beyond their capacity for good drainage purposes.

**The Siphon Elevator.**—This contrivance is composed of two pipes of unequal diameter—a receiver and a regulator. In the interior of the receiver a clack-valve is placed, so as to cut off, intermittingly, the flow of water into the regulator, and above it is a puppet-valve maintained in its place by a spiral spring. A lever carrying a counterweight is attached rigidly to the axis of the clack-valve, causing it to open. The



regulator is formed of a cast-iron drum, having thin corrugated heads. At the bottom of the suction-pipe is a check-valve, which allows the ingress of the water but prevents the escape. At or near the bottom of the discharge pipe is a stop-cock. The siphon elevator is filled with water the first time through the orifice, which is then closed by a screw-cap.

Its operation is as follows: By opening the stop-cock in the pipe, the water in the siphon is submitted to atmospheric pressure, with which it seeks equilibrium. Therefore, as it falls in one pipe it ascends in the other pipe and penetrates into the receiver, where, meeting the open check-valve, it forces the same forward and closes it. Its exit being thus cut off, the water by its momentum raises the puppet-valve and escapes through the opening, whence it runs off in a reservoir or other receptacle. During the time the regulator partially empties into the pipe, causing a partial vacuum and a depression of the corrugated heads; but the pressure upon the clack-valve meanwhile diminishes, allowing it to be thrown open by the weight on the level, so that the water immediately fills the regulator again. The corrugated heads assume their original positions, and the same phenomena take place again in a very brief period of time, varying from four hundred to four hundred and fifty a minute. The vibrations insure the continuity of the movement, causing an uninterrupted flow of water from the reservoir over the puppet-valve. This elevator will lift water eighteen feet in high altitudes and thirty feet at sea-level, the difference being in the natural atmospheric pressure. The elevator costs a few hundred

dollars, and may be used in streams, wells, or reservoirs.

**The Bucket Elevator.**—This arrangement is calculated to raise water from a stream by the force of the current, but the writer does not accord to it all the great things claimed by the inventor, Ira J. Paddock, of Hemingford, Nebraska. The device is crudely sketched in Fig. 95. According to this plan, two upright posts are to be driven a few rods apart on the

farther bank of the stream, and two or more on the nearer side, at least one being far enough up the slope to be beyond the reservoir. To the tops of the posts are fastened, by short ropes, pulley-blocks, through

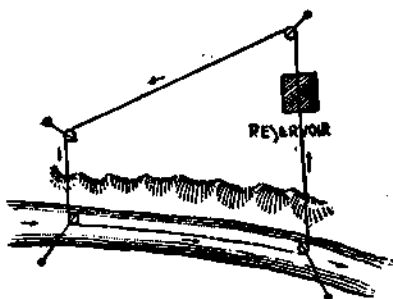

FIG. 95—BUCKET ELEVATOR.

which is rove a taut endless rope belt. This should be two feet above the ground, and should run quite a distance lengthwise over the stream, the latter adjustment being effected by giving enough length to the fastenings of the pulleys to the two posts on the farther bank.

The pulleys are so designed that drag-cords knotted to and hanging from the moving belt-rope will pass them without any trouble. Then to the rope are fastened a lot of boxes, or buckets, which perform double duty in carrying water and generating power. They would be full going uphill, their weight being then sus-

tained by two wheels running on the ground, and the belt-rope merely hauling them. A bit of plank above the reservoir would come in contact with a valve in the bottom of each box as it arrives, thus discharging the contents, so that a procession of empty boxes would be going down the slope. These would nearly overcome the weight of the boxes, but not the water going up. Of course, there is some loss through friction. Mr. Paddock aims to get enough power for hauling from the pull of the stream upon those boxes which are floating in the water, and if the length of the stream section of the belt-rope is great enough in proportion to the climb up the hill the plan ought to work. He would thus have an automatic machine working something like a grain elevator.

W. W. Allen, of Centerville, South Dakota, has rigged up a contrivance for elevating water from a river to irrigate his fields. He has had a lot of galvanized iron buckets made, holding about five gallons each, which are attached to a large belt running over pulleys, it being operated by a small horse-power. He has ditches running from the river, so that he can run the water very readily over his entire field.

**The Canvas Dam.**—Of the home-made devices for saving labor to the irrigation farmer, the canvas apron, which is capitally illustrated in Fig. 96, is one worthy of special attention. The advantages of using canvas instead of earth for lateral dams are that it saves time and labor and affords complete security against the breaking away of the water during the absence of the irrigator. It also obviates the necessity for mutilating the sides of the laterals for earth with

which to build the dams, which is a point of importance to farmers who take pride in keeping their ditches in good condition. The materials for a common apron, such as is shown in Fig. 96, aside from the canvas, are a piece of scantling seven feet long, two laths, a bit of sheet iron, a piece of rope and a few short nails. The canvas should be twelve-ounce, and for fifty-inch ditches and upward should be sixty inches in width, so as to afford ample protection for the sides of the ditch. Nail the scantling to the canvas through the lath, and to the bottom of the apron fasten in the same way a piece of 1 x 3, fifteen inches in length. Put a rope handle in the scantling, and a strong wire staple in the piece fastened to the bottom of the apron.

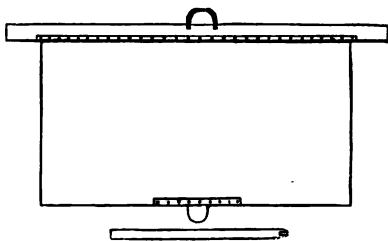

FIG. 96—THE APRON DAM.

When set, one end of the brace engages this staple and the other end the rope handle. For laterals of ordinary depth the apron should be three feet long, to allow the canvas to lie on the bottom of the ditch for a few inches behind the staple; otherwise the water will cut under and escape. Make the brace similar to the one shown in the sketch, and cut to suitable length to allow the canvas to lie on the bottom of the ditch.

**The Tri-Lateral Canvas Dam.**—It will be seen that the essential feature of this dam will admit of varied construction in its attachments. A cheap and

simple method of construction would be to nail one of the three borders to a pole, and make a loop, by means of a stout cord, in the opposite corner. A better construction, however, is recommended. Select a stout stick of hard wood, or good pine, 2 x 4 and six feet long, bore a one-half inch hole through the center of the larger diameter about one foot from the two ends, and make a wide saw-cut between and connecting the two holes. The cut may be started with a keyhole saw. Make the sides of equal length, about four feet and four inches. Hem the edges so as to admit the passage of a half-inch rope around the entire border between the two layers of cloth. To fasten the cloth to the stick, pass one edge of the canvas through the saw kerf to the opposite edge, then thread the rope through the half-inch holes in the stick and around through the border of the canvas, remembering to pass the rope through a two-inch iron ring at the angle opposite the stick, for a fastener, or anchor, in the ditch. The two ends of the rope should be made to meet about half-way along the edge of the stick. Bolt or nail through the flat side of the stick to prevent the sides from spreading and the canvas from slipping in the kerf. The other two edges should be fastened firmly to the rope by sewing a stout cord around the rope and canvas. To make the whole thing complete, a half-inch rod of iron about three feet long and sharpened at one end is provided, to pass through the iron ring at the point of the canvas. The device is shown in Fig. 97. In use, the ends of the stick rest upon the banks of the lateral, the iron rod through the ring with the top slanting in the direction of the water-source, and the sharpened

end thrust to a good depth in the earth at the bottom of the ditch.

The author has used—many years ago, however—a metallic dam consisting of a sheet of galvanized iron, about thirty inches long and fifteen inches wide, and having two rounded corners. There was an aperture four by ten inches square in the center for the water to flow through. When the gate was in position the flow of water through the aperture was regulated by a sliding adjustable gate, made also of galvanized iron, easily moved up or down by hand. The dam was set in position across a lateral by crowding its sharp edges down into the soil to the proper depth, thus forming a check to the flow of the water in the lateral except as it passed through the sliding gate.

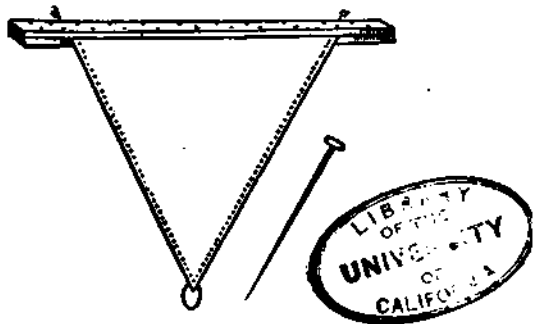

FIG. 97—HUNTLEY DAM.

The Witcher dam is a patented improvement over the apron and diaper sheets. It is composed of a large piece of canvas secured on one edge to a beam or pole which spans the ditch. The side edges are laid on the banks, while the lower edge lies across the bottom of the ditch or canal. The front is adjustably looped by a rope in the middle, regulating the water to a predetermined stage, and causing it to pass through the branch ditch or canal. The main pressure is supported by

stanchions or stay-braces connected with the beam, as shown in Fig. 98. A flap is attached to the apron under openings made just under the pole on the upstream side in such a way that the weight of the water will hold it in position and allow the desired amount of water to pass through.

**The Van Horn Tap Gate.**—This is the invention of J. A. Van Horn, of Cañon City, Colorado, and is not patented. It may, therefore, be used by any one who irrigates land through laterals. The various

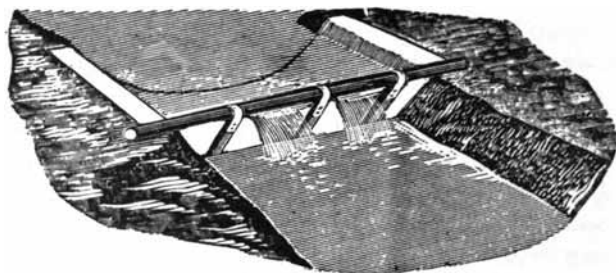

FIG. 98—THE WITCHER CANVAS DAM.

forms of its construction are shown in Fig. 99. The design, *A*, shows a plain box made by nailing four boards opposite each other, perfectly square on the front end. *B* represents *A* with four boards on the outside, breaking joints, three of the outside boards extending forward of the inside box, which makes a box, or pipe, stronger than if made of two-inch lumber, having free passage for water. For tapping reservoirs and main ditches under high pressure put a gasket on the end of the inside box, thus making it absolutely water-tight. *C* needs no explanation other than that

the wings need not be more than one-half as wide as drawn, and should also extend under the bottom. For variations make *B* with only three outside boards, or make the outside jacket to extend only about one foot on the first box, just sufficient to hold the gate in position.

#### Simple Grade Levels.

—A cheap and accurate leveling instrument and a target or sighting-rod, like that shown in Fig. 100, can be made by any one with a little ingenuity. This is simply a sharp shaft or stake, *B*, with cross-bar, *A*, bolted firmly to it. *C* is a rubber tube attached to the staff and passing up through a hole at each end of the cross-bar. At each upper end of this rubber tube is a glass tube, say four inches long, with the rubber tubing stretched or sprung around it so as not to leak. Colored water fills the tube, and in leveling it is only necessary to sight across the tops of the colored water to the target and take levels just as with a \$25 surveyor's level.

For short distances it is accurate enough. The glass tubes may be corked tight about an inch above the colored water to prevent its escape when the level is carried. Of course a carpenter's spirit-level, instead

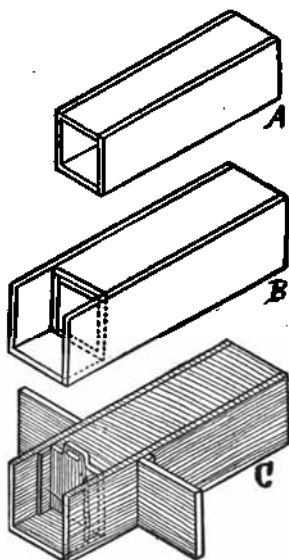

FIG. 99—THE VAN HORN  
TAP GATE.



of the cross-bar and tubing, may be screwed to the bar, and sights may be attached to each end of the level half an inch above the top surface, or even small, flat phials, four inches long or so, can be used instead. Two pegs, four inches in height, with holes bored through near the top, may be driven into the bar to be thus used for sighting. For the sighting-rod or flag use a two-inch

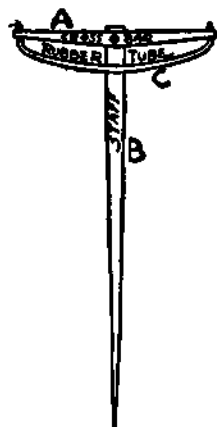

FIG. 100—A HOME-MADE SPIRIT-LEVEL.

batten ten feet long, planed and plainly marked in feet and inches, from the bottom up. Then with a cheap tape line, two rods or half a chain long, measure the distances, take levels, and set the depth stakes for digging the ditch.

**A Ditch Cleaner.**—A home-made affair consists of the forks of a tree cut ten feet long, on one side of which is bolted a share of sheet iron. The arrangement is exhibited in Fig. 101. The plow is heavily weighted, and can be pulled through irrigation ditches, canals, or creeks, by horses. Two men, with four horses, can do the work of fifty ditch men with shovels. The pole is used to raise the front of the ditcher when necessary. A man swings his weight upon the back, and thereby lifts the front or point from the mud. A big hook is bolted on the top, to which the double-trees are attached by a long chain. In ordinary work two horses can pull the ditcher, but in most cases, where the ditches are filled with mud and gravel, two teams

are necessary. To strengthen the plow and make it more substantial, braces of iron could be put in, extending from the middle cross-beam to each runner,



FIG. 101—A DITCH CLEANER.

as in a sleigh. In constructing new canals it has no equal, considering the expense of making. There is

no patent on the idea. Some 6 x 8 good oak timbers will make a better ditcher than an old tree.

**A Tandem Hitcher.**—A useful device for working two horses tandem in a ditch is shown in Fig. 102. It is made by attaching two pulleys for inch rope to opposite ends of a double-thick singletree. Two one-inch ropes, each about ten feet long, are used with an ordinary single-tree hook on each end of the ropes. Fasten one end of each rope, *A A*,

to the trace-eyes of the rear horse, and to the front end of each rope, *B B*, to the trace-eyes of the lead horse. As

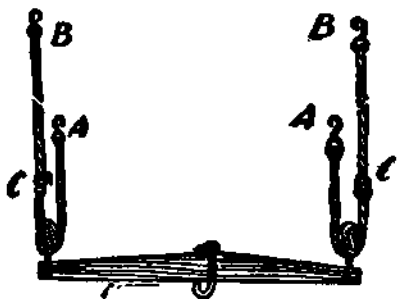

FIG. 102—A GARDEN HITCHER.

shown in the illustration, a knot, *C C*, is made in each rope a little in front of the pulleys, to prevent the rear horse from coming too close to the lead horse.

**A Water-Gate.**—Of all the flood-gates, patented or otherwise, there is but one that is worth building.

This gate is called the Carlisle gate, as a man by that name invented it. Suppose a canal is sixteen feet wide; drive three good six-inch posts into the bottom of the stream—one on each side and one in the middle; make a water-gate just as if intended to swing it to a pole the old-fashioned way. Then fasten the gate to the stakes at the bottom with strap-hinges—or if cheapness is an item, with wires; then prop it up so that it will stand erect against the common stream, but so that

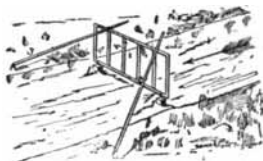

FIG. 103—WATER-GATE,  
STANDING POSITION.

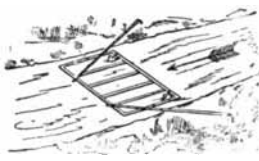

FIG. 104—WATER-GATE,  
WHILE WATER IS HIGH.

high water will wash it down where it will lie, letting the drift go over, but will not carry the gate away. The stakes or posts at the bottom should be driven clear down to the bottom of the stream, or the water will make a whirl around them and finally dig them up. If the stream is large two or more gates can be put in, in the same way. After the storm is over and the water recedes the gate is raised.

**The Transplanting Machine.**—This is a sort of an irrigation system on wheels, and while it was originally invented for planting tobacco, it serves as well for sweet potatoes, tomatoes, and cabbage. The machine is not unlike a mower in general appearance and costs \$70. It is drawn by two horses. The field is previ-

ously prepared by a double cultivator, which turns the earth into ridges of two feet level surface and nearly four feet apart. The planter is then driven in the furrows between the ridges. Two boys are seated on the rear of the machine, under a shady canopy, each with a pile of plants at his side. As the machine is driven along a sort of a small plow called a marker opens a space in the ridge into which the boys place the plants, alternating with each other, but so rapid is the movement that each boy is kept busy placing plants in the ground. As the plant is thus placed, a stream of water is let out of the barrel carried under the seat of the driver, which moistens the plant. The roots of the plant are then covered with soil by two small shares which follow and close the earth over the ridge, as when the cultivator left it. The valve letting out the jet of water from the barrel is operated by a cam connected with one of the wheels. The plants are placed twenty-three inches apart, and the distance between the rows is three feet nine inches. One of the advantages of this machine is that the roots of the plants are not doubled up as in the stuffing hand process, but the chief advantage is the saving of labor. One machine operated by a driver and two skilful boys can do the work of twelve men. The machine will plant ten acres in a day and a half.

**Watering-Cart.**—Where a small area of valuable crops is to be covered only occasionally in a season, very satisfactory results may be obtained with a watering-cart. The author has a friend in Colorado who used one and was much pleased with it. He had an orchard of over one hundred acres, for which he made

an unsuccessful attempt to get water for less than \$2.50 an acre. He then put in a gasoline engine, pumping 15,000 gallons in two hours against a sixty-foot head. He irrigated his trees with the cart, having to convey the water as far as half a mile. He employed five men, gave each tree fifteen gallons of water, and did the entire job at a cost of \$97 for labor, gasoline oil, and all incidentals. He kept a strict account of the expenses for his own satisfaction, and states that the cost of gasoline for the job was \$3.80. He simply

hauled the water in the cart to a tree where a border had previously been dug, and turned in enough water from the tank-cart to fill the border.

**Liquid Manuring.**—The utilization of liquid manure

on all farms is an important consideration. On rolling land, such as found on many farms, it is entirely feasible to build a cistern or reservoir in a

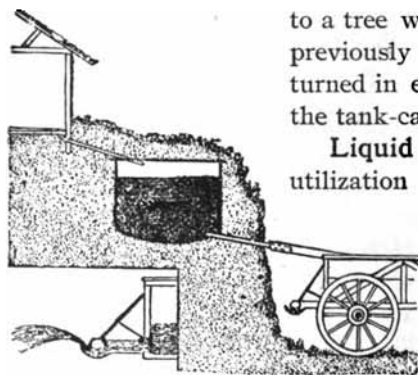

FIG. 105—CISTERN AND LIQUID MANURE SPREADER.

side-hill, as shown in Fig. 105, to which the liquid may be conveyed by pipes or troughs from the barn, and from which it may be let into a water-tight vehicle through a rude flood-gate or large pipe-faucet by gravity, the wagon standing below the level of the reservoir. Nor will this method be made less valuable by clogging in

passing the fluid from the cistern to the wagon, because the need of pumps and power is dispensed with. Attached to the cart should be a liquid-spreader such as adopted on most city street-sprinkling wagons. It is merely a semicircular trough at the end of a pipe, through which the water flows. On being freed from the pipe the water is forced downward, then it is spread in a thin sheet regularly over an even area. Straw, sawdust, and other refuse passes through. Such a cart is useful also in watering crops in dry weather. Filled with water it may be left in the center of the lawn or garden, and the whirling lawn-sprinkler and hose attached to it play all night over the grass, strawberries, etc. The advantages it presents are numerous. It may be only partly filled with the liquid fertilizer where the stuff is too strong, and its contents diluted with water before distribution. This plan is often advantageous where the liquid is hauled up a steep hill. We can see where this cistern could be made to discharge its contents into a lateral of running irrigation water, and the manure carried direct to the land in this way. Some such scheme will have to be devised.

**Manure Vat.**—An excellent fertilizer vat or settler used successfully by many irrigation gardeners consists of a barrel, hogshead or box sunk in the ground at the highest point reached by an irrigating ditch on the garden plat. This vat can be made of old slabs if nothing better is available and will last for many years. It should be filled with well-rotted manure of any kind, having some hay, corn-stalks, or brush mixed to keep it from becoming solid. The

water can be turned in from the irrigating ditch and left to fill up the vat and flow out from a two-inch auger-hole near the top. Sometimes the vats are made large enough to hold two or three wagon-loads of manure, and are filled with water and left to stand a few days before the liquid fertilizing element is conveyed by ditch or otherwise to the growing plants. These vats may be filled and emptied as desired and fresh fertilizers be given the plants. There is no danger of conveying the odor or contaminating influences of the liquid to the vegetables.

**The Corrugated Roller.**—One of the most useful machines for preparing a seed-bed in irrigated land is the corrugator invented by Eugene H. Grubb, of Carbondale, Colorado, and illustrated in Fig. 106. There is no patent on the machine and any one may make it. The main part consists of a drum or roller made in two sections to toggle like a disc harrow. This cylinder should be of cast iron, but may be made from wood and weighted from 500 to 750 pounds while in operation. It should be three feet or so in diameter. The first section, or the one at the left, is thirty-four inches long and has but one rim or corrugate, while the other has two and is thirty-nine inches long. This is made necessary to facilitate turning. The corrugates are five inches wide at the base and have a four-inch flange which leaves a demarkation of similar depth in the soil. A half-worn wagon tire should face each wooden corrugate to keep it from wearing. A spring seat is bolted on the rear of the frame, and in front of each corrugate depending from the frame is a shovel-plow made from  $\frac{5}{8}$ -inch by 3-inch iron kept in place

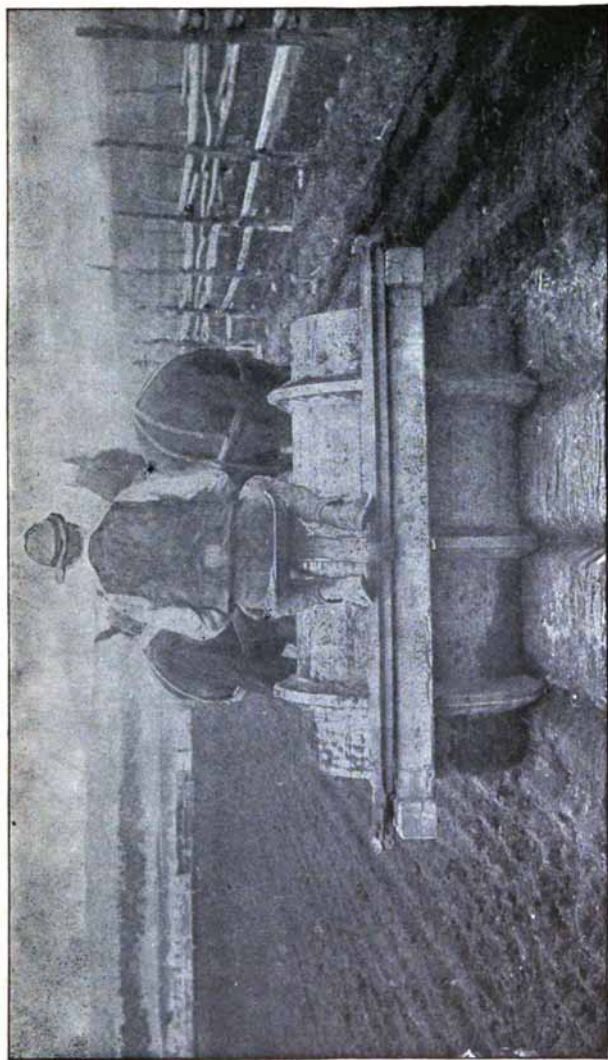

FIG. 106—THE CORRUGATED ROLLER IN OPERATION.



by long stirrups made from  $\frac{3}{4}$  round iron. These are connected with a tilting lever so as to raise them in turning. The rollers act on their axle independent of the frame and the team is attached to a strong pole. The advantage of this machine is that it firms the seed-bed and at the same time makes small furrows for the irrigating water. This prevents flooding and baking, and permits the water to seep through from one corrugate to the other without injuring the surface. In a meadow these corrugations will remain for years and do not interfere with harvesting machines.

## CHAPTER XIX.

### SUBIRRIGATION AND SUBSOILING.

**S**UBIRRIGATION is more of a theory than a condition, and until it is better comprehended and more thoroughly tested, the writer does not care to uphold it as a system worthy of general adoption. There is no doubt that subirrigation has many advantages, especially in the way of economizing water, but the original cost of an underground pipe system is so expensive that many men are deterred from adopting it. A rough estimate would make a gallon of water sufficient to irrigate a cubic foot of ground, and this is a much higher duty of water than can be obtained by the open trench system.

This method is probably correct in principle, and there are authorities who claim that it is most economic, effective and wholesome. The prime aim, under any system of cultivation, or irrigation, should be to stimulate and induce capillary action in every possible way. It is a fact, conceded by every observing cultivator of the soil, that the finest and best crops and the most satisfactory results in every way are obtained from those lands where there is free, constant and uniform moisture diffused from below. Soils differ with respect to the workings of capillary attraction, but it is more or less potent in all lands. The diffusion of moisture in this way will depend mainly upon two conditions—

the supply received or contained in the underlying strata, and the character of the soil operated upon. Two other points closely allied to these are the storage capacity underneath and the manner of cultivation.

Farmers should make themselves most thoroughly acquainted with the subsoil on their estates down to a depth of at least four, but preferably six or eight feet. Similarly, no irrigator should be ignorant of the time or amount of water required to wet the soil to a given depth. A definite knowledge of the rapidity with which irrigation water penetrates downward and laterally in the soil should form a part of the mental equipment of every irrigator, particularly in arranging for subirrigation. Supposing the moisture to have reached the depths of the soil, whether from rains or from irrigation, it is essential that proper means be employed for retaining it in the land and especially to prevent evaporation. As has been set forth quite elaborately in this work in the chapter on soils, this is best accomplished by a dust mulch on the surface of loose, well-tilled soil. Where this principle is well understood, it is considered that a surface layer of three inches or so in thickness is sufficient for effective protection, and this rule applies in subirrigation quite as materially as when water is applied by the various surface methods.

The difference between water applied to the surface by irrigation and that applied below the surface eighteen inches to two feet, is that in the former case there is much evaporation after the water is applied, and the air has not free access to the soil and roots of the plants for a day or two. In the latter the subsoil is saturated

thoroughly, the plant is never deprived of air and the surface soil is kept loose and fine, and there is comparatively small waste, as the water rises slowly when the cultivated soil is reached ; the temperature of the soil is thus more uniform, and the growth of the plant is not varied by changes in supply of moisture, air, and temperature. It has been found by experiment that subirrigated soil is warmer than that which has been surface irrigated, and that the atmosphere around plants to the height of twelve inches is warmer by subirrigation than by surface irrigation. Instead of dilating at length upon the *pro* and *con* advantages of subirrigation, the writer prefers to give a description of the various methods of applying water in this way, and allow the reader to form his own conclusions as to the utility of the system considered as a whole.

**Subbing.**—This is the most natural method of subirrigation and it is practiced without resorting to pipes or artificial waterways. It is simply seepage, and is possible only on sloping land having a clay subsoil within a foot or two of the surface, and is quite commonly seen in the San Luis valley of Colorado. Wherever irrigation is necessary for the production of a crop, it will be found of great advantage at the time of seeding to make ditches and furrows at short intervals, and then to so check the water in these ditches that it may stand in small bodies at a level above the general surface of the ground to be irrigated. If the water is held constantly in these small reservoirs during the growing season, it will not be necessary to flood the ground so often ; and if the soil is sufficiently

porous, it may be possible to give the crop all the moisture needed without surface application.

If a field has a steep side-hill slope, it is best to bring the water upon it by a supply ditch on the highest part, as shown at *a* in Fig. 107, and conduct it by a series of dams or drops, *b b b*, to the lowest part of the field. Then run laterals, *c c*, from above each drop nearly along a contour or equal level-line on the field, diking these laterals up to keep the water above accidental high places. These laterals should be permanent and should be near together at the top of the field, the intervals widening as they near the lower edge, as the seepage from the upper laterals will necessarily make the ground more and more moist toward the lower edge of the field. The field should be made as long as possible, and the laterals should be made as near parallel as the ground will permit, so as to obtain as large and regular an area between the furrows as possible. Whenever it is necessary to flood growing crops, an opening can be made in these permanent ditches at points where the grade-line intersects a slight knoll. From these openings the water should be conducted in zigzag courses, in furrows prepared at the time of seeding, thus preventing washing, and keeping the water as much as possible away from the crowns of plants until it soaks into the soil. A headgate, *d d*, should be placed at the source of each of these field laterals, and then it is possible for the farmer to so regulate the supply in each part of the field that a sufficient quantity may be obtained at the roots of every plant, with very little or no water going to waste at the ends of the field laterals.

**The Asbestine System.**—If the water-supply be limited, or difficult to obtain, this plan stands well at the head. It consists of cement pipes, generally three inches in diameter, but varying from two to four inches, that are made in a continuous line in the bottom of trenches with small openings at intervals, in which wooden plugs or nipples with quarter-inch holes are inserted. A modified form for use in orchards, where

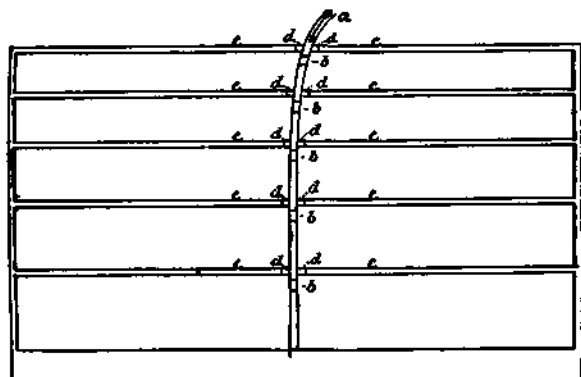

FIG. 107—DIAGRAM OF SUBIRRIGATED FIELD.

the tree roots would be likely to trouble by clogging the holes, has square openings about six by three inches, over which a piece of tile of a size that will fit evenly down over the opening is laid. These tiles are laid from fifteen to twenty inches below the surface, and although they will work if given considerable fall, they distribute the water in a more satisfactory manner if they have at best but a slight and even slope. In the orchards they are laid between alternate rows, and the holes are from fifteen to thirty feet apart. The

machine used in laying this system is illustrated in Fig. 25, Chapter VIII.

Another form of tile consists of short lengths of cement pipe made in sheet-iron molds, which have their joints closed with cement when they are laid. These distributing pipes are often connected into systems of considerable size by being joined at one end to a main supply pipe, which is generally of sheet iron coated with asbestos. Sometimes what is known as laminated pipe, which consists of two thicknesses, is used. This may be made of two pipes of such a size that when placed one within the other there will be a space of one-sixteenth of an inch between them, which space is filled with asbestos, while the inner and outer surfaces are coated with the same material; or it may be made from one piece of sheet iron rolled so that it will form a double thickness of iron. The elbows and T's are of iron laid in cement. When used for irrigating small fruits and vegetables, the laterals are placed twelve to twenty feet apart and the holes are at intervals of from six to eight feet.

**Tiling.**—Scientists who have given thought to the subject are agreed that, theoretically, subirrigation by porous tiles is the ideal plan. The tiles may be made porous by mixing sawdust with the mortar, which being burned out in the baking process leaves the tiles porous to the exact degree desired and prepared for in the mixing. The first cost of laying a system of pipes has been estimated at \$400 an acre. The tiling has the advantage of furnishing drainage when there is too much water in the soil. The ground is first graded and leveled, and a ditch is dug with plows and spades

every rod or so, one foot wide and two feet deep. In the bottom of this ditch a row of four-inch drain-tile is laid. A line is used to keep the tile straight and true. They are placed in the ditch as if they were intended for draining the land.

Six inches fall for every hundred feet is necessary. The dirt is placed around the tiles by hand, until they are sufficiently firm so as not to be displaced by filling in with plow and shovel. If the soil is of a sandy nature, it is necessary to have a piece of tin or galvanized iron over the joints, to prevent the sand from filling in. The tile is placed at least eighteen inches below the surface, and is out of reach of the plow. The water is brought to the land by means of a pipe which is laid directly across the tile at the highest point, and a faucet is arranged so that water may be turned into each line of tile at the same time. The tile may be stopped at the lower end, thus allowing the water to seep out of the joints until the land is sufficiently moist. Many persons would suppose that the water would descend, but it naturally rises to the surface. It is essential that a drainage ditch should be provided at the lower end of the field to serve as an outlet for the tiles, which should be so arranged that they can be drained during the winter, as otherwise they might be cracked by the freezing of the water that they would contain. Upon stiff soils with impervious hard-pan the lines of tile can be placed considerably deeper.

In all subirrigation undertakings the first precaution is to ascertain whether the structure of the soil and subsoil is such that this method is practicable, as



it is useless expenditure of money to lay pipes where the conditions are such that the water will not spread laterally to the plants. In some localities the subsoil is so porous or gravelly that the water applied beneath the surface sinks immediately and cannot be utilized by the roots of any of the plants except those in the immediate vicinity of the source of supply. This is especially the case on the bottom lands along streams where the surface soil rests upon gravel or beds of sand. Where, on the contrary, the subsoil is comparatively impervious, and above this the structure is such that the water is transmitted horizontally, systems of subirrigation can be introduced to advantage.

Different depths have been tried, some being fourteen inches, others eighteen, and still others two feet deep. Some difficulty has been found in pipes laid from eighteen to twenty-four inches beneath the surface. By digging down it was found that the deeper pipes were placed so low as to be imbedded in a tenacious clay subsoil through which the water could not spread freely. By raising the pipes about six inches, well above the clay, the water percolated freely. For vegetables it has been found that pipes give the best results when laid from eight to ten feet apart, while for orchards a single row of pipes is sufficient between alternate rows of trees, the pipes being placed from ten to twelve inches in depth. It has also been found that the moisture was rendered more efficient by using fertilizers. One of the most common mistakes has been in giving too great slope or inclination to the pipes. If laid on ground which has decided fall the water runs to the lower end before it can

escape in considerable part through the openings along the side. For this reason the pipes should be laid very nearly level, but if a considerable slope cannot be avoided it has been found best to have cut-offs in the pipe every ten or twenty feet to check the flow.

Another way is to run the main pipe on the down grade and connect this with irrigating pipes branching from it with suitable valves or cut-offs, so that the water can be turned into the branches. The preferred length of irrigating pipe is about 200 feet. Sometimes double T's are provided on the main supply pipe to connect with the pipes on each side. The main supply pipe is proportioned according to the amount of water to be carried. In general, for garden and orchards it is one and one-fourth inches in diameter. One style of sheet-iron lateral pipe has an open seam along its length, and is usually seven-eighths of an inch in diameter, although smaller sizes can be used for flower beds. The cost varies according to the amount used, but in one case where three acres were provided, two of these in orchard and the remaining acre devoted to potatoes, watermelons, and other vegetables, the entire cost was \$63. In this case the watermelons alone paid the cost of the pipe. One man can lay 3,000 feet in a day by covering with a plow.

In order to subirrigate a tract with a windmill, one should have a reservoir or tank that will hold at least 800 or 1,000 barrels, and unless one is reasonably sure of sufficient wind to fill the tank within three days at all times throughout the summer, a corresponding increase would be necessary. A reservoir that will hold 3,000 or 4,000 barrels would, in many places, be

advisable. The amount of water and the frequency of application would depend upon soil condition and the character of the season, but ordinarily the application of 800 or 1,000 barrels of water to the acre at intervals of six or seven days in spring and two or three days during the hot, dry weather of summer, would probably suffice.

**The Gravel Trench.**—This plan is very simple and quite cheap. Trenches may be dug six or eight inches wide and two feet deep, running with the slope of the land, and forty or fifty feet apart, connecting at the upper end with a head ditch somewhat wider than the others. Into these trenches put six to eight inches of gravel or crushed stone and then fill with earth. If for orchards, the trenches could be dug so as to go under each row of trees if the slope permitted. We believe this plan will work as well as tiling, and to many who are near gravel beds it will be much cheaper. Any blossom rock or detached shale often found on plowed ground can be used for this purpose, and cobblestones or kidney rock would be just the thing. We believe a trench plow has been invented for opening the trenches, and the work ought to be done late in the fall or during the mild days of winter, when nothing more urgent is pressing. Brickbats, such as are found around the kilns in a brickyard, could be placed in the trenches and would answer admirably. The only expense connected with the work would be that of labor, and the experiment ought to pay well.

**Father Cole's Plan.**—The late Honorable A. N. Cole, of Wellsville, New York, inaugurated a system of trench irrigation which proved quite a success and

elicited so much enthusiasm from the old gentleman that he wrote a book on the subject in 1885, and a year or two later the author had the pleasure of visiting Father Cole and personally examining his work at "The Home on the Hillside." His scheme was substantially that described under the preceding caption, and while he put in more time and labor in the detail and made his trenches in a more pretentious way, he

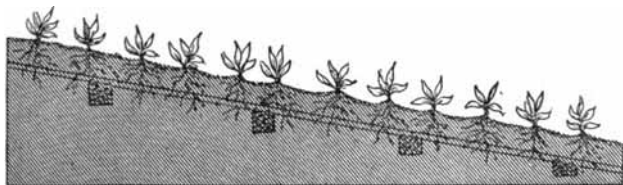

FIG. 108—FATHER COLE'S SYSTEM.

always said that the extra work repaid him well. A sectional view of Father Cole's works is given in Fig. 108.

In his book, "The New Agriculture," the following description appears: "The land is a hillside, along the eastern front of which runs a wayside gutter. Parallel with this and from forty to fifty feet apart, and across the land to its highest boundary, he caused a series of trenches two and a half feet wide and four and a half to five feet deep to be dug, and filled to within eighteen inches of the surface with coarse large stones, covered with loose flat stones, for subterranean water reservoirs; these were connected by numerous shallow and smaller trenches partially filled with small stones at about eighteen inches from the surface, de-

signed to carry off all surface water." The water which naturally fell from the heavens was caught in these trenches and filtered one from the other in such a way as to render the subsoil constantly moist and friable. Mr. Cole said: "The advantage of such a system for market gardening will commend itself to those who grow or aim to grow large and valuable crops upon small areas of land."

**Greenhouse Irrigation.**—This is the modern idea in greenhouse construction, and the writer is impressed with the system described by Professor L. A. Taft, in the *American Agriculturist*, and shown by sectional view in Fig. 109.

A durable greenhouse bench for subirrigation can be built of cement, at small cost, especially if it is to be at the same level as the wall. When the bed is desired at the height of three or more feet, supports must be provided. When the natural level of the soil is where the bottom of the bed should come, one has only to excavate walks, and run up the walls. In a house twenty feet wide it will be easier to make two wide benches, with a walk in the center and two quite narrow ones next to the outer walls of the house. Having provided for benches, the subirrigation may be secured by means of two or three rows of two and one-half inch drain-tiles laid lengthwise of each bed. If the beds are long, it will be well to have a slope at least one inch in thirty feet from the point where the water is admitted. To avoid the over-saturation of the soil, the lower ends of the tiles can extend beyond the ends of the beds, and be so arranged that they can be closed while the water is being admitted, and opened so as to allow

all surplus to drain off when a sufficient time has been given the soil to take up the needed water. In this way the soil can also be well aerated, and if bottom heat is desired, one has only to run steam or hot water pipes through the tiles.

When the beds are to be irrigated, water is poured quickly into the ends of the rows of the tiles, so that it will run the entire length of each row at once, and

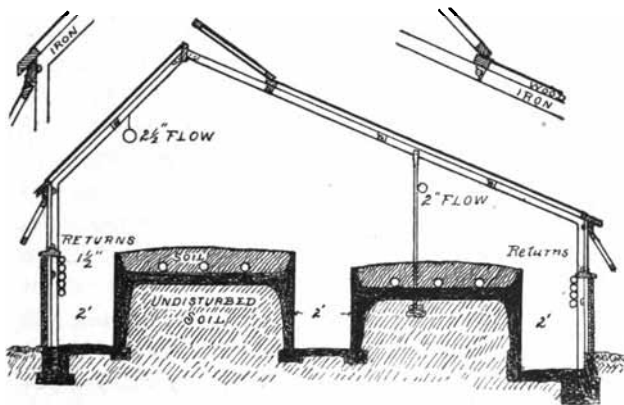

FIG. 109—GREENHOUSE IRRIGATION.

soak out slowly and uniformly through the adjacent soil; watering is to be done as often as the plants require it, and their needs are learned in the same manner as by surface watering, but the applications need not be so frequent as by the old plan. It may readily be seen that this system has some advantages. Heretofore the difficulty has been that when the moisture was applied directly on the plants, the result was rot or mildew, lettuce being attacked by fungus severely in

some instances, which is believed to be due to the frequent application of water to the foliage.

**Subsoiling.**—The greatest step in modern agricultural advancement, especially in the arid regions of the west, where the soil is of a tenacious hard-pan character, is subsoiling. Every thoughtful farmer has known for years that if he had a plow that would stir the under soil from eighteen inches to two feet deep it would be the most desirable tool on the farm. But the trouble has been that no such tool could be found that could be used in hard subsoil with any reasonable amount of power.

Recently a number of subsoil plows have been invented which are simple and inexpensive, and peculiarly adapted to run deep in the hardest subsoil with a moderate amount of power. In reasonably hard subsoil two good horses have run a subsoiler fourteen inches below the bottom of the furrow of a common stirring plow. Allowing six inches as the depth which stirring plows run, this makes twenty inches from the surface that is broken up and made mellow by the subsoiler.

This would permit the heaviest rains to quickly go down from the surface, and to be retained far enough below to avoid being evaporated soon by the hot sun, and would be exactly in the right place for the growing crops. Besides, the next time the same ground was subsoiled it would be comparatively an easy job to go from four to six inches deeper, making two feet or more of mellow soil, which would hold an immense amount of water, so that during the rainiest seasons the water would not run off into the rivers. In describing

his experience with a subsoiler in Allan County, Kansas, Clarence J. Norton wrote :

“ When I received my plow from the manufacturer I made no change of adjustment, as it was set for three horses, and I reasoned that the maker knew how it ought to be run, and I did not have to make any change at all. The plow went sixteen inches deep from the surface and pulled very hard on the team. I went one round after many stops to rest, and then changed double-trees and put on a big Percheron stallion. They now went easier, but in a short time I became aware that the enormous strain was too much to keep up long, so I lowered the shoe to make the plow run about fourteen inches in depth, plowing every two feet apart. This is all the change I made, except to raise the shoe again for twenty inches when cross-plowing.

“ This plow does not throw out any earth at all. It simply lifts up the ground about four inches, raising it most at the plow and for two feet each way, when, of course, the ground splits or cracks in front of the standard, and allows the inch and a half standard to pass through, only leaving just such a track as a ground mole leaves, excepting that this plow mole goes fourteen inches deep. When I returned four feet away, the whole ground between the plow-marks was raised up, loosened, or stirred, being raised the most where the plow had gone, and at the two-foot point between it had the appearance of a dead furrow ; but when this was also plowed into it was raised just as high as the rest. The earth seemed to be moved ahead a little and raised up about four inches. It was won-



derfully mellow and could have been harrowed down to a fine seed-bed. I plowed three acres in one and one-half days and then cross-plowed it, going every two and one-half feet apart and twenty inches deep.

“When I came to cross-plow I discovered the change even more marked. I plowed from one end in the form of a back furrow, going every five feet, or as close as the plow would run with the near horse close to the last mark. After this back furrow land became about thirty feet wide I split the marks going one way, and came back five feet away as before, thus always turning one way; and as I leaned the plow only a little I plowed around the ends, which in fact were the best plowed. This second plowing was done to the hard-pan, but not in it. The soil was real moist for six inches down, when from there to the hard-pan it was as dry as blotting-paper, and had probably not been wet for two years or more. Now this earth is at least six or eight inches higher than before, and will take in all the rain it can hold, and the lower soil in drying out again will of necessity supply the surface with moisture, as the gumbo below it is waterproof.”

**Irrigation Hard-Pan.**—This is one of the peculiar annoying outgrowths of surface irrigation in many parts of the irrigated west, especially among the citrus orchards of Southern California. This singular substratum should not be confounded with the natural hard-pan in stiff clay soils found the world over. The irrigation hard-pan is an altogether different condition, occurring as it does in deep, loamy soils, and is apparently occasioned by the gradual running together or cementing of the soil in irrigated orchards at a depth

immediately below that reached by the customary frequent cultivation. It is more frequently observed in orchards which have been subjected for a few years to irrigation and cultivation as ordinarily practiced, and seems to be a gradual process. A most urgent appeal was made a few years ago to the United States Agricultural Department for a solution of the mystery, but



FIG. 110—SUBSOIL PLOW.

the matter was turned down completely with the usual promptitude so characteristic of that organization at the time.

As a matter of fact the trouble is of most simple solution, inasmuch as it is caused by a peculiar action of certain chemicals in the soil superinduced by solar influence, the result of which is not unlike the hardening of mortar in a plaster bed when neglected by workmen. Usually it exists four to five inches in thickness just below the line of draft of plows or cultivating implements. That it is a very serious obstacle to the irrigation of the soil to a proper depth can readily be understood. In orchards underlaid by this pan the trees in the hot summer months will wilt in

two weeks after receiving the most thorough surface irrigation. The trees suffer in consequence, and the size and quality of the fruit is seriously impaired. The difficulty has been overcome in a measure by breaking the hard-pan crust with a subsoil plow, such as is shown in Fig. 110, running the plow one or two rounds, midway between the rows of trees as described in the chapter on orchards.

Frank L. Palmer, of North Pomona, California, once tried the experiment of tearing up some of this hard-pan by furrowing with a ten-inch turning plow in the middle of July. He plowed eight rows in this manner and turned up large chunks of hard-pan, which, of course, were difficult to subdue, but he finally succeeded in pulverizing them and getting the surface into tolerable condition again. Notwithstanding this the soil began to run together after the first irrigation, and the trouble seemed to be as pronounced as ever.

Analysis of this formation showed that while it contained no excess of lime or of carbonates, it had four per cent. of aluminum hydrates, and this constituted the bulk of the cementing material. It was subsequently ascertained that the water used in irrigating this particular orchard carried excess quantities of lime in solution, and this naturally added to the difficulties experienced when applied to the land under the scorching influence of the sun. This perplexing problem is in fact nothing new in Southern California, for the chronicles tell us that as far back as 100 years ago a similar condition existed near San Gabriel. The lands formerly cultivated by the padres about the old Spanish missions were irrigated from ditches, which

gradually became cemented with a calcareous coating two inches in thickness. This phenomenon was no doubt caused by the lime deposit left by the water running in the ditches. In cleaning them periodically, the old settlers were very careful not to disturb this formation in the bottom of the ditches, having learned by experience that when this was done there was loss of water from seepage. Subirrigation will no doubt rectify this condition and restore the soil to its natural status.

## CHAPTER XX.

### SEEPAGE AND DRAINAGE.

 ONE of the most startling revelations of later years acting as a serious menace to modern agriculture, as carried on by present irrigation methods, is the loss of many thousand acres of valuable bottom-lands, by the induction of seepage waters, coming as they do through subterranean ways from the great canals or other sources of water-supply on the higher lands. We of the irrigated west are to-day confronted by a condition more serious than the most extravagant theory, and the means of abating the evil will need the closest study of our most careful thinkers and scientific men. In the earlier days of western development and before the extent of irrigation was fully realized, the choicest lands were considered those lying along the lower river-bottoms, and naturally enough were the first to be occupied and utilized by settlers. In course of time these lands, exceptionally rich and available, were all taken for their alluvial fertility and adaptability to irrigation facilities. The second bottom-land was thought to be entirely out of the question for other than grazing purposes, but with the advent of time and the organization of companies and capital for constructing the great canals, these lands soon became even more desirable than the bottoms, and ready capital found the means for their occupancy and usefulness.

After ten or fifteen years of constant irrigation, it began to be noticed that the seepage waters of these larger canals were working most damaging results upon the river flats. The condition of many thousand acres may justly be designated as water-sick—that is, they have been rendered sick, as the saying goes, by the constant seepage of water as described, and the consequence is the formation of pools, sloughs, bogs, and marshy places in spots where the waters naturally settle in seeking a level, while a superabundance of saturation prevails throughout all soil coming within the scope of their baneful influence. When soil becomes filled to an extent exceeding a 70 per cent. saturation it may then be termed water-sick, or perhaps can be better understood by the term water-logged. It may be well at this point to interpolate the fact that no land can be profitably irrigated that has not either natural or artificial drainage. While no plant can grow without water, too much water will drown and kill it. The same law that governs the animal governs the vegetable kingdom as well. Neither can live without water, and too much very soon kills. It is just as essential for the roots of plants to come in contact with the air as it is for the tops, and any process that tends to draw the atmosphere out of the air-cells and fill them with water is detrimental to the growth of all vegetable life, except perhaps such things as foxtail, water-grass, the iris, and other aquatic plants.

**Action of Seepage.**—In irrigating, more water is often applied than the crop uses, and while the roots are taking up what they necessarily require some flows off on the surface, some evaporates into the air, and

some sinks into the soil below the reach of plants. The amount of water which sinks below the roots of the irrigated crops depends upon various conditions. Observations in many sections show that usually this water sinks directly downward with very little side-flow till it reaches a stratum of rock or clay so compact that it can go no farther. Then as other sinking water is added, the surface of the underground reservoir rises, filling all the pores and spaces in the soil till it reaches a layer of gravel or sand, through which it slowly percolates until it finds outlet into the river from which it was originally taken, or it may appear in some arroyo, branch, or draw which leads into the river—in any event, it finally finds its way back to the parent stream. This is why the water-table in the wells of an irrigated country rises many feet nearer the surface than before irrigation was practiced, and even springs often burst out at the foot of hills below irrigated fields or mesas. The deeper this seepage water has to sink before finding an impervious layer to form the bottom of its underground reservoir, the longer will it be before the detrimental effects of over-irrigation will show themselves and the looser the layer through which it flows, and the greater the slope of such layer the more rapid will be the underflow of the seepage water.

This underflow may come out upon a lower lying field, and as said previously tend to convert it into a marsh, establishing water-sick land, or it may bring up a solution of alkali to ruin the soil of such fields. In either case, suits for damages may follow. Such results are becoming alarmingly apparent in the irrigated districts of Colorado and elsewhere throughout

the far west. On the other hand, this seepage water returning to the stream from which it originally came passes on to bless the fields of those who live farther down. The courts have been asked to decide damage suits for injury often caused by seepage, but judgment cannot usually be obtained, although such may be the result where wilful negligence is shown on the part of the defendant corporation or individual. It generally devolves upon the owner of impaired land to seek his own relief, which is done by drainage, pumping, or other means known to irrigation experts. Of later years the trouble is quite apparent on some of the uplands, and with it comes the added difficulty of alkali rising to the surface. All these things imply carelessness and extravagance in the use of water on land, and the remedy rests largely in the judgment of the consumer himself. Irrigating out of season, allowing the water to run longer than necessary, and a misunderstanding of the soils on which it is applied are all paramount sources of water-sick land.

**Remedial Agencies.**—In some places, particularly in Utah, the damaging effects of seepage have become such a nuisance as to threaten public menace. In most instances the trouble might have been more easily prevented than can be cured, and prevention should now be invoked in such localities as are not already suffering from the advanced stages of overwatering. If the ground is leveled at the outset so that it can be watered evenly and drains are made to carry away the surplus, there is not much danger, provided the waste-drains are not discharged so as to damage other lands below. There is no hardship in



the extra expense involved in this, because the instant effect is to increase production with less outlay of labor. The magnitude of the interests involved, the curtailing and absolute destruction of productive capacity as affecting the welfare of the community at large, regardless of individual losses suffered; the neutralizing of the vast expenditures made for the original reclamation of desert lands; the waste of water, one of the most valuable of natural resources, and the limitation put upon further land improvement thereby—all these should appeal to the judgment of all people and should justify any public measures that may be necessary to correct the grievous wrong. Consequently, steps toward legislative relief have been considered advisable in many western states, and these are likely to be taken before the evil is corrected. To do this, however, must necessarily involve many complications not so easily overcome. As a general thing the irrigation companies themselves are powerless to prevent the difficulty, for the reason that under existant contracts with the farmers they are entitled to a certain amount of water for each eighty acres, which is probably twice as much as is really necessary to use. Unless the stated amount is assigned to the farmers there is danger of legal complications. Hence because there is a large surplusage of water available, it is contributing to the rapid diminution of product and a deterioration of the soils. Speaking from an individual standpoint it must be seen that drainage is the only alternative. Each year emphasizes the fact that drainage is the handmaid of irrigation. The one demands the other.

**Open Ditches.**—There are different methods of drainage suitable alike to the surrounding conditions. For draining swampy lands caused from seepage, open ditches cut at an average depth of three or four feet will reclaim the land and make it tillable. These should be run with the fall or slope of the land. A mistaken course is often adopted by placing the lines for the drains in an oblique direction down the slope instead of directly by the shortest course. Such



FIG. 111—INCORRECT DRAINAGE.

ditches are needlessly long and are made with much additional labor, and, what is still more objectionable, they perform their intended work in a very inefficient manner. Fig. 111 represents the portion of a field, the lower part of which toward the spectator receives the water from the sloping land above. The dark lines are the ditches, laid in a slanting direction, and are much longer than those in Fig. 112, which run by the shortest cut directly down the slope. An objection to the sloping drainage, as already stated, is that it carries off the surplus water in a very imperfect manner. As water will not run up-hill, all the water received by such ditches presses toward the lower side, and as the ditch is expected to draw water away from

the soil on the upper side, from a distance of a rod or more, by the porous texture of such soil, so the earth, being equally porous on the lower side, will allow it to leak out and pass a rod or more on the lower side toward the next ditch below.

If the trenches are cut directly down the slope by the shortest course, no water can leak out, as there is

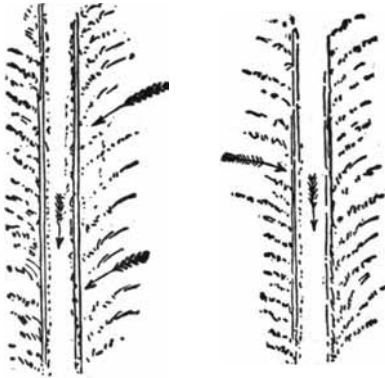

FIG. 112—CORRECT DRAINAGE.

no lower side, but it all takes the ready channel offered it and rapidly escapes. This ready channel in effect draws the water from the soil on each side, the bottom of the ditch being lower than the adjacent soil, while the natural descent of the ground and the downward currents are quickly carried off by the central ditches, the arrows in both the figures showing the currents. The difference should be always borne in mind between the water currents as they soak slowly through the earth by natural drainage, or as they rush rapidly down-hill through tile or other smooth and straight

artificial channels which the owner of the land has provided. By the natural drainage, creeping slowly by minute quantities down the slope, added to the slow, natural evaporation, two or three weeks, or even a month, are often required to relieve land which might otherwise be dried in a few days. It may be desirable to have the drains covered, in which case the trenches can be half filled with loose materials, such as broken stone, brush, logs, or any débris sufficiently solid to hold up the covering, which should be thick enough to admit of plowing.

**The Steam Irishman.**—So practicable has the plan of open trenches proven that already a number of new canals have been constructed which obtain their supply of water wholly from seepage pools or basins. One of these canals is near Platteville, Colorado, and was constructed with a steam dredging-machine floated on a mud-scow, as shown in Fig. 113. This machine is twelve feet wide, and is really a house-boat containing the power for working a dredge or "steam Irishman," as it is often called. It cuts a ditch or tunnel through swamps or other low ground, beginning at the head of the proposed canal, and is floated gradually along by the drainage water which follows behind and around the scow. It scoops out dirt, stones, and even small trees at a wonderful rate. Such a machine will do the work of a full gang of men, and can also work in places where men could not possibly operate. By means of these dredges large tracts of land have been drained and made fit for the plow. In some places these canals are cut not only to afford outlet for drainage water, but are utilized for the double pur-

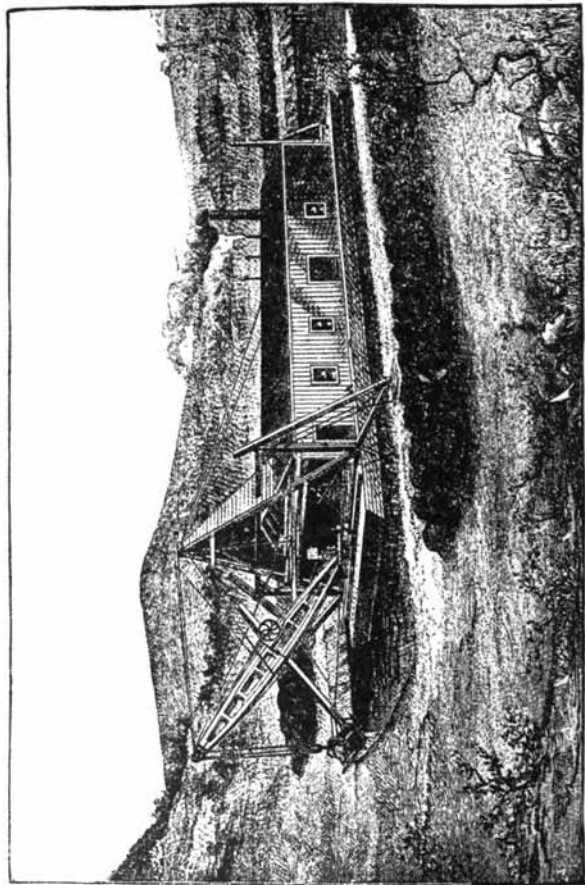

FIG. 113—A STEAM DITCHER AT WORK.

pose of reclaiming new sections of arid land, and in this way the water serves a twofold mission. One peculiarity about these canals is their constancy of flow, which is most marked in midsummer, at a time when many of the original canals are at low ebb.

**Tiling.**—Another good method of drainage is by the use of tiling. This may be large or small, proportionate to the nature of the soil and the area to be drained. The price of vitrified sewer pipe, which is best of all for the purpose, varies greatly according to size, and ranges all the way from twenty cents a foot for six-inch tile to \$2 a foot for twenty-four-inch pipe. With a grade of from eight to fifteen inches to the mile, the use of tiling is thoroughly practicable, provided, of course, that one wishes to go to the expense of putting in such a system of drainage. However, tile ditches put through very wet places may only imperfectly drain the surrounding soil. Water has been seen to stand on the surface of the ground with tile buried three feet below—all clear, free, and in good working order. The reason is the water is forced out of the ground by an upward pressure and comes through little seams and veins distributed through the soil, many of them near the tile perhaps. The water may come nearly or quite to the surface before working its way to the tile. The natural remedy whenever available is to give the tile greater pitch so as to create more momentum in the flow and thus attract outstanding water to the pipe, which in this instance should be loose-jointed so as to allow intake at every collar.

## CHAPTER XXI.

### ELECTRICITY IN IRRIGATION.

**T**HERE can be no doubt that the great irrigation enterprises of the future must depend more or less upon power for lifting water, and this can best be supplied by electricity. The running water of natural streams of the arid west is virtually all appropriated, and promoters of irrigation works in the future must look below the surface for water-supplies. In figuring on the possibilities of electricity for developing the necessary power, the following computation based on a proposition to irrigate twenty sections of land with thirty-four motors operated from one central power-station may be valuable in aiding operators to calculate the feasibility of such plan. There are 6,272,640 square inches in an acre of land. There are 231 cubic inches in a gallon. Twenty-seven thousand one hundred and fifty-four gallons will cover an acre one inch deep. A twenty-five horse-power motor will pump 1,000 gallons a minute and raise the water fifty feet. One thousand gallons a minute for twenty-four hours will cover fifty-three acres one inch deep. Fifty-three acres a day for seven days equals 371 acres.

## COST OF POWER-HOUSE

Two 500 horse-power dynamos at \$7,000 . . . . .	\$14,000
Two 500 horse-power engines at \$4,000 . . . . .	8,000
Five 250 horse-power boilers at \$1,800 . . . . .	9,000
Foundations, etc. . . . .	2,000
Buildings and well . . . . .	4,000
	<hr/>
Total cost of power-house . . . . .	\$37,000

One thousand horse-power less fifteen per cent. loss in transmission, etc., would be 850 horse-power actual service given. Eight hundred and fifty horse-power will run thirty-four twenty-five horse-power motors. Three hundred and seventy-one acres times thirty-four equals 12,614 acres irrigated by 1,000 horse-power electric plant.

## COST OF EQUIPMENT AND LAND

Thirty-four wells at \$300 each . . . . .	\$10,200
Thirty-four pumps at \$150 each . . . . .	5,100
Thirty-four motors at \$300 each . . . . .	10,200
One thousand poles at \$2 each . . . . .	2,000
Copper wire . . . . .	5,000
	<hr/>
Total cost of equipment . . . . .	\$32,500

Cost of machinery an acre, including plant. . . . .	\$5.51
Estimated cost of ditches and reservoir an acre . . . . .	3.00
Estimated original cost of land an acre . . . . .	5.00
	<hr/>

Total cost for each acre . . . . . \$13.51

The value of 12,614 acres well watered at \$50 is \$630,700. The cost of 12,614 acres and plant at \$13.51 equals \$170,415.14, making a gain in valuation of



\$460,284.86, which amounts to 270 per cent. gain on the investment. One thousand horse-power would cost \$50 for each horse-power per annum, which for five months of an irrigating season would cost \$20.83 for each horse-power, or a total of \$20,830. The cost of the motor-tenders, oil, etc., would amount to \$750, making the total operating expense \$21,580 for the entire 12,614 acres, or \$1.71 for each acre.

**Generating Electricity by Turbines.**—Probably a more feasible proposition would be to harness the streams of mountains, thus creating water-power, with which to turn turbines for the operation of dynamos. The practicability of such transmission for not only twenty or thirty miles, but even for 150 or 180 miles, has opened the way for this new and enormous proposition. Let us suppose a stream flowing from the mountains down into a large broad valley or a plain a hundred miles below. The water from this river is perhaps sufficient to irrigate only one-half or one-third of the plain, and all the rest is dead land. We will presume, however, an underflow beneath this remaining, or dead land, which can usually be found at a depth of from twenty to fifty feet. This would furnish an inexhaustible supply of good water for irrigation could it be gotten economically to the surface. The great bulk of the lowlands of the valleys adjacent or tributary to the forest areas of the Rocky mountains or the Sierra Nevadas are underlaid with this water—a practically inexhaustible supply suitable for pumping. Fuel, however, is often expensive, although a 1,000 horse-power electric plant near Grand Junction, Colorado, is operated by burning slack coal costing

comparatively nothing. This installation is delivering 50,000 gallons a minute fifty feet high, adequate for irrigating 10,000 acres of orchard.

Storage reservoirs can be constructed in the mountains in such manner as to utilize the power of a river or its fall to the full extent, and from this plant or plants the power generated can be transmitted down the valley to the twenty or forty acre irrigated farms, where it can be applied to an electric motor operating a pump lifting water upon the land as required. This should be the ideal irrigation system. The farmer could start his motor and the water will come. When he has enough he shuts it off. His water-supply is right under him in great abundance. The practicability of this development has already been demonstrated by a number of plants already in operation in the San Joaquin valley of California, where it is claimed that water is actually being pumped at less cost than from gravity ditches, but the author does not stand voucher for the completeness of this statement. There are no doubt many opportunities where electric power plants can be economically installed in the cañons and the water from these used to irrigate the fields miles away. The power from these plants can be conducted to points beyond reach of the canals and employed in lifting underground waters to the surface.

#### **Induction Motors for Combination Pumping.**

—One of the largest and most successful electric pumping plants in the world is operated by a land company in Kern County, California. This concern instituted a very careful investigation to determine the cheapest and most effective means for raising water

for individual consumers, and the combination is now using a special type of centrifugal pump adapted to low lift and high speed—characteristics which make it possible to directly connect the pumps to standard high-speed induction motors. Twenty-five pumping plants are operated under this system, each delivering from 1,400 to 2,000 gallons a minute, and it may be said in a very liberal sense that the investment has been fully justified by the service performed during the most drouthy conditions. The average cost of each battery was \$3,500. Each station consists of four wells in a line sunk to a depth of from 80 to 130 feet through strata of alluvial loam, clay, and water-bearing sand. The wells are cased with galvanized iron pipe thirteen inches in diameter No. 16 gauge, perforated with vertical slits opened about a sixteenth of an inch.

The casing was landed in clay, perforating all the sand below a depth of thirty feet. The shoe on the starter was somewhat larger than the casing, and by means of a small supplementary sand pipe sunk to the first water the sand encountered by the large casing was inclosed in a layer of coarse sand which, while effectually excluding the flow of fine sand, offered little obstruction to the water entering the casing. Surface water was encountered at a depth of from ten to fifteen feet, and, as a rule, a flow of three to four cubic feet a second was secured when the thickness of the water-sand was from twenty to thirty feet. In this kind of work much depends on the care and skill exercised in sinking the wells, securing a proper landing, and adapting the perforations to the quality of sand

encountered. The Kern county wells are six feet apart on centers, and the flow from four wells is a little more than double the quantity supplied by one well. The sills of the pit on which the pump is set are placed at the surface water-level, and the water is exhausted in the wells to a depth of from twenty-two to twenty-eight feet, making the total lift from thirty-five to forty feet. The pit was excavated to water and lined with redwood one inch thick. The pump was set in the center with two wells on either side, and is of the ordinary centrifugal pit type, with a specially designed runner adapted to permit of direct connection to a high-speed vertical shaft-motor, without sacrifice of efficiency.

**Efficiency of Service.**—The pumps are scattered over a wide area of land belonging to the company, and are operated by three attendants and one inspector. The attendants are paid \$40 a month and are required to visit each station under their charge once or twice a day. The stations are so far apart that the men have to ride from twenty-five to thirty miles a day to perform their duties, and one man operates as many as ten plants. The inspector is a skilled mechanic, who, as far as possible, anticipates any deterioration, and when accidents do occur is prepared to make repairs with the least delay possible. During a whole year there were months when the actual operating period of all the pumps was over ninety-eight per cent. of the possible time. The pumps ran night and day, Sundays included, except when the current is shut off the lines to permit electrical repairs, and thus beneficial use is made of the water throughout the year.

Continuity of service and large volume, with constant demand for the water, are the requisites for successful and economical pump irrigation. These conditions have been met by the use of electrical power, by grouping several pump stations together within a quarter of a mile of each other, and by utilizing the water pumped on the company's storage crops when no other demand exists for its use elsewhere. Experience has demonstrated in a practical way that pumping to reasonable heights can be made a commercial success. By this installation the company is enabled to sell water to farmers at the rate of seventy-five cents an acre foot, and the actual cost an acre per annum is under rather than over \$1.50. While this figure does not mean large profits, it may be said safely that it covers power, attendance, interest, and depreciation, and does not involve any loss to the operating company. Individual installations will not attain results so favorable as these because the necessary experience and organization are not available on a small scale, but where electric power can be had as cheaply as in this case, and neighbors combine to construct pumping plants for joint use in rotation, the cost an acre should not exceed \$2.50 per annum.

## CHAPTER XXII.

### IRRIGATION IN HUMID CLIMATES.



IT is a well-established fact in agricultural economics that no soil can produce large yields if it is not in good tilth ; no soil can support heavy crops that does not contain the requisite materials for conversion into available food ; no abundance of available food and no degree of perfection of tilth can take the place of the right amount of soil moisture at just the right time. On the lighter soil, of which there are many thousands of acres east of the Mississippi river, the water capacity of which is small, there is every reason to believe that supplementary irrigation will give increased crops, especially under high fertilization. When the influence of irrigation on the yield of higher-priced crops like the small fruits and market gardening is considered, there can be no question of the commercial advantage of supplementary irrigation where the water may be handled at a moderate cost.

It is not so much a deficiency of rainfall in the eastern United States as it is the unfavorable distribution which so often gives too little soil moisture for large yields. All crops when forming fruit buds and developing the fruit require water at much more than the average rate, and it is deficiency of moisture at such times which so greatly cuts down the yields. In-

asmuch as an abundance of soil moisture and good tilth are prime requisites for the development of available nitrogen, it is clear that a deficiency at any time between July and September must reduce the yield by lessening the rate of nitrate development, and the prevention of this occurrence by supplementary irrigation must tend to maintain a higher average. The case is rendered still more critical by the fact that when the amount of soil moisture is drawn down very low, the rate at which it can travel through the soil by capillarity to reach the roots is so much reduced by relatively greater friction that growth must slow down because the water cannot move rapidly enough to meet the needs.

It must be remembered also that the rains are never as effective after the soil has been permitted to become too dry, for the reason that it is retained so close to the surface that it does not reach the roots, and a very large percentage of it is returned at once to the atmosphere through evaporation from the soil. In many states the rainfall for June, July, and August may average more than twelve inches, and yet a second crop of hay without irrigation is a very rare possibility, chiefly because the first crop so thoroughly dries the surface soil that future rains are largely retained by it and returned to the atmosphere without helping the crops or assisting in developing plant-food. There may often be moisture enough in the second and third foot so that a small supplementary irrigation puts the soil in prime condition, and hence a comparatively small cost when compared with the demands of the arid region would ensure a second and third crop of hay. Besides, it has

been demonstrated that timothy, which is an exceptionally harsh and fibrous plant, when raised under irrigation is over five per cent. better in quality and in nutritive properties than that raised in a state where the rainfall is more than forty-eight inches annually.

So far as growth and quality for various uses go, there is no peculiar virtue in rainfall, but there is every advantage in wise irrigation, which means using water at the right time. The experience of centuries in various countries shows that irrigation water is generally superior to rain-water, in that it carries greater quantities of plant-food, and for this reason irrigation should be considered advantageous by farmers living in a humid climate with its erratic and superabundant rainfall. Easterners express wonder at times when seeing men afield in the far west irrigating during rain-storms, protected by rubber clothing. They argue that if enough moisture is being precipitated to compel the use of water-proof clothing it is not necessary to artificially water the growing crops. This great error is always made in considering the benefits of irrigation. Rain never fell on growing grain, especially about the time of heading out, that would have the same effect which good irrigation would produce. This is obvious. To secure complete saturation of the soil to a depth of from six to eighteen inches, depending on the composition and condition of the soil, would necessitate a cloudburst, with its attendant destruction to both soil and crops. We are not discussing the effect of irrigation upon the moisture content of the atmosphere, although the more the principles of irrigation are put into effect the less will be the need of artificial moisture.



**Losses by Drouth.**—Up to the present time little has been done in eastern states with irrigation in producing farm, garden, or orchard crops, but its great value has been demonstrated in a few striking instances by some leading fruit growers, and these, together with the general interest that is being manifested in the subject, show the need of information such as is contained in this work. Within the past few years a lively agitation of the subject has appeared in the agricultural press of the east, and farmers and small fruit growers are beginning to appreciate the value of artificial watering. In the eastern portion of this country the intensive system of agriculture is rapidly replacing the extensive. This has become necessary because of the rapidly increasing population and a corresponding increase in the value of lands.

In the last fifty years the agriculture of New England has been entirely changed. A system of general husbandry has been largely replaced by special branches of farming. The many thriving manufacturing cities and towns that have been built have caused great demand for fruits and vegetables. These products have proven especially profitable where markets are near at hand. The high acreage value and the active and increasing demand for fresh fruits and vegetables have induced many farmers to enter upon the production of these crops. It is in such lines of farming and market gardening that irrigation has its highest value. Where the cost of cultivation is large the losses from drouth are felt all the more severely, for the expenses are essentially the same whether a half crop or a full crop is harvested. Losses of from \$100 to \$200

an acre, as a result of a few weeks' drouth, are not uncommon.

**Utilizing the Water.**—The sources of water for irrigating purposes throughout the east are mainly from small natural streams, from ponds, wells, and from springs. The water is usually stored either in open ponds or in large tanks. One man in Michigan utilized a five-inch spring brook on his place so as to irrigate eighty acres of land. He estimated the value of the spring to be worth more than \$5,000 and capable of paying 6 per cent. per annum on that basis.

The means of making the water available are through some form of power, such as a ram or windmill, or, when the source is high enough above the fields to be watered, it is conducted to and over the fields through open ditches or pipes. There are many instances where the water can be made available only by some form of power, as the water is below the fields upon which it is to be applied. Where the water is supplied by means of a ram or other pumping appliance it becomes necessary to economize in the use of water and to prevent losses by evaporation in order to reduce expense. For these reasons it has often been thought advisable to apply the water from pipes distributed over the fields, but the author has always deprecated this system as being too much of the clap-trap order. Still the water is sometimes allowed to flow between the rows from pipes laid along one end of the field. In other cases it is applied by spraying. The cheapest and simplest method of distributing water is by conducting through open ditches, and there are many instances where this is being successfully done.

There are many localities in the east, especially in hilly countries, and oftentimes along the side of a river valley, where a terrace rises to a considerable height above the flood plane from which water is continuously but slowly oozing from the ground to such an extent as to keep it swampy and unfit for agricultural purposes. In many such cases the water can be led out by underdraining upon lower lands and stored in reservoirs to become warm, and then applied to the surface for irrigation, at the same time rendering the land from which the water has been withdrawn fit for cultivation, as described previously in this book. Besides the deeper artesian waters which are available in many localities for irrigation purposes, there are a larger number of places where flowing wells of the artesian type may be sunk and their waters used for the irrigation of small areas. In these cases the water may often be raised to a height of several feet above ground and thence led away to where it would be valuable for irrigation in either a kitchen or market garden. Often such wells will supply the equivalent of a 1-inch stream flowing four miles an hour, which is water enough to irrigate to a depth of four inches every ten days 2.42 acres of land, or about five times the area a 3-inch piston pump with a 12-inch stroke will raise when working eight hours a day and making thirty strokes a minute.

**The Eastern Duty of Water.**—The amount of water needed for irrigation varies within wide limits, being affected by the climate, weather, kind of soil, variety of crop, manner of application of the water, and by the character of cultivation which the field receives

subsequent to irrigation. The amount needed for a single watering must be determined by the quantity of water the soil contains at the time it is to be irrigated, and by the amount it should contain in order that plants should work to the best advantage. The maximum capacity of upland field soils for water ranges from eighteen per cent. of their dry weight for the light sandy types to about thirty per cent. for the heavy clayey varieties, while the amounts of water these soils should contain in order that plants may thrive in them best is from twelve to fourteen per cent. for the former and from eighteen to twenty per cent. for the latter. Since water should be applied as soon as the water content of the sandy soil falls to eight per cent., and that of the clayey soil to fourteen per cent., it follows that under these conditions 10.5 pounds of water, or two inches, is the maximum amount which would be needed to fill the surface foot of sandy soil, and 12.8 pounds, or 2.46 inches, is enough to fill the surface foot of clay soil.

If we consider the second foot of soil to have been dried out to a corresponding extent, and that it is desirable to also saturate this with water, then the amounts just stated would need to be doubled. In humid irrigation not more than 800 to 1,500 barrels an acre should be applied at one time, for if heavy rains should follow the ground may be saturated. Even with the most thorough cultivation, anywhere from a half inch to two inches of water a week can be used to advantage by vegetables during May, June, July and August, and unless the natural supply available approximates this amount, it should be supplied arti-

ficially in proportion to the character of the soil and season and the needs of the crop, at least one inch being taken as an average for each application for good garden soils. In this connection the writer would like to suggest that drainage is of more vital importance than in the arid region, where provision is largely made for such emergencies by the laws of nature. The principles and methods of irrigation as outlined so minutely throughout "Irrigation Farming," are fully applicable to the needs of eastern farmers, and they cannot go very greatly amiss by following the instructions to the letter.

## CHAPTER XXIII.

### WINTER IRRIGATION.

**T**HIS subject is a matter which has become of paramount importance throughout the arid region during the past decade, and we can see on every hand the beneficent influences of the system wherever it has been conscientiously carried out. The possibility of storing water in the soil during winter is better understood yearly and the practice is rapidly becoming more general. Right here it must be understood by those unacquainted with the circumstances that the great plains of arid America are practically snowless throughout the winter months, and for this reason the running of water during the milder hibernal days is a very easy and simple task when the supply is available. In parts of Kansas it has been found possible to store enough water in the soil by winter irrigation to mature the summer's crops. In Colorado it is quite common to give all kinds of plowed land a good wetting early in winter and often again in midwinter. There are large ranches in Wyoming with a limited supply of water on which irrigation is systematically given to hay land in the winter to supply moisture for the coming crop. Such practice enables the owner to double the amount of meadow from which to cut hay. The land supplied with moisture in the winter is not necessarily irrigated during the summer months, and the summer supply is used on

separate areas. This practice is in full accord with the old eastern idea of our boyhood days which proclaimed that a wet fall on meadow or pasture always predicted a fine growth of grass and a good hay crop the following summer.

**Winter Evaporation.**—It is a fact well understood by observers that evaporation from the surface goes on at all times and under all conditions of temperature, but is naturally least rapid during the colder months of the year, and especially when the ground is frozen. Water put on the ground late in the fall and during the winter will sink deeper and deeper into the subsoil before its downward course is stopped by surface evaporation. While ordinarily in the summertime an inch of water will wet down from four to six inches of soil, in the winter this same amount of water will sink to nearly thrice this depth, or from twelve to eighteen inches, and will remain there until withdrawn by solar capillarity in the warm days of early summer. It is quite practical to have the ground wet down five or six feet, so it will freeze as deep as possible. If it is thoroughly wet, it is surprising how deep the frost will penetrate. If this land is plowed in proper condition scarcely a clod will be found, nor will a roller or float have to be used. Very little water will be required during the following season. Crops on such land will withstand any amount of dry wind, and will be doubly productive in comparison with crops grown entirely by summer irrigation. If the subsoil is thoroughly wet the succeeding season will indeed be a rare one that will not produce a crop of barley, oats, or wheat by the ordinary rains of spring.

There are successive winters when there is not enough rain or snow to wet the subsoil, hence the spring and summer rains fall on a soil unfavorable by its dryness to make proper use of the water, and instead of soaking into the earth to any depth it runs off rapidly or evaporates. Enough rain may fall in the spring to mature a fair crop, provided the subsoil is sufficiently wet from winter irrigation. Many fruit and forest trees die from the lack of moisture in the subsoil in winter. Rain may keep the surface soil in moist condition, sufficiently so to produce growth, but the feeding rootlets having penetrated the dry subsoil, cannot obtain enough moisture to equalize the evaporation going on through the leaves, thus starving the tree to death.

**Some Valuable Experiments.**—The value of conserving moisture on fruit lands by mulches through the winter has long been understood and is widely practiced by many farmers, and the value of winter irrigation for orchards is no longer questioned. As we have said, the winters are long and dry in the arid region, there is no continuous mulch of snow, and the orchardist who cannot irrigate late in the fall or occasionally through the winter is unfortunate. The value of irrigating alfalfa in the fall has been tested by a friend of the writer. Alfalfa irrigated late in the season, October 2d and 3d, did not winter-kill as badly as that not irrigated. The quantity applied cannot be estimated accurately, but as nearly as can be estimated enough was used to cover the land six inches deep. The plants which were fall irrigated started earlier in the spring and made better growth, at one time being four



to five inches higher than those not so irrigated, and the dividing line marked by the water could be traced up to the time of first cutting. In spite of the fact that evaporation was sufficient to remove nearly or quite all of this water during the winter months, its influence was felt far into the following growing season. It must be understood by foreign readers that such a wetting could be applied only to the extraordinary dry soils of the arid region, where heaving out by frost expansion is unknown, and the writer very much doubts if such practice would be advisable on the more moist soils of the east.

On land in the dry zone used for the production of cultivated crops, where the surface soil can be stirred frequently to prevent loss of water by evaporation, winter irrigation is far more effective than on grass land. Such irrigation has been practiced somewhat successfully in Colorado and Utah by potato growers. The fields are flooded before plowing and allowed to dry to a tillable condition. This treatment insures perfect condition of soil for working and for the first growth of the plants. The ordinary methods of cultivation follow in this system without the application of water until the plants are in bloom. In parts of California, water supplied to the land during the winter or wet season is often sufficient to mature crops, although they may not receive any water between planting and harvesting, and the same is true in Utah. In such places complete and continuous cultivation is practiced to prevent the soil from losing its store of moisture through evaporation. It is necessary to continually stir the surface to form a natural mulch.

It has been found by nearly all observant irrigators of the great plains that winter irrigation, thoroughly done, serves very well the double process of fertilizing and moistening. Captain Perry, of Kansas, says that after ten years of extensive experience in irrigation he has had the best average results by thoroughly saturating the soil to a depth of two or three feet during fall or winter or very early spring, then cultivating crops on this land without subsequent irrigation. C. B. Huffman, of Enterprise, Kansas, has found that land thoroughly irrigated and well cultivated during winter, and afterward sown in wheat, produced surprisingly well without any irrigation after the wheat was sown, while similar land that had not been irrigated gave a very poor yield. The general experience favors winter irrigation. Not unlikely, future practice in the application of water will consist in thoroughly wetting the soil during the winter and in such subsequent irrigation as may be found desirable to maintain maximum growth, the larger quantity of water being applied in winter when evaporation is at a minimum.

**Orchards in Winter.**—Throughout the irrigated regions of the west it has been the prevailing practice with orchardists to withhold water from trees during September and October in order to let the new wood ripen, then give one irrigation late in November, with no other applications until after the buds blossom in spring. The reasons for this method of treatment were founded on the hypothesis that the trees did not need water during the winter months when they were dormant, and that by keeping off the water the fruit buds could be retarded from blossoming too early in



the spring. It is needless to say that no objection can be raised against withholding water while the young wood is ripening, but that by keeping water from the trees in the spring the blossoms are held back has been shown to be a fallacious idea. The fact is that the bursting of the bud is entirely dependent upon the state of the outside and surrounding atmosphere. It is a well-established fact that the application of water to the roots puts off rather than hastens the blossoming period by the chill that has been introduced to the ground.

The mistaken notion about trees needing no irrigation during winter has no doubt arisen from two sources: There is a popular delusion that the tree is dormant during winter. Any one who has heeled in young trees in the fall and lifted them again in spring cannot have failed to notice that the roots have made growth during the interval. Moreover, by careful measurement it has been proved that even the trunks of trees, and doubtless also the branches, actually increase in girth during the winter months. It is therefore evident that the tree is in active growth during winter and is laying up a store of energy for the coming summer. If the tree during that period suffers from drouth, its vitality must necessarily be weakened.

People have been told that in California it is not customary to irrigate orchards during winter. They, however, have not taken into consideration the fact that heavy rains fall over the greater part of the Pacific coast, whereas in the region of the Rocky mountains the winter months are the dry season. Furthermore,

if we look at those countries where fruit grows to the greatest perfection without irrigation, we see that they have their principal rainfall during the winter. This is true in the south of France, where nature gives a valuable lesson on the application of water to fruit trees during the hibernal rest. The writer has observed two large peach orchards on similar land and within a quarter of a mile of each other, one of which was not irrigated during winter, while the other received three or four copious irrigations. The peach blossoms opened a few days later in the irrigated orchard, but its fruit ripened at least a week ahead of that in the other orchard. The moisture of the soil probably tended to keep the air cool around the irrigated trees and so retarded the blossoms, but when the fruit on these trees started to grow it rapidly overtook that on the others, which, owing to lack of moisture, were deficient in vitality, whereas the irrigated trees were in condition to devote all their energies to the development of fruit. In the Mesilla valley of New Mexico it has been customary to hill up grape-vines with earth in November and to apply water during the winter. The cold is not feared so much as the dry winds in the early months of spring. The writer called editorial attention to this fact in the *Field and Farm* several years ago, and as a result nearly all the vineyards around Denver and elsewhere in Colorado are now treated in this manner as the complete means for winter protection.

**Depth of Saturation.**—A winter-irrigated orchard in Southern Arizona was once tested to determine the moisture content of the soil. A sample of

each foot from the surface to ground water was taken during April, May, June, and September. In taking the samples of soil, roots were encountered in abundance as deep as fourteen to sixteen feet, while one peach root was followed into the twentieth foot at a horizontal distance of eighteen feet from the tree, showing that the water of at least the upper twenty feet could be used by the trees. The upper five and a half feet was clayey loam; the next nine feet gravel; then about a foot of clay; then another foot of gravel, and the rest of the way to water a fine clay. Hence the roots had passed through ten feet of gravel and four feet at least into the clay beneath.

The total results indicated that the irrigating water had penetrated to a depth of twenty-four feet. The sixteenth foot contained the most moisture, the soil being so nearly saturated that it was muddy. From this point the moisture was less abundant until the twenty-sixth foot was reached. From here the percentage of water increased gradually until ground water was found at thirty-four feet. Samples taken as late as September showed that while the upper fifteen feet were comparatively dry the lower extremities of the roots were still surrounded by moist soil. The conditions above ground were very satisfactory. The trees grew thriftily and maintained vigorous appearance throughout the season. They were well loaded with fruit, the peaches and apricots being larger than the previous year when the orchard was irrigated frequently during the summer.

**Preventing Frost.**—The claim has often been set up that irrigation will assist greatly in saving ten-

der vegetation from early spring frosts. Fruit buds may stand a temperature of twenty-six and come out with a little harm where other conditions are reasonably favorable. A temperature of twenty-two usually proves fatal. The temperature to drop suddenly to the freezing-point, thirty-two, has not often resulted in much harm. Observation shows that anything which tends to raise the dew point lessens the damage from a freeze. That is, should the dew point be raised to nearly thirty-two or above there will be no harm. An increase of humidity in the atmosphere raises the dew point. Accidental irrigation of vegetable and fruit plants on the afternoon and evening preceding some severe freezes has shown that the plants so irrigated were protected. Doubtless there is considerable latent heat set free in the cooling of flowing waters and ditches down to the freezing-point.

At any rate, numerous instances are at hand showing that those who spray their vegetables or fruit trees during the night of a spring freeze save their vegetables and fruits, while unsprayed plants 200 feet away are cut down by frost. Those who happened to be irrigating plots of melons or other products the same night found that as far as the water extended, tender vegetables and fruit plantations were saved. Numerous instances have fully illustrated this fact. Others have saved strawberry bloom by maintaining a smudge through a particularly critical night. Ordinarily we have in each spring but one dangerous night, and if by a combination of watering and smudging harm can be averted, the expense is so light and the returns are so marked over neglect that both of these methods seem

well worthy the attention of orchardists and planters everywhere. Observation seems to show that the protection afforded by copious watering is very much greater than that by smudging.

The irrigation planter fortunately has both of these safeguards available, and with the aid of them should almost certainly protect his crop each season. It is wise, therefore, to be prepared, that the ditches should be in running order, the laterals cleaned up, and everything in readiness to apply water at the critical time. Accumulated waste material, stable litter, chaff, straw, brush, anything that will make a smoke, should likewise be accumulated on the windward side of the plantation in readiness to make use of both materials for averting the danger arising from the occasional freezes which have sometimes become destructive to orchard and vegetable products.

## CHAPTER XXIV.

### THE COMMON LAW OF IRRIGATION.

**E**ARLY in the history of agriculture in the arid regions of the west, it became apparent that the common law, rules and principles of riparian ownership could not obtain; such laws would have been unjust, and were wholly unsuited to the condition of affairs there found to exist, and the people set about to discover principles and formulate rules which might be more just and equitable. The questions are numerous and complex, the whole matter is fraught with problems most difficult, new theories are constantly arising, and the greatest diversity of views exists among those who have given years of close and careful study to the subject; and how far the people have succeeded in their efforts to solve these questions can only be determined by a careful examination of the statutes and decisions of those States and Territories where the subject of irrigation has commanded the attention of profound thinkers and able jurists. The writer's humble opinion is that the laws upon these subjects are far from perfect in any section of the arid country, and he furthermore believes that many years of evolution and change in these laws will be necessary before anything approaching a just exposition of the principle applicable will assume a definite form.



The Colorado Constitution, Sec. 5, Art. XVI, declares the water of every natural stream to be the property of the public, and Section 6 in substance gives the prior right to the prior appropriator to beneficial use. The underlying principle seems to be that the water of all natural streams belongs to the public until appropriated to beneficial use, and then to the prior appropriator, and these principles with slight variations more or less well defined are the basis of the laws upon the subject in other States and Territories, where for natural reasons the rules of the common law do not obtain.

The common law rules and principles of riparian ownership never obtained in Colorado. The Constitution, Secs. 5 and 6, Art. XVI, declaring the waters of all natural streams to be the property of the public until appropriated to beneficial use, and that it then belongs to the prior appropriator, is only declaratory of an unwritten law which existed long prior to any legislation or judicial decision upon the subject, and arose from the peculiar conditions of soil and climate.

Schilling <i>vs.</i> Rominger,	4 Col.	103
Thomas <i>vs.</i> Guiraud,	6 Id.	532
Coffin <i>vs.</i> Left Hand Ditch Co.,	Id.	446

And the various acts of Congress upon the subject are but the recognition of a pre-existing right, and not the establishment of a new one.

Broder <i>vs.</i> Water Co.,	101 U. S.	276
------------------------------	-----------	-----

Waters in the various streams of this climate acquire a value unknown in moister climates; the

right to its use is not a mere incident to the soil, but rises to the dignity of a distinct usufructuary estate.

Coffin	<i>vs.</i> Left Hand Ditch Co.,	Supra.
Rominger	<i>vs.</i> Squires,	9 Col. 329

It may safely be said that in all the States and Territories, where, as in Colorado, these rights are of peculiar and paramount importance, they are treated as realty. The Colorado Legislature in 1893 (L. 93 p. 293) enacted that thereafter all conveyances of such rights should be by deed with usual formalities; but in ordinary cases such was probably the law before the enactment.

Yonker	<i>vs.</i> Nichols,	1 Col. 551
Hill	<i>vs.</i> Newman,	5 Col. 445
Schilling	<i>vs.</i> Rominger,	4 Col. 100
Barkley	<i>vs.</i> Tickele,	2 Mont. 59
Smith	<i>vs.</i> O'Hara,	43 Cal. 371

The right when vested may in some cases be appurtenant to the soil upon which it is used, but generally it is separate and distinct from the ownership of the land, and a conveyance of the latter would not carry the water right, unless mentioned in the deed; the right, though it can only be acquired by appropriation and use, may, when acquired, be sold, transferred to and used upon other lands.

Fuller	<i>vs.</i> Swan River P. M. Co.,	12 Col. 17
--------	----------------------------------	------------

The place of use as well as the point of diversion may be changed, when such change works no injury to others.

Fuller	<i>vs.</i> Swan River P. M. Co.,	Supra
--------	----------------------------------	-------

The right is in no way dependent upon the *locus* of its application to the beneficial and designed.

Hammond *vs.* Rose,

11 Col. 526

The lands irrigated need not be on the banks, nor even in the vicinity of the stream from which the water is taken. The water may be conducted across a watershed and onto a different drainage and yet the right is preserved.

Coffin *vs.* Left Hand Ditch Co.,

*Supra*

The right is absolute and unqualified so long as it exists. It may not be lost by abandonment.

Siber *vs.* Frink,

7 Col. 154

Dorr *vs.* Hammond,

Id. 83

Burnham *vs.* Freeman,

11 Id. 601

But proof of non-user as evidence of abandonment must be strong; failure for an unreasonable length of time to use the water may afford a presumption of intention to abandon the right, still such presumption may be overcome by satisfactory proofs.

Siber *vs.* Frink,

*Supra*

An intention to abandon may be shown in various ways. It has been held that an attempted verbal transfer or sale of the right operates as an abandonment, as it conveys nothing and manifests an intention to part with the right.

Smith *vs.* O'Hara and Barkley *vs.* Tickele,

*Supra*

But it must be borne in mind that as abandonment is a question of intention, the acts of the party to be

conclusive (unless there be some element of estoppel) must be so very strong as to scarcely be susceptible of explanation. The party will not be held to have surrendered a valuable right, except upon evidence reasonably clear and satisfactory.

Rominger *vs.* Squires,

Supra

Doubtless a party may also lose his right by non-use, and as the right is regarded as realty, it is probable that by analogy, at least, the laws of limitation and prescription apply; it seems that acquiescence in adverse use during the period fixed by the statutes of limitation would bar the right.

Union Water Co. <i>vs.</i> Crary,	25	Cal.	504
Davis <i>vs.</i> Gale,	32	Id.	26
Smith <i>vs.</i> Logan,	18	Nev.	149
Woolman <i>vs.</i> Garringer,	1	Mont.	535
Crandal <i>vs.</i> Woods,	8	Cal.	136

The continual use of water for beneficial purposes is essential to the existence of the right; and when the right is lost either by abandonment or non-use, it goes either to the next prior appropriator or reverts to the public.

It is not believed that a user for any length of time will give title by prescription or limitation as against the government.

Union Ms. M. Co. <i>vs.</i> Ferris,	2	Saw.	176
Matthews <i>vs.</i> Ferrea,	45	Cal.	51
Ogburn <i>vs.</i> Comer,	46	Id.	346
Van Sickle <i>vs.</i> Hains,	7	Nev.	247

The right in this respect is of much the same nature as the possessory right to public lands, and when abandoned it reverts to the government and is subject to appropriation by any one else; or he may return, reappropriate and acquire all his original rights, if the claim of no one else intervenes.

Tucker vs. Jones,

19 Pac. Rep. (Mont.) 571

It was never designed that these rights should be held without use for beneficial purpose, and in this a "water right," so-called, lacks one of the qualities of realty or title to the land. It is probable that any one possessing a water right and failing to use the same for a continuous period equal to that of the statute of limitations would lose the right, but if at any time during that period he had used it the right would still exist; and herein is a defect in the law, for no one having acquired so valuable a right should be permitted to withhold the use from others, unless he use the same himself, and even if the law would permit others to condemn the right the remedy would, in most cases, be tedious, expensive, and barren of benefit. The principle herein announced, that the existence of the right depends upon the user, is in consonance with the Constitution, and all reasoning upon the subject; but the courts, by way of construction, give the possessor of the right the privilege of non-user, and thus nullify the spirit of the law. The loss of his right is made to depend upon his intention, *i.e.*, abandonment, when he should be held to a reasonably continuous use of the right, or allow it to revert to the public. In the present condition of the law in Colo-

rado, as established by these decisions, were it not for the legal and physical impossibility of preventing the water of natural streams from being used by settlers who need the same for irrigation, a monopoly of non-using proprietors could, and might be, maintained, to the serious detriment of the agricultural interests of the State, and an express statute of limitation upon this subject would avert any evil from the source indicated. One holding a water right should be required to use the same for a beneficial purpose every year or else forfeit his right, and the Colorado Legislature has latterly provided a statute covering the exigencies of such a circumstance.

**Acquisition of the Right.**—The right can only be acquired by *appropriation* and *application to beneficial use*, and the true test is the successful application to the beneficial use designed; and the method or means of diverting or carrying the same is immaterial.

Thomas *vs.* Guinard, 6 Col. 533  
Farmers H. L. Canal & R. R. Co. *vs.* Southworth, 13 Id. 114

An erroneous notion for some time prevailed that the construction of a ditch with a given capacity was equivalent to the appropriation of water to the capacity of the ditch, but recent decisions have exploded that idea. A party may employ any means he chooses to conduct the water from the stream to the lands irrigated; open physical acts, such as the construction of a ditch, flume, or other conduit is usually evidence of, but does not constitute, appropriation. But our courts have, by a line of decisions, established what may be

termed *constructive* as distinguished from *actual* appropriation.

Siber	<i>vs.</i> Frink,	Supra
Larimer Co. Res. Co.	<i>vs.</i> People,	8 Col. 617
Wheeler	<i>vs.</i> N. Col. Irr. Co.,	10 Id. 588
Farmers' H. L. C. & R. Co.	<i>vs.</i> Southworth,	13 Id. 115

These decisions have led to much confusion and uncertainty, and the doctrine will be fruitful of litigation. It is said that when a person commences the construction of a ditch, tapping a stream and thereafter within a *reasonable time* completes his ditch and diverts and applies the water to beneficial use, his right thus acquired relates back to the time of the commencement of the construction of the ditch. The Constitution seems to give the right to the first *actual* appropriator to beneficial use, but the courts have apparently engrafted a new principle upon that instrument—the term “reasonable time,” uncertain and indefinite in itself, becomes more so when applied to the various cases which arise under these laws. No man knows or can know what is a “reasonable time” in a given case until the courts have passed upon the case. What might be considered reasonable in one case might be considered unreasonable in another, even under circumstances somewhat similar. “Reasonable diligence” is said not to imply unusual or extraordinary effort. It is also said that sickness and lack of pecuniary means, being matters incident to the person and not to the enterprise, will not excuse great delay, and hence it follows that health and wealth, being also incident to the person only, are not matters

to be considered, and the difficulty is that there is no fixed standard or rule by which the claimant may be governed in determining what is or would be considered "reasonable time" or "reasonable diligence."

**The Use Must Be Beneficial.**—The use must be truly beneficial, and the appropriation must not be excessive, nor for speculative purposes. And in determining these questions the amount of water appropriated, the use to which the same is applied, the quantity of land, character of soil, etc., are to be considered.

Combs *vs.* A. D. Co., 17 Col.

The character, value and extent of the crops, and their need of water for irrigation, should also be considered, and the waste of any ditch, flume, pipe-line, or other conduit, should be the loss of the claimant.

"Natural streams" are not easily defined in terms which will admit of universal application. It is said that to constitute a water course there must be a defined channel with bed and banks.

Barnes	<i>vs.</i> Sabron,	10 Nev.	217
Simmonds	<i>vs.</i> Winters (Oregon),	27 Pac. Rep.	7
Barkley	<i>vs.</i> Wilcox,	86 N. Y.	143
Gibbs	<i>vs.</i> Williams,	25 Kansas	220
Jeffers	<i>vs.</i> Jeffers,	107 N. Y.	651

But whatever definition may be adopted it is apparent that the term "natural stream," as used in the Colorado Constitution, refers more particularly to the character and source of supply than to the form of the stream. The principal source and origin is the melting



of snows on the mountain ranges. These waters assume different forms, sometimes as springs, rivulets, ponds and lakes, depending upon the character of the ground through or over which they pass. Sometimes these waters percolate through the ground and pass unseen for miles and then appear as springs. These are as a rule feeders of the natural streams and in contemplation of law are a part of them, and to divert the waters from a spring or lake which is the source of supply of a natural stream could scarcely be distinguished from the appropriation of water from the stream itself. How far the owner of lands upon which springs arise may be permitted to use the water, allowing it to flow on after use, would no doubt depend upon the character and amount of the land, and the nature of the spring or springs. We are now referring to what may be termed natural as distinguished from artificial springs, produced by waste or seepage water, escaping from reservoirs, ditches or canals, or the surplus produced by irrigation. The right to these waters is defined by statute. By an act of the Colorado Legislature of 1889, Act LXXXIX, p. 215, a prior right to the use of seepage or spring waters is given to the person upon whose lands the same first rises, but the term spring waters as used in the act doubtless refers to artificial springs, produced by seepage or waste water. If, however, it should be held to apply to natural springs, it might be of doubtful constitutionality. Anything which tends to diminish the source of supply water in a natural stream to the detriment of prior appropriators is prohibited, hence the digging of wells close to a stream, so that the water from the

stream percolates into the same, is held to be but indirectly appropriating water from the stream.

McClellan *vs.* Hurdle,

33 Pac. Rep. Col. App.

And so if a source or supply of a natural stream were a lake, to take water from the lake would be an infringement of the rights of prior appropriators from the stream. Any body of water in whatever form, originating from natural causes, and supplying and having an outlet through a stream with well-defined channel, is a part of a "natural stream," and the waters are subject to appropriation in the same manner.

**Carrier's Diversion.**—Canals or common carriers are permitted to divert water from streams, to be appropriated by their patrons, and many thousand of acres of valuable lands are irrigated and made productive by this means, where otherwise it would be impracticable. In such case the right of use is in the consumer. The canal company is in one sense a *quasi* public servant, and is entitled to reasonable compensation for the carriage. When a canal is commenced and completed within "reasonable time," the consumers who thereafter, within "a reasonable time," appropriate waters therefrom to beneficial use, have priorities dating from the carrier's diversion.

**Ditch Rights.**—The right of way for ditches is easily and oftentimes confused with water rights—the former is no more or less than a right of way or easement through lands, but in some cases as evidence of appropriation, furnish the measure of the water right. The Colorado Statutes provide for a record of ditch statements and the Legislatures have gone so far as to

declare that the construction of a ditch and record of statement shall give priority of right to water, but all such statutes are in that respect unconstitutional.

**Adjudication of Priorities.**—The Colorado Statutes provide a method for the adjudication of priorities as between claimants of water from the same stream ; and many attempts have been made by the courts to carry out these laws, but with little success and unsatisfactory results, mainly from the fact that the law is imperfect, vague, and indefinite, and the courts in attempting to follow its provisions have lost sight of constitutional restrictions. In many instances the construction and record of a ditch right was treated as equivalent to the appropriation of water to the extent of the capacity of the ditch, and in some instances parties were decreed priorities, to take effect upon future contingency, when an *actual* appropriation to beneficial use in each case should have been the basis of the decree.

**Rights Existing in Parole.**—Under the Colorado system, water rights exist almost exclusively in parole, and hence there is the greatest latitude for disputes and litigation. Since these rights have been declared to be in the nature of "realty," a code of laws should be enacted requiring a complete public record to be kept of each water right.

## GLOSSARY OF IRRIGATION TERMS

---

- Acequia**—Spanish name for an irrigating canal.
- Acre Foot**—Amount of water covering one acre, one foot in depth.
- Adit**—A tunnel for carrying water.
- Anchor**—Piles driven in a channel, upon which to rest a superstructure.
- Aqueduct**—A water conduit for long distances.
- Artesian**—Self-flowing deep wells.
- Asbestine**—A system of underground piping used in subirrigation.
- Azarbes**—Spanish term for channel.
- Backsetting**—Replowing a furrow back into its original position; damming streams for irrigation by percolation.
- Basins**—Water spaces made around trees for irrigation.
- Bench Flume**—A wooden conduit laid upon benches or sills.
- Bench Mark**—A monument from which differences of level are measured.
- Bents**—Sections of framework or trellises used in flume work.
- Berne**—The inner slope of embankments, so graded as to prevent earth from sliding.
- Beton**—Concrete of lime, sand, and hydraulic cement.
- Billabong**—Australian term for a lake or lagoon.
- Border**—A system of ridges thrown up to hold water within prescribed limits.
- Breakwater**—A structure to protect works from the force of waves.
- Bulkhead**—The head flume of a ditch or canal; the gateway at the headworks.
- Canal**—A large irrigating ditch; the main watercourse.
- Canvas Dam**—A coarse fabric apron used as a check in laterals.

- Catchment**—Extent of country that may be utilized in drawing water to a certain point, as a reservoir; also catchment area.
- Check**—An impediment placed in a lateral to divert water out upon the land.
- Conduit**—An aqueduct for passing water; a tube or pipe.
- Contour**—The high level line describing the course of a canal.
- Crown Arch**—An arched plate serving as a keystone in a masonry curved dam.
- Cylinder**—An enlarged mechanism for a piston at the bottom of a pump in a well.
- Dam**—A barrier to confine the flow of a stream to raise its level; an embankment of a reservoir.
- Detritus**—Disintegrated material of any kind flowing in a ditch; silt or alluvial deposit.
- Dike**—An embankment for holding water.
- Ditch**—An artificial watercourse, one somewhat smaller than a canal.
- Ditching Machine**—An implement for excavating canals, etc.
- Diversion Dam**—A structure in a natural stream for diverting the water into a canal.
- Division Box**—A contrivance for dividing or apportioning water to consumers.
- Drop Box**—An arrangement in a canal for lowering or reducing the grade.
- Duty of Water**—Service required of water in supplying land; the tax to which water is put in irrigating.
- Evaporation**—The loss of water by vaporizing.
- Fellah**—An Egyptian laborer, cultivator or irrigator.
- Filament**—The center course of a current in a stream.
- Fill-Bank**—Material used in constructing embankments.
- Filtration**—Act of filtering, as water through soil.
- Flights**—A continuous series of lifting buckets or plates in a water elevator.
- Float**—An object thrown into a stream to calculate water velocity; a water-wheel paddle.
- Flume**—A structure or box for conducting water across depressions or uneven places.

- Fly-Off**—Evaporation of water as compared with run-off waters.
- Fore Bay**—That part of a canal where the water enters the headgate.
- Fountainhead**—Original source; a spring from which water flows.
- Grade**—The degree of inclination in a canal.
- Grade Level**—An instrument for determining the slope of a watercourse.
- Gradient**—Rate of variation in the grade of a ditch.
- Head**—The measure of stored up or gathered force ready to be used in irrigating; the height of a body of water in covering land, as by flooding.
- Head Bay**—See Fore Bay.
- Head Ditch**—A lateral running along the highest level of land to be irrigated.
- Headgate**—The up-stream gate of a canal; a water or flood-gate.
- Hydraulic Engineer**—One skilled in hydraulics and the construction of waterways.
- Hydraulic Ram**—An automatic device for raising water by its own power.
- Hydraulics**—The science of liquids, especially of water in motion.
- Hydrometric Sluice**—A certain kind of measuring box.
- Intake**—The point in a stream where a canal is taken out.
- Inundation**—Overflowing or covering land with water.
- Irrigant**—An irrigating ditch.
- Irrigation**—The process of watering agricultural lands by artificial means.
- Irrigator**—A cart for watering crops; one who irrigates.
- Lateral**—A side ditch; the small service line leading from a supply ditch or canal.
- Levee**—A border or embankment.
- Loess**—A deposit of fine clay loam or very fine sand; the sediment found in canals.
- Measuring Box**—A device set in ditches for apportioning water to consumers.

- Miner's Inch**—A unit of water measurement.
- Module**—A French device for measuring water.
- Mudfall**—The structure upon which rests the floor of a head-gate.
- Nilometer**—A gauge for measuring and recording the rise and fall of streams.
- Overfall**—The apron of a weir or dam.
- Penstock**—A pipe for supplying water ; a sluice or conduit for controlling the discharge of water.
- Percolation**—Filtration of water through the soil.
- Phreatic**—Underground, as the sources of wells ; phreatic waters.
- Pipe-Line**—A system of pipe or conduit for conveying water.
- Points**—Perforated pipes driven into the earth to secure water for pumps.
- Porosity**—Porous condition or possessing pores.
- Puddle**—To line, as canal banks, with clay to render water-tight ; preparing plants for transplanting.
- Reduction Box**—A device for decreasing the flow of a canal.
- Reservoir**—A basin for collecting and impounding water ; a storage lake or pond.
- Rill**—A small stream or delicate furrow.
- Riparian**—Pertaining to the banks of a river.
- Riprap**—Broken stone arranged in beds for protecting embankments.
- Run-Off**—Those waters which escape by natural courses on the earth's surface ; those waters which do not " fly-off." (2)
- Sakiyeh**—A rude water-wheel used in Egypt.
- Sand Gate**—An appliance for diverting sand from a canal.
- Second Foot**—A unit of water measure ; the discharge of one cubic foot a second.
- Seepage**—Oozing or percolation of water in soil ; also spelled seepage and sipage.
- Sewage**—The discharge from sewers ; waste water.
- Shadoof**—An Oriental device similar to a well-sweep.
- Sheet-Piling**—Thick planking driven as piles ; the sides of coffer-dams.
- Silt**—Detritus or floating matter in a ditch ; sediment.

- Siphon**—A bent pipe or tube, or even a box, for drawing water by atmospheric pressure; also syphon.
- Slope**—The grade of a ditch.
- Sluice**—An artificial channel for carrying water, with gates or valves.
- Spillway**—A waste weir or overflow.
- Standpipe**—An elevated tap for draining water from a main; a tower-like pipe at a reservoir into which water is pumped to give it a head.
- Storm Water**—That which falls in catchments during freshets.
- Strut**—A compression brace in a framework, as a truss.
- Subbing**—Water percolating near the surface and utilized in subirrigation.
- Subirrigation**—Watering land through pipes or channels below the surface.
- Subsidiary Canals**—Those that are secondary.
- Subsoiling**—To break up; to loosen the subsoil.
- Sump**—A shallow well or cistern.
- Tail-Race**—A wasteway from a canal.
- Tamp**—To pack with earth or other materials.
- Target**—An instrument used as a flag in directing surveyors.
- Terreplein**—The level fill or surface of earth made to connect with flumes, etc.
- Turnbeam**—A sort of treadmill device used in Oriental lands for raising water.
- Tympanum**—A large drum-wheel for raising water from a running stream.
- Underflow**—Currents of water below the earth's surface.
- Warping**—A method of retaining water by means of banks in overflows, as of tides along the ocean shore.
- Waste Gate**—An outlet for discharging water from a canal or storage pond.
- Water Register**—An instrument for measuring the flow of streams.
- Water Right**—A privilege; the right to the possession and use of water for irrigating.
- Water Witchery**—Art of discovering the underground presence of water by aid of divining rods.



- Weir**—A sort of dam placed in a stream for diverting or measuring water.
- Well**—A source of water-supply; a hollow tower in a reservoir
- Wind Rustler**—A crude apparatus serving the purpose of a windmill.
- Wind Dam**—A jetty or barrier built into a stream to deflect the current.
- Zanjero**—Spanish term for a ditch-walker or overseer.

# INDEX

	PAGE		PAGE
Advantages of Irrigation.....	13	Canal Construction—Cont'd.	
Fertilizing effects.....	15	Grades and slopes.....	66
Scientific principles.....	16	Headgates.....	70
Value of irrigated lands....	20	Laterals.....	81
<b>Alfalfa</b> .....	324	Laying out ditches.....	58
Disease of.....	346	Locating by surveys.....	59
Dodder.....	347	Ratio of slopes.....	68
Feeding value.....	345	Sand gates.....	74
Fertilizing elements.....	343	Surveying outfit.....	58
Harvesting.....	336	Tail races.....	75
History of.....	324	Waste gates.....	75
Hoove or blot.....	349	Cisterns, Capacity of.....	165
Irrigating.....	334	Dams.....	96
Nurse crops.....	331	Drouth, Loss by.....	458
Preparing land.....	328	Duty and Measurement of	
Rotation.....	348	Water.....	140
Soils for.....	327	Capacity of canals.....	148
Seed crop.....	340	Capacity of cisterns.....	165
Seeding.....	329	Capacity of windmills.....	164
Stacking.....	337	Cubic foot.....	141
Straw sandwich.....	350	Current meters.....	156
Turkestan variety.....	326	Divisors.....	149
Ventilating stacks.....	340	Evaporation.....	146
<b>Alkali—Chemical antidotes</b> ... 44		Floats.....	156
Composition of.....	86	Gauging rivers.....	155-165
Crops to neutralize.....	44	Hour system.....	146
Effect on plants.....	38	Irrigation head.....	143
Formation of salts.....	37	Miner's inch.....	142, 149
Remedies for.....	40	Modules or boxes.....	150
Waters carrying.....	39	Stokes measuring gate.....	159
<b>Asbestosine Sytem</b> .....	116	Under humid conditions....	466
<b>Canal Construction—Cement-</b>		Units of calculation.....	141
<b>ing</b> .....	80	Water registers.....	158
Curves and friction.....	68	Weirs.....	152, 163
Cost of.....	63-65	<b>Electricity—Cost of a plant</b> ... 454	
Ditching methods.....	61	Generating by turbines... 448-450	
Drop-head.....	72	Joint use.....	454
Dropping the grade.....	67	Induction motors.....	451
Evaporation and seepage... 79		Installing a plant.....	451
Form and capacity.....	65	Operating pumps.....	451

	PAGE		PAGE
Evaporation.....	79, 146	History of Irrigation—Cont'd.	
In winter.....	464	Early work of Menes.....	2
Flumes.....	123	First artesian wells.....	3
Arc stave.....	134	Great imperial well of China.....	4
Bracing.....	136	Hanging gardens of Babylon.....	6
Construction of.....	124	Hidden springs of Solomon.....	7
Crossing a river.....	132	Invention of the nilometer.....	2
Curves and grades.....	124	Irrigation among the Greeks.....	7
Iron structures.....	136	Mormon operations in Utah.....	11
Trestlework.....	130	Primeval operations in	
Siphons.....	136	America.....	10
Frost, Preventing.....	476	Roman aqueducts.....	9
Garden Irrigation.....	260	Shadoof or well-sweep.....	3
Asparagus.....	261	Spanish methods.....	9
Beans.....	263	Sunken island of Atlantis.....	1
Beets.....	266	Tympanum wheel.....	8
Cabbage.....	266	Humid Irrigation.....	455
Cantaloupes.....	268	Eastern duty of water.....	460
Carrots.....	267	Irrigating terraces.....	450
Cauliflower.....	267	Losses by drouth.....	458
Celery.....	268	Sources of supply.....	458
Cucumbers.....	265	Hydraulic Embankment.....	163
Horseradish.....	267	Rams.....	376
Lettuce.....	273	Induction Motors.....	467
Onions.....	269	Iron Pipes.....	111
Parsley.....	273	Irrigation in Humid Climates.....	465
Parsnips.....	267	Laterals.....	81
Peanuts.....	273	Law of Irrigation.....	473
Peas.....	268	Acquiring a right.....	479
Pieplant.....	273	Adjudication of priorities... ..	464
Pumpkins.....	270	Beneficial use.....	477
Radishes.....	266	Carrier's diversion.....	483
Rhubarb.....	274	Changing point of diver-	
Roses.....	275	sion.....	476
Salsify.....	267	Common law rules.....	474
Spinach.....	273	Defining channels.....	481
Sweet Corn.....	271	Intention of abandonment... ..	476
Tomatoes.....	263	Locus of application.....	476
Turnips.....	267	Proof of non-user.....	476
Watermelons.....	267	Rights as realty.....	475
Gasoline Engines.....	368	Rights in parole.....	464
Glossary of Terms.....	485	Rights of appropriation.....	474
Hardpan.....	265	Right of way.....	483
Headgates.....	70	Manures.....	84
History of Irrigation.....	1	Orchard Irrigation.....	277
Assyrian works.....	6	Apples.....	288

PAGE	PAGE
Orchard Irrigation—Cont'd.	Pumps—Continued.
Apricots..... 296	Water motors..... 380
Cherries..... 296	Quicksand, Pumping from.... 391
Condition in winter..... 467	Reservoirs..... 84
Cultivation..... 283	Bear valley works..... 92
Lemons and limes..... 300	Capacity of..... 363
Nuts..... 260	Cementing..... 100
Oranges..... 397	Construction of..... 89
Peaches..... 293	Cost and capacity..... 94
Pears..... 290	Damming a stream..... 96
Planting..... 280	For windmills..... 354
Plums..... 291	Gates and spillways..... 101
Preventing frost..... 470	Hydraulic embankment.... 108
Prunes..... 292	Laying out..... 88
Pruning..... 292	Location of..... 86
Quinces..... 296	Masonry work..... 92
Pipes for Irrigation Purposes. 109	Storage ponds..... 98
Asbestine system..... 116	Sweetwater dam..... 94
Capacity..... 164	Trouble from silt..... 105
Iron..... 111	Rights of Appropriation..... 480
Laminated..... 113	Sand Gates..... 74
Pressure of..... 110	Saturation in Winter..... 470
Riveted pipes..... 112	Seepage..... 79
Spiral..... 112	Open ditches..... 443
Steel..... 114	The Steam Irishman..... 445
Vitrified..... 114	Tiling..... 447
Plowsole..... 296	Silt..... 32
Pumps..... 369	In reservoirs..... 52, 105
Capacity of..... 369	Siphons..... 138
Centrifugals..... 374	Soils..... 22
Compressed air..... 365	Acids in..... 26
Cost of raising water..... 368	Adobe..... 24
Current wheels..... 363	Absorptive qualities..... 25
For windmills..... 370	Capillary action..... 31
Gasoline engines..... 363	Classification of..... 22
Hurdy-gurdy..... 381	Clay soils..... 23
Hydraulic rams..... 376	Color and texture..... 27
Irrigation cylinders..... 376	For alfalfa..... 327
Plunger pumps..... 369	Gravity..... 26
Propellers..... 375	Gumbo and loam..... 24
Pumping from quicksand... 391	Humus..... 25
Repairs on..... 387	Mechanical arrangement... 28
Rotary..... 371	Sand and silica..... 25
Rotary engines..... 384	Temperature..... 29
Turbine..... 381	Solids in Alkali..... 317
Vacuums..... 372	Storage Ponds..... 96

PAGE	PAGE		
Subirrigation.....	391	Water-supply—Continued.	
Subsoil Plow.....	297	Underflow, phreatic and ar-	
Tail Races.....	75	tesian.....	58
Vineyards and Small Fruits..	308	Water witchery.....	55
Best soils.....	308	Weirs.....	153-162
Blackberries.....	313	Windmills.....	352
Capers.....	316	Capacity of.....	363
Cranberries.....	314	Care of.....	361
Cultivation.....	305	Erecting towers.....	358
Currants.....	313	For pumping.....	362
Foreign grapes.....	309	Home-made kinds.....	366
Gooseberries.....	312	Jumbos.....	364
Irrigation.....	307	Merry-go-round.....	367
Vineyard.....	304	Repairs.....	367
Raspberries.....	310	Selecting.....	356
Strawberries.....	317	Steel towers.....	320
Winter protection.....	409	Various makes.....	358
Vitrified Pipe.....	114	Wind-power.....	361
Waste Gates.....	75	Wind rustlers.....	354
Water-supply.....	47	Winter Irrigation—Depth of	
Beneficial use of.....	477	saturation.....	459
Catchment area.....	511	Evaporation in winter.....	464
Evaporation and run-off....	48	Orchards in winter.....	467
Newsom system.....	54	Preventing frosts.....	470
Surface supply.....	50	Valuable experiment.....	465
Tunneling.....	58	Vineyard protection.....	469



# STANDARD BOOKS

.. PUBLISHED BY ..

## ORANGE JUDD COMPANY

NEW YORK  
52 & 54 Lafayette Place

CHICAGO  
Marquette Building

---

*BOOKS sent to all parts of the world for catalog price. Discounts for large quantities on application. Correspondence invited. Brief descriptive catalog free. Large illustrated catalog, six cents : : :*

---

### RECENT BOOKS BY THOMAS SHAW

Professor of Animal Husbandry at the University of Minnesota,  
formerly Professor of Agriculture at the Ontario Agricultural College.

#### **Animal Breeding**

The most complete and comprehensive work ever published on the subject of which it treats, and the first book of the kind ever given to the world which has systematized the subject of animal breeding. The striking originality in the treatment of the subject is no less conspicuous than the superb order and regular sequence of thought from the beginning to the end of the book. Illustrated. 5 x 8 inches, 13 full-page plates, about 400 pages. \$1.50.

#### **The Study of Breeds**

Origin, history, distribution, characteristics, adaptability, uses, and standards of excellence of all the pedigreed breeds of cattle, sheep, and swine in America. The accepted text-book in colleges, and the authority for farmers and breeders. 387 pages, 5 x 8 inches, 60 full-page plates. \$1.50.

#### **Forage Crops Other than Grasses**

How to cultivate, harvest, and use them. Indian corn, sorghum, clover, leguminous plants, crops of the brassica genus, the cereals, millet, field roots, etc. Intensely practical and reliable. 295 pages. Illustrated. 5 x 8 inches. \$1.00.

#### **Soiling Crops and the Silo**

The growing and feeding of all kinds of soiling crops, conditions to which they are adapted, their plan in the rotation, etc. Best methods of building the silo, filling it, and feeding ensilage. Illustrated. 5 x 8 inches, 378 pages. \$1.50.

## Fumigation Methods

By WILLIS G. JOHNSON. A timely up-to-date book on the practical application of the new methods for destroying insects with hydrocyanic acid gas and carbon bisulphid, the most powerful insecticides ever discovered. It is an indispensable book for farmers, fruit growers, nurserymen, gardeners, florists, millers, grain dealers, transportation companies, college and experiment station workers, etc. Illustrated. 313 pages. 5x7 inches. Cloth. \$1.00.

## Alfalfa

By F. D. COBURN. Its growth, uses and feeding value. The fact that alfalfa thrives in almost any soil; that without reseeding, it goes on yielding two, three, four and sometimes five cuttings annually for five, ten, or perhaps 100 years; and that either green or cured it is one of the most nutritious forage plants known, makes reliable information upon its production and uses of unusual interest. Such information is given in this volume for every part of America, by the highest authority. Illustrated. 164 pages, 5x7 inches. Cloth. 50 cents.

## Coburn's Swine Husbandry

By F. D. COBURN. New, revised and enlarged edition. The breeding, rearing and management of swine, and the prevention and treatment of their diseases. It is the fullest and freshest compendium relating to swine breeding yet offered. Illustrated. 312 pages. 5x7 inches. Cloth. \$1.50.

## Feeds and Feeding

By W. A. HENRY. This handbook for students and stockmen constitutes a compendium of practical and useful knowledge on plant growth and animal nutrition, feeding stuffs, feeding animals and every detail pertaining to this important subject. It is thorough, accurate and reliable, and is the most valuable contribution to live stock literature in many years. All the latest and best information is clearly and systematically presented, making the work indispensable to every owner of live stock. 658 pages. 6x9 inches. Cloth. \$2.00.

## Fruit, Harvesting, Storing, Marketing

By F. A. WAUGH. A practical guide to the picking, storing, shipping and marketing of fruit. The principal subjects covered are the fruit market, fruit picking, sorting and packing, the fruit storage, evaporating, canning, statistics of the fruit trade, fruit package laws, commission dealers and dealing, cold storage, etc., etc. No progressive fruit grower can afford to be without this most valuable book. Illustrated. 232 pages. 5x7 inches. Cloth. \$1.00.

## American Grape Growing and Wine Making

By GEORGE HUSMANN, of California. New and enlarged edition. With contributions from well-known grape growers, giving wide range of experience. The author of this book is a recognized authority on the subject. Illustrated. 269 pages. 5x7 inches. Cloth. \$1.50.

## The American Sugar Industry

By HERBERT MYRICK. A practical manual on the production of Sugar Beets and Sugar Cane, and on the manufacture of Sugar therefrom. A handbook for the farmer, manufacturer, statesman, or student. This book is the only complete up-to-date epitome of this new and promising industry. It covers just the points that every one interested wants to know about. It illustrates and describes the newest model sugar mills. It gives the results of the latest experience in promoting and operating sugar factories. It shows just how to establish the industry in any given locality. Illustrated. 10x7 inches. 240 pages, cloth. \$1.50.





UNIVERSITY OF CALIFORNIA LIBRARY

THIS BOOK IS DUE ON THE LAST DATE  
STAMPED BELOW

JUL 27 1914

APR 10 1915

DEC 13 1916

MAR 12 1921

MAR 29 1923

APR 16 1927

DEC 18 1967

RECEIVED

DEC 10 '67 - 10 A

LOAN DEPT.

MAR 12 1968 53

RECEIVED

UC INTERLIBRARY LOAN

MAR 2 '68 - 5 PM

OCT 8 1984

OCT 11 1980

UNIV. OF CALIF., BERK

MAR 28 1966 33

JUN 4 '66 28 ROD

30m-6,'14

4/65

YB 53328

*his*

*TC 05  
W  
140*

*Wilcox*

101944

*7 -*

025 05 12 1975

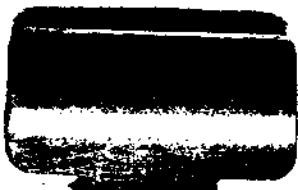

Copy

UNIVERSITY OF CALIFORNIA LIBRARY

THIS BOOK IS DUE ON THE LAST DATE  
STAMPED BELOW

JUL 27 1914

APR 10 1915

DEC 13 1916

MAR 12 1921

MAR 29 1923

APR 16 1927

DEC 18 1967

RECEIVED

DEC 10 '67 - 10 A

LOAN DEPT.

MAR 12 1968 53

RECEIVED

UC INTERLIBRARY LOAN  
MAR 2 '68 - 5 PM

OCT 8 1984

OCT 11 1930

UNIV. OF CALIF., BERK

MAR 28 1966 33

JUN 4 '66 28 RCD

30m-6, '14

6/65