

**AT** MICROFICHE  
REFERENCE  
LIBRARY

A project of Volunteers in Asia

Surface Irrigation, FAO Agricultural Development  
Paper No. 95

by: L. J. Booher

Published by:

Food and Agriculture Organization of the  
United Nations

Via delle Terme di Caracalla

00100 Rome

Italy

Available from:

UNIPUB

345 Park Avenue South

New York, NY 10021 USA

Reproduced by permission of the Food and  
Agriculture Organization of the United Nations.

Reproduction of this microfiche document in any  
form is subject to the same restrictions as those  
of the original document.

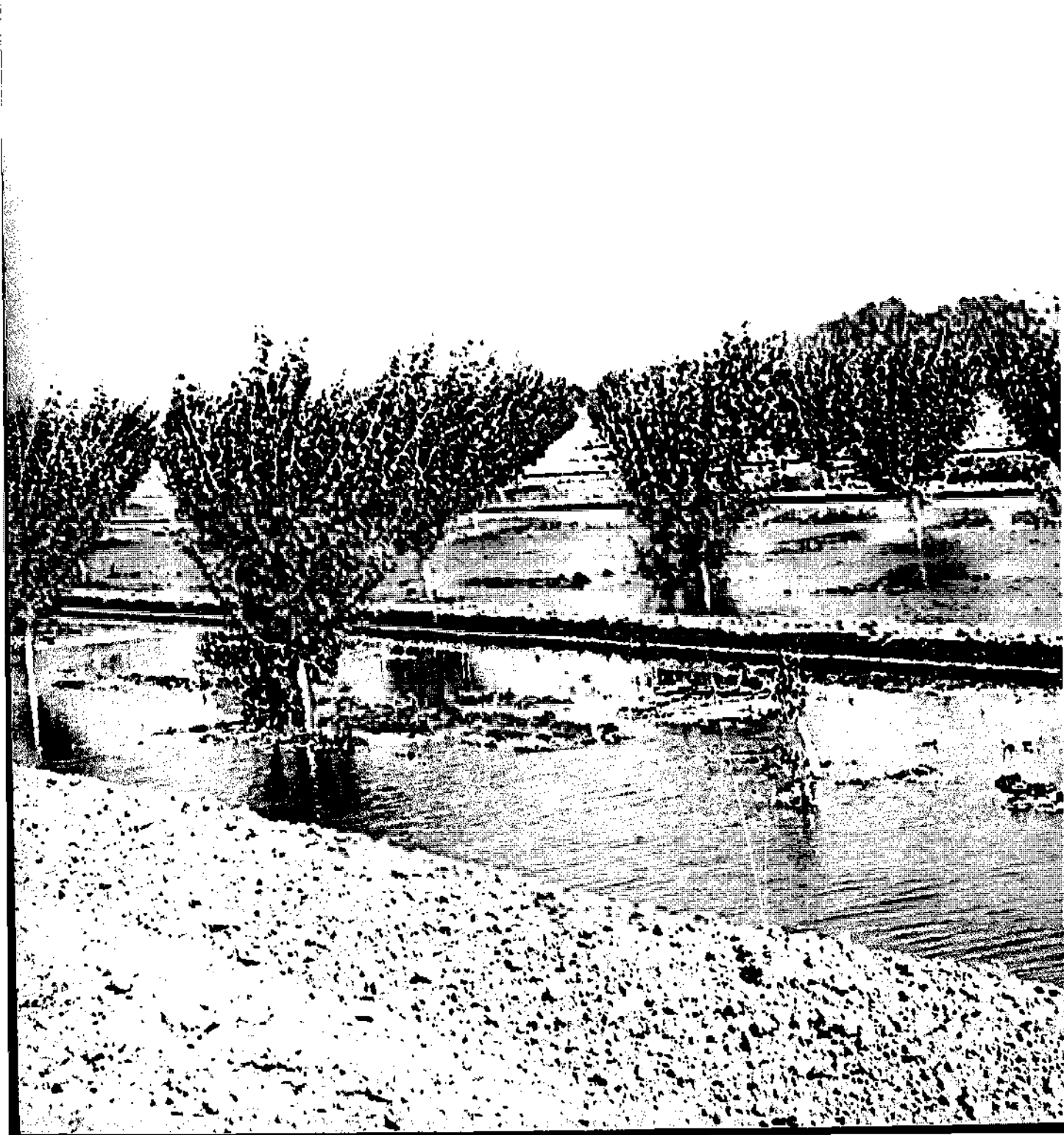

---

Although only 15 to 20 percent of the world's crop land is under irrigation, the production from irrigated land amounts to as much as 30 to 40 percent of total world agricultural output. The needed increase in food production will therefore depend to an appreciable extent on enlarging the area under irrigation and improving existing systems.

Surface systems of irrigation are the most widely practised. This publication is a comprehensive survey of all the several existing surface systems. Their combination in one volume makes possible the study and comparison of the various parameters of soil, water supply, topography and cropping possibilities of these systems, as well as their technical requirements, practical application and costs — knowledge of great value in the selection and planning of an irrigation scheme. The book is particularly recommended to students, planners and designers of farm irrigation systems.

---

## SURFACE IRRIGATION

**This is the last major contribution of L.J. Booher to the field of agricultural water management. Mr. Booher, who was recognized as a world authority on the subject, died on 22 November 1972. His absence will create a void in the discipline which will not be easily filled.**

**This is the last major contribution of L.J. Booher to the field of agricultural water management. Mr. Booher, who was recognized as a world authority on the subject, died on 22 November 1972. His absence will create a void in the discipline which will not be easily filled.**

# **SURFACE IRRIGATION**

*by*

**L.J. BOOHER**

**Consultant**

**Land and Water Development Division, FAO  
Extension Irrigationist  
University of California, Davis**

*First printing 1974*  
*Second printing 1976*

The copyright in this book is vested in the Food and Agriculture Organization of the United Nations. The book may not be reproduced, in whole or in part, by any method or process, without written permission from the copyright holder. Applications for such permission, with a statement of the purpose and extent of the reproduction desired, should be addressed to the Director, Publications Division, Food and Agriculture Organization of the United Nations, Via delle Terme di Caracalla, Rome, Italy.

© FAO 1974

---

*Printed in Italy*



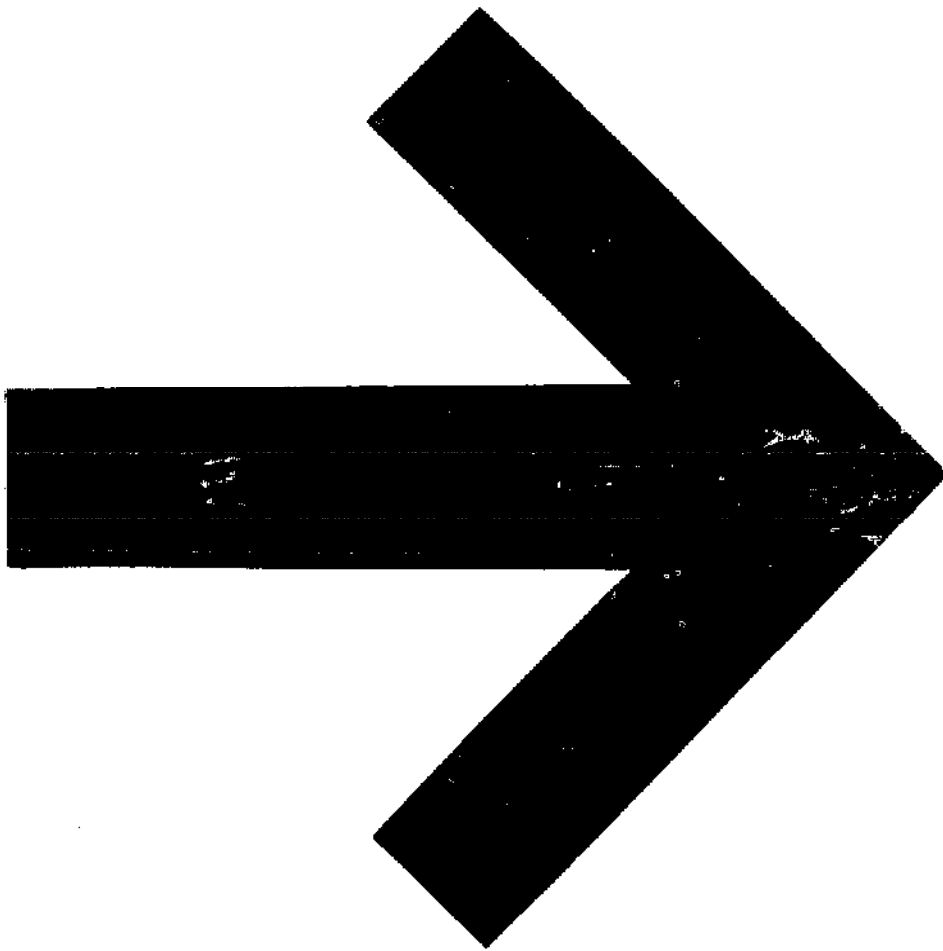

## CONTENTS

<b>Introduction</b> .....	1
<b>1. Water supply</b> .....	3
Methods of water delivery .....	3
Water requirements .....	4
Small regulating reservoirs .....	7
<b>2. Soils</b> .....	10
Infiltration rates .....	10
Water-holding capacities of soils .....	12
<b>3. Land preparation</b> .....	16
Soil survey .....	16
Engineering .....	17
Equipment .....	22
<b>4. Open distribution systems</b> .....	31
Unlined ditches .....	32
Lined ditches .....	34
Flumes .....	39
Design of open distribution systems .....	41
Control structures for ditches .....	44
Canal outlets .....	44
Division boxes .....	46
Checks .....	46
Drops .....	49
Other structures .....	50
Inverted siphons .....	51
Outlets .....	52

<b>5. Piped distribution systems</b> .....	<b>53</b>
Types of pipe .....	53
Costs .....	56
Types of pipeline systems .....	57
Friction losses .....	59
Control structures for pipelines .....	64
Inlet gates .....	64
Flow-control gates and valves .....	65
Air vents .....	66
Outlets .....	67
Hydrants .....	71
Gated pipes .....	74
<b>6. Selecting the method of irrigation to use</b> .....	<b>77</b>
<b>7. Basin irrigation</b> .....	<b>80</b>
Relation of soil type to flow of water and area in each basin .....	81
Slope in relation to size and shape of basin .....	85
Forming the levees .....	86
Filling the basins with water .....	89
<b>8. Border irrigation</b> .....	<b>93</b>
Soils .....	93
Slope .....	95
Width of border-strips .....	97
Length of border-strips .....	97
Stream size .....	98
Design criteria .....	99
Forming the levees .....	103
Controlling the water .....	104
<b>9. Wild flooding</b> .....	<b>108</b>
Ditches .....	109
Outlets .....	110
Water management .....	110

<b>Furrow irrigation</b> .....	111
Furrow and bed shapes .....	111
Furrow spacing .....	114
Furrow slopes .....	115
Contour furrows .....	117
Benched furrows .....	117
Zigzag furrows .....	120
Furrow lengths .....	121
Flow rates .....	123
Regulating the flow of water into furrows .....	126
Average depth of water applied .....	130
<b>11. Corrugation irrigation</b> .....	133
Soils .....	133
Land preparation .....	134
Slope .....	134
Length of runs .....	135
Forming the corrugations .....	135
Flow of water in corrugations .....	137
<b>12. Drip irrigation</b> .....	140
Requirements of drip systems .....	140
Uses of drip irrigation .....	141
Dangers from salt accumulation in the soil .....	143
Types of emitters .....	143
Performance of emitters .....	145
Plugging of emitters .....	149
Supply lines .....	150
Care in using plastic materials .....	152
<b>Conversion factors</b> .....	154
<b>References</b> .....	157

## LIST OF ILLUSTRATIONS

1. Distributor and Neyrpic automatic gate .....	5
2. Soil moisture characteristics .....	13
3. Topographic map for land grading .....	18
4. Profiles of average slopes .....	19
5. Scarifier, or subsoiler, mounted on wheel assembly .....	23
6. Chisels to loosen soil or break up shallow compacted layers..	23
7A-7B. Buck scraper and rake .....	24
8. Buck scraper drawn by team of horses .....	25
9. Small hydraulic scraper operated with a 45-to-50-horsepower wheel tractor .....	25
10. Small two-wheel scraper used with four-wheel tractor ....	27
11. Rotary-type earth scraper operated with 40-to-60-horsepower wheel tractor .....	27
12. Elevating scraper with two-wheel tractor for land grading ..	27
13. Four-wheel rubber-tired tractor and two-wheel bucket scraper pushed by crawler tractor with blade during loading operation	28
14. Crawler tractor and four-wheel bucket scraper for land grading	28
15. Wooden float .....	29
16. Bottomless scraper for final smoothing .....	30
17. Another type of bottomless scraper .....	30
18. Earthen ditch distributing irrigation water .....	33
19. Homemade drag-type ditcher .....	33

20.	V-ditcher mounted on tool bar of crawler tractor .....	34
21.	Concrete lining in elevated ditch .....	35
22.	Precast concrete blocks lining field ditch .....	38
23.	Precast concrete flumes mounted on pedestals .....	40
24.	Cross-section of canal .....	43
25.	Control gate made of precast concrete blocks, in unlined canal .....	45
26.	Underflow control gates set in concrete headwall .....	45
27.	Constant-upstream-level Neyrpic automatic gate .....	47
28.	Wooden checks in earthen ditch .....	47
29.	Concrete check gate in earthen ditch .....	48
30.	Concrete check dam in earthen ditch .....	48
31.	Portable canvas dam in earthen ditch .....	49
32.	Pipe drop structure for field ditches .....	50
33.	Cross-section of inverted siphon placed under roadway ...	51
34.	Workman installing precast concrete pipe in trench .....	54
35.	Cast-in-place concrete pipeline being constructed in trench ..	55
36.	Profile of overflow stands with baffles, used with open pipeline system .....	58
37.	Automatic float-controlled valve in pipe stand .....	58
38.	Slide gate in standpipe to regulate flow in pipeline .....	66
39.	Line-gate valve for concrete pipeline .....	66
40.	Cross-section of concrete supply pipe and riser with alfalfa valve attached .....	70
41.	Orchard valve and low-pressure open hydrant with slide gates for controlling flow to furrows .....	70
42.	Water from buried concrete pipeline being released through capped riser outlets .....	73
43.	Portable metal hydrants .....	73

44. Aluminium pipe with slide gates .....	75
45. Aerial view of contour basins .....	77
46. Small basins irrigating young date palms .....	82
47. View of small basins irrigating crops grown under date palms .....	82
48. Citrus trees irrigated with basins .....	83
49. Levees constructed on lines of equal elevation to form contour basins .....	85
50. Large contour basins and rectangular basins irrigating rice..	87
51. Earth levee between rice paddies .....	88
52. Wooden A-frame ridger for forming levees .....	89
53. Large V-diker .....	90
54. Precast concrete units forming levees .....	90
55. Control gate in place in rice levee .....	91
56. Wooden gate with flashboards .....	92
57. Water being released into border-strips .....	94
58. Deciduous orchard irrigated by border-strips .....	94
59. Metal A-frame ridger and shaper for forming flat-sided levees	104
60. Drag float smoothing land surface between levees .....	104
61. Weir-type outlet with flashboards in concrete-lined canal ..	105
62. Circular gate on pipe outlet from concrete-lined canal ....	105
63. Grade ditches across field to be irrigated by wild flooding ..	109
64. Furrows irrigating tomato plants on raised beds .....	113
65. Broad furrows in orchard .....	113
66. Young melon plants on sloped beds to control salts and receive more sunlight .....	114
67. Furrows placed on diagonal of field to reduce slope .....	116
68. Wooden flume conveying water down slope .....	118
69. Contour furrows irrigated from wooden flume .....	118

70A-70B. Benched terraces planted to citrus trees irrigated with furrows .....	119
71. Zigzag furrows irrigating orchard .....	120
72A-72B. Patterns of zigzag furrows for moderate and fairly flat slopes .....	121
73. Garlic growing on raised beds irrigated by furrows enclosed in basins .....	123
74. Tailwater pickup ditch and low-lift pump for return-water system .....	127
75. Plan for return-flow system .....	127
76. Water from buried concrete pipeline being released through alfalfa valve into temporary earthen ditch .....	128
77. Auxiliary ponding area used with furrow irrigation .....	130
78. Wooden corrugator with four runners .....	135
79. Corrugations for irrigating pasture on flat land, and corrugator	137
80. Small tubing emitter for drip irrigation .....	144
81. Double-wall polyethylene tubing with small perforations irrigating staked tomatoes .....	145
82. Self-flushing plastic emitter connected to polyethylene tubing	147
83. Sand filters removing organic matter from water used in drip irrigation .....	149



## LIST OF TABLES

1. Conversion of daily consumptive use rates to equivalent continuous flow rates per unit area .....	6
2. Capacities required to store water for various periods, delivered at different flow rates .....	8
3. Range of readily available soil moisture for different soil types .....	14
4. Suggested maximum flow velocities, coefficients of roughness and side slopes, for lined and unlined ditches and flumes ...	37
5. Friction loss in concrete pipe .....	60
6. Friction loss in asbestos-cement pipe .....	61
7. Friction loss in welded steel pipe .....	62
8. Friction loss in low-head rigid polyvinyl chloride pipe .....	63
9. Head loss through alfalfa valves .....	68
10. Capacities of orchard valves .....	72
11. Surface irrigation methods and conditions of use .....	78
12. Suggested basin areas for different soil types and rates of water flow .....	84
13. Suggested standards for the design of border-strips for shallow-rooted crops .....	101
14. Suggested standards for the design of border-strips for deep-rooted crops .....	102
15. Flow through pipe turnouts and siphons used in border irrigation .....	106
16. Suggested maximum lengths of cultivated furrows for different soils, slopes, and depths of water to be applied .....	124

17. Relation of maximum nonerosive flow rates to critical slopes in furrows .....	125
18. Flow through small siphons and spiles .....	129
19. Length and spacing of corrugations .....	136
20. Maximum nonerosive flow rates that should be used in corrugations on various slopes .....	138
21. Continuous flows required to satisfy peak water requirements of mature plants at various spacings .....	142
22. Flows from polyethylene tubing emitters of 0.96-millimetre (0.038-inch) diameter .....	146
23. Surface areas flooded by drip emitters .....	148
24. Friction losses in plastic tubing .....	151

## INTRODUCTION

Surface irrigation is accomplished by impounding water on the soil surface or causing the water to flow over the surface. In either case some means must be provided for controlling the water, so that the proper depth enters the soil to supply the water needs of the crop, and so that the water can be distributed uniformly to all parts of the field. An efficient irrigation system will also provide means of avoiding excess water losses by deep percolation or by surface runoff at the ends of the fields. The two criteria for good surface irrigation, therefore, are *adequacy* and *efficiency*.

All surface irrigation methods have certain basic principles in common. Water is turned on to the field at the high point of the land and flows to lower elevations, with flow diminishing as water infiltrates the soil while moving down the slope. One might assume that uniformity of water distribution would be impossible to obtain under these conditions because more water would inevitably enter the soil at the upper end of the irrigated area than at the lower end. While there is always this tendency, it is possible to minimize nonuniformity and obtain efficiencies of water distribution with surface irrigation which are comparable with other methods. This is accomplished by dividing the area to be irrigated into units of the appropriate size and shape, and regulating the size of stream turned into the units according to type of soil, slope, and depth of rooting of the crop. However, to obtain this uniformity with soils having very high infiltration rates, the area irrigated as a unit may need to be so small or the flow of water required may be so large that surface irrigation becomes impractical, and sprinkler irrigation should then be considered. There are other conditions in which sprinkler irrigation might be preferable to surface irrigation methods (FAO, 1960, 1968).

It is not always possible to express in quantitative units all the factors influencing uniformity of water distribution. Some are variables — such as the infiltration rate of water into the soil, the depths of rooting of different crops, the enlarging root system of annual crops, and the vagaries of the weather. Other factors remain fairly constant — the slope of the land, the soil texture and structure, the water-holding properties of the

soil, and the rates of water movement within the soil. It is necessary to use judgement based on the best information available concerning these factors in planning the layout of the irrigation system.

The irrigator must recognize that he may have to vary certain practices over which he has control in order to obtain the best use of the irrigation water. These practices might include the division of the irrigated area into units, the size of stream used for irrigating each unit, and the length of time the water is allowed to flow on to each unit area.

Two other requirements of prime importance in utilizing surface irrigation methods are distribution systems which are constructed to provide adequate control of the water, and land preparation that permits uniform distribution of water and allows excess water to drain off.

## I. WATER SUPPLY

The source of the water, particularly with regard to the size of stream available, will influence the method of irrigation which can be used. It may be a large canal supplying water to a number of users, a privately owned ditch diverting water from a stream or a small reservoir, or an artesian or pumped well.

Water supplies obtained by diverting the natural flow of a stream will normally fluctuate in quantity during the irrigation season, and vary from year to year. Supplies will be more uniform when they are obtained from releases of water stored in a large surface reservoir, or are pumped from a groundwater reservoir.

The amount of water available will influence the type of crops that can be grown, and determine the area that can be irrigated. The method of irrigation must be efficiently designed for the highest possible use of the water where the supply is limited.

Also important in determining the irrigation method is the cost of water, which will depend on the investment in irrigation works and operation and maintenance costs. It is generally accepted that the higher the cost the greater will be the care taken to see that water is used efficiently.

### **Methods of water delivery**

In most irrigated areas a common water supply is shared by a number of users. Division of the water, in such cases, may be based on established priorities, or users may share in the available supply according to the area irrigated by each. The total flow is sometimes divided among the users, with each obtaining a share as a continuous flow throughout the season on the basis of his entitlement. A more common practice is to rotate the use of the full stream. The time each user is allotted in the rotation is usually based on his irrigated area and use is limited so that everyone will have an opportunity to share in the water at reasonable intervals.

The sharing of water on a rotational basis often leads to wasteful use. Users will normally take their full share at each turn, irrespective of the water needs of their crops. In some areas where supplies are limited, a water users' organization will make an apportionment at the beginning of the season of a given volume of water to each unit of irrigated area. This apportionment is based on an estimate of the total seasonal water supply that will be available and the total area to be irrigated. Water deliveries are measured, and each user is limited to his seasonal allotment. This encourages efficient use of water.

Another method, which is used in more advanced irrigation projects, is delivery of water on request. This is commonly referred to as the delivery-on-demand system. It requires the maintenance of a flow of water in the entire canal system throughout the irrigation season. To avoid waste the flow must be regulated at the source by a reservoir or some other means of control. Where the canals are equipped with automatic gates (Figure 1) for regulating the depth of water, users can take water when it is needed. Where such automatic controls are not installed users must request delivery of water beforehand, and the flow entering the canals is regulated to fulfil the orders received. This means that request must specify quantity, period, and starting date. A leeway of from 24 to 48 hours is generally allowed between request and delivery.

### **Water requirements**

The amount of water used in producing a crop is commonly referred to as "consumptive use" or "evapotranspiration." It includes the water transpired by the leaves of the plants and evaporated from the wet soil. Part of the consumptive use requirement may be satisfied by rainfall during the growing season, or precipitation prior to planting which is retained in the soil and can be used later by the crop. Rainfall that runs off the surface or penetrates below the depth of rooting of the crop cannot be used. Only that retained within the root zone is considered as "effective rainfall." The amount of water needed in addition to effective rainfall to satisfy the consumptive use requirement of the crop is referred to as the consumptive use of applied water. This is the amount that must be supplied by irrigation.

Consumptive use can be expressed as depth of water per unit of time, such as millimetres per season or inches per day. To compute the total volume of water needed, the seasonal water requirement is multiplied by the area to be irrigated. The volume units used most commonly are cubic metres, acre-inches, or acre-feet.



FIGURE 1. Distributor, with Neyrpic automatic gate downstream in the main canal to regulate water depth.

The consumptive use of water will vary with the type of crop, the season when it is grown, and the climatic conditions existing at the various stages of plant growth. The seasonal consumptive use values may vary from as little as 250 millimetres for short-season crops grown in cool humid areas, to 1 800 millimetres or more for long-season crops grown in hot arid climates.<sup>1</sup> Estimates of water needs for various crops can usually be obtained from irrigation research stations located in the region where the crops are to be grown.

The rate of consumptive use during the period of peak water use generally determines the size of stream that should be available for irrigating the crop. The rate of peak consumptive use may vary from 2.5 to 6 millimetres per day in humid areas, to 6 to 9 millimetres per day in arid areas. Rates of consumptive use can be converted to equivalent rates of water flow per unit

---

<sup>1</sup> For readers not familiar with the metric measurements used in this publication, a list of conversions to British and United States units of measure is given on page 157. The tables give data in both metric and British or United States units, and the more complicated metric measures in the text, such as rates of flow, are followed by the British or United States measure in brackets.

area. Table 1 gives the equivalent continuous flow rates (24 hours a day) per unit area for various daily consumptive use rates. If the water is used for irrigation only part of the day, the rate of flow must be increased accordingly.

The quality of the water must always be taken into consideration in planning an irrigation system. It may limit the method of irrigation which can be used. Some soils must be leached by overirrigation to maintain a safe salt balance in the soil. The factors governing the use of waters of various qualities are discussed more fully in FAO Irrigation and Drainage Paper No. 7 (1971g), and in FAO/Unesco *Irrigation, drainage and salinity: an international source book*.

In addition to satisfying the consumptive use requirement of the crop, irrigation water must be supplied to take care of such losses as surface run-off or deep percolation from the field. Water will also be lost through seepage from field ditches, leaks from gates, evaporation from water surfaces, transpiration by ditch-bank weeds, and so on. Where soil salinity is a factor, additional water will be needed for leaching excess salts from the soil. Leaching requirements, however, can usually be taken care of

TABLE 1. - CONVERSION OF DAILY CONSUMPTIVE USE RATES TO EQUIVALENT CONTINUOUS FLOW RATES PER UNIT AREA

Consumptive use of water by crop		Equivalent continuous flow rates			
		Per hectare		Per acre	
<i>Millimetres per day</i>	<i>Inches per day</i>	<i>Litres per second</i>	<i>Cubic metres per day</i>	<i>Cubic feet per second</i>	<i>U.S. gallons per minute<sup>1</sup></i>
2	0.08	0.23	20	0.0033	1.5
3	0.12	0.35	30	0.0050	2.2
4	0.16	0.46	40	0.0067	3.0
5	0.20	0.58	50	0.0083	3.7
6	0.24	0.69	60	0.0100	4.5
7	0.28	0.81	70	0.0117	5.2
8	0.32	0.92	80	0.0133	6.0
9	0.36	1.04	90	0.0150	6.7
10	0.40	1.15	100	0.0167	7.5

<sup>1</sup> To convert to imperial gallons per minute, multiply values by 0.833.



during the off-season and generally do not need to be included in determining the peak water requirements. They do need to be included in determining the seasonal water requirement.

Irrigation efficiencies can be based on the amount of water applied to a field or to the entire irrigation system, taking into account losses occurring in the distribution system. Although the following equation does not take into consideration the adequacy of irrigation, it is commonly used to express field irrigation efficiencies:

$$\text{Field irrigation efficiency} = \frac{\text{water applied} - \text{losses}}{\text{water applied}}$$

The amount of irrigation water required for a field can be computed from the equation:

$$\text{Field irrigation water requirement} = \frac{\text{consumptive use} - \text{effective rainfall}}{\text{field irrigation efficiency}}$$

The following example is used to illustrate how the size of the stream required can be computed. Assume that a 15-hectare area is being irrigated 12 hours each day in a region with no effective rainfall, with peak consumptive use 5 millimetres per day, and field irrigation efficiency 0.50 (50 percent). From Table 1, the continuous flow requirement is shown to be 0.58 litre per second per hectare, but because water is used only 12 hours each day this must be multiplied by 2:

$$\frac{15 \times 0.58 \times 2}{0.50} = 34.8 \text{ litres per second}$$

Some types of irrigation, such as the border and basin methods, have minimum flow rates to enable the water to be distributed uniformly and applied at the desired depth, and for irrigation labour to be used efficiently. These minimum flow requirements are discussed in more detail in the sections dealing with specific irrigation methods.

### **Small regulating reservoirs**

A small stream which flows continuously can sometimes be stored in a small reservoir for a short period in order to provide a larger flow part of

the time. For example, a continuous flow of 20 litres per second could be stored in a reservoir and released as a flow of 60 litres per second for eight hours each day. Table 2 gives the reservoir capacities needed for

TABLE 2. - CAPACITIES REQUIRED TO STORE WATER FOR VARIOUS PERIODS, DELIVERED AT DIFFERENT FLOW RATES

A. Capacities in cubic metres, eight flow rates

Flow rate	Hours of storage				
	8	12	16	20	24
<i>Litres per second</i>	..... <i>Cubic metres</i> .....				
2	58	86	115	144	173
5	144	216	288	360	432
10	288	432	576	720	864
15	432	648	864	1 080	1 296
20	576	864	1 152	1 440	1 728
25	720	1 080	1 440	1 800	2 160
30	864	1 296	1 728	2 160	2 592
35	1 008	1 512	2 016	2 520	3 024

B. Capacities in acre-feet,<sup>1</sup> six flow rates

Flow rates		Hours of storage				
		8	12	16	20	24
<i>Cubic feet per second</i>	<i>U.S. gallons per minute</i>	..... <i>Acre-feet</i> .....				
0.2	90	0.13	0.20	0.27	0.33	0.40
0.4	180	0.27	0.40	0.53	0.67	0.80
0.6	270	0.40	0.60	0.80	1.00	1.20
0.8	360	0.53	0.80	1.07	1.33	1.60
1.0	450	0.67	1.00	1.14	1.66	2.00
1.2	540	0.80	1.20	1.60	2.00	2.40

<sup>1</sup> 1 acre-foot = 43 560 cubic feet = 1 233.5 cubic metres.

storing various flow rates for different periods. Such "overnight" storage reservoirs are commonly used for temporary storage of the discharge from well pumps, the flow from springs, or water delivered from canals on a continuous flow basis. These permit irrigation during daylight only, reducing the hours of irrigating time and allowing a more efficient use of the water.

## 2. SOILS

The two soil characteristics of most concern in the selection, design and use of surface irrigation systems are the rate at which water will enter the soil (infiltration rate) and the amount of water that can be retained in the soil for use by the crop (water-holding capacity). Properties such as soil-profile conditions, salinity, texture, structure, capillary conductivity and depth to water table must also be taken into account in the management of irrigation water.

### **Infiltration rates**

The rate at which water enters the soil determines the length of time it must be held on the surface to allow it to penetrate to the desired depth. Infiltration rates are expressed in depths of water per unit of time, such as centimetres or inches per hour.

Infiltration rates are closely related to the extent of large, interconnected pore spaces in the soil. Coarse sands and soils with well-aggregated soil particles usually have many large pores (and higher infiltration rates) than dispersed clays or soils, which have had their pore spaces reduced in size by compaction or a breakdown of soil aggregates.

Many soils are not uniform in depth. Changes in texture or structure within the soil profile will affect the infiltration rate. The effects of non-uniform profile conditions on the movement of water in the soil have been discussed by Doneen (FAO, 1971f) in considerable detail.

Soil changes affecting infiltration rates may also occur within a small area. This is particularly true with alluvial soils, where strips of fine-textured and coarse-textured soils may be found adjacent to each other. Since infiltration rates may thus vary greatly within short distances, these differences must be taken into consideration in the layout of the irrigation system. The area irrigated as one unit should, wherever possible, be confined to soils with nearly uniform infiltration rates.

The infiltration rate of any particular soil will vary with the amount of

moisture it holds at irrigation and with the tillage practices used prior to irrigation. Soils which have been recently ploughed will have a higher initial infiltration rate than those which have been settled by previous irrigations. This difference, however, generally disappears after water has been applied for about 30 minutes. Furrows in which wheel tractors have travelled will have slower infiltration than the other intermediate furrows.

In most soils, the infiltration rate decreases with the length of time that water is applied. It is normally relatively high at first, and gradually decreases to a nearly uniform rate. This condition, when changes in infiltration rates are slow, is sometimes referred to as the basic intake rate. An exception to this general rule occurs with some soils with a high organic matter content which repel water when they are dry. When particles of these soils become wet the infiltration rate will gradually increase. They are referred to as hydrophobic soils.

A number of different methods of measuring infiltration rates are used. For worthwhile results the infiltration of the irrigation system used in the area should be measured.

One type of measurement used with furrow irrigation is the inflow-outflow method, described by Shockley *et al.* (1959). The flow is measured at two points along the furrow. The difference in flow is the amount of water infiltrating the soil and this determines the infiltration rate of the area between the two points. Measurements must be made after infiltration stabilizes in the range of the basic intake rate. Thus, infiltration during the initial period of irrigation cannot be measured by this method. The furrow infiltrometer developed by Bondurant (1957) measures infiltration throughout an irrigation by ponding water in a very short length of the furrow.

Infiltration rates for irrigation by flooding are usually measured by ponding water on the surface of the soil and measuring the rate of drop in the water level or the rate of inflow that must be supplied to maintain a uniform depth of water. Water losses include evaporation as well as seepage. With porous soils the evaporation loss is minor, but on some tight soils the entire loss may be accounted for by evaporation. The reliability of such measurements is related to the size of the ponded area and to the number of replications of the measurements. Basins 3 to 5 metres square surrounded by levees are sometimes used, or metal cylinders, both single- and double-ring, are driven into the soil to pond the water, as described by Burgy and Luthin (1956) and Haise *et al.* (1956). It is not possible to determine the initial infiltration rates occurring during the filling period when using ponding methods. These rates can be estimated by measuring the total volume of water required to fill the ponds in relation to the volume of water ponded above the soil surface at the time the filling is completed.

The infiltration rates of different soils cover a wide range of values. Basic hourly intake rates for some coarse sands may be as high as 25 centimetres, for loam soils from 1 to 10 centimetres, and for clay soils from 0.1 to 2.5 centimetres. Clay soils which develop wide cracks on drying may initially have high water entry rates through the cracks, but as these close on wetting the infiltration rate may drop rapidly to negligible values.

The flow of water required and the area irrigated as one unit must be adjusted in accordance with the infiltration rate of the soil. A high infiltration rate requires a large stream and/or a small area. With low rates a much larger area can be irrigated as a unit, using a smaller flow of water.

Because infiltration rates are so variable it is difficult to derive equations which can be universally used for designing the layout of surface irrigation systems. Many research workers (Bishop, 1961; Christiansen *et al.*, 1959; Criddle *et al.*, 1956; Davis, 1961; Davis and Fry, 1963; Hall, 1956; Lewis, 1937; Lewis and Milne, 1938; Smerdon and Hohn, 1961; Wilke and Smerdon, 1965) have developed methods which are helpful in analysing uniformity of water distribution where the factors governing the flow of water over the soil surface and the infiltration rate of water into the soil are known. The application of these methods requires a prior evaluation of the parameters which must be used to solve specific irrigation problems. There is no substitute, therefore, for conducting field tests before establishing design criteria. In areas where irrigation has been widely practised, certain general rules have been developed which can be used as guides. The broad variation in these rules developed in different regions points to the need for caution in applying them to other areas. Certain of these general criteria are referred to in the descriptions of different irrigation methods. They are offered as aids to planning, not as final solutions.

### **Water-holding capacities of soils**

The depth of water that must be applied during an irrigation is related to the amount of usable water that can be retained in the soil per unit of depth, the depth of rooting of the crop, and the amount of soil water that has been used by the crop or evaporated from the soil surface and needs to be replenished by irrigation.

Each soil has certain characteristics which influence the amount of water that can be stored for use by crop roots. Figure 2 illustrates the most important of these in computing the amounts of water in the soil.

Point D, at the bottom of the vertical scale, is a dry soil. This condition is reached only by drying the soil at about 110°C for extended periods.

Point A, at the top of the scale, is a saturated soil with all air excluded.

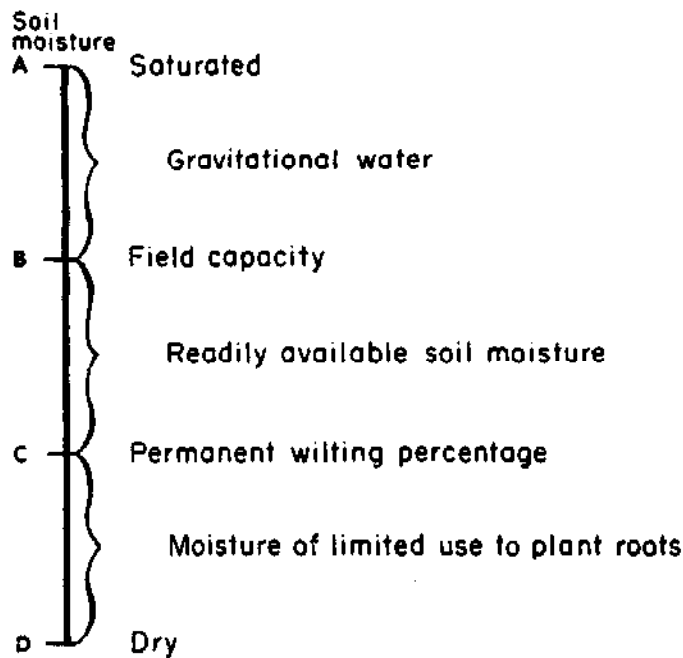

FIGURE 2. Soil moisture characteristics which influence movement of water in the soil and availability of water to plants.

The amount of water in the soil at saturation is equal to the volume of pore spaces. Clay soils usually have a higher total porosity than sands, although the pores are much smaller.

Point B is the amount of water remaining in a wetted soil after drainage has been completed. This is called the field capacity of the soil.

Point C is the moisture content at which the films of water around the soil particles are held so tightly that roots in contact with the soil cannot remove the water fast enough to prevent wilting of the plant leaves. This is called the permanent wilting percentage of the soil. It is a soil characteristic, for all plants whose root systems thoroughly permeate the soil will wilt at nearly the same soil moisture content.

Soil moisture in the range between saturation and field capacity (A to B) is sometimes referred to as gravitational water. Water movement takes place readily within this range, downward by gravitational force and in all directions by capillary movement. The movement is most rapid near saturation, decreasing to very slow values as field capacity is approached. Soils with impaired drainage, in which water is retained at or near saturation during or following an irrigation, will exhibit rapid lateral movement of the water. This is often apparent with furrow irrigation. Because much of the air which is normally present in the soil has been replaced by water within this range, an unfavourable environment results for many plants whose roots have a high oxygen requirement. The very wet soil condition within this range may also be favourable for waterborne diseases,

which can cause serious injury to the roots. Although active roots can utilize the moisture in the soil within this range, care should be taken to prevent this condition from prevailing for prolonged periods when irrigating most crops. Rice is an exception to this general rule, but even the roots of rice require a certain amount of oxygen for best growth.

Soil moisture between field capacity and permanent wilting percentage (B to C) is the range of most importance in computing the amount of available moisture that can be retained in the soil. This range is referred to as the readily available soil moisture. However, it should be recognized that the moisture is available only if the roots have permeated the soil so that they can utilize the water. Soils which have not had their structure impaired by compaction or other causes which prevent the free diffusion of air will generally provide an adequate supply of the oxygen needed by the roots when the soil moisture is within this range.

Many different opinions have been expressed regarding the relationship between plant growth and soil moisture content at various levels within the range of readily available soil moisture. These differences are related to the physics of soil moisture and the physiology of plant growth, and are too involved to be included in this publication. Veihmeyer (1956), Veihmeyer and Hendrickson (1950), Richards and Wadleigh (1952) and others discuss these relationships.

The amount of moisture in the soil is usually expressed as a percentage of the volume or of the dry weight of the soil. The water retained at field capacity is related to the texture (size of particles) of the soil. The per-

TABLE 3. - RANGE OF READILY AVAILABLE SOIL MOISTURE FOR DIFFERENT SOIL TYPES

Soil type	Percent of moisture based on dry weight of soil		Depth of available water per unit depth of soil	
	Field capacity	Permanent wilting percentage	<i>Centimetres per metre</i>	<i>Inches per foot</i>
Fine sand .....	3-5	1-3	2-4	0.3-0.5
Sandy loam .....	5-15	3-8	4-11	0.5-1.3
Silt loam .....	12-18	6-10	6-13	0.7-1.6
Clay loam .....	15-30	7-16	10-18	1.2-2.2
Clay .....	25-40	12-20	16-30	2.0-3.5



permanent wilting percentage is also related to the texture, but can be affected as well by the structure of the soil, which determines the extent that roots can permeate through the pores to utilize the water. For many soils the amount of water present when the permanent wilting percentage is reached is about one half of field capacity. This ratio for specific soils can vary from one third to two thirds. Table 3 shows the range of soil moisture that might be expected to be available for soils of different textures.

### 3. LAND PREPARATION

One of the first tasks in planning a system of surface irrigation is the preparation of the land surface to permit uniform distribution of the water and provide for drainage of excess surface water. Attempts to irrigate land with an uneven surface generally result in low efficiency of water use, excessive labour requirements and poor crop yields. Running the water deep in low points in order to wet the high points causes uneven water distribution and erratic plant growth. Water flowing over land with non-uniform slopes may cause soil to be eroded from the steeper and deposited on the flatter slopes. Excess water resulting from rainfall or overirrigation, if allowed to collect in undrained areas of a field for extended periods, causes deterioration of the soil structure and interferes with tilling. Water standing on a field for longer than 24 hours, unless used for rice crops or for leaching salts from the soil, is generally of no value to crop production. The ponded water may also be a source of mosquitoes.

Land preparation involves moving soil from high spots and placing it in low spots, providing a more uniform plane to the surface of the land. This is sometimes referred to as land levelling or land grading. Since the land surface is not usually levelled to a flat plane, the preferred term is land grading.

Some methods of surface irrigation, such as wild flooding, corrugation and basin irrigation, require only minimum land preparation. Others, using furrows or borders, require very careful preparation.

#### **Soil survey**

Before grading land it is desirable to survey soil profile conditions. This will indicate the extent to which the topsoil can be removed without reducing crop production. Deep cuts may expose saline subsoils, dense soil layers, soils of low fertility or gravel strata which are not conducive to the growing of crops. On some deep uniform soils the exposure of subsoils may require only a moderate amount of leaching or the application of

fertilizers for normal crop production. Stockpiling the more fertile topsoil, grading the subsoil to a uniform slope and then replacing the topsoil uniformly over the surface may be justified in areas suitable for growing high-income crops.

## **Engineering**

Land grading should be based on accurate topographic surveys in order to select the most suitable slopes to which the land surface can be economically graded, and to obtain a proper balance of cuts and fills for the earth-moving work. The cost of a proper engineering design, generally 5 to 10 percent of the total expenses, can usually be repaid many times both by savings in earth-moving costs and by the more uniform surface obtained than would result from attempts to grade the land by guessing where the cuts and fills should be made.

The topographic survey determines land surface elevations at coordinate points established on the field to be graded. This is usually done by dividing the field into small square or rectangular areas of equal size. These areas should be sized so that the elevation of the centre of each is representative of that area. Fields with a very uneven surface will require smaller coordinate areas than fields with nearly uniform surfaces. The sides of small areas should be no longer than 30 metres.

Figures 3 and 4 illustrate the steps followed in planning land grading for a field. A survey revealed that the soils were clay loam with a claypan at a depth of 1 to 1.5 metres. The land is destined for field and forage crops with irrigation runs the full length of the field.

The field is 270 metres wide, east and west, and 325 metres long, north and south. To obtain the topographic survey the field was divided into 13 segments of 25 metres in the north-south direction, and into 9 segments of 30 metres in the east-west direction. A stake was driven into the centre of each of the coordinate areas. The rows of stakes in the north-south direction are indicated by figures, and the rows in the east-west direction by letters (Figure 3).

The elevation of the ground surface is measured at each stake. The top of a hub driven flush with the ground surface at each stake can be used as the reference for the elevation at each point. These elevations, as explained previously, are assumed to represent the average elevation of each of the coordinate areas. The elevations are shown on the map, with the location of the centre of the area being represented by the decimal point of the elevation. An examination of the elevations (contour lines can be drawn if desired) reveals that it would be impossible to run water the full length of

FIGURE 3. Topographic map for land grading, which shows original land surface elevations, computed final grade elevations, and depths of cut (—) or fill (+) at coordinate points.

	A	B	C	D	E	F	G	H	I	Average elevation
1	-0.12 1.95 (1.83)	+0.01 1.81 (1.82)	+0.03 1.77 (1.80)	-0.12 1.90 (1.78)	-0.15 1.92 (1.77)	-0.14 1.90 (1.76)	-0.08 1.82 (1.74)	-0.03 1.75 (1.72)	+0.03 1.68 (1.71)	1.83
2	-0.04 1.80 (1.76)	+0.03 1.71 (1.74)	+0.10 1.62 (1.72)	-0.07 1.78 (1.71)	+0.01 1.69 (1.70)	0 1.68 (1.68)	+0.06 1.60 (1.66)	+0.10 1.55 (1.65)	+0.08 1.56 (1.64)	1.67
3	+0.01 1.67 (1.68)	+0.07 1.59 (1.66)	+0.14 1.51 (1.65)	0 1.64 (1.64)	+0.09 1.53 (1.62)	+0.06 1.54 (1.60)	+0.18 1.41 (1.59)	+0.18 1.40 (1.68)	+0.04 1.52 (1.56)	1.53
4	+0.17 1.43 (1.60)	+0.20 1.39 (1.59)	+0.12 1.46 (1.58)	+0.05 1.51 (1.56)	+0.01 1.53 (1.54)	+0.11 1.42 (1.53)	+0.13 1.39 (1.52)	+0.15 1.35 (1.50)	+0.05 1.43 (1.48)	1.43
5	+0.32 1.21 (1.53)	+0.20 1.32 (1.52)	+0.04 1.46 (1.50)	-0.02 1.50 (1.48)	-0.05 1.52 (1.47)	-0.02 1.48 (1.46)	+0.07 1.37 (1.44)	+0.07 1.35 (1.42)	+0.11 1.30 (1.41)	1.39
6	+0.10 1.36 (1.46)	-0.01 1.45 (1.44)	-0.07 1.49 (1.42)	-0.09 1.50 (1.41)	-0.12 1.52 (1.40)	-0.13 1.51 (1.38)	-0.11 1.47 (1.36)	-0.13 1.48 (1.35)	-0.04 1.38 (1.34)	1.46
7	-0.10 1.48 (1.38)	-0.11 1.47 (1.36)	-0.14 1.49 (1.35)	-0.13 1.47 (1.34)	-0.16 1.48 (1.32)	-0.21 1.51 (1.30)	-0.21 1.50 (1.29)	-0.18 1.46 (1.28)	-0.18 1.44 (1.26)	1.48
8	-0.17 1.47 (1.30)	-0.19 1.48 (1.29)	-0.14 1.42 (1.28)	-0.20 1.46 (1.26)	-0.12 1.36 (1.24)	-0.17 1.40 (1.23)	-0.24 1.46 (1.22)	-0.25 1.45 (1.20)	-0.24 1.42 (1.18)	1.44
9	-0.14 1.37 (1.23)	-0.14 1.36 (1.22)	-0.15 1.35 (1.20)	-0.14 1.32 (1.18)	-0.07 1.24 (1.17)	-0.08 1.24 (1.16)	-0.13 1.27 (1.14)	-0.17 1.29 (1.12)	-0.19 1.30 (1.11)	1.30
10	-0.15 1.31 (1.16)	-0.16 1.30 (1.14)	-0.11 1.23 (1.12)	-0.06 1.17 (1.11)	+0.01 1.09 (1.10)	-0.01 1.09 (1.08)	-0.04 1.10 (1.06)	-0.07 1.12 (1.05)	-0.11 1.15 (1.04)	1.18
11	-0.16 1.24 (1.08)	-0.14 1.20 (1.06)	-0.08 1.13 (1.05)	+0.02 1.02 (1.04)	+0.05 0.97 (1.02)	+0.07 0.93 (1.00)	+0.05 0.94 (0.99)	+0.01 0.97 (0.98)	-0.08 1.04 (0.96)	1.05
12	-0.12 1.12 (1.00)	-0.01 1.00 (0.99)	+0.06 0.92 (0.98)	+0.08 0.88 (0.96)	+0.13 0.81 (0.94)	+0.14 0.79 (0.93)	+0.17 0.75 (0.92)	+0.14 0.76 (0.90)	+0.08 0.80 (0.88)	0.87
13	-0.04 0.97 (0.93)	+0.06 0.86 (0.92)	+0.10 0.80 (0.90)	+0.10 0.78 (0.88)	+0.12 0.75 (0.87)	+0.16 0.70 (0.86)	+0.16 0.68 (0.84)	+0.15 0.67 (0.82)	+0.11 0.70 (0.81)	0.77
← 270 metres →										
325 metres ↑										
Average elevation	1.41	1.38	1.36	1.38	1.34	1.32	1.29	1.28	1.29	1.34
Σ (—)	1.04	0.76	0.69	0.83	0.67	0.76	0.81	0.83	0.84	7.23
Σ (+)	0.60	0.57	0.59	0.25	0.42	0.54	0.82	0.80	0.50	5.09

the field in either direction. For surface irrigation of the field as a unit land grading is necessary.

To select the most suitable slopes to which the land can be graded the natural slope of the field in the two directions must be first determined. Several methods are available for determining slopes of best fit, as described by Marr (1965). These include average-profile, least-squares, cross-section and two-way profile methods. The average-profile method is adequate for solving most land grading problems, and is used in this example.

The average elevations of the points for each east-west row of stakes were computed and are shown on the right; those for each north-south row are shown at the bottom. The average elevation for the entire field is 1.34 metres.

The average elevations are plotted as profiles in Figure 4. The elevations for the east-west rows of stakes give the general slope of the field

FIGURE 4. Profiles of average slopes.

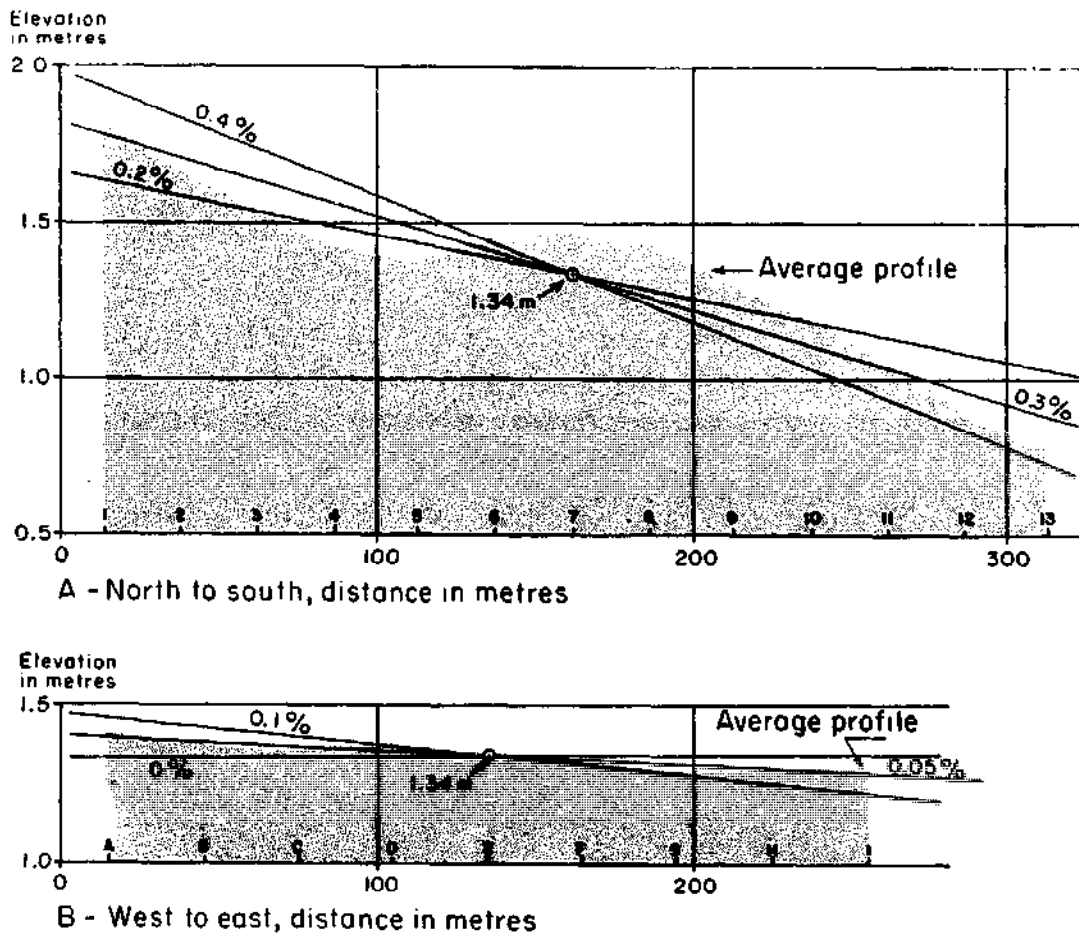

from north to south. The centre of the field is located at point E-7, so the average elevation of the field is plotted on the profile as being on row 7. Lines representing slopes of 0.4, 0.3 and 0.2 percent are drawn through this average elevation. Comparing these slopes with the points representing the average elevations it can be seen that a slope of 0.4 percent would require the hauling of considerable earth from the south end to the north of the field. A slope of 0.2 percent would mean moving soil from the north to the south. A slope of 0.3 percent would mean hauling earth for only short distances, and so is selected as the one of best fit.

The average elevations of the rows in the north-south direction give the general slope of the field from west to east. The average elevation for the field is plotted as being on row E. Lines representing slopes of 0, 0.05 and 0.1 percent are drawn through the point of average elevation for the field. The line representing a slope of 0.05 percent is seen to be the one of best fit. It is therefore decided to grade the field with a slope of 0.3 percent from north to south, and one of 0.05 percent from west to east.

A plane with the selected slopes passing through the average elevations at the centre of the field should theoretically provide a balance of cuts with fills over the entire area. However, experience has shown that there must be an excess of cuts over fills in order to provide enough soil to satisfy the fill requirements. This fact has never been satisfactorily explained, but is probably due to compaction of the soil during the grading operations. The extra amount required will vary for different soils, and must generally be determined by experience. Where most of the cuts are shallow, less than 0.1 metre, the amount of overage required will be greater than it would be for deeper cuts. Loose soils or soils high in organic matter will need more overage than firm mineral soils. An excess of 20 to 45 percent is normally required for loam soils.

To provide an excess of cuts over fills, the grade elevations at each point can be lowered by an equal amount. The exact amount of lowering required to provide the needed excess can be determined by trial and error. In the example, using the method which will be shown later, lowering the elevation 0.30 metre resulted in an excess of 76 percent. When the elevations were lowered 0.01 metre the excess was found to be only 20 percent. Since many of the cuts are less than 0.1 metre this excess would not be adequate. It was therefore decided to lower all grade elevations by 0.02 metre.

Since the average elevation of the field was found to be 1.34 metres, the grade elevation to be used for the central point, E-7, will be 1.32 metres. By adding 0.015 metre (0.05 percent slope for 30 metres) successively to each station to the west of the central point, the grade elevation for point D-7 becomes 1.335 metres, 1.35 for point C-7, etc. By subtracting 0.015 metre for each station to the east of the central point, the grade elevation

becomes 1.305 metres for point F-7, 1.29 for G-7, etc. Likewise, by adding 0.075 metre (0.03 percent slope for 25 metres) to each successive station to the north of the central point, the grade elevation becomes 1.395 metres for point E-6, 1.47 for E-5, etc. The grade elevations for the points to the south of the central point are obtained by subtracting 0.075 metre for each successive point. This procedure can be extended to determine the grade elevations for all points. They are shown on the map in parentheses below the actual elevation of each point. Some figures have been rounded; 1.345 is shown as 1.34, 0.975 as 0.98, etc.

The difference between the actual elevation and the computed grade elevation for each point indicates the amount of cut or fill required. For point A-1 the actual elevation is 1.95 and the grade elevation is 1.83, requiring a cut 0.12 metre deep. For point B-1 the actual elevation is 1.81 and the grade elevation is 1.82, requiring a fill of 0.01 metre. Where fills exceed 30 centimetres the fill depths are sometimes increased by 10 percent to allow for the settlement that will occur when the soil is wetted. The cuts or fills for each point are determined and shown on the figure above the actual elevation of the point, with the amount preceded by a negative sign for cuts and a positive sign for fills. The cuts are sometimes shown in red and the fills in blue on maps for field use.

The cuts and fills in each north-south line are totalled and shown at the bottom: 5.09 metres for all fills and 7.23 metres for all cuts. The percentage of excess cuts over fills is

$$\frac{7.23 - 5.09}{5.09} \times 100 = 42 \text{ percent}$$

This appears to be a reasonable excess for the conditions given in the example.

Since each of the small areas is 30 by 25 metres, or 750 square metres, the total volume of fill is 750 times 5.09, or 3 818 cubic metres. The area of the entire field is 325 by 270 metres, or 8.78 hectares. The amount of earth placed is therefore equivalent to 435 cubic metres per hectare. If the cost of hauling is \$0.20 per cubic metre for earth in place, the cost would be \$87 per hectare. The volume of soil to be moved should normally not exceed 1 000 cubic metres per hectare (530 cubic yards per acre) in order to be economically justified under average conditions. The length of haul should also be limited to about 200 metres whenever possible.

When water is to be delivered to the field in open ditches, a "ditch pad" (ribbon of soil) placed along their alignment will provide the extra soil needed for constructing them with strong banks and high enough above the surface of the field to allow easy delivery of the water into the basins,

checks or furrows. The amount of earth to be placed in the pad will depend on the size of the ditch, but is generally 4 to 6 metres wide and 15 to 30 centimetres high. The volume can be computed and included as part of the fill requirement.

When open ditches are to be used for drainage it is sometimes possible to construct them before doing the land grading. This will permit soil excavated from the ditches to be spread over the field and eliminate high banks along the drains, which are often a nuisance. The volume of the excavated soil can be computed and used to satisfy part of the cut requirement.

The final step in the engineering work is to mark the stakes in the field to indicate the amount of cut or fill required at each of the coordinate points, and to check the earth moving to see that the work is properly done. Various techniques are used for indicating on the stakes the depth of cut or fill at each point. One is to colour both sides of the stake with a blue crayon to the height of the fill required in fill areas, and to colour the stakes from the top with a red crayon for a length equal to the depth of the cut required in cut areas. Another method is to place a narrow white band around the stakes at a given distance, such as 30 centimetres, above the final grade. In areas where deep cuts are required two bands can be used, showing that the indicated elevation is 60 centimetres above final grade, and so on. Whatever method is used it should give a clear and easily distinguishable direction to the operator of the earth-moving equipment as to the amount of cut or fill at each point.

## **Equipment**

Land preparation requires equipment for removing brush, trees and roots from the area to be irrigated; equipment for breaking up stratified soil profile conditions which may interfere with the growth of crops; equipment for hauling earth in making major cuts and fills; equipment for doing the final grading work to provide a smooth, uniform surface to the field; and equipment for constructing the levees, ridges or furrows needed for irrigation.

Native vegetation can be removed by hand, using axes and other small tools. Herbicidal sprays and burning can be used for brush removal if care is taken to protect growth outside the treated area. Tractors equipped with dozer blades, brush cutters or tree-felling attachments are commonly used for clearing large areas.

The loosening of large roots and the breaking up of plough soles, compacted layers or other stratified conditions in the soil profile require heavy tractor-drawn equipment. Scarifiers, subsoilers, chisels, etc., may



be mounted to the tool bar of large tractors or may be wheel-mounted (Figure 5). Such work should be done when the soil is relatively dry, so that the soil strata can be more thoroughly shattered and broken up than is possible when the soil is wet. Because of the large thrust force required to move such tools through dry soils the equipment must be strongly constructed. Even with the largest tractors it is usually not possible to break up compacted layers to depths greater than about 75 centimetres using a single shank on the scarifier or ripper. Vibrating subsoilers have been developed which require less power to pull them through dry soils. Where the soil is to be chiselled to depths of 40 centimetres or less, it is generally possible to use multiple shanks drawn by a single large tractor (Figure 6).



FIGURE 5. Scarifier, or subsoiler, mounted on wheel assembly, for ripping the soil. This heavy equipment may use 1 to 3 shanks each 60 to 90 centimetres long.

FIGURE 6. Chisels used to loosen soil or break up shallow compacted layers. These multiple-toothed tools will operate to a depth of 25 to 30 centimetres.

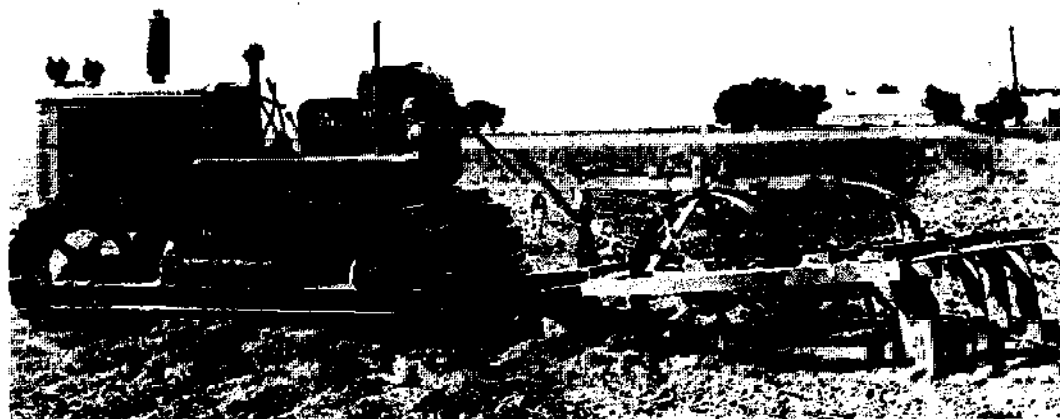

It is usual to do deep subsoiling before major earth-moving work, and to do shallow chiselling after the field has been roughly graded but before the final smoothing work.

Equipment used for moving earth will vary according to availability, size of field, and so on; the essential features are provisions for excavating, lifting, transporting and spreading the soil.

In regions where holdings are small, and where labour is abundant, the use of hand-operated earth-moving equipment drawn by farm animals may be the most feasible (Figures 7A, 7B and 8). A buck scraper drawn by bullocks is used in India. It can be made by a carpenter or blacksmith, as described by Michael *et al.* (1964). It is suitable for moving small volumes of soil short distances, after the soil has been loosened by ploughing or softened by flooding. Shallow ponding of water in a basin can be used for locating the high and low spots which need to be graded. This is sometimes referred to as water levelling.

FIGURE 7A. Buck scraper, which can be drawn by animals, provides a means of grading small areas to a uniform slope.

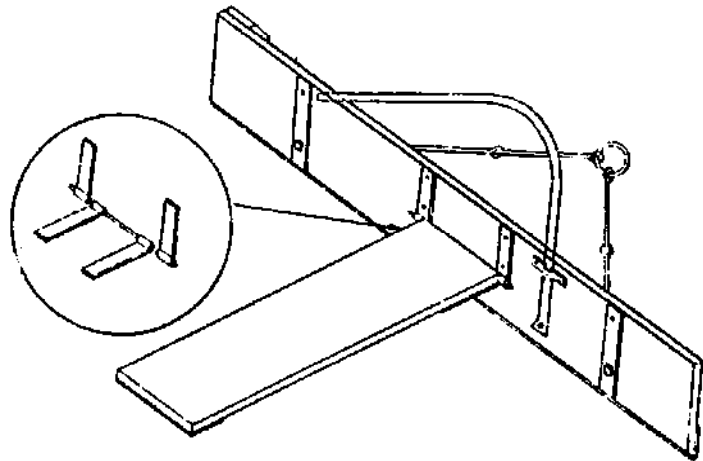
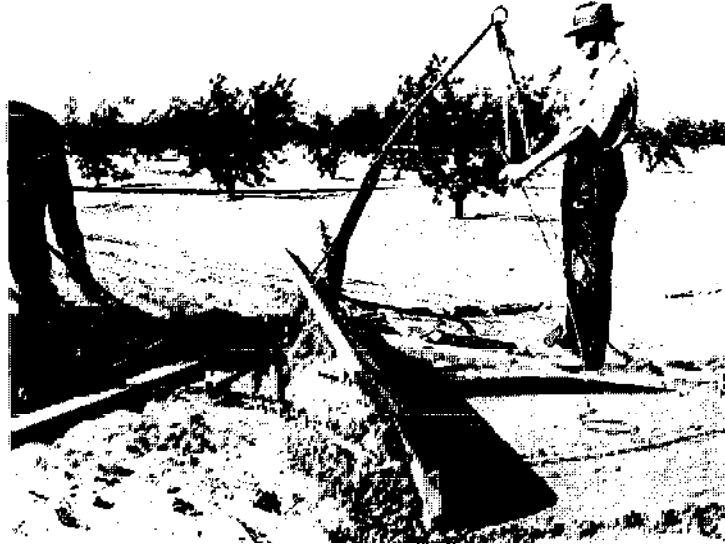

FIGURE 7B. Bullock-drawn rake for water levelling in rice paddies.

FIGURE 8. Buck scraper, drawn by a team of horses, used to remove small irregularities on the land surface of an orchard.



Where farm tractors are available, small bucket-type scrapers can be used for land-grading work. The capacity of such scrapers is usually limited to about 2 cubic metres when drawn by a 40-to-50-horsepower tractor (Figures 9 and 10). This equipment takes considerable time to move large volumes of soil, so its use is generally limited to filling in small depressions or correcting other minor irregularities on the field surface.

A rotary-type scraper (Figure 11), which has blades attached to a rotating reel for lifting the soil into a carrying bowl, can also be used with

FIGURE 9. Small hydraulic scraper with capacity of 2 cubic metres, which can be operated with a 45-to-50-horsepower wheel tractor.

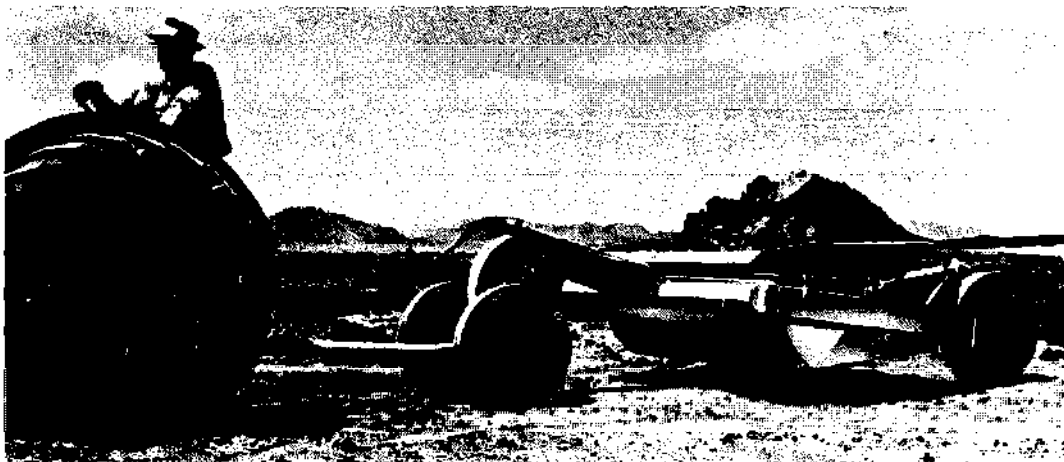

medium-sized wheel tractors, as can the elevating scraper (Figure 12), which has a series of blades on a moving chain for lifting the soil into the bowl. As they require less power for excavating and filling, these scrapers can carry two to three times as much soil as a bucket-type scraper utilizing the same tractor horsepower. A pneumatic system is required to operate the hydraulic controls on both types of scraper.

On more extensive holdings, or where a considerable amount of land grading is to be done, the use of large mechanized equipment is usually more economical. Fields should be a minimum size of about 4 hectares. Smaller adjoining fields can be graded as one unit in order to justify the use of large equipment. Land in new development projects which is to be irrigated should be graded before subdivision into small holdings.

Large earth-moving equipment represents a sizable investment. Since its use on each field is of limited duration, it would not normally be practical for individual landowners to buy it. Work requiring large equipment is usually done by government agencies or by specialized contractors.

Payment for use of the equipment may be based on an hourly rental or on a price per unit volume of earth moved. The hourly rental rate usually includes the wages of the operator and the cost of the fuel, with payment restricted to the hours that the equipment is actually working. When the work is paid by volume, the contract should specify the method to be used for computing the amount of earth moved. This is usually based on the volume of earth placed in the fills. It can be computed by the method used in the previous example, or by using the prismoidal formula described by Marr (1965), which is more exact.

The size and type of tractor will have an important bearing on the efficiency of the earth-moving work. The size will determine the capacity of the bucket scraper which can be used. This, together with the tractors' normal travelling speed, determines the volume of soil which can be moved in a unit of time by one operator.

The two- and four-wheel rubber-tired tractors are designed for speed but provide less traction than the crawler type. The two-wheel tractor has more manoeuvrability but less control over the depth of cutting of the scraper blade than the four-wheel. A crawler tractor is generally required to push loading scrapers drawn by wheel tractors (Figure 13). One pusher can be used with several scraper units. For a land-grading project requiring long hauls, a fleet of several wheel tractors with scrapers, and one crawler tractor used as a pusher, will do the work most efficiently.

The crawler tractor has greater traction than the wheel tractor on all types of soils. This permits more rapid loading of the bucket scrapers and better control over the depth of cutting and spreading of the soil. A bucket scraper drawn by a crawler tractor can be operated as a single

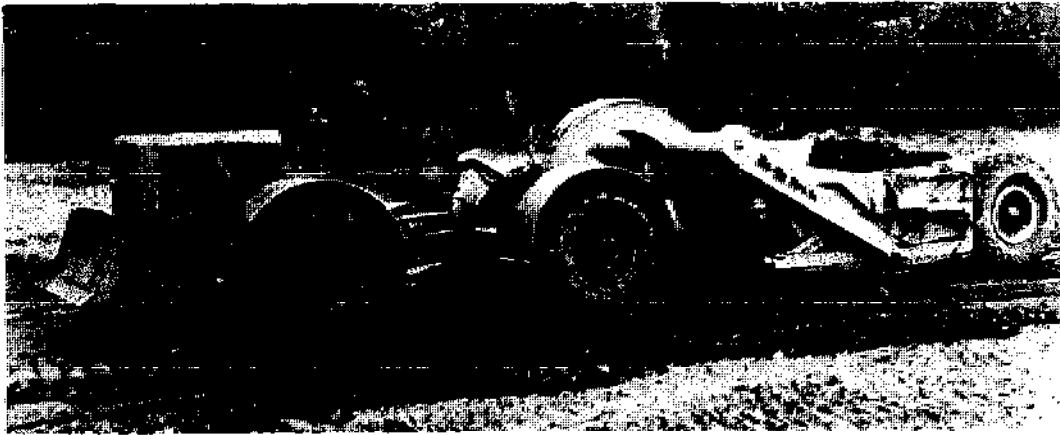

FIGURE 10. Small two-wheel scraper used with a four-wheel tractor.

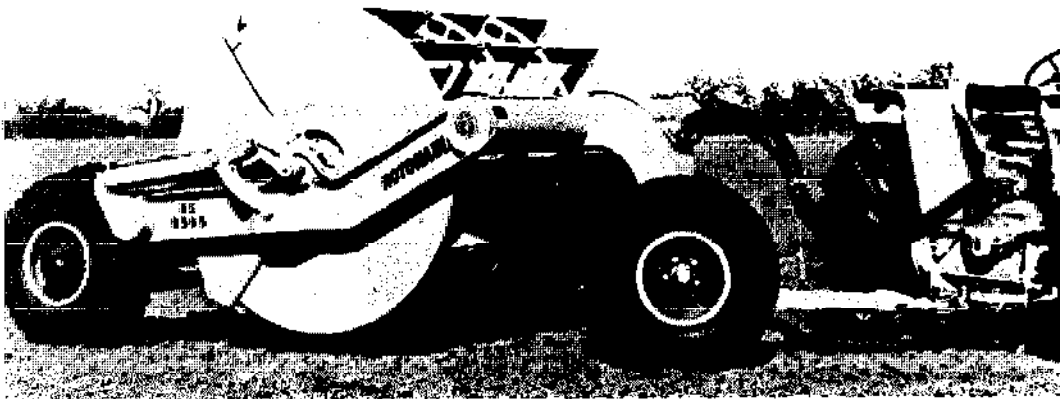
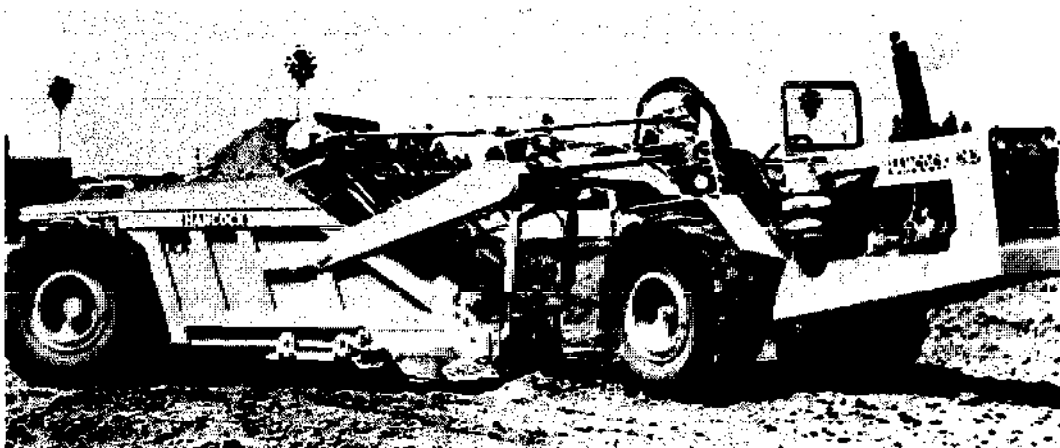
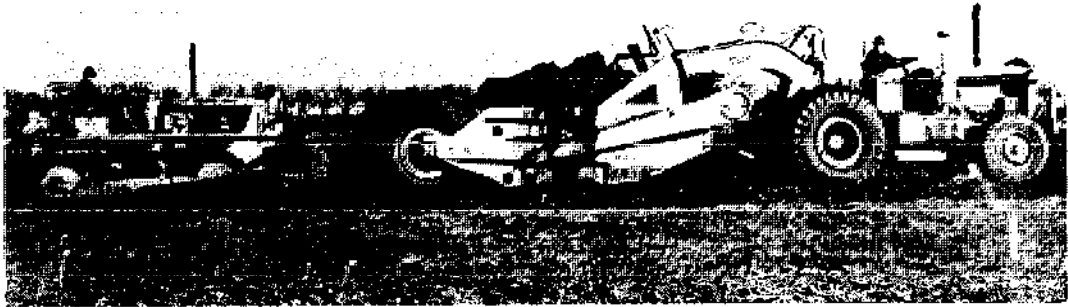

FIGURE 11. Rotary-type earth scraper which can be operated with a wheel tractor of 40-to-60-horsepower. The bowl has a capacity of 5 cubic metres.

FIGURE 12. Elevating scraper with two-wheel tractor making cut for land-grading work.



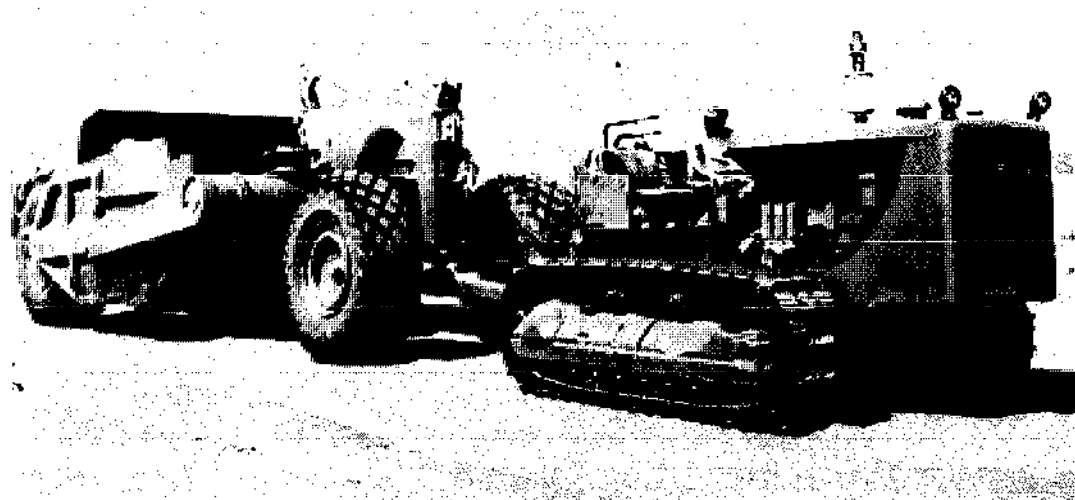

**FIGURE 13.** Four-wheel rubber-tired tractor and two-wheel bucket scraper being pushed by crawler tractor with blade during loading operation.

unit (Figure 14), and is generally preferred on small land-grading projects and where hauling distances are short.

The large carrier-type scrapers consist of a rectangular bucket mounted on a two- or four-wheel frame. A cutting blade is attached to the lip of the bucket. An apron at the front end of the bucket can be raised or lowered to retain the soil and control the rate of loading or dumping. A movable ejector face across the back can be moved forward to push the soil from the bucket during the spreading operation. During loading, the bucket is lowered and the apron is lifted. During hauling, the bucket is lifted clear of the ground and the apron is closed. During spreading, the apron is lifted and the depth of fill is controlled by the height of the cutting blade above the ground surface. The capacity of the buckets

**FIGURE 14.** Crawler tractor and four-wheel bucket scraper used for land-grading.



generally used for land grading varies from 8.5 to 31 cubic metres of loose earth.

After the major earth-moving work is done the soil is sometimes chiselled (Figure 6) with a multiple-toothed implement that breaks it to a depth of about 25 centimetres. This helps to counteract the compaction caused by the movement of heavy equipment across the soil.

The final step in land-grading work is to correct minor irregularities that have not been smoothed by the scrapers. This finishing can be done by a drag float drawn by animals or a small tractor, or by large bottomless scrapers (land planes) pulled by tractors.

Floats are frames holding several inclined boards or blades which can drag small quantities of soil short distances from high spots and deposit them in low spots. The width and length of the frame to use will depend on the amount of power available to pull it across the soil surface. A frame made with side runners 5 metres long and three cross blades 1.7 metres long can be drawn by two bullocks (Figure 15). Wooden blades are sometimes faced with metal.

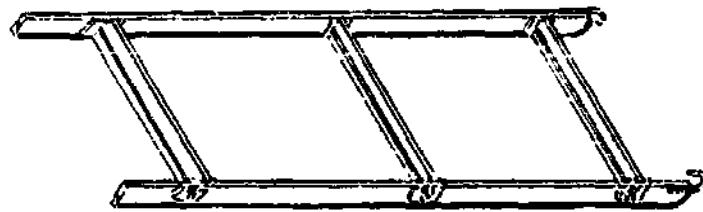
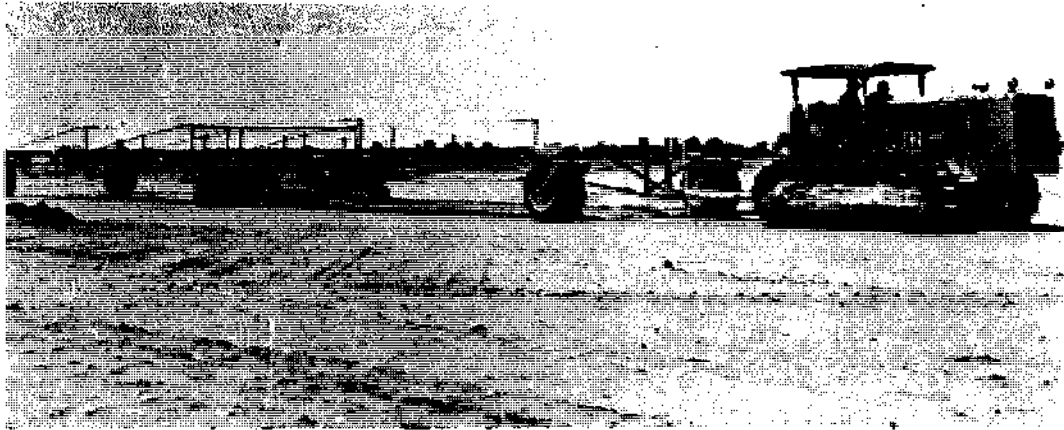

FIGURE 15. Wooden float for final smoothing of irrigated fields.

Bottomless scrapers are available in several different designs (Figures 16 and 17). They consist essentially of a long frame with wheels at the four corners and a bucket with an open bottom in the middle. The bucket automatically scrapes soil from the high points and deposits it in the low points over which it passes. The rolling action of the soil being carried along by the bucket helps to pulverize the large clods. The clearance of the bucket above the soil surface can be set to the height needed for the conditions where it is operating. The longer the span, the more uniform the finished soil surface. These machines are generally used only on large fields of 4 hectares or more, which have been previously graded to uniform slopes of less than 2 percent. Three passes are normally made across the field with the scraper during the finishing operation—once in each of the diagonal directions and once in the direction of irrigation.

The accuracy and efficiency of land-grading work depend on the ability of the operators of the earth-moving equipment. There is a specialized job requiring considerable experience. This is one of the reasons why



**FIGURE 16 (above).** Bottomless scraper, or land plane, being used for final smoothing of a field which has been graded to a uniform plane.

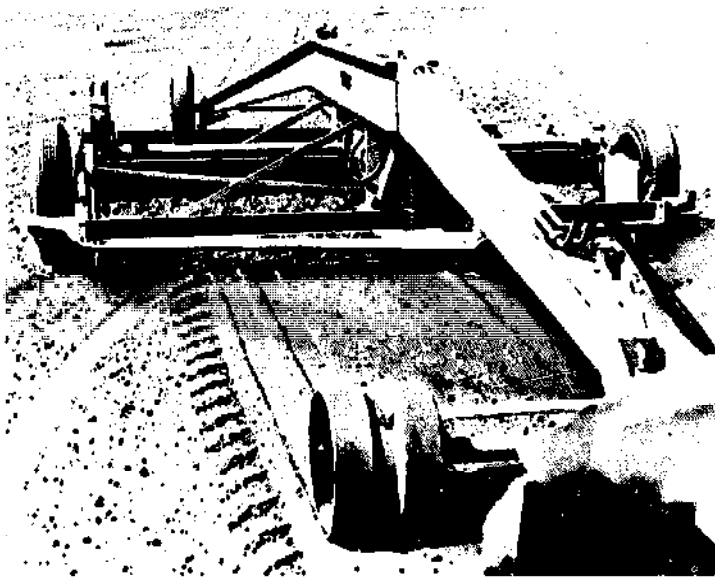

**FIGURE 17 (left).** Another type of bottomless scraper, for correcting minor irregularities on land surface.

contractors who have trained operators and the proper equipment can do land-grading work at reasonable cost.

Earth-moving operations should be confined to seasons when soils are relatively dry. The use of heavy equipment on wet soils can cause severe compaction or a breakdown of soil structure, which can decrease crop yields for several years. An ideal time is soon after a grain crop is harvested, provided that rains have not rewet the soil.

Some settlement of the soil is likely to follow irrigation, especially in areas of deep fills. This may cause minor irregularities to develop on the surface, even on land which has been carefully graded. For this reason it is best to plant an annual crop the first year after grading. After harvesting this crop, low spots which develop can be refilled before perennial crops such as orchards or vineyards are planted.



#### 4. OPEN DISTRIBUTION SYSTEMS

The distribution system consists of the canals, pipelines or flumes used for conveying the water from its source to the high edge of the field, where it can be released into basins, checks or furrows. The structures needed for the control and measurement of the water are also considered to be part of the distribution system.

The conveyance structures used on large projects for the delivery of water to a number of farms require careful engineering to suit the conditions where they are to be installed. These primary and secondary systems should be designed by a qualified engineer, and are beyond the scope of this publication, which is concerned with systems which can be constructed and operated by the irrigator, using small conveyance structures for carrying the water from the main supply system to the fields to be irrigated, and often referred to as tertiary or quaternary systems.

The requirements of any distribution system are: that it have sufficient capacity to deliver the required amount of water to any point whenever needed; that the flow of water can be accurately controlled; that soil erosion and seepage losses can be kept to a minimum; that maintenance and weed control work can be easily performed; that it be convenient to operate so that labour requirements are not excessive; and that installation costs can be economically justified by the returns expected from the crops to be grown.

The distribution system must be located with care so that it will adequately meet the above requirements. For open structures, such as ditches or flumes, the alignment must provide a uniform slope. Where the land has been graded to a uniform plane the ditch or flume can usually be placed in a straight line across the upper edge of the field or fields to be irrigated. Where the land has an irregular surface the ditch must follow the general contour of the field in order to obtain a uniform slope. For closed structures, such as pipelines (see following chapter), the principal requirement is that the outlets be at an elevation sufficiently lower than the inlet to compensate for friction losses in the pipe and to provide the needed outlet pressure. Pipelines can usually be placed in a relatively straight line regardless of the slope, but hydrostatic pressures which might develop at

the low points must not exceed the allowable operating pressure for the type of pipe being used.

### **Unlined ditches**

The most widely used of all distribution systems are earthen ditches, because of their low cost and ease of construction. They are often the most suitable means for conveying water on relatively flat land with soils having low water intake rates. On steep lands or unstable soils, however, they are subject to soil erosion and loss of control of the water is possible. Water losses from seepage on pervious soils can reduce the quantity available for irrigation to inadequate amounts. In all cases, costs for maintenance and weed control are high when unlined ditches are used.

Weeds growing along the ditch banks are a source of seeds for infesting the irrigated fields. In tropical areas aquatic weeds can provide a habitat for snails and so risk the spread of water-borne diseases in humans. Weed growth can also reduce the carrying capacities of the ditches to the extent that water will overflow the banks unless the inflow is reduced. Weed control is thus essential for the efficient use of earthen ditches. Even with lined canals it is desirable that a soil sterilant be applied to the subgrade before placing the lining, to inhibit possible weed growth through cracks or small openings which might develop.

Unlined ditches for delivering water to basins or checks (Figure 18) are frequently constructed with semipermanent levees so that they can be used for a number of years. Ditches supplying water to furrows, basins or checks for irrigating annual crops are often dug at the beginning of the irrigation season and removed prior to harvest. Where farming is highly mechanized it is sometimes the custom to dig the earthen ditches prior to each irrigation and fill them in after irrigation is completed. This helps control ditch-bank weeds and eliminates crossing and turning problems for cultivating and harvesting equipment.

Various methods are used for constructing earthen ditches. Where farms are small and labour is plentiful, they are often dug by hand. Simple animal-drawn tools, such as the homemade drag-type ditcher described by Herpich (FAO, 1963), may be used as aids in forming the ditches (Figure 19). When using the drag-type ditcher a furrow is first opened with a mouldboard plough. The runner board of the ditcher rides in the bottom of the furrow, and the crowder board (with handle) deflects the soil at an angle out of the furrow to deepen and enlarge it to form the ditch. The operator can add weight by standing on the runner board. Several passes in each direction are made with the ditcher until the required size has been



FIGURE 18. Earthen ditch for distributing irrigation water. Water is released into the field by shovelling openings in ditch bank.

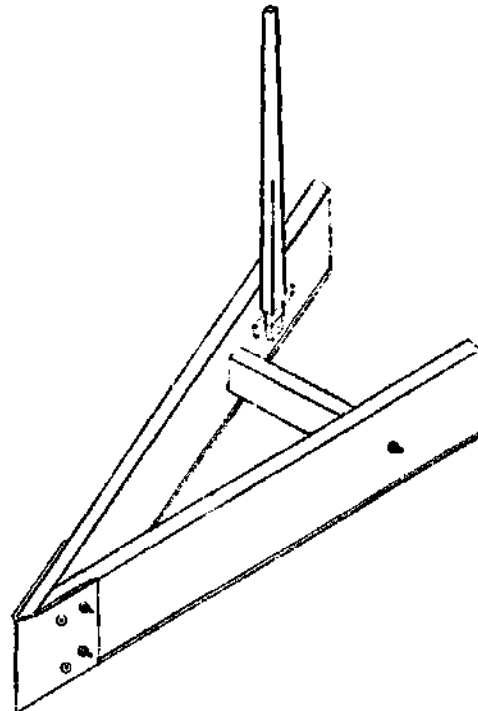

FIGURE 19. Homemade drag-type ditcher.

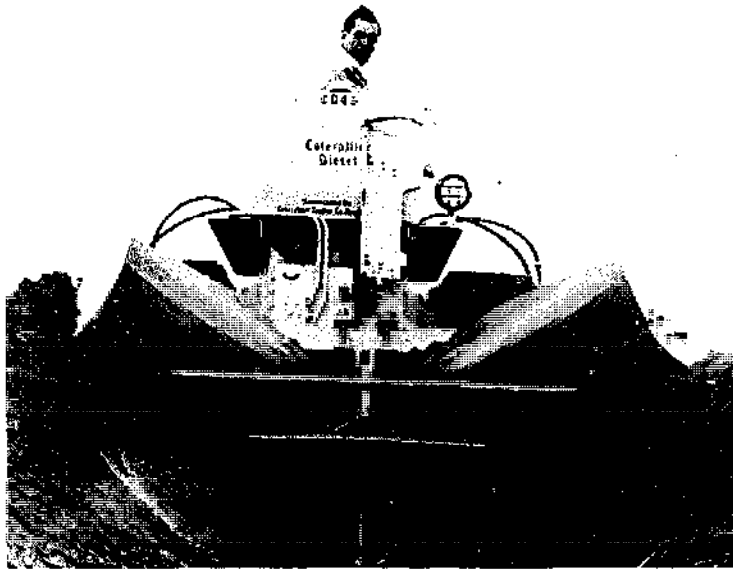

FIGURE 20. V-ditcher mounted on the tool bar of a crawler tractor.

excavated. A single ditch may be used for supplying water to several farms, in which case the work of constructing and maintaining it can be done as a community enterprise.

On large holdings earthen ditches are usually excavated with tractor-drawn tools. The V-ditchers used are a variation of a double mouldboard plough (Figure 20). This equipment is commercially available for forming ditches of any size.

The normal practice is to construct the ditch by excavating a channel in the surface of the soil. Unless it is quite deep the amount of excavated soil may not be enough to form strong banks. On the other hand, it is difficult to release large flows on to the land from deep ditches with most of their depth lying below the ground surface. One means of overcoming these difficulties is to lay a pad of soil along the line for the ditch, as described in the chapter on land preparation. This provides the additional earth needed to construct banks firm and high enough to permit easy delivery of water on to the field. When available, an impervious clay is sometimes used for the ditch pad, to reduce seepage losses. Compacting the soil in the pad will also help to reduce water losses.

### Lined ditches

Linings are placed in ditches for a number of reasons. Where water must be transported over porous soils linings help reduce seepage, thus minimizing water losses and helping to prevent waterlogging of cropland.

Because lined ditches are more resistant to erosion, they can be used on steeper slopes than can unlined ditches.

Linings which form smooth surfaces reduce friction losses and increase the carrying capacity of the ditch. Rigid linings permit steeper banks than are possible in unlined ditches, allowing narrow ditches that occupy less land. Some linings help prevent the growth of aquatic plants and the breeding of mosquitoes, snails and other parasites. Linings reduce water losses caused by burrowing animals, particularly when the ditches are placed on elevated fills (Figure 21). Finally, maintenance costs are generally less for lined ditches.

Various materials are used for lining. In selecting the type to use, consideration should be given to the size of the ditch, its permanence, the soil in which it is to be constructed, the availability of material, and the type of machinery and the ability of the workmen available for installing the lining. The effectiveness of various types of canal linings is discussed more fully by Kraatz (FAO, 1971e).

The simplest lining is a layer of clay placed over the bed and banks of the ditch. Bentonitic clays are sometimes mixed with the natural soil on the ditch faces. Where clay materials are readily available they are often the most economical type of lining for reducing seepage through porous soils. Compaction of the soil will help to further reduce seepage losses.

FIGURE 21. Concrete lining in elevated ditch supplying irrigation water to basin furrows.



Clay linings do not, however, provide resistance to erosion, improve the hydraulic characteristics of the ditch, or inhibit the growth of weeds and parasites. Velocities of water flow in earthen ditches should usually be less than 1 metre per second. The side slopes for clay-lined canals may vary from 2 to 1 in fairly stable soils, to 3 to 1 in loose sands (see Table 4).

Rigid linings using cement or asphalt concrete paving may be cast in place or formed from precast concrete slabs, bricks or rubble masonry. These linings are relatively permanent.

Where sand, gravel and portland cement are available, concrete linings are generally preferred. Although requiring a high initial investment, their long life means their prorated annual cost is lower than that of most other types of lining. Cement concrete linings can be formed by plastering the faces of the ditch with mortar. Guide templates are often used to obtain a more uniform surface in placing the wet concrete. Machines, using a slipform for placing the concrete, are available for lining ditches of all sizes. Also available are special machines which apply a mixture of portland cement, sand and water pneumatically to the faces of the ditch. Small ditches with vertical sidewalls are sometimes constructed by using wood or metal forms for placement of the concrete.

Asphaltic concrete linings can be applied where asphaltic materials are readily available. A mixture of sand, gravel and asphalt is used to form a paved surface in much the same manner as that for placing a portland cement concrete lining. Asphaltic concrete linings normally have a shorter life, a greater possibility of weed growth through the lining and less resistance to erosion than portland cement concrete linings. The asphaltic mix may be hot or cold. Special equipment is required to prepare and place the hot mixtures.

Prefabricated materials, such as precast concrete slabs (Figure 22) or bricks, or rock for forming rubble masonry linings, may be preferred in some areas. Their construction requires more manpower than poured concrete linings, so their use is generally confined to areas where labour is plentiful, or where the costs of alternate materials are high.

The required thickness of rigid concrete linings will depend on the size of the ditch, and may vary from 2.5 to 7.5 centimetres. The side slopes may be 1 to 1 in rocky soils, but for most soils a slope of 1½ to 1 is preferred. Poured concrete linings in small ditches do not usually require reinforcing steel, although a meshed reinforcement is sometimes used in larger canals. Grooved contraction joints should be placed 2 to 4 metres apart in these linings to localize cracks resulting from transverse shrinkage caused by temperature or moisture changes. Portland cement concrete linings should be properly cured by keeping the surface wet for several days after placement.

TABLE 4. - SUGGESTED MAXIMUM FLOW VELOCITIES, COEFFICIENTS OF ROUGHNESS AND SIDE SLOPES, FOR LINED AND UNLINED DITCHES AND FLUMES

Type of surface	Maximum flow velocities		Coefficients of roughness ( <i>n</i> )	Side slopes or shape
	<i>Metres per second</i>	<i>Feet per second</i>		
<b>UNLINED DITCHES</b>				
Sand .....	0.3-0.7	1.0-2.5	0.030-0.040	3:1
Sandy loam .....	0.5-0.7	1.7-2.5	0.030-0.035	2:1 to 2½:1
Clay loam .....	0.6-0.9	2.0-3.0	0.030	1½:1 to 2:1
Clays .....	0.9-1.5	3.0-5.0	0.025-0.030	1:1 to 2:1
Gravel .....	0.9-1.5	3.0-5.0	0.030-0.035	1:1 to 1½:1
Rock .....	1.2-1.8	4.0-6.0	0.030-0.040	¼:1 to 1:1
<b>LINED DITCHES</b>				
<b>Concrete</b>				
Cast-in-place .....	1.5-2.5	5.0-7.5	0.014	1:1 to 1½:1
Precast .....	1.5-2.0	5.0-7.0	0.018-0.022	1½:1
Bricks .....	1.2-1.8	4.0-6.0	0.018-0.022	1½:1
<b>Asphalt</b>				
Concrete .....	1.2-1.8	4.0-6.0	0.015	1:1 to 1½:1
Exposed membrane .....	0.9-1.5	3.0-5.0	0.015	1½:1 to 2:1
Buried membrane .....	0.7-1.0	2.5-3.5	0.025-0.030	2:1
<b>Plastic</b>				
Buried membrane .....	0.6-0.9	2.0-3.0	0.025-0.030	2½:1
<b>FLUMES</b>				
Concrete .....	1.5-2.0	5.0-7.0	0.0125	
<b>Metal</b>				
Smooth .....	1.5-2.0	5.0-7.0	0.015	
Corrugated .....	1.2-1.8	4.0-6.0	0.021	
Wood .....	0.9-1.5	3.0-5.0	0.014	



FIGURE 22. Precast concrete blocks were used to line this field ditch. The joints between the blocks are filled with mortar to form a nearly watertight lining.

Nonrigid linings formed from various membrane materials are also used. These are usually prefabricated from plastic, butyl rubber, or compounds of asphalt with jute, paper or fibreglass, in sheets of a size that can be easily handled. These linings may be exposed or covered with a layer of soil and gravel. Exposed membrane linings, as well as being relatively impervious to water, should be resistant to deterioration by weathering and able to withstand trampling by animals. The membranes are often covered with a layer of soil and the ditch faced with gravel to protect it from weathering and mechanical damage. Such a cover does not inhibit weed growth, and ditch-cleaning operations must be carried out carefully, to protect the membrane from punctures or other damage. It may also be subject to erosion in places, such as where water flow is fast or below drop structures where there is considerable turbulence.

The side slopes required for nonrigid linings will vary from  $1\frac{1}{2}$  to 1 to  $2\frac{1}{2}$  to 1. Details of construction methods are generally furnished by the companies which make the membranes or supply the raw materials used.

A number of liquid materials have been proposed for sealing ditches to



reduce seepage losses. Some are mixed with the irrigation water and others are sprayed on the faces of the empty ditch. They reduce seepage by dispersing the clay materials in the soil or by filling the soil pores to form an impervious membrane. Several liquid sealants are available commercially and, when properly used, some have shown promise for reducing seepage.

## Flumes

Elevated flumes made of precast concrete are used in many parts of southern Europe and northern Africa for delivering water from the main canal systems to fields under surface irrigation (Figure 23).

The flumes are either semicircular or elliptical, which means they have ideal hydraulic characteristics for obtaining maximum flow per unit of cross-sectional area. The ends of the flume sections are supported on pedestals 0.2 to 1 metre above the soil surface, allowing the entire area to be farmed up to the flumes. Their concrete construction allows very little leakage, so there is no waterlogging of soils nearby. Any leaks or other failures are easily observed, and maintenance work can be kept to a minimum.

Little silting and no weed growth take place in the flumes. They are made under controlled conditions in plants specializing in their construction. This allows a high degree of perfection as to minimum tolerance of dimensions and in providing smooth interior surfaces to reduce friction losses.

Installation requires skilled workmen who can place the pedestals at the correct elevation to provide the desired slope. The maximum allowable deviation from the design elevation at any point is generally limited to 1 centimetre. Such accuracy is essential to utilize the efficiency of design which is characteristic of these systems. Sizes are selected to carry the required flow with a minimum allowance for freeboard. Flumes designed to carry 50 litres per second usually allow only 1 centimetre depth for freeboard. This provides very little "elasticity" in the network and requires accurate control of the water level in the flumes. Constant-level automatic gates are imperative with such systems. Emergency siphons are sometimes incorporated in the design to release into a spilling channel the excess resulting from an abnormal rise in the water level.

The length of the flume sections and the spacing of the support pedestals are dependent on the type of concrete used. Precast vibrated nonreinforced sections are usually limited to 1 metre in length. These short lengths are often used for forming the curved sections of the system. Reinforced flumes with capacities of 50 litres per second with a semicircular cross-section can be made in 5-metre lengths with supports at the ends only.

Prestressed reinforced flumes of elliptical cross-section capable of carrying the same discharge can be made in lengths of 7 metres when supported only at the ends. Single sections can be removed to let equipment in and out of the fields.

Because concrete is relatively resistant to erosion the flumes can be installed with fairly steep slopes when necessary to convey water from a high to a lower elevation. Slopes are generally slight, however, where water is taken directly from the flume for irrigating. Drop structures are used where the slope of the flume is less than the slope of the alignment. These drops are usually vertical concrete pipe stands into which the water flows at the higher elevation and with an outlet into the flume at the lower elevation. They are generally spaced so that the drop of the water does not exceed 1 metre.

Siphon outlets are normally used for taking water from the flumes to the fields. To dissipate the energy of the falling water the siphons drop it into a stilling basin, which is a component of the siphon. Another component is a portable metal dam shaped to fit the cross-sectional area of the

FIGURE 23. Precast concrete flumes mounted on pedestals carrying water to irrigated fields.



flume; this is placed in the flume below the siphon to check the flow of water.

The flume distribution system needs correct engineering design to realize its greatest potential value. The initial costs are quite high in comparison with those of other distribution systems.

### Design of open distribution systems

The quantity of water which can be carried in a ditch or flume depends on the cross-sectional area of the stream of water and the velocity of the water. This relation can be expressed by

$$Q = AV \quad (1)$$

When the cross-sectional area ( $A$ ) is measured in square metres and the velocity of the water ( $V$ ) is in metres per second, the discharge ( $Q$ ) will be in units of cubic metres per second; or,  $Q$  will be in cubic feet per second when  $A$  is in square feet and  $V$  is in feet per second. When water is flowing in a ditch or flume without outlets, the value of  $Q$  remains constant. Any change in cross-sectional area must be accompanied by a corresponding inverse change in velocity of the water.

The movement of water in a ditch or flume depends on the accelerating force (gravity) which causes the water to flow, and the resisting force (friction) which tends to slow the flow. The design of a channel is based upon approaching a balance of these two forces so that flow with respect to time will be uniform and steady.

The shape of the cross-sectional area will influence the carrying capacity. The ideal shape for the cross-sectional area of the water is a semicircle. As the width increases in relation to the depth, the average velocity of the water will decrease. The term "hydraulic radius" ( $r$ ) is used to define the shape of the channel, and is expressed by

$$r = \frac{\text{area}}{\text{wetted perimeter}} \quad (2)$$

The wetted perimeter is the length of the perimeter of the cross-sectional area of the channel actually in contact with the water, and does not include the distance across the water surface.

The velocity of water flowing in an open channel will vary with depth and with distance from the edge of the channel. It is therefore necessary to determine what the average velocity will be for the entire cross-sectional

area of the water under consideration. The Chezy formula is commonly used for determining average velocity:

$$V = C \sqrt{rs} \quad (3)$$

where  $V$  is the average velocity;  $C$  is a coefficient dependent on the roughness of the channel ( $n$ ), the shape of the conduit ( $r$ ), and to a slight degree upon the slope ( $s$ );  $r$  is the hydraulic radius, and  $s$  is the slope measured in unit fall per unit distance.

Several formulæ can be used for determining the value of  $C$  in the Chezy formula. The most practical of these is the Manning formula, which eliminates the effect of slope and is expressed by

$$C = K \frac{r^{\frac{1}{6}}}{n} \quad (4)$$

where  $K$  is a constant equal to unity when metric units are used, and is equal to 1.486 when distances are measured in feet;  $r$  is the hydraulic radius, and  $n$  is the Manning's coefficient of roughness, the values of which are given in Table 4 for different types of ditches and flumes.

Combining equations (1), (2), (3) and (4) gives an expression for the rate of discharge as follows

$$Q = A K \frac{r^{\frac{2}{3}} s^{\frac{1}{2}}}{n} \quad (5)$$

The quantity  $Q$  is in cubic metres per second when the area ( $A$ ) is measured in square metres,  $r$  is measured in metres, and  $K = 1$ ; or  $Q$  is in cubic feet per second when  $A$  is in square feet,  $r$  is in feet, and  $K = 1.486$ .

Channels for conveying water can be any number of different shapes. The most efficient is a semicircle, but the near-vertical sides for such cross-sections are impractical for earthen ditches, and are possible for lined channels only if forms are used to hold the concrete until it has set. Semicircular channels are therefore generally limited to precast concrete flumes and pre-shaped metal or plastic flumes. The most efficient trapezoidal section is the half-hexagon, but the side slopes are again too steep for most channels except possibly those with concrete linings placed by the slip-form process. The side slopes commonly used for various types of lined and unlined canals are given in Table 4. Slopes are expressed as the ratio of the horizontal distance to the vertical distance. The bottom widths used for lined trapezoidal channels should usually be from half to equal their depth of water.

The depth of the ditch or flume is always greater than the depth of water

which it will normally carry. This additional depth is referred to as the freeboard, which is provided to allow for abnormal flows or conditions which might otherwise cause the ditch or flume to overflow. The amount of freeboard required will depend on the accuracy of design and construction; the quantity of water to be carried; the curvature of alignment; the possibility of reduction in carrying capacity due to aquatic weeds, siltation, or other causes of plugging; and the stability of the banks against settlement, erosion or other failures. The amount of freeboard is also a measure of the elasticity of the system, and the usual practice is to allow for abnormal flows 20 to 40 percent in excess of the design capacity. For concrete-lined canals 6 centimetres is generally allowed, and for earthen ditches, where more freeboard is desirable, 7.5 to 15 centimetres.

The velocity of the flow in the channel should be low enough to avoid erosion of the bed or banks, but high enough to prevent silting. The maximum velocity which can be safely allowed will depend on the erodibility of the soil or the lining material. Local experience is often needed to determine which velocities can be used for particular soils. Clear water is more erosive than muddy water. Suggested velocities are also given in Table 4.

FIGURE 24. Cross-section of canal.

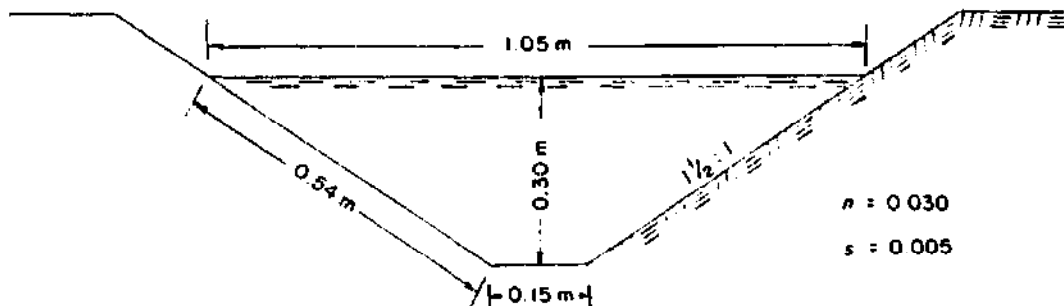

$$\text{Area} = 0.18 \text{ square metre}$$

$$\text{Wetted perimeter} = 1.23 \text{ metres}$$

$$r = 0.146 \text{ metre}$$

$$r^{\frac{2}{3}} = 0.277$$

$$\frac{1}{s^{\frac{1}{2}}} = 0.0707$$

$$Q = A \frac{r^{\frac{2}{3}}}{n} s^{\frac{1}{2}}$$

$$= 0.18 \times \frac{0.277}{0.030} \times 0.0707$$

$$= 0.118 \text{ cubic metre per second or 118 litres per second}$$

$$v = \frac{Q}{A} = \frac{0.118}{0.18} = 0.65 \text{ metre per second}$$

Because of the large number of combinations of shape, slope and roughness that are possible, it is not feasible to prepare tables showing capacities of ditches. A number of graphs and tables of one-half and two-thirds powers of number have been prepared to aid in solving the Manning formula. These are available in most of the standard handbooks on hydraulics, such as the one by King (1963). A process of trial and error is generally used to find the correct size of channel for a given set of conditions. An example of the solution of the Manning formula is given for the earthen ditch shown in Figure 24. If the capacity determined by the first trial is too large or too small the dimension can be altered and a new capacity computed, until the proper size to deliver the required amount of water is obtained.

### **Control structures for ditches**

Irrigation water must be always under control. Structures designed for regulating flow will help provide control and also reduce the work involved in irrigating crops. They deliver the correct amount of water into the field ditches from the main canal, and control it until it is released on to the fields. The number and type of structures required will depend on the type of ditch, the slope, and the obstacles encountered in conveying the water to its ultimate delivery.

### **CANAL OUTLETS**

Where water is obtained from a large canal system, some type of gate must be used for releasing and controlling the amount to be delivered into the field ditch. The two types normally used can be classified as an overflow gate, similar to a weir, or an underflow gate which is a sort of orifice. The primary difference between the two is in the control they provide in maintaining a nearly uniform flow when fluctuations occur in the water level of the supply canal. Flow over a weir-type gate varies as the three-halves power of the pressure head, whereas flow through an orifice-type gate varies as the one-half power of the pressure head. It is therefore possible to obtain more uniform flow through undershot or orifice-type gates than through overflow gates, when fluctuations are likely in the water level of the canal from which the water is taken

Overflow gates are usually rectangular box-like structures with grooves in the sidewalls into which flashboards can be placed (Figure 25). The overflow section is similar to a weir crest, the height of which can be adjusted by adding or removing boards. When the boards are higher than the water surface in the canal, the structure serves as a gate to stop the flow.



FIGURE 25. Control gate made of precast concrete blocks, in unlined canal.

Underflow gates may be similar, except that a solid wood or metal gate is raised or lowered to control the flow under the gate (Figure 26). Another type makes use of a pipe placed through the ditch bank with a sliding control gate on the inlet end. The pipe should be slightly lower than the bottom of the field ditch into which the water is released. Having the outlet submerged will help dissipate the energy of the moving water as it leaves the pipe, reducing erosion in the ditch.

It is important that all gates releasing water from main canal systems be properly installed. Failure of these structures can cause serious flooding of agricultural lands and loss of valuable water supplies. The walls of the gate structures should be securely tied into the banks of the canal by means of cutoff walls so that leakage cannot occur. The gates should be solidly built so that they will be safe from structural failure. Concrete



FIGURE 26. Underflow control gates set in concrete headwall, for releasing water into field ditches or pipelines.

or rock riprap walls should be used above and below the gate to protect the canal banks from erosion.

Automatic controls are an efficient means of regulating the rate of flow into field ditches and of maintaining constant water levels in the main canal system (Figure 27). Where conditions allow the installation of these controls in the network system many of the problems associated with manually controlled gates are eliminated. Automatic controls usually require an abundant supply of water at the source or a regulating reservoir at the head of the distribution system. Methods for automating irrigation systems are discussed in FAO Irrigation and Drainage Paper No. 5 (1971a).

#### DIVISION BOXES

It is often necessary to divert the irrigation water from one field ditch to another, or divide a stream between two or more ditches. This is commonly the case when several owners make use of the same ditch. Concrete structures are generally installed for this purpose. They are usually box-like structures with two or more outlets for the water. The width of each outlet is in proportion to the division of water which is to be made. Gates are required for closing or regulating the flow into each separate ditch.

#### CHECKS

Structures placed across field ditches to control the water level are called checks. These are used to raise the water level to the elevation that will release the required amount of water on to the field. The checks also serve as dams, which when necessary can confine the water to a part of the ditch in order to release it only on to the section of the field being irrigated at the time.

The spacing of checks depends on the slope of the ditch and the amount of water being carried, and the amount of water determines the width of field which can be irrigated at one time (Figure 28). It is desirable that the water level be kept at nearly the same height above the ground surface for the width of the field being irrigated, to permit an equal flow into each of the basins, strips or furrows (Figure 29).

Permanent gates may be used as checks in lined ditches, or in earthen ditches which are to be used for a number of years (Figure 30). They may be equipped with flashboards or undershot sliding gates to control the water level. The bottom of the checks should be level with the bottom of the ditch so that, when open, they can drain all the water from the ditch. They should also be large enough to keep resistance to the flow at a minimum.



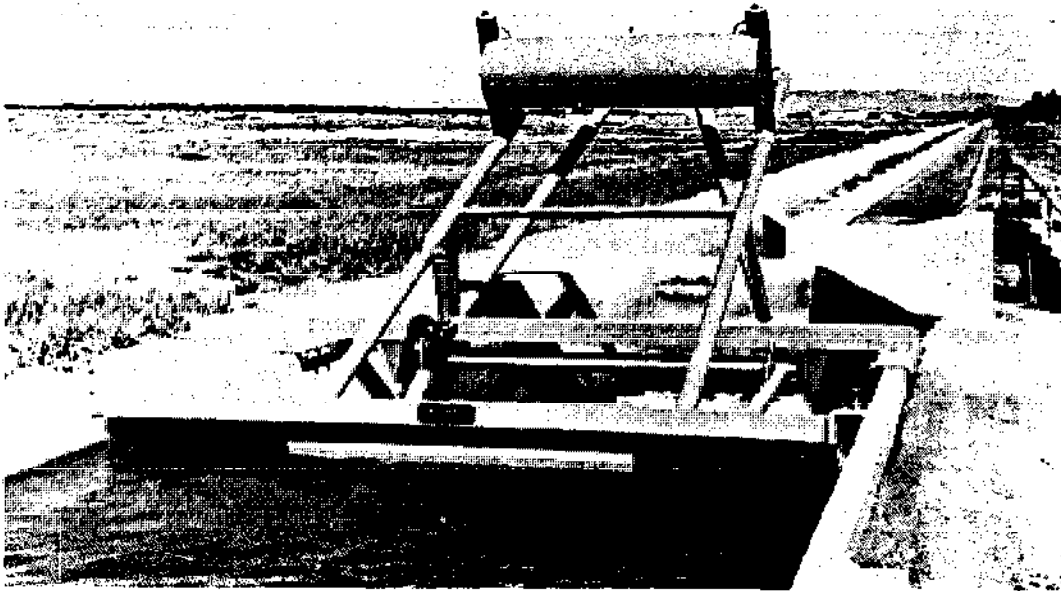

FIGURE 27. Constant-upstream-level Neyrpic automatic gate in the main canal.

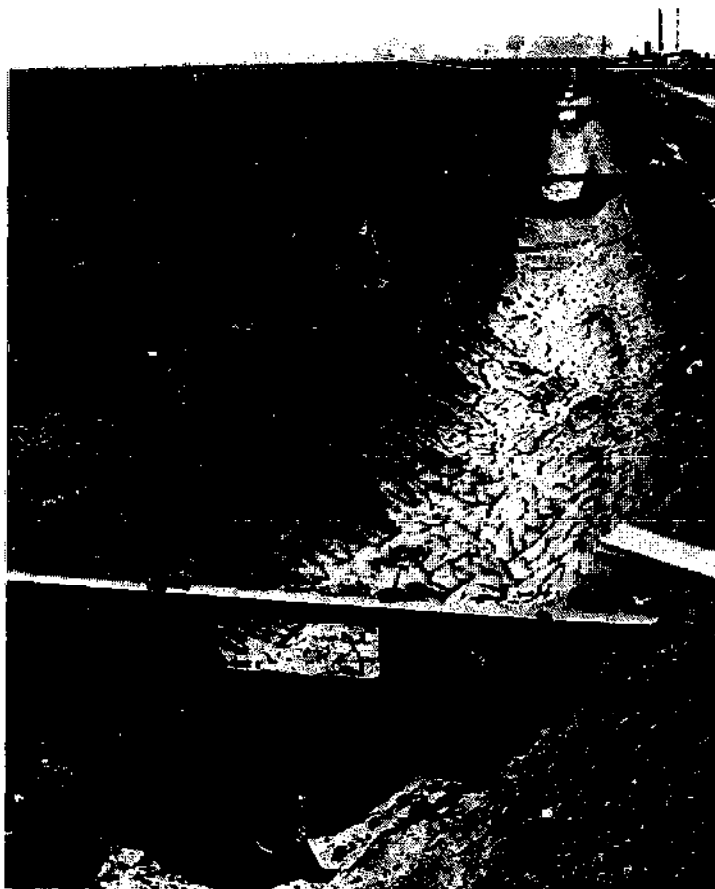
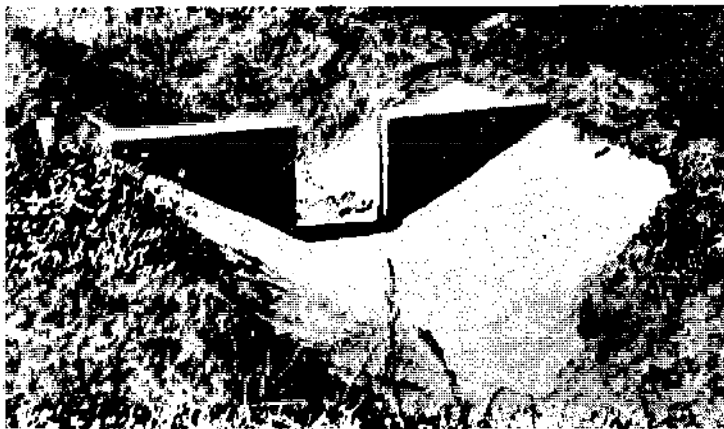

FIGURE 28. Wooden checks in earthen ditch. Flashboards control the flow of water.



**FIGURE 29.** Concrete check gate placed in earthen ditch. Grooves permit using flashboards for checking flow of water, or directing the flow into different laterals.

Portable dams made of canvas (treated to reduce rotting), heavy plastic or rubber sheeting are often used in earthen ditches as checks. These flexible dams are supported by a pipe or wooden crosspiece laid across the banks of the ditch (Figure 31). A notch is sometimes provided in the upper edge of the dam below the crosspiece to serve as a spillway. By



**FIGURE 30.** Concrete check dam in earthen ditch. Concrete aprons above and below the check help prevent seepage losses and erosion.

rolling the material around the crosspiece the elevation of the spillway can be adjusted to control the water level. Being portable, these dams can be removed so that machines can clean and repair ditches without having to bypass permanent check structures.

Removable metal gates are sometimes used as checks in concrete-lined ditches. Permanent slots are made in the concrete lining into which the gates can be inserted. Metal dams, of such size and shape that they can be placed at an incline and form a tight fit with the bottom and sides of the lined ditch, are also used. The pressure of the water helps hold these in place.

## DROPS

Ditches on land with considerable slope require drop structures. These permit the ditch to be constructed as a series of relatively flat channels, each at a different elevation. The water is lowered from one section to the next by means of the drop structures. They are generally spaced so that the difference in elevation at each drop does not exceed 50 centimetres.

FIGURE 31. Portable canvas dam in earthen ditch.

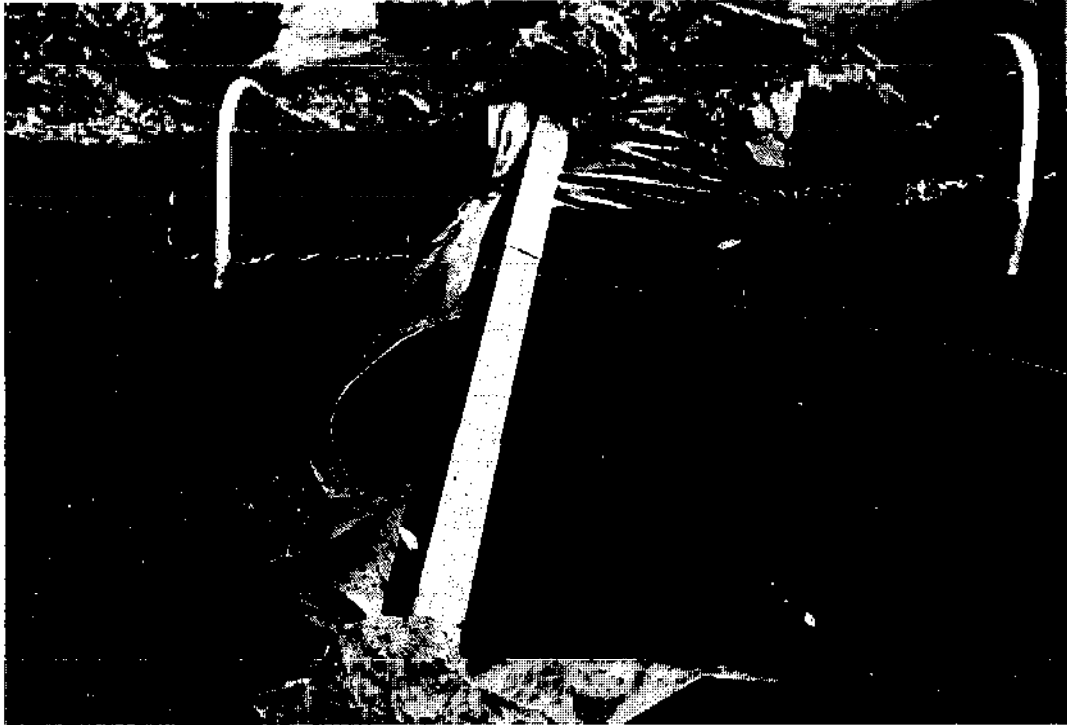

The main function of a drop is to dissipate the energy of the falling water so that it does not erode the ditch. A stilling basin or a concrete or rock apron is generally used to absorb this energy.

The drops may also serve as checks in the ditch in which case they are usually built like box gates, except that the floor of the outlet sections is at a lower elevation than the inlet section. The flashboards serve as an overflow crest when the water is being ponded above the structure. Cutoff walls are generally necessary to prevent undercutting by the water.

Another method drops the water through a section of pipe containing a right-angled elbow, as shown in Figure 32. Steel piping permits welding of the angle and offers good resistance to erosion by the falling water. Pipes of precast concrete and other materials are also used. Their diameter should be such that the water velocity will not be excessive, and still sufficient to transport any suspended materials. The outlet is submerged to help dissipate the energy of the water as it leaves the pipe. A short section of close-fitting pipe can be placed vertically over the inlet as a check, and also as a spillway. Care must be taken to prevent trash from clogging the pipe. Drop structures of this nature can also be used for crossing roads.

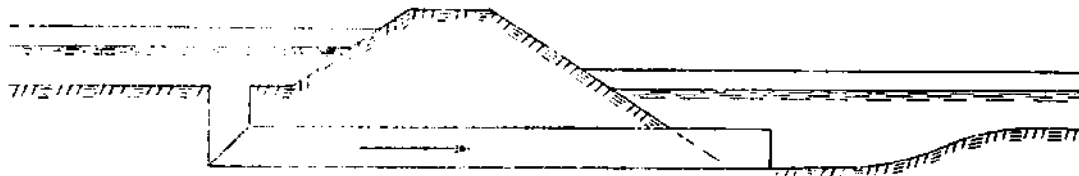

FIGURE 32. Pipe drop structure for field ditches.

With either type of drop structure the water emerging from the outlet is likely to form eddy currents, which can erode the ditch below. A concrete lining or rock riprap placed in the ditch for a short distance below the drop will help confine the water until the flow is uniform.

#### OTHER STRUCTURES

Excavated ditches will not serve when water must be transported across stream channels, depressions or difficult terrain. In these cases flumes, pipelines, inverted siphons or earth fills are used to convey the water between connecting ditch sections to maintain the desired grade elevation.

Flumes constructed of wood, metal or concrete are often used where

the water must be carried a considerable distance. Beams or rails between supporting piers are needed to carry the weight of the flume and the water. Since efficiency of design is important, a qualified engineer should be employed to prepare the plans for any major flume installation.

Exposed pipe supported on a substructure is also used for transporting water across low areas. Steel or corrugated metal pipe can be used for short spans without the need for trusses between piers. The length of unsupported span which can be safely used with the pipe full of flowing water will depend on the diameter, gauge and type of pipe; this information can be furnished by the manufacturer. Entrance and exit sections are needed to connect the pipe to the open ditch. It should be installed at a slightly lower elevation than the ditch so that it always carries a full flow of water.

Earth fills can be placed across low areas to raise the ditch. The earth in such fills should be well compacted to provide stability. Raised ditches require careful maintenance to prevent leaks, and are often lined for extra protection. Some means must also be provided for diverting storm waters which might collect on the higher side of the fill.

#### INVERTED SIPHONS

Where water carried in open ditches must be conveyed across roadways or other obstructions, an inverted siphon is sometimes used. This is a buried closed conduit which carries the water under pressure beneath the roadway, as shown in Figure 33. Inverted siphons are often more satisfactory for carrying traffic across ditches than are bridges or culverts, especially where the ditch banks are considerably higher than the ground surface. Inverted siphons are also used for conveying water beneath other canals or stream channels where the substructure required for supporting a pipe or flume crossing would not be practical.

An inverted siphon may be a concrete box structure or a pipe. Steel or precast concrete pipes are often used. The conduit should be strong

FIGURE 33. Cross-section of an inverted siphon placed under a roadway.

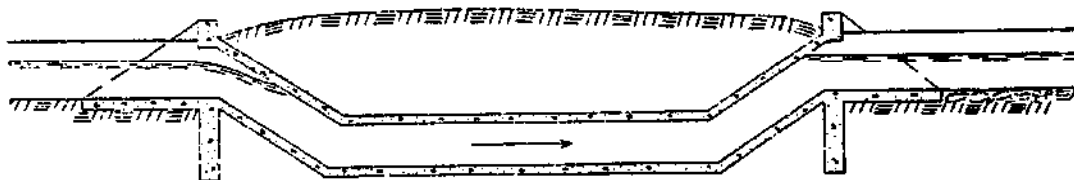

enough to support the bearing load of vehicles passing over it and to withstand the internal hydrostatic pressure of the water.

A common mistake in the construction of inverted siphons is the use of conduits too large for the water flow. Suspended matter carried by the water is then often deposited at the bottom. The siphon should be small enough to ensure that the velocity of the water will transport the suspended material, yet not so small that hydraulic losses will be excessive.

Transition sections at the inlet and outlet ends will help reduce the pressure head required to cause the water to flow through the siphon. This will also help reduce turbulence, which might cause erosion of the ditch banks as the water leaves the siphon.

## OUTLETS

The devices used for releasing the irrigation water from the ditch on to the field are called outlets. Their purpose is to control the amount of water being diverted into each basin, strip or furrow. They should be easy for the irrigator to operate, and should provide protection against erosion of the ditch bank or the surface of the field at the point of release.

The choice of outlet will depend on the method of irrigation being used. This is discussed in the chapters dealing with the different systems of irrigation.

## 5. PIPED DISTRIBUTION SYSTEMS

Pipelines offer a number of advantages over open ditches for the distribution of irrigation water. They are comparable with concrete-lined ditches in reducing seepage losses. Evaporation losses can be eliminated. The problem of weed control along ditch banks does not exist. The area that would otherwise be occupied by open ditches can be sown to crops. No space is needed for the turning of cultivating equipment at the edges of the field. They usually require less labour for irrigation work than open ditches. Increased use is being made of pipelines in areas where water savings, costs and/or shortage of labour or the full use of all irrigable land are important considerations. Pipelines also permit the conveyance of water uphill against the normal slope of the land and, unlike open ditches, they do not have to be installed on a uniform grade.

### Types of pipe

Several different kinds of pipe are used in surface irrigation systems. Because the water does not usually have to be carried in the pipelines under high pressure, as with sprinkler systems, a number of special types of pipe have been developed. Most of these make use of portland cement concrete in some form.

Nonreinforced concrete pipe which is precast in short lengths is the most widely used type of low-pressure irrigation pipeline. It is manufactured at a central plant from which it is hauled to the place of installation. Skilled workmen lay the pipe in a prepared trench and install the necessary outlets and control structures. The short sections may be connected with concrete mortar joints (Figure 34), or the pipe may be constructed with bell-ends, permitting the use of rubber or plastic rings to seal the joints. This type of pipeline is normally used where internal hydrostatic pressures do not exceed about 6 metres of water for pipe diameters up to 45 centimetres, and 5 metres of water pressure for diameters up to 60 centimetres. The pressure at any point along the pipeline is the height that water would rise in an open column if attached to the pipe at that point.

Where higher pressures or greater strength to resist external loading are required, pipe with reinforced concrete or extra-thick walls can be used. This adds considerably to costs, and the use of such pipe for field distribution systems is limited to exceptional situations where the extra expense is justified. Steel-reinforced pipe must be manufactured with special equipment designed for the purpose. It is generally made in longer lengths than unreinforced precast pipe.

Asbestos-cement pipe, with asbestos fibres to provide added tensile strength to the concrete, is also used. This type of pipe is now being manufactured with thin walls especially for use with low-pressure irrigation systems. It is available in various strengths for a wide range of pressure conditions. Although more costly than precast unreinforced concrete pipe it is lighter, so it is sometimes used where the pipe must be transported long distances.



**FIGURE 34.** Workman installing precast concrete pipe in trench.



Both steel-reinforced concrete pipe and asbestos-cement pipe make use of reinforced collars for joining the individual lengths in the trench. Some type of rubber gasket is generally used as a seal in the joints. This provides a certain amount of flexibility, which is an advantage where soil settlement, earth tremors, thermal contraction from cold water or other factors are likely to cause cracks in rigid pipe.

Another type of concrete pipe which has been developed for low-pressure systems is cast in place (Figure 35). This is an unreinforced pipe which is constructed directly in the trench. The bottom of the trench is carefully shaped and serves as the form for the lower outside of the pipe. Portable steel forms are used for the inside crown, and slip-forms are used to shape the invert and upper outside faces. Another method makes use of an inflated rubber tube for the inside form of the pipe. Special machines which are pulled along the trench have been developed for placing this type of

FIGURE 35. Cast-in-place concrete pipeline being constructed in trench. The wet concrete is supplied by an agitator truck from a centrally located mixing plant. The steel forms on the left bank are used to support the arch of the pipe until the concrete has set. The concrete placed in the hopper flows through the machine to form the entire pipeline in one operation. A riser outlet pipe can be seen in the foreground.



pipe. The machine contains a hopper for the wet concrete and vibrators which cause this to flow around the entire circumference of the pipe. A similar pipe is constructed in two sections by hand. The bottom half is poured first, with a sled-type screed used to shape the invert. The upper half is then poured using steel forms to support the crown. Because the steel forms inside must be removed, cast-in-place pipe is usually made in sizes of from 60 to 100 centimetres in diameter so that a man can enter the pipe to clear the forms. Cast-in-place concrete pipe should not be used where the internal hydrostatic pressure exceeds 2.4 metres of water above the centre line of the pipe. Specifications for cast-in-place concrete pipe have been prepared by the American Concrete Institute (1969).

Special sulfate-resistant cement should be used for making all types of concrete pipe if the water to be carried or the soils in which the pipe is to be placed contain excessive sulfur.

Steel, aluminium, butyl rubber and plastic pipes are also used to a limited extent in surface irrigation systems. Steel and aluminium pipelines should be protected by coating and wrapping when buried in saline or acid soils, which can rapidly corrode the metals. Cathodic protection, which is an induced flow of direct electrical current from buried electrodes to the pipe, as described by Dutt and Booher (1971), has also been used in cases where serious corrosion might otherwise occur. Plastic pipe should always be buried to protect it from sunlight, which can deteriorate the plastic materials commonly used for making low-pressure pipes.

### **Costs**

To determine whether the use of pipelines is justified, the costs should be compared with those of open ditch or flume systems. The factors to be considered include: fixed costs such as interest and depreciation on the investment, water savings from reduced seepage losses, relative costs for maintenance and weed control, yield of crops that can be grown on the land occupied by ditches, and reduction in labour costs resulting from better control of the water.

The relative costs of pipelines and lined ditches will depend on the availability of materials and skilled workmen who can do the construction work. As a general rule, the investment costs for installing precast unreinforced concrete pipe are comparable with concrete-lined ditches for capacities less than 85 to 140 litres (3 to 5 cubic feet) per second. For larger flows the costs of cast-in-place concrete pipe are comparable with concrete-lined ditches for capacities up to 850 litres (30 cubic feet) per second.

Aquatic weeds and algae will not grow in pipelines. However, the roots of some trees will grow through cracks in the pipelines and develop into fibrous masses which can plug the lines. Water diverted into pipelines from open ditches may contain floating materials which can plug the lines and outlet structures. This may require screens at the entrance to the pipelines. These factors should be taken into consideration in comparing costs for weed control on open ditches.

Buried pipelines can develop cracks and leaks which are sometimes difficult to locate and repair. Annual maintenance costs for concrete pipelines may amount to as much as 5 percent of the original installation costs. The quality of the pipe used, and the care taken in installing and operating it to reduce possible failures, are therefore important considerations.

### **Types of pipeline systems**

The most suitable situation for a pipeline is where the water level in the canal or other source is sufficiently higher than the land to provide the pressure needed to overcome the friction in the pipes and yet not develop pressures which are excessive for the type of pipe being used.

Where the land to be irrigated lies above the water source, a pump must be used to lift the water and overcome the friction losses. The pipe selected must be strong enough to withstand the pressure that the pump develops.

Where the land has considerable slope away from the water source, excessive pressures must be prevented from developing in the pipeline. Open-top stands equipped with baffles or weirs, as shown in Figure 36, offer one solution; the pressure in the pipeline above a stand is limited by the elevation of the surface of the water flowing over the baffle. If the water delivered into the pipeline is more than is needed for irrigation, the excess will overflow the baffles and be eventually wasted at the end of the pipeline. Surging or nonuniform flow sometimes develops in pipelines where baffles are used. The surge may be amplified as the water flows over successive weirs. Spacing the baffles at irregular intervals will help break up the harmonics of the surging. Vents placed a short distance below each baffle will release air which might become entrapped in the falling water.

Automatic float-controlled valves in the stands (Figure 37) can prevent excess pressures and also facilitate the taking of water from the pipeline. These systems are used generally where the water is supplied from a reservoir or other source which permits taking water as needed. When water is taken from the pipeline below a stand, the water level in the stand is lowered; this opens the valve and allows the water to flow in from the pipeline

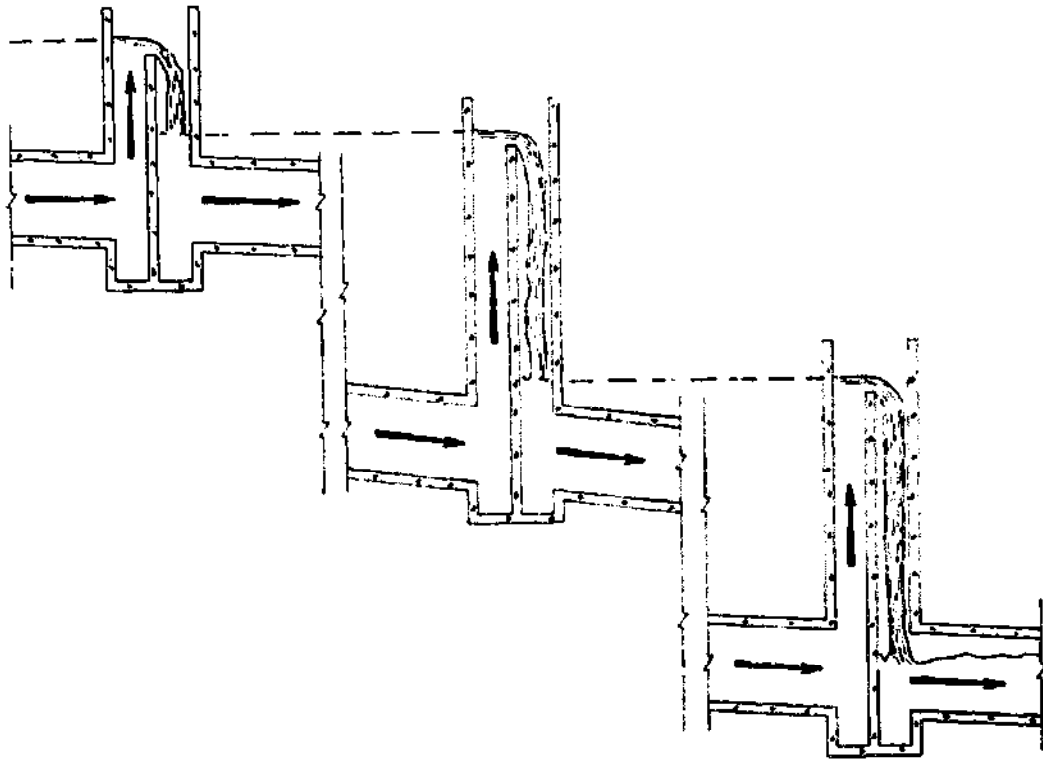

FIGURE 36. Profile of overflow stands with baffles, used with open pipeline system.

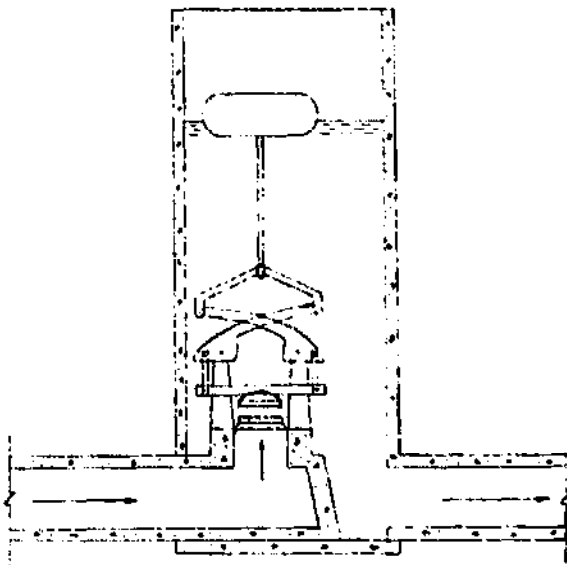

FIGURE 37. Automatic float-controlled valve in pipe stand.

above. When no water is being used the valves remain closed, stopping the flow of water in the system. Placing the floats at elevations which correspond to overflow baffles can control the pressure in the pipeline.

### Friction losses

Friction losses are related to the roughness of the pipe and the square of the velocity of flow in the pipe. These losses are proportional to the length of the pipeline and vary inversely with the inside diameter.

A number of different equations, derived from experiments, have been developed for computing friction losses in pipelines. Tables based on these equations are convenient for determining the size of pipe required for a given set of conditions. The friction losses for concrete pipe are given in Table 5, for asbestos-cement pipe in Table 6, for steel pipe in Table 7, and for plastic pipe in Table 8. These tables are based on the Hazen-Williams equation

$$H_f = 4.75 \frac{L Q^{1.851}}{C^{1.851} D^{4.869}}$$

where  $H_f$  is the head loss due to friction, in unit depth of water per unit length;  $L$  is the length of pipe in feet for which the friction losses are computed;  $Q$  is the flow rate, in cubic feet per second;  $C$  is a coefficient for friction; and  $D$  is the diameter of the pipe, measured in feet.

The examples of typical field problems which follow show how the tables can be used.

*Example 1:* A concrete pipeline is to be installed to carry 50 litres per second so that the friction loss will be equal to the slope of the land. The alignment where the pipe will be laid has a uniform slope of 0.3 percent (0.3 metre per 100 metres). Table 5 shows that a 30-centimetre pipeline carrying 51 litres per second will have a friction loss of 0.28 metre per 100 metres; this would be the pipe diameter to use.

*Example 2:* An unreinforced concrete pipeline is to be used to deliver 90 litres per second for a distance of 400 metres where the land has an upward slope of 0.5 percent, and it is desired to limit pressure in the pipeline to 5 metres of water pressure. The difference in elevation for which the water is to be lifted is  $0.005 \times 400 = 2$  metres. The additional pressure which can be utilized in overcoming friction is  $5 - 2 = 3$  metres, which for 400 metres of pipe is 0.75 metre per 100 metres. The friction

TABLE 5. - FRICTION LOSS IN CONCRETE PIPE ( $C = 100$ )

Flow rate ( $Q$ )		Diameter of pipe ( $D$ )										
		20 cm (8 in)	25 cm (10 in)	30 cm (12 in)	35 cm (14 in)	40 cm (16 in)	45 cm (18 in)	50 cm (20 in)	60 cm (24 in)	75 cm (30 in)	90 cm (36 in)	105 cm (42 in)
		..... Metres per 100 metres; feet per 100 feet .....										
Litres per second	Cubic feet per second											
2.8	0.1	0.01										
5.7	0.2	0.03										
8.5	0.3	0.07										
11.3	0.4	0.12	0.04									
14.2	0.5	0.19	0.06									
17.0	0.6	0.26	0.09	0.04								
22.7	0.8	0.45	0.15	0.06								
28.3	1.0	0.68	0.23	0.09	0.04							
34.0	1.2	0.95	0.32	0.13	0.06							
39.6	1.4	1.23	0.43	0.18	0.08	0.04						
45.3	1.6	1.62	0.55	0.22	0.11	0.06						
51.0	1.8	2.02	0.68	0.28	0.13	0.07						
57.0	2.0	2.45	0.83	0.34	0.16	0.08	0.05					
68.0	2.4	3.43	1.16	0.48	0.22	0.12	0.07					
79.0	2.8	4.57	1.54	0.63	0.30	0.16	0.09	0.05				
91.0	3.2	5.85	1.97	0.81	0.38	0.20	0.11	0.07				
102.0	3.6	7.27	2.46	1.01	0.48	0.25	0.14	0.08	0.04			
113.0	4.0	8.84	2.98	1.23	0.58	0.30	0.17	0.10	0.04			
127.0	4.5		3.71	1.53	0.72	0.38	0.21	0.13	0.05			
142.0	5.0		4.51	1.86	0.88	0.46	0.26	0.15	0.06			
156.0	5.5		5.38	2.21	1.05	0.55	0.31	0.18	0.08	0.03		
170.0	6.0		6.32	2.60	1.23	0.64	0.36	0.22	0.09	0.03		
184.0	6.5		7.33	3.02	1.42	0.74	0.42	0.25	0.10	0.04		
198.0	7.0		8.41	3.46	1.63	0.85	0.48	0.29	0.12	0.04		
227.0	8.0			4.43	2.09	1.09	0.62	0.37	0.15	0.05		
255.0	9.0			5.51	2.60	1.36	0.76	0.46	0.19	0.06		
283.0	10.0			6.69	3.16	1.65	0.93	0.56	0.23	0.08		
340.0	12.0			9.38	4.43	2.31	1.30	0.78	0.32	0.11	0.04	
396.0	14.0				5.89	3.08	1.73	1.04	0.43	0.14	0.06	
453.0	16.0				7.54	3.94	2.22	1.33	0.55	0.18	0.08	
510.0	18.0					4.90	2.76	1.65	0.68	0.23	0.09	
566.0	20.0					5.95	3.35	2.01	0.83	0.28	0.12	0.05

TABLE 6. - FRICTION LOSS IN ASBESTOS-CEMENT PIPE ( $C = 145$ )

Flow rate ( $Q$ )		Diameter of pipe ( $D$ )							
		7.5 cm (3 in)	10 cm (4 in)	12.5 cm (5 in)	15 cm (6 in)	17.5 cm (7 in)	20 cm (8 in)	25 cm (10 in)	30 cm (12 in)
<i>Litres per second</i>	<i>U.S. gallons per minute<sup>1</sup></i>	<i>..... Metres per 100 metres; feet per 100 feet .....</i>							
0.6	10	0.04	0.01						
1.3	20	0.13	0.03	0.01					
1.9	30	0.27	0.07	0.02					
2.5	40	0.46	0.12	0.04					
3.2	50	0.70	0.18	0.06	0.03				
4.4	75	1.48	0.39	0.12	0.06				
6.3	100	2.53	0.66	0.21	0.10				
7.9	125	3.82	1.00	0.32	0.15				
9.5	150	5.34	1.40	0.44	0.21	0.09			
11.0	175	7.08	1.85	0.59	0.27	0.11			
12.6	200	9.10	2.38	0.76	0.35	0.15	0.08		
15.8	250	13.76	3.60	1.14	0.53	0.22	0.13		
19.0	300	19.26	5.04	1.60	0.75	0.31	0.18	0.06	
22.0	350	25.61	6.70	2.13	0.99	0.41	0.24	0.07	
25.2	400		8.60	2.73	1.27	0.53	0.30	0.09	
28.4	450		10.69	3.40	1.58	0.66	0.38	0.12	
31.6	500		12.98	4.12	1.92	0.80	0.46	0.14	0.06
37.9	600		18.17	5.77	2.69	1.12	0.64	0.20	0.08
44.2	700		24.19	7.68	3.58	1.49	0.86	0.26	0.11
50.5	800		30.99	9.84	4.58	1.91	1.10	0.34	0.14
56.9	900			12.21	5.69	2.37	1.36	0.42	0.17
63.2	1 000			14.88	6.93	2.89	1.66	0.51	0.21
76.0	1 200			20.79	9.68	4.04	2.31	0.71	0.29
88.5	1 400			27.72	12.91	5.39	3.08	0.95	0.39
101.0	1 600				16.53	6.90	3.95	1.22	0.50
113.8	1 800				20.60	8.60	4.92	1.52	0.62
126.0	2 000				24.99	10.43	5.97	1.84	0.76

<sup>1</sup> 1 imperial gallon per minute = 1.2 U.S. gallons per minute

TABLE 7. - FRICTION LOSS IN WELDED STEEL PIPE ( $C = 120$ )

Flow rate ( $Q$ )		Nominal pipe diameter ( $D$ )							
		5 cm (2 in)	7.5 cm (3 in)	10 cm (4 in)	12.5 cm (5 in)	15 cm (6 in)	20 cm (8 in)	25 cm (10 in)	30 cm (12 in)
<i>Litres per second</i>	<i>U.S. gallons per minute</i>	..... Metres per 100 metres; feet per 100 feet .....							
0.6	10	0.3	0.1						
1.3	20	1.1	0.2						
1.9	30	2.4	0.3	0.1					
2.5	40	4.1	0.6	0.2					
3.2	50	6.3	0.9	0.2	0.1				
4.4	75	13.1	1.9	0.5	0.2				
6.3	100	22.5	3.2	0.9	0.3	0.1			
7.9	125	34.0	4.8	1.3	0.4	0.2			
9.5	150	47.5	6.7	1.8	0.6	0.2			
11.0	175		8.9	2.4	0.8	0.3	0.1		
12.6	200		11.5	3.1	1.0	0.4	0.1		
15.8	250		17.3	4.7	1.5	0.6	0.2		
19.0	300		24.3	6.5	2.2	0.9	0.2		
22.0	350		32.3	8.7	2.9	1.2	0.3	0.1	
25.2	400		41.4	11.1	3.7	1.5	0.4	0.1	
28.4	450			13.9	4.6	1.9	0.5	0.2	
31.6	500			16.8	5.6	2.3	0.6	0.2	0.1
37.9	600			23.6	7.8	3.2	0.8	0.3	0.1
44.2	700			31.4	10.4	4.3	1.1	0.4	0.2
50.5	800			40.2	13.3	5.5	1.4	0.5	0.2
56.9	900				16.5	6.8	1.8	0.6	0.3
63.2	1 000				20.1	8.3	2.2	0.7	0.3
76.0	1 200				28.1	11.6	3.0	1.0	0.4
88.5	1 400				37.5	15.4	4.0	1.3	0.6
101.0	1 600					19.7	5.2	1.7	0.7
113.8	1 800					24.6	6.5	2.1	0.9
126.0	2 000					29.8	7.8	2.6	1.1



TABLE 8. - FRICTION LOSS IN LOW-HEAD RIGID POLYVINYL CHLORIDE (PVC) PIPE (C = 150)

Flow rate (Q)		Nominal pipe diameter (D)					
		10 cm (4 in)	15 cm (6 in)	20 cm (8 in)	25 cm (10 in)	30 cm (12 in)	37.5 cm (15 in)
<i>Litres per second</i>	<i>U.S. gallons per minute</i>	<i>..... Metres per 100 metres; feet per 100 feet .....</i>					
3.2	50	0.16					
6.3	100	0.58	0.08				
9.5	150	1.23	0.17				
12.6	200	2.10	0.29	0.07			
15.8	250	3.17	0.44	0.11			
19.0	300	4.45	0.62	0.15	0.05		
22.0	350	5.91	0.82	0.20	0.07		
25.2	400	7.57	1.05	0.26	0.09		
28.4	450	9.42	1.31	0.32	0.11	0.04	
31.6	500	11.45	1.59	0.39	0.13	0.05	
37.9	600		2.23	0.55	0.18	0.08	
44.2	700		2.96	0.73	0.25	0.10	
50.5	800		3.79	0.94	0.32	0.13	
56.9	900		4.72	1.16	0.39	0.16	0.05
63.1	1 000		5.73	1.41	0.48	0.20	0.07
76.0	1 200		8.04	1.98	0.67	0.28	0.09
88.5	1 400		10.69	2.63	0.89	0.37	0.12
101.0	1 600			3.37	1.14	0.47	0.16
113.0	1 800			4.19	1.42	0.58	0.20
126.0	2 000			5.10	1.72	0.71	0.24
151.0	2 400			7.14	2.41	0.99	0.34
177.0	2 800			9.50	3.21	1.32	0.44
202.0	3 200				4.10	1.69	0.57
227.0	3 600				5.10	2.10	0.71
252.0	4 000				6.20	2.55	0.86

loss, as shown in Table 5, for a 30-centimetre pipeline carrying 91 litres per second is 0.81 metre per 100 metres, so a 35-centimetre pipeline should be used. The maximum pressure in the pipeline will be  $4 \times 0.37 + 2 = 3.48$  metres.

*Example 3:* A concrete pipeline is to carry water across level land for a distance of 800 metres from a well pump which discharges 200 litres per second, and it is desired that the maximum pressure in the line should not exceed 4.5 metres of water. What size of pipeline should be used, and how high should the standpipe be at the pump? The pressure available for overcoming friction will be  $4.5 \div 8 = 0.56$  metre per 100 metres. Table 5 shows that a 45-centimetre pipe should be used, with a friction loss of 0.48 metre per 100 metres. The water will rise  $8 \times 0.48 = 3.84$  metres in the standpipe at the pump when the water is being delivered to the end of the pipe. Allowing for a freeboard of about 0.5 metre, the standpipe at the pump should be about 4.3 metres high.

### **Control structures for pipelines**

Controls are necessary to regulate the flow of water into pipelines, the pressure in the pipes and the release of water on to the fields to be irrigated.

#### **INLET GATES**

Where the water carried by the pipeline is obtained from an open canal, it is desirable that the water surface in the canal be sufficiently higher than the land to allow gravity flow into the pipeline and provide the pressure needed at the outlets. Otherwise a pump must provide the needed pressure. Where gravity flow can be used, the pipeline is connected directly to the canal. A submerged slide-gate placed in the side of the canal and connected to the inlet end can be used for controlling the flow of water into the pipeline. The gate should be mounted on a concrete headwall structure to provide stability and prevent leakage. The gate should have an opening of nearly the same size as the diameter of the pipeline so that entrance head losses can be kept to a minimum.

Weirs or flumes are sometimes incorporated in the inlet structure where it is necessary to measure the amount of water being taken from the canal into the pipeline. Rate of flow can also be measured by meter gates, which utilize the pressure drop through a long-tube orifice. Tables are available showing the flow rates through gates which have been calibrated

for various gate openings in relation to head loss. Propeller-type flow meters can also be placed in the pipeline to record total flow.

Screens are recommended for removing trash or moss that might enter the pipeline from a canal or reservoir. The screens may be installed as part of the inlet structure, or in a box structure below the turnout. The area of the screen should be such that the average velocity of the water through the box is limited to 0.15 metre per second. Double screens are sometimes used so that one can be cleaned while the other continues to function.

Sand traps may also be advisable when excessive amounts of sand or silt are carried in the canal water to be released into the pipeline. These are usually basins which are large enough to slow the water to the point that suspended particles settle out. The basins should be constructed so that they can be easily cleaned.

Where the irrigation water is obtained from a pump the flow is usually delivered into a standpipe before entering the pipeline. When the pipeline is lower than the discharge pipe of the pump, in order to avoid backflow of water into the pump the discharge pipe can be extended horizontally into the standpipe. Some type of flexible coupling is needed between the pump and the standpipe to prevent vibration from breaking the seal where the discharge pipe enters the standpipe. When the pipeline is higher than the pump the usual practice is to carry the discharge pipe over the top of the standpipe; otherwise, a backflow check valve will be needed in the discharge pipe.

#### FLOW-CONTROL GATES AND VALVES

The flow of water is regulated by slide gates in the standpipes or line valves in the pipeline, which can direct the flow of water into different lateral lines, or stop the flow into a section of the pipeline. These controls make it possible to repair the section of the pipeline lying below the gate without shutting down the entire system.

A typical slide gate is shown in Figure 38. The gate at the entrance to the section of the pipeline to be controlled is placed so that the pressure of water in the standpipe will help to keep the gate sealed. Several gates may be placed in one standpipe from which water is diverted into different connecting lateral lines.

A line-gate valve is shown in Figure 39. This is a simple gate valve with hub ends which can be connected to the concrete pipeline with mortared joints. These valves are useful where water is carried under considerable pressure and slide gates would necessitate tall standpipes.

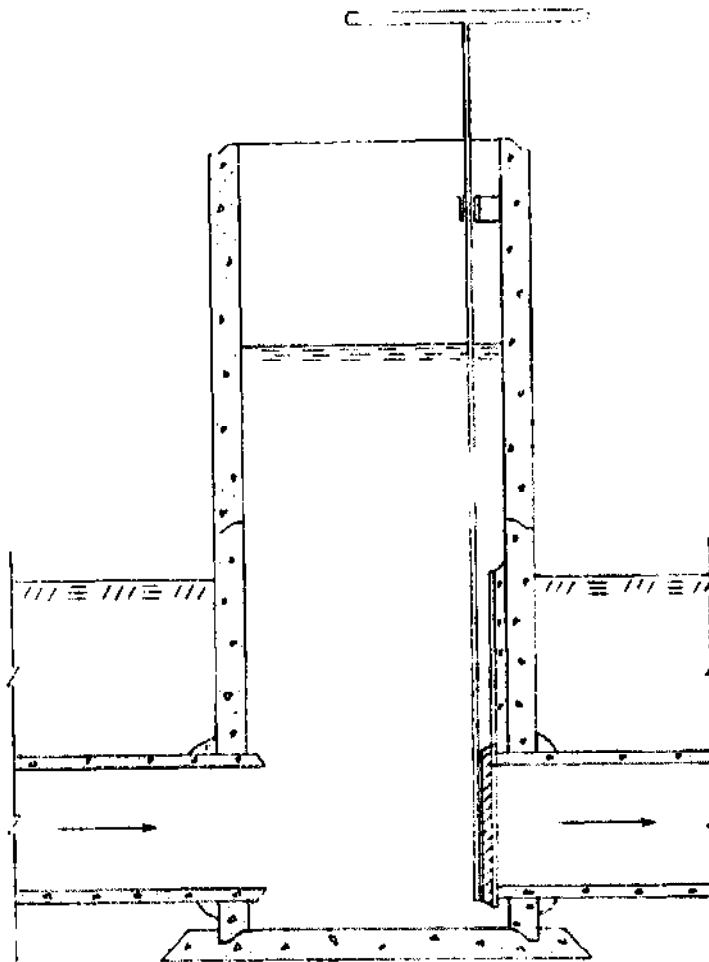

**FIGURE 38.** Slide gate placed in standpipe to regulate flow of water in pipeline.

**FIGURE 39.** Line-gate valve for concrete pipeline.

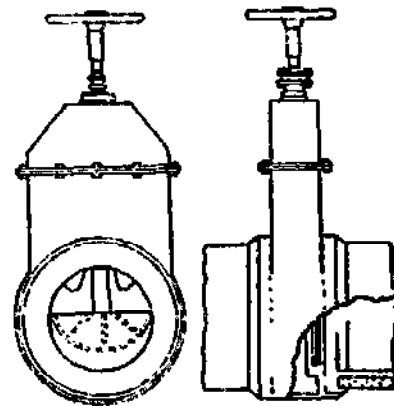

#### **AIR VENTS**

Air vents should be installed where air might collect in the lines. They are normally located at all high points, at sharp turns, where lines inter-

connect, and at the ends of the pipelines. Sometimes they are also placed at intervals of about 200 metres on straight pipelines with uniform slopes.

Where venting only is required, vertical pipes of about 15-centimetre diameter can be connected to the lines. Where access to the pipeline or the installation of slide gates is necessary, concrete standpipes at least 75 centimetres in diameter may also serve as air vents. The vents should be high enough to provide a freeboard of at least 60 centimetres above the maximum height to which water will rise at that point under normal operation.

Pipelines designed to operate under higher pressures than can be conveniently served by open air vents should have air-escape valves placed at critical points. These are usually spring-operated valves set to open whenever excess pressures develop in the pipeline. Excess pressures are usually caused by surging, resulting from air entrapment or compression of the air when the pipeline is being filled with water.

Drains or blowoffs may be installed at low points to permit emptying or flushing of the pipelines.

## OUTLETS

The devices that release water on to the fields are an important feature of any pipeline system. They should be easy to open and close, of the correct size to provide the flow required, and so constructed that the water released will not cause soil erosion. Most outlets consist of a riser pipe to bring the water from the buried pipeline to the surface, and an attached valve to control the flow.

Where large flows are required, as in basin or border-check irrigation, a valve with an opening the same size as the riser pipe is usually attached to the top of the riser. These are generally opened and closed by a screw-type shaft. The alfalfa valve shown in Figure 40 is an example of this type of outlet. The head losses through alfalfa valves of various sizes are given in Table 9. Additional pressure must be available in the pipeline to overcome the head loss through the valve. The general practice is to limit this additional pressure requirement to about 30 centimetres above the ground surface. Releasing the water under low pressure assures that it will be discharged from the valve with a low velocity. The correct valve size should be selected to deliver the required volume of water. For example, if it is planned to deliver 50 litres per second (800 gallons per minute) into a border strip, a 20-centimetre alfalfa valve would be required. To release 400 litres per second (6 400 gallons per minute) into a large basin, a 60-centimetre valve would be needed if the pressure head loss is to be limited to 30 centimetres.

The larger valves are often constructed with a steel frame above the valve to support the thread box used for raising or lowering the disk which serves as the valve. This eliminates the web at the top of the riser that is required for alfalfa valves, and is of particular advantage where moss or other debris is carried with the irrigation water.

TABLE 9. - HEAD LOSS THROUGH ALFALFA VALVES

A. Pressure loss expressed in centimetres of water depth

Flow rate		Diameter of opening (centimetres)									
		15	20	25	30	35	40	45	50	60	75
<i>Litres per second</i>	<i>Cubic metres per hour</i>	..... Centimetres .....									
10	36	2	1								
20	72	10	3	1							
30	108	26	7	3	1						
40	144	50	13	5	2	1					
50	180	83	22	8	4	2	1				
60	216	126	34	12	6	3	2	1			
80	288	250	64	24	11	5	3	2	1		
100	360		105	40	18	9	5	3	2		
125	450		165	65	29	15	7	5	3	1	
150	540		250	97	44	22	12	7	4	2	
175	630			136	65	30	17	10	6	3	1
200	720			185	83	41	22	14	8	4	1
225	810			245	100	55	30	18	11	5	2
250	900				137	69	37	23	14	6	2
275	990				170	83	45	28	17	7	3
300	1 080				210	100	56	35	21	9	3
350	1 260				300	145	77	50	29	13	4
400	1 440					195	103	66	40	17	6
450	1 620					250	135	87	50	23	8
500	1 800						170	110	63	29	10
550	1 980						210	140	78	36	13

B. Pressure loss expressed in feet of water depth

Flow rate		Diameter of opening (inches)									
		6	8	10	12	14	16	18	20	24	30
<i>Cubic feet per second</i>	<i>U.S. gallons per minute</i>	..... Feet .....									
0.2	90	0.02									
0.4	180	0.07	0.03								
0.6	270	0.23	0.06								
0.8	360	0.45	0.12								
1.0	450	0.73	0.20	0.07							
1.2	540	1.12	0.31	0.11							
1.4	630	1.58	0.43	0.16							
1.6	720	2.11	0.58	0.21	0.09						
2.0	900	3.50	0.96	0.36	0.16	0.08					
2.4	1 080	5.29	1.47	0.54	0.24	0.12					
2.8	1 260	7.52	2.03	0.74	0.33	0.17	0.09				
3.2	1 440		2.72	1.01	0.44	0.23	0.12	0.07			
3.6	1 620		3.58	1.30	0.58	0.29	0.16	0.09	0.06		
4.0	1 800		4.53	1.67	0.73	0.37	0.20	0.12	0.08		
4.5	2 025		5.87	2.16	0.96	0.48	0.26	0.16	0.10		
5.0	2 250		7.58	2.72	1.21	0.61	0.34	0.19	0.12	0.05	
6.0	2 700			4.17	1.85	0.92	0.51	0.29	0.18	0.08	
7.0	3 150			5.82	2.57	1.28	0.71	0.42	0.26	0.11	
8.0	3 600			7.95	3.51	1.74	0.96	0.57	0.35	0.15	0.06
10.0	4 500				5.72	2.95	1.60	0.94	0.58	0.26	0.09
12.0	5 400				8.83	4.35	2.41	1.43	0.89	0.38	0.14
14.0	6 300					6.04	3.40	1.98	1.23	0.55	0.20
16.0	7 200					8.28	4.53	2.67	1.67	0.73	0.27
18.0	8 100						5.87	3.50	2.15	0.96	0.35
20.0	9 000						7.59	4.42	2.74	1.21	0.44

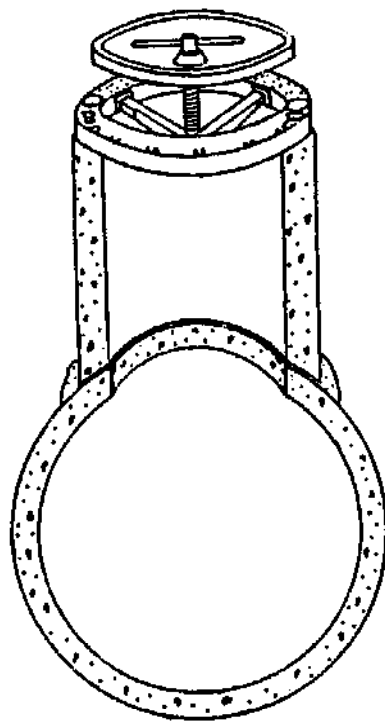

FIGURE 40. Cross-section of concrete supply pipe and riser with alfalfa valve attached.

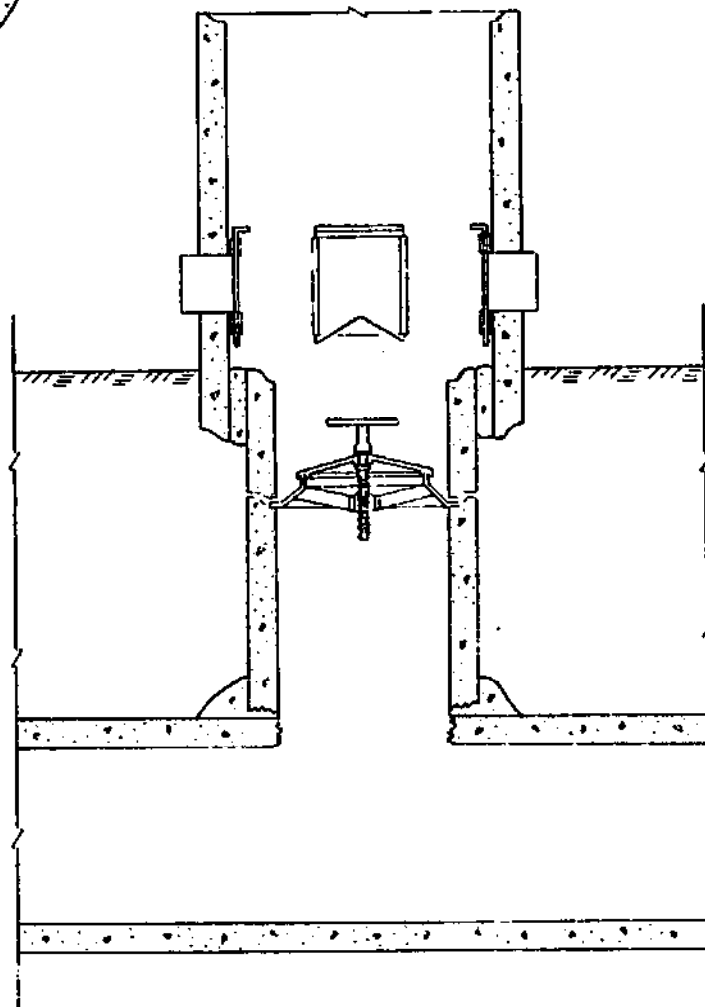

FIGURE 41. Orchard valve and low-pressure open hydrant with slide gates for controlling flow to furrows.



Alfalfa valves are normally spaced so that there will be one outlet for each border strip. When used for irrigation furrows they may be spaced 20 to 40 metres apart.

Another type of outlet, called the orchard valve, is shown in Figure 41. This is placed inside the riser, and has a restricted opening somewhat less in diameter than the riser pipe. This valve is generally used where minor flows of water are required, for irrigating a small number of furrows in orchards or vineyards, for example, or for narrow border strips. Table 10 shows approximate flows through orchard valves of various sizes under pressure heads of 30 and 75 centimetres.

Orchard valves are normally placed at the upper end of each vine or tree row. In narrowly spaced vineyards one valve may serve two vine rows. Valves are usually spaced from 2.5 to 6 metres apart.

Outlet valves of both types should be placed so that the top of the riser or valve is at ground level, or slightly below. Water falling from outlets elevated above the surface can cause serious erosion of the soil around the riser pipe. Where the tops of the outlets are depressed below ground level the water flows from the valves into a pool, which serves as a stilling basin to help dissipate the energy resulting from water released at a high velocity.

Where the pipeline is to be used for irrigating basins or border-strips, the water is allowed to flow freely from the opened valve on to the area being irrigated. The rate of flow can be controlled by raising or lowering the valve plate. For furrow irrigation a temporary head ditch can be constructed which directs the flow of water from the valve to the head of the furrows. Siphons or spiles can be used to release the water from the temporary ditch into the furrows.

## HYDRANTS

Hydrants are placed over orchard or alfalfa valve outlets to permit additional control of the irrigation water. They are also used as a means of connecting portable gated pipe to the pipeline. Hydrants may be permanent, and constructed over each riser, or portable, so that they can be moved from one valve outlet to another to serve any part of the field being irrigated.

Permanent hydrants usually consist of sections of concrete pipe placed vertically over the riser pipes with small metal slide-gate outlets, as shown in Figure 41. The top of the hydrant is left open so that total flow can be adjusted by the orchard valve and the flow to each furrow adjusted by the small slide gate. The slide is generally notched at the bottom so that the size of the opening can be carefully regulated when only small flows are wanted.

A concrete cap is sometimes mortared to the top of permanent hydrants (Figure 42), in which case an orchard valve is not used and the flow to the furrows is regulated solely by the slide gates, which are placed on the outside of the hydrant. Care must be taken to prevent excessive pressures from developing in the pipeline and to use gates which seal tightly when closed.

Portable hydrants are used with alfalfa valves (Figure 43). They can be made of cast aluminium or galvanized iron sheeting. Some are similar

TABLE 10. - CAPACITIES OF ORCHARD VALVES

A. Flow in litres per second

Inside diameter of riser pipe	Diameter of valve opening	Pressure head available	
		30 centimetres	75 centimetres
<i>Centimetres</i>		<i>Litres per second</i>	
15	3.75	1	2
15	6.25	3	6
15	8.75	6	12
20	12.50	13	26
25	15.00	19	38
30	20.00	33	67

B. Flow in U.S. gallons per minute

Inside diameter of riser pipe	Diameter of valve opening	Pressure head available	
		12 inches	30 inches
<i>Inches</i>		<i>U.S. gallons per minute</i>	
6	1.5	18	35
6	2.5	50	100
6	3.5	100	200
8	5.0	200	400
10	6.0	300	600
12	8.0	500	1 000

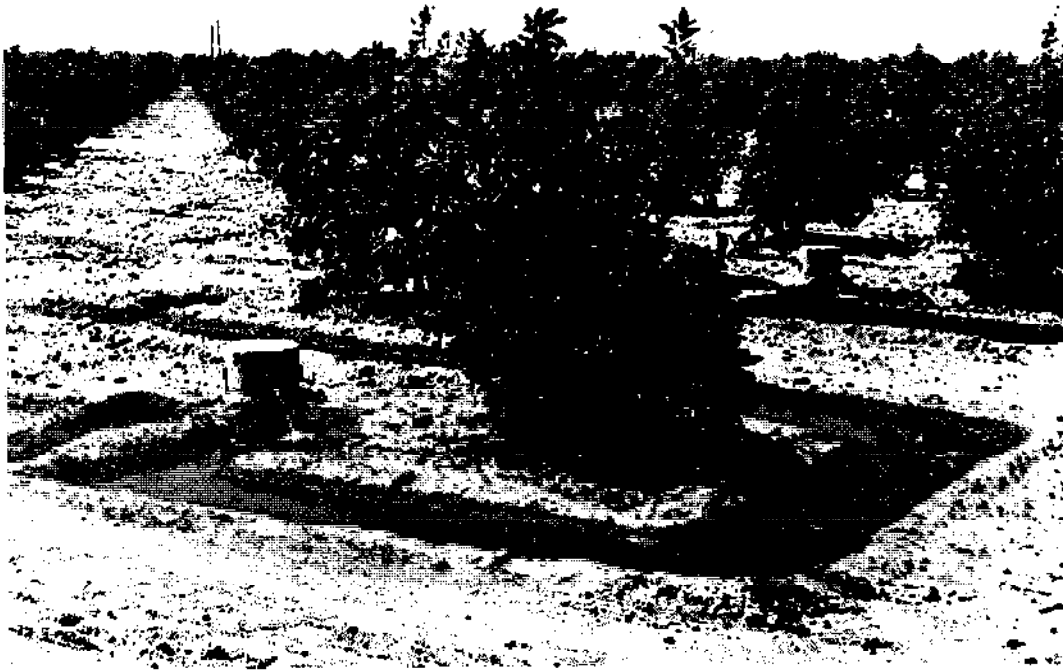

FIGURE 42. Irrigation water from buried concrete pipeline being released through capped riser outlets into furrows irrigating a young citrus orchard.

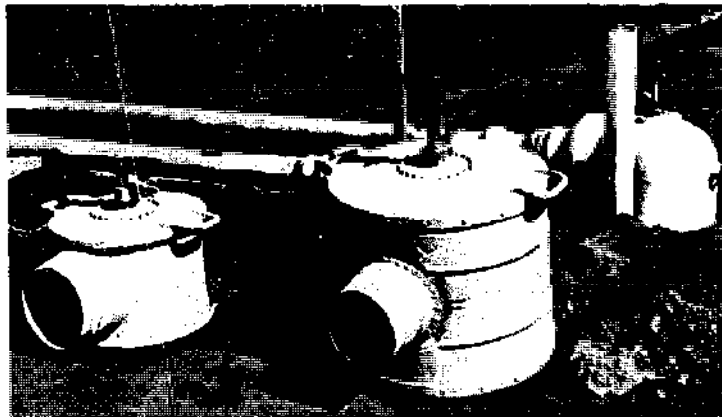

FIGURE 43. Portable metal hydrants, which can be placed over alfalfa valves to connect portable pipe to buried concrete pipelines.

to the open concrete hydrants, and are pushed into the wet soil around the riser pipe to form a seal. Others are closed, with a double screw arrangement connected to the handle on the alfalfa valve. One screw forms a tight seal between the hydrant and the top of the riser pipe, and the other is used for opening the alfalfa valve after the hydrant is in place. Hydrants may have a single outlet, permitting flow in one direction only, or outlets on two sides. The closed portable hydrants are generally used as connectors for metal, rubber or plastic pipe, with the size of the outlets correspond-

ing to the size of the pipe. A friction or clamp joint can be used to connect the pipe to the hydrant. These hydrants are necessary where gated pipe is employed for irrigating furrows. Hydrants can also serve to connect the suction hose of a pump to the water supply carried in the pipeline under low pressure, so that the pump can develop the high pressure needed for operating sprinkler systems or for lifting the water to higher elevations.

#### GATED PIPES

Gated pipes are portable lines with uniformly spaced outlets, used primarily for releasing irrigation water into furrows. When connected to buried pipelines through hydrants they allow the water to be conveyed in an enclosed system from the source to the head of the furrow. Seepage losses are reduced to a minimum. They also provide a convenient means of regulating flow into the furrows.

Gated pipes are usually constructed of aluminium or lightweight steel tubing (Figure 44). Small metal slide gates are spaced along the side of the pipe, the same distance apart as the furrows being irrigated. The gates are often placed in a rubber gasket, which provides a water-lubricated bearing surface for the slides. Water flow can be regulated by the degree the gates are opened. Gated pipe is usually manufactured in lengths of about 4 metres. Individual pipes can be connected to the hydrant or to each other with friction or clamp couplings to assemble a system of the length required. A portable plug is installed at the end of the line.

Flexible butyl rubber or plastic tubing is also used for gated pipe. The tubing has metal slide gates similar to those used with metal pipe, or flexible sleeves (sleeves) of small diameter, about 1 metre long, through which the water is released into the furrows. The sleeves can be folded back to stop the flow, or some type of clamp can be used to regulate it. The sleeves help direct the water in a uniform flow into the furrows and so reduce the risk of erosion from falling water.

The outlets on gated pipe operate as sharp-edge or long-tube orifices. The flow is a function of the pressure within the pipe and of the size of the opening. An available pressure of 30 to 200 centimetres of water is usually required at the hydrant to operate the gated pipe. Flows ranging from 0.15 to 6 litres per second (2.5 to 100 gallons per minute) can be obtained from each outlet. This permits the irrigation to start with a large flow into each furrow, which can then be cut back to a small stream after the water approaches the end of the furrow.

Pressure must also be provided at the hydrant to overcome friction losses in the gated pipe; it is advisable to limit the length of the line and use pipe of sufficient diameter so that these losses can be kept to a minimum —



FIGURE 44. Aluminium pipe with slide gates releasing water into furrows.

usually not greater than 60 centimetres of water. The risers and outlet valves are usually spaced along the buried pipeline so that not more than 30 metres of gated pipe need be connected to each hydrant. Limiting the length of the assembled unit will also allow the use of pipe of smaller diameter, which is easier to move from one position to another. Gated pipe is available in diameters ranging from 10 to 30 centimetres.

To illustrate the installation of a gated pipe system, the following example is given: a flow of 80 litres per second (1 268 gallons per minute) is to be used for furrow irrigation with a flow of 2 litres per second (32 gallons per minute) needed in each furrow, and with the furrows spaced 1 metre apart. This requires that water be released simultaneously into 40 furrows. Forty metres of gated pipe will be needed, with the gated outlets spaced 1 metre apart. Using a two-way hydrant, the gated pipe can be assembled into two units, each 20 metres long. The flow into each unit will be 40 litres per second (634 gallons per minute). Friction loss in a pipeline where water is being released uniformly along its full length will be only about 40 per cent as much as where the entire flow is carried the full length. The friction loss in a 15-centimetre welded steel pipe carrying 40 litres per second is

shown in Table 7 to be 3.6 metres per 100 metres. For 20 metres of gated pipe the friction loss will be  $3.6 \times 0.2 \times 0.4 = 0.29$  metre. A 25-centimetre alfalfa valve used for releasing the 80 litres per second into the hydrant would have a pressure loss of 24 centimetres, as shown in Table 9. In installing the buried pipeline the risers and valves should be spaced no more than 40 metres apart. It would be advisable to have an extra portable hydrant and an additional 40 metres of gated pipe so that one assembled unit could be operating while the other was being moved to the next setting.

## 6. SELECTING THE METHOD OF IRRIGATION TO USE

Selecting the method most suitable for applying the water is important, as the wrong choice could lead to the failure of the irrigation undertaking and possibly cause serious damage to the land. Misuse of irrigation water can cause soil erosion, waterlogging, a build-up of soil salinity, and also waste the funds used for installing the irrigation system.

Each method of irrigation is suited to a certain set of limiting conditions which govern its use. A thorough understanding of the soil, topography, water supply and other factors which can affect irrigation will be helpful in selecting the proper method. The relation of these controlling factors to the various methods of irrigation is discussed by Marr (1958, 1965) and Smith (1957b, 1957c). Each method has certain variations which can be used to widen its scope of application. The chapters that follow discuss the various systems, and Table 11 summarizes the conditions for their use.

The *basin* method is the simplest, and the most widely used for irrigating crops. Cotton, maize, grain, groundnuts, grams, lucerne, pasture and other field crops, as well as orchards and plantations, are all suited to this system.

*Border* irrigation can be the most efficient method for irrigating close-growing crops such as lucerne, pasture and small grains.

*Furrow* irrigation is particularly suitable for crops which would be injured if their stems or crowns were submerged. Row crops, such as vegetables, cotton, sugar beet, maize, potatoes and seed crops, planted on raised beds, are irrigated by furrows between plant rows, and orchards and vineyards by furrows between tree and vine rows.

A variation of the furrow system is *corrugation* irrigation, used for close-spaced crops such as grains, lucerne and pasture. It is sometimes used for germinating crops which have been drill- or broadcast-seeded.

*Drip* (or trickle or dribble) irrigation is particularly beneficial for young orchards and vineyards, for close-spaced perennials such as artichokes, bananas and other crops of high value, and, where water is scarce or has a high salt content, for vegetables grown on raised beds.

*Wild flooding* is used principally for irrigating perennial forage crops, which protect the soil against erosion by the water.

TABLE 11. - SURFACE IRRIGATION METHODS AND CONDITIONS OF USE

Irrigation method	Suitabilities and conditions of use				Remarks
	Crops	Topography	Water supply	Soils	
Small rectangular basins	Grain, field crops, orchards, rice	Relatively flat land; area within each basin should be levelled	Can be adapted to streams of various size	Suitable for soils of high or low intake rates; should not be used on soils that tend to puddle	High installation costs. Considerable labour required for irrigating. When used for close-spaced crops, a high percentage of land is used for levees and distribution ditches. High efficiencies of water use possible.
Large rectangular basins	Grain, field crops, rice	Flat land; must be graded to uniform plane	Large flows of water	Soils of fine texture with low intake rates	Lower installation costs and less labour required for irrigation than with small basins. Substantial levees needed.
Contour checks	Orchards, grain, rice, forage crops	Irregular land; slopes less than 2 percent	Flows greater than 30 litres (1 cubic foot) per second	Soils of medium to heavy texture which do not crack on drying	Little land grading required. Checks can be continuously flooded as for rice, water ponded as for orchards, or intermittently flooded as for pastures.
Narrow borders up to 5 metres (16 feet) wide	Pasture, grain, lucerne, vineyards, orchards	Uniform slopes less than 7 percent	Moderately large flows	Soils of medium to heavy texture	Borders should be in direction of maximum slope. Accurate cross-leveling required between guide levees.
Wide borders up to 30 metres (100 feet) wide	Grain, lucerne, orchards	Land graded to uniform plane with maximum slope less than 0.5 percent	Large flows, up to 600 litres (20 cubic feet) per second	Deep soils of medium to fine texture	Very careful land grading necessary. Minimum of labour required for irrigation. Little interference with use of farm machinery.
Wild flooding	Pasture, grain	Irregular surfaces with slopes up to 20 percent	Can utilize small continuous flows on steeper land or large flows on flatter land	Soils of medium to fine texture with stable aggregate which do not crack on drying	Little land grading required. Low initial cost for system. Best adapted to shallow soils since percolation losses may be high on deep permeable soils.



Benched terraces	Grain, field crops, forage crops, orchards, vineyards	Slopes up to 20 percent	Streams of small to medium size	Soils must be sufficiently deep that grading operations will not impair crop growth	Care must be taken in constructing benches and providing adequate drainage channels for excess water. Irrigation water must be properly managed. Misuse of water can result in serious soil erosion.
Straight furrows	Vegetables, row crops, orchards, vineyards	Uniform slopes not exceeding 2 percent for cultivated crops	Flows up to 350 litres (12 cubic feet) per second	Can be used on all soils if length of furrows is adjusted to type of soil	Best suited for crops which cannot be flooded. High irrigation efficiency possible. Well adapted to mechanized farming.
Graded contour furrows	Vegetables, field crops, orchards, vineyards	Undulating land with slopes up to 8 percent	Flows up to 100 litres (3 cubic feet) per second	Soils of medium to fine texture which do not crack on drying	Rodent control is essential. Erosion hazard from heavy rains or water breaking out of furrows. High labour requirement for irrigation.
Corrugations	Close-spaced crops such as grain, pasture, lucerne	Uniform slopes of up to 10 percent	Flows up to 30 litres (1 cubic foot) per second	Best on soils of medium to fine texture	High water losses possible from deep percolation or surface runoff. Care must be used in limiting size of flow in corrugations to reduce soil erosion. Little land grading required.
Basin furrows	Vegetables, cotton, maize and other row crops	Relatively flat land	Flows up to 150 litres (5 cubic feet) per second	Can be used with most soil types	Similar to small rectangular basins, except crops are planted on ridges.
Zigzag furrows	Vineyards, bush berries, orchards	Land graded to uniform slopes of less than 1 percent	Flows required are usually less than for straight furrows	Used on soils with low intake rates	This method is used to slow the flow of water in furrows to increase water penetration into soil.

## 7. BASIN IRRIGATION

Basin irrigation is the simplest in principle of all methods. For this reason it is the most widely used for irrigating crops. There are many variations in its application, but all involve dividing the field into small units so that each has a nearly level surface. Levees (ridges, bunds or dikes) are constructed around the areas forming basins (plots or paddies) within which the irrigation water can be controlled. The basins are filled to the desired depth and the water is retained until it infiltrates into the soil, or the excess is drained off. In irrigating rice, or ponding water for leaching salts from the soil, the depth of water can be maintained for considerable periods by allowing a continuous flow into the basins.

Variations involve the size or shape of the basins, the techniques used for delivering water to them, and whether the ponding of the water is intermittent or continuous.

Many different crops are irrigated by this method. Practically all systems of irrigated rice production make use of levees for controlling the water on the paddies (Figure 45). Cotton, grain, maize, groundnuts, grams, lucerne, pasture and many other field crops are suited to this system of irrigation, as are many orchards and plantations (Figures 46 and 47). It is seldom used for crops which are sensitive to wet soil conditions around the stems, or for annual crops on soils which crust badly when flooded. Plants which would be damaged by these conditions are usually grown on raised beds so that the water flows in furrows between them. As an extra precaution levees are sometimes constructed around small areas to contain the water in the furrows.

The principal disadvantage of basin irrigation is that the levees interfere with the movement of equipment drawn by animals or tractors to cultivate or harvest the crops. Because of their flat surface, it is sometimes difficult to drain excess waters rapidly from the basins. This can be a particularly serious problem on clay soils with very slow infiltration rates, where standing water reduces soil aeration or creates a favourable environment for the breeding of mosquitoes. These conditions may require a drainage ditch for each basin to provide an outlet for excess water. Considerable land

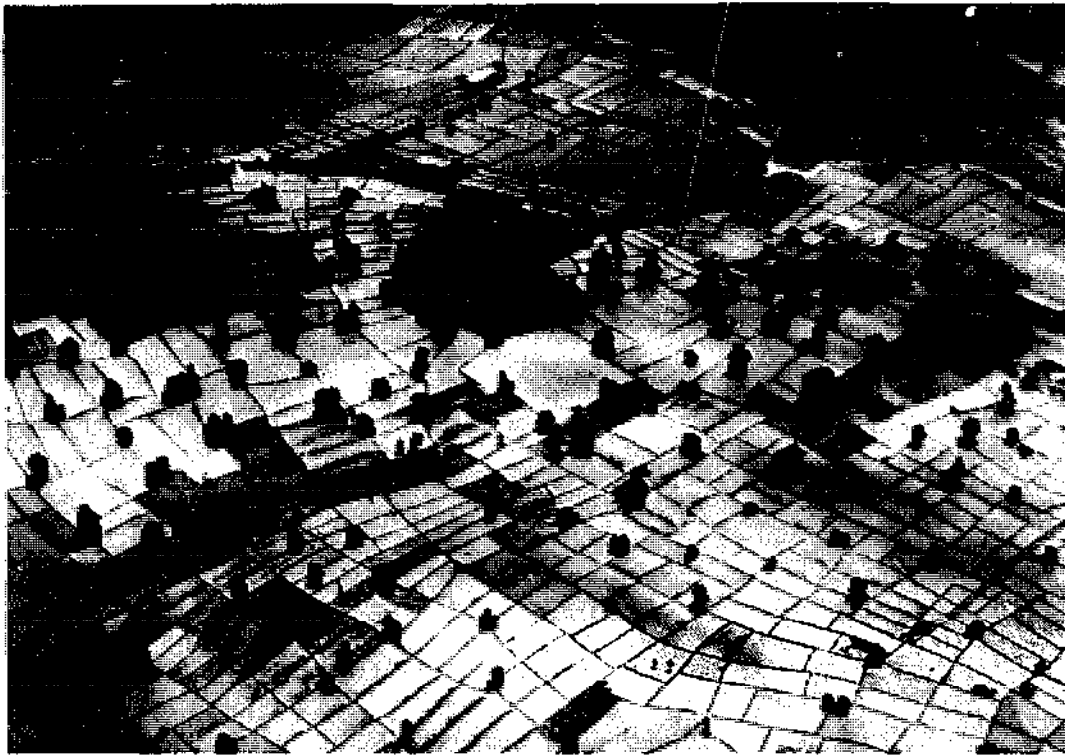

FIGURE 45. Aerial view of contour basins used to irrigate paddy fields.

is occupied by the levees and ditches, reducing the area available for production. Crops such as soybeans are sometimes grown on the levees surrounding basins in which rice or other crops are being grown.

Basins may vary in size from 1 square metre, used for growing vegetables and other intensive crops, to as much as 7.5 hectares for the production of rice and other grain crops on basin-type clay soils. In many areas the size is determined by custom; in some parts of Asia the maximum size is 6 by 4.5 metres while in others it may be 10 by 50 metres. One basin may be used to irrigate each tree in an orchard, or one may irrigate groups of two, four or more trees (Figure 48). Criteria for the design of basin irrigation systems are discussed by Slabbers (FAO, 1971b).

#### **Relation of soil type to flow of water and area in each basin**

Basin irrigation is used on many different soils. The soil characteristic of most importance is the water infiltration rate. This and the size of the stream available determine the area which can be enclosed in each basin.



FIGURE 46 (above).  
Small basins irrigating  
young date palms.

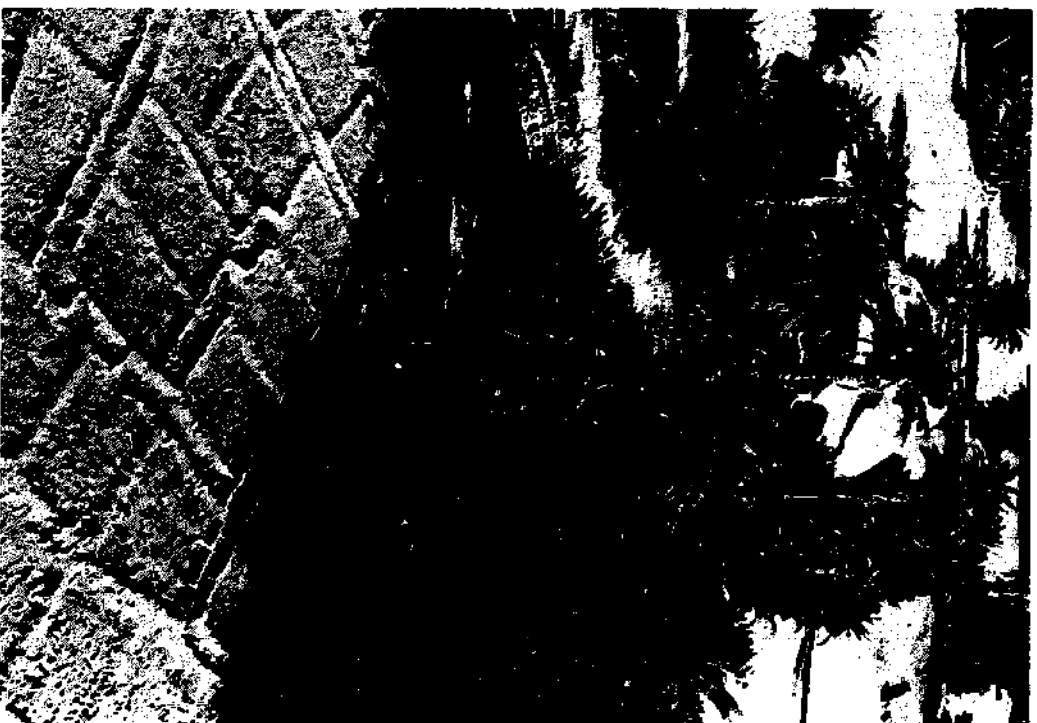

FIGURE 47 (left). View  
of small basins irrigating  
crops grown under date  
palms.

Soils with high infiltration rates, such as sands, require limited basin size even when large flows of water are available. Basins on clay soils can be large or small, depending on water flow. The objective in selecting the basin size is to be able to flood the entire area in a reasonable length of time so that the desired depth of water can be applied with a high degree of uniformity over the entire basin. Experience in irrigating each type of soil is necessary before the most suitable size can be determined. Suggested sizes for various soil types and stream flows are given in Table 12 (the areas are approximations, and the table should be used as a guide only).

It is sometimes possible to modify the soil to decrease the infiltration rate. Compacting and puddling can reduce the pore sizes of medium-textured soils used for growing paddy rice. Bentonite or other clay materials are sometimes added to sands to make them less pervious to water. Where these methods are effective they enable the area that can be enclosed in each basin to be increased, and reduce water losses resulting from excessively deep percolation.

FIGURE 48. Citrus trees irrigated with basins. The basins are expanded as the trees grow larger. The supply ditch placed close to the trees also helps wet the soil during irrigations.



TABLE 12. — SUGGESTED BASIN AREAS FOR DIFFERENT SOIL TYPES AND RATES OF WATER FLOW

A. Area in hectares

Flow rate		Soil type			
		Sand	Sandy loam	Clay loam	Clay
<i>Litres per second</i>	<i>Cubic metres per hour</i>	..... <i>Hectares</i> .....			
30	108	0.02	0.06	0.12	0.2
60	216	0.04	0.12	0.24	0.4
90	324	0.06	0.18	0.36	0.6
120	432	0.08	0.24	0.48	0.8
150	540	0.10	0.30	0.60	1.0
180	648	0.12	0.36	0.72	1.2
210	756	0.14	0.42	0.84	1.4
240	864	0.16	0.48	0.96	1.6
270	972	0.18	0.54	1.08	1.8
300	1 080	0.20	0.60	1.20	2.0

B. Area in acres

Flow rate		Soil type			
		Sand	Sandy loam	Clay loam	Clay
<i>Cubic feet per second</i>	<i>U.S. gallons per minute</i>	..... <i>Acres</i> .....			
1	450	0.05	0.15	0.3	0.5
2	900	0.10	0.30	0.6	1.0
3	1 350	0.15	0.45	0.9	1.5
4	1 800	0.20	0.60	1.2	2.0
5	2 250	0.25	0.75	1.5	2.5
6	2 700	0.30	0.90	1.8	3.0
7	3 150	0.35	1.05	2.1	3.5
8	3 600	0.40	1.20	2.4	4.0
9	4 050	0.45	1.35	2.7	4.5
10	4 500	0.50	1.50	3.0	5.0

### **Slope in relation to size and shape of basin**

Water can be applied most uniformly if the soil surface of the area enclosed in each basin is level. A perfectly flat surface requires careful grading of the soil to remove the high and low spots. In some circumstances, such as when basins are used for supplementary irrigation of winter grain crops, careful levelling may not be justified. A variation of 6 to 9 centimetres between the highest and lowest elevations is therefore sometimes allowed.

If the natural slope of the land is steep, level terraces or benches must be constructed on which the basins can be formed. Masonry walls are sometimes used to stabilize the banks between adjacent terraces. Earth embankments can be used between terraces on moderately sloping land; however, leaks caused by rodents are sometimes a serious problem.

On steeply sloping land with soils which develop deep cracks on drying, the basin method of irrigation should not be used.

Basins can be formed with a minimum amount of land grading on slopes of less than 2 percent, by placing the levees the correct distance apart so

FIGURE 49. Levees have been constructed on lines of equal elevation to form the contour basins used for irrigating this orchard.



that the difference in elevation within each basin is not excessive (Figure 49). For example, if the land has a slope of 1 percent and the maximum allowable difference in elevation within a basin is 6 centimetres the levees must be placed 6 metres apart down the slope. In other words, the levees would be placed along each contour line representing a drop in elevation of 6 centimetres. This difference in elevation is called the vertical interval between levees.

On very flat land, with slopes of 0.2 percent or less, it is often possible to enclose relatively large areas within a single basin without exceeding the maximum allowable difference in elevation. In such cases it may be necessary to use a vertical interval of less than 6 centimetres between levees in order to form basins of reasonable size and shape.

The general topography of the land surface will influence the shape of the basins. Land with a uniform slope permits the use of rectangular basins. Where the topography is rolling the basins will follow the contours of the land surface, giving an irregular pattern to the fields (Figure 50).

Although the basin method can be used on land with an irregular surface, grading to provide a uniform slope is highly desirable. This permits rectangular instead of odd-shaped basins, greatly facilitating the layout of roadways, irrigation supply ditches and drainage ditches. Correct land preparation will also reduce irrigation labour requirements, permit efficient use of the irrigation water and generally result in higher crop yields.

### **Forming the levees**

Levees used for basin irrigation serve as dams for ponding the water. They must be constructed more substantially than those used with the border method, which serve only to guide the water down the slope. Factors which must be considered in determining the size and shape of levees include the depth of water to be ponded; the amount of wave action that will occur, which in turn is related to the size of the basins and the direction and magnitude of prevailing winds; the stability of the soil when wet; the amount and kind of traffic that will cross the levees; and possible damage by burrowing rodents.

The levees may be constructed temporarily for use in a single irrigation or for one cropping season, or they may be semipermanent for use in irrigating perennial crops, such as lucerne or pasture, or for repeated use in irrigating annual crops such as rice grown on the same land for several years (Figure 51). Levees built by hand are likely to be more permanent than those constructed by machines using tractor power. In orchards where mechanical equipment is used for controlling weeds, applying pesticide





FIGURE 50. Rice irrigation. On the right of the illustration there are large contour basins; the levees follow the contours of the field surface, and are placed at vertical intervals of 9 centimetres. On the left, land grading has permitted the construction of rectangular basins, which are more practical for cultivation.

sprays and hauling fruit, the levees are generally used for a single irrigation, or two at most; machines are used for constructing the levees and for knocking them down after irrigation is completed.

The height of earthen levees should provide a freeboard above the ponded water of 10 to 20 centimetres. Newly constructed levees should have additional height to take care of the settlement of loose soil which will occur when they are wetted. Temporary levees are normally 60 to 120 centimetres wide at the base, with a settled height of 15 to 30 centimetres above the original ground surface. Permanent levees used for rice irrigation in large paddies are usually 75 to 100 centimetres high when first constructed. When settled they will be 40 to 50 centimetres high, with a base width of 150 to 180 centimetres. Where possible, permanent levees should be built a month or two before they are to be used so that the soil can settle before water is ponded in the basins.

The levees are formed by borrowing soil from the area immediately to the sides of them. Temporary levees are sometimes formed by a border disk which leaves a borrow-furrow on each side. A more common method uses an A-frame or V-type ridger, which collects soil from a wider area leav-



FIGURE 51. Earth levee between rice paddies constructed by hand labour. The levee also serves as a pathway for going in and out of the fields.

ing only a shallow depth to the borrow strips. An A-frame ridger (Figure 52) consists of two boards set on edge and cross-braced, with a wide opening at the front end and a narrow opening at the rear or discharge end. The boards act as blades for cutting into the soil and crowding it into a ridge. Before using ridgers it is usually necessary to loosen the top soil to a depth of 10 to 15 centimetres so that the blades can collect sufficient soil to make levees of the correct size. One type of ridger, drawn by animals, uses blades about 20 centimetres wide and 2 metres long, spaced 1.5 metres apart at the front and 30 centimetres apart at the rear end. A large V-diker drawn by tractors is used for making rice levees in some areas (Figure 53). It has blades 1 metre wide and up to 9 metres long, spaced 4 to 5 metres apart in front and 1.3 metres apart at the discharge end.

Various methods have been used to stabilize semipermanent levees.

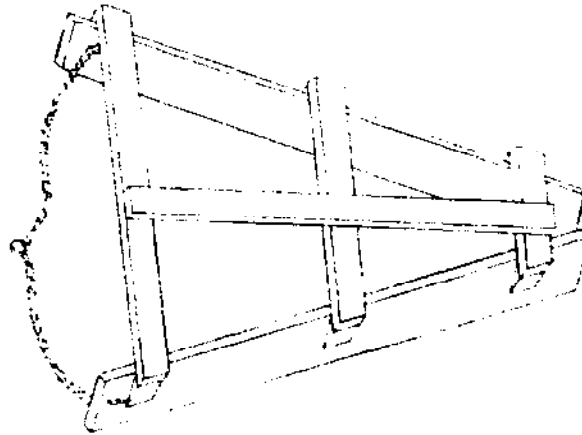

FIGURE 52. Wooden A-frame ridger for forming levees in small-basin or border irrigation systems.

Gypsum is sometimes mixed with soils which are sodium-dispersed to aggregate the soil particles and make them more water-stable. Plastic sheeting placed over earthen levees will protect them from wave action, reduce seepage and inhibit the growth of weeds. In some parts of Asia a plastic membrane is incorporated in levees on pervious soils, vertically along the centre of the ridge, as a barrier to seepage. Levees may also be constructed of bentonitic clays or concrete (Figure 54).

### **Filling the basins with water**

Most crops other than rice are irrigated by filling the basins to the required depth with water, then allowing the water to penetrate into the soil or draining off the excess. Soils with high infiltration rates must be filled quickly, which usually requires serving the basins individually with a large flow of water. This is often accomplished by placing the supply ditch between two rows of basins. Water is delivered into individual basins through outlet gates spaced along each side of the supply ditch. It is advisable to use rectangular basins with the longest length at right angles to the supply ditch so that the ditches can be spaced as far apart as possible. For example, two rows of basins which are 10 metres wide and 50 metres long can be irrigated from supply ditches spaced 100 metres apart. The outlet gates into the basins would be spaced at 10-metre intervals along the ditch. Drains are sometimes placed at the ends of the basins midway between the supply ditches to remove excess water resulting from overirrigation or heavy rainfall. Drain ditches are not usually needed on soils which are pervious enough to allow any excess water to penetrate within 24 hours.

Another common practice for filling basins allows the water to flow successively through one basin into the next one lower down, so that

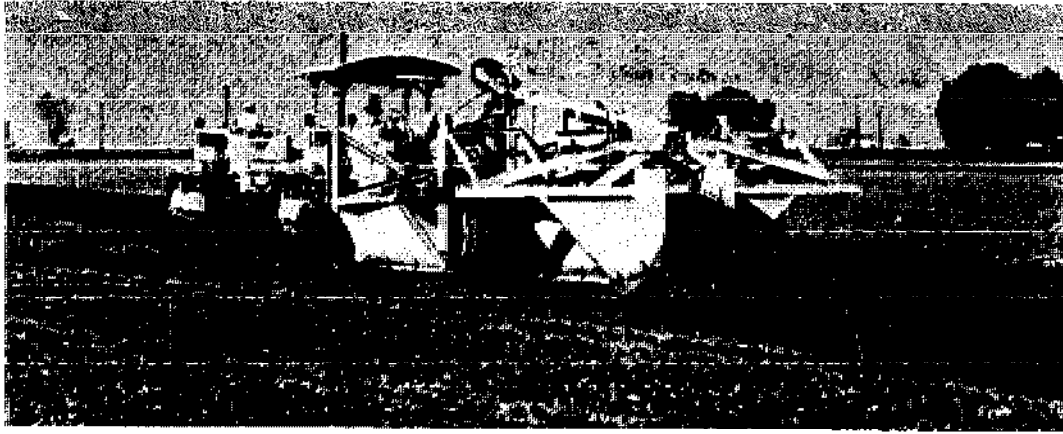
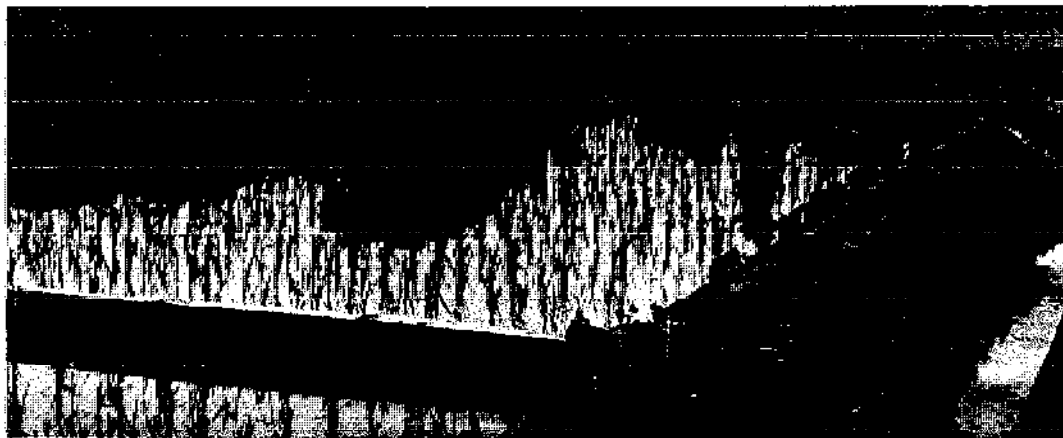

FIGURE 53. Large V-diker which forms levees for rice irrigation.

a single outlet can be used for filling a number of basins located downslope from the supply ditch. Often the water is allowed to flow in the borrow-furrow alongside a levee through gaps in the cross levees to the lowest of the tier of basins. When this is filled to the required depth, the gap in the cross levee of that basin is closed and the next higher basin is filled, and so on until all the basins have been filled. As the borrow-furrow will not normally contain all the water flow, there is partial or complete coverage of the upper basins while the lower ones are being filled. This will result in very uneven distribution of the water on soils which take water readily, unless the entire tier of basins can be filled quickly. Care must be taken to prevent breaks in the cross levees when all the basins are filled. This

FIGURE 54. Rice being irrigated in paddies. Precast concrete units form the levees between basins.



could result in overflowing of the lower basins and possibly cause serious erosion.

A fill-and-drain procedure can also be employed for irrigating a tier of basins. This is often used on soils with a high initial intake rate which decreases to a much slower rate after an hour or two. The highest basin is filled first, and the water is retained for the necessary length of time. The lower cross levee of the first basin is then opened and the next basin is filled with the excess water draining from the first together with water being released from the supply ditch, and so on until the entire tier of basins has been irrigated. The water flowing from the supply ditch can be carried through the basins in a channel, the bottom of which is at a slightly lower level than the normal ground surface, so that it will also serve as a drain to remove water from the basins. The soil excavated in forming this channel should be spread evenly over the basin surface so that there are no banks to obstruct the movement of water into or out of the channel. Removable dams or adjustable check structures can be placed across the channel at each levee to control the water.

Rice irrigation needs careful control of the depth of water in the paddies, as described by Finrock *et al.* (1960). Water needs will vary with the stage of growth of the plants. In order to maintain a uniform depth the inflow must be sufficient to satisfy the consumptive use requirements (evapo-

FIGURE 55. Control gate in place in rice levee. The structure is set low, with soil well compacted on the sides.

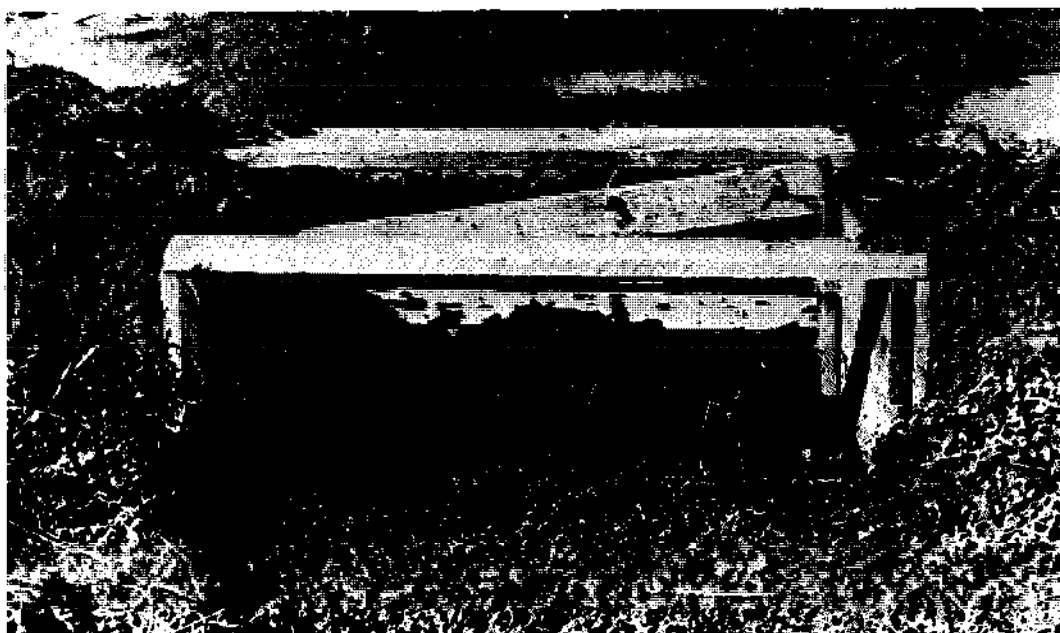

transpiration) and seepage losses. As the consumptive use is variable it is difficult to regulate inflow to fit the water needs exactly. A slight excess is generally allowed to flow through the paddies and drain off at the lower end so that the desired depth can be maintained.

Although most rice is irrigated by continuous flooding during the growing season, intermittent irrigation is gaining favour in some regions. The water may be drained off the fields for salinity or temperature control, and they must be completely drained for harvest. It is therefore necessary to provide means for regulating the inflow accurately and for draining water from the paddies.

Rice paddies can be of various sizes and shapes. Each may be directly connected to a supply and drain ditch, or there may be a tier of basins with the water flowing successively through the higher to the lower paddies. Excess water from the lowest paddy flows into the drain ditch.

Control gates are installed in the levees to permit circulation of the water and to regulate the depth (Figure 55). These are usually equipped with flashboards, which can be varied in height to regulate depth and can be removed for draining the paddies (Figure 56). The boards also serve as spillways to prevent the ponding of excessive depths of water, which might overtop and wash out the levees.

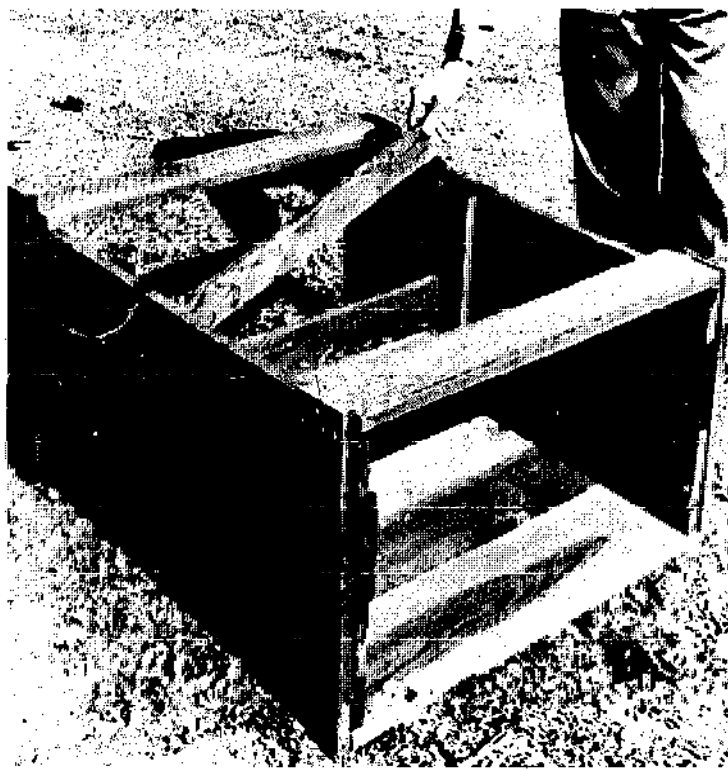

FIGURE 56. Wooden gate with flashboards for controlling depth of water in rice checks. The wood can be treated with preservative to lengthen its life.

## 8. BORDER IRRIGATION

The border method of irrigation<sup>1</sup> makes use of parallel earth ridges -- the levees or borders -- which guide a sheet of flowing water as it moves down the slope. The land between two levees is called a border-strip.<sup>2</sup> These strips may vary from 3 to 30 metres in width and from 100 to 800 metres in length.

This method is more suitable for fields with an area of 4 hectares or more. A relatively large flow of water is needed, the land should have a uniform moderate slope and careful land preparation is necessary for it to be efficient (Figure 57).

Where conditions are suitable for border irrigation it is often the most efficient method for the irrigation of close-growing crops such as lucerne, pasture, small grains and other field crops. It is also used for irrigating orchards and vineyards (Figure 58).

It is essential that the land has an even surface so that the water can flow down the slope at a nearly uniform depth. This requires that a border-strip contain no cross-slope, furrow or other depression which might concentrate the flow of water.

### Soils

Medium-textured deep permeable soils are ideally suited to border irrigation for deep-rooted crops such as lucerne, and for orchards and vineyards. Shallow-rooted crops, such as pastures and grains, can also be efficiently irrigated by this method on slowly permeable or shallow soils. For shallow-rooted crops on sandy soils with high water intake rates, border irrigation could result in excessive losses caused by deep percolation unless the border-strips are very short, in which case it would approach the basin method.

<sup>1</sup> Also called border-strip, strip-check, ribbon-check, border-check, border-ditch and gravity-check irrigation.

<sup>2</sup> Other terms used are: check, strip-check, gravity-check and border-check.



**FIGURE 57.** Water being released into border-strips. The uniform movement of the water across the full width between each pair of levees indicates that the land has been properly graded for this method of irrigation.

**FIGURE 58.** Deciduous orchard irrigated by border-strips, with the guide levee in the centre between the tree rows. Large flows of water and a well-graded land surface are necessary for this system of irrigation.





The rate at which water infiltrates the soil is more important with border than with basin irrigation. Since the water is constantly moving down the strips, the velocity must be regulated by the size of stream so that the water covers each unit for the time necessary for the required depth to penetrate into the soil. Sandy soils, with a high intake rate and low water-holding capacity, require a very rapid spread of water over the border-strip so that a relatively shallow depth can be uniformly applied. Clay soils, with a low intake rate and high water-holding capacity, require a slow spread so that a greater average depth of water can be applied. The rate of spread of the water is controlled by the width and length of the strip, the slope, resistance to flow due to vegetation or soil roughness, and the size of stream used for irrigating.

Soil erosion is not usually a problem with border irrigation if care is taken in preparing the land so that water will not concentrate in narrow channels. A cover of close-spaced plants grown beforehand with soil moisture supplied by rainfall will also help protect the soil from erosion when irrigations are applied.

### **Slope**

The slope of the border-strip down which the water flows should be uniform or slightly decreasing. An increase in rate of slope should be avoided as it will speed the water flow and usually result in uneven water distribution and perhaps erosion of the soil. An exception to this general rule is the first reach of the border-strip, which should be flat. Having no slope in the first 10 to 15 metres will help spread the water over the full width before it starts to flow down the strip.

It is sometimes the practice to have no slope in the last 30 to 50 metres of the strips, to create a flat area over which any excess water can be ponded. This might be justified on permeable soils with good internal drainage, but should not be practised on fine-textured soils where water is likely to pond for periods longer than 24 hours. On these soils the slope should be continued to the end of the strip and a drainage ditch used for carrying away any excess water.

A minimum slope is needed to provide the hydraulic gradient which will cause the water to flow down the border-strips. This slope will also permit the drainage of excess water which might otherwise collect in minor depressions caused by soil settlement or inaccuracies in the land-grading work. Drainage is of particular importance on slowly permeable soils where standing water can cause injury to the crop. A minimum slope of 0.2 percent is recommended for irrigating lucerne, orchards or vineyards, which

require relatively infrequent heavy irrigations because of their deep-rooting characteristics. A minimum slope of 0.3 percent is recommended for shallow-rooted crops, such as pastures, which require frequent light irrigations.

Sandy loam soils with slopes of up to 2 percent can be irrigated successfully by the border method after close growing crops have become established, providing the proper flow of water is used. Pastures planted on clay soils which form water-stable aggregates are being irrigated by border-strips on slopes of up to 7 percent with no serious erosion problems.

For an ideal border irrigation system there should be no cross slope (slope at right angles to the direction of the levees) within a strip. Adjacent levees, however, may have some difference in elevation. This difference should not exceed one fourth the normal depth of water as it flows down the strip. The depth of water will be influenced by the type of crop being grown and the roughness of the soil, but depends more on the slope in the direction the water is flowing. If the irrigation slope is 0.1 to 0.2 percent, the depth of water will be 10 to 12.5 centimetres, and the allowable difference in grading across the strip may be as much as 3 centimetres. Depths decrease markedly as the irrigation slope increases, which implies that the care taken in grading across the strip must be greater on steep lands than on flat. Narrow strips will help overcome difficulties resulting from unevenness of the land surface.

A cross slope can best be avoided by having the water flow in the direction of maximum slope. Constructing the levees at right angles to the ground surface contours means that there would be no natural cross slope. This is the practice usually followed as it has been found that eliminating cross slope is of greater importance in reducing soil erosion than is the slope in the direction that the water flows.

To simplify irrigation and other cultural operations it is usually more convenient to have the levees parallel to a field boundary. If the field has a slope in both directions, there will be some slope across the strips to consider in designing the irrigation layout. This can be taken care of by selecting the correct width for the strips or by grading the soil surface across each strip. If, for example, the cross slope is 0.2 percent and the maximum allowable difference in elevation across the strip is 3 centimetres, then the width of the strips may be as great as 15 metres without the need for any special cross-grading within the strips. With greater cross slopes the width of strips would be correspondingly narrower. In order to keep the strips to a desired width it is sometimes feasible to cross-grade them so as not to exceed the allowable difference in elevation. For example, if the land has a cross slope of 0.5 percent and it is planned to use border-strips 15 metres wide with an allowable difference in elevation of 3 centimetres, then it will be necessary to move 2.25 centimetres depth of soil from the

higher to the lower edge of the strip. This will create a difference in elevation of 4.5 centimetres between the soil surface on the two sides of a levee. This difference should not exceed 6 centimetres when the normal type of levee is used, otherwise leaks are likely to result from levee failure, burrowing animals and so on.

### **Width of border-strips**

Some of the limitations imposed by topography on width of border-strips have been discussed. Widths of 15 to 20 metres are commonly used on relatively flat lands, and under ideal conditions strips can be even wider. With slopes of 0.3 to 0.4 percent, width should not exceed 10 to 12 metres. Border-strips on slopes of 0.5 percent or greater should be limited to 6 to 8 metres in width, and where only small streams are available this width may be reduced to 4 metres to allow adequate infiltration of water into the soil.

The size of stream available for irrigating may also be a limiting factor in determining width. As with basin irrigation, the flow of water must be sufficient to cover the entire strip in a reasonable length of time. If the size of stream is limited the width and also the length of strip must be reduced accordingly, so that water will not be lost by deep percolation at the upper end before it reaches the lower. This relation is explained more fully under the discussion on flow requirements.

Another factor which should be given consideration is the width of the harvesting machinery to be used. For example, if the length of the cutter blade for mowing lucerne is 2 metres, then the width of the border-strip used for irrigating the lucerne should be a multiple of two metres. In other words, the design of the irrigation system should always take into consideration other cultural practices to be used in producing the crop.

### **Length of border-strips**

Border-strips should be as long as possible while still retaining reasonable efficiency in water application. The longer the strips the lower the cost of the distribution system and the amount of labour required for irrigation.

In deciding the length the first factor to be considered is the size and shape of the field. Strips will usually run the full length of small fields, but large fields may need to be divided so that the lengths of the strips are one half, one third, one fourth, etc., the total length of the field. Supply

ditches or pipelines must be provided across the upper end of each irrigation run, and the cost of the distribution system should be taken into consideration in designing the irrigation layout.

The length of border-strips should bear an inverse relation to the infiltration rate of the soil. On soils with very low infiltration rates the strips can be up to 800 metres long. These lengths are often advantageous in that they allow the water to run for a sufficient time to guarantee the necessary water penetration without causing excessive runoff at the lower ends of the strips. On soils with very high intake rates it may be necessary to limit length to 100 metres or less.

Other factors affect strip length. It can normally be increased as the depth of water to be applied increases. This is related to the depth of rooting of the crop and the water-holding capacity of the soil; for example, longer strips can be used for deep-rooted crops grown on clay soils than for shallow-rooted crops grown on sandy soils. Any increase in resistance to water flow, resulting from density of vegetative cover, soil roughness, and so on, will require a corresponding decrease in length of strip. On flatter slopes (up to 0.5 to 1 percent, depending on erodibility of the soil), the strip length may be increased as the velocity of water flow (which is related to slope) increases. On steeper slopes it may be necessary to limit the flow rate to avoid erosion, and in this slope range the length may need to be decreased as the slope increases. The length may be limited also by the size of stream available, although adjustments of this nature should be taken care of in the width of the strip where this is practical.

Where soils of widely different characteristics occur in the same field the lengths of the strips should be adjusted so that only soils with similar infiltration rates are included in a strip, for uniform water distribution.

### **Stream size**

The size of stream delivered into each border-strip is the one factor which can be varied after the irrigation system has been installed. It can therefore compensate in part for inadequacies in strip width or length and for changes which might take place in soil infiltration rates or depths of rooting of crops. The size of stream required, however, should be determined as accurately as possible in the design of the system.

It is often convenient to express the stream requirement in terms of rate of water flow per unit width of the border-strip, such as litres per second per metre of width, or cubic feet per second per foot of width. This is referred to as the unit flow. This value multiplied by the width of the strip is the size of stream that should be delivered into each strip

Where irrigation water is delivered to a field at a constant rate it is usually possible to vary the amount turned into each border-strip by changing the number of strips irrigated at one time. An exception would be where the stream available is so small that the entire flow must be used in a single strip. This factor should be taken into consideration in selecting the strip width. To provide some flexibility in operating the system, enough water should be available for two or more strips to be irrigated at the same time.

The depth of water applied can be regulated by stream size. A larger stream is used to apply a shallower depth, and a smaller stream to apply a greater depth. The amount of water that enters the soil is related to intake-opportunity time, which in turn is related to how fast the entire area of the strip can be covered with the flow of water. Varying the size of stream therefore makes it possible to vary the depth of water applied.

Under favourable conditions, uniform irrigation can be accomplished by using a constant flow turned into the strip. When the water has reached a given point down the strip (usually about three quarters the distance) the flow is turned off. The water above the ground surface on the wetted portion of the strip flows to the lower end, completing the irrigation. Uniformity depends on using the proper stream flow and shutting off the flow at the correct time.

A number of factors determine the conditions which permit the use of a constant stream flow for obtaining uniform distribution of water. One important factor is the volume of water above the ground when the flow is turned off, which is related to the slope. Constant-flow application is usually most successful on medium-textured soils with slopes of 0.2 to 0.3 percent; on slopes in excess of 0.5 percent the depth will probably be too shallow for uniform distribution.

Uniformity of distribution is only one criterion for good irrigation; consideration must also be given to adequacy. If the depth of water applied is excessive, the unit flow must be increased, or the strip shortened, or the land regraded to a steeper slope. If the depth is inadequate, the unit flow can be reduced, the strip can be lengthened, or the flow can be decreased when the water approaches the end of the strip and the reduced flow continued until the required depth of water has been applied. Irrigators usually prefer a single constant flow, because less attendance is required. If too little water is applied, more frequent irrigations to shallower depths can satisfy the water needs of the crop.

### **Design criteria**

The layout of a border irrigation system involves reaching a proper balance between soil type, slope, dimensions of the border-strips and flow

of water, so that the desired depth of water will be applied uniformly to the entire field without waste from deep percolation or surface runoff. In newly developed areas the relationship between the above factors should be determined by irrigation trials conducted under the conditions where the border method will be used. These trials would include testing various widths and lengths of strips, and checking the uniformity of applications when different stream flows are used.

The uniformity of water distribution can be evaluated in detail by determining the time the water takes to flow over each unit of length of the border-strip. This can be done by placing stakes at regular intervals down the length of the strip. The field should be divided into at least 10 segments, and the distance between stakes should not exceed 30 metres. The time is recorded when the water is turned into the head of the strip, and when it advances to each stake. It is also recorded when the water is turned off, and when it recedes from each station. The advance and recession curves can then be plotted with time as the ordinate, and distance down the border as the abscissa. The vertical distance between the two curves at any distance is the period during which the water covered the surface at that point. If this period is the same at all points, the irrigation can be considered uniform. If the two curves tend to converge, a larger flow of water or a shorter strip is suggested.

The average depth of water applied can be computed from

$$D = \frac{Q \times C \times T}{W \times L}$$

where  $D$  is the average depth of water in centimetres,  $Q$  is the size of stream turned into the border-strip in litres per second,  $C$  is a constant equal to 360,  $T$  is the time in hours,  $W$  is the width and  $L$  is the length of the border-strip in metres (or, where  $D$  is the average depth of water in inches,  $Q$  is the flow in cubic feet per second,  $C$  is a constant equal to 43 560,  $T$  is the time in hours,  $W$  is the width and  $L$  is the length of the border-strip in feet).

The average depth of water calculated should be evaluated to see whether it is inadequate or excessive, taking into consideration the water-holding capacity of the soil and the depth of rooting of the crop.

Because of the many factors which affect the design of border irrigation systems, generalized criteria should be used only after they have been evaluated by field trials of applicability. However, these criteria can be useful in planning field trials to establish proper ranges of flow rates and widths and lengths of strips for various conditions of soil, slope and depth of water.

Tables 13 and 14 are guides modified from those suggested by Marr (1958), which have proved useful in the southwestern United States for irrigating shallow- and deep-rooted crops.

TABLE 13. - SUGGESTED STANDARDS FOR THE DESIGN OF BORDER-STRIPS FOR SHALLOW-ROOTED CROPS

A. Metric units

Soil profile	Percent of slope	Unit flow per metre of strip width	Average depth of water applied	Border-strip	
				Width	Length
	<i>Metres per 100 metres</i>	<i>Litres per second</i>	<i>Milli-metres</i>	<i>..... Metres .....</i>	
CLAY LOAM 0.6 metre deep over permeable subsoil	0.15-0.6	6-8	50-100	5-18	90-180
	0.6-1.5	4-6	50-100	5-6	99-180
	1.5-4.0	2-4	50-100	5-6	90
CLAY 0.6 metre deep over permeable subsoil	0.15-0.6	3-4	100-150	5-18	180-300
	0.6-1.5	2-3	100-150	5-6	180-300
	1.5-4.0	1-2	100-150	5-6	180
LOAM 0.15 to 0.45 metre deep over hardpan	1.0-4.0	1-4	25-75	5-6	90-300

B. British units

Soil profile	Percent of slope	Unit flow per foot of strip width	Average depth of water applied	Border-strip	
				Width	Length
	<i>Feet per 100 feet</i>	<i>Cubic feet per second</i>	<i>Inches</i>	<i>..... Feet .....</i>	
CLAY LOAM 24 inches deep over permeable subsoil	0.15-0.6	0.06-0.08	2-4	15-60	300-600
	0.6-1.5	0.04-0.07	2-4	15-20	300-600
	1.5-4.0	0.02-0.04	2-4	15-20	300
CLAY 24 inches deep over permeable subsoil	0.15-0.6	0.03-0.04	4-6	15-60	600-1 000
	0.6-1.5	0.02-0.03	4-6	15-20	600-1 000
	1.5-4.0	0.01-0.02	4-6	15-20	600
LOAM 6 to 18 inches deep over hardpan	1.0-4.0	0.01-4.0	1-3	15-20	300-1 000

TABLE 14. — SUGGESTED STANDARDS FOR THE DESIGN OF BORDER-STRIPS FOR DEEP-ROOTED CROPS

A. Metric units

Soil type	Percent of slope	Unit flow per metre of strip width	Average depth of water applied	Border-strip	
				Width	Length
	<i>Metres per 100 metres</i>	<i>Litres per second</i>	<i>Milli-metres</i>	<i>Metres</i>	
SAND Infiltration rate of 2.5 + cm per hour	0.2-0.4	10-15	100	12-30	60-90
	0.4-0.6	8-10	100	9-12	60-90
	0.6-1.0	5-8	100	6-9	75
LOAMY SAND Infiltration rate of 1.8 to 2.5 cm per hour	0.2-0.4	7-10	125	12-30	75-150
	0.4-0.6	5-8	125	9-12	75-150
	0.6-1.0	3-6	125	6-9	75
SANDY LOAM Infiltration rate of 1.2 to 1.8 cm per hour	0.2-0.4	5-7	150	12-30	90-250
	0.4-0.6	4-6	160	6-12	90-180
	0.6-1.0	2-4	160	6	90
CLAY LOAM Infiltration rate of 0.6 to 0.8 cm per hour	0.2-0.4	3-4	175	12-30	180-300
	0.4-0.6	2-3	175	6-12	90-180
	0.6-1.0	1-2	175	6	90
CLAY Infiltration rate of 0.25 to 0.6 cm per hour	0.2-0.3	2-4	200	12-30	350

B. British units

Soil type	Percent of slope	Unit flow per foot of strip width	Average depth of water applied	Border-strip	
				Width	Length
	<i>Feet per 100 feet</i>	<i>Cubic feet per second</i>	<i>Inches</i>	<i>Feet</i>	
SANDY Infiltration rate of 1 + inch per hour	0.2-0.4	0.11-0.16	4	40-100	200-300
	0.4-0.6	0.09-0.11	4	30-40	200-300
	0.6-1.0	0.06-0.09	4	20-30	250
LOAMY SAND Infiltration rate of 0.75 to 1 inch per hour	0.2-0.4	0.07-0.11	5	40-100	250-500
	0.4-0.6	0.06-0.09	5	25-40	250-500
	0.6-1.0	0.03-0.06	5	25	250
SANDY LOAM Infiltration rate of 0.5 to 0.75 inch per hour	0.2-0.4	0.06-0.08	6	40-100	300-800
	0.4-0.6	0.04-0.07	6	20-40	300-600
	0.6-1.0	0.02-0.04	6	20	300
CLAY LOAM Infiltration rate of 0.25 to 0.5 inch per hour	0.2-0.4	0.03-0.04	7	40-100	600-1000
	0.4-0.6	0.02-0.03	7	20-40	300-600
	0.6-1.0	0.01-0.02	7	20	300
CLAY Infiltration rate of 0.10 to 0.25 inch per hour	0.2-0.3	0.02-0.04	8	40-100	1200



## Forming the levees

The levees used in border irrigation serve only to guide the water as it flows in the strips. They must be high enough to confine the water within the strip being irrigated, but not so high as to interfere with harvesting operations. They should be shaped so that close-planted crops growing on them can obtain soil moisture, thus allowing the entire field area to be utilized for crop production.

Levees used for irrigating flat land with large flows of water must be higher than those used on steep lands with small flows. The height should be at least 3 centimetres greater than the maximum depth at which water flows in the strips. Heights required after the soil in the levees has settled may vary from 12 to 18 centimetres.

The sides of the levees should have sufficient slope to provide soil stability when they are wet. Those formed from clay soils can often be constructed with base widths of only 60 centimetres, whereas those formed from loose sandy soils may require base widths of up to 2.4 metres.

Levees used for irrigating perennial crops such as lucerne or pasture are considered to be semipermanent, while those used for only one or two irrigations of a grain crop or an orchard are temporary. Greater care should be taken in forming levees to be used over a number of years than for temporary levees, particularly with regard to the elimination of the borrow furrow from which soil is taken to form the levee.

The first step in installing the irrigation system is to mark the field where the levees are to be constructed. Stakes with flags, spaced out to the width selected for the strips, can be placed at the two ends of the field as guides. It is sometimes convenient to mark the field with small furrows where the levees are to be located. This will help ensure that the levees will be straight and spaced the correct distance apart. Building the ridges involves three operations. One is to collect soil from as wide a strip as possible and deposit it in a ridge to form the levee. The second is to compress and shape the levee. The third is to smooth the land between the levees to fill in any depressions.

Three types of equipment are used for these operations. A-frame ridgers, V-dikers, border disks and various types of scrapers are used for collecting the soil into the ridges (Figure 59). Chain drags, ring rollers, and sleds with shapers especially constructed to provide the required size of levee are used for compacting and smoothing the levees. Drag floats and angle-bladed scrapers are used for smoothing the strips to reduce any cross slope and fill in any small depressions (Figure 60).

The levees are usually discontinued a short distance from the lower edge of fields that have relatively flat slopes. Leaving a gap of about 10 metres

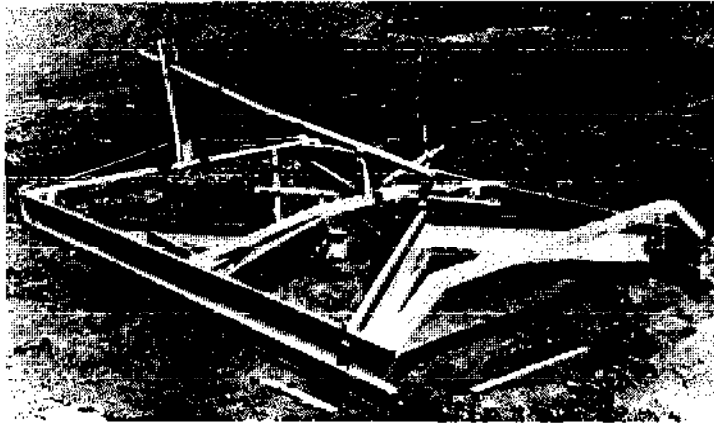

**FIGURE 59.** Metal A-frame ridger and shaper for forming flat-sided levees.

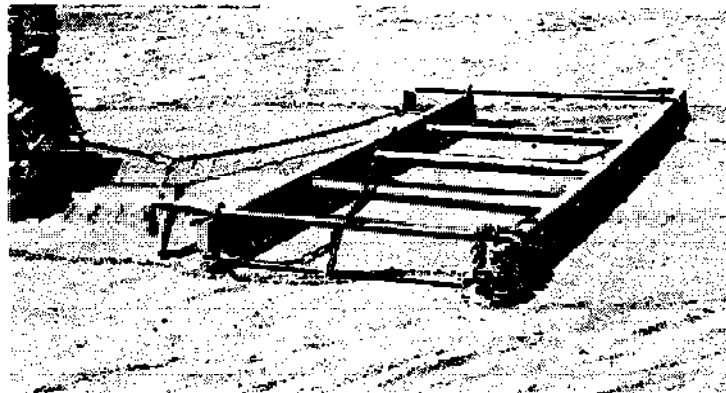

**FIGURE 60.** Drag float smoothing the land surface between levees, used with the border method of irrigation.

and constructing a levee across the lower edge of the field will cause any excess water to move in the direction of the cross slope, and any water not penetrating into the soil will eventually reach the lowest corner of the field, where it can be collected into a drainage ditch.

### **Controlling the water**

Efficient irrigation by the border method requires accurate control of the water as it is being delivered into the border-strips. The devices used for regulating the flow should provide adequate capacity for releasing the size of stream required, should prevent any leakage of water when they are closed, and should be easy to operate. The water may be supplied through an open ditch or a pipeline placed across the upper edge, or head end, of the strips. A drainage ditch may also be needed across the lower edge of the field to remove any excess water.

Where water is delivered to the field in an open ditch, structures are needed to regulate the height of the water in the ditch. They may be per-

manently installed check-gate structures or portable dams made of canvas or other pliable material. They are used to raise the water level in the ditch to provide the pressure head needed to force the water through the outlets into the border-strips.

The outlets or turnouts from the ditch into the strips may be concrete or wooden gate structures equipped with flashboards, pipes placed through



FIGURE 61. Weir-type outlet with flashboards in concrete-lined canal.



FIGURE 62. Circular gate on pipe outlet from concrete-lined canal.

the ditch bank with slide-gate controls, or large portable siphons placed over the ditch bank (Figures 61 and 62). The bottom of the turnouts should be lower than the surface of the field so the water will discharge into a pool at the downstream end. Releasing water into the strips by cutting the ditch bank is poor practice because the rate of flow cannot be accurately

TABLE 15. - FLOW THROUGH PIPE TURNOUTS AND SIPHONS USED IN BORDER IRRIGATION

A. Flow in litres per second

Diameter of pipe or siphon	Pressure head (centimetres)						
	5	7.5	10	12.5	15	20	25
<i>Centimetres</i>	<i>..... Litres per second .....</i>						
10	4.7	5.7	6.6	7.4	8.1	9.3	10.4
12.5	7.3	8.9	10.3	11.5	12.6	14.6	16.3
15	10.5	12.9	14.9	16.6	18.2	21.0	23.5
20	18.7	22.9	26.4	29.5	32.3	37.3	41.8
25	29.2	35.7	41.3	46.1	50.5	58.4	65.2
30	42.0	51.5	59.4	66.4	72.8	84.0	94.0
35	57.2	70.0	80.9	90.4	99.1	114.4	127.9

B. Flow in cubic feet per second

Diameter of pipe or siphon	Pressure head (inches)						
	2	3	4	5	6	8	10
<i>Inches</i>	<i>..... Cubic feet per second .....</i>						
4	0.17	0.21	0.24	0.27	0.30	0.34	0.38
5	0.27	0.33	0.38	0.43	0.46	0.54	0.60
6	0.39	0.47	0.55	0.61	0.67	0.77	0.86
8	0.69	0.84	0.97	1.09	1.19	1.37	1.54
10	1.07	1.31	1.52	1.70	1.86	2.15	2.40
12	1.54	1.89	2.18	2.45	2.68	3.09	3.45
14	2.10	2.58	2.97	3.34	3.64	4.20	4.70

controlled, erosion may be serious, and it is sometimes quite difficult to close the gap to stop the flow.

The turnouts should be large enough in cross-sectional area so that the velocity of the water as it enters the strip will not erode the soil. The high velocities needed to obtain desired flow through outlets which are too small will have a high head-loss requirement, which is often not available. It is therefore important to determine the correct size of outlet required.

Table 15 gives the flow through different sizes of large pipe turnouts or siphons operated under different pressure heads. For free-flow conditions (outlet end not submerged), the pressure head is the difference in elevation between the water surface in the ditch and the centre line of the outlet. For submerged conditions, the pressure head is the difference in elevation between the water surface in the ditch and the water surface on the field above the outlet.

For example, field trials indicate that a unit flow of 6 litres per second per metre of strip width is required for irrigating a sandy loam soil, and it is desirable to have strips 12 metres wide. What size of pipe turnout should be used through the ditch bank? The flow required for each strip will be 72 litres per second. Table 15 indicates that this flow could be delivered with a pipe 30 centimetres in diameter with a pressure head of 15 centimetres, or with two pipes 25 centimetres in diameter with a pressure head of 7.5 centimetres.

## 9. WILD FLOODING

Wild flooding consists of spilling water at frequent intervals from a grade ditch constructed along the high edge of a sloping field. The water is allowed to flow freely down the slope, irrigating the soils the water moves across. Interceptor ditches are placed at intervals down the slope to collect the water, which will tend to concentrate in swales, and to redistribute it more uniformly. It is used primarily for irrigating low-income crops on steep lands where uniformity of water distribution is not a major consideration. It is also used on the heavier soils of valley lands with uneven topography.

Success with this method often depends on the skill used in locating the points where water is released from the grade ditches, and in adjusting the size of openings so that the correct amount of water is released to cover the area served without causing soil erosion. Once the system has been properly established, minimum labour is required to control the irrigation water.

This method is used most often for irrigating perennial forage crops, which protect the soil against erosion by the water. Its use on shallow soils, such as residual soils occurring in foothill regions, prevents excessive deep percolation losses resulting from nonuniformity of water distribution. Wild flooding is seldom used on deep sandy soils with high infiltration rates or on soils with unstable aggregates, which erode readily. It should not be used on clay soils which develop wide cracks upon drying. The occasional large boulders often found on hillside fields do not seriously impair the use of this method of irrigation.

Small streams of water, which are sometimes available as a continuous flow, can be used to advantage, particularly on steeper slopes. However, a small storage reservoir will help in utilizing these small streams. Large flows can also be used for wild flooding on flatter lands.

A minimum of land grading is required with this method of irrigation. Earth moving can be limited to removing small humps and depressions in the land surface, to allow for drainage of excess surface waters, and provide a surface over which farm machinery can be operated with minimum interference. This is an important advantage where soils depths are shallow and only a limited amount of earth can be moved.

## Ditches

The distribution system required for wild flooding consists of the supply ditches, usually running down the slope, and the grade ditches, running across the slope (Figure 63). A slope of 0.5 percent is normally used for the grade ditches (50 centimetres per 100 metres, or 6 inches per 100 feet). The usual method of construction is to plough along the line of the ditch and then shape it with an angle blade attached to a light tractor. On steeper slopes only the downslope side of the ditch is banked. Banks are required on both sides on flatter land. Ditches are sometimes concrete-lined to prevent erosion, control weed growth and eliminate the need for reshaping every year or two.

Pickup or spreader ditches are constructed at intervals down the slope to redistribute the water. Additional water must sometimes be released from the supply ditch into the spreader ditches to provide an adequate flow to irrigate the lower areas of the field. The usual practice is to have these interceptor ditches spaced at intervals of 30 to 60 metres, or at differences in elevation of 2 to 3 metres, whichever is less. They should slope away from low points so that excess water can be carried to the ridges. The

FIGURE 63. Grade ditches placed across a field to be irrigated by wild flooding



slope and spacing of turnouts for the spreader ditches are the same as for the grade ditch across the top of the field.

The supply ditches required to deliver the water from the source into the field ditches must often be placed on steep slopes. To prevent serious erosion they should be concrete-lined, or drop structures must be placed at intervals to dissipate the energy of the water. Concrete pipelines may also be used.

The flow required in the supply ditches will depend on the area being irrigated and on whether a continuous small flow or an intermittent large flow is being used. A continuous flow of 0.7 to 1 litre per second per hectare (4.5 to 6.5 U.S. gallons per minute per acre) is usually needed. Where an intermittent flow is used the ditch capacities must be increased.

### **Outlets**

Uniform distribution is obtained by controlling the release of water from the grade ditches. Where the ditch banks are stabilized (with concrete linings, for example), it is sometimes possible to distribute the water by overflowing the banks. This requires care in constructing the ditch banks at the correct elevation to obtain uniform spillage in the quantities needed within each reach of the ditch.

The more usual practice in regulating the release of water is to have turnouts or openings placed at intervals along the ditch, usually spaced 2 to 3 metres apart. The turnouts can be made by shovelling breaks in the ditch bank. Placing rocks or using sod for the crest and sides of the openings helps prevent erosion. When the canals are concrete-lined, small grooved turnouts, in which flashboards can be placed, are often used.

### **Water management**

The frequency of irrigation is determined by the water needs of the crop and the water-holding capacity of the soil. If use is made of a continuous small stream flow, the water must be rotated between different field areas. Where a large flow is used intermittently some rotation of the water may also be required. Control structures must be placed in the ditches to direct the water to each area that is to be irrigated as a unit.

Considerable experience is needed in putting the wild flooding method of irrigation into operation. Many changes in the location and size of the turnouts and some changes in the location of control structures may be needed before the system can be used to the best advantage.



## 10. FURROW IRRIGATION

Irrigation by the furrow method is accomplished by running water in small channels (furrows) that carry the water as it moves down or across the slope of the field. The water seeps into the bottom and sides of the furrows to provide the desired wetting of soil. Careful land grading for uniform slopes is essential with this method.

Furrows are particularly suitable for irrigating crops which are subject to injury if water covers the crown or stems of the plants. Row crops such as vegetables, cotton, sugar beet, maize, potatoes, seed crops, and so on, planted on raised beds, are irrigated by furrows placed between the plant rows (Figure 64). Orchards and vineyards can be irrigated by placing one or more furrows between the tree or vine rows in order to wet a major area of the root zone (Figure 65). A variation of the furrow method is the use of small rills, or corrugations, for irrigating close-spaced crops such as grains, lucerne or pasture. Corrugations are discussed as a separate method in the following chapter.

In contrast to flooding, furrow irrigation does not wet the entire soil surface. Efficient irrigation therefore depends on the lateral movement of water from the furrows. This movement is important not only for wetting the soil: the movement of soluble salts, fertilizers and herbicides carried with the water must also be considered.

The labour required is generally greater for this than for any other method of surface irrigation, except possibly irrigation with small basins. Considerable experience is needed to divide the water in the supply ditch into a number of furrow streams and maintain correct rates of flow until irrigation is adequate.

### **Furrow and bed shapes**

The shape of the furrows and raised beds can have considerable influence on the adequacy and efficiency of furrow irrigation. The cross-section of the furrows should be sufficient to carry the amount of water needed to obtain uniform distribution throughout the furrow.

The most common furrow is V-shaped. Such furrows 15 to 20 centimetres deep and 25 to 30 centimetres wide at the top will normally carry a flow of about 3 litres per second (50 gallons per minute) on relatively flat slopes. Water moving with a depth of 15 centimetres in such a furrow will have a cross-sectional area of about 250 square centimetres. This is equivalent to a depth of 2.5 centimetres spread uniformly over the area between furrows spaced 1 metre apart.

Irrigations used for the germination of crops require that the soil near the surface of the beds containing the seeds be thoroughly wetted. Shallow furrows 10 to 15 centimetres deep will facilitate the movement of water into the surface of the beds. Such shallow furrows require careful grading of the land to a uniform slope so that they can be filled deeply with water without overflowing the beds, which might cause crusting of the surface soil. Another method is to use relatively flat slopes (about 0.05 percent), which will allow the water to run deeply in furrows of normal depth without causing erosion.

In irrigating perennial crops or mature annual crops with deep root systems, the principal objective is to replenish the water which has been used up in the entire root zone. For such crops deeper furrows can be used, and the slope of the furrow is not as important as with shallow-rooted crops.

Broad-based furrows are sometimes used on soils which take water slowly. Increasing the wetted perimeter provides a greater area for the water to move into the soil. These furrows are roughly U-shaped and generally have a bottom width of 15 to 25 centimetres, although widths of 60 centimetres or more have been used for irrigating orchards, vineyards, and widely spaced crops such as tomatoes and melons.

Furrow shapes will be modified by the water as it moves down the slope. On steep slopes the water tends to form a narrower channel, whereas on flatter slopes it forms a broader channel. These tendencies are greater on sandy than on clay soils. To help keep the water spread over the full width, the bottoms can be roughened or made to undulate. Two small furrows can be placed in the bottom of one broad-based furrow.

Beds for row crops irrigated by furrows are normally flat or slightly rounded. The crops may be planted in single or double rows on each bed. Beds for winter or early spring crops in cooler areas may be sloped to increase exposure to the sun (Figure 66).

Excessive salinity in the soil or the irrigation water can create serious problems with furrow irrigation. Soluble salts are moved with the water and tend to concentrate in the surface and centre of the beds. They often inhibit the germination of seeds and can severely damage salt-sensitive crops. Since the salts tend to move toward the highest point, the beds are sometimes formed with a ridge to control the location where they will accumulate.

FIGURE 64 (right). Furrows used to irrigate tomato plants growing on raised beds. The small siphons deliver water into the furrows from an earthen field ditch.



FIGURE 65 (below). Broad furrows between the tree rows are used to irrigate this orchard.



The ridge is formed near the centre of beds with a double row of crops, and on one edge of beds with a single row. The seeds are planted along the lower edges of the beds away from the ridge where the salts will concentrate.



FIGURE 66. Beds are sloped to control salts around young melon plants. Plants are covered with "hot caps" to reduce frost injury, and planted on the edges of the beds that receive most sunlight.

### **Furrow spacing**

The spacing of the furrows will depend on the crop to be irrigated, the type of tillage machinery to be used, and the wetting pattern obtained by the lateral movement of water in the soil.

Many crops are planted in single rows 75 to 105 centimetres apart for convenience in planting, cultivating and harvesting. Other crops, particularly vegetables, are often planted in double rows on each raised bed, with a spacing of 40 centimetres between the plants and 60 centimetres between the beds. Furrow spacing in such cases would be 1 metre.

A standard width between furrows is often used for irrigating a number of different crops which make use of the same cultivating equipment. This eliminates changing the spacing of the tool attachments when the equipment is moved from one crop to another. The lateral movement of water from furrows in soils with uniform profiles depends primarily on the texture of the soil; the wetting pattern being broader in clays than in sands. To obtain complete wetting of sandy soils to depths of 1.2 to 1.8 metres the furrows usually should not be placed more than 50 centimetres apart. In uniform clay soils, complete wetting to the same depths might be obtained by furrow spacings of 120 centimetres or more.

Soils with nonuniform profiles will generally have greater lateral movement of water than soils with uniform profiles. Lateral movement is always increased in soils lying above less permeable layers or above abrupt changes in soil texture. Lateral movement is also increased by high water-

table levels or perched water conditions. Wetting patterns as they are affected by soil profile conditions have been discussed more fully by Doneen (FAO, 1971f).

The main objective in selecting furrow spacing is to make sure that the lateral movement of the water between adjacent furrows will wet the entire root zone of the crop before it moves beyond the depths from which the roots can extract the soil water. Wetting patterns can be easily determined by digging a trench across a furrow after it has been irrigated, if the soil was dry to a considerable depth before the irrigation was applied. The examination of a number of furrows in which water has run for different periods is usually the best way to decide furrow spacings for any particular soil.

### **Furrow slopes**

Water can be applied most efficiently if the furrows have a uniform slope. Uneven slopes generally result in uneven depths of irrigation along the furrows, and they may cause soil erosion from the steeper areas and soil deposition on the flatter areas. There is also the danger that crops will be injured by water overtopping the beds if there are low spots in the field where water can pond.

A furrow is actually a small channel, and the principles governing the flow of water in open channels also apply to furrows. The velocity of the water flowing in a furrow is related to the square root of the slope of the furrow. The velocity is also affected by the shape and roughness of the furrow and the quantity of water being carried.

A slope is required to provide the energy gradient needed to cause the water to flow. If the bottom of the furrow is level, as is often the case with short furrows, the slope of the water surface when water is flowing provides the energy gradient needed. The water will continue to flow as long as there is a slope to the water surface. The slope of the bottom of the furrow, however, is normally used to indicate the steepness of the furrow. The slope is usually expressed as a percentage (metres per 100 metres, or feet per 100 feet). The slope serves not only to cause the water to flow, but is also necessary to provide for the drainage of excess rainfall or irrigation water from the surface of the field.

Soil erosion is an important limitation on the use of the furrow method. The system must be designed to avoid conditions which would contribute to soil movement. Erosion is related to the erodibility of the soil and the velocity of the water as it enters or moves down the furrow. Erodibility cannot be related to a single soil characteristic, but it tends to be related to

texture. Maximum erodibility is generally associated with noncohesive soils with a predominance of fine sand and silt particles. Clay soils are generally less erodible than sands, but this depends on whether the clay particles disperse under the action of water or whether they are formed into water-stable aggregates. To avoid excessive erosion in irrigating cultivated crops the slope of the furrows in the direction of water movement should not exceed 2 percent. In areas with intense rainfall, soil erosion may result from slopes in excess of 0.3 percent.

Whenever feasible, furrows should be straight and parallel with an edge of the field. If the topography of the land is such that it is not economically feasible to grade the land so that the major slope will not exceed the maximum allowable for furrow irrigation, consideration should be given to changing the direction of the furrows so that the water flows in the direction of the minor slope, or the furrows can be run diagonally across the field to obtain the desired slope (Figure 67).

Grading a field to a uniform plane with slopes in two directions is of particular advantage where crop rotation is practised. Row crops irrigated with furrows can be planted with the rows in the direction of the minor slope, and close-spaced crops can be irrigated by the border method with the levees in the direction of the major slope. This requires moving the supply ditch from one edge of the field to another, so that water can be delivered to the head of the irrigation runs for whichever method is being used at the time.

FIGURE 67. Furrows placed on the diagonal of a field to reduce slope.



## **Contour furrows**

On fields with uneven or warped surfaces it is generally not possible to use straight furrows with a uniform slope. In such cases, furrows are sometimes constructed on a predetermined slope with the direction dictated by the topography. These are called contour furrows.

The furrow patterns are often complicated on uneven terrain in that to maintain a proper spacing between them it is sometimes necessary to start or end the furrows in the interior of the field. Methods for laying out a contour furrow irrigation system have been described by Brown (1963) and Kohler (1953). When used for irrigating annual crops it is necessary to relocate the furrows for each crop.

The limit of land slopes which can be used for irrigating field and vegetable crops with contour furrows is 8 to 10 percent.

Water is generally delivered to the individual furrows by means of gated flumes (Figures 68 and 69) or pipelines. The unit flows delivered into each furrow are relatively small to prevent overflowing of the banks, which could cause serious erosion. This requires using steeper slopes and shorter lengths than those normally used on fields graded to a uniform plane.

A means must be provided for draining the excess rainfall or irrigation water which might collect in the furrows. Grassed waterways located in swales, concrete pipes, or lined ditches with suitable inlets can be used for this purpose.

Sandy soils and soils which develop wide cracks on drying should not be irrigated with contour furrows. Rodent control will be needed to prevent the leakage of water from higher into lower furrows. The irrigator must also use great care to prevent the water from breaking out of the furrows. Any neglect in the management of the water in contour furrow irrigation presents a potentially serious erosion problem.

## **Benched furrows**

Land which is too steep for contour furrows can sometimes be graded with levelled strips (benches) across the slope on which furrows can be constructed (Figures 70A and 70B). The soil should be deep so that the grading operations will not impair its ability to grow a crop. Land with slopes of up to 25 percent can sometimes be benched to permit the production of irrigated crops.

The width of the benches will depend on the general slope of the land. Where orchards are to be planted, each bench must be wide enough for one or more rows of trees; for field or vegetable crops they should be able to take two or more rows of plants.

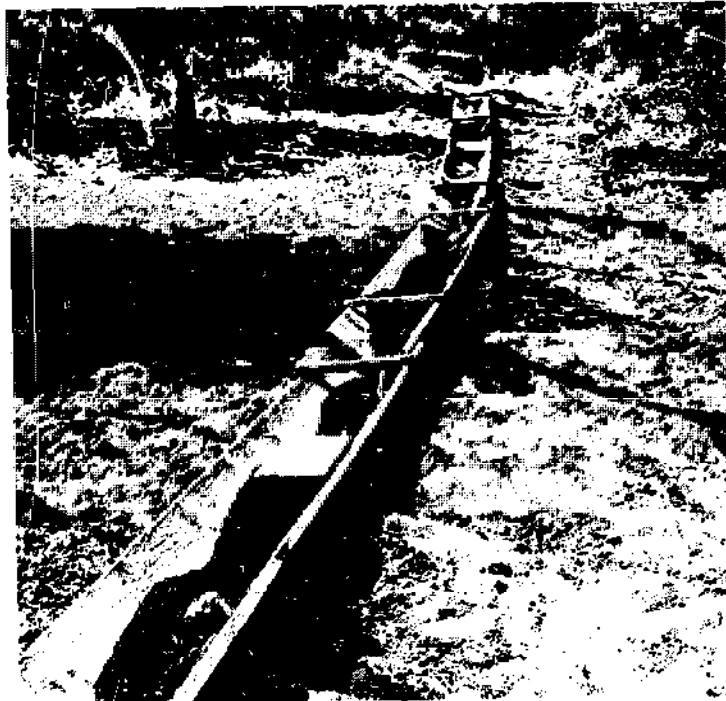

FIGURE 68. Wooden flume conveying water down slope. Water is released into contour furrows irrigating an orchard.

FIGURE 69. Contour furrows irrigated from wooden flume which carries the water down the slope.





The strips are graded with a slope in the direction in which the water will flow in the furrows. So that small streams of water can be used the slopes are generally steeper than for normal furrow irrigation, but should not be so steep as to allow erosion.



FIGURE 70A (above) and 70B (below). Bench terraces planted to citrus trees are irrigated with furrows. The benches have a slight cross-slope toward the hill, and the trees are planted on the outer margin of the terraces.



Because of the small flows used, each furrow should be relatively short. Suggested lengths are 60 to 120 metres on coarse-textured soils, 120 to 180 metres on medium-textured soils, and 180 to 240 metres on fine-textured soils.

Care must be taken to prevent erosion when supplying irrigation water to the benches. Concrete-lined ditches with appropriate drop structures, or concrete, wooden or metal flumes, or pipelines are generally used for conveying the water down the slope. Similar structures are also needed for the safe removal of excess water which might collect on the benches.

### **Zigzag furrows**

Furrows that zigzag are sometimes used to increase the length that water must travel to reach the end of the irrigation run. Increasing the length reduces the average slope and the velocity of the water. This means a given flow of water will run more deeply in the furrows, increasing infiltration into slowly permeable soils. Zigzag furrows are common in the southwestern United States (Figure 71).

A number of different patterns are used in laying out the irregular furrows. Figure 72A shows a method used in vineyards where the land has a moderate slope, while Figure 72B shows a method used on fairly flat slopes.



**FIGURE 71.** Zigzag furrows increase the length of water flow in this orchard in the southwestern United States.

The system used for constructing zigzag furrows will depend on the equipment available. In orchards the furrows are sometimes formed down and across the slope by machines, and the blocking needed to direct the flow of water is done by hand shovelling. Special machines can now make the complete pattern shown in Figure 72B in a single operation.

FIGURE 72.  
A. Zigzag furrows used for irrigating vineyards on land with a moderate slope. The arrows indicate the direction of water flow.  
B. Another zigzag pattern for furrow irrigation on fairly flat slopes.

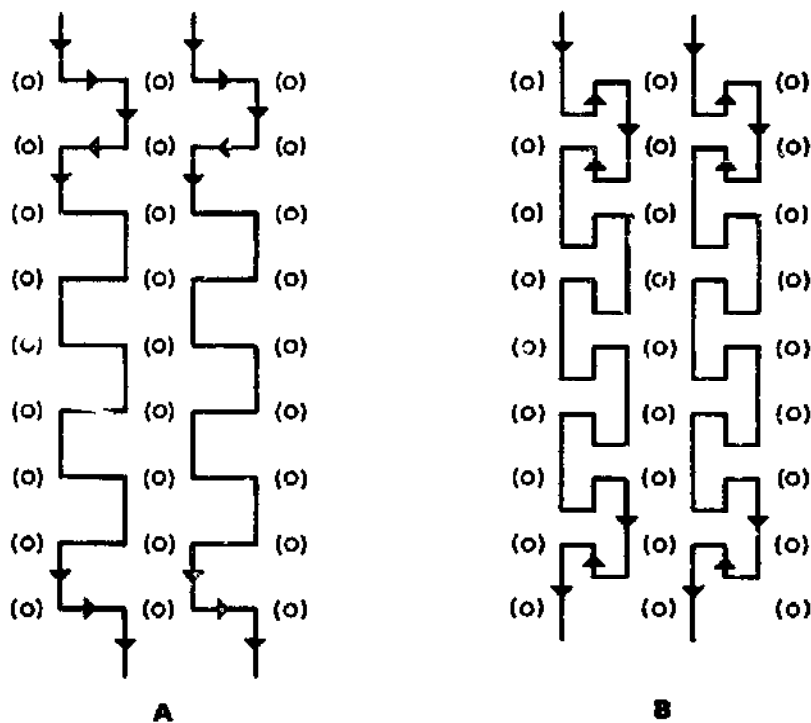

### Furrow lengths

The furrow length must be selected with care. Labour requirements and costs for irrigating increase as the furrows become shorter, while the uniformity of water application usually decreases as the furrows become longer. They should therefore be as long as will permit reasonable efficiency in applying the water.

Short furrows require that the supply ditches or pipelines be spaced at close intervals. This adds considerably to the cost of installing the system. Considerable land may be taken out of production because of the area occupied by the close-spaced ditches. Short furrows require careful regulation of flows and frequent changing of the stream from one furrow to another. Short furrows also make it difficult to use mechanized equipment in planting, cultivating and harvesting.

If the furrows are too long, excessive water may enter the soil at the upper

end of the irrigation run before the lower end is adequately irrigated. This is particularly likely in the case of permeable deep soils with high infiltration rates. Heavy rains falling on soils with low intake rates may cause excessive water to collect in the lower reaches of the furrows if they are too long. This could create an erosion hazard on steeper lands, or injure the crop from flooding over the beds at the lower ends of the furrows.

The length of furrow can be limited by the size and shape of the field. If only a small area is to be irrigated the lengths may be determined by the length of the field. If the area is large, it may be desirable to have the furrow lengths equal to an even fraction of the total length of the field.

Lengths should be adjusted to take changes in soil type into account where soils in the same field have different intake rates. Consideration should also be given to sharp changes in slope within the field. Each irrigation furrow should be confined to similar soils and have a uniform slope.

Cultural practices may influence the length of furrows. Where abundant labour is available and furrows and ridges are constructed by hand, very short furrows may be most suitable. This is often the case where the land is used to produce a variety of vegetable crops. Where agriculture is mechanized it may be more economical to make the furrows long, even if some irrigation efficiency is sacrificed. This would be possible where water supplies are plentiful, water costs are low, and there is no danger of creating a high water table.

The factors which should be given primary consideration in determining maximum furrow lengths are the type of soil, the slope, and the crop to be grown. While the size of stream turned into each furrow is also a factor, it is subject to regulation and hence is to be considered only if the flow might be limited by slope, soil conditions, or the size of furrow used.

With flat slopes (less than 0.3 to 0.5 percent) the length of run can usually be increased as the slope increases. However, with slopes greater than about 0.5 percent the length should be decreased as the slope increases, because unit flow must be reduced to prevent erosion.

Furrows must be shorter for sandy soils, which take water rapidly and have low water-holding capacities, than for clay soils with slow intake rates and high water-holding capacities. Lengths can be increased as the average depth of water to be applied increases. Since the depth of irrigation needed is related to the water-holding capacity of the soil and the depth of rooting of the crop, furrows can be much longer for deep-rooted crops on clay soils than for shallow-rooted crops on sandy soils.

Furrows are sometimes used in combination with basins where the crop must be grown on raised beds to protect the plants from flooding. From three to eight raised beds 1 to 15 metres long are used, and are surrounded by levees (Figure 73). The furrows are irrigated by turning a stream of

water from a supply ditch into the high corner of each basin. The furrows may be open at each or alternate ends. When all the furrows have been filled to the proper depth, the flow of water is shut off.

Field trials testing various rates of water flow in furrows of different lengths, as suggested by Criddle *et al.* (1956) and Marsh (FAO, 1967), should be made in each area to determine the most suitable lengths for different slope and soil conditions. Evaluations of the rate of advance of the water down the furrow and of the average depths of water applied will provide information which can be used for determining which length will give the most adequate and uniform irrigation.

General criteria for the design of furrow irrigation systems cannot be applied to all conditions. Some suggested maximum furrow lengths are given in Table 16, which can be used as a basis for setting up field trials.

### Flow rates

The flow rate, or unit flow, is the size of stream delivered into each furrow. It is generally measured in units of litres per second or gallons per minute. The unit flow is the one factor which can be varied after the furrow irrigation system has been installed. Proper flow in the furrows is of the utmost importance for the efficient use of the irrigation water.

The most uniform distribution is usually obtained by starting the irriga-

FIGURE 73. Garlic growing on broad raised beds which are irrigated by furrows enclosed in basins. Note the straw mulch used to prevent crusting of the soil on the beds.



TABLE 16. - SUGGESTED MAXIMUM LENGTHS OF CULTIVATED FURROWS FOR DIFFERENT SOILS, SLOPES, AND DEPTHS OF WATER TO BE APPLIED

A. Lengths in metres; depths in centimetres

Furrow slope	Average depth of water applied (centimetres)											
	7.5	15	22.5	30	5	10	15	20	5	7.5	10	12.5
	Clays				Loams				Sands			
<i>Percent</i>	<i>Metres</i>											
0.05	300	400	400	400	120	270	400	400	60	90	150	190
0.1	340	440	470	500	180	340	440	470	90	120	190	220
0.2	370	470	530	620	220	370	470	530	120	190	250	300
0.3	400	500	620	800	280	400	500	600	150	220	280	400
0.5	400	500	560	750	280	370	470	530	120	190	250	300
1.0	280	400	500	600	250	300	370	470	90	150	220	250
1.5	250	340	430	500	220	280	340	400	80	120	190	220
2.0	220	270	340	400	180	250	300	340	60	90	150	190

B. Lengths in feet; depths in inches

Furrow slope	Average depth of water applied (inches)											
	3	6	9	12	2	4	6	8	2	3	4	5
	Clays				Loams				Sands			
<i>Percent</i>	<i>Feet</i>											
0.05	1 000	1 300	1 300	1 300	400	900	1 300	1 300	200	300	500	600
0.1	1 100	1 400	1 500	1 600	600	1 100	1 400	1 500	300	400	600	700
0.2	1 200	1 500	1 700	2 000	700	1 200	1 500	1 700	400	600	800	1 000
0.3	1 300	1 600	2 000	2 600	900	1 300	1 600	1 900	500	700	900	1 300
0.5	1 300	1 600	1 800	2 400	900	1 200	1 500	1 700	400	600	800	1 000
1.0	900	1 300	1 600	1 900	800	1 000	1 200	1 500	300	500	700	800
1.5	800	1 100	1 400	1 600	700	900	1 100	1 300	250	400	600	700
2.0	700	900	1 100	1 300	600	800	1 000	1 100	200	300	500	600

tion with the largest unit flow that can be safely carried in the furrow. With short flat furrows a large flow is used to fill the furrows quickly, the flow is shut off, and the ponded water is allowed to infiltrate into the soil. With long sloping furrows it is generally necessary to regulate the flow during the irrigation. For the desired wetting of the soil the water should, whenever possible, reach the end of the furrow within a quarter of the total time that water must be carried in the furrow.

The maximum flow rate allowable at the start of the irrigation is determined by the need to prevent excess runoff, overtopping of the beds, and soil erosion. In some areas the concept of "maximum nonerosive flow rate" based on the slope of the furrow is used. Although soil erodibility is also a factor, the maximum nonerosive flow in furrows can be estimated from

$$Q_m = \frac{C}{S}$$

where  $S$  is the slope expressed as a percentage,  $C$  is 0.60 when  $Q_m$  is in litres per second, or  $C$  is 10 when  $Q_m$  is in U.S. gallons per minute.

An analysis of nonerosive flow rates, suggested by Marr (1967), is given for several critical slopes in Table 17.

TABLE 17. - RELATION OF MAXIMUM NONEROSIVE FLOW RATES TO CRITICAL SLOPES IN FURROWS<sup>1</sup>

Furrow slope, $S$	Maximum flow rate, $Q_m$		Comments
	<i>Litres per second</i>	<i>U.S. gallons per minute</i>	
0.1	6.0	100	The flow rate indicated is about double the carrying capacity of most furrows in normal use on a 0.1 percent slope. Erosion is negligible with furrows flowing to capacity on this slope.
0.3	2.0	33	A slope of 0.3 percent is near the upper limit where furrows flowing at capacity will not cause serious erosion.
0.5	1.2	20	Cultivated furrows with 0.5 percent slope will erode unless the flow rate is considerably less than furrow capacity.
2.0	0.3	5	This indicates the reduction in flow rate needed to prevent serious erosion on a 2 percent slope. This is considered to be the maximum slope allowable for cultivated furrows.

<sup>1</sup> Based on the equation  $Q_m = \frac{C}{S}$

Flow rate must sometimes be adjusted to maintain the flow without losing water by surface runoff at the end of the furrow. This is accomplished by reducing the unit flow to the minimum required when the water approaches the end of the furrow. The reduced flow rate under this ideal condition is equal to the rate that water is infiltrating into the bed and the sides of the furrow. Since the infiltration rate will generally decrease with the length of time that water runs in the furrow, the irrigator must use considerable judgement in reducing the flow to the proper rate.

The initially high infiltration capacities of some soils decline in a short time to very low intake rates. In such cases the need for cutting back on the unit flow is questionable. The irrigation can be started with a unit flow considerably less than the safe capacity of the furrow and be allowed to continue to flow at the same rate until the entire length of the furrow is properly irrigated. This often reduces the labour required for irrigation without particularly reducing irrigation efficiency.

Excess water reaching the ends of the furrows can be taken care of by ponding it in the furrows, by allowing it to back up into adjacent dry furrows, or by wasting it into a drainage ditch at the lower edge of the field. In the last case it is desirable to provide some means of controlling the waste water so that it can be used again for irrigation.

In some highly developed irrigated areas the water is collected in the low corner of the field and pumped back through a pipeline to the head end to be used again on the same field (Figures 74 and 75). Such return-flow systems greatly reduce the amount of labour required for controlling flow in the furrows. Irrigation return-water systems are described by Houston and Schade (1966).

### **Regulating the flow of water into furrows**

Various devices are used for controlling the flow of water into each furrow. Since it is generally desired to deliver nearly equal flows into a number of furrows at one time, use is made of the hydraulic concept that outlets of equal size operating under the same pressure head will have equal flows. Rates of flow are changed during the irrigation by altering the size of the outlets.

Where the water supply to the field is delivered in an open ditch, the most popular type of outlet is the irrigation siphon pipe (Figure 76). These are usually preformed from aluminium or plastic pipe, but are sometimes made of flexible butyl rubber. They are easy to install and remove without disturbing the ditch bank, and their portability reduces the number required. The flow can be regulated by changing the pressure head, varying the size



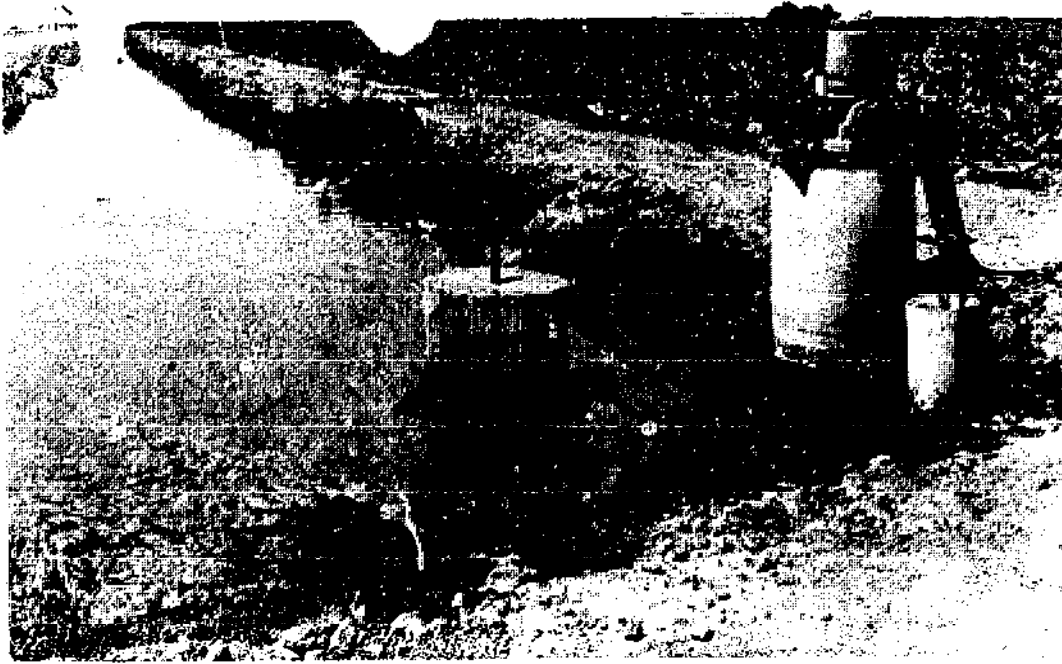
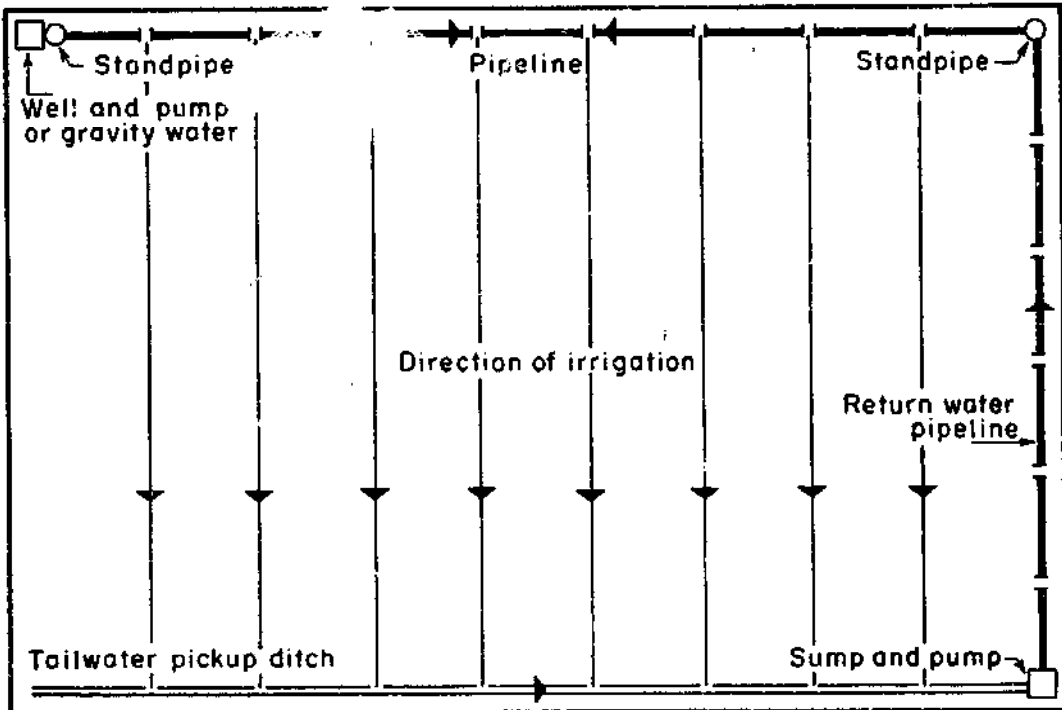

FIGURE 74. Tailwater pickup ditch at end of field, and low-lift pump used for returning the water to the upper end for use again on the same field.

FIGURE 75. Plan for a return-flow system used in conjunction with an underground pipeline distribution.



or number of siphons used in each furrow, or adjusting a slide gate attached to the inlet end of each siphon. The most satisfactory method is to use a number of small siphons to deliver the maximum nonerosive stream into each furrow at the beginning of the irrigation, and to remove several siphons when the water reaches the end, thereby adjusting the desired flow in the furrow up to the end of the irrigation.

Spiles are also used. These are short pipes placed through the ditch bank, installed at the beginning of the irrigation period and not removed until it ends. This means that a spile must be used for each furrow. They must be large enough to deliver the maximum flow needed. Flow is regulated by obstructing the inlet end, which can be done by placing a lath partly across the opening or by other means. Care must be taken to install spiles at the proper elevation so that the same flow enters all the furrows being irrigated at the same time.

Table 18 gives the flow through various sizes of siphons and spiles operated under different pressure heads. The pressure head is the difference in elevation between the water surface in the ditch and the centre of the outlet (if flowing) or the water surface above the outlet (if submerged).

Open cuts in the ditch banks should not be used for releasing water into

FIGURE 76. Water from buried concrete pipeline being released through alfalfa valve into temporary earthen ditch. Siphons deliver water from ditch into furrows.



TABLE 18. - FLOW THROUGH SMALL SIPHONS AND SPILES

A. Flow in litres per second

Diameter of siphon or spile	Pressure head (centimetres)							
	2.5	5	7.5	10	12.5	15	17.5	20
<i>Centi- metres</i>	<i>Litres per second</i>							
1	0.03	0.05	0.06	0.07	0.07	0.08	0.09	0.09
2	0.13	0.19	0.23	0.26	0.30	0.32	0.35	0.73
3	0.30	0.42	0.51	0.59	0.66	0.73	0.79	0.84
4	0.53	0.75	0.91	1.06	1.18	1.29	1.40	1.49
5	0.83	1.17	1.43	1.65	1.85	2.02	2.18	2.33
6	1.19	1.68	2.06	2.38	2.66	2.91	3.14	3.36
7	1.62	2.29	2.80	3.24	3.62	3.96	4.28	4.58
8	2.11	2.99	3.66	4.23	4.72	5.18	5.59	5.98
9	2.67	3.78	4.63	5.35	5.98	6.55	7.07	7.56
10	3.30	4.67	5.72	6.60	7.38	8.09	8.73	9.34

B. Flow in U.S. gallons per minute

Diameter of siphon or spile	Pressure head (inches)							
	1	2	3	4	5	6	7	8
<i>Inches</i>	<i>U.S. gallons per minute</i>							
0.5	0.8	1.2	1.5	1.7	1.9	2.1	2.3	2.4
0.75	1.9	2.7	3.3	3.8	4.3	4.7	5.1	5.4
1.0	3.4	4.8	5.9	6.8	7.6	8.3	9.0	9.6
1.25	5.3	7.5	9.2	10.6	11.9	13.0	14.1	15.0
1.5	7.7	10.8	13.3	15.3	17.2	18.8	20.3	21.7
2.0	13.6	19.3	23.6	27.2	30.6	33.4	36.0	38.5
2.5	21.3	30.1	36.9	42.6	47.8	52.1	56.3	60.2
3.0	30.6	43.3	53.1	61.3	68.8	75.1	81.1	86.7
3.5	41.7	59.0	72.2	83.4	93.7	102.0	110.0	118.0
4.0	54.5	77.0	94.3	109.0	122.0	133.0	144.0	154.0

the furrows unless an auxiliary ditch (sometimes called a forebay) is used (Figure 77). This is a short ditch constructed parallel with and below the supply ditch, from which the water can be released for delivery into a number of furrows. A gate is placed in the ditch bank for the safe control of the release of water into the auxiliary ditch. Siphons and spiles can be used for releasing water from the auxiliary ditch into the furrows. Such auxiliary ditches are also used with flumes and pipelines for delivering irrigation water to the fields.



FIGURE 77. An auxiliary ponding area used with furrow irrigation. A siphon delivers the water into the ponded area, and spiles release the water from the ponded area into the furrows.

There are a variety of methods for distributing water from pipelines to the furrows. If the pipelines are buried, risers with valves are normally spaced at frequent intervals to release the water at the ground surface. Temporary earth ditches may be constructed between the valves, and the water can be delivered from these into the furrows through siphons or spiles. Portable metal, plastic or rubber pipes with outlet gates may be connected to the valves by means of hydrants. The outlet gates are spaced the same distance apart as the furrows, and are provided with slides or other devices for regulating the flow into the furrows. In orchards and vineyards, special distributing hydrants fitted over the valves can release water into from four to eight furrows. These hydrants can be permanent or portable and are normally located in line with the tree or vine rows.

#### **Average depth of water applied**

The average depth of water applied during an irrigation can be computed from the following equation, if the flow rate, the duration of the irrigation and the area irrigated (furrow spacing  $\times$  furrow length) are known

$$\text{millimetres per hour} = \frac{\text{litres per second} \times 3\,600}{S_m \times L_m}$$

where  $S_m$  is the spacing of furrows in metres, and  
 $L_m$  is the length of furrow in metres;

$$\text{or inches per hour} = \frac{\text{gallons}^1 \text{ per minute} \times 96.3}{S_f \times L_f}$$

where  $S_f$  is the spacing of furrows in feet, and  
 $L_f$  is the length of furrow in feet.

For example, furrows spaced 0.9 metre apart and 210 metres long are irrigated with an initial flow rate of 2.2 litres per second for 1.5 hours, and then the flow rate is reduced to 0.5 litre per second for 5.3 hours. The rate that water is being applied during the initial period is

$$\frac{2.2 \times 3\,600}{0.9 \times 210} = 42 \text{ millimetres per hour}$$

and during the final period the application rate is:

$$\frac{0.5 \times 3\,600}{0.9 \times 210} = 9.5 \text{ millimetres per hour}$$

The average depth of water applied is:

$$\begin{aligned} 1.5 \text{ hours} \times 42 \text{ millimetres per hour} &= 63 \text{ millimetres} \\ 5.3 \text{ hours} \times 9.5 \text{ millimetres per hour} &= \underline{50 \text{ millimetres}} \\ \text{Total depth applied} &= 113 \text{ millimetres} \end{aligned}$$

This is the average depth of water applied during the irrigation and does not mean that 113 millimetres in depth was applied uniformly to each section of the furrow. Soil sampling can be used to check the uniformity of water penetration at different points along the furrow.

If siphons or spiles are used for releasing into the furrows the flow shown in the example, and the pressure head available is 10 centimetres, the size

<sup>1</sup> U.S. gallons. If imperial gallons per minute are used, substitute 80.2 for 96.3.

of outlets required can be determined from Table 18. Four siphons of 3-centimetre diameter could be used for starting the irrigation, and after the water reaches the end of the furrow the flow could be cut back by removing three of the siphons.

## 11. CORRUGATION IRRIGATION

In corrugation irrigation the water flows down the slope in small furrows, called corrugations or rills. This method is most often used for irrigating uncultivated close-growing crops such as small grains, lucerne or pasture on steep slopes. It can also be used in conjunction with flooding methods on land with relatively flat slopes, to help obtain uniform water coverage.

One requirement of this method is that the conducting channels for the water do not interfere with the use of farm machinery during moving or harvesting operations. It therefore differs from furrow irrigation in that no raised beds are used for crops.

The corrugations are V- or U-shaped channels about 10 centimetres deep, spaced 40 to 75 centimetres apart. The entire soil surface is wetted slowly by the capillary movement of the water flowing in the corrugations. This method of wetting the soil minimizes the crusting effect on the surface, which is a problem when the entire surface is flooded. For this reason, corrugation irrigation is sometimes used for germinating crops which have been drill- or broadcast-seeded. Flooding methods may be used after the plants become established.

### Soils

Corrugation irrigation is most suitable for use on silt loam or clay loam soils, in which the lateral movement of water takes place readily. Clay soils, which take water slowly, are difficult to irrigate by this method unless the slopes are quite flat or water can be held in the corrugations for a considerable time. This method is not recommended for sandy soils with high intake rates, because excessive water will be lost by deep percolation before the entire soil surface is wetted.

The corrugation method should not be used on saline soils or where the irrigation waters have a high salt content. The capillary movement and

subsequent evaporation of the water will tend to concentrate the salts in the surface soils.

### **Land preparation**

Land grading for corrugation irrigation is generally limited to removing minor irregularities in the soil surface. The slopes in the direction of irrigation must be continuous, although not necessarily uniform. This may require moving some earth to eliminate small raised areas. Depressions should be filled in to provide surface drainage and to prevent ponding of water. Smoothing the land surface will also facilitate the use of planting and harvesting equipment.

Since corrugation irrigation requires little investment for land preparation, it is sometimes used as an expedient method on gently sloping land which is capable of being uniformly graded. This permits the irrigating of crops until land grading can be done properly. Once the land surface has been graded to a uniform slope other methods of irrigation are generally used.

### **Slope**

The corrugations should always be made in the direction of the steepest slope. They often become blocked by soil or plant debris, causing the water to overflow the small channels. If the corrugations are placed across the slope the overflow will move down into the next lower corrugation. This combined flow is likely to exceed the capacity of the corrugation, causing the water to break over again into the next lower one. Eventually, then, water from many corrugations can become concentrated into a single stream flowing down the slope. The hazard of serious soil erosion can be minimized by running the water in the direction of the steepest slope, thereby eliminating any cross slope.

The maximum slope which can be used for corrugation irrigation will depend on the erodibility of the soil and the type of crop being grown. Low-growing plants, such as those used for pasture, tend to grow into the channels, so that the corrugations serve only as guides for the water. In this case the system becomes a combination of corrugation and wild flooding. Low-growing plants provide excellent protection against erosion, and slopes of 10 percent or more can be used. Lucerne provides less protection than pasture, and grains provide still less, but careful control of the water and the small streams will minimize erosion when these crops are grown on steep slopes.



### **Length of runs**

Care should be taken in locating the head ditches which supply water to the corrugations so that the irrigation runs will not be too long. If they are excessively long water may be wasted by deep percolation losses at the upper end before the soils at the lower end are adequately watered.

To prevent uneven water distribution from abrupt changes in slope within a single run, head ditches can be placed across the slope where there are sharp breaks in the topography. This will permit nearly uniform slopes for each run, and the flow of water can thus be regulated more closely to fit the slope. This rule also applies to major changes in soil types.

The spacing of the corrugations will depend on how rapidly the water moves laterally through the soil. They can generally be farther apart on fine-textured than on coarse-textured soils, and should be closer on steep slopes than on flat slopes.

Table 19 gives the recommended lengths of runs and spacing of corrugations for various conditions.

### **Forming the corrugations**

Corrugations are usually made after the field has been seeded. To obtain maximum carrying capacity for the water, the soil on the periphery of the corrugations should be compressed and made smooth.

Several types of implement are used for forming the channels. A sled-type corrugator with two or more runners, described by Stanley (1954), can be used for pressing the corrugations into loose soils (Figure 78). The runners are shaped to form the corrugations required and spaced the

TABLE 19. -- LENGTH AND SPACING OF CORRUGATIONS

A. Distances in metres

	Slope	Fine-textured clay soils		Medium-textured loam soils		Coarse-textured sandy soils	
		Length	Spacing	Length	Spacing	Length	Spacing
	<i>Percent</i>	<i>Metres</i>					
Deep-rooted crops or deep soils	2	180	0.75	130	0.75	70	0.60
	4	120	0.65	90	0.75	45	0.55
	6	90	0.55	75	0.65	40	0.50
	8	85	0.55	60	0.55	30	0.45
	10	75	0.50	50	0.50		
Shallow-rooted crops or shallow soils	2	120	0.60	90	0.60	45	0.45
	2	85	0.55	60	0.55	30	0.45
	6	70	0.55	50	0.50		
	8	60	0.50	45	0.45		
	10	55	0.45	40	0.45		

B. Distances in feet

	Slope	Fine-textured clay soils		Medium-textured loam soils		Coarse-textured sandy soils	
		Length	Spacing	Length	Spacing	Length	Spacing
	<i>Percent</i>	<i>Feet</i>					

desired distance apart. Weights can be added to the platform of the sled to provide the necessary pressing force as it is pulled across the field (Figure 79).

A shovel-type corrugator can also be used, attached directly to the rear of a wheel tractor or mounted separately on wheels. This type is generally preferred for making corrugations in heavy clay soils. The small shovels open the soil so that a compaction wheel or skid which follows can shape, smooth and compress the soil. Any loose soil remaining on the edges of the corrugations must be spread evenly over the surface to prevent its falling back into and clogging the channels.



FIGURE 79. Corrugations which have been pressed into the soil by the corrugator (on right). Barrels filled with water add the weight needed to form the indentations in the soil. These corrugations will be used for irrigating pasture on flat land.

### **Flow of water in corrugations**

The rules governing the flow of water in furrows apply also to corrugations. The flow at the beginning of the irrigation should be as large as can safely be carried in the corrugations without causing erosion. Because of the small flows used, the practice of cutting back flow when the water approaches the end is not feasible.

The formula for determining the maximum nonerosive stream for furrow irrigation can be applied also to corrugations. Table 20 shows the max-

imum safe flow that can be carried for different slopes, based on this formula.

Where the slope of corrugations is not uniform, it is necessary to determine the slope that is applicable. Experience in irrigating each field is generally needed to decide the flows which should be turned into the corrugations to obtain the best irrigation.

TABLE 20. - MAXIMUM NONEROSIVE FLOW RATES THAT SHOULD BE USED IN CORRUGATIONS ON VARIOUS SLOPES

Corrugation slope	Maximum flow rate	
	<i>Percent</i>	<i>Litres per second</i>
2	0.30	5.0
4	0.15	2.5
6	0.10	1.7
8	0.08	1.2
10	0.06	1.0
12	0.05	0.8

Some means of regulating the flow of water into the corrugations is necessary. The water may be released directly from the head ditch into the corrugations by the use of siphons, spiles or breaks in the ditch bank; or the water from the head ditch may be released first into an equalizing basin, or subhead ditch, from which the water is released into the corrugations. The equalizing basins are usually long enough to irrigate 10 to 20 corrugations at one time. The flows that will be delivered through small siphons or spiles for various pressure heads are given in Table 18.

Siphon tubes, made of metal, plastic or rubber, are generally preformed to fit the shape of the ditch bank. They can be equipped with slide gates on the inlet end to regulate the amount of water they deliver into the corrugations.

Spiles may be metal or plastic pipes, square pipes made of four wooden laths, or short sections of bamboo, placed through the ditch bank. Care should be taken to place them at the proper elevation to obtain a uniform flow through each. Earth should be tamped around the spiles to prevent

leakage along the outside. The flow can be regulated by covering part of the inlet opening with a lath, forced into the soil to hold it firmly in place.

When the water is released through open cuts in the ditch bank, the cuts should be lined with canvas, paper, burlap or grass sod to prevent the water from eroding the sides and bottom. Metal plates with notches sized to release the flow needed can also be placed across the cuts to control the water. The depth to which the plate is thrust into the soil can be adjusted for raising or lowering the elevation of the notch in order to regulate the flow.

## 12. DRIP IRRIGATION

The application of water to the soil through small orifices is known as drip, trickle or dribble irrigation. The small orifices, often called emitters, are designed to discharge water at rates of 1 to 8 litres per hour. Water is delivered to the orifices through plastic pipelines; these are generally laid on the soil surface, but can be buried. The rate of discharge is determined by the size of the orifice and the pressure in the pipelines. Pressure may vary for different systems from 0.15 to 2 atmospheres (2 to 30 pounds per square inch). The systems are usually designed so that water can be applied at intervals, according to the needs of the crops being grown.

The complete drip system should include screens or filters for removing suspended particles which might plug the small orifices. It usually includes an injector for adding fertilizers to the irrigation. Where the water supply comes from a well or community system, a vacuum-breaker control valve should be installed to prevent any backflow of chemicals into the water source. Drip systems can be installed with an automatic control valve which starts and stops the flow; it can be set to operate at specified times, or to turn off after a predetermined volume of water has been applied. Moisture-sensing devices, located in the irrigated area to indicate when irrigation is necessary and automatically regulate flow from the emitters, have not yet proved successful, but show some promise for the future.

### **Requirements of drip systems**

The drip system must meet the same basic requirements as other methods of irrigation. Enough water must be applied to satisfy the needs of the crop being grown. A readily available supply of soil moisture must be maintained in most of the root zone during the entire growing season. Excessive wetting must be avoided if the roots are to have a healthy environment.

The water requirements of crops are closely related to the leaf area exposed to sunlight and the amount of heat energy (solar radiation plus

advective heat sources) available to cause transpiration losses from the plant leaves and evaporation from wet soils. Newly planted crops shade only a small portion of the soil area and have a much lower water requirement than mature crops, which shade most of the area. Additional water may be required for leaching, to maintain a favourable salt balance in the soil.

The drip irrigation system must be adequate to satisfy the peak daily water requirement of the crop. Table 21 shows the continuous flows necessary for crops planted at different spacings. Since it is desirable to cycle the water so that the crops are irrigated at intervals, the system capacity must be adjusted accordingly. For example, to determine the flow capacity required for each tree in a mature orchard with a peak water requirement of 6 millimetres per day, with the trees planted 6 metres apart and the emitters operated 8 hours each day: Table 21 shows that a continuous flow of 9 litres per hour will provide 6 millimetres of water daily for each tree occupying an area of 6 × 6 metres. As the emitters are operated for only one third of the 24 hours, the flow capacity required would be 27 litres per hour. If each emitter has a capacity of 4.5 litres per hour, 6 emitters would be required for each tree.

### **Uses of drip irrigation**

Although drip irrigation is used for crops grown under a wide range of conditions, as described in FAO (1973f), it is particularly beneficial in some specific cases.

In temperate areas where irrigation is supplemental to rains during the growing season, drip irrigation can provide the additional water needed by the crops during short dry periods. Uniformity of water application to the entire root is not usually an important factor in these conditions.

The drip system is efficient for irrigating newly planted orchards and vineyards. Young trees and vines have a limited leaf area exposed to sunlight, and so have a lower water requirement than mature plants. Frequent light irrigations can be applied close to the plants to keep moisture available in the limited root zone without wetting the soil beyond the extent of the root system. As the rooting system expands the soil volume which must be irrigated increases, and additional emitters will be necessary to supply the extra water needed.

Relatively close-spaced perennial crops, such as artichokes, bananas and vines, have responded favourably to drip irrigation. Adequate soil moisture can be supplied using only a few emitters for each plant.

Drip irrigation allows the use of water with a relatively high salt content for irrigating vegetable crops grown on raised beds. With furrow irrigation,

TABLE 21. - CONTINUOUS FLOWS REQUIRED TO SATISFY PEAK WATER REQUIREMENTS OF MATURE PLANTS AT VARIOUS SPACINGS

A. Flow in litres per hour

Plant spacing	Peak daily water requirement (millimetres)						
	2	3	4	5	6	8	10
<i>Metres</i>	..... <i>Litres per hour</i> .....						
0.5 × 1	0.04	0.06	0.08	0.10	0.12	0.16	0.21
1.5 × 3	0.38	0.56	0.75	0.94	1.12	1.50	1.88
2 × 4	0.67	1.00	1.33	1.67	2.00	2.67	3.33
3 × 6	1.50	2.20	3.00	3.80	4.50	6.00	7.50
5 × 5	2.10	3.10	4.20	5.20	6.20	8.30	10.40
6 × 6	3.00	4.50	6.00	7.50	9.00	12.00	15.00
7 × 7	4.10	6.10	8.20	10.20	12.20	14.30	20.40
8 × 8	5.30	8.00	10.70	13.30	16.00	21.30	26.70
10 × 10	8.30	12.50	16.70	20.80	25.00	33.30	41.70
12 × 12	12.00	18.00	24.00	30.00	36.00	48.00	60.00
14 × 14	16.30	24.50	32.70	40.80	49.00	65.30	81.70
16 × 16	22.20	33.20	44.30	55.40	66.50	88.70	110.80

B. Flow in U.S. gallons per hour

Plant spacing	Peak daily water requirement (inches)						
	0.10	0.15	0.20	0.25	0.30	0.35	0.40
<i>Feet</i>	..... <i>U.S. gallons per hour</i> .....						
1.5 × 3	0.01	0.02	0.02	0.03	0.04	0.04	0.05
3 × 6	0.05	0.07	0.09	0.12	0.14	0.16	0.19
6 × 9	0.14	0.21	0.28	0.35	0.42	0.49	0.56
10 × 20	0.52	0.78	1.04	1.30	1.56	1.82	2.08
15 × 15	0.58	0.88	1.17	1.46	1.75	2.04	2.34
20 × 20	1.04	1.56	2.08	2.60	3.11	3.64	4.16
22 × 22	1.26	1.88	2.51	3.14	3.78	4.40	5.00
25 × 25	1.60	2.40	3.20	4.10	4.90	5.70	6.50
30 × 30	2.30	3.50	4.70	5.80	7.00	8.20	9.35
35 × 35	3.70	5.60	7.40	9.20	11.10	13.00	14.80
40 × 40	4.20	6.20	8.30	10.40	12.50	14.50	16.60
50 × 50	6.50	9.70	13.00	16.20	19.50	22.70	26.00



yields of salt-sensitive crops are often reduced by waters containing dissolved salts in excess of 0.75 millimhos/centimetre because the salts move with the water into the beds. With sprinkler irrigation, absorption of salts by the leaves can be toxic to plants if the water contains sodium or chloride in excess of 3 milliequivalents per litre. Using drip irrigation with the emitters placed along the plant rows, the salts are moved with the water away from the plant roots. Vegetables irrigated by the drip system with water containing dissolved salts up to 4 millimhos/centimetre have given satisfactory yields. The salts move with the water and accumulate at the periphery of the wetted zone. Where rainfall is not sufficient to leach these salts below the rooting depth in the soil, it is usually necessary to leach the soil with sprinkler or flood irrigations between crops.

### **Dangers from salt accumulation in the soil**

Dissolved salts in the soil solution will move in the direction of the water movement in the soil. Salts will normally accumulate at the periphery of the volume of soil wet by the emitters, and at the soil surface when evaporation occurs, as discussed by Rolland (FAO, 1972b).

When roots extract moisture from the soil a reversal in the flux of the water from the periphery back into the root zone can take place. In saline soil conditions, the plants can be injured by this reverse movement of the salts if irrigations are too infrequent. Irrigations must therefore be scheduled carefully to make sure that the roots have a continuous supply of readily available moisture. Tensiometers can sometimes be used to indicate the moisture potential of the soil.

Salts which have accumulated on the surface can be leached into the soil by rain and create a toxic condition in the root zone. It is desirable to continue irrigating with the drip system during rainy periods. This will dilute the salts in the soil solution and continue the flux of the water away from the roots toward the periphery of the wetted soil volume. The flow of water from the emitters should continue until enough water has been added to the soil by rain or by the emitters to make sure that excessive salts have been leached from the root zone. For shallow-rooted crops this usually requires a depth of about 50 millimetres of water added to the soil.

### **Types of emitters**

Various devices are used for controlling the release of water on to the soil. One of the earliest drip irrigation systems uses short lengths of flexible

plastic tubing of small diameter. The tubing is inserted through holes in the walls of the supply lines (Figure 80). This is commonly referred to as the "spaghetti" or "microtube" system, often used for irrigating container-grown plants in nurseries. It is widely used in Australia for irrigating orchards and row crops, described by Black (1969). Table 22 gives the flow from different lengths of 0.96-millimetre (0.038-inch) polyethylene tubing under various pressures.

A modification of the spaghetti system, developed by Symcha Blass in Israel and described by Goldberg and Shmueli (1970), utilizes a long spiral coil encased in a plastic unit as a path for the flow of water. A similar device developed by Rinkewich causes the water to flow through a labyrinthine path, about 2.44 metres long, within a plastic unit, before it is released on the soil. These plastic units have a hollow centre, and the ends are connected directly to the supply tubing at any desired spacing. Discharge rates vary from 0.4 to 8 litres per hour, depending on the pressure in the supply line.

Another method for releasing small flows of water uses plastic tubing with small perforations in the walls (Figure 81), sometimes called "soakers." The water must be filtered to prevent plugging of the small holes. Some systems utilize double-walled tubing. The inner wall usually has only a quarter as many perforations as the outer wall; water will generally continue to flow through the outer perforations even if some of those in the inner tubing become plugged. These systems release a nearly uniform flow throughout their length. A typical system, with the outer perforations spaced 0.5 metre apart, will release 1 litre per minute for each 30 metres of length when operated at 0.1 atmosphere (1.5 pounds per square inch) of pressure. The total length of any line should be limited to about 100 metres.

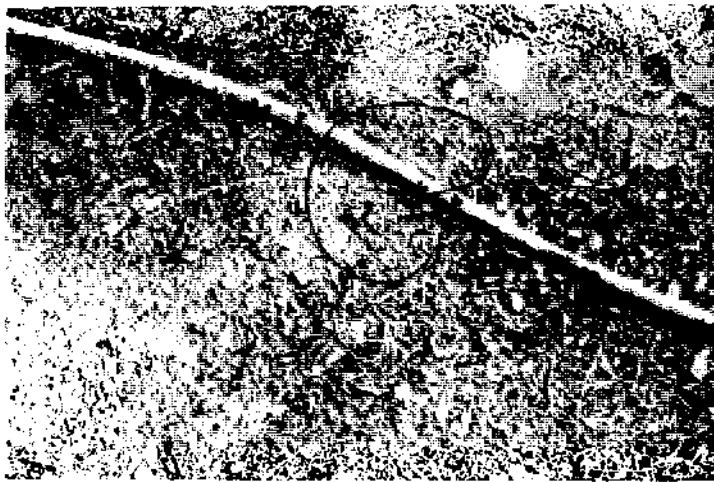

FIGURE 80. Small tubing of 0.86-millimetre diameter inserted into a 12.5-millimetre supply line as an emitter for a drip irrigation system.



FIGURE 81. Double-wall polyethylene tubing with small perforations used to irrigate staked tomatoes.

A number of plastic units containing an orifice outlet are manufactured. Most are designed to release a predetermined flow of water at a given pressure (Figure 82). Some have an adjustable screw over the outlet which permits regulation of flow. Others have ingenious devices utilizing a diaphragm, plunger or ball which provide automatic flushing of the orifices when water is first delivered into the supply lines. Some emitters are attached to plastic tees which can be connected to the supply lines. Others have stems which can be inserted through the walls of the supply tubing.

### **Performance of emitters**

The water discharged by the emitters will spread on the surface before being absorbed by the soil. The area flooded will depend on the rate at

TABLE 22. - FLOWS FROM POLYETHYLENE TUBING EMITTERS OF 0.96-MILLIMETRE (0.038-INCH) DIAMETER

A. Flows in litres per hour

Length of tubing	Pressure in supply line (atmospheres)						
	0.10	0.20	0.30	0.50	0.75	1.00	1.50
<i>Centi-metres</i>	<i>..... Litres per hour .....</i>						
7.5	6.10	10.40	13.9	20.2	27.2	33.2	44.7
15	4.10	6.70	9.0	12.8	17.0	20.7	27.4
25	2.90	4.70	6.3	8.9	11.8	14.4	19.0
35	2.30	3.70	4.9	7.0	9.3	11.3	15.0
50	1.80	2.90	3.8	5.5	7.3	8.8	11.7
75	1.40	2.20	2.9	4.2	5.6	6.8	9.0
100	1.10	1.80	2.4	3.4	4.5	5.5	7.3
125	0.96	1.60	2.0	2.9	3.9	4.7	6.3
150	0.84	1.40	1.8	2.6	3.4	4.2	5.5
175	0.75	1.20	1.6	2.3	3.0	3.7	4.9
200	0.69	1.10	1.5	2.1	2.7	3.3	4.4
250	0.60	0.97	1.3	1.8	2.4	2.9	3.8
300	0.53	0.85	1.1	1.6	2.1	2.6	3.4

B. Flows in U.S. gallons per hour

Length of tubing	Pressure in supply line (pounds per square inch)						
	1	2	4	7	10	15	20
<i>Inches</i>	<i>..... U.S. gallons per hour .....</i>						
3	1.40	2.20	3.50	5.20	6.60	8.70	10.60
6	0.87	1.40	2.20	3.20	4.10	5.40	6.60
9	0.64	1.00	1.60	2.40	3.10	4.10	5.00
12	0.53	0.84	1.30	2.00	2.60	3.40	4.10
18	0.40	0.64	1.00	1.50	1.90	2.60	3.10
24	0.33	0.53	0.84	1.30	1.60	2.10	2.60
30	0.28	0.45	0.72	1.10	1.40	1.80	2.20
36	0.25	0.40	0.64	0.94	1.20	1.60	1.90
48	0.20	0.32	0.52	0.77	0.98	1.30	1.60
72	0.15	0.24	0.39	0.58	0.74	0.98	1.20
96	0.13	0.20	0.33	0.48	0.61	0.81	0.98
120	0.11	0.18	0.28	0.41	0.53	0.69	0.84
144	0.10	0.15	0.25	0.36	0.46	0.61	0.74

FIGURE 82. A self-flushing plastic emitter connected to polyethylene tubing, used to irrigate an avocado orchard.



which water flows from the emitters and the infiltration rate of the soil, as shown in Table 23. If the land is level the water will spread out to form a wetted circle. If the land slopes the water will move downslope in an irregular pattern.

After the water infiltrates it will move vertically and laterally in the soil. The shape of the wetted soil volume will depend on the capillary conductivity of the soil, and whether there are stratifications which impede downward movement, as described by Doneen (FAO, 1971f). The rate of flow from the emitters can also influence the wetting pattern. Where drip irrigation is used on well-drained coarse-textured soils the diameter of the wetted soil volume may be less than 1 metre across. Experience in Israel, reported by Boaz (1971), indicates that drip irrigation has not been very successful on shallow gravelly soils. If the soil is a tight clay with a very low intake rate, water may pond on the surface for prolonged periods. With such soils the emitters should be operated at short intervals so that the water will have an opportunity to infiltrate between irrigations. The best results have been obtained with medium-textured soils which have some slight stratification. Where soils are shallow and underlain with a highly impervious stratum, extreme care must be taken to avoid saturating the soil in which the roots are growing.

The wetting pattern will determine the number of emitters required to irrigate a given area. This will not only decide the spacing of the emitters along the lateral line but also the allowable spacing between lateral lines. The wetting pattern is also a determining factor in selecting the rate of flow that should be discharged by the emitters.

In orchards with wide-spaced trees, two or more lateral lines may be required for each row of trees, or a looped line with several emitters may

be placed in a ring around each tree. For annual crops planted on beds spaced about 1 metre apart, a lateral line is usually required for each bed. The wetting pattern from a single emitter must be known for the type of soil before a drip irrigation system can be properly designed. No infor-

TABLE 23. — SURFACE AREAS FLOODED BY DRIP EMITTERS

A. Areas in square metres

Emitter flow	Soil infiltration rate (centimetres per hour)					
	0.25	0.50	0.75	1.00	1.25	1.50
<i>Litres per hour</i>	..... <i>Square metres</i> .....					
1	0.4	0.2	0.13	0.1	0.08	0.07
2	0.8	0.4	0.27	0.2	0.16	0.13
3	1.2	0.6	0.40	0.3	0.24	0.20
4	1.6	0.8	0.53	0.4	0.32	0.27
5	2.0	1.0	0.67	0.5	0.40	0.33
6	2.4	1.2	0.80	0.6	0.48	0.40
7	2.8	1.4	0.93	0.7	0.56	0.47
8	3.2	1.6	1.07	0.8	0.64	0.53

B. Areas in square feet

Emitter flow	Soil infiltration rate (inches per hour)					
	0.10	0.20	0.30	0.40	0.50	0.60
<i>U.S. gallons per hour</i>	..... <i>Square feet</i> .....					
0.25	4.0	2.0	1.3	1.0	0.8	0.7
0.50	8.0	4.0	2.7	2.0	1.6	1.3
0.75	12.0	6.0	4.0	3.0	2.4	2.0
1.00	16.0	8.0	5.3	4.0	3.2	2.7
1.25	20.0	10.0	6.6	5.0	4.0	3.3
1.50	24.0	12.0	8.0	6.0	4.8	4.0
1.75	28.0	14.0	9.3	7.0	5.6	4.7
2.00	32.0	16.0	10.7	8.0	6.4	5.4

mation is available about wetting patterns for different soils. To determine the shape and size of the wetting pattern, field tests should be made at each site with emitters of various flow rates.

### Plugging of emitters

The plugging of emitter orifices has been a serious problem with many drip irrigation systems. Screening or filtering the irrigation water is a basic requirement. Multiple screens are often used with the size of openings related to the size of the orifices. Screens with 200 mesh per square inch are sometimes required. Where suspended organic materials such as algae are carried in the water it may be necessary to use a sand or diatomaceous earth filter (Figure 83). Screens and filters require periodic cleaning.

Water containing quantities of calcium or magnesium bicarbonates may

FIGURE 83. Two sand filters removing organic matter and other particles from water used for drip irrigation. The use of two filters permits backflushing each filter separately without shutting off the flow of water to the irrigation system.

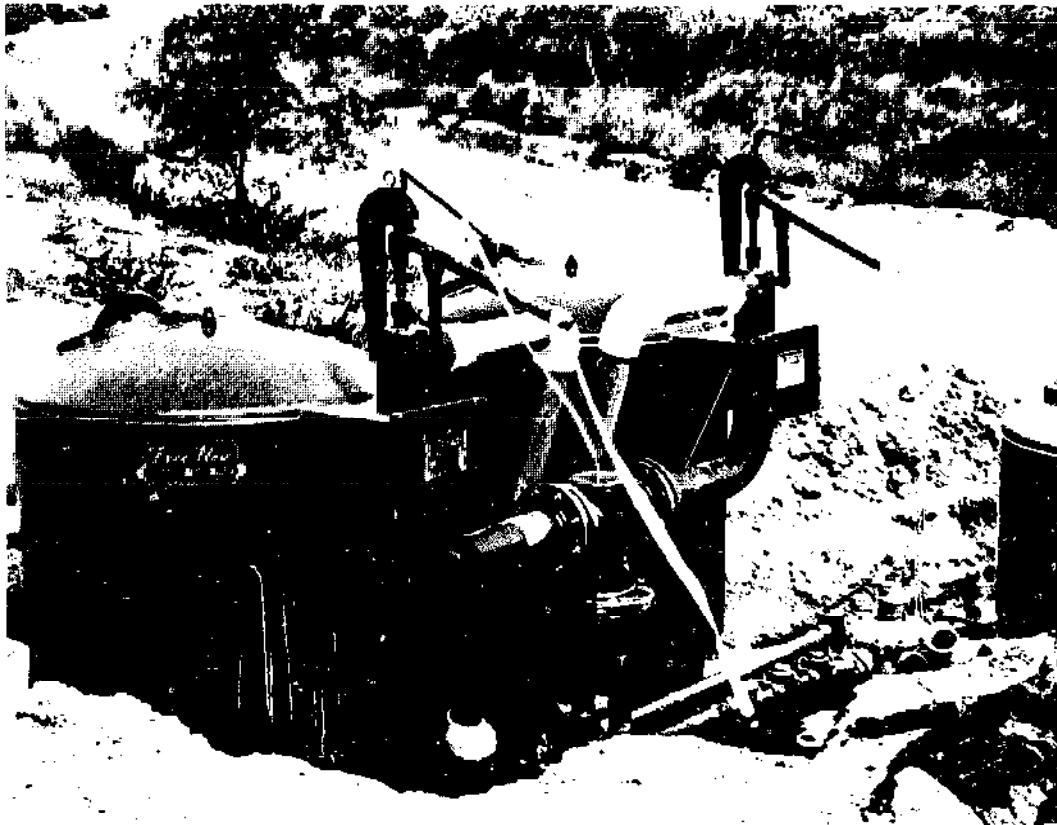

form carbonate encrustations on the outer side of the orifices, reducing the flow. Water carrying dissolved iron may precipitate iron oxides and plug the outlets. These waters may not be suitable for drip irrigation.

The injection of phosphate or ammonia fertilizers into the water can result in the formation of precipitates of calcium or magnesium compounds which can plug small orifices.

The growth of algae or filamentous bacteria inside the supply tubing can also plug the orifices. This problem occurs more frequently during hot weather or where the water supply is obtained from a pond or open ditch. Cycling the system so that the water can be completely drained from the supply lines every day will help to control this growth. Valves at the ends of the lines will permit the flushing of the system to remove accumulated growth. In severe cases it may be necessary to add an algacide, such as copper sulfate, to the water.

### **Supply lines**

The supply lines should follow the contours of the land as closely as possible. Where they must follow an uneven surface, allowances must be made for pressure differences due to changes in elevation. A fall of 1 metre in elevation is equivalent to an increase in pressure of 0.1 atmosphere (a fall of 1 foot is equivalent to an increase in pressure of 0.433 pound per square inch). Where the supply lines are laid down a slope, the increase in pressure due to elevation change will help compensate for friction losses.

Extruded polyethylene, polyvinyl chloride or polypropylene plastic tubing are generally used for the lateral supply lines which deliver water to the emitters. Opaque tubing, which is impervious to light rays and reduces algal growth, is preferred. To provide nearly uniform pressure at each emitter, the tubing should be sufficient in diameter to avoid excessive friction losses.

The water delivered into the supply line is released through a large number of emitters spaced along its length. The total friction loss is therefore only about one third of the loss that would occur if the entire flow were delivered the full length of the supply line. Table 24 gives friction losses for various flows in different sizes of plastic tubing.

*Example:* An orchard to be irrigated has trees spaced 6 metres apart with 20 trees in each row. The rows are on a slope with a fall of 0.5 metre per 100 metres. Six emitters with a capacity of 4.5 litres per hour each are to be used for each tree. Determine the size of supply pipe required so that pressure difference at the emitters does not exceed 2 metres of water. The



TABLE 24. - FRICTION LOSSES IN PLASTIC TUBING

A. Losses in metres per 100 metres

Flow	Inside diameter (millimetres)						
	9.2	11.7	12.7	13.9	15.8	18.0	19.0
<i>Litres per hour</i>	<i>Metres per 100 metres</i>						
200	10.0	5.2	2.5	1.7	0.8	0.4	0.3
400	39.0	18.0	8.6	5.7	2.7	1.6	1.1
600		39.0	18.0	13.0	5.9	3.2	2.5
800			30.0	21.0	10.0	5.5	4.1
1 000			45.0	30.0	16.0	8.3	6.2
1 200				42.0	21.0	11.0	8.8
1 400				56.0	28.0	16.0	11.0
1 600					36.0	20.0	15.0
1 800					45.0	25.0	19.0
2 000					54.0	30.0	23.0

B. Losses in pounds per square inch per 100 feet

Flow	Inside diameter (inches)						
	0.36	0.42	0.50	0.55	0.62	0.71	0.75
<i>U.S. gallons per hour</i>	<i>Pounds per square inch per 100 feet</i>						
60	5.8	2.8	1.2	0.8	0.4	0.2	0.2
120	21.1	10.3	4.5	2.9	1.5	0.8	0.6
180		21.5	9.5	6.2	2.8	1.7	1.3
240		36.6	16.2	10.6	5.6	3.0	2.3
300			24.5	16.0	8.4	4.5	3.4
360			34.4	22.8	11.8	6.2	4.8
420				29.8	15.8	8.3	6.4
480				38.2	20.1	10.6	8.1
540					25.2	13.2	10.1
600					30.6	16.1	12.3

supply line is 120 metres long, with 120 emitters spaced 1 metre apart. Total flow is 540 litres per hour. The pressure gain due to slope is  $0.5 \times 1.2 = 0.6$  metre. Total dynamic head allowable for overcoming friction is  $2 + 0.6 = 2.6$  metres for 120 metres, or 2.17 metres per 100 metres. Table 24 shows that for a flow of 600 litres per hour through a 15.8-millimetre pipe the friction loss is 5.9 metres per 100 metres. Since the friction loss with multiple outlets will only be one third of this (1.97 metres per 100 metres), a supply line with an inside diameter of about 15 millimetres should be used.

The allowable pressure drop in a supply line will depend on the operating pressure required at the emitters. The pressure difference between any two points along the supply line should not exceed 10 percent of the required pressure at the emitters.

In systems using self-flushing emitters, a greater flow and higher pressure when water starts flowing in the supply lines are required in order to close the flushing devices. This can sometimes be satisfied by concentrating the flow into a limited number of laterals at the start of irrigation. After a few minutes the flushing devices will usually close and the emitters will discharge water at their normal flow rate.

Water is delivered to the lateral supply lines through a mainline pipe. This pipe should be of a size that will deliver the required flows while keeping friction losses within allowable limits. Where there are considerable differences in elevation between supply lines, pressure regulators and/or flow regulators are required on the intakes to the lines to equalize pressures.

### **Care in using plastic materials**

The plastics used in drip irrigation systems are subject to deterioration when exposed to the sun. Inhibitors of ultraviolet light are sometimes mixed with the plastics to extend the life of the tubing. The pipes should be buried whenever possible. The emitters should not be buried, as they must be checked to see whether they are working properly. Rodents can chew through plastic pipe and tubing, whether the pipe is buried or exposed on the soil surface. Damage from rodents occurs more commonly with polyethylene than with polyvinyl chloride plastics.

Some chemicals used for weed control or in pesticides act as solvents on plastics. Care should be taken not to spray them on to the plastic parts of the drip system. Damage can also result from injecting certain chemical pesticides into the pipelines.

## CONVERSION FACTORS

## CONVERSION FACTORS

### Metric and British/United States units of measure

	<i>Metric</i>	<i>British/United States</i>
<b>Length</b>		
1 millimetre		= 0.039 inch
1 centimetre		= 0.3937 inch
1 metre	= 100 centimetres	= 39.37 inches = 3.2808 feet
1 kilometre	= 1 000 metres	= 0.6214 mile
1 inch	= 2.54 centimetres	
1 foot	= 0.3048 metre	
1 mile	= 1.609 kilometres	
<b>Area</b>		
1 square centimetre		= 0.155 square inch
1 square metre		= 10.764 square feet
1 square kilometre	= 100 hectares	= 0.3861 square mile
1 hectare	= 10 000 square metres	= 107 640 square feet = 2.471 acres
1 square inch	= 6.452 square centimetres	
1 square foot	= 0.0929 square metre	
1 acre	= 0.4047 hectare	= 43 560 square feet
1 square mile	= 258.99 hectares = 2.59 square kilometres	= 640 acres
<b>Volume</b>		
1 cubic centimetre		= 0.061 cubic inch
1 cubic metre	= 1 000 litres	= 35.314 cubic feet = 1.308 cubic yards
1 litre		= 0.0353 cubic foot = 0.2642 U.S. gallon = 0.2201 imperial gallon

	<i>Metric</i>	<i>British/United States</i>
1 cubic inch	= 16.39 cubic centimetres	
1 cubic foot	= 0.0283 cubic metre = 28.32 litres	= 7.48 U.S. gallons = 6.23 imperial gallons
1 cubic yard	= 0.7645 cubic metre	
1 U.S. gallon	= 3.783 litres	= 0.833 imperial gallon
1 imperial gallon	= 4.5460 litres	= 1.201 U.S. gallons
1 acre-inch	= 102.8 cubic metres	= 3 630 cubic feet
1 acre-foot	= 1 233.5 cubic metres	= 43 560 cubic feet
<b>Rates of flow</b>		
1 cubic metre per second		= 35.314 cubic feet per second
1 cubic metre per hour	= 0.278 litre per second	= 4.403 U.S. gallons per minute = 3.668 imperial gallons per minute
1 litre per second	= 3.6 cubic metres per hour	= 0.0353 cubic feet per second = 15.852 U.S. gallons per minute = 13.206 imperial gallons per minute
1 cubic foot per second	= 0.0283 cubic metre per second = 28.32 litres per second	= 448.8 U.S. gallons per minute = 373.8 imperial gallons per minute = 1 acre-inch per hour (approximately) = 2 acre-feet per day (approximately)
1 U.S. gallon per minute	= 0.06309 litre per second	
1 imperial gallon per minute	= 0.07573 litre per second	
<b>Pressure</b>		
1 atmosphere		= 14.7 pounds per square inch
1 pound per square inch	= 0.068 atmosphere	

## REFERENCES

- AMERICAN CONCRETE INSTITUTE. *Specifications for cast-in-place nonreinforced concrete pipe (ACI Standard 346-70) and supplemental report recommendations (Title No. 66-22)*. Detroit, Michigan.  
1969
- BAMESBERGER, JOHN G. *Land levelling for irrigation*. Washington, D.C., U.S. Department of Agriculture. Leaflet No. 371.  
1961
- BISHOP, A. ALVIN. Relation of intake to length of run in surface irrigation. *Proceedings of the American Society of Civil Engineers, Journal of the Irrigation and Drainage Division*, 87: 23-29.  
1961
- BLACK, J.D.F. *Daily flow. Irrigation for fruit trees and row crops*. Victoria Department of Agriculture. Leaflet H 191.  
1969
- BOAZ, MOSHE. *Trickle irrigation in Israel*. Israel Ministry of Agriculture.  
1971
- BONDURANT, J. A. Developing a furrow infiltrometer. *Agricultural Engineering*, 1957 38: 602-604.
- BROWN, LLOYD N. *Planting and irrigation on the contour*. University of California, 1963 Agricultural Extension Service. Circular 523.
- BROWN, LLOYD N. & BOOHER, L.J. *Irrigation on steep land*. University of California, 1972 Agricultural Extension Service. Circular 509.
- BURGY, R.H. & LUTHIN, J.N. A test of the single and double ring types of infiltrometers. *Transactions, American Geophysical Union*, 37: 189-191.  
1956
- CHRISTIANSEN, J. E., BISHOP, A. ALVIN & YU SI FOK. *The intake rate as related to the advance of water in surface irrigation*. Paper presented at the 1959 Winter Meeting of the American Society of Agricultural Engineers, Chicago, Illinois.  
1959
- CRIDDLE, WAYNE D., DAVIS, STERLING, PAIR, CLAUDE H. & SHOCKLEY, DELL G. 1956. *Methods of evaluating irrigation systems*. U.S. Department of Agriculture, Soil Conservation Service. Agricultural Handbook No. 82.
- DAVIS, J.R. Estimating rate of advance for irrigation furrows. *Transactions of the American Society of Agricultural Engineers*, 4(1): 52-54, 57.  
1961
- DAVIS, J.R. & FRY, A.W. Measurement of infiltration rates in irrigation furrows. *Transactions of the American Society of Agricultural Engineers*, 6(4): 318-319.  
1963
- DUTT, GORDON R. & BOOHER, L.J. *Corrosion of irrigation structures*. University of California, Agricultural Extension Service. Pub. AXT-109.  
1971
- FAO. *Irrigation by sprinkling*. Rome. FAO Agricultural Development Paper No. 65.  
1960

- FAO. *Agricultural engineering: water control, tillage and seeding practices and machines for crop production under irrigation*. Rome. FAO, Farm Power and Machinery, Informal Working Bulletin 7. 1963
- FAO. *Applied irrigation research*. Rome. 1967
- FAO. *Sprinkler irrigation*. Rome. FAO Agricultural Development Paper No. 88. 1968
- FAO. *Automated irrigation*. Rome. FAO, Irrigation and Drainage Paper No. 5. 1971a
- FAO. *Design criteria for basin irrigation systems*. Rome. FAO, Irrigation and Drainage Paper No. 3. 1971b
- FAO. *Drainage of heavy soils*. Rome. FAO, Irrigation and Drainage Paper No. 6. 1971c
- FAO. *Integrated farm water management*. Rome. FAO, Irrigation and Drainage Paper No. 10. 1971d
- FAO. *Irrigation canal lining*. Rome. FAO, Irrigation and Drainage Paper No. 2. 1971e
- FAO. *Irrigation practice and water management*. Rome. FAO, Irrigation and Drainage Paper No. 1. 1971f
- FAO. *Salinity seminar, Baghdad*. Rome. FAO, Irrigation and Drainage Paper No. 7. 1971g
- FAO. *Village irrigation programmes: a new approach in water economy*. Rome. FAO, Irrigation and Drainage Paper No. 4. 1971h
- FAO. *Water and the environment*. Rome. FAO, Irrigation and Drainage Paper No. 8. 1971i
- FAO. *Drainage materials*. Rome. FAO, Irrigation and Drainage Paper No. 9. 1972a
- FAO. *Farm water management seminar, Manila*. Rome. FAO, Irrigation and Drainage Paper No. 12. 1972b
- FAO. *Planning methodology seminar, Bucharest*. Rome. FAO, Irrigation and Drainage Paper No. 11. 1972c
- FAO. *Water use seminar, Damascus*. Rome. FAO, Irrigation and Drainage Paper No. 13. 1972d
- FAO. *Drainage of machinery*. Rome. FAO, Irrigation and Drainage Paper No. 15. 1973a
- FAO. *Drainage of salty soils*. Rome. FAO, Irrigation and Drainage Paper No. 16. 1973b
- FAO. *Groundwater seminar, Granada*. Rome. FAO, Irrigation and Drainage Paper No. 18. 1973c
- FAO. *Man's influence on the hydrological cycle*. Rome. FAO, Irrigation and Drainage Paper No. 17. 1973d
- FAO. *Mathematical models in hydrology*. Rome. FAO, Irrigation and Drainage Paper No. 19. 1973e
- FAO. *Trickle irrigation*. Rome. FAO, Irrigation and Drainage Paper No. 14. 1973f

- FAO. *Water laws in Moslem countries*. Rome. FAO, Irrigation and Drainage Paper 1973g No. 20.
- FAO/UNESCO. *Irrigation, drainage and salinity: an international source book*. London, 1973 Hutchinson & Co. (Publishers) Ltd.
- FINFROCK, DWIGHT C., RANEY, FRANKLIN C., MILLER, MILTON D. & BOOHER, 1960 LAWRENCE J. *Water management in rice production*. University of California, Agricultural Extension Service. Leaflet 131.
- GARDNER, W.R. Dynamic aspects of water availability to plants. *Soil Science*, 89(2): 1960 63-73.
- GOLDBERG, D. & SHMUELI, M. Drip irrigation: a method used under arid and desert 1970 conditions of high water and soil salinity. *Transactions of the American Society of Agricultural Engineers*, 13.
- HAISE, H.R., DONNAN, W.W., PHELAN, J.T., LAWHON, L.F. & SHOCKLEY, D.F. *The 1956 use of cylinder infiltrometers to determine the intake characteristics of irrigated soils*. U.S. Department of Agriculture. Pub. ARS 41-7.
- HALL, WARREN A. Estimating irrigation border flow. *Agricultural Engineering*, 37: 1956 263-265.
- HOUSTON, C.E. & SCHADE, R.O. *Irrigation return-water systems*. University of California, Agricultural Extension Service. Circular 542.
- KING, H.W. *Handbook of hydraulics for the solution of hydraulic problems*. New York, 1963 McGraw Hill.
- KOHLER, K.O. JR. *Contour-furrow irrigation*. U.S. Department of Agriculture, Soil 1953 Conservation Service. Leaflet 324.
- LAURITZEN, C.W. *Lining irrigation laterals and farm ditches*. U.S. Department of 1961 Agriculture in cooperation with Utah Agricultural Experiment Station. Agriculture Information Bulletin No. ARS 242.
- LEWIS, M.R. The rate of infiltration in irrigation practice. *Transactions, American 1937 Geophysical Union*, 18: 361-368.
- LEWIS, M.R. & MILNE, W.E. Analysis of border irrigation. *Agricultural Engineering*, 19. 1938
- MARR, JAMES C. *The border method of irrigation*. University of California, Agricultural 1958 Extension Service. Circular 408.
- MARR, JAMES C. *Grading land for surface irrigation*. University of California, Agricultural 1965 Extension Service. Circular 438.
- MARR, JAMES C. *Furrow irrigation*. University of California, Agricultural Extension 1967 Service. Manual No. 37.
- MICHAEL, A.M. & KNIERIM, G.C. *Cultivation practices in irrigation farming*. Jobner, 1965 India, University of Udaipur, College of Agriculture. Extension Bulletin No. 3.
- MICHAEL, A.M., KNIERIM, G.C. & REESER, R.M. *Simple bullock-drawn implements*. 1964 Jobner, India, University of Udaipur, College of Agriculture. Extension Bulletin No. 1.
- MICHAEL, A.M., REESER, R.M. & KNIERIM, G.C. *How to improve irrigation farming 1965 in India*. Jobner, India, University of Udaipur, College of Agriculture. Extension Bulletin No. 2.



- MICHAEL, A.M., ARORA, D.R., BHATTACHARYA, A.K., MANDAL, A. & GUPTA, A.K.  
1970 *Handbook of farm irrigation structures*. New Delhi, Indian Agricultural Research Institute, Division of Agricultural Engineering.
- PORTLAND CEMENT ASSOCIATION. *Concrete pipe irrigation systems*. Chicago, Illinois. 1960
- RICHARDS, L.A. & WADLEIGH, C.H. Soil water and plant growth. In *Soil physical conditions and plant growth*, p. 73-251. New York, Academic Press. American Society of Agronomy Monographs No. 2.
- ROBINSON, A.R., LAURITZEN, C.W., MUCKEL, D.C. & PHELAN, J.T. *Distribution, control, measurement of irrigation water on the farm*. U.S. Department of Agriculture. Miscellaneous Publication No. 926.
- SHOCKLEY, D.G., PHELAN, J.T., LAWHON, L.F., HAISE, H.R., DONNAN, W.W. & MEYERS, L.E. *A method for determining intake characteristics of irrigation furrows*. U.S. Department of Agriculture. Publication ARS 41-53.
- SMERDON, E.T. & HOHN, C.M. *Relationships between the rate of advance and intake rate in furrow irrigation*. College Station, Texas Agricultural and Mechanical University. Publication MP-509.
- SMITH, JOHN B. *Design of irrigation system*. Iraq College of Agriculture. Circular 3. 1957a
- SMITH, JOHN B. *Irrigation methods and problems*. Iraq College of Agriculture. 1957b Circular 1.
- SMITH, JOHN B. *Selection of irrigation methods*. Iraq College of Agriculture. Circular 2. 1957c
- SPINDLER, W.H., ed. *Handbook of drainage and irrigation practice*. Middletown, Ohio, Armco International Corporation.
- STANLEY, WILLIAM R. *Corrugation irrigation*. U.S. Department of Agriculture, Soil Conservation Service. Leaflet 343.
- UNITED STATES. DEPARTMENT OF AGRICULTURE. *Equipment for clearing brush from land*. Farmers' Bulletin No. 2180.
- VEIHMEYER, F.J. Soil moisture. *Encyclopedia of plant physiology*, Vol. 3, p. 64-123. 1956 Berlin, Springer Verlag.
- VEIHMEYER, F.J. & HENDRICKSON, A.H. Soil moisture in relation to plant growth. 1950 *Annual Review of Plant Pathology*, 1: 285-304.
- WILKE, O. & SMERDON, E.T. A solution of the irrigation advance problem. *Proceedings of the American Society of Civil Engineers, Journal of the Irrigation and Drainage Division*, 91 (IR 3): 23-34.

**FAO SALES AGENTS AND BOOKSELLERS**  
**AGENTS ET DÉPOSITAIRES DE LA FAO**  
**LIBRERIAS Y AGENTES DE VENTAS DE LA FAO**

<b>Argentina</b>	Editorial Hemisferio Sur S.R.L., Librería Agropecuaria, Pasteur 743, Buenos Aires.
<b>Australia</b>	Hunter Publications, 58A Gipps Street, Collingwood, Vic. 3066; The Assistant Director, Sales and Distribution, Australian Government Publishing Service, P.O. Box 84, Canberra, A.C.T. 2600, and Australian Government Publications and Inquiry Centres in Canberra, Melbourne, Sydney, Perth, Adelaide and Hobart.
<b>Austria</b>	Gerold & Co., Buchhandlung und Verlag, Graben 31, 1011 Vienna.
<b>Bangladesh</b>	Association of Voluntary Agencies in Bangladesh, 549F Road 14, Dhammandi, P.O. Box 5045, Dacca 5.
<b>Belgique</b>	Service des publications de la FAO, M. J. De Lannoy, rue du Trône 112, 1050 Bruxelles. CCP 000-0808993-13.
<b>Bolivia</b>	Los Amigos del Libro, Perú 3712, Casilla 450, Cochabamba; Mercado 1315, La Paz; René Moreno 26, Santa Cruz; Junín esq. 6 de Octubre, Oruro.
<b>Brazil</b>	Livraria Mestre Jou, Rua Guaipá 518, São Paulo 10; Rua Senador Dantas 19-S205/206, Rio de Janeiro.
<b>Brunei</b>	MPH Distributors Sdn. Bhd., 71/77 Stamford Road, Singapore 6, Singapore.
<b>Canada</b>	Information Canada, Ottawa.
<b>Chile</b>	Biblioteca, FAO Oficina Regional para América Latina, Av. Providencia 871, Casilla 10095, Santiago.
<b>China</b>	China National Publications Import Corporation, P.O. Box 88, Peking.
<b>Colombia</b>	Litexsa Colombiana Ltda., Carrera 15, N° 51-79, Apartado Aéreo 51340, Bogotá.
<b>Costa Rica</b>	Librería, Imprenta y Litografía Lehmann S.A., Apartado 10011, San José.
<b>Cuba</b>	Instituto del Libro, Calle 19 y 10, N° 1002, Vedado.
<b>Cyprus</b>	MAM, P.O. Box 1722, Nicosia.
<b>Denmark</b>	Ejnar Munksgaard, Norregade 6, Copenhagen S.
<b>Ecuador</b>	Su Librería Cia. Ltda., García Moreno 1172, Apartado 2556, Quito.
<b>Egypt</b>	Al Ahram, El Galaa St., Cairo.
<b>El Salvador</b>	Librería Cultural Salvadoreña S.A., Avenida Morazán 113, Apartado Postal 2296, San Salvador.
<b>España</b>	Librería Mundi Prensa, Castelló 37, Madrid; Librería Agrícola, Fernando VI, 2, Madrid - 4
<b>Finland</b>	Akateeminen Kirjakauppa, 1 Keskuskatu, Helsinki.
<b>France</b>	Editions A. Pedone, 13 rue Soufflot, 75005 Paris.
<b>Germany, F. R.</b>	Alexander Horn Internationale Buchhandlung, Spiegelgasse 9, Postfach 3340, Wiesbaden
<b>Ghana</b>	Ghana Publishing Corporation, P.O. Box 3632, Accra.
<b>Grèce</b>	"Eleftheroudakis", 4 Nikis Street, Athènes.
<b>Guatemala</b>	Distribuciones Culturales y Técnicas "Artemis", Quinta Avenida 12-11, Zona 1 Guatemala.
<b>Haiti</b>	Max Bouchereau, Librairie "A la Caravelle", B.P. 111B, Port-au-Prince.
<b>Honduras</b>	Editorial Nuevo Continente S. de R.L., Avenida Cervantes 1230-A, Apartado Postal 380, Tegucigalpa.
<b>Hong Kong</b>	Swindon Book Co., 13-15 Lock Road, Kowloon.
<b>Iceland</b>	Snaebjörn Jónsson and Co. h.f., Hafnarstraeti 9, P.O. Box 1131, Reykjavik.
<b>India</b>	Oxford Book and Stationery Co., Scindia House, New Delhi; 17 Park Street, Calcutta.
<b>Indonesia</b>	P.T. Gunung Agung, 6 Kwitang, Djakarta.
<b>Iran</b>	Iran Book Co. Ltd., 127 Nadershah Avenue, P.O. Box 14-1532, Tehran; Economist Tehran, 99 Sevom Esfand Avenue, Tehran (sub-agent).
<b>Iraq</b>	National House for Publishing, Distributing and Advertising, Rashid Street, Baghdad.
<b>Ireland</b>	The Controller, Stationery Office, Dublin.
<b>Israel</b>	Emanuel Brown, P.O. Box 4101, 35 Allenby Road and Nachlat Benyamin Street, Tel Aviv; 9 Shlomzion Hamalka Street, Jerusalem.
<b>Italie</b>	Distribution and Sales Section, Food and Agriculture Organization of the United Nations, Via delle Terme di Caracalla, 00100 Rome; Libreria Scientifica Dott. L. De Biasio "Aeiou", Via Meravigli 16, 20123 Milan; Libreria Commissionaria Sansoni "Licosa", Via Lamarmora 45, C.P. 552, 50121 Florence.
<b>Jamaica</b>	Teachers Book Centre Ltd., 96 Church Street, Kingston.
<b>Japan</b>	Maruzen Company Ltd., P.O. Box 5050, Tokyo Central 100-31.
<b>Kenya</b>	The E.S.A. Bookshop, P.O. Box 30167, Nairobi.

**FAO SALES AGENTS AND BOOKSELLERS**  
**AGENTS ET DÉPOSITAIRES DE LA FAO**  
**LIBRERIAS Y AGENTES DE VENTAS DE LA FAO**

<b>Korea, Rep. of</b>	The Eul-Yoo Publishing Co. Ltd., 5 2-Ka, Chong-ro, Seoul.
<b>Liban</b>	Dar Al-Maaref Liban S.A.L., place Riad El-Solh, B.P. 2320, Beyrouth.
<b>Luxembourg</b>	Service des publications de la FAO, M. J. De Lannoy, rue du Trône 112, 1050 Bruxelles (Belgique).
<b>Malaysia</b>	MPH Distributors Sdn. Bhd., 71/77 Stamford Road, Singapore 6, Singapore.
<b>Maroc</b>	Librairie "Aux Belles Images", 281 avenue Mohammed V, Rabat.
<b>Mauritius</b>	Nalanda Company Limited, 30 Bourbon Street, Port-Louis.
<b>México</b>	Dilitsa, Puebla 182-D, Apartado 24-448, México 7, D.F.
<b>Netherlands</b>	N.V. Martinus Nijhoff, Lange Voorhout 9, The Hague.
<b>New Zealand</b>	Government Printing Office: Government Bookshops at Rutland Street, P.O. Box 5344, Auckland; Mulgrave Street, Private Bag, Wellington; 130 Oxford Terrace, P.O. Box 1721, Christchurch; Princes Street, P.O. Box 1104, Dunedin; Alma Street, P.O. Box 857, Hamilton.
<b>Nicaragua</b>	Culturama, Camino de Oriente, Apartado 4741, Managua.
<b>Nigeria</b>	University Bookshop Nigeria Ltd., University of Ibadan.
<b>Norway</b>	Johan Grundt Tanum Bokhandel, Karl Johansgt. GT 41-43, Oslo 1.
<b>Pakistan</b>	Mirza Book Agency, 65 The Mall, Lahore 3.
<b>Panamá</b>	Distribuidora Lewis S.A., Edificio Dorasol, Calle 25 y Avenida Balboa, Apartado 1634, Panamá 1.
<b>Perú</b>	Librería Juan Mejía Baca, Azangaro 722, Lima.
<b>Philippines</b>	The Modern Book Company, 928 Rizal Avenue, Manila.
<b>Poland</b>	Ars Polona-Ruch, Krakowskie Przedmiescie 7, Warsaw.
<b>Portugal</b>	Livraria Bertrand, S.A.R.L., Apartado 37, Amadora; Livraria Portugal, Dias y Andrade Ltda., Apartado 2681, Rua do Carmo 70-74, Lisbon - 2.
<b>Rep. Dominicana</b>	Fundación Dominicana de Desarrollo, Casa de las Gárgolas, Mercedes 4, Santo Domingo.
<b>Roumanie</b>	Ilexim, Calea Grivitei No. 64-66, P.O. Box 2001, Bucharest.
<b>Saudi Arabia</b>	Khazindar Establishment, King Faysal Street, Riyadh.
<b>Singapore</b>	MPH Distributors Sdn. Bhd., 71/77 Stamford Road, Singapore 6.
<b>Somalia</b>	"Samater's", P.O. Box 936, Mogadishu.
<b>Sri Lanka</b>	M.D. Gunasena and Co. Ltd., 217 Norris Road, Colombo 11.
<b>Suisse</b>	Librairie Payot S.A., Lausanne et Genève; Hans Raunhardt, Kirchgasse 17, Zurich 1.
<b>Sweden</b>	C.E. Fritzes Kungl. Hovbokhandel, Fredsgatan 2, 103 27 Stockholm 16.
<b>Tanzania</b>	Dar es Salaam Bookshop, P.O. Box 9030, Dar es Salaam.
<b>Thailand</b>	Suksapan Panit, Mansion 9, Hajadamnern Avenue, Bangkok.
<b>Togo</b>	Librairie du Bon Pasteur, B.P. 1164, Lomé.
<b>Turkey</b>	Güven Kitabevi Müdafaa Cad., Güven Building 12/5, Ankara.
<b>United Kingdom</b>	Her Majesty's Stationery Office, 49 High Holborn, London, W.C.1; P.O. Box 569, London, S.E.1 (trade and London area mail orders); 13a Castle Street, Edinburgh EH2 3AR; 109 St. Mary Street, Cardiff CF1 1JW; 7 Linenhall Street, Belfast BT2 8AY; Brazenose Street, Manchester M60 8AS; 258 Broad Street, Birmingham 1; Southey House, Wine Street, Bristol BS1 2BO.
<b>United States of America</b>	UNIPUB, 650 First Avenue, P.O. Box 433, Murray Hill Station, New York, N.Y. 10016.
<b>Uruguay</b>	Juan Angel Peri, Alzaibar 1328, Casilla de Correos 1755, Montevideo.
<b>Venezuela</b>	Blume Distribuidora S.A., Calle 3, N° 508, Quinta Palmera Sola, Campo Alegre, Chacao, Caracas.
<b>Yugoslavia</b>	Jugoslovenska Knjiga, Terazije 27/11, Belgrade; Cankarjeva Založba, P.O. Box 201-IV, Ljubljana.
<b>Other countries</b>	Requests from countries where sales agents have not yet been appointed may be sent to: Distribution and Sales Section, Food and Agriculture Organization of the United Nations, Via delle Terme di Caracalla, 00100 Rome, Italy.
<b>Autres pays</b>	Les commandes ou les demandes de renseignements émanant de pays pour lesquels des agents ou des dépositaires n'ont pas encore été désignés peuvent être adressées à: Section distribution et ventes, Organisation des Nations Unies pour l'alimentation et l'agriculture, Via delle Terme di Caracalla, 00100 Rome, Italie.
<b>Otros países</b>	Los pedidos procedentes de países en donde aún no han sido designados agentes distribuidores, pueden hacerse directamente a la Sección de Distribución y Venta, FAO, Via delle Terme di Caracalla, 00100 Roma, Italia.

