

HPWA-MH00	HPWT-MH00	HPWN-MB00
HPWA-DH00	HPWT-DH00	HPWN-MC00
HPWT-RD00	HPWT-BH00	HPWN-MG00
HPWT-MD00	HPWT-RL00	
HPWT-DD00	HPWT-ML00	
HPWT-BD00	HPWT-DL00	
HPWT-RH00	HPWT-BL00	

Super Flux LEDs

Technical Data

This revolutionary package design allows the lighting designer to reduce the number of LEDs required and provide a more uniform and unique illuminated appearance than with other LED solutions. This is possible through the efficient optical package design and high-current capabilities.

The low profile package can be easily coupled with reflectors or lenses to efficiently distribute light and provide the desired lit appearance. This product family employs the world's brightest red, red-orange, amber, blue, cyan and green LED materials, which allow designers to match the color of many lighting applications like vehicle signal lamps, specialty lighting, and electronic signs.

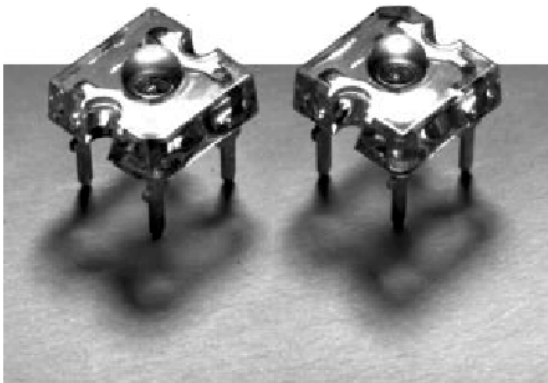

LUMILEDS™
LIGHT FROM SILICON VALLEY

Benefits

- Rugged Lighting Products
- Electricity Savings
- Maintenance Savings

Features

- High Luminance
- Low Power Consumption
- Low Thermal Resistance
- Low Profile
- Meets SAE/ECE/JIS Automotive Color Requirements
- Packaged in tubes for use with automatic insertion equipment

Typical Applications

- Automotive Exterior Lighting
- Electronic Signs and Signals
- Specialty Lighting

Outline Drawings

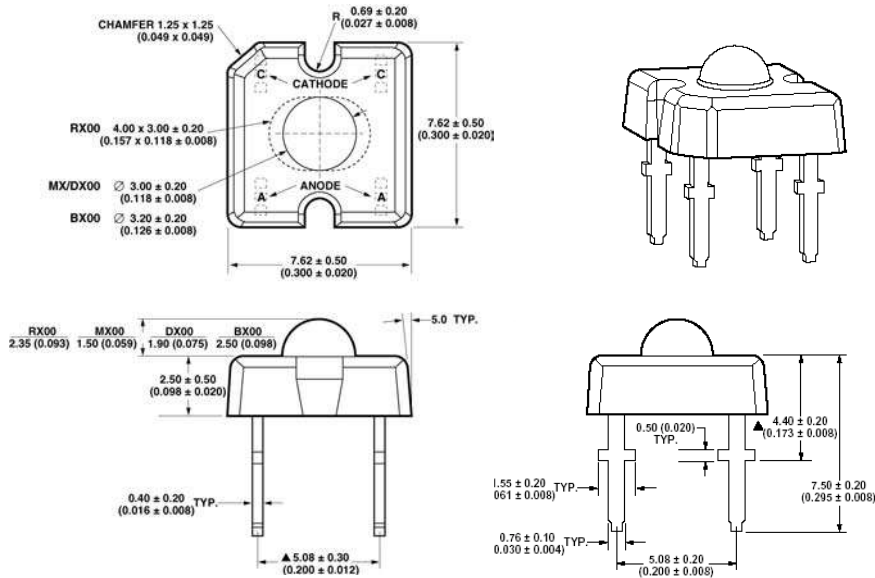

Selection Guide

Part Number	LED Color	Total flux Φ_v (mIm)	
		70 mA ^[1] (HPWA, HPWT) 50mA (HPWN) Typ.	Total Included angle $\theta_{90\%}$ (Degrees) ^[2] Typ.
HPWA-MH00-00000	AS AlInGaP Red-Orange	1500	95
HPWA-DH00-00000			75
HPWT-RD00-00000	TS AlInGaP Red	3000	44 X 88
HPWT-MD00-00000			100
HPWT-DD00-00000			70
HPWT-BD00-00000			50
HPWT-RH00-00000	TS AlInGaP Red-Orange	3750	44 X 88
HPWT-MH00-00000			100
HPWT-DH00-00000			70
HPWT-BH00-00000			50
HPWT-RL00-00000	TS AlInGaP Amber	1500	44 X 88
HPWT-ML00-00000			100
HPWT-DL00-00000			70
HPWT-BL00-00000			50
HPWN-MB00-00000	InGaN Blue	2000	110
HPWN-MC00-00000	InGaN Cyan	5000	110
HPWN-MG00-00000	InGaN Green	4500	110

Notes:

- Φ_v is the total luminous flux output as measured with an integrating sphere after the device has stabilized. ($R_{\theta, J-A} = 200^\circ$ C/W, $T_A = 25^\circ\text{C}$)
- $\theta_{90\%}$ is the included angle at which 90% of the total luminous flux is captured.

Absolute Maximum Ratings at $T_A = 25\text{ }^\circ\text{C}$

Parameter	HPWA	HPWT	HPWN	UNITS
DC Forward Current ^[1]	70	70	50	mA
Power Dissipation	187	221	228	mW
Reverse Voltage ($I_R = 100\text{ }\mu\text{A}$)	10	10	0.55	V
Operating Temperature Range	-40 to +100			$^\circ\text{C}$
Storage Temperature Range	-55 to +100			$^\circ\text{C}$
High Temperature Chamber	125 $^\circ\text{C}$, 2 Hours			
LED Junction Temperature	125 $^\circ\text{C}$			
Solder Conditions ^[2]				
Preheat Temperature	100 $^\circ\text{C}$ for 30 seconds			
Solder Temperature	260 $^\circ\text{C}$ for 5 seconds			
	[1.5mm (0.06 in) below seating plane]			

Optical Characteristics at $T_A = 25\text{ }^\circ\text{C}$, $I_F = 70\text{ mA}$ HPWA, HPWT), $I_F = 50\text{ mA}$ (HPWN) $R_{\theta\text{-JA}} = 200\text{ }^\circ\text{C/W}$

Part Number	Total flux Φ (mIm) ^[1]		Peak wavelength λ_{peak} (nm) Typ.	Color, Dominant Wavelength λ_{dom} (nm) ^[2] Typ.	Total Included Angle $\theta_{0.90\text{V}}$ (degrees) ^[3] Typ.	Luminous Intensity/ Total Flux $I_v(\text{mcd})/\Phi$, (mIm) Typ.	Viewing Angle $\theta^{1/2}$ (Degrees) Typ.
	Min.	Typ.					
HPWA-MH00	600	1500	624	618	95	0.6	90
HPWA-DH00					75	0.9	60
HPWT-RD00					44 X 88	1.25	25 x 68
HPWT-MD00	1000	3000	640	630	100	0.6	70
HPWT-DD00					70	1.5	40
HPWT-BD00					50	2.0	30
HPWT-RH00					44 X 88	1.25	25 x 68
HPWT-MH00	1000	3750	626	620	100	0.6	70
HPWT-DH00					70	1.5	40
HPWT-BH00					50	2.0	30
HPWT-RL00					44 X 88	1.25	25 x 68
HPWT-ML00	1000	1500	596	594	100	0.6	70
HPWT-DL00					70	1.5	40
HPWT-BL00					50	2.0	30
HPWN-MB00	1110	2000	460	470	110	0.9	90
HPWN-MC00	3300	5000	503	505	110	0.9	90
HPWN-MG00	3300	4500	520	525	110	0.9	90

Electrical Characteristics at $T_A = 25\text{ }^\circ\text{C}$

Part Number	Forward Voltage V_F (Volts) @ $I_F = 70\text{ mA}$ (HPWA, HPWT) $I_F = 50\text{ mA}$ (HPWN)			Reverse Breakdown V_R (Volts) ^[1] @ $I_R = 100\text{ }\mu\text{A}$		Capacitance C (pF) $V_F = 0$, $F = 1\text{ MHz}$.	Thermal resistance $R\theta_{\text{J-PIN}}$ ($^\circ\text{C/W}$)	Speed of Response τ_s (ns) ^[2]
	Min	Typ	Max	Min	Typ			
HPWA-xH00	1.83	2.1	2.67	10	20	40	155	20
HPWT-xD00	2.15	2.5	3.03	10	20	40	125	20
HPWT-xH00	2.15	2.5	3.15	10	20	40	125	20
HPWT-xL00	2.15	2.6	3.15	10	20	40	125	20
HPWN-xB00	3.15	3.8	4.55	0.55	0.65	1900	130	20
HPWN-xC00	3.15	3.8	4.55	0.55	0.65	1900	130	20
HPWN-xG00	3.15	3.9	4.55	0.55	0.65	1900	130	20

Notes:

- De-rate as shown in Figures 4a, 4b and 4c.
- Detailed wave soldering instructions are available.

Notes:

- Φ_v is the total luminous flux output as measured with an integrating sphere after the device has stabilized.
- The dominant wavelength is derived from the CIE Chromaticity Diagram and represents the perceived color of the device.
- $\theta_{0.90\text{V}}$ is the included angle at which 90% of the total luminous flux is captured.

Notes:

- Operation in reverse bias is not recommended.
- τ_s is the time constant, e^{-t/τ_s} .

Figures

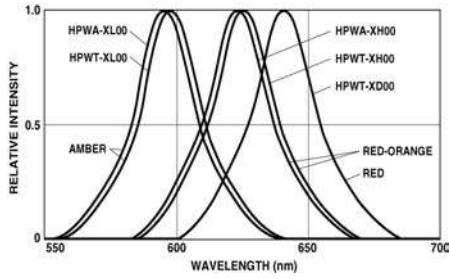

Figure 1. Relative Intensity vs. Wavelength

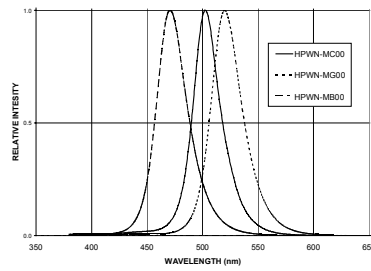

Figure 1a. Relative Intensity vs. Wavelength (HPWN)

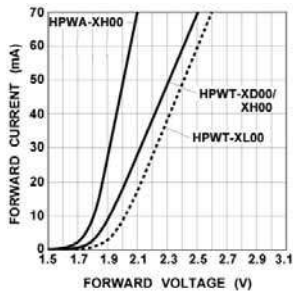

Figure 2. Forward Current vs. Forward Voltage

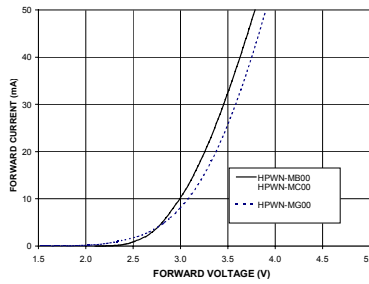

Figure 2a. Forward Current vs. Forward Voltage

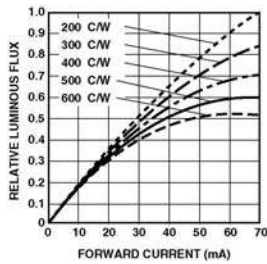

Figure 3. HPWA/HPST-XX00 Relative Luminous Flux vs. Forward Current.

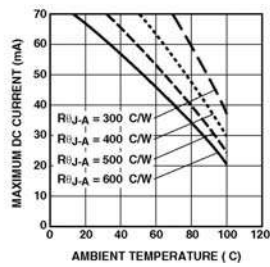

Figure 4a. HPWA-XX00 Maximum DC Forward Current vs. Ambient Temperature.

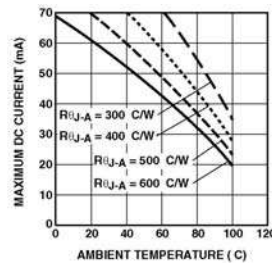

Figure 4b. HPWT-XX00 Maximum DC Forward Current vs. Ambient Temperature.

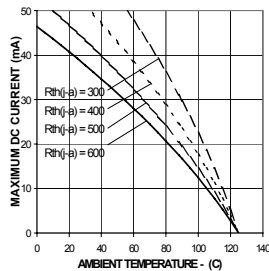

Figure 4c. HPWN-XX00 Maximum DC Forward Current vs. Ambient Temperature.

Note:

1. 24 mm² of Cu pad per emitter at cathode lead is recommended for lowest thermal resistance.

Figures

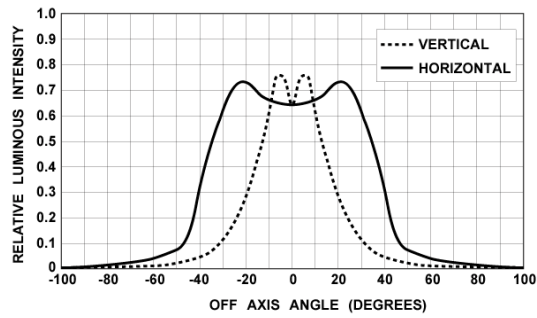

Figure 5a. HPWT-RX00 Relative Luminous Intensity vs. Off Axis Angle.

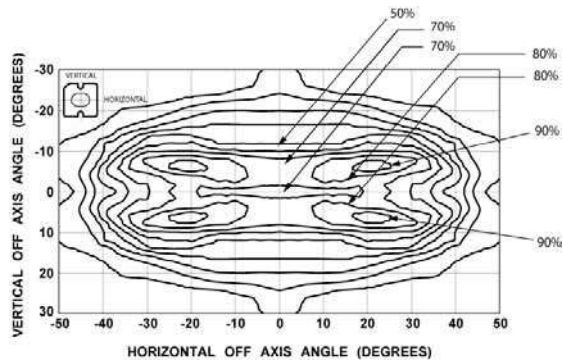

Figure 5b. HPWT-RX00 Relative Luminous Intensity vs. Off Axis Angle. Iso-Intensity Contour Plot.

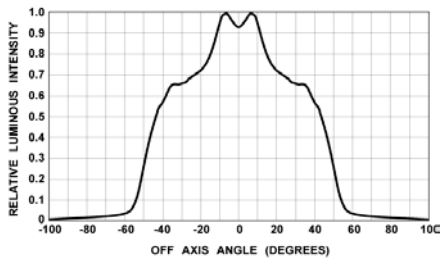

Figure 5c. HPWA-MX00 Relative Luminous Intensity vs. Off Axis Angle.

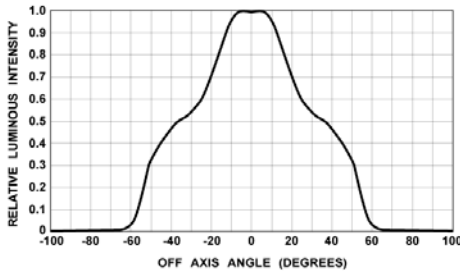

Figure 5d. HPWT-MX00 Relative Luminous Intensity vs. Off Axis Angle.

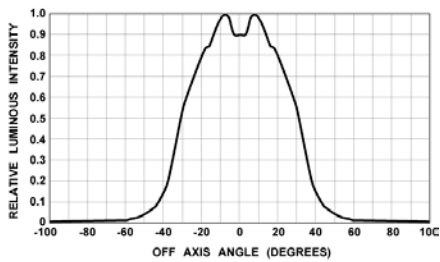

Figure 5e. HPWA-DX00 Relative Luminous Intensity vs. Off Axis Angle.

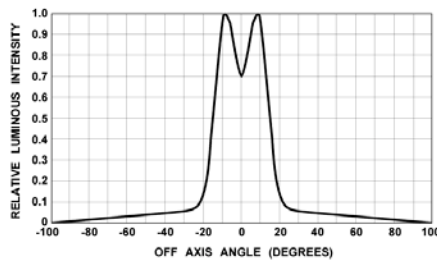

Figure 5f. HPWT-BX00 Relative Luminous Intensity vs. Off Axis Angle.

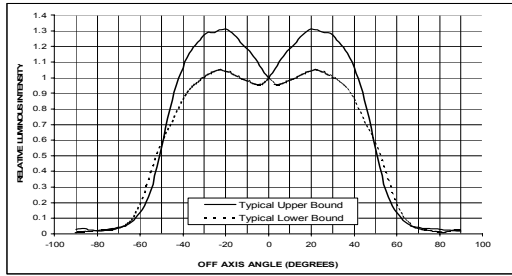

Figure 5g. HPWN-MX00 Relative Luminous Intensity vs. Off Axis Angle

Company Information

Lumileds is a world-class supplier of Light Emitting Diodes (LEDs) producing billions of LEDs annually. Lumileds is a fully integrated supplier, producing core LED material in all three base colors (Red, Green, Blue) and White. Lumileds has R&D development centers in San Jose, California and Best, The Netherlands. Production capabilities in San Jose, California and Malaysia.

Lumileds is pioneering the high-flux LED technology and bridging the gap between solid state LED technology and the lighting world. Lumileds is absolutely dedicated to bringing the best and brightest LED technology to enable new applications and markets in the lighting world.

LUMILEDS™
LIGHT FROM SILICON VALLEY

©2002 Lumileds Lighting. All rights reserved. Lumileds Lighting is a joint venture between Agilent Technologies and Philips Lighting. Luxeon is a trademark of Lumileds Lighting, Inc. Product specifications are subject to change without notice.

Lumileds may make process or materials changes affecting the performance or other characteristics of our products. These products supplied after such changes will continue to meet published specifications, but may not be identical to products supplied as samples or under prior orders.

LUMILEDS

www.luxeon.com
www.lumileds.com

For technical assistance or the location of your nearest Lumileds sales office, call:

Worldwide:
+1 408-435-6044
US Toll free: 877-298-9455
Europe: +31 499 339 439
Fax: 408-435-6855
Email us at info@lumileds.com

Lumileds Lighting, LLC
370 West Trimble Road
San Jose, CA 95131