

Tungsten Light Bulb Non-standard Uses

(12/24/2016)

After the pole shift those old tungsten light bulbs would not be that useful for producing light. They are 8 to 10 times less efficient at producing light than LEDs. Incandescent bulbs are much less efficient than most other types of electric lighting; incandescent bulbs convert less than 5% of the energy they use into visible light, with standard light bulbs averaging about 2.2%. The remaining energy is converted into heat. They could end up with other uses that make them more valuable than the original use. This report discusses some of these potential uses.

Draw a horizontal line through the percent of design voltage to be used and read the value of the calculated parameters (in design percentage) on the right side of the diagram.

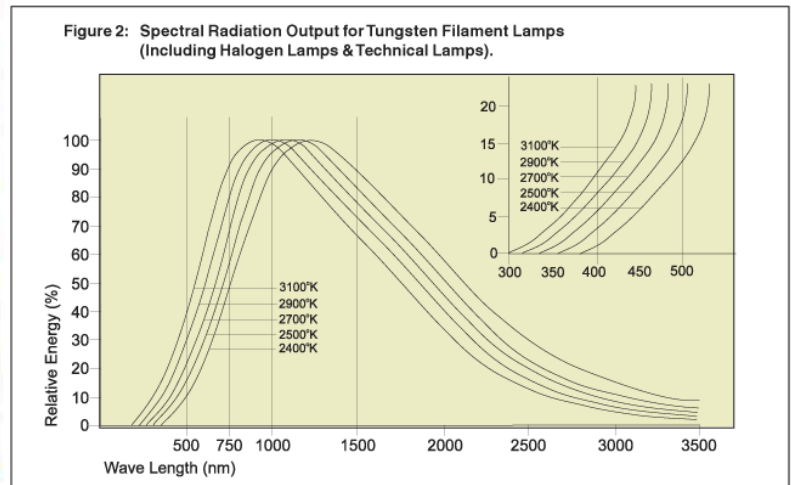
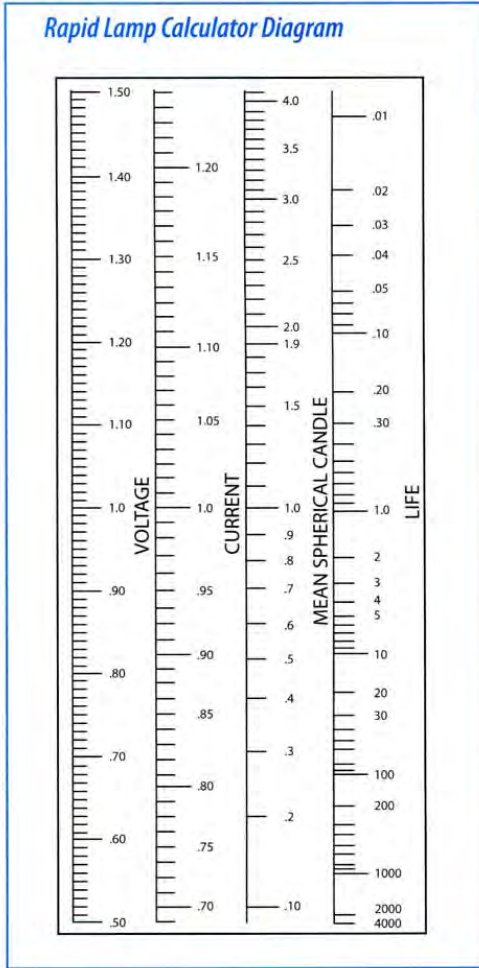

The above nomograph shows that if one operates at 90% of original voltage that the bulb will last about 3-4 times longer producing 70% of the original light. At 80% of original voltage the bulb will last about 15 times longer but only give out about 45% of original light. This does not approach the life time of LEDs and at the expense of much loss in light producing efficiency. However, the use of tungsten bulbs could be useful as a power resistor or current limiter.

Tungsten filament bulbs do have one advantage over LED's in that they provide a wider spectrum of light. Both have a peak frequency. Tungsten produces a lot of infrared heat when compared to LED light spectrum. See the following.

Tungsten Light Bulb Non-standard Uses

(12/24/2016)

Phosphor-Based White LED Emission Spectrum

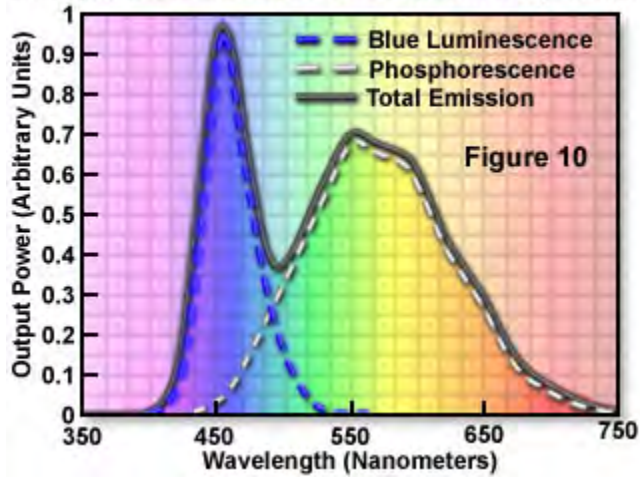

Spectra From Common Sources of Visible Light

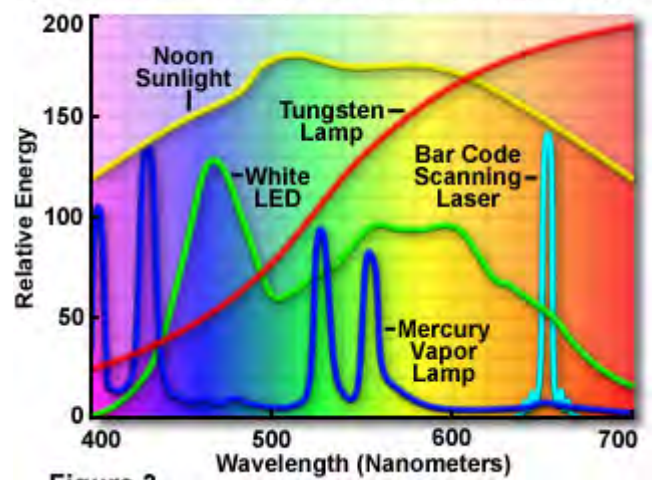

The next nomograph along with the first one, could be useful when determining how best to use your surviving tungsten bulbs.

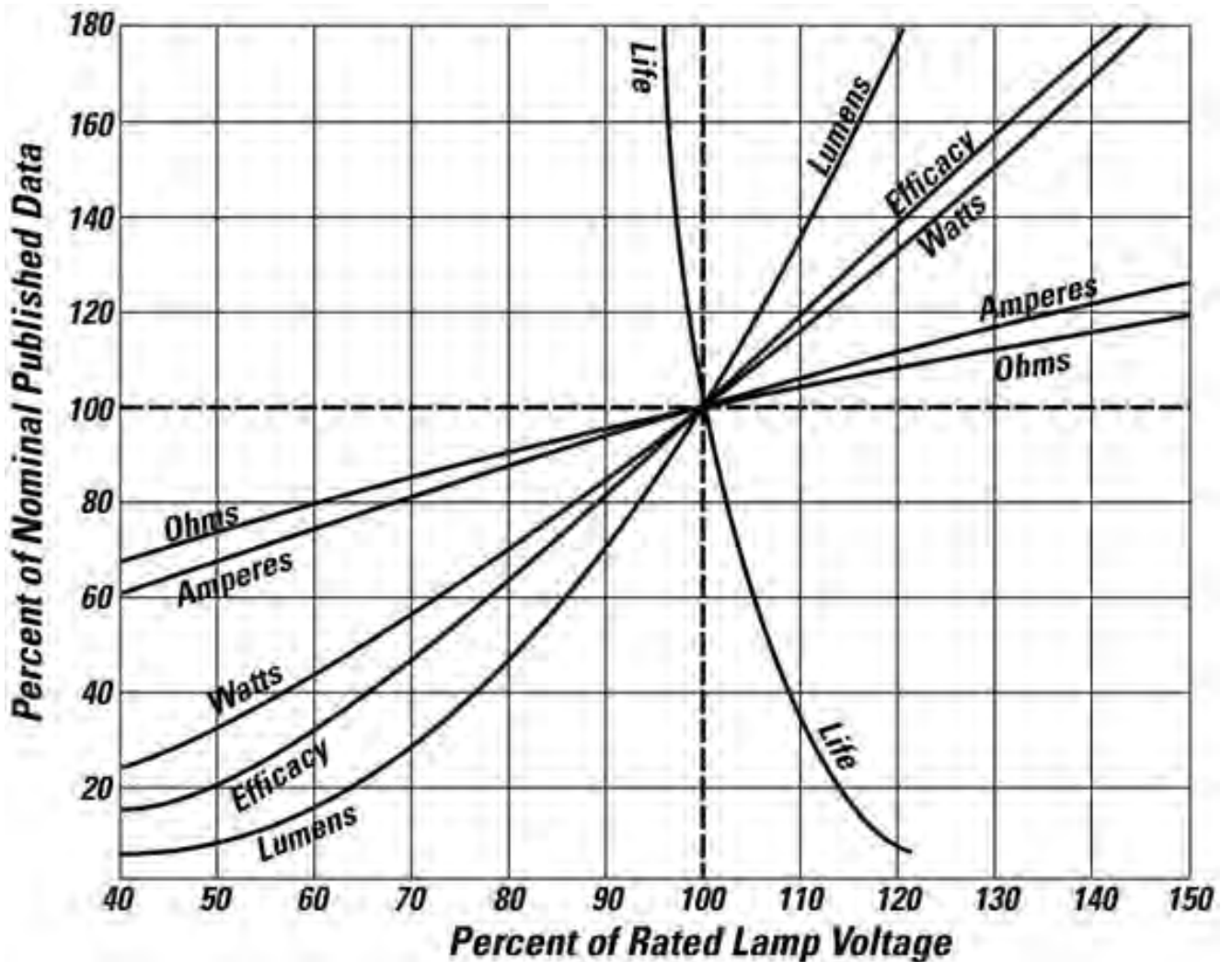

Tungsten Light Bulb Non-standard Uses

(12/24/2016)

Light bulbs used as a resistor or current limiter

The following gives typical curves for resistance, current vs voltage for different voltages and wattage of tungsten light bulbs. It is recommended that one plot what one has at hand before deciding on its use as a resistor or current limiter.

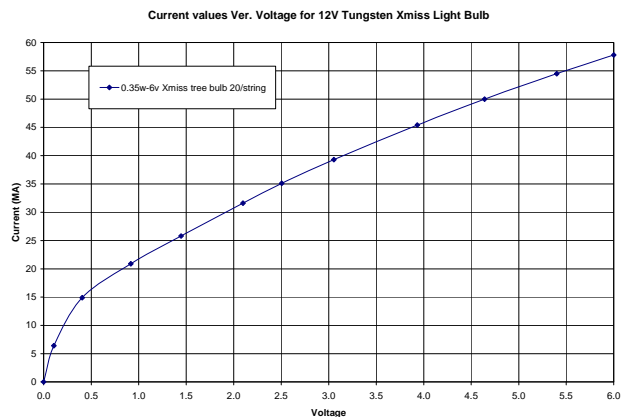
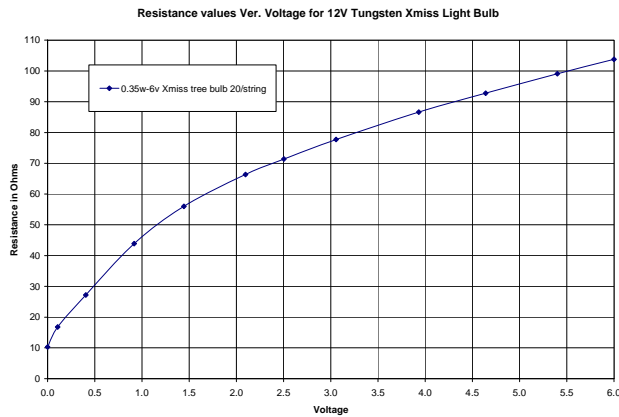
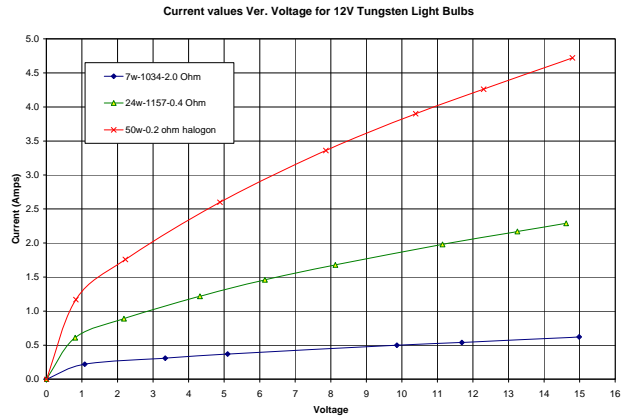
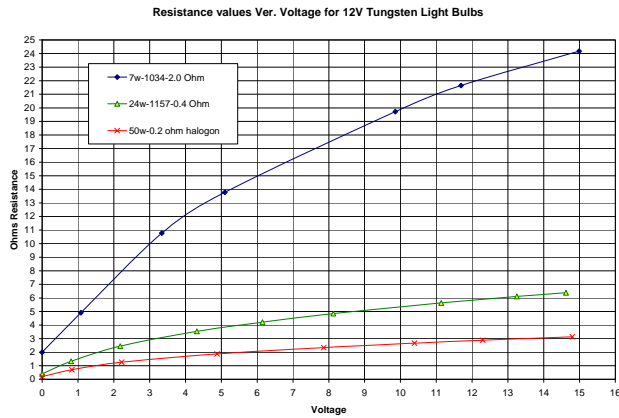
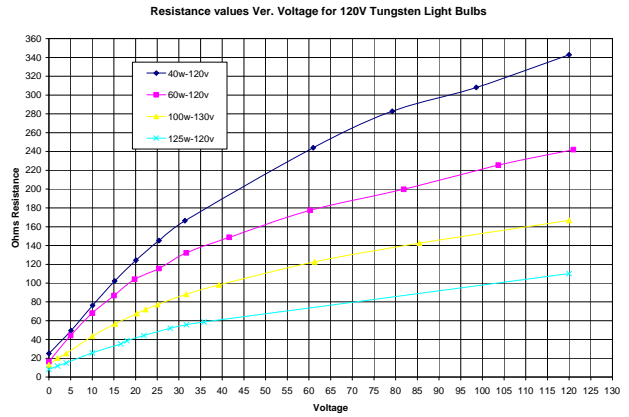
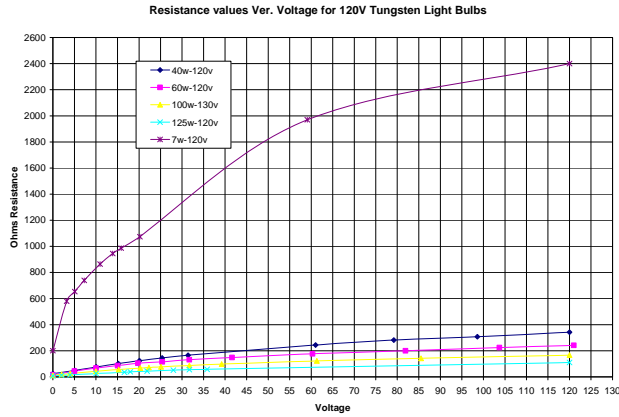

Note that varistors have an opposite shaped curve to tungsten light bulbs. Tungsten bulbs tend to limit current flow as voltage increase. Varistors used in circuit protection, and tend to allow much more current flow above a given voltage. See the following curve as typical for varistors current vs voltage.

Tungsten Light Bulb Non-standard Uses

(12/24/2016)

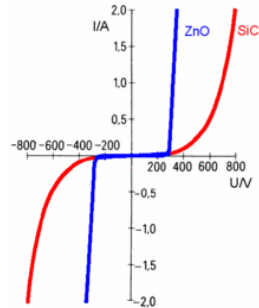

Example use as a Power Supply Current Limiter:

The advantage of an incandescent light bulb over a resistor is that its cold resistance is about 10 times less than when lit up to normal brightness. Therefore you can choose a wattage that limits short circuit current to a safe value, without excessive voltage drop at lower currents. Also, since it takes some time for the filament to heat up and increase resistance, short duration current surges cause much less voltage drop.

You should choose a bulb with a voltage rating close to the power supply voltage (a little lower won't hurt) and wattage that gives an acceptable short circuit current. Power = Volts x Amps, so if you wanted to limit a 12V supply to 0.5A then you would need a 12V 6W lamp.

The maximum normal operating current will then be determined by how much voltage sag is acceptable. This is tricky to calculate because the lamp's change in resistance with current is very non-linear. A 12V 15W tested festoon lamp had a resistance of 0.9 Ohms when cold, and 9.8 Ohms at full brightness. At 0.3A (24% of the bulb's nominal current draw) the output voltage dropped from 12.0V to 11.5V. Here is a graph showing output voltage vs current for the bulb compared to using a 10 Ohm resistor.

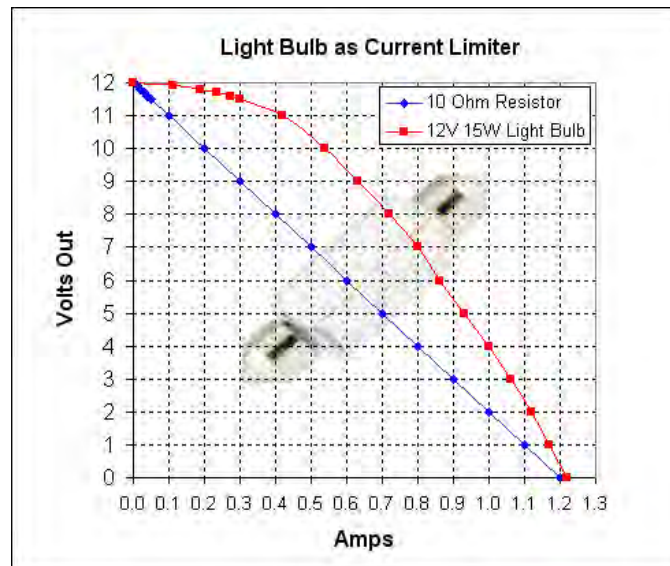

The 'soft' current limiting that a bulb provides is good for protecting against continuous short circuits without affecting normal operation, but won't protect sensitive electronic components which cannot withstand short current surges or slightly higher than normal operating current.

If you need a fast acting current limit with sharper cutoff then you could use a bipolar transistor (PNP for positive voltage, NPN for negative) with its Emitter connected to the power supply, Collector to the load and a high value resistor going from Base to Ground. Maximum collector current will then be determined by the Base current multiplied by the transistor's current gain (which varies from unit to unit, so you may have to adjust the resistor value to get a precise current limit). Or you could use a Polly Fuse (switch) that increases resistance rapidly after it triggers due to a given level of current. Neither of these

Tungsten Light Bulb Non-standard Uses

(12/24/2016)

would be a normal option in a primitive environment, thus the use of tungsten light bulbs salvaged from abandoned cars would be the most likely option.

Use as an electric Heater

If one uses a tungsten light bulb at lower than rated voltage it puts out a lot of heat and not much light. This can be used to **warm hands, warm seeds during germination, and even as a slow food cooker.** How does one do this? One easy way to lower voltage and power usage is to put two light bulbs in series. The following table shows the results as the wattage is adjusted. This also shows how one can get the voltage one needs for a given project (as a voltage limiter).

Input of 120 volts					
No. 1 Bulb		No. 2 Bulb		Series Result	
Watts	Voltage	Watts	Voltage	Current	Watts
40	60	40	60	0.25	30
60	60	60	60	0.34	41
100	60	100	60	0.50	60
40	41	60	79	0.28	34
40	22	100	98	0.32	38
60	39	100	81	0.41	49

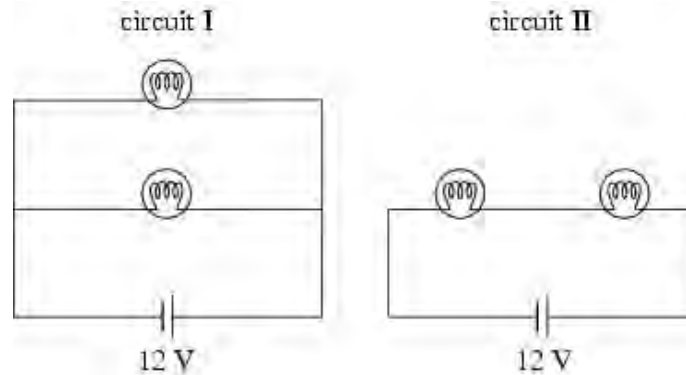

Circuit I is “parallel” connected. Circuit II is “series” connected.

Old Food Cooler As a Food Slow Cooker

Ice type food cooler for camping with a few added old style x-miss bulbs makes a good adjustable heater hot box. By unscrewing bulbs, one can selectively turn off bulbs, and lower the maxim heat. These coolers are made of plastic and may or may not withstand enough temperature for cooking.

A simple box made of plywood put inside one of these well insulated existing coolers should be enough to be able to raise the temperature up to boiling inside the box with very little power usage and without melting the cooler. My tests indicate wood, cardboard, paper will withstand up to about 218 deg C or 425 deg F. This is will above boiling point at 212 deg F. Ideally the heat source (light bubs) should be below the pot. This could be done with a heavy screen or metal grill placed above the bulbs, wood below and on the sides then cardboard then the existing cooler with its insulation.

Tungsten Light Bulb Non-standard Uses

(12/24/2016)

To give a feeling for what is needed. The following test was done. This type of cooler is not that well insulated and was giving off a lot of heat though the sides. This could be felt with the hands. The task is to insulate as much as you can until you feel no heat from the sides yet the inside is 212 deg F or boiling temperature. 4 bulbs wired in parallel were used. One can unscrew one or more bulbs to adjust the final temperature. Using two bulbs of the same type in series would put out mostly heat and not much light. The parallel connecting sets of two series conned bulbs would allow temperature changing.



This test unit measured on the inside an average of 7"x9.5"x10 and at 21.3 watts heated up from 72 degrees to about 130 degree Fahrenheit over about 2 hours before maxing out. This is where the heat escaped though the walls equaled the heat coming in through the bulbs. If better insulation were used then the same wattage would level off at a higher temperature.

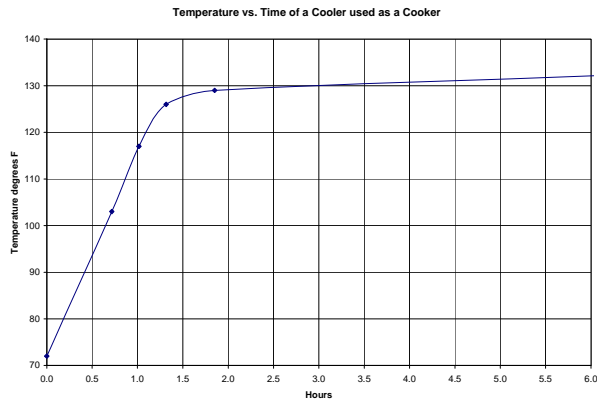

Calculating the K Factor of industry standard Insulation

If R factor is unknown, the formula to calculate the K factor of insulation is:

$$K \text{ factor} = \text{BTU-in} / \text{hr} - \text{ft}^2 - \text{°F}$$

or

British Thermal Unit-Inch Per Square Foot Per Hour Per Fahrenheit Degree

If R factor is know, this easier formula can be used to calculate the K factor:

$$K \text{ factor} = \text{inches of thickness} / R \text{ Factor}$$

Tungsten Light Bulb Non-standard Uses

(12/24/2016)

Calculating the B Factor of ones tested Insulation

Assuming BTU in our case is proportional to Watt of power, and then we can conclude that the following would be our new practical after pole shift “constant B” for “build factor”.

B factor = watts*(inches thick)/ (hours)*(square feet)*(change in temperature in degree F)

Recommend this determined for your best build.

For this test star-foam cooler material test this was approximately:

$$B=(21.3*0.5*144\text{sq in/sq ft})/(2*2*((7*9.5)+(7*10)+(9.5*10))*(130-72)) = 0.0286 \text{ watt-in/hr-ft}^2\text{-}^\circ\text{F}$$

Assuming this now is a constant. Then a similar build that would go to 212 F boiling temperature would be: Watts needed for 1 cubic foot or 6 square feet at 1hr = $B*\text{hr}* \text{ft}^2*\text{ }^\circ\text{F/in} = .0286*1*6*(212-72)/.5 = 48$ watts for same .5 inch thick star foam material. One could do better than this with thicker or better insulation.

This test unit as shown would work for warming seeds to speed germination. One would unscrew bulbs until the desired temperature. Optimum temperature for beans germination is 80 deg F. See below for guide lines of other seeds.

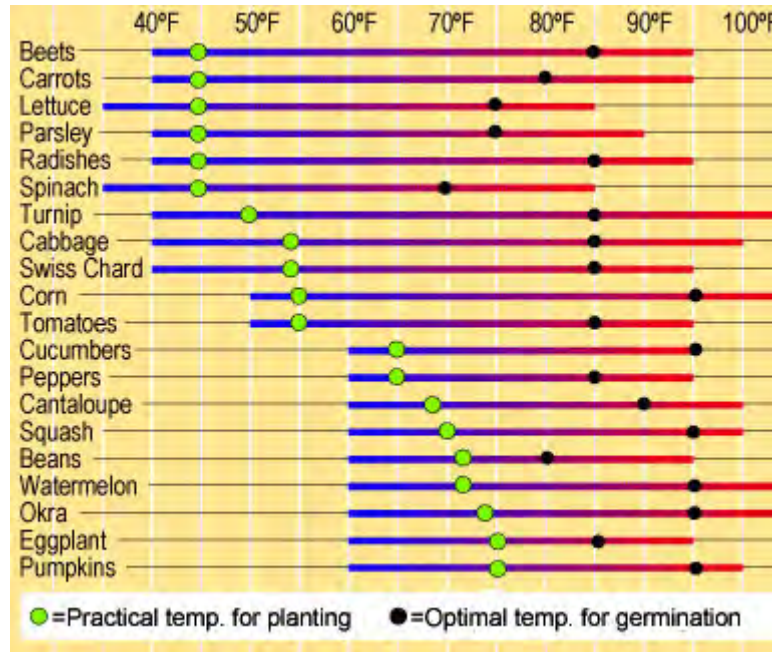

Cooking strategies: One could use efficient conventional techniques to raise the temperature fast up to boiling temp and then put the pot in one of these slow cookers. Or one could take the time to raise the temperature slowly putting it in the slow cooker to start with. It is believed at this time that raising the temperature fast using the most efficient method one has, then transferring to one of these slow light bulb cookers would be the most efficient use of electrical power. This technique should work well for rice and beans that take a long time to cook.

References:

Incandescent light bulb

https://en.wikipedia.org/wiki/Incandescent_light_bulb