

AT MICROFICHE
REFERENCE
LIBRARY

A project of Volunteers in Asia

Manual of Basic Techniques for a Health Laboratory

Published by:
World Health Organization
CH-1211 Geneva 27
Switzerland

Paper copies are 30 Swiss francs.

Available from:
World Health Organization
CH-1211 Geneva 27
Switzerland

Reproduced by permission of the World Health
Organization.

Reproduction of this microfiche document in any
form is subject to the same restrictions as those
of the original document.

Manual of basic techniques for a health laboratory

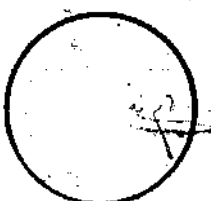
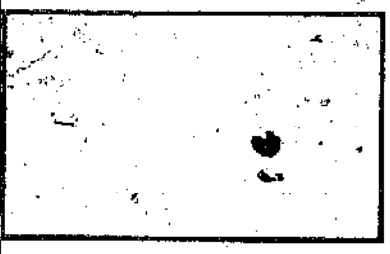
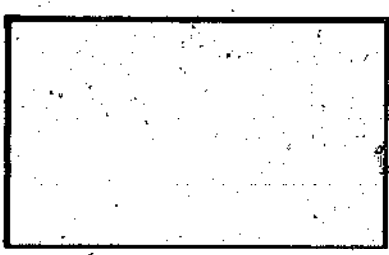
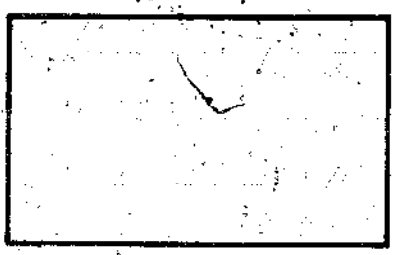
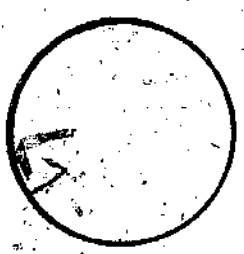
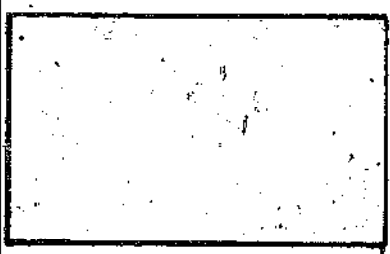
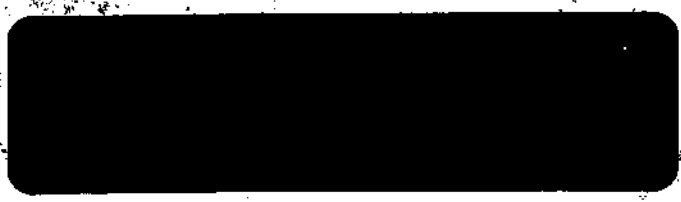

The World Health Organization is a specialized agency of the United Nations with primary responsibility for international health matters and public health. Through this organization, which was created in 1948, the health professions of some 150 countries exchange their knowledge and experience with the aim of achieving the highest possible level of health throughout the world.

By means of direct technical cooperation with its Member States, and by stimulating such cooperation among them, WHO promotes the development of comprehensive health services, the prevention and control of diseases, the improvement of environmental conditions, the development of health manpower, the coordination and development of biomedical and health services research, and the planning and implementation of health programmes.

These broad fields of endeavour encompass a wide variety of activities, such as developing systems of primary health care that reach the whole population of Member countries; promoting the health of mothers and children; combating malnutrition; eradicating smallpox throughout the world; controlling malaria and other communicable diseases including tuberculosis and leprosy; promoting mass immunization campaigns against a number of preventable diseases; improving mental health; providing safe water supplies; and training health personnel of all categories.

Progress towards better health throughout the world also demands international cooperation in such matters as establishing international standards for biological substances, pesticides and pharmaceuticals; recommending international nonproprietary names for drugs; administering the International Health Regulations; revising the international classification of diseases and causes of death; and collecting and disseminating health statistical information.

Further information on many aspects of WHO's work is presented in the Organization's publications.

Manual of Basic Techniques for a Health Laboratory

**WORLD
HEALTH
ORGANIZATION
GENEVA 1980**



© World Health Organization 1980

ISBN 92 4 154145 B

Publications of the World Health Organization enjoy copyright protection in accordance with the provisions of Protocol 2 of the Universal Copyright Convention. For rights of reproduction or translation of WHO publications, in part or *in toto*, application should be made to the Office of Publications, World Health Organization, Geneva, Switzerland. The World Health Organization welcomes such applications.

The designations employed and the presentation of the material in this publication do not imply the expression of any opinion whatsoever on the part of the Director-General of the World Health Organization concerning the legal status of any country, territory, city or area or of its authorities, or concerning the delimitation of its frontiers or boundaries.

The mention of specific companies or of certain manufacturers' products does not imply that they are endorsed or recommended by the World Health Organization in preference to others of a similar nature that are not mentioned.

Errors and omissions excepted, the names of proprietary products are distinguished by initial capital letters.

77/4086 - ACCENT/INDEX PRINTERS - 20000

TYPESET AND PRINTED IN ENGLAND

Contents

	Page
Preface	1
Aim of the manual	2
How to use the manual	3
The responsibility of the laboratory worker	4
Units of measurement	5

PART I

GENERAL LABORATORY PROCEDURES

1. The microscope: adjustment and maintenance	13
2. Laboratory glassware and small apparatus	27
3. Cleaning glassware	29
4. Sterilization	33
5. Disposal of specimens and infected material	39
6. Measurement of volume	42
7. Balances	48
8. Centrifuges	52
9. Water for laboratory use	56
10. Making glass equipment	64
11. Specimen containers	68
12. Dispatch of specimens to a reference laboratory	71
13. Fixation and dispatch of biopsy material for pathological examination	75
14. Registration of specimens; laboratory records and monthly reports	78
15. Storage, inventory, ordering supplies	85
16. Electricity: setting up simple electrical equipment	87
17. Plumbing: simple procedures	94
18. First aid in laboratory accidents	98
19. Plan of a peripheral medical laboratory	102
20. List of apparatus to equip a peripheral laboratory	104

PART II

A. PARASITOLOGY

Introduction	111
1. What to look for. Collection of stools	113
2. Slide preparation	116
3. Special technique for pinworm eggs	119
4. Eggs and larvae of intestinal parasites	122
5. Adult worms found in stools	143
6. Amoebae, flagellates, and ciliates: motile forms	147
7. Amoebae, flagellates, and ciliates: cysts	155
8. Choice of method for concentration of parasites	162
9. Concentration method using sodium chloride solution (Willis)	163
10. Concentration method using formaldehyde-ether or MIF	165
11. Concentration method for <i>Strongyloides</i> larvae (Harada-Mori)	168
12. How to record the results of stool examinations	170
13. Dispatch of stools for detection of parasites	173
14. Chemical test for occult blood in stools	175
15. Examination of urine for eggs of <i>Schistosoma haematobium</i>	178
16. Other parasites found in urine	181
17. Eggs of pulmonary flukes; other parasites	183
18. <i>Trichomonas</i> : direct examination of genitourinary discharge, etc.	186
19. Preparation of thick blood film and staining with Field stain	189
20. Staining of thick and thin films with Giemsa stain	193
21. Identification of malaria parasites	196
22. Blood microfilariae: examination of wet preparation, concentration	204
23. Blood microfilariae: staining and identification	209
24. Onchocerciasis: examination for skin microfilariae	215
25. Trypanosomes: detection in the blood, concentration	220
26. Trypanosomes: examination of lymph node fluid	226

B. BACTERIOLOGY

	Page
Introduction	231
27. Preparation of smears. Fixation.	232
28. Gram staining	235
29. Microorganisms found by direct film examination	238
30. Gonococci: direct examination of urethral pus. Syphilis.	243
31. Tubercle bacilli. Ziehl-Neelsen stain: hot method	249
32. Tubercle bacilli. Kinyoun stain: cold method	257
33. Leprosy: examination for the bacillus in nodules and skin lesions.	259
34. Leprosy: examination for the bacillus in nasal smears.	264
35. Plague: examination for the bacillus	265
36. Dispatch of stool specimens	268
37. Direct examination of specimens from the throat. Dispatch of specimens.	270
38. Direct bacteriological examination of urine.	275
39. Water sampling for bacteriological analysis	279

C. SEROLOGY

40. Dispatch of serum and dried blood specimens for serological examination	285
41. VDRL test.	288

D. MYCOLOGY

42. Pityriasis versicolor: direct examination	297
43. Tinea: direct examination	300

PART III

A. EXAMINATION OF URINE

1. Collection of urine specimens and appearance.	305
2. Specific gravity and pH of urine	307
3. Detection and estimation of glucose in urine.	311
4. Detection and estimation of protein in urine.	313
5. Bile pigments in urine	316
6. Urobilinogen in urine	319
7. Ketone substances in urine	320
8. Use of indicator papers and tablets for urine examination.	323
9. Urinary deposits	325
10. Pregnancy tests	336

B. EXAMINATION OF CEREBROSPINAL FLUID

11. Collection of CSF. Appearance	339
12. Leukocyte concentration in the CSF:	342
13. Glucose estimation in the CSF	344
14. Protein in the CSF.	345
15. Microscopical examination of the CSF	347

C. HAEMATOLOGY

	Page
16. The blood cells	351
17. Collection of venous blood	353
18. Leukocyte number concentration	360
19. Erythrocyte number concentration	366
20. Haemoglobin: estimation of cyanmethaemoglobin, photometric method	371
21. Haemoglobin estimation using a comparator	375
22. Haemoglobin estimation by Sahli method	377
23. Erythrocyte volume fraction	379
24. Mean erythrocyte haemoglobin concentration	386
25. Preparation of thin blood films	387
26. Staining of thin blood films	391
27. Leukocyte type number fraction and examination of leukocytes	397
28. Abnormal red cells: microscopical examination	407
29. Test for sickle cells	411
30. Reticulocytes	414
31. Erythrocyte sedimentation rate (ESR)	418
32. Bleeding time: Duke method	421
33. Whole blood coagulation time: Lee and White method	423
34. Clot retraction and lysis time	425

D. BLOOD CHEMISTRY

35. Blood and CSF glucose estimation: orthotoluidine method	429
36. Urea estimation: diacetyl monoxime/thiosemicarbazide method	432

E. BLOOD TRANSFUSION

37. Blood groups: theory	435
38. ABO grouping with antisera	437
39. ABO grouping with standard red cells	443
40. Rhesus grouping	448
41. Cross-matching (compatibility testing)	453
42. Detection of dangerous group O donors	456
43. Collection and storage of blood	458
44. Blood grouping and cross-matching: summary plan of work	463
Reagents and their preparation	465
Index	479

Preface

This book is a revised version of a WHO manual by Etienne Lévy-Lambert, *Basic techniques for a medical laboratory* (1974), major revisions having been carried out by Miss M. Cheesbrough and Dr L.M. Prescott. The original version was tested in the field and comments and suggestions from national experts in several countries as well as from WHO staff have been used in the revision.

The manual is intended mainly for the use of laboratory assistants in developing countries during their training and thereafter in their work. It can also be used for routine work in clinical or health laboratories. In the selection of techniques particular attention has been paid to the low cost, reliability and simplicity of the methods and to the availability of resources in small laboratories.

The illustrations have been revised by Lynne Cullen Dennis and Pierre Neumann.

WHO expresses its thanks to all those who have assisted in the preparation of this manual.

Aim of the Manual

Laboratories

The manual is intended for use mainly in medical laboratories in developing countries. It is designed particularly for use in peripheral laboratories in such countries, i.e., in small or medium-sized laboratories attached to regional hospitals and in dispensaries and rural health centres where the laboratory technician often has to work alone.

The language used has been kept as simple as possible. Common technical terms are employed, however, when necessary.

Techniques

The manual describes only direct examination procedures that can be carried out with a microscope or other simple apparatus. For example:

- the examination of stools for parasites
- the examination of blood for malaria parasites
- the examination of sputum for tubercle bacilli
- the examination of urine for bile pigments
- the leukocyte type number fraction
- the dispatch of stools to specialized laboratories for the detection of cholera vibrios.

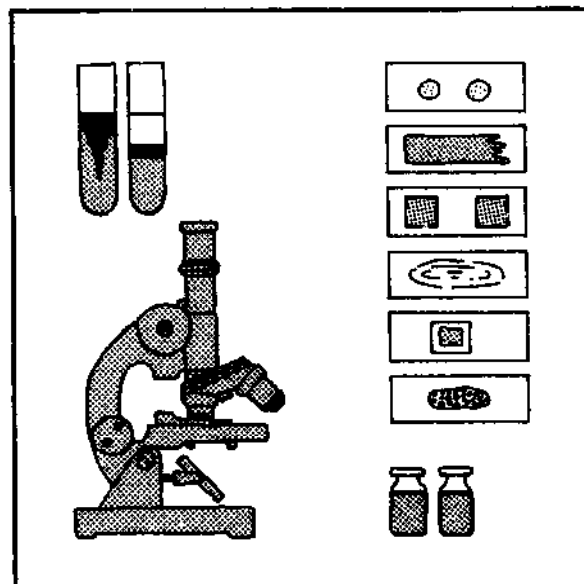

The intention is to provide an account of basic laboratory techniques that are useful to peripheral laboratories and can be carried out with relatively limited routine equipment.

Some laboratories may not be able to perform all the techniques described. For example, a rural health centre laboratory may not be able to carry out blood chemistry or VDRL tests.

How to Use the Manual

1. How to find the required technique

The manual is in three parts according to the subject matter:

- Part I — General laboratory procedures
- Part II — Parasitology
Bacteriology
Serology
Mycology
- Part III — Examination of urine
Cerebrospinal fluid examination
General haematology
Blood chemistry and blood transfusion

A list of the techniques classified according to the subject matter appears in the table of contents. An alphabetical list appears in the index. For example, references to *Gram staining* will be found:

- in the table of contents under *Bacteriology* (Part II, B, 28)
 - in the index under *Stain, Gram*.
-

2. Reagents

Each reagent has been given a number. The reagents required and their numbers are indicated in the description of each technique. An alphabetical list of all of the reagents used, with the numbers assigned to them, their composition, methods of preparation and storage requirements will be found at the end of the volume. For example, for *Gram staining* a reagent needed is crystal violet (reagent No. 15). The composition of crystal violet and the method of preparing it are given in the alphabetical list of reagents at the end of the manual.

3. Equipment

No articles are included that are very expensive or difficult to obtain. The items required for each technique are listed at the beginning of the corresponding section. A list of the apparatus needed to equip a laboratory capable of carrying out all the examinations described can be found on pages 104-107.

When certain articles are not available the technician should do his best to find substitutes: thus empty bottles that formerly contained antibiotics for injection ("penicillin bottles") or other drugs can be kept; racks for test-tubes and slides can be made locally; empty tins can be used to make water baths; etc.

The Responsibility of the Laboratory Worker

The laboratory worker carries out laboratory examinations to provide information for doctors (or their representatives) in order to benefit patients. He therefore plays an important role in helping patients to get better. At the same time, in the course of his work he gains a lot of information about patients and their illnesses. The laboratory worker, like the doctor, must regard this information as strictly confidential; only the doctor who requests examinations should receive the reports on them. When patients inquire about test results they should be told to ask the doctor.

In most countries of the world there are high moral and professional standards of behaviour for doctors and qualified laboratory personnel. Every laboratory worker handling clinical materials must maintain these standards.

Units of Measurement

In the laboratory you will work extensively with both quantities and units of measurement, and it is important to understand the difference between them.

Any measurable physical property is called a *quantity*. Note that the word "quantity" has two meanings: the scientific meaning just defined and the everyday meaning "amount of". In scientific usage height, length, speed, temperature and electric current are quantities, whereas the standards in which they are measured are units.

Quantities and units in the clinical laboratory

Almost all your work in the laboratory will involve making measurements of quantities and using units in reporting the results of those measurements. Since the health — and even the life — of a patient may depend on the care with which you make a measurement and the way in which you report its results, you should thoroughly understand (a) the quantities you measure, (b) the names that are given to those quantities, and (c) the units that are used to measure the quantities.

New units and names for quantities

A simple standardized set of units of measurement has been the goal of scientists for almost two centuries. Over the years numerous different systems have been proposed, but all but one of them have, for one reason or another, proved unsatisfactory. The exception is a version of the metric system that was introduced in 1901. Since then this system has been gradually expanded, and in 1960 it was given the name *International System of Units* and the international abbreviation "SI". Units of measurement that form part of this system are called "SI units". These units have been used to an increasing extent in the sciences, especially chemistry and physics, since 1901 (long before they were called SI units), but most of them were introduced into medicine only after the system was renamed "International System of Units". Some countries have already made the change to the use of SI units in medicine, others are now in the process of making it, and in others the change is only in the planning stage. Furthermore, in some countries the change is being made not on a nationwide basis but in one locality (or even in one laboratory) at a time.

To accompany the introduction of SI units, medical scientists prepared a systematic list of names for quantities. Some of these names are the same as the traditional ones; in other cases, however, the traditional names were inaccurate, misleading or ambiguous, and new names were introduced to replace them.

This manual primarily uses SI units and the new names for quantities. However, since many of the areas and laboratories in which it will be used have not yet made the change to SI units, traditional units and traditional names for quantities are also included and the relationship between the two is explained.

The following section gives a brief description of the SI units and of the new quantity names that are used in this manual.

SI units used in this manual

All SI units are based on seven *SI base units*. Only four of them are used in this manual; they are listed in the accompanying table.

Name of quantity	Name of SI base unit	Symbol for SI base unit
length	metre	m
mass	kilogram	kg
time	second	s
amount of substance	mole	mol

The first three of these units will be familiar to you, although the quantity name "mass" may need explanation; the last quantity name and unit will undoubtedly require explanation. *Mass* is the correct term for what is commonly called "weight". (There is a technical meaning of the term "weight": it is a measure of the force with which the earth's gravity attracts a given mass. Mass, on the other hand, is independent of the earth's gravitational attraction. The two terms are mixed up in everyday usage; furthermore, we speak of measuring a mass as "weighing".) "Amount of substance" and its unit, *mole*, are very important in medicine and they will affect your work in the laboratory more than any other quantities or SI units. When two or more chemical substances react together, they do not do so in relation to their mass. For example, in the reaction

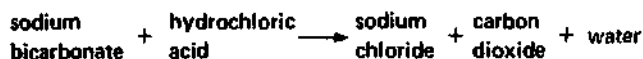

1 kg (1 kilogram) of sodium bicarbonate does not react with 1 kg of hydrochloric acid. On the contrary, 1 mol (1 mole) of sodium bicarbonate reacts with 1 mol of hydrochloric acid. Whenever chemical substances interact, they do so in relation to their relative molecular mass (the new name for what used to be called "molecular weight"). Use of the mole, which is based on the relative molecular mass, therefore gives a measure of equivalent amounts of two or more different substances (use of mass units does not).

The great majority of the SI units are called *SI derived units*. These are obtained by combining the SI base units (by multiplication or division) as appropriate. Some common SI derived units are shown in the accompanying table.

Name of quantity	Name of SI derived unit	Symbol for SI derived unit
area	square metre	m ²
volume	cubic metre	m ³
speed	metre per second	m/s

You will see that the unit of area is metre x metre = metre squared or square metre; the unit of volume is metre x metre x metre = metre cubed or cubic metre; and the unit of speed is metre divided by second = metre per second. All the SI derived units are obtained in this simple way. In some cases, however, it is necessary to multiply and divide several times, and the resulting expression becomes very cumbersome; for example, the unit of pressure is kilogram divided by (metre x second x second). To avoid this difficulty such units are given special names. For example, the unit of pressure is called the pascal.

If only the SI base units and derived units were available, measurements would be difficult because these units are too large or too small for many purposes. For example, the metre is far too big for convenient measurement of the diameter of a red blood cell. To overcome this difficulty, the SI incorporates a series of prefixes, called *SI prefixes*, which when added to the name of a unit multiply or divide that unit by a certain factor, giving multiples or submultiples of the unit. The SI prefixes used in this manual are listed in the accompanying table.

Name of prefix	Symbol for prefix	Multiplication/division factor
mega	M	mult. by 1 million (x 10 ⁶)
kilo	k	mult. by 1 thousand (x 10 ³)
centi	c	div. by 1 hundred (x 0.01 or 10 ⁻²)
milli	m	div. by 1 thousand (x 0.001 or 10 ⁻³)
micro	μ	div. by 1 million (x 10 ⁻⁶)
nano	n	div. by 1 000 million (x 10 ⁻⁹)

For example, 1 kilometre (symbol: km) = 1 000 metres (1 000 m); 1 centimetre (1 cm) = 0.01 metre (0.01 m or 10^{-2} m); 1 millimetre (1 mm) = 0.001 metre (0.001 m or 10^{-3} m); and 1 micrometre (1 μm) = 0.000 001 metre (0.000 001 m or 10^{-6} m). Most of these prefixes will already be familiar to you when they are applied to the metre. All you have to remember is that they have the same meaning when they are applied to any other unit.

New quantity names

It was stated above that, to accompany the change to SI units, certain new names for quantities were introduced. There are not very many of these; quantity names such as length, height, area, volume, and speed remain unchanged. Most of the new names are related to concentration and related quantities. The difficulty with concentration is that it can be expressed in several different ways. Traditionally all of these were called simply "concentration", which was misleading. Now each different way of expressing concentration has its own special name. Before these new names can be described, it is necessary to explain the unit of volume called the "litre". You are probably familiar with this unit of volume, and may have been surprised not to find it mentioned above in the discussion of SI derived units. It was not mentioned there because the litre is not, strictly speaking, an SI unit. The SI (derived) unit of volume is the cubic metre, but this is far too large to be convenient for measurements of body fluids. A submultiple of the cubic metre is therefore used: the cubic decimetre. The prefix "deci" was not listed above because it is not used in this manual, but it means division by 10 (or multiplication by 0.1 or 10^{-1}). A decimetre is therefore 0.1 m, and a cubic decimetre is $0.1 \times 0.1 \times 0.1 \text{ m}^3 = 0.001 \text{ m}^3$ (or 10^{-3} m^3 ; that is, one-thousandth of a cubic metre). The name "litre", although not part of the SI, has been approved for use as a special name for the cubic decimetre. The litre and its submultiples, such as the millilitre, are used mainly for measuring relatively small volumes of liquids and sometimes gases; volumes of solids and large volumes of liquids and gases are usually measured in terms of the cubic metre or one of its multiples or submultiples. The litre is a very important unit because it is the unit used in the clinical laboratory for reporting all concentrations and related quantities. However, you may encounter (for example, on graduated glassware) volumes marked in terms of submultiples of the cubic metre. At the end of this section you will find a table of equivalents in the two systems.

Having explained the litre, we can now return to the names for different ways of expressing concentration. First, suppose that we have a solution of salt. The mass of dissolved salt divided by the volume of solution is called the *mass concentration*. A more general definition of mass concentration is "the mass of a given component (e.g., a dissolved substance) divided by the volume of solution". The unit in which it is measured is gram (or milligram, microgram, etc.) per litre. In the SI system mass concentration is rarely used; it is used only for substances whose relative molecular mass ("molecular weight") is uncertain, such as proteins.

Now suppose that we have another solution of salt, only this time the amount of dissolved salt is expressed in terms of "amount of substance". The amount of substance of salt (that is, the number of moles of salt) contained in the solution divided by the volume of the solution is called the amount of substance concentration, or, for short, the *substance concentration*. A more general definition of substance concentration is "the amount of substance of a given component (e.g., a dissolved substance) divided by the volume of solution". The unit in which substance concentration is measured is mole (or millimole, micromole, etc.) per litre. In using SI units all concentrations are expressed in terms of substance concentration wherever possible.

This use of substance concentration instead of mass concentration is the most important difference between the use of SI units and the use of traditional units.

In the traditional system mass concentration was used almost exclusively (although it was not called "mass concentration", which is a relatively new name). However, mass concentration was not, in the traditional system, always expressed in terms of "per litre". Sometimes "per litre" was used, sometimes "per 100 ml" (that is, per 100 millilitres or 1/10 litre), and sometimes "per millilitre". Different countries (and even different laboratories in the same country) followed different practices, making for considerable confusion.

For particles or entities that are not dissolved it is not possible to use either mass concentration or substance concentration; a different quantity must be used. For example, the blood contains many different kinds of cell. These cells are suspended in the blood, and we must have a way of expressing the number of cells in each litre of blood. In this case the quantity name is *number concentration*, which is defined as "the number of specified particles or entities in a mixture divided by the volume of the mixture". The unit in which number concentration is measured is number per litre.

In the traditional system number concentration was called a "count" and it was expressed in the unit "number per cubic millimetre".

Sometimes the quantity that is of concern is not the actual number of cells per litre (number concentration) but the proportion of cells of a given type – that is, the fraction of the total number that is accounted for by cells of that type. This quantity is called *number fraction*, and the unit in which it is measured is 1 (unity, "one"). At first sight this may seem a little confusing, but in reality it is very simple. Unity, or the number "one", represents the whole; 0.5 represents one half, 0.2 one fifth, 0.25 one quarter, 0.1 one tenth, and so on. For example, five kinds of leukocyte (white cell) occur in the blood. The number fraction of each type might be 0.45, 0.35, 0.10, 0.08 and 0.02. (If you add these fractions, you will find that the total is 1.0 – the whole).

In the traditional system this quantity had no name and results were reported as percentages instead of fractions. For example, a number fraction of 0.5 was reported as 50%, and a number fraction of 0.08 was reported as 8%. From this you will see that percentage divided by 100 gives number fraction.

Another quantity that is measured by the unit "one" is *volume fraction*. This is defined as the volume of a specified component of a mixture divided by the total volume of the mixture. For example, if the total volume occupied by all the erythrocytes (red cells) in 1 litre (1 000 ml) of blood is 450 ml, the erythrocyte volume fraction is $450/1\ 000 = 0.45$. The erythrocyte volume fraction is important for the diagnosis of many diseases and you will often measure it in the laboratory.

In the traditional system volume fraction had no special name: instead, each different volume fraction had a different name. Erythrocyte volume fraction, for example, was called "packed cell volume" (which was misleading because it did not specify what kind of cell was measured and because it was reported as a percentage, not as a volume).

From the above explanation you will see that number fraction is "number per number" and volume fraction is "volume per volume" – that is, they are both ratios. For convenience, we say that the unit for reporting a ratio is "one".

On the following pages you will find a table of new and traditional quantity names and of SI and traditional units, with conversion factors.

UNITS OF VOLUME
Equivalent submultiples of the cubic metre and of the litre

Name	Symbol	Equivalent in terms of cubic metre	Name	Symbol	Equivalent in terms of litre	Equivalent in terms of millilitre
cubic decimetre	dm ³	= 0.001 m ³	= litre	l	=	= 1 000 ml
(no special name)	100 cm ³	= 0.0001 m ³	= decilitre*	dl	= 0.1 litre	= 100 ml
(no special name)	10 cm ³	= 0.000 01 m ³	= centilitre*	cl	= 0.01 litre	= 10 ml
cubic centimetre	cm ³	= 0.000 001 m ³	= millilitre	ml	= 0.001 litre	
cubic millimetre	mm ³	= 0.000 000 001 m ³	= microlitre	μl	= 0.000 001 litre	= 0.001 ml

*Seldom used in the laboratory.

NEW QUANTITY NAMES AND SI UNITS, TRADITIONAL EQUIVALENTS, AND CONVERSION FACTORS

New quantity name	SI unit	Traditional quantity name	Trad. unit	Conv. factors & examples ^a
erythrocyte number concentration (see page 386)	no. x 10 ¹² /l	erythrocyte count	millions/mm ³	no conv. factor: 4.5 millions/mm ³ = <u>4.5 x 10¹² /l</u> 5.0 x 10 ¹² /l = 5.0 millions/mm ³
erythrocyte volume fraction (see page 379)	1	packed cell volume or haematocrit	%	packed cell volume 38% x <u>0.01</u> = erythrocyte volume fraction 0.38 erythrocyte volume fraction 0.4 x <u>100</u> = packed cell volume 40%
leukocyte number concentration (blood) (see page 360)	no. x 10 ⁹ /l	leukocyte count (blood)	no./mm ³	8 000/mm ³ x <u>0.001</u> = 8.0 x 10 ⁹ /l 7.5 x 10 ⁹ /l x <u>1 000</u> = 7 500/mm ³
leukocyte number concentration (cerebrospinal fluid) (see page 342)	no. x 10 ⁶ /l	leukocyte count (cerebrospinal fluid)	no./mm ³	no conv. factor: 27/mm ³ = 27 x 10 ⁶ /l 25 x 10 ⁶ /l = 25/mm ³
leukocyte type number fraction (e.g. lymphocyte number fraction) (see pages 397, 343)	1	differential leukocyte count (e.g. lymphocytes)	%	lymphocytes 33% x <u>0.01</u> = lymphocyte number fraction 0.33 lymphocyte number fraction 0.33 x 100 = lymphocytes 33%
reticulocyte number concentration (see page 416)	no. x 10 ⁹ /l	reticulocyte count	no./mm ³	86 000/mm ³ x <u>0.001</u> = 86.0 x 10 ⁹ /l 91.5 x 10 ⁹ /l x <u>1 000</u> = 91 500/mm ³
reticulocyte number fraction ^b (see page 416)	10 ⁻³	reticulocyte count	% or ‰	(a) 0.50% x <u>10</u> = 5 x 10 ⁻³ 12 x 10 ⁻³ x <u>0.1</u> = 1.2% or (b) 5 ‰ = 5 x 10 ⁻³ 12 x 10 ⁻³ = 12 ‰
thrombocyte number concentration	no. x 10 ⁹ /l	thrombocyte count	no./mm ³	220 000/mm ³ x <u>0.001</u> = 220 x 10 ⁹ /l 250 x 10 ⁹ /l x <u>1 000</u> = 250 000/mm ³

^a The examples show first the conversion of actual numerical values in traditional units into values in SI units, and then the conversion from SI into traditional units. The conversion factor is underlined.

^b In this case, number fraction is reported not as a fraction of 1, but as a fraction of 1 000, in order to avoid inconveniently small numerical values.

New quantity name	SI unit	Traditional quantity name	Trad. unit	Conv. factors & examples*
glucose, substance concentration (blood and cerebrospinal fluid)	mmol/l	glucose, mass concentration ^b (blood and cerebrospinal fluid)	mg/100 ml	81 mg/100 ml \times <u>0.0555</u> = 4.5 mmol/l 4.2 mmol/l \times <u>18.02</u> = 75.7 mg/100 ml
haemoglobin(Fe), substance concentration	mmol/l	haemoglobin, mass concentration ^b	g/100 ml	Hb 13.7 g/100 ml \times <u>0.621</u> = Hb(Fe) 8.5 mmol/l Hb(Fe) 9 mmol/l \times <u>1.61</u> = Hb 14.5 g/100 ml
haemoglobin, mass concentration ^c	g/l	haemoglobin, mass concentration ^b	g/100 ml	14.8 g/100 ml \times <u>10</u> = 148 g/l 139 g/l \times <u>0.1</u> = 13.9 g/100 ml
mean erythrocyte haemoglobin(Fe) substance concentration ^c	mmol/l	mean corpuscular haemoglobin concentration (i.e. mass concentration)	% ^d	35% \times <u>0.621</u> = 21.7 mmol/l 22 mmol/l \times <u>1.611</u> = 35.4%
mean erythrocyte haemoglobin mass concentration ^c	g/l	mean corpuscular haemoglobin concentration (i.e. mass concentration)	% ^d	35% \times <u>10</u> = 350 g/l 298 g/l \times <u>0.1</u> = 29.8%
protein, mass concentration (cerebrospinal fluid)	g/l	protein, mass concentration ^b	mg/100 ml g/l	25 mg/100 ml \times <u>0.01</u> = 0.25 g/l 0.31 g/l \times <u>100</u> = 31 mg/100 ml no change
urea, substance concentration (blood)	mmol/l	urea, mass concentration ^b	mg/100 ml	15 mg/100 ml \times <u>0.167</u> = 2.5 mmol/l 2.9 mmol/l \times <u>6.01</u> = 17.4 mg/100 ml
		urea nitrogen ^e , mass concentration	mg/100 ml	urea nitrogen, 7 mg/100 ml \times <u>0.357</u> = urea, 2.5 mmol/l

* The examples show first the conversion of actual numerical values in traditional units into values in SI units, and then the conversion from SI into traditional units. The conversion factor is underlined.

^b Mass concentration is what was measured, but the term "mass concentration" was not usually used.

^c For explanation, see the text.

^d Mean corpuscular haemoglobin concentration was sometimes expressed in the form of a decimal fraction instead of a percentage, for example 0.35 instead of 35%. In this case, each of the conversion factors listed must be multiplied or divided by 100, as in the following examples:

$$0.35 \times 62.1 = 21.7 \text{ mmol/l}$$

$$22 \text{ mmol/l} \times 0.01611 = 0.354$$

$$0.35 \times 1000 = 350 \text{ g/l}$$

$$298 \text{ g/l} \times 0.001 = 0.298$$

^e In the traditional system urea was sometimes reported in terms of urea and sometimes in terms of urea nitrogen (i.e. the nitrogen content of the urea). Conversions for both systems are shown.

PART I
GENERAL LABORATORY PROCEDURES

1. The Microscope: Adjustment and Maintenance

Many of the diseases prevalent in hot climates are communicable diseases, transmitted by organisms that can often be seen under the microscope in specimens taken from patients. Direct microscopy is therefore indispensable in laboratories in tropical countries.

A clinical laboratory without a microscope or with a microscope that is not properly maintained cannot be considered properly equipped.

1. COMPONENTS OF THE MICROSCOPE

The various components of the microscope can be classified into 4 systems:

- (a) the support system
- (b) the magnification system
- (c) the illumination system
- (d) the adjustment system.

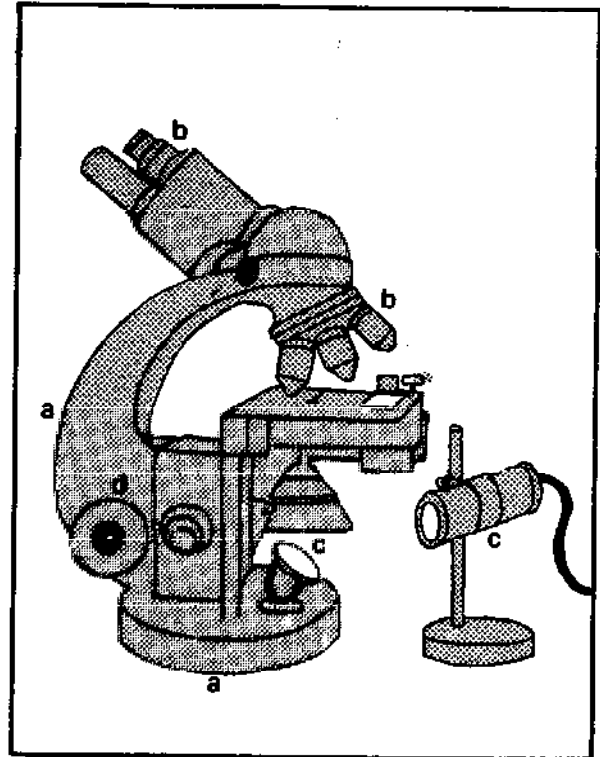

A. The support system

This consists of:

- 1. The foot
- 2. the limb
- 3. the revolving nosepiece (objective changer)
- 4. the stage
- 5. the mechanical stage, which gives a slow controlled movement to the object slide.

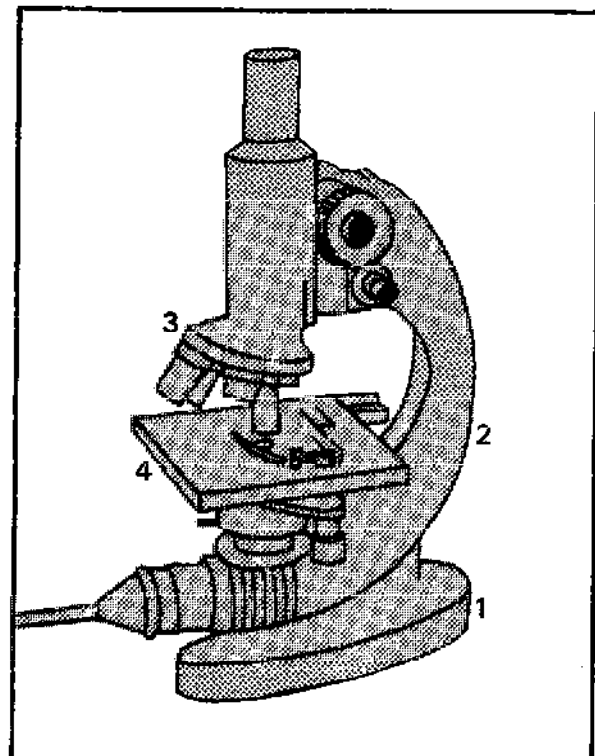

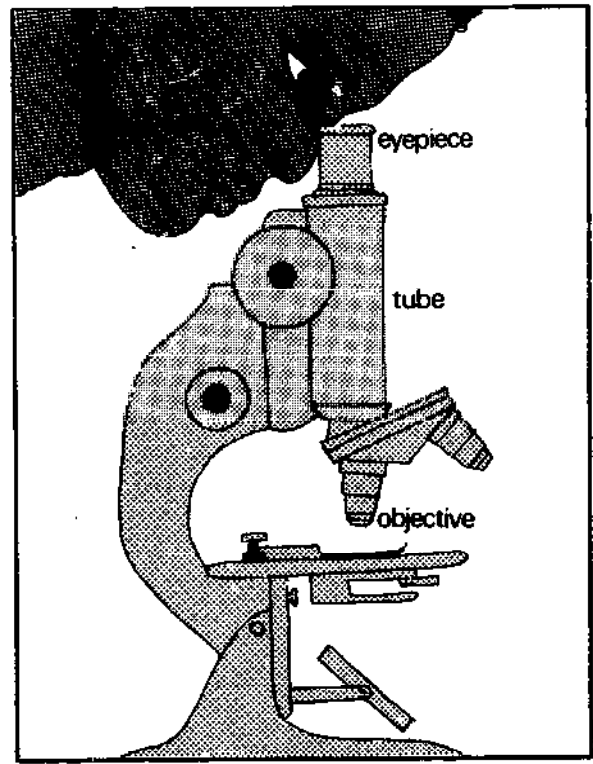

B. The magnification system

This consists of a system of lenses.

The lenses of the microscope are mounted in 2 groups, one at each end of a long tube – *the body tube*:

- the first group of lenses is at the bottom of the tube, just above the preparation under examination (the object), and is called *the objective*
- the second group of lenses is at the top of the tube, where the microscopist applies his eye, and is called *the eyepiece*.

1. THE OBJECTIVES

(a) Magnification

The magnifying power of each objective is shown by a figure engraved on the sleeve of the lens:

- the x 10 objective magnifies 10 times
- the x 40 objective magnifies 40 times
- the x 100 objective magnifies 100 times.

(The x100 objective is usually marked with a red ring to show that it must be used with immersion oil.)

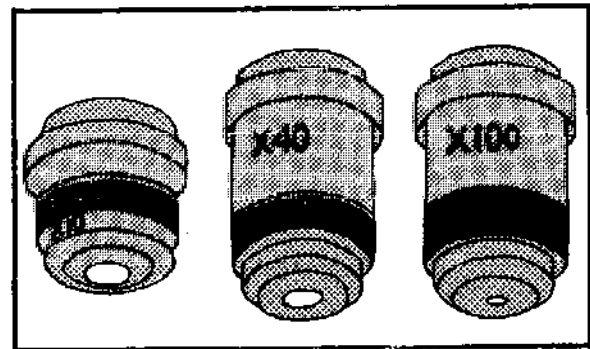

(b) The numerical aperture (NA)

The NA is also engraved on the sleeve, next to the magnification, e.g.:

- 0.30 on the x 10 objective
- 0.65 on the x 40 objective
- 1.30 on the x 100 objective.

The greater the NA, the greater the resolving power (the ability to reveal closely adjacent details as separate and distinct).

(Moreover, the greater the NA figure, the smaller the front lens mounted at the base of the objective. The front lens of the x 100 objective is the size of a pin-head, so handle it with care.)

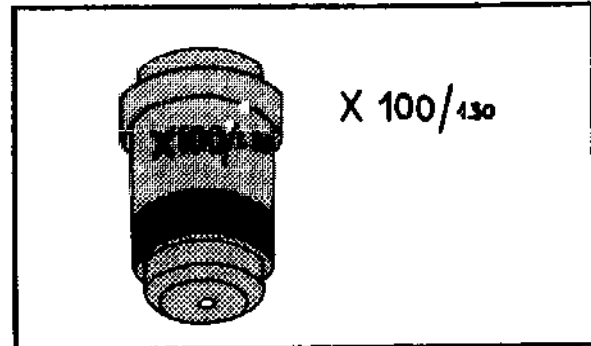

(c) Other figures may be marked on the sleeve:

the recommended length in mm of the tube (between the objective and the eyepiece) – usually 160 mm

the recommended thickness in mm of the coverslip used to cover the object slide – e.g., 0.17.

The screw threads of all objectives are standard, so the objectives in the revolving nosepiece are interchangeable.

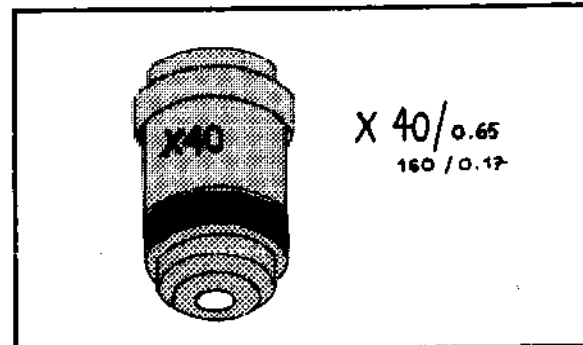

(d) Working distance of an objective

This is the distance between the front lens of the objective and the object slide when the image is in focus.

The greater the magnifying power of the objective, the smaller the working distance.

- x 10 objective: the working distance is 5-6 mm
- x 40 objective: the working distance is 0.5-1.5 mm
- x 100 objective: the working distance is 0.15-0.20 mm

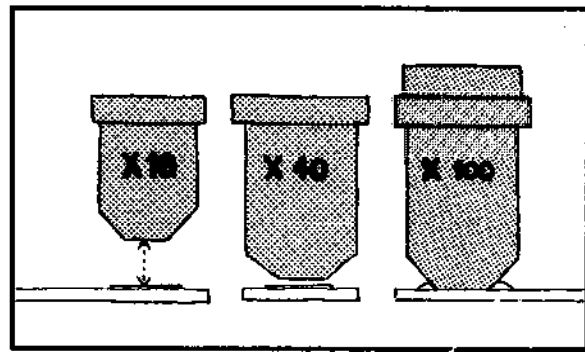

(e) Resolving power

The greater the resolving power of the objective, the clearer the image and the greater the ability to reveal closely adjacent details as separate and distinct.

The maximum resolving power of a good medical laboratory microscope is about $0.25 \mu\text{m}$ (the resolving power of the normal human eye is 0.25 mm).

Immersion oil increases the resolving power by conserving many light rays that would be lost by refraction if a dry objective were used.

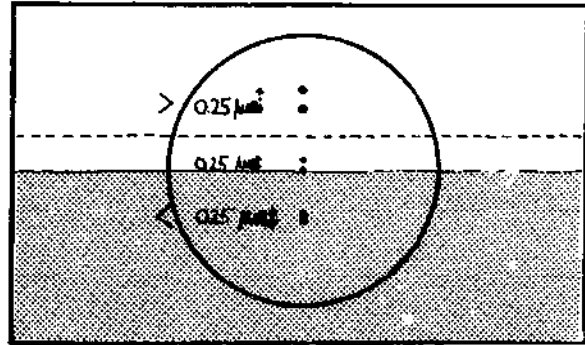

2. THE EYEPIECE

Magnification

The magnifying power of the eyepiece is marked on it:

- An x 4 eyepiece magnifies the image produced by the objective 4 times
- An x 6 eyepiece magnifies the image 6 times
- An x 10 eyepiece magnifies the image 10 times.

If the object is magnified 40 times by the x 40 objective, then 6 times by the x 6 eyepiece, the total magnification is $6 \times 40 = 240$.

To calculate the total magnification of the object observed, multiply the magnifying power of the objective by that of the eyepiece.

Microscopes used in medical laboratories have a magnifying power of between 50 and 1000.

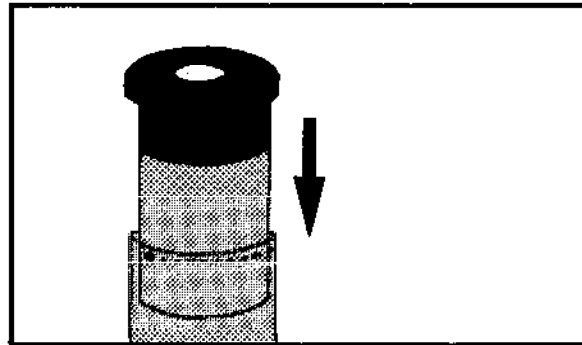

Monocular and binocular microscopes

Monocular microscopes (only one eyepiece) give better illumination and are recommended for use with x 100 oil-immersion objectives when the source of light is daylight.

Binocular microscopes (2 eyepieces but only using 1 objective at a time) are less fatiguing for the eyes when long examinations have to be made. Electric illumination is, however, essential for the x 100 objective.

C. The illumination system

1. The source of light

Electric light should preferably be used, since it is easier to adjust. It is provided by a lamp built into the microscope beneath the stage, or by an external lamp placed in front of the microscope.

Otherwise, daylight can be used. The microscope must never be used, and should never be stood, in direct sunlight. It should be well illuminated but used in a subdued light. If there is bright sunlight a bottle or a round flask of clear glass and full of water can be placed in front of the microscope to reduce the intensity of the light.

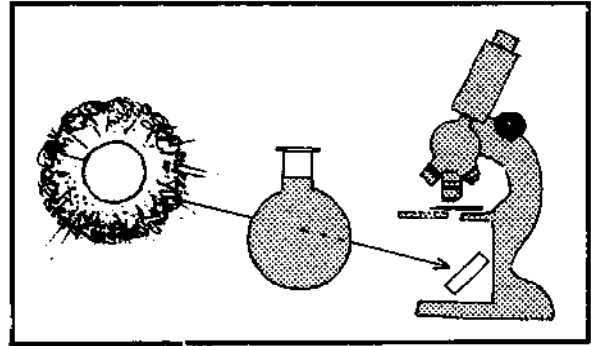

2. The mirror

The mirror reflects rays from the light source on to the object. One side has a plane surface, the other a concave surface. The concave side forms a low-power condenser and is not intended to be used if there is already a condenser.

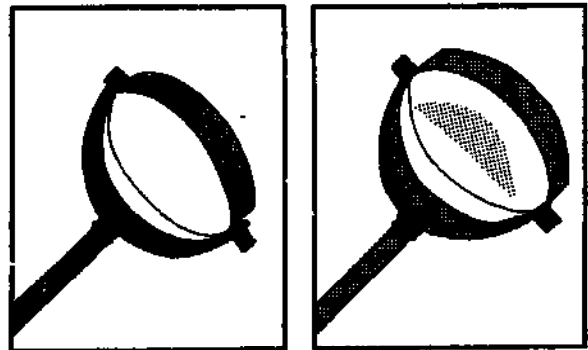

3. The condenser

The condenser brings the rays of light to a common focus on the object to be examined.

It is situated between the mirror and the stage. It can be raised (maximum illumination) and lowered (minimum illumination). It must be centred and adjusted correctly.

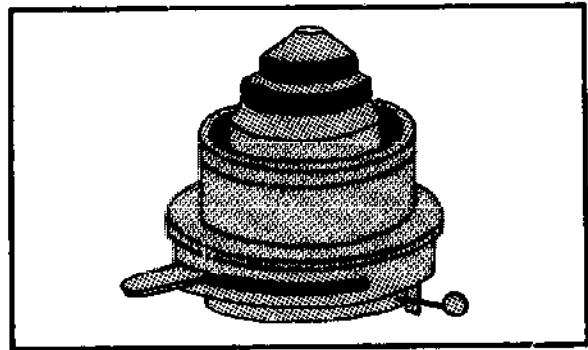

4. The diaphragm

The diaphragm, which is within the condenser, is used to reduce or increase the angle and therefore also the amount of light that passes into the condenser.

The wider the diaphragm the wider the angle and consequently the greater the NA and the smaller the detail seen. But the contrast is correspondingly less.

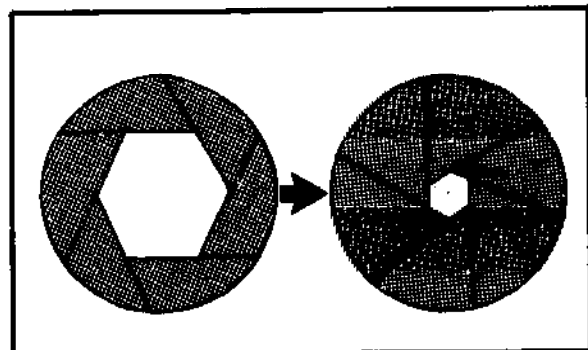

5. Filters

In some microscopes coloured filters (particularly blue filters) are fitted below the condenser. These can be left in place or removed according to the type of preparation being examined.

D. The adjustment system

The system comprises:

1. *The coarse adjustment screw*
This is the largest screw. It is used first to achieve an approximate focus.
2. *The fine adjustment screw*
This moves the objective more slowly. It is used to bring the object into perfect focus.
3. *The condenser adjustment screw*
This is used to raise the condenser for greater illumination or to lower it to reduce the illumination.
4. *Condenser centring screws*
There may be 3 screws placed around the condenser: one in front, one on the left and one on the right. They are used to centre the condenser exactly in relation to the objective.
5. *The iris diaphragm lever*
This is a small lever fixed on the condenser. It can be moved to close or open the diaphragm, thus reducing or increasing both the angle and the intensity of the light.

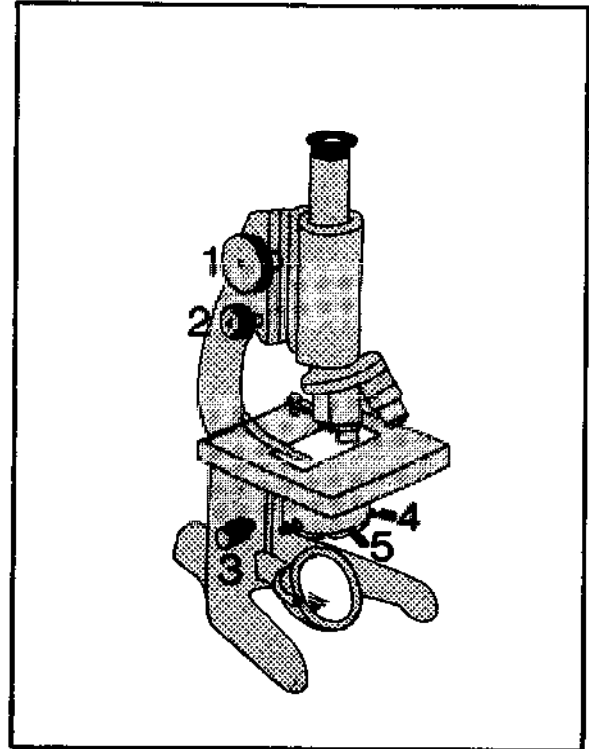

6. Mechanical stage controls

These are used to move the object slide on the stage:
1 screw to move it backwards and forwards
1 screw to move it to left or right.

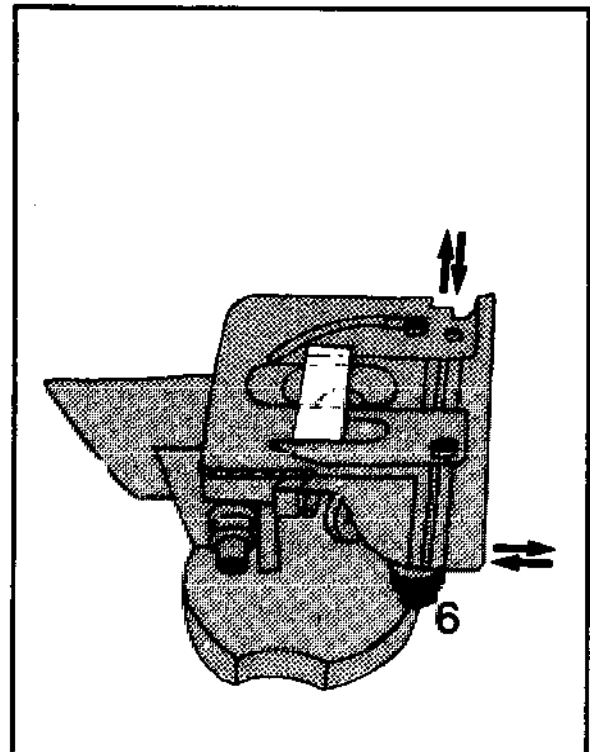

II. SETTING UP THE MICROSCOPE

When a new microscope is received in the laboratory, it is important to know how to set it up.

1. *Position of microscope*

Place it on a firm level bench (check with a spirit level) of adequate size but not too high. If electric illumination is to be used the microscope must be placed in the shade, away from the window. Place a square felt pad under the microscope. If no felt is available, use a piece of heavy cloth.

2. *Fitting the accessories*

- Screw the objectives into the revolving nosepiece, following this order in a clockwise direction:
 - (x 3 or x 5 objective)
 - x 10 objective
 - x 40 objective
 - x 100 (oil-immersion) objective.

The screw threads are standard.

- Put the eyepiece(s) in place.
- Fix the condenser under the stage.
- Fix the mirror on the foot.

3. *Positioning the lamp*

If electric illumination is to be used, place the lamp 20 cm in front of the microscope facing the mirror, which should be fixed at an angle of 45° . Place a piece of paper over the mirror. Adjust the position of the lamp so that it shines on the centre of the mirror.

If the lamp is fitted with a lens, the filaments in the bulb are projected on to the piece of paper covering the mirror. This makes it possible to centre the beam more precisely. In some models the bulb is turned until a clear image of the filament is obtained.

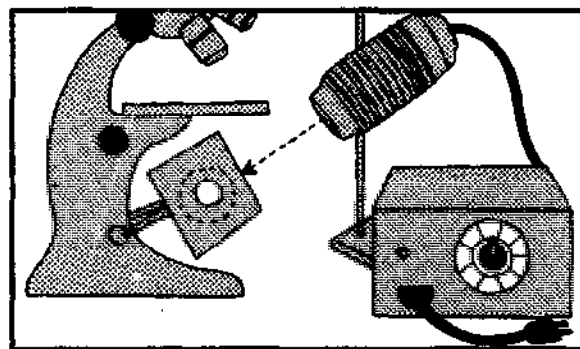

4. *Preliminary adjustment of the mirror*

Use the plane side of the mirror. Remove any coloured filters. Open the iris diaphragm to the maximum. Raise the condenser. Place a piece of thin white paper over the lens at the top of the condenser. This piece of paper should show an image of the electric bulb, surrounded by a circle of light.

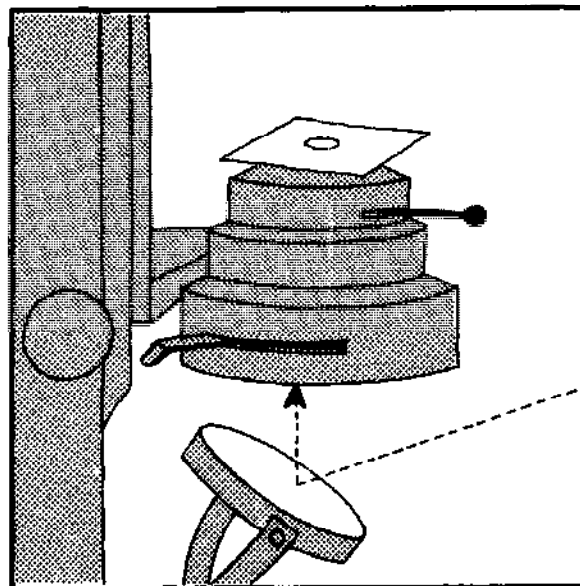

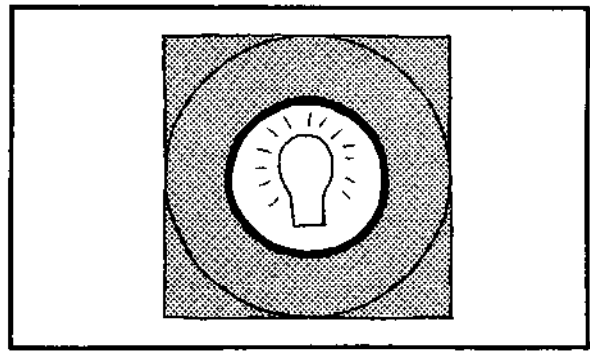

Adjust the mirror so that the image of the bulb is in the exact centre of the circle of light (or the brightest part if daylight is being used).

5. Centring the condenser (if centring is provided for)

It is very important to centre the condenser correctly. This is quite frequently overlooked.

- (a) Place a slide preparation without a coverglass on the stage. Lower the condenser. Open the iris diaphragm. Examine with the lowest power objective ($\times 3$, $\times 5$ or $\times 10$). Look through the eyepiece and bring into focus.
-

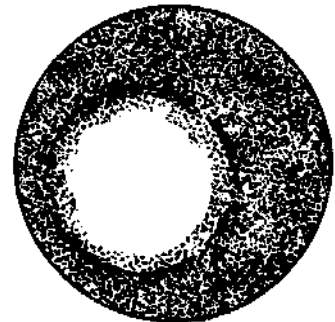

- (b) Close the diaphragm. A blurred circle of light surrounded by a dark ring appears in the field.
-

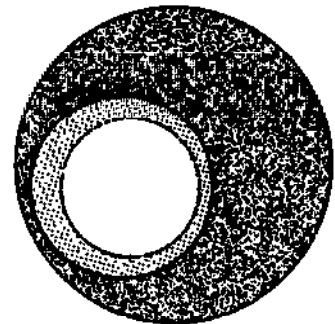

- (c) Raise the condenser slowly until the edges of the circle of light are in sharp focus.
-

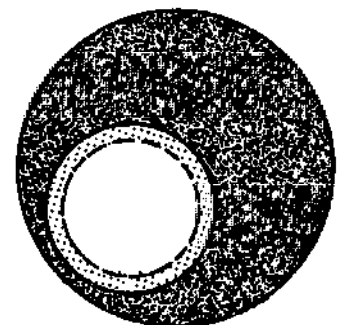

- (d) Adjust the position of the mirror (if necessary) so that the circle of light is in the exact centre of or superimposed upon the bright area surrounded by the dark zone.

- (e) Using the centring screws of the condenser, adjust so that the circle of light is in the exact centre of the field. Check for other objectives also.

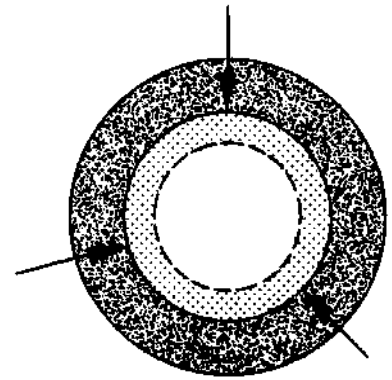

6. Adjustment of diaphragm

Open the diaphragm completely. Remove the eyepiece and look down the tube: the upper lens of the objective will be seen to be filled with a circle of light. Close the diaphragm slowly until the circle of light takes up only 2/3 of the surface. Do this for each objective as it is used.

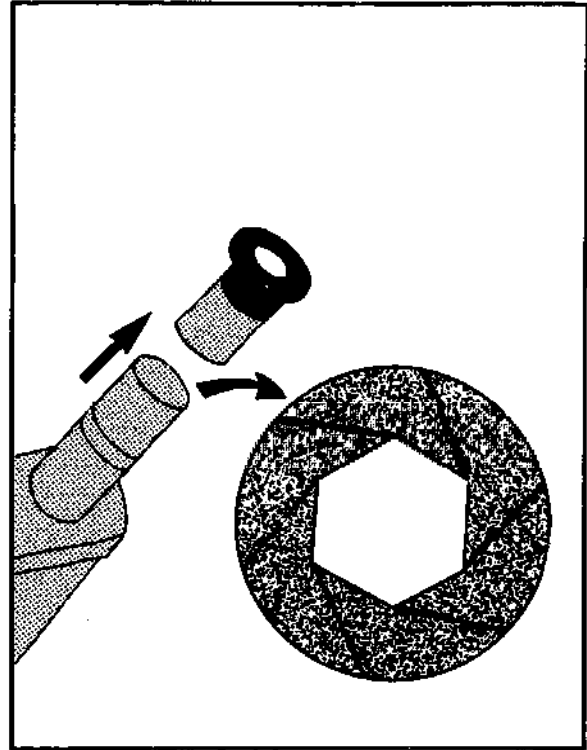

7. Adjustment of eyepieces

Selection of eyepiece

The x 5 or x 6 eyepieces give good results for the medical laboratory. With a high-power eyepiece there will be increased magnification but perhaps no great increase in detail. The eyepiece to use is a matter of choice.

Binocular adjustment

In binocular microscopes the interpupillary distance (the distance between the pupils of the eyes) can be adjusted to suit the operator.

Focusing the right and left eyes

One of the eyepiece holders (usually the left) has a focusing collar. If the collar is on the left eyepiece holder, close your left eye and, using the x 40 objective, bring the image into focus for your right eye with the right eyepiece.

Then close your right eye and look through the left eyepiece. If the image is in focus, no adjustment is needed. If the image is not clear, turn the focusing collar until it is in focus. The microscope is now adjusted to suit your own binocular vision.

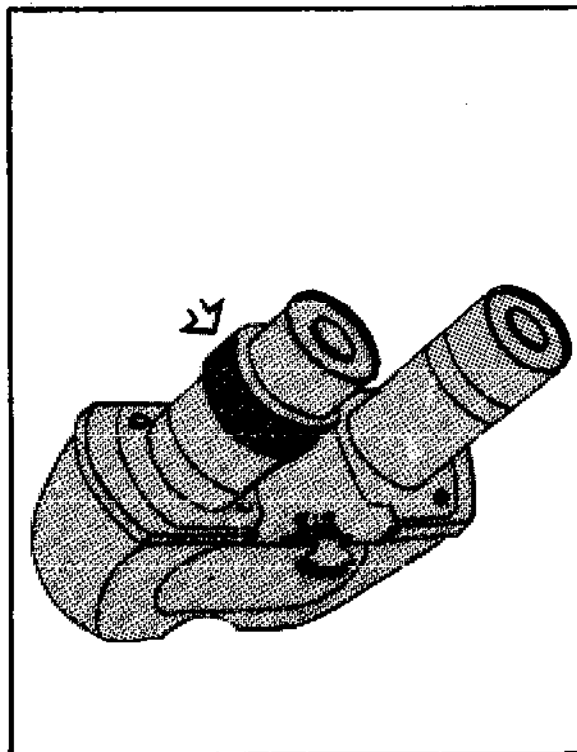

III. FOCUSING THE OBJECT

1. *Using a low-power objective (x 5 or x 10)*

Rack the condenser down to the bottom.

Lower the objective until it is just above the slide preparation.

Raise the objective, using the coarse adjustment screw, until a clear image is seen in the eyepiece.

Occasionally a clear image cannot be obtained although the objective has been lowered as far as possible. This is because the fine adjustment screw has been turned right to the end. Turn it back as far as it will go in the other direction and then focus by raising the objective.

Rack the condenser up slightly if there is insufficient illumination.

2. *Using a high-power objective (x 40)*

Rack the condenser half-way down.

Lower the objective until it is just above the slide preparation (the working distance is very short – about 0.5 mm).

Using the coarse adjustment, *raise* the objective very slowly until a blurred image appears on the field.

Bring into focus using the fine adjustment. Raise the condenser to obtain sufficient illumination.

If the microscope has no condenser, use the concave side of the mirror.

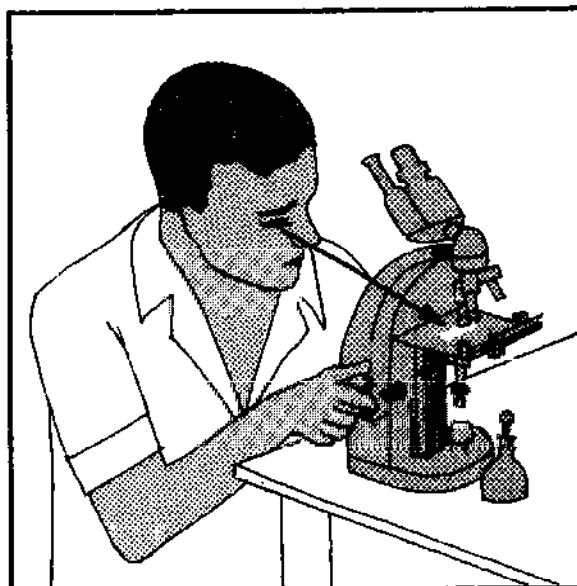

3. Using the oil-immersion objective (x 100)

Perfectly dry stained preparations must be used.

Place a tiny drop of immersion oil on the part to be examined (use synthetic oils, which do not dry, in preference to cedarwood oil, which dries quickly).

Rack the condenser up as far as it will go, and open the iris diaphragm fully. Lower the x 100 objective until it is in contact with the oil. Bring it as close as possible to the slide, but avoid pressing on the preparation (modern objectives are fitted with a damper).

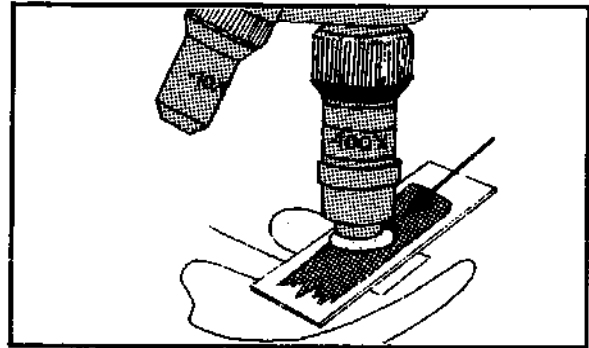

Look through the eyepiece and turn the fine adjustment very slowly upwards until the image is in focus.

If the illumination is inadequate, use the concave side of the mirror as recommended for the x 40 objective.

Important: In most microscopes now it is not the objective holder but the stage that is moved up or down by the coarse and fine adjustment screws. In this case the screws must be turned in the opposite direction to bring the image into focus.

Depth of the field

The image is seen in depth when a low-power objective is used. The depth of focus is small and the impression of depth intensified when higher-power objectives (x 40, x 100) are used, and the fine adjustment must be used to examine every detail from the top to the bottom levels of focus of the object observed (e.g., the different nuclei in a spherical amoeba cyst).

4. Images seen under the microscope

Remember that the circle of light seen in the eyepiece is called "the microscopic field".

How to establish the position of objects seen

Objects observed in the field can be placed in relation to the hands of a clock.

For example, a schistosome egg is placed at "2 o'clock" in the illustration.

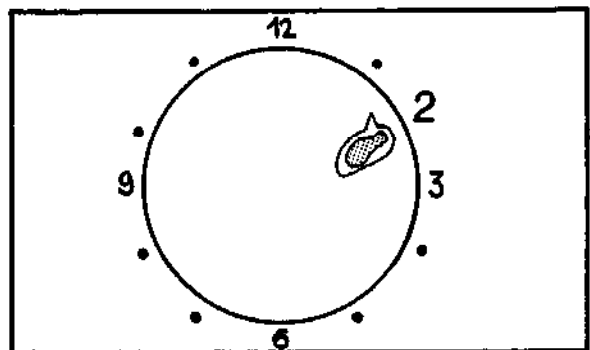

Inversion of images

The image seen is inverted by the lenses:

- objects seen at the bottom of the field are actually at the top
- objects seen on the left hand side of the field are actually on the right.

Moving the object

If you move the slide to the right, the object examined moves to the left.
If you move the slide towards you, the object examined moves away from you.

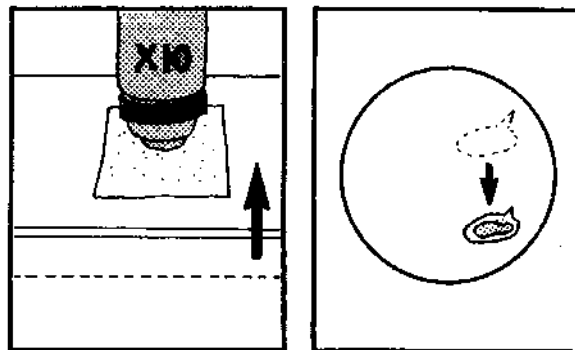

Changing objectives

Modern microscopes are made so that when you change from a low-power objective to a more powerful one to examine the same object, the object remains more or less in focus. If this is not the case, raise the nosepiece before changing to the more powerful objective and refocus.

Before changing objectives, make sure that the object examined is in the middle of the field, so that it is not lost after the change.

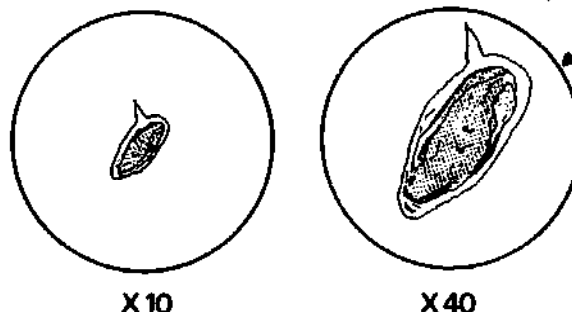

IV. ROUTINE MAINTENANCE OF THE MICROSCOPE

The microscope needs daily attention to keep it in good working order and thus to ensure reliable laboratory results. Special care is required in hot and humid climates.

1. *Equipment*

1. Pieces of old cloth and a fine soft linen handkerchief, already washed
2. Special lens tissue paper or, if unavailable, white absorbent paper (toilet paper)
3. A piece of chamois leather, if possible (otherwise a non-fluffy rag)
4. A little bottle of xylene (or toluene)
5. A plastic cover
6. A small rubber bulb and, if possible, a fine paintbrush (or a special brush for cleaning lenses)
7. In hot, humid climates -
Laboratories with electricity:
- a warm cupboard heated by 1 or 2 light bulbs (40-watt)
Laboratories without electricity:
- if possible, a desiccator 15-20 cm in diameter with not less than 250 g of dry blue silica gel (which indicates humidity by turning pink).

2. *Cleaning the objectives*

Dry objectives

Breathe on the lens and wipe with a soft cloth, moving the cloth across and not circularly.

Oil-immersion objectives

Remove the oil with lens paper or absorbent paper. If there are traces of old immersion oil or if cedarwood oil has been used, moisten the paper *very slightly* with xylene or toluene, then wipe again with dry paper. Every evening before putting the microscope away, remove any dust on the objectives by puffing air with the rubber bulb. If necessary, remove any remaining dust using the fine paintbrush.

3. *Cleaning the eyepieces*

- Clean the upper surface of the upper lens (where you apply your eye) with a soft cloth or tissue paper
- Clean the lower surface of the lower lens, inside the microscope tube, with the fine paintbrush
- If there is dust inside the eyepiece, unscrew the upper lens and clean the inside lenses using only air from the rubber bulb and the fine paintbrush.

4. *Cleaning the condenser and mirror*

The condenser is cleaned in the same way as the objectives, with a soft cloth or tissue moistened with xylene. The mirror is cleaned with a soft cloth moistened with alcohol.

5. *Cleaning the support and stage*

Clean with chamois leather or a soft non-fluffy cloth.

Never use xylene, which may remove the black paint from the microscope.

The stage can be cleaned thoroughly using absorbent paper impregnated with petroleum jelly.

V. ADDITIONAL PRECAUTIONS TO BE TAKEN IN HOT CLIMATES

A. Hot humid climates

In hot humid climates, if no precautions are taken, fungus may develop on the microscope, particularly on the surface of the lenses, in the grooves of the screws and under the paint, and the instrument will soon be useless. This can be prevented as described below.

1. *Laboratories with electricity*

Every evening place the microscope in a warm cupboard. This is simply a cupboard with a tight-fitting door, heated by one or two 40-watt light bulbs (for a cupboard just big enough to take 1 - 4 microscopes one bulb is enough). The bulb is left on continuously, even when the microscope is not in the cupboard.

Check that the temperature inside the cupboard is at least 5° warmer than that of the laboratory.

For example:

- temperature of laboratory: 26 °C
- temperature inside cupboard: 32 °C.

Important: the microscopes must be kept in the warm cupboard even if the laboratory is air-conditioned.

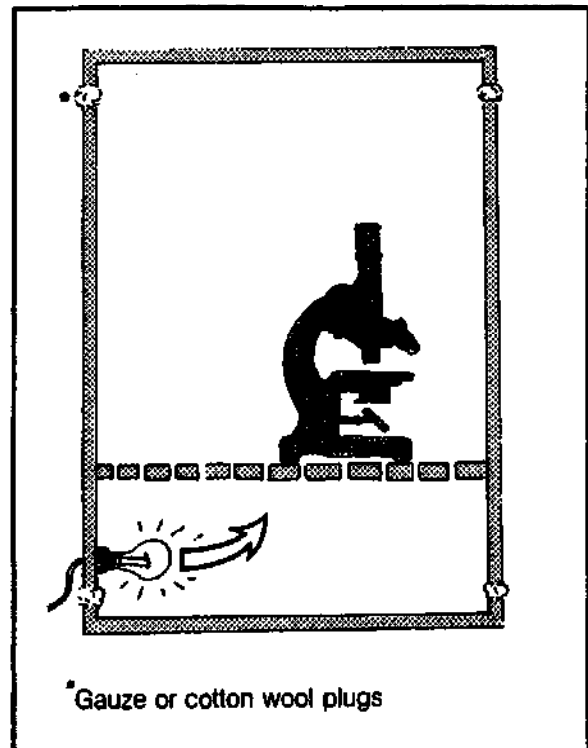

2. Laboratories without electricity

The microscope can always be kept *in the open air*, in the shade but near a sunny spot. Never put the microscope in its wooden box (even overnight) but always use a cover. The microscope must, however, be cleaned daily to get rid of dust.

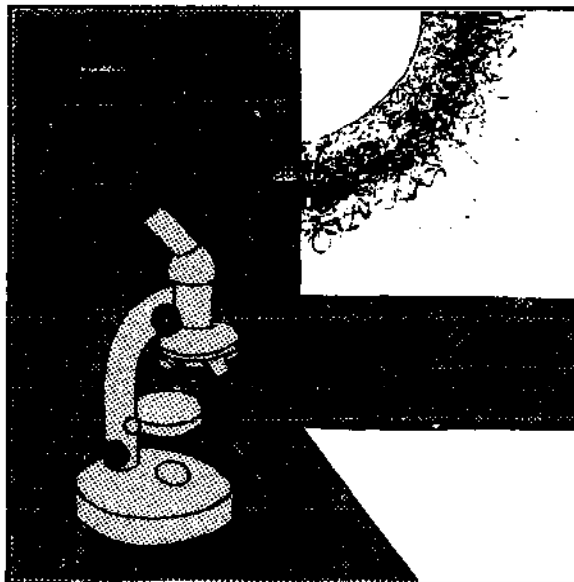

Ideally, the laboratory should be visited every 3 months by a specialist, who takes the microscope to pieces and:

- inspects the surfaces of the lenses and the prism for the first signs of fungus
- lubricates the metal parts with a special liquid oil that has cleaning properties.

B. Hot dry climates

In hot dry countries the main problem is dust (sandstorms, etc.). Fine particles work their way into the threads of the screws and under the lenses. This can be avoided as follows:

1. Always keep the microscope under a airtight plastic cover when not in use. Put it away in its wooden box every evening.
2. At the end of the day's work, clean the microscope thoroughly by blowing air on it from a rubber bulb.
3. Finish cleaning the lenses with a lens brush or fine paintbrush. If dust particles remain on the surface of the objectives, remove with lens paper.
4. If there is a wet season lasting more than a month, take the precautions recommended above for hot humid climates.

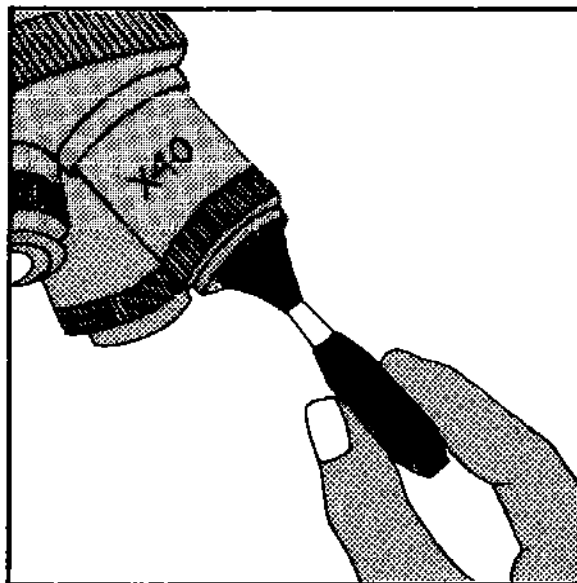

SOME THINGS NOT TO DO

1. Never clean the lenses of the objectives and eyepieces with ethanol.
 2. Never dip the objectives in xylene or ethanol (the lenses would become unstuck).
 3. Never use ordinary paper or cotton wool to clean the lenses.
 4. Never touch the objectives with your fingers.
 5. Never clean the supports or the stage with xylene.
 6. Never clean the *inside* lenses of the eyepieces and objectives with cloth or paper (this might remove the anti-reflecting coating); use a fine paintbrush only.
 7. Never leave the microscope without the eyepieces unless the openings are plugged.
 8. Never keep the microscope in a closed wooden box in hot humid countries.
 9. Never put the microscope away with immersion oil on the objective.
 10. Never carry the microscope by the limb with one hand: use both hands, one under the foot, the other holding the limb.
-









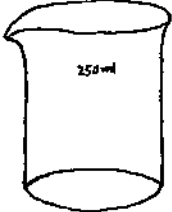
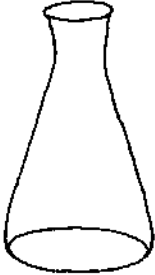
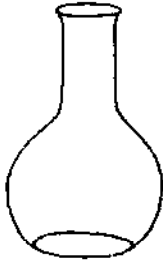
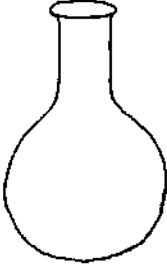

THE McARTHUR MICROSCOPE

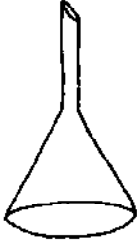
The McArthur microscope is an instrument that, while capable of the highest magnifications and a number of unusual forms of work, is no larger than a miniature camera, weighs less than half a kilogram, and can be used in the hand.

It is used in tropical medicine for the examination of blood films and dissections of mosquitos for malaria in rural surveys; of blood films and the cerebrospinal fluid for carriers of sleeping sickness; of urine and stools for eggs, and of sputum in tuberculosis surveys, and also for the dissection of snails in schistosomiasis and the rapid diagnosis of cholera (which can be done within seconds and with no adjustment whatever).

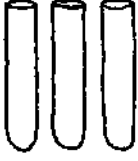
The instrument has automatic focusing and gives a direct instead of an inverted image, is extremely rugged, and has a wide range of accessories, including equipment for immersion, dark-ground illumination and phase contrast. It can be used for the examination of sediments in considerable volumes of fluid, in blood counts and in a variety of other operations in rural surveys in circumstances in which no other microscope can be used.

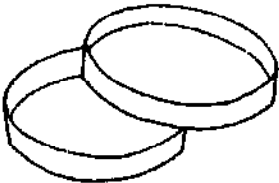
2. Laboratory Glassware and Small Apparatus

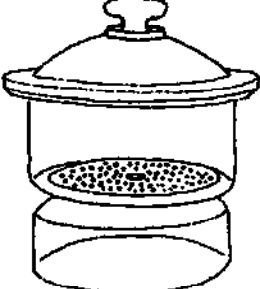
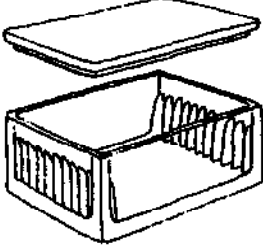
			
Beaker	Erlenmeyer flask	Flat-bottomed round flask (Florence flask)	Round-bottomed flask
			
Conical testing glass	Filter funnel	Evaporating dish	Watch glass
			
Test tube	Kahn or precipitin tubes	Round-bottomed centrifuge tube	Conical centrifuge tube
			
Petri dish	Crystallizing dish	Desiccator	Staining trough

Glassware for measuring volume (pipettes, measuring cylinders, volumetric flasks, etc.):
See following sections.

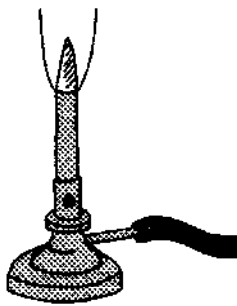

Bunsen burner
(hot flame)

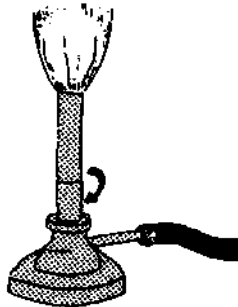

Bunsen burner
(light flame)

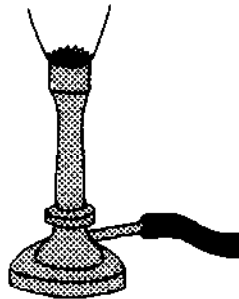

Meker burner



Asbestos gauze
Tripod

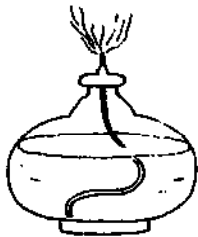

Spirit lamp

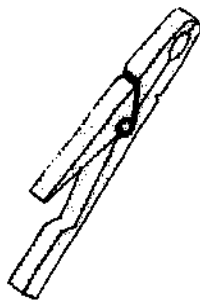

Wooden test
tube holder

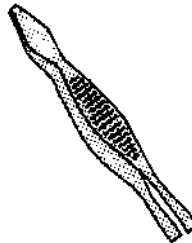

Slide
forceps

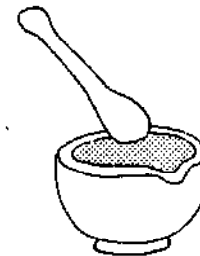

Pestle
Mortar

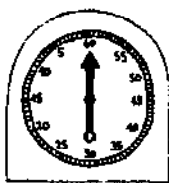

Timer

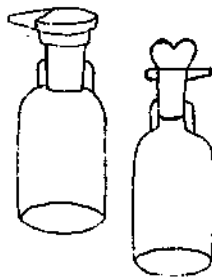

Drop bottles

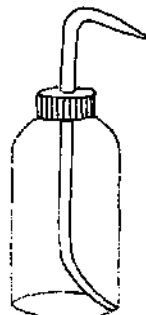

Wash bottle

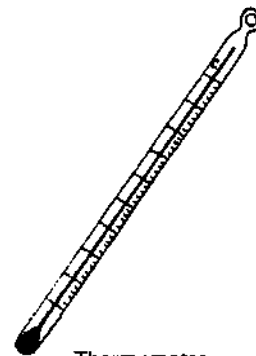

Thermometer

3. Cleaning Glassware

PROCEDURES FOR CLEANING

1. Glass containers (Erlenmeyer flasks, beakers, tubes)
 2. Pipettes
 3. Microscope slides
 4. Small apparatus (syringes, needles, etc.)
-

I. GLASS CONTAINERS

A. New glassware

Glassware that has never been used is slightly alkaline. In order to neutralize it:

- prepare a basin containing 3 litres of water and 60 ml of concentrated hydrochloric acid (i.e., a 2% solution of acid)
 - leave the new glassware completely immersed in this solution for 24 hours
 - rinse twice with ordinary water and once with demineralized water
 - dry.
-

B. Dirty glassware

1. *Disposal of specimen containers (see page 40)*
2. *Preliminary rinsing*

Rinse twice in cold or lukewarm water (never rinse bloodstained tubes in hot water). Glassware that has been used for fluids containing protein fluids must never be allowed to dry before first being rinsed and then washed.

3. *Soaking in detergent solution*

Prepare a bowl of water mixed with washing powder or liquid detergent. Put the glassware in the bowl and brush the inside of the containers with a test-tube brush. Leave to soak for 2–3 hours.

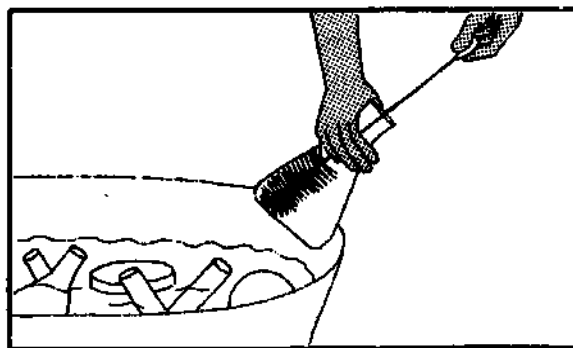

4. *Rinsing*

Remove the articles one by one. Rinse each one thoroughly under the tap, then soak them all in a bowl of ordinary water for 30 minutes. Rinse each article in a stream of clean water. (Do not forget that traces of detergent left on glassware can lead to false laboratory results.)

5. *Draining*

Place containers (beakers, flasks, measuring cylinders) on the pegs of a wall draining rack. Place tubes upside down in a wire basket.

6. *Drying*

Place in wire baskets and dry in the hot air oven at 60 °C. Otherwise, place the baskets in a sunny spot in the laboratory and cover with a fine cloth.

7. *Plugging*

The clean dry glassware should be put away in a cupboard to protect it from dust. It is recommended that containers should be plugged with non-absorbent cotton wool or the mouths covered with little caps made from newspaper or, preferably, thin sheeting of paraffin wax or clinging plastic (e.g., Parafilm or Saran), if available.

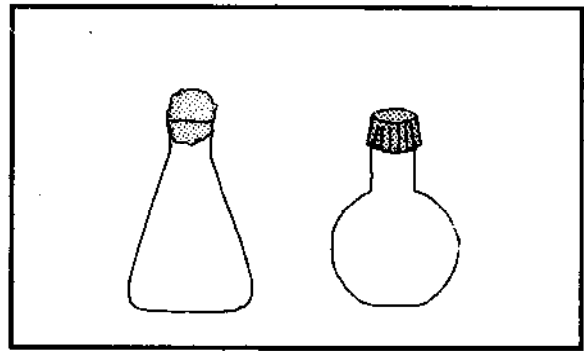

II. PIPETTES

1. *Immediate rinsing*

As soon as a pipette has been used, it must be rinsed at once in a stream of cold water to remove blood, urine, serum, reagents, etc.

2. *Soaking in water*

After rinsing, place the pipettes in a large, plastic measuring cylinder (or bowl) full of water. If the pipettes have been used to measure infected material, leave them in a cylinder full of disinfectant solution (a quaternary ammonium compound or 2% phenol) for 24 hours.

3. *Soaking in detergent and rinsing*

Follow the instructions given above for laboratory glassware.

4. *Blocked pipettes*

- Put them in a cylinder filled with dichromate cleaning solution (reagent No. 16). Slide them carefully into the solution and leave for 24 hours.
- The next day, pour the dichromate solution into another cylinder (it can be used 4 times).
- Hold the cylinder containing the pipettes under the tap and rinse thoroughly.
- Remove the pipettes one at a time. Check that the obstruction has been washed away. Rinse again.
- Leave to soak in ordinary water for 30 minutes, then repeat in clean water for 30 minutes.

Warning: The dichromate solution is highly corrosive and should be used with extreme care. If accidentally spilled on skin, eye or clothing, wash at once with copious amounts of water.

5. *Drying*

Dry Pyrex pipettes in the hot air oven at 60 °C and ordinary pipettes in the incubator at 37 °C or in the air.

6. *Using the vacuum pump*

This is a small metal or glass (fragile) instrument that is attached to the tap.

- Turn the water on hard to drive a strong jet through the pump. This causes air to be sucked into the side arm of the pump and the rubber tubing attached to it.
- Fit this rubber tubing over the tip of the pipette.
- Dip the other end of the pipette into the rinsing liquid, which is sucked through the pipette and discharged by the pump into the sink.

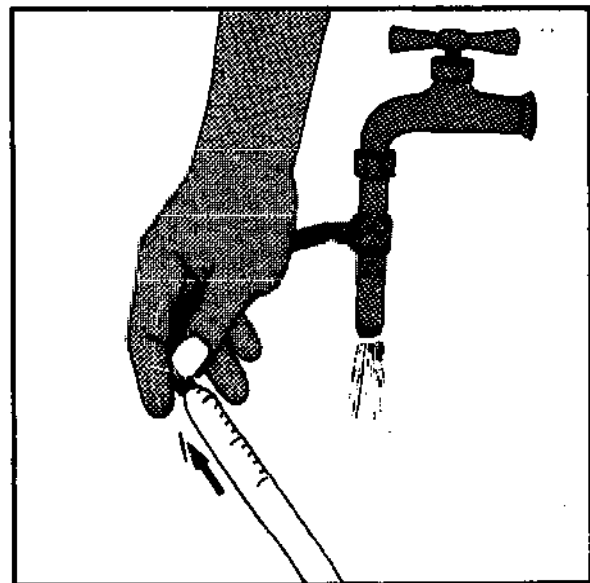

III. MICROSCOPE SLIDES

A. New slides

1. Soaking in detergent solution

Prepare a bowl of water with washing powder or liquid detergent using the amount of detergent recommended by the manufacturer. Place the slides in the bowl one by one and leave to soak overnight.

2. Rinsing in water

Rinse each slide with tapwater and then soak in clean water for 15 minutes.

3. Wiping and drying

Wipe the slides, one at a time, with a soft, non-fluffy cloth. Place them on a sheet of filter paper, one by one. Leave to dry. Examine each slide. Reject slides that are stained, scratched or yellow and those that have dull patches on them.

4. Wrapping up

Divide the slides into piles of 10 or 20 and wrap in small sheets of paper.

5. Numbering

In some laboratories the slides in a series of 5 packets are numbered in advance from 1 to 100 with a diamond pencil (thus the packets contain slides 1-20, 21-40, 41-60, 61-80 and 81-100 respectively).

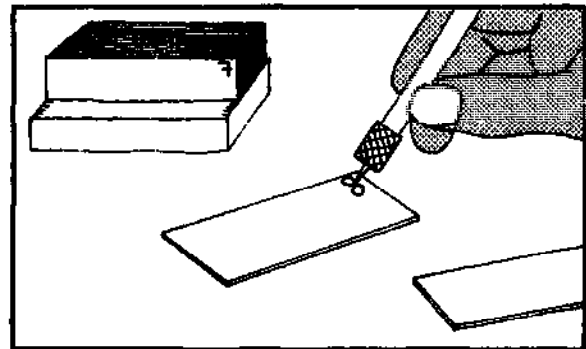

B. Dirty slides

1. Slides soiled with immersion oil

Take the slides one by one and rub them with newspaper to remove as much of the oil as possible.

2. Slides with coverslips

Using the tip of a needle or forceps, detach the coverslips and drop them into a beaker of water (for cleaning of coverslips, see page 32).

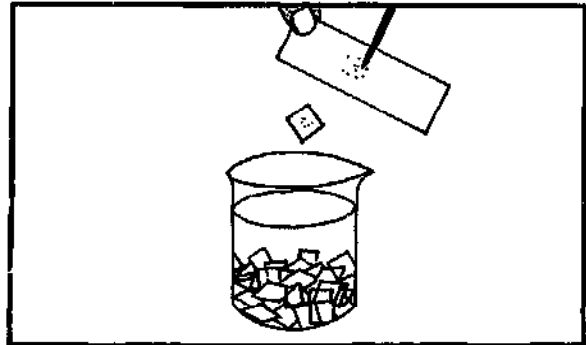

3. Soaking in concentrated detergent solution

Prepare a bowl containing:

- cold or lukewarm water
 - detergent (in the amount recommended by the manufacturer).
- Leave to soak for 24 hours.

Detergents containing enzymes are excellent for removing blood films.

Note: When slides have been used for infected specimens (urine, stools), they should be placed in a disinfectant solution.

4. *Cleaning slides*

Prepare another bowl containing a weak detergent solution (15 ml of domestic detergent per litre of water). Take the slides one by one out of the strong detergent solution. Rub each one with cotton wool dipped in the strong solution, then drop it into the bowl of weak detergent. Leave to soak for 1 or 2 hours in the bowl of weak detergent.

5. *Rinsing slides*

Take the slides out one by one, preferably using forceps. If you use your fingers, pick them up by the edges. Rinse them separately under the tap, then soak them for 30 minutes in a bowl of water. This is the best method.

Quick method

Empty the bowl of weak detergent solution and fill with clean water. Change the water 3 times, shaking the bowl vigorously each time.

6. *Wiping, drying and wrapping up*

Follow the instructions given above for new slides.

C. Coverslips

Coverslips can be recovered after use, cleaned and used again. For cleaning:

1. Soak in a weak detergent solution with added disinfectant made up in a large beaker as follows:
 - 200 ml of water
 - 3 ml of detergent
 - 15 ml of bleach or 5 ml of a quaternary ammonium disinfectant.

Leave to soak for 2-3 hours, shaking gently from time to time.

2. Rinse out the beaker with tap water 4 times, shaking gently.
3. Give a final rinse with demineralized water.
4. Drain the coverslips by tipping them out carefully on to a pad of gauze.
5. Dry in the hot air oven at 60 °C, if possible.
6. Keep them in a small Petri dish. When taking them out, use special coverslip forceps, if possible.

IV. SYRINGES AND NEEDLES

As soon as a sample has been collected, remove the plunger and rinse the barrel and plunger. Fill the barrel and insert the plunger; force the water through the needle. Finally remove the needle and rinse the hub cavity.

1. *Syringe with blocked piston*

To loosen the piston, several methods may be used:

- (a) Soak for 2 hours in hot water (about 70°C).
- (b) Alternatively, pipette 50% acetic acid into the nozzle of the syringe with a fine Pasteur pipette. Stand the syringe on its end, piston down. Leave for 10 minutes.
- (c) Soak the syringe for several hours in a bowl of 10-voi. hydrogen peroxide.

2. *Rinsing and soaking needles*

As soon as the needle has been used, rinse it while it is still attached to the syringe and leave it to soak in the same way as the syringe.

3. *Blocked needles*

Use a nylon thread dipped in 50% acetic acid. Otherwise use a stylet.

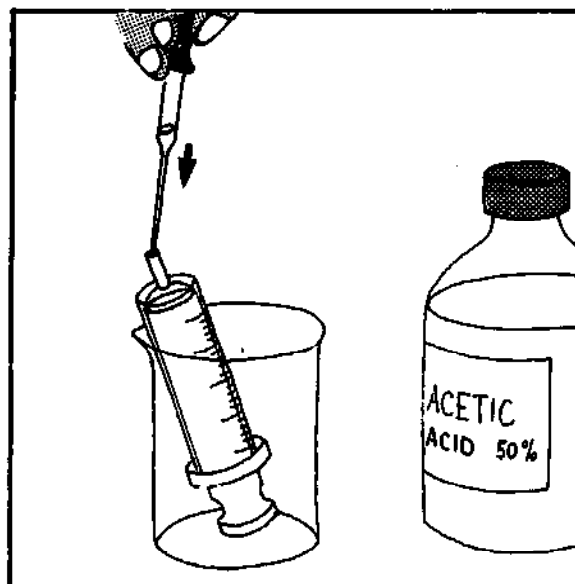

4. Sterilization

Sterilization means the freeing of any object or substance from all life of any kind. The equipment treated then becomes free from living micro-organisms.

In the medical laboratory materials are sterilized for 3 main purposes:

1. In preparation for taking specimens (needles, syringes, tubes, etc. must be sterile)
2. To disinfect contaminated materials
3. To prepare the apparatus used for bacteriological cultures (Petri dishes, Pasteur pipettes, tubes, etc.).

Sterilization is achieved in the medical laboratory either by moist heat (autoclave, boiling) or by dry heat (hot air oven, flaming).

I. THE AUTOCLAVE

Principle

Water is heated in a closed container. This produces saturated steam under pressure, with a temperature of over 100 °C.

All types of organisms are killed when apparatus is heated for 20 minutes at 120 °C in this steam under pressure.

Components of the autoclave

1. **Boiler**
A large deep cylinder in which the apparatus to be sterilized is placed.
2. **Basket**
A big wire basket that holds the materials to be sterilized.
3. **Basket support**
A support in the bottom of the autoclave that holds the basket above the water level.
4. **Drainage tap**
A tap fitted at the base of the boiler that drains off excess water.
5. **Lid**
The lid covers and seals the boiler and is fitted with a rubber washer.
6. **Lid clamps**
These clamps, together with the rubber washer, seal the lid and prevent steam from escaping.
7. **Air outlet valve**
A valve at the top of the boiler or on the lid used to let air out when the water is first heated.
8. **Safety valve**
A valve at the top of the boiler or on the lid that lets steam escape if the pressure becomes too high and so prevents an explosion.
9. **Temperature gauge or pressure gauge**
A dial at the top of the boiler or on the lid that shows the pressure, the temperature, or both.

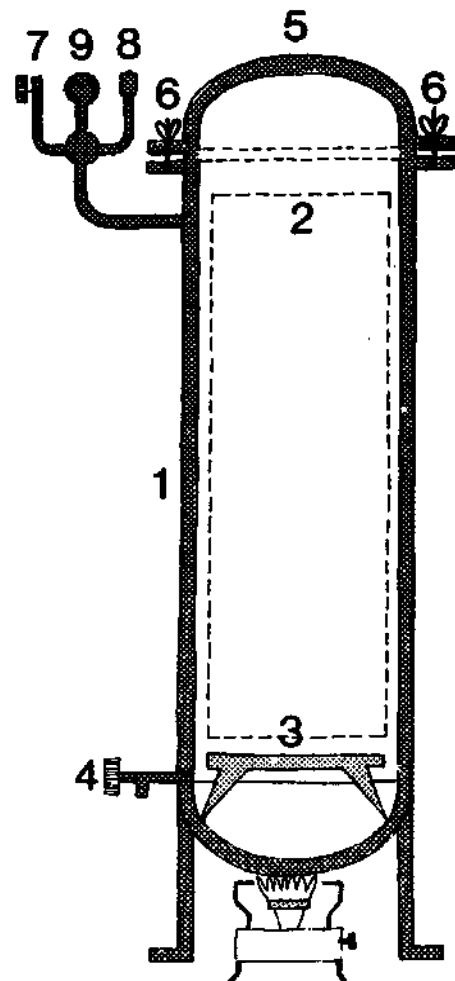

Graduations on the gauge

All gauges indicate the temperature in degrees Celsius ($^{\circ}\text{C}$); some also have a second set of figures indicating the pressure.

Heating the autoclave

The heating system may be built into the instrument in the form of:

- electric elements or
- gas burners.

Otherwise, the autoclave is heated over:

- a butane gas burner or
- a paraffin oil (Primus) stove.

How to use the autoclave

1. Preparation of material for sterilization

Syringes

These are placed in large glass tubes plugged with non-absorbent cotton wool (the pistons and barrels in separate tubes), or they are wrapped in gauze and placed in metal trays.

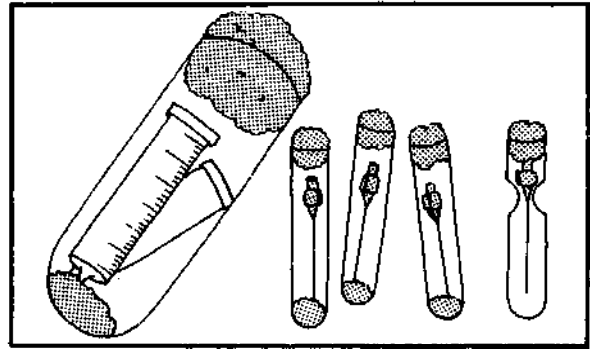

Needles

Needles should preferably be placed separately in small test-tubes that are then plugged. Place a pad of non-absorbent cotton wool at the bottom of each tube to protect the tip of the needle. Otherwise, arrange them in metal trays with the points stuck into a folded gauze pad.

The metal trays are placed uncovered in the autoclave.

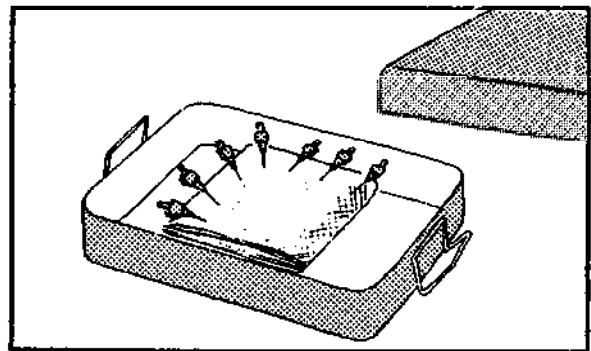

Glassware

Specimen tubes, Petri dishes, etc. Wrap in brown paper and tie with string.

Pasteur pipettes

These are placed in large tubes which are then plugged. Alternatively they may be wrapped in several layers of brown paper.

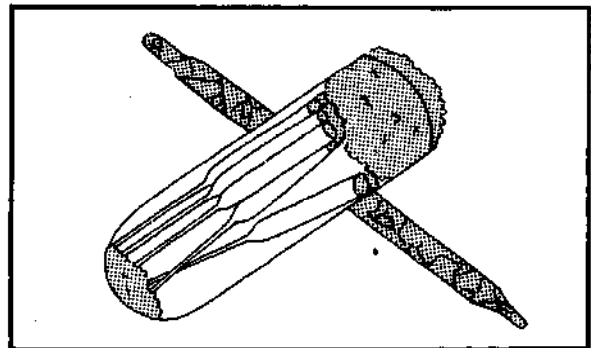

2. Sterilization procedure

- (a) Fill the bottom of the autoclave with water (up to the basket support).
Make sure that the water does not touch the basket. If necessary, drain off excess water by opening the drainage tap.
- (b) Put the basket containing the material to be sterilized in the autoclave.
(Sterilization indicators can be added, i.e., indicator papers that turn black when the right temperature is reached.)
- (c) Close the lid, making sure that the rubber washer is in its groove. Screw down the lid clamps evenly and firmly but not too tightly.
- (d) Open the air outlet valve.
- (e) Begin heating the autoclave.
- (f) Watch the air outlet valve until a jet of steam appears. Wait 3 or 4 minutes until the jet of steam is uniform and continuous. This shows that all the air has been driven out of the autoclave.
- (g) Then close the air outlet valve. Tighten the lid clamps and reduce the heat slightly.
- (h) Watch the gauge. When the desired temperature is reached (i.e., 120 °C), the heat must be regulated to maintain it. Reduce the heat until the needle on the dial remains at the temperature selected.
- (i) Start timing at this point:
 - Materials for collecting specimens (syringes, needles, tubes):
20 minutes at 120 °C.
 - Containers of infected material (sputum pot, tubes of pus):
30 minutes at 120 °C.
 - Bacteriological culture media:
follow the instructions of the bacteriologist or the chief laboratory technician.

3. Turning off the heat

- (a) Turn off the heat as soon as the required time is up.
- (b) When the temperature falls below 100 °C, open the air outlet valve to equalize the pressures inside and outside the autoclave.
- (c) When the hissing sound stops, unscrew the lid clamps. Take off the lid. Leave to cool, then carefully remove basket of sterile equipment. If drops of water have formed, dry in the incubator at 37 °C, if possible.

Some things not to do

1. Never touch the drainage tap or outlet valve while heating under pressure.
2. Never touch the safety valve while heating under pressure.
3. Never heat too quickly to bring up the pressure, once the outlet valve is closed.
4. Never leave the autoclave unattended while the pressure is rising.
5. Never leave the autoclave to cool for too long. If it is left for several hours without the outflow valve being opened, a vacuum forms and the sterilized material may break.

II. USING A PRESSURE COOKER

Pressure cookers are large saucepans designed to cook food very quickly, using steam under pressure. They are used in some small laboratories to sterilize specimen collection equipment.

Model with revolving valve

1. Fill the bottom of the cooker with water. Place the material to be sterilized in the basket held above the water level by a support. The wrapped articles should be placed upright (never lay them flat).

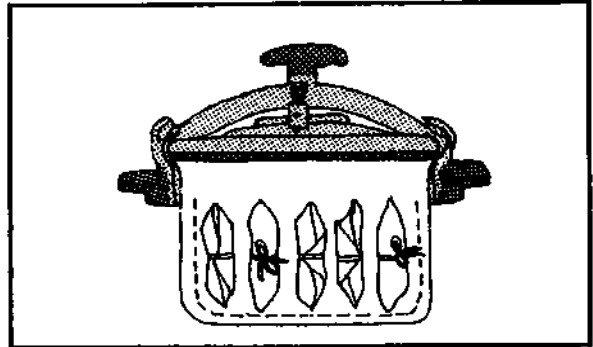

2. Fit on the lid. Screw it down with its knob. Place the revolving valve (V1) on its shaft in the lid.
3. Start heating on the stove. The valve soon begins to turn, letting a jet of steam escape.
4. Wait until the jet of steam is continuous, then lower the heat so that the valve keeps turning slowly. Leave on moderate heat for 20 minutes.
5. Turn off the heat. Leave to cool (or cool under the tap). Pull off the revolving valve so that air can enter. Remove the lid. Take out the sterilized material and leave to dry.
6. Never touch the safety valve (V2), which is fixed to the lid.

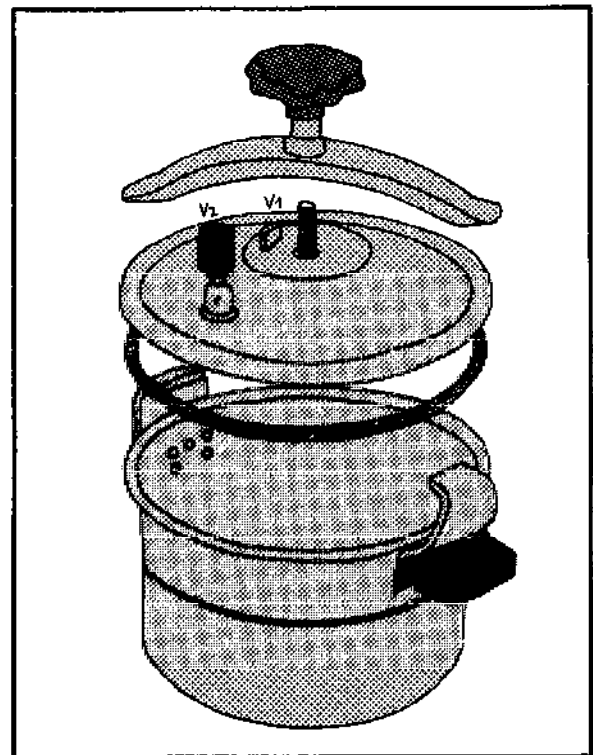

Model with fixed valve

1. Put the water and material to be sterilized in the cooker as described above.
2. Open the valve in the lid. Start heating.
3. As soon as a continuous jet of steam escapes from the valve, close the valve.
4. Wait until the valve begins to whistle. When it does, reduce the heat. Leave on moderate heat for 20 minutes.
5. Turn off the heat. Leave to cool (or cool under the tap).
6. Open the valve so that air can enter. Remove the sterilized material, etc.
7. Never touch the safety valve.

III. STERILIZATION BY BOILING

This method should be used only where there is no alternative. Use a special boiling pan or, if not available, a saucepan. Fill with water (preferably demineralized water). Heat over the stove.

Glassware (syringes) should be put in while the water is still cold.

Metal articles (needles, forceps) should be put in when the water is boiling.

Leave articles used for collecting specimens (needles, syringes) to boil for 20 minutes.

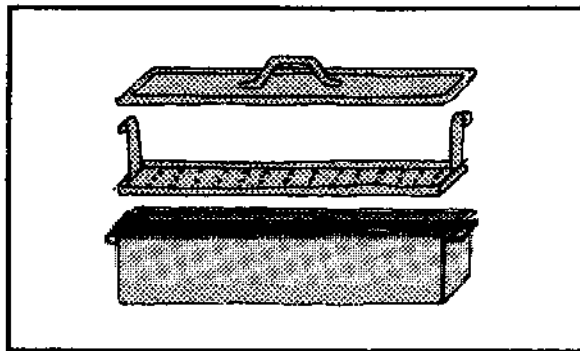

IV. STERILIZATION BY HOT AIR OVEN

This method of sterilizing by dry heat can be used only for glass or metal articles (syringes, needles, pipettes, etc).

1. Prepare the material to be sterilized in the same way as for the autoclave method. Cotton wool plugs should not be too thick, so that the air can penetrate. Raise the lids of the metal boxes slightly and arrange them so that they face the back of the oven.
2. Set the thermostat at 175 °C and switch on the oven. If there is a fan, check that it is working.
3. Watch the thermometer. When the temperature reaches 175 °C, continue heating for a further 60 minutes. If the material is heavy or bulky or if there are powders, oils, petroleum jelly, etc., heat at 175 °C for 2 hours.
4. Switch off the heat. Wait until the temperature falls to 40 °C. Open the oven door. Close the lids of the metal boxes. Remove the sterile material. *The wrapping paper used should have turned brown. If white wrapping paper turns pale yellow, the oven is not hot enough; if it is blackened, the oven is too hot.*

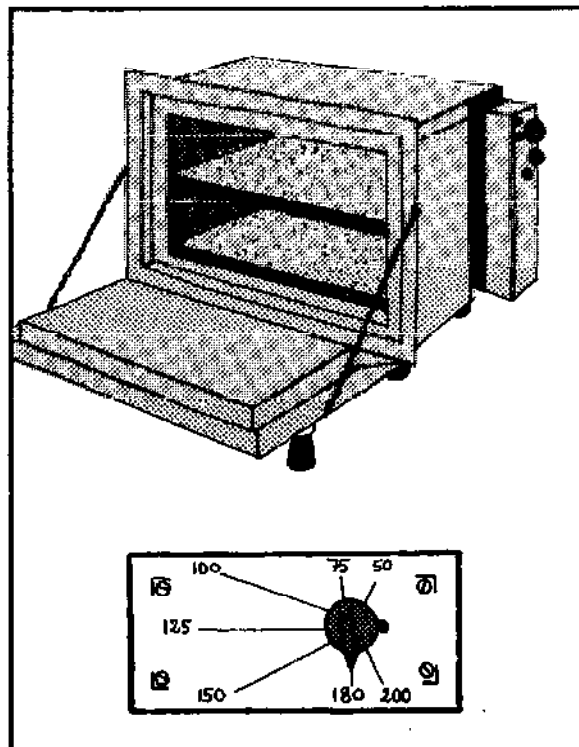

V. STERILIZATION BY FLAMING

This is a method that should be used only for metal articles such as forceps and scalpels. It is not suitable for general use.

1. Place the articles in a metal tray.
2. Add about 10 drops of ethanol and ignite.
3. Tilt the tray one way, then the other, during flaming.

Bacteriological loops, vaccinating needles, or lancets for taking capillary blood samples should be heated in the flame of a gas burner or spirit lamp until they are red hot.

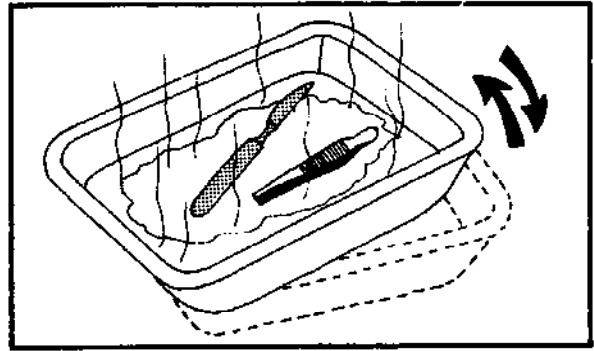

5. Disposal of Specimens and Infected Material

Important: The specimens examined in the laboratory (stools, pus, sputum, urine, etc.) are often infectious. After examination they must be destroyed in such a way that all risk of infection is avoided.

The specimens may be disposed of:

- in cardboard cartons or plastic pots that can be destroyed (stools, sputum)
- in glass jars and bottles that can be cleaned, sterilized and used again.

All disposable containers are used once only.

DISPOSABLE BOXES CONTAINING STOOLS OR SPUTUM

These may be burned (incinerated) or buried in the ground.

Incineration is the easier and more effective method.

A. Incineration

Making an incinerator

1. Use an old metal drum.
2. Fix a strong metal grating (g) firmly about 1/3 of the way up the drum.
3. Cut a wide opening or vent (v) below the level of the grating.
4. Find a removable lid (l) for the drum.

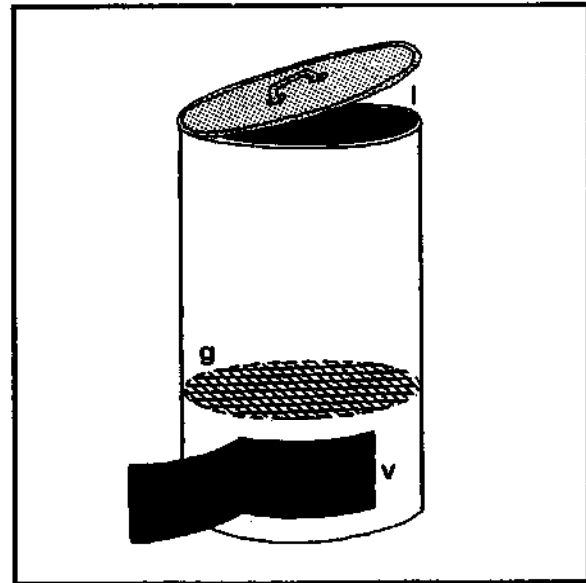

How to incinerate

1. At the end of each morning's and afternoon's work, place all used stool and sputum boxes on the grating of the incinerator.
2. Always keep the metal drum tightly closed (both lid and vent) except during incineration.
3. Incinerate once a week, or more often if necessary. Fill the bottom of the drum with paper, sticks, wood shavings, etc.
4. Remove the lid. Light the fire and keep it burning until all the infected material has been reduced to ashes.
5. The ash produced is not dangerous and can be thrown on the refuse heap.

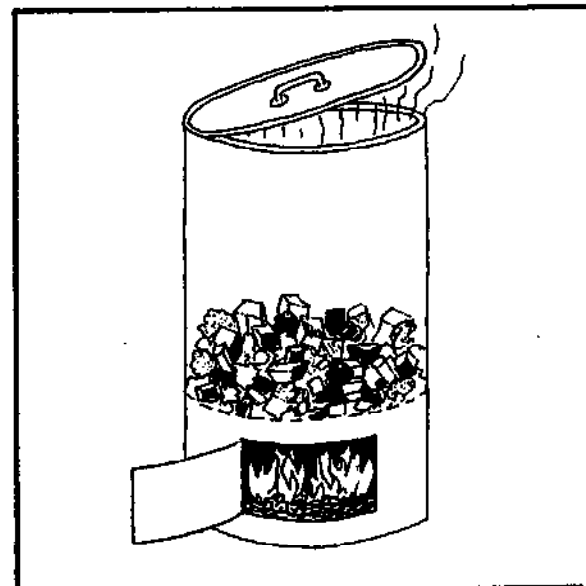

B. BURIAL

- (a) Dig a pit 4-5 metres deep and 1-2 metres wide.
- (b) Make a lid that fits tightly over the pit. It is advisable to strengthen the upper rim of the pit by lining it with bricks or stones.
- (c) Throw stool or sputum boxes and other infected material into the pit twice a day. Replace the lid immediately.
- (d) Once a week, cover the refuse with a layer (about 10cm thick) of dried leaves.
- (e) If possible, instead of using dry leaves add a *layer of quicklime* once a week.

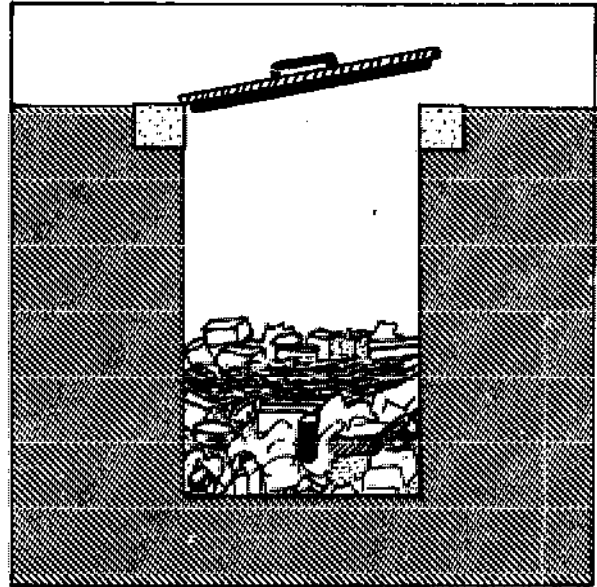

STERILIZATION AND CLEANING OF NON-DISPOSABLE CONTAINERS

This is a more difficult procedure (so, where possible, use disposable containers).

The jars and bottles may contain:

- very infectious material (stools, sputum, pus, CSF)
- other specimens (blood, urine).

A. Stool containers

Fill the jars containing stools with a 5% solution of phenol or a similar disinfectant. Leave for 24 hours. Empty into the lavatory. If the lavatory is connected to a septic tank, phenol or other antiseptic should not be added to the stools. Clean the jars with detergent and water, as described on page 29.

B. Sputum pots and tubes of pus and CSF

There are several possible methods.

Using an autoclave

This is the best method.

1. Place the jars as they are in the autoclave and sterilize for 30 minutes at 120°C to destroy all organisms.
2. After they have cooled, empty the contents into the sink or the lavatory.
3. Clean with water and detergent.

Boiling in detergent

Keep a large pan especially for this purpose.

Boil sputum pots:

- for 30 minutes
- in water containing washing powder in a strong solution (or, even better, sodium carbonate crystals), 60 ml per litre of water.

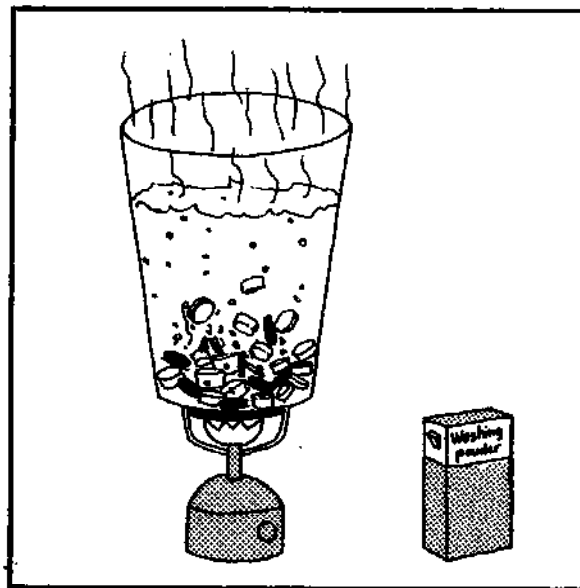

Using formaldehyde solution (reagent No. 26) or phenol

Pour into each sputum pot:

- 10 ml of undiluted formaldehyde solution, or
- 5 ml of 5% phenol.

Leave for 24 hours.

C. Urine bottles

Empty the bottles into the lavatory.

Fill them with:

- a 10% solution of commercial bleach, or
- a 2% solution of phenol.

Leave for 24 hours.

D. Tubes of blood

Tubes of *fresh blood* collected the same day should be:

- rinsed in cold water
- left to soak in a detergent solution (see page 29).

Tubes of *"old" blood* kept for several days at room temperature where organisms may multiply in them should be:

- filled with a 10% solution of commercial bleach
- left for 12 hours and then rinsed and cleaned.

6. Measurement of Volume

	microlitre	millilitre or cubic centimetre	litre
Abbreviation	μl , mm^3 ("c mm") = 1/1000 ml	ml, cm^3 = 1/1000 litre	1 = 1000 millilitres (ml)

The unit used most often in the laboratory is the millilitre (ml).

The following apparatus is used for measuring volume in the laboratory:

1. Measuring cylinders
2. Pipettes
3. Volumetric flasks
4. Burettes
5. Graduated dropping pipettes
6. Graduated conical testing glasses

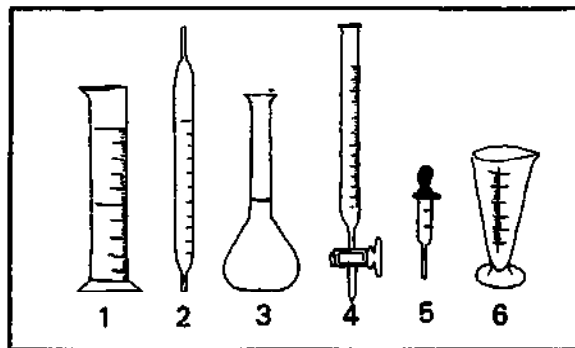

1. MEASURING CYLINDERS

Various volumes can be measured with these, but without great accuracy.

Use a measuring cylinder with a capacity close to the volume required. For example:

- to measure 45 ml, use a 50-ml measuring cylinder
- to measure 180 ml, use a 200-ml measuring cylinder
- to measure 850 ml, use a 1000-ml measuring cylinder.

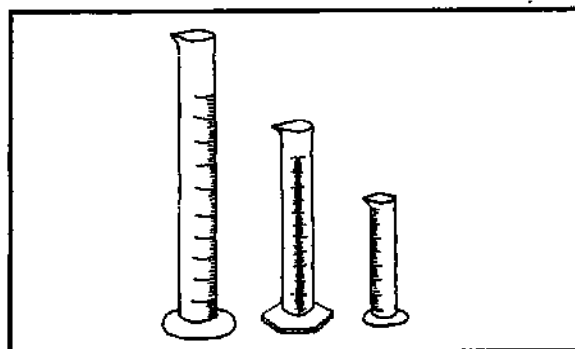

Reading the level

A concave meniscus (M) forms at the surface of water (and most other liquids) in narrow glass tubes.

The reading should be made at the graduation mark (G) corresponding to the lower part of the meniscus.

To avoid errors in reading, stand the cylinder on a bench and adjust your eye level to the surface of the liquid.

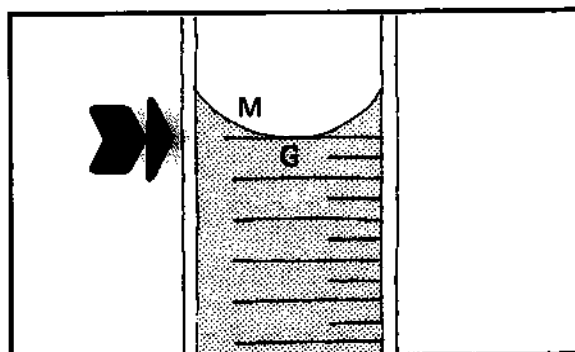

2. PIPETTES

(a) Graduated pipettes

The following graduation marks are marked at the top of the pipette:

- the total volume that can be measured
- the volume between 2 graduation marks.

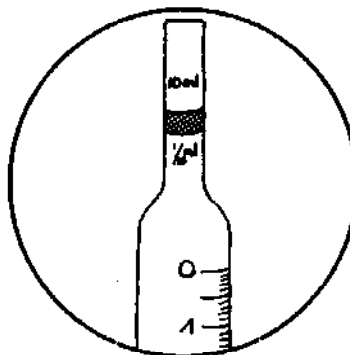

There are several types of graduated pipette:

1. A pipette with graduations to the tip (A). The total volume that can be measured is contained between the 0 mark and the tip.
2. A pipette with graduations not extending to the tip (B). The total volume is contained between the 0 mark and the last mark before the tip (this type is recommended for quantitative chemical tests).

Various volumes can be measured using graduated pipettes. For example:

- a 10-ml pipette can be used to measure 8.5 ml
- a 5-ml pipette can be used to measure 3.2 ml
- a 1-ml pipette can be used to measure 0.6 ml.

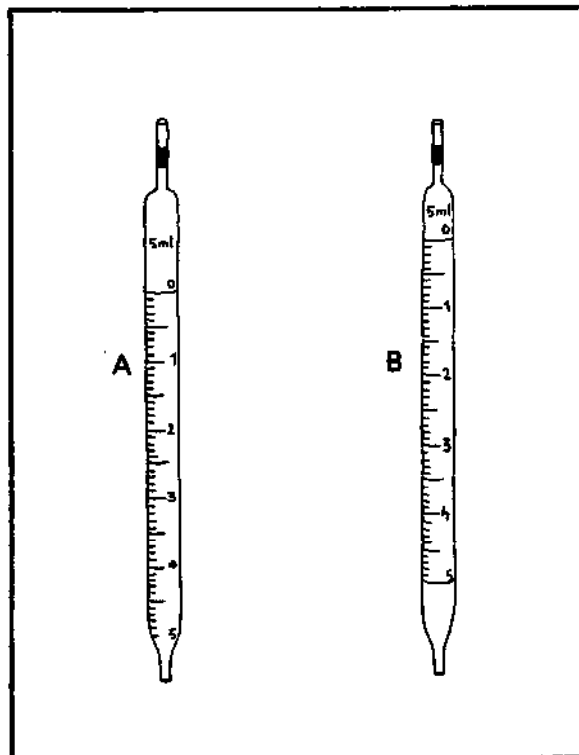

(b) Volumetric pipettes

These are intended to measure a precise volume with a high degree of accuracy (A and B). B are considerably cheaper than A, yet are quite precise enough for clinical analyses.

There are two other types:

1. A pipette with a single graduation mark, which is intended to be filled to the mark. After discharge of the contents, the pipette is allowed to drain for 15-45 seconds (according to size, marked on bulb) and the last drop is expressed against the side of the recipient container. It should not be blown out.
2. A pipette with 2 graduation marks. In skilled hands this may be more accurate, but it is less reliable for the less expert because it is easy to overrun the lower graduation when discharging.

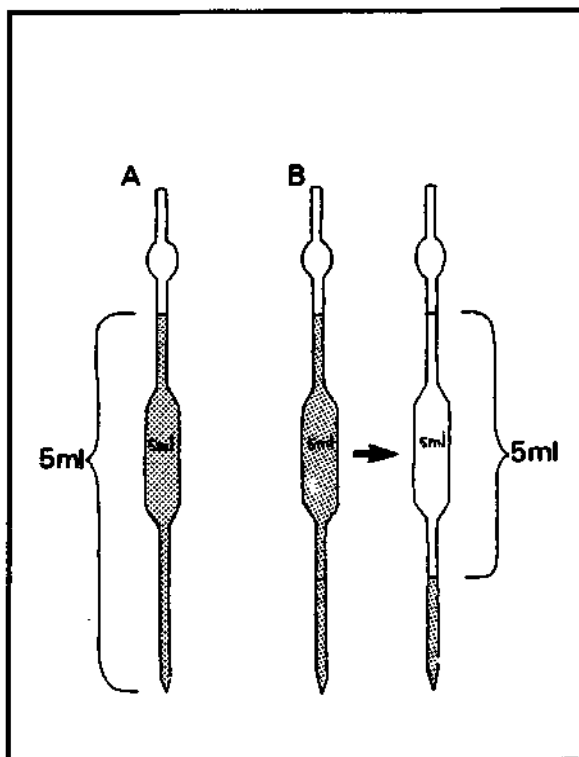

To pipette dangerous fluids

1. Use a pipette with a safety bulb (S) near the mouth opening
2. Plug the pipette with cotton wool (non-absorbent) (C) or
3. Aspirate the solution with a rubber bulb pipette filler (this is far the best method).

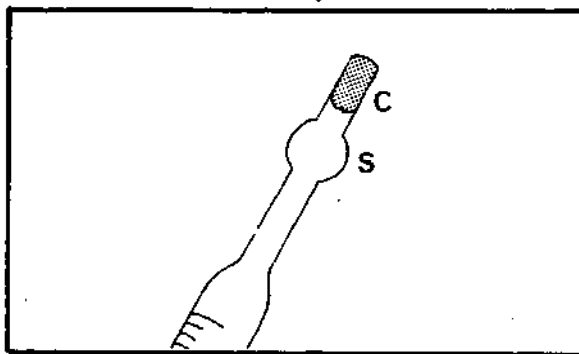

How to hold the pipette

Hold the pipette in a vertical position to check that the liquid reaches the desired graduation mark (G). The mark should be level with the bottom of the meniscus formed by the liquid.

The tip (T) of the pipette should be held against the side of the receptacle.

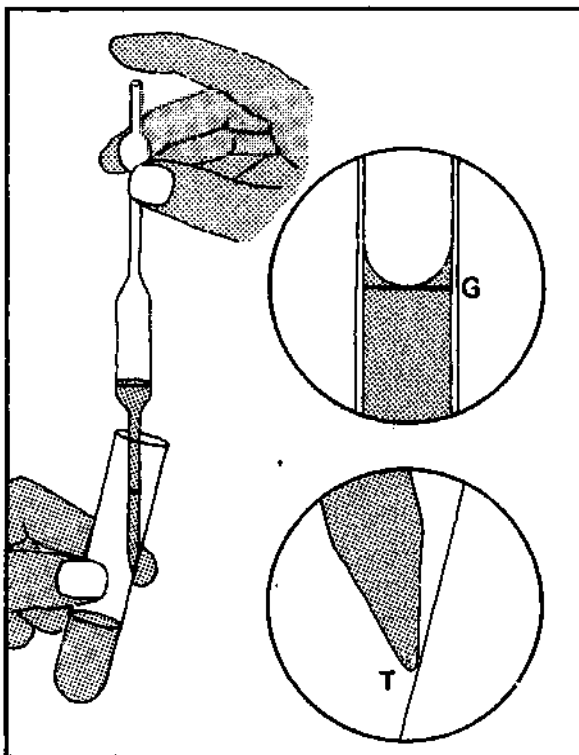

3. VOLUMETRIC FLASKS

These are graduated to measure a certain volume when filled to the graduation mark.

They have various capacities:

- 2000 and 1000 ml
- 500 ml
- 250 and 200 ml
- 100 ml
- 50 and 25 ml.

Volumetric flasks are more accurate than measuring cylinders. They should be used for the preparation of reagents.

For example: 1 litre of sodium chloride solution (reagent No. 45) is prepared by washing 8.5 g sodium chloride, dissolved in water in a beaker, into a 1000 ml flask through a funnel and diluting (while mixing) to the 1000 ml mark.

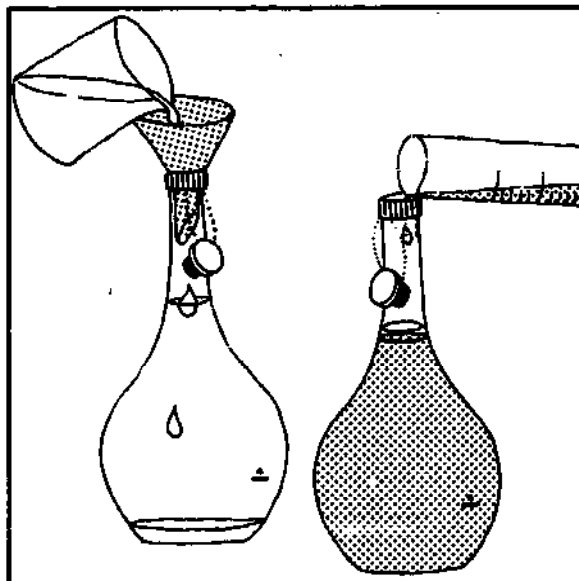

Alternatively, the substance(s) can be dissolved in a small container and the solution poured into the flask along a glass rod.

Rinse the container several times, pouring the liquid into the flask along the glass rod each time. Fill to the graduation mark.

(This method is recommended for the preparation of titrated chemical reagents.)

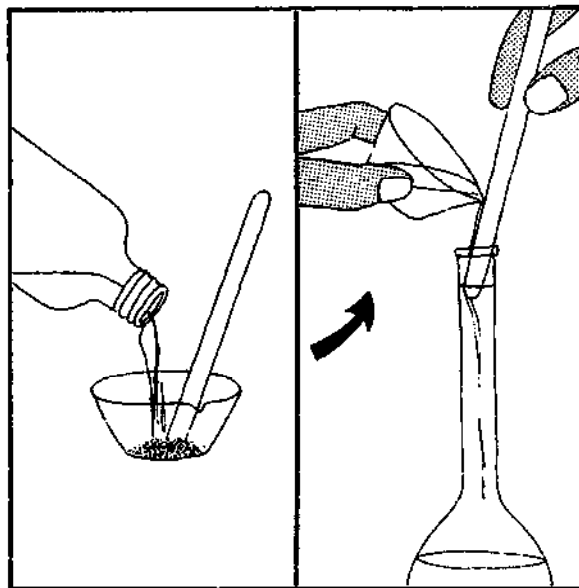

Temperature of the liquid

The temperature at which liquids should be measured is etched on the flask (after the capacity figure).

For example:

– 200 ml: 20 °C.

Liquids expand with heat and contract when cold. Never measure hot liquids, or cold liquids just taken from the refrigerator.

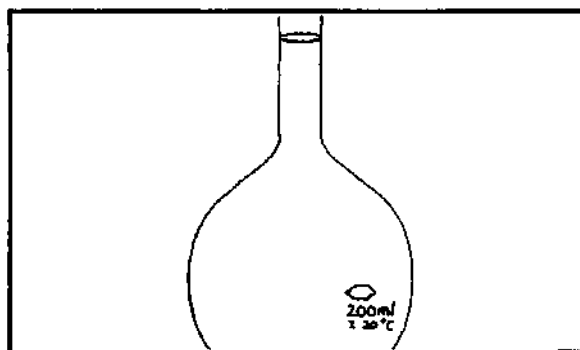

Stoppers

Volumetric flasks should have plastic (preferably) or ground glass stoppers. Be careful not to lose them, so tie them to the neck of the flask with a piece of thread.

Cost

Volumetric flasks are very expensive, so use them with great care.

4. BURETTES

These are graduated glass tubes with a glass stopcock at the lower end. Burettes are filled from the top with the liquid to be measured. They are of 10 ml, 20 ml, 25 ml and 50 ml capacity.

Stopcock and tap (A)

The stopcock and tap should be kept well greased. To grease a clean stopcock properly, apply the tiniest smear of petroleum jelly with a finger tip down the two sides of the stopcock away from the capillary bore. Then insert the stopcock in the burette and rotate it until a smooth covering of the whole stopcock is obtained. Keep the top plugged or covered (B).

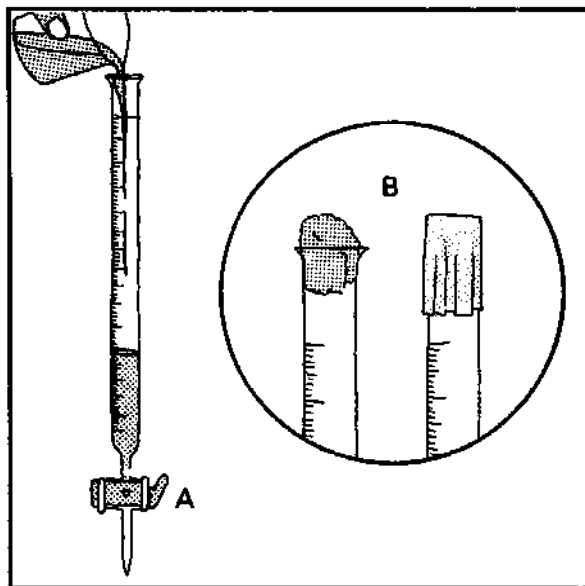

5. CALIBRATED DROPPING PIPETTES

Ordinary calibrated dropping pipettes often deliver 20 drops per ml of distilled water, thus 1 drop = 0.05 ml.

Hold the dropping pipette absolutely vertical to measure the drops. Check that drops do not contain any air bubbles.

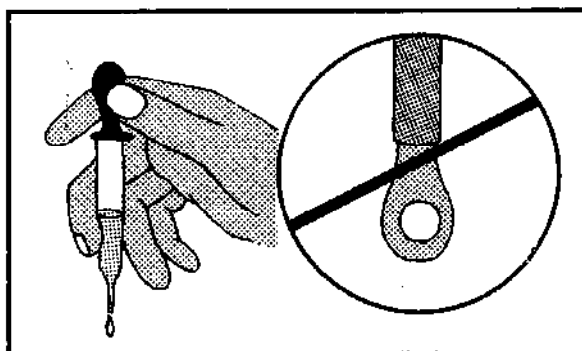

Calibration of dropping pipettes

Using a volumetric pipette, measure 1 ml of water into a small tube.

Draw the water into the dropping pipette to be calibrated.

Count the number of drops delivered from the ml of water.

Repeat the procedure 3 times to check the accuracy.

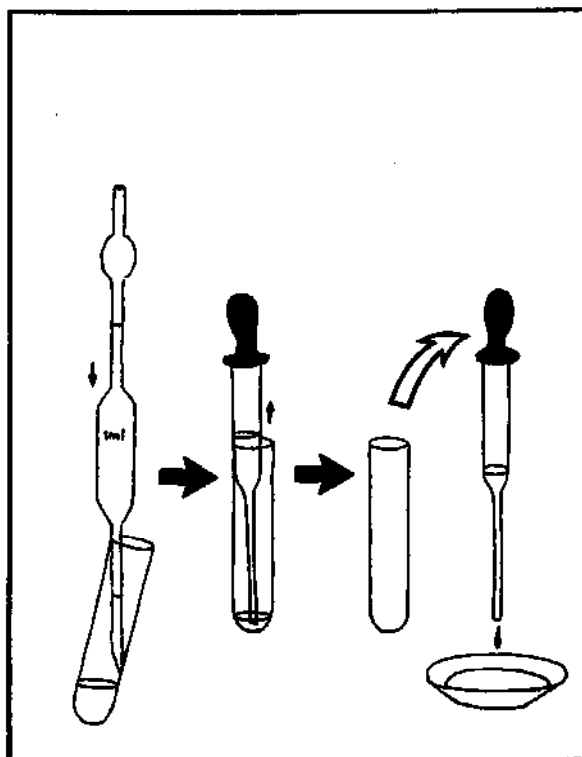

6. GRADUATED CONICAL TESTING GLASSES

These are not very accurate. Avoid using them for laboratory tests.

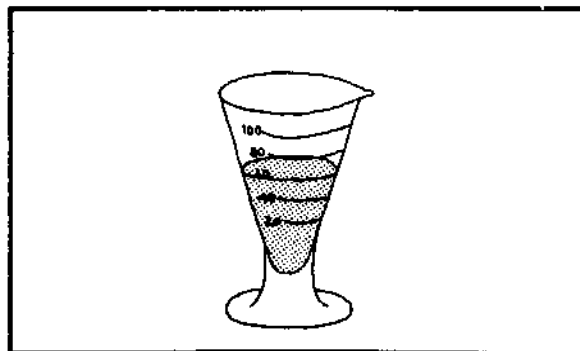

ACCURATE	LESS ACCURATE	INACCURATE
Pipettes Volumetric flasks	Measuring cylinders Calibrated dropping pipettes	Conical testing glasses

SOME THINGS NOT TO DO

1. Never measure the volume of hot liquids (they will have expanded).
2. Never heat graduated glassware in a flame.
3. Never leave graduated glassware to soak in an alkaline solution (sodium hydroxide, potassium, ammonia).

7. Balances

UNITS OF WEIGHT

	milligram	centigram	decigram	gram	kilogram
Abbreviation	mg (10^{-3} g)	cg (10^{-2} g)	dg (10^{-1} g)	g	kg (10^3 g)
Corresponding value	$\frac{1}{1000}^g$	$\frac{10 \text{ mg}}{100}^g$	$\frac{100 \text{ mg}}{10}^g$	$\frac{1000 \text{ mg}}{1000} \text{ kg}$	1000 g

Sensitivity of a balance

This corresponds to the smallest mass that makes the pointer move over one division on the scale. For example: if the sensitivity of a balance is 1 mg, this means that a mass of at least 1 mg is needed to move the pointer.

For routine laboratory purposes, the sensitivity of a balance can be considered to be the *smallest mass* that it will measure accurately.

1. OPEN TWO-PAN BALANCE

This has 2 pans supported by shafts. It may be designed for use with separate weights, as illustrated, or incorporate a graduated arm with a sliding weight ("Harvard trip balance"). It is used to weigh large amounts (up to several kilograms) when a high degree of accuracy is not required, e.g. 22.5 g, 38 g, 8.5 g, 380 g.

Sensitivity: 0.5 g (500 mg).

If the pans are made of easily scratched or corroded material, protect them with rings cut out of strong plastic or old X-ray films of equal weight.

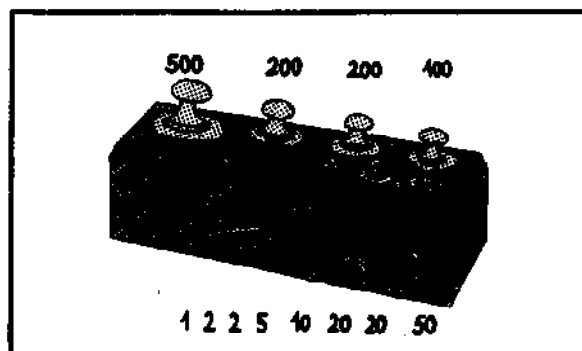
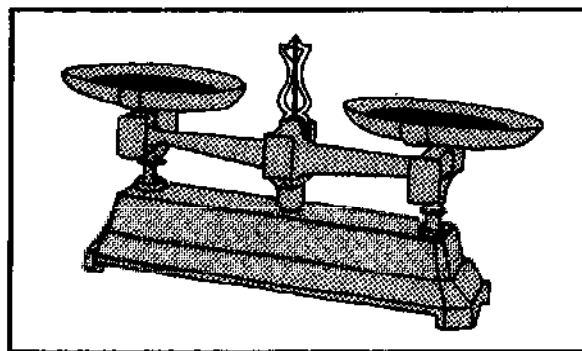

Set of weights for use with open two-pan balance.

2. ANALYTICAL BALANCE

This balance has 2 pans suspended from a cross-beam inside a glass case.

Use the balance:

- to weigh small quantities (up to 20 or 200 g, depending on the model)
- when great accuracy is required: e.g. 3.85 g, 0.220 g, 6.740 g.

Sensitivity: 0.5 mg - 0.1 mg, depending on the model.

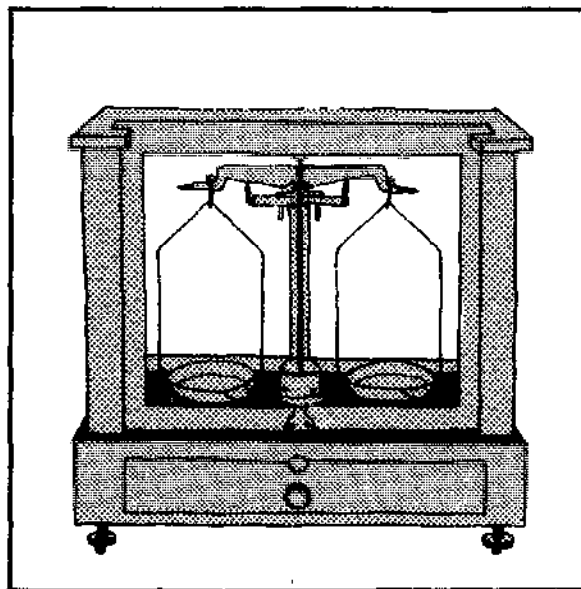

Components of the balance

- CB = cross-beam. This is the structure from which the pans are suspended.
- KE = knife edges (KE1, KE2, KE3). These support the beam at the fulcrum; during the weighing and give sensitivity to the balance. Those on the beam support the suspended pans.
- S = stirrups (S1, S2)
- Pt = pointer
- P = pans
- B = beam release screw (or pan arrester control). Arrests the pan so that the sudden addition of weights or chemicals will not injure the delicate knife edges.
- AS = adjusting screws (AS1, AS2). Used only for initial adjustment of the unloaded balance to a reading of zero.

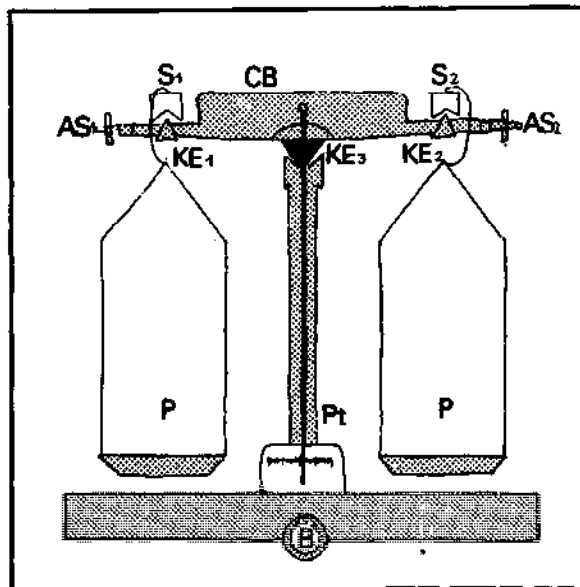

Set of weights for use with analytical balance.
Single pieces: 1, 2, 5, 10, 20, 50, 100, 200 and 500 g.
Single fractional pieces: 2, 5, 10, 20, 50, 100, 200 and 500 mg.

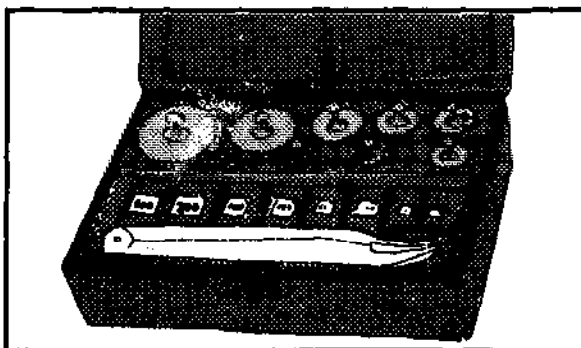

Instructions for use

1. The cross-beam must always be at rest (beam release screw tightened) before the weights and the substance to be weighed are placed on the pans.
2. The cross-beam must always be put back at rest before the weights and the substance weighed are removed from the pans.
3. Always place the substance to be weighed on a piece of paper folded in 4, or in a watch glass or porcelain dish.
4. Always use forceps to pick up the weights.
5. Check that the pans are balanced by unscrewing the beam release screw, after closing the glass case.
6. Use adjusting screws AS1 and AS2 to obtain a perfect balance when compensating for the weight of the receptacle in which the substance will be weighed.
 - When the screw is turned away from the central support the weight is increased
 - When it is turned towards the central support the weight is decreased.

3. DISPENSARY BALANCE

This balance also has 2 suspended pans, but it has no glass case and no rests.

Sensitivity: 5-10 mg.

The dispensary balance is more accurate than the open two-pan balance, but weighs only up to 50g. (After using the dispensary balance, put it away in a closed cupboard.)

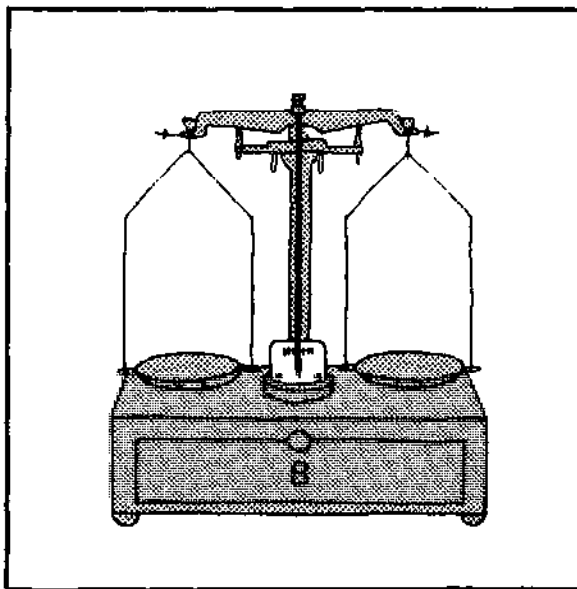

4. WEIGHING PROCEDURE

- (a) Place the bottle containing the substance to be weighed to the left of the balance.
- (b) Place *on the left-hand pan* the receptacle (folded paper or dish) in which the substance will be weighed.
- (c) Place *on the right-hand pan* the weights equivalent to the weight of the receptacle plus the amount of the substance to be weighed.

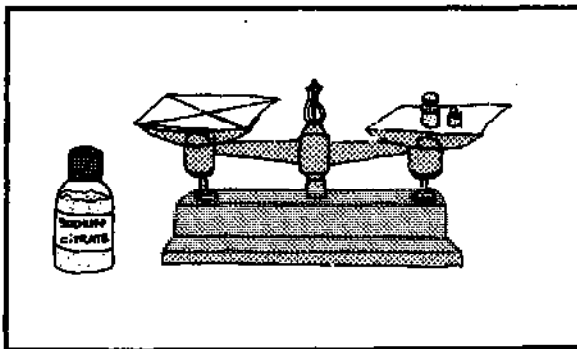

- (d) To measure out the substance to be weighed:
 - hold the bottle tilted in your left hand (label upwards)
 - tap the neck of the bottle gently with your right hand so that the powder or crystals to be weighed fall little by little
 - use a clean spatula when weighing small amounts of substances.

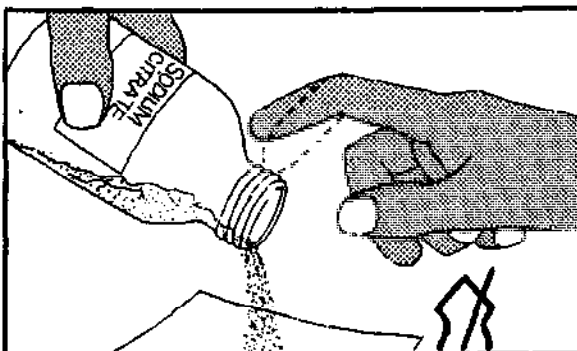

(e) As soon as the substance has been weighed, move the bottle to the right hand side of the balance. Thus place:

- the weighed substances on the right
- the unweighed substances on the left.

This avoids confusion.

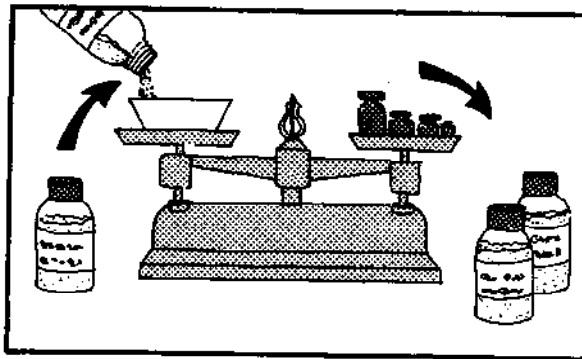

(f) Read the label 3 times:

- before taking the bottle off the shelf
- while weighing the substance (label facing upwards)
- after weighing, when you move the bottle to the right of the balance.

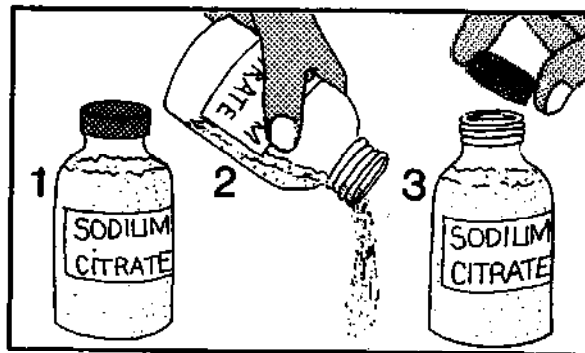

8. Centrifuges

Centrifugal force

A body is rotated in a circular movement (CM) at speed.

This creates a force that drives the body away from the centre of the circular movement: centrifugal force (g).

You should *always* follow the manufacturer's instructions in centrifuging, but it is possible to calculate the revolutions per minute (r/min) from g for an individual centrifuge. Measure the radius (r) of the rotor arm and use the formula:

$$g = r \times (r/\text{min})^2 \times 118 \times 10^{-7}$$

For example, if the radius is 25 cm, 500 g is about 1300 r/min.

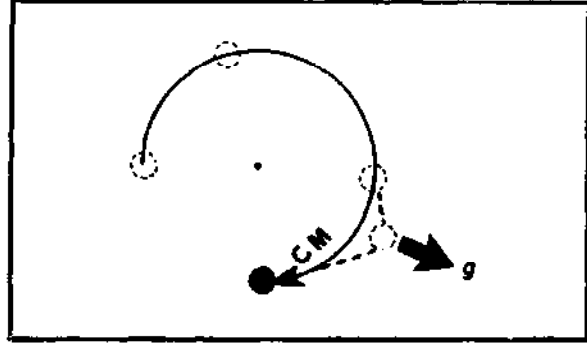

Centrifuges consist of

- a central shaft or spindle (A) which rotates at high speed
- a head (E), fixed to the shaft, with buckets for holding the centrifuge tubes
- tubes (T) containing the liquid to be centrifuged, which are fixed to the head.

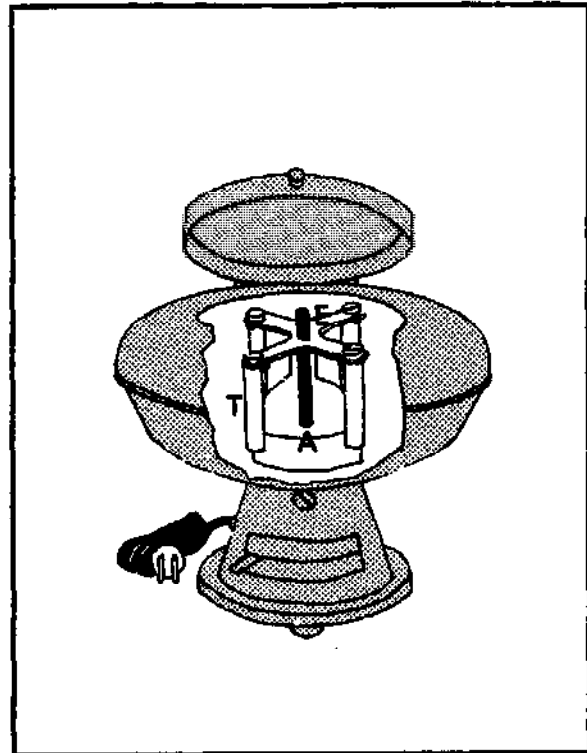

When the spindle rotates the tubes are subjected to centrifugal force. They swing out to the horizontal and the particles in suspension in the liquids in the tubes are thrown to the bottom of the tubes.

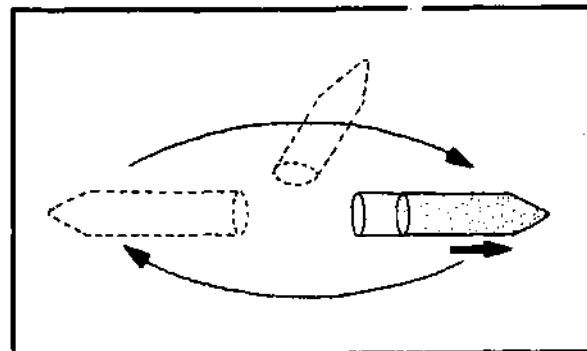

The particles are compacted at the bottom of the centrifuge tubes, forming the centrifuge deposit.

The deposit can be separated from the supernatant fluid and examined. It may contain:

- blood cells
- parasite eggs (in diluted stools)
- cells from the urinary tract (in urine) etc.

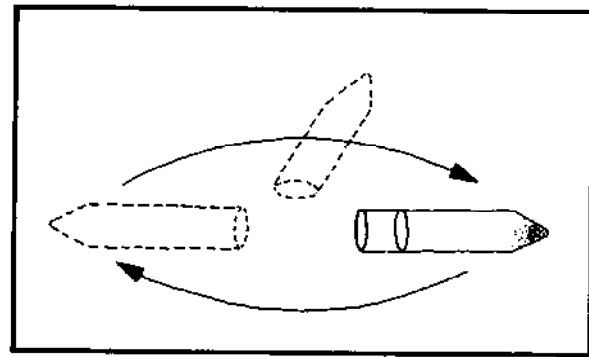

DIFFERENT TYPES OF CENTRIFUGE

A. Hand centrifuge

This is operated manually by turning a handle. It takes 2 or 4 tubes.

Uses

1. To examine urinary deposits
2. To concentrate certain parasites in stools.

The speed is insufficient for satisfactory separation of red cells from plasma in blood.

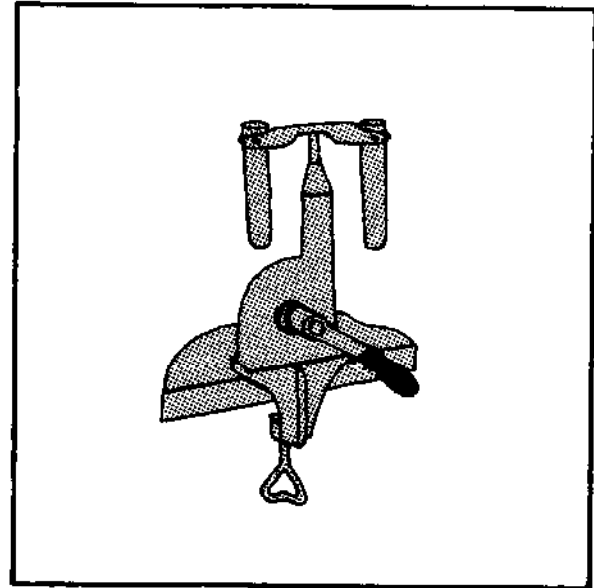

Important:

1. Clamp the hand centrifuge firmly on a stable support (edge of a table).
2. Balance the 2 diametrically opposite tubes perfectly as indicated in instructions for use, page 54.
3. Keep your distance while centrifuging.
4. To stop the centrifuge, do not slow down the turning of the handle. Pull the handle out of the machine with a sharp movement.
5. Remove the tubes slowly and carefully (so as not to disturb the deposit).
6. Lubricate the spindle of the centrifuge regularly.

Warning: The hand centrifuge can cause serious injury, so follow the instructions above carefully.

B. Electric centrifuges

In certain areas battery-operated centrifuges may be used.

Centrifuges are used with two types of head:

1. "Swing out" head

The head is designed to swing the tubes out to a horizontal position during centrifuging. This is the type most frequently needed.

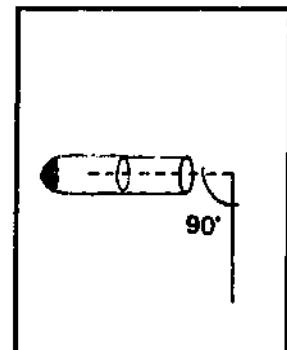
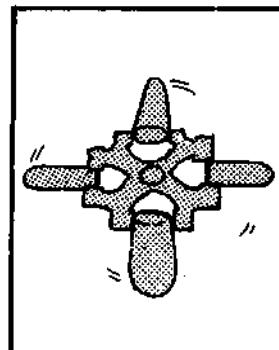

2. "Angle" head

This holds the tubes at an angle of about 45° during centrifuging. It is useful for certain techniques, e.g. agglutination tests in blood grouping by the test-tube method. It is not essential, however, for any of the techniques described in this manual.

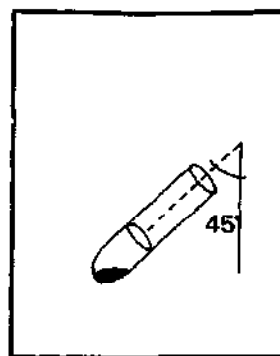
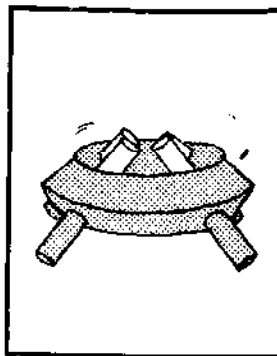

Accessories for electric centrifuges

Buckets (tube holders)

There are several types, depending on the model:

- (a) buckets designed to hold one round-bottomed or conical tube only
- (b) buckets that hold 2 round-bottomed or conical tubes
- (c) buckets that hold 9 small (precipitin) tubes etc.

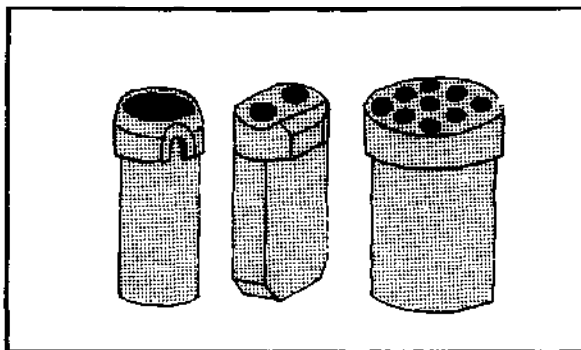

Some models are fitted with:

- a timer (T) that stops the centrifuge automatically when the time is up (e.g. after 5 or 10 minutes)
- a revolution counter (RC), i.e., a dial with a needle that indicates the speed of the machine during centrifuging (this is useful for some methods of concentration of parasites).

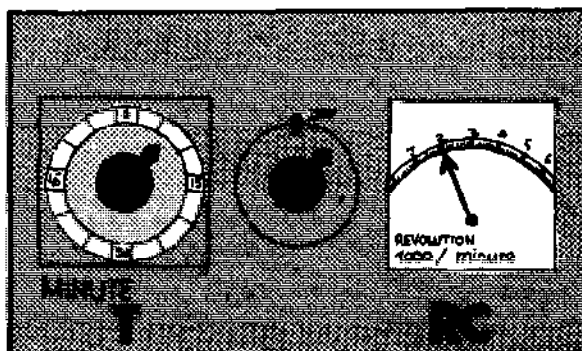

INSTRUCTIONS FOR USE

1. Balancing the buckets

If the tubes are numbered, place them as follows:

- tube 1 opposite tube 2
- tube 3 opposite tube 4.

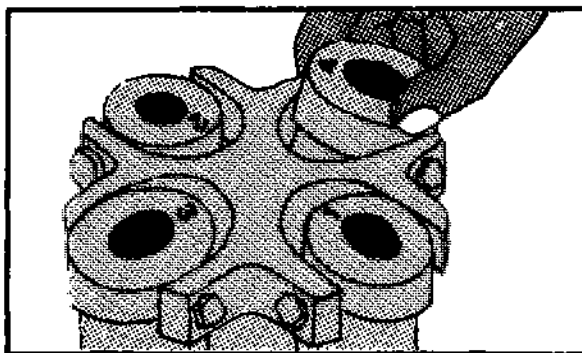

Balance the tubes that are opposite each other by weighing them in their buckets on the open two-pan balance. To balance:

- either add more of the liquid to be centrifuged to the lighter tube
- or add water to the bucket containing the lighter tube (using a wash bottle).

If only one tube of liquid is to be centrifuged, balance it with an identical tube filled with water.

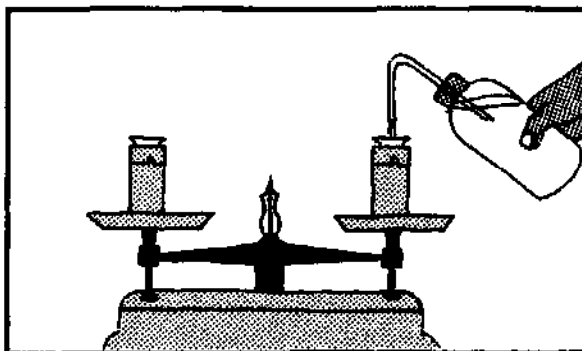

2. Preventing breakage of tubes

Always pad the bottom of the buckets with the rubber cushions provided with the machine. This protects the bottom of the centrifuge tubes.

Using a wash bottle, add a little water between each tube and its bucket.

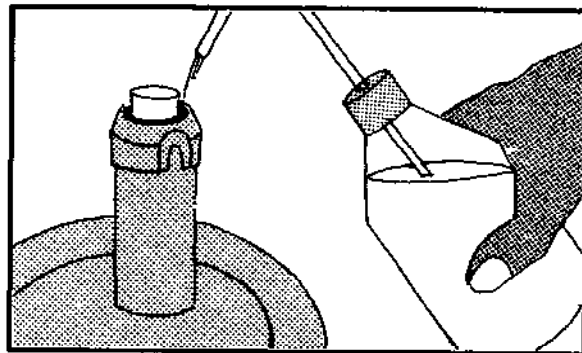

3. Starting and stopping the centrifuge

- (a) Start the motor and gradually increase the speed, turning the knob slowly until the desired speed is reached.
- (b) Stop the centrifuge gradually (some models have a brake that can be applied).
- (c) Remove the tubes slowly and carefully.
- (d) Never open the centrifuge until it has come to a complete stop.
- (e) Never try to slow it down with your hand.

4. Cleaning and lubrication

Keep the bowl of the centrifuge very clean. Rinse the buckets after use. Remove any spots of blood, etc. Lubrication should be carried out by a specialist, according to the manufacturer's instructions.

Important: If you fall into the habit of centrifuging without balancing the tubes beforehand, the centrifuge will soon break down.

9. Water for Laboratory Use

The medical laboratory needs an adequate water supply for its work. It requires:

1. Clean water
2. Distilled water
3. Demineralized water (if possible)
4. Buffered water (if possible).

In some areas water is scarce and highly contaminated. How can clean water be obtained?

CLEAN WATER

A. Quality control

1. Fill a bottle with water.
2. Let it stand for 3 hours.
3. Examine the bottom of the bottle. If there is a deposit, the water needs to be filtered.

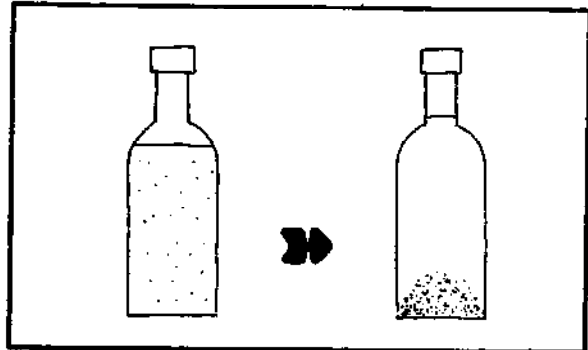

B. Filtering

1. *Using a porous unglazed porcelain or sintered glass filter (Chamberland type or other)*

(a) This can be attached to a tap.

(b) Alternatively, it can be kept immersed in a container of the water to be filtered.

Important: Filters of this type must be dismantled once a month and washed in boiling filtered water.

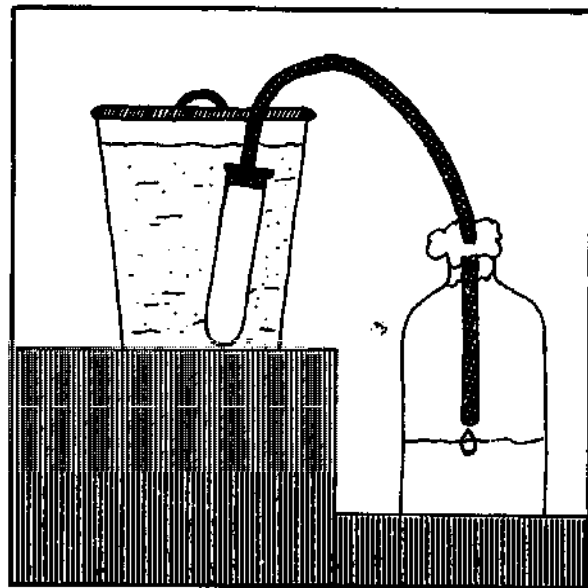

2. *Using a sand filter*

This can be made in the laboratory. You will need:

- (a) A filter reservoir (a large container such as a metal drum, a big earthenware pot or a perforated bucket)
- (b) Sand
- (c) Gravel.

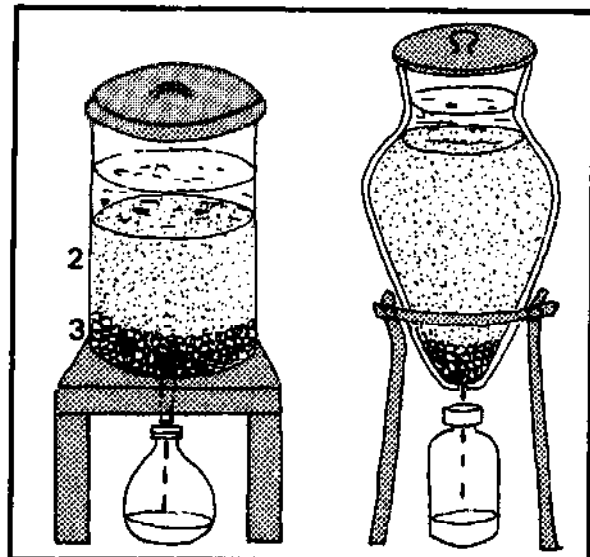

C. Storage of water

If water is scarce or comes from a tank or well, always keep a large supply in reserve, preferably in glass or plastic containers.

Decant water that has been stored before filtering it.

D. Water supply

If there is no running water in the laboratory, set up a distributor as follows:

1. Place the container of water on a high shelf.
2. Attach a rubber tubing to the container so that the water can flow down.
3. Clamp the rubber tubing with a Mohr clip or a small screw clamp.

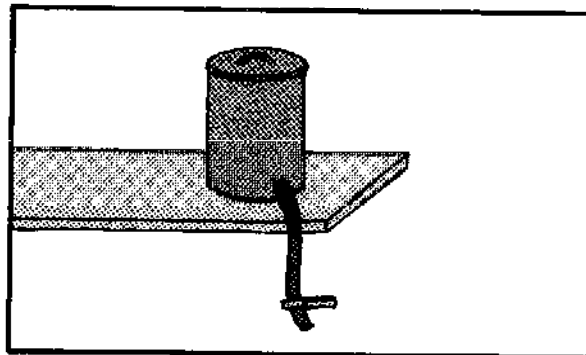

DISTILLED WATER

A. Preparation

This is prepared using a still, in which:

- ordinary water is heated to boiling point
- the steam produced is cooled as it passes through a cooling tube and condenses to form distilled water.

The following types of apparatus are available:

1. Copper stills (alembics)
2. Glass stills.

They are heated by gas, kerosene or electricity, depending on the type of still.

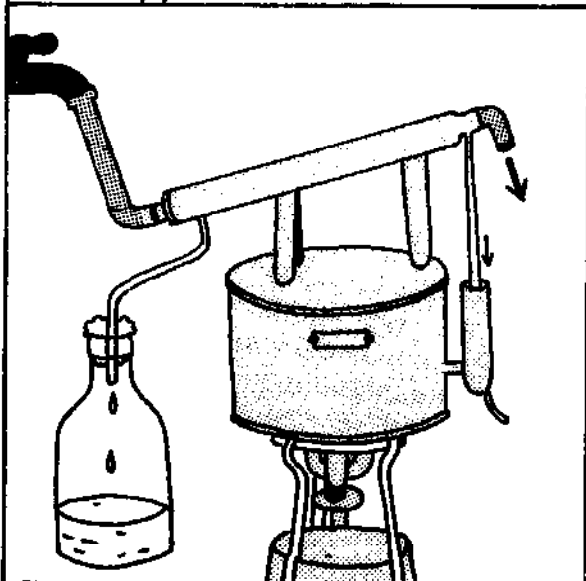
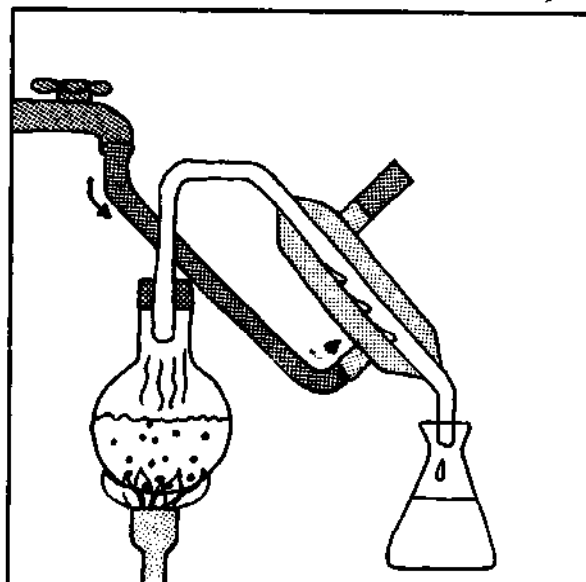

1. Copper or stainless steel alembics

One of the simplest models is the alembic supplied by UNICEF (ref: 01.680.02).

(a) Fill the reservoir with the water to be distilled.

(b) Connect the cold water tube to a tap.

(c) Heat the reservoir with:

- a Bunsen burner, or
- a kerosene heater (Primus type).

The still can produce 1 or 2 litres of distilled water per hour, depending on the efficiency of the heating system.

2. Glass stills

These are more fragile, but almost always produce purer water. The distillation method is the same. Make sure that the running water circulates freely round the condenser (C). The water can be heated in the flask by an electric element (E).

Important:

- Collect the distilled water in a glass or plastic container that is protected from the atmosphere.
- Do not distil the last 1/4 of the water heated.

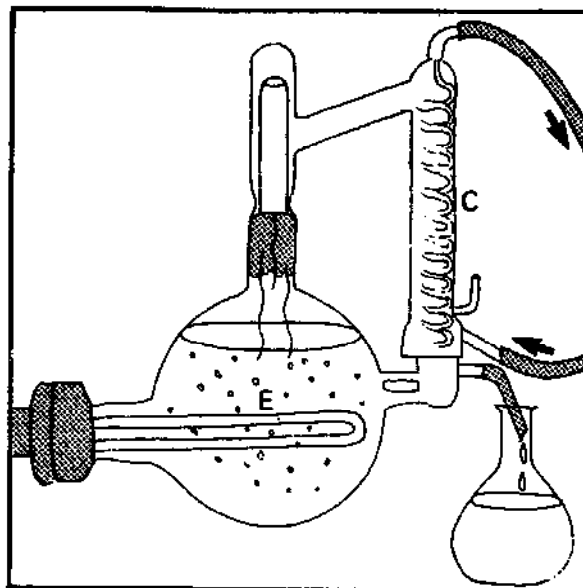

B. Quality control of distilled water

Use a 17 g/l (17 g in 1 litre of solution) (1.7%) aqueous solution of silver nitrate (AgNO_3) (reagent No. 43).

Put in a beaker:

- 10 ml of distilled water
- 2 drops of nitric acid
- 1 ml of the silver nitrate solution

The water should remain perfectly clear.

If a slight whitish turbidity appears, the quality of the distilled water is poor.

The pH of distilled water is normally between 5.0 and 5.5 (i.e., it is acid).

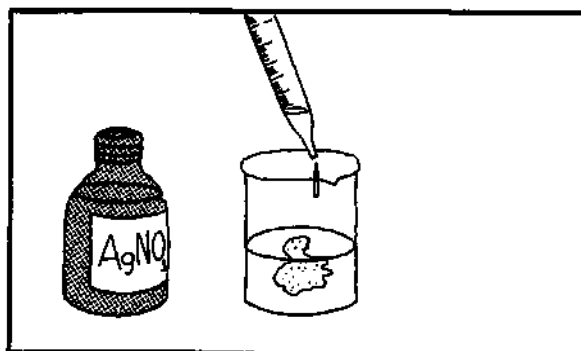

C. Uses for distilled water

- For the preparation of reagents
- As a last rinse for some glassware before drying.

Important:

- Do not use commercial distilled water (the type sold for filling car batteries) for the preparation of laboratory reagents.
- Freshly prepared distilled water is preferable; if this is not possible store the distilled water in glass or plastic containers, which should be washed periodically.
- Always use distilled water prepared the same week.

DEMINERALIZED WATER

Principle

Demineralized water is prepared by passing ordinary water through a column of *ion-exchange resins*.

The apparatus consists of a long cartridge filled with ion-exchange resin granules.

The water filters through the column of granules, which retain all the mineral ions (i.e., all the dissolved mineral salts). This water free from ions is called *demineralized water*.

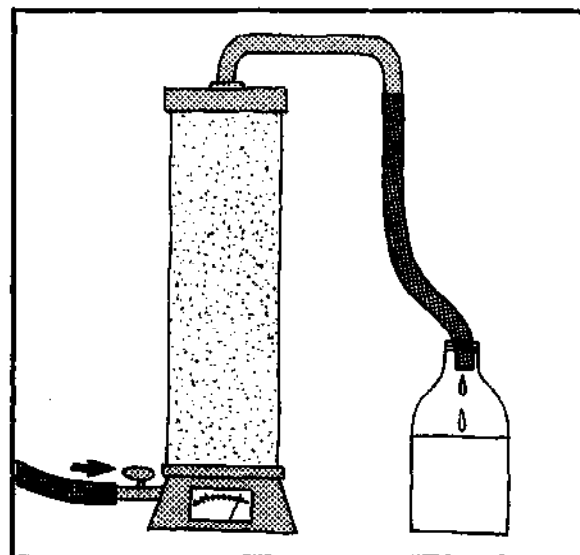
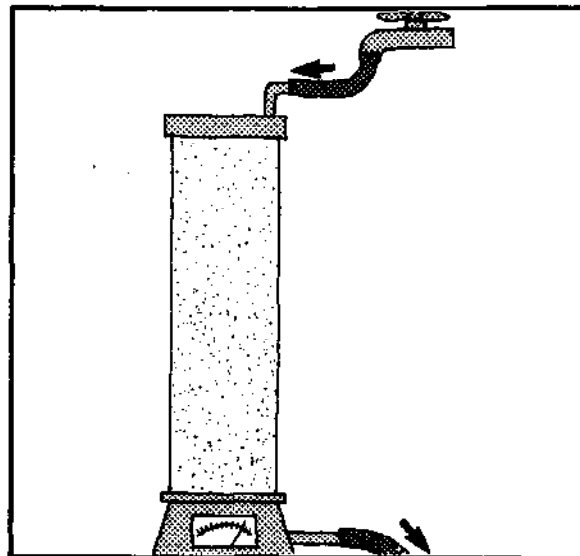

A. Preparation

1. Check that the cartridge is completely filled with ion-exchange resin granules. Some demineralizers have 2 cartridges through which the water passes successively.
2. Connect the inlet tube of the apparatus to the water supply (a tap or a small tank placed above). In some models the water flows in at the top of the column, in others at the bottom.
3. Let the water flow in slowly.
4. Collect the demineralized water in a closed container.

B. Quality control of demineralized water

1. Apparatus with a control dial

This measures the conductivity of the water. The more complete the demineralization, the lower the electrical conductivity of the water.

- (a) Check that the control system is fitted with a battery in good working order.
- (b) To check that the battery is charged, press the button marked "zero test". The needle on the dial should swing to zero.
- (c) Let water flow into the cartridge.
- (d) When demineralized water begins to flow out at the other end, press the button marked "water test". The needle should register a resistivity of over 2 megaohms/cm ($2\text{ M}\Omega/\text{cm}$).
- (e) If the needle stops at a point below 2 or stays at zero, the cartridge of ion-exchange resins has been used for too long and must be replaced or reactivated.

The apparatus may be graduated in resistivity ($\text{M}\Omega/\text{cm}$) or in conductance (siemens, S). Most modern instruments manufactured in Europe use siemens.

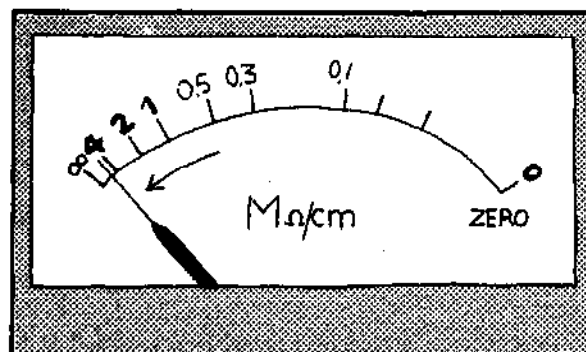
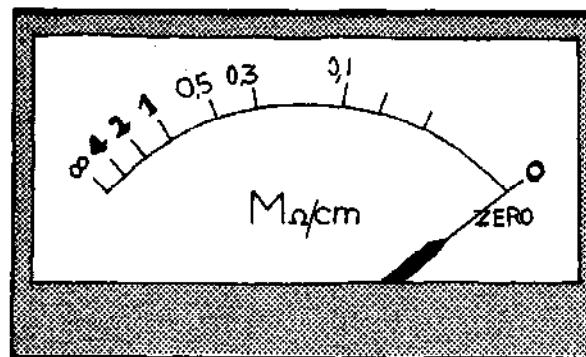

2. Apparatus without control dial

Using an indicator paper, determine:

- the pH of the ordinary water fed into the apparatus
- the pH of the demineralized water that flows out at the other end.

If the pH remains the same (usually below 6.5), the resin is no longer active. Good-quality demineralized water should have a pH between 6.6 and 7.0.

An additional check can be made using a 17 g/l (1.7%) solution of silver nitrate (AgNO_3) (reagent No. 43). Pass a weak solution of sodium chloride (cooking salt) through the resin, then carry out the test described above for the quality control of distilled water. If a slight whitish cloudiness appears the resin must be replaced.

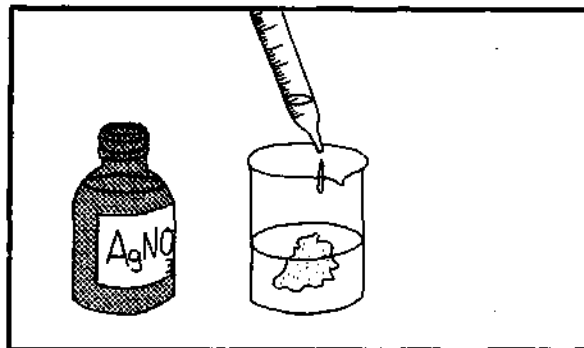

3. Change of colour in resin

Some resins change colour (e.g., they may turn black) when they are exhausted and need to be replaced. Consult the instructions for use supplied by the manufacturer.

4. Replacement or reactivation of ion-exchange resins

This can be done in one of the following ways, depending on the model:

- The cartridge is replaced by another filled with resins and ready for use.
- The column of the apparatus is refilled with resin or a mixture of 2 resins.
- The exhausted resin can be reused following reactivation, i.e., by passing a solution of ammonia through the apparatus.

Follow the instructions for use supplied by the manufacturer.

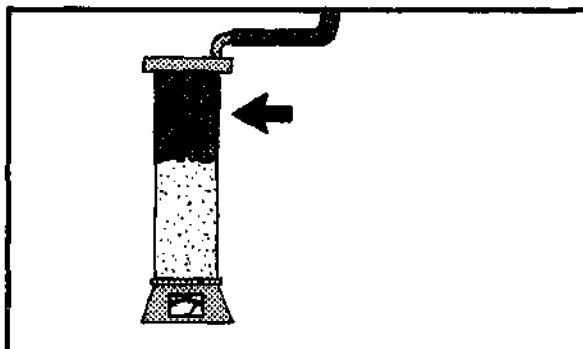

C. Uses for demineralized water

Demineralized water is slightly less pure than distilled water, for it may still contain traces of organic matter. It is, however, pure enough for:

- rinsing glassware before drying
- preparing almost all the reagents used in medical laboratories, including stains.

Distilled water can be saved by preparing demineralized water in the laboratory (especially for rinsing glassware).

BUFFERED WATER

Distilled water is usually acid and demineralized water becomes acid on exposure to the air. For a number of laboratory procedures (preparation of stains, etc.) the pH of the water has to be around 7.0 (neutral water) and kept neutral. This is achieved, if possible, by dissolving buffer salts in the water (buffered water).

A. Materials

- (a) 10 ml and 1000 ml measuring cylinders
- (b) 1000 ml volumetric flask
- (c) Lovibond type comparator (UNICEF ref. No. 931200), if available. Otherwise, pH indicator papers, narrow range
- (d) Distilled (or demineralized) water
- (e) Bromothymol blue indicator
- (f) Disodium hydrogen phosphate ($\text{Na}_2\text{HPO}_4 \cdot 2\text{H}_2\text{O}$), hydrated
- (g) Potassium dihydrogen phosphate (KH_2PO_4), anhydrous.

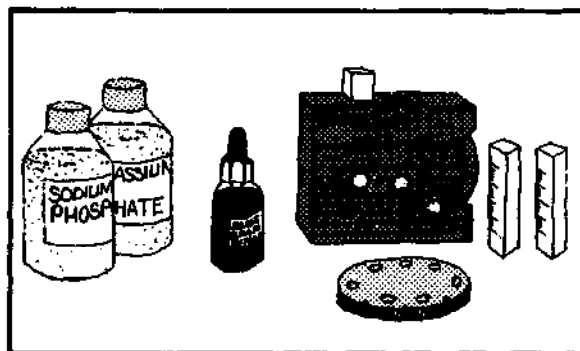

B. Method

1. Weigh out 3.76 g of disodium hydrogen phosphate accurately.
2. Transfer the chemical to a 1000 ml volumetric flask through a funnel.
3. Rinse out the weighing container into the volumetric flask several times with water. Rinse the funnel into the flask.
4. Weigh out accurately 2.1 g of potassium dihydrogen phosphate and proceed as in 2 and 3.
5. Add a little more water and mix the solution until the chemicals are dissolved.
6. Complete to the 1-litre mark with water.
7. Replace the flask stopper and mix the solution well.
8. Store the solution in a white glass reagent bottle and keep in a refrigerator (reagent No.12).

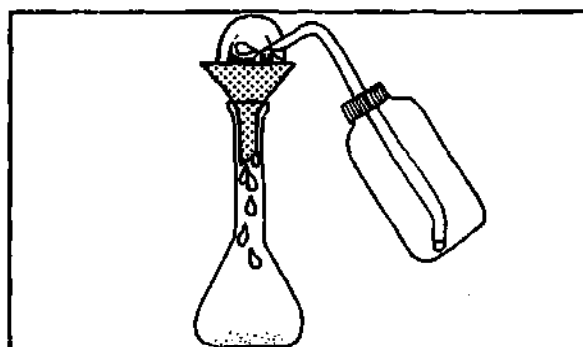
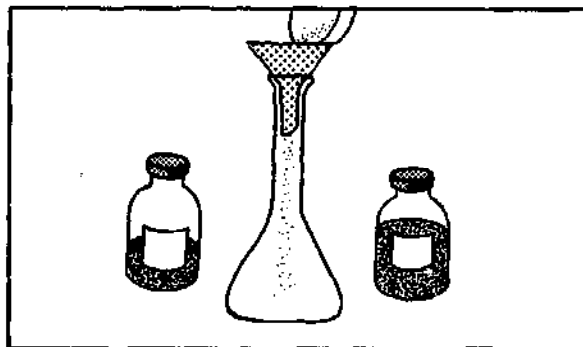

9. Pipette into a comparator tube:
- 10ml of the buffered water
 - 6 drops of bromothymol blue.
- Mix.

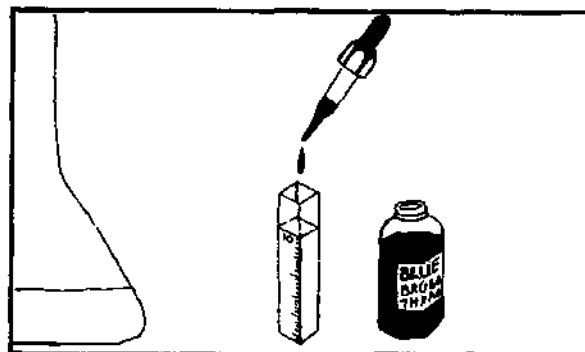

10. Place this tube (containing buffered water and indicator) in the comparator (tube 1).
Place beside it another tube containing water alone (tube 2).

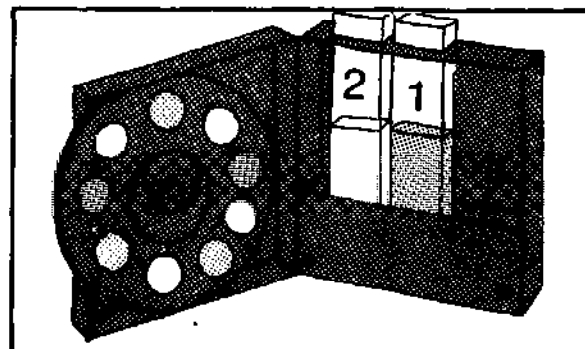

11. Compare the colour of tube 1 (seen through window 1) with the colour of the disc seen through window 2.
Turn the disc until both windows show the same colour.
Then read off the pH shown at the bottom right hand corner.

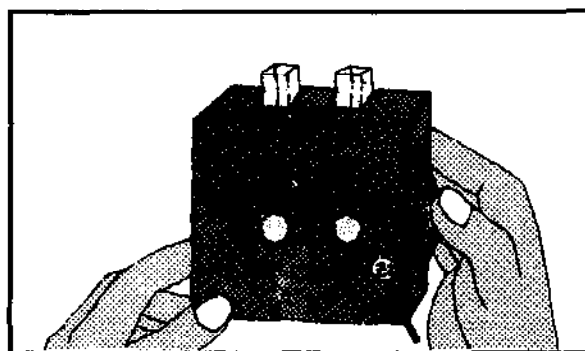

12. *pH 7.0 to 7.2*: the buffered water is satisfactory.
pH below 7.0: the water is acid.
If the water is acid make a fresh solution, using distilled water that has been boiled for 10 minutes in an uncovered round flask (this gets rid of the carbon dioxide).

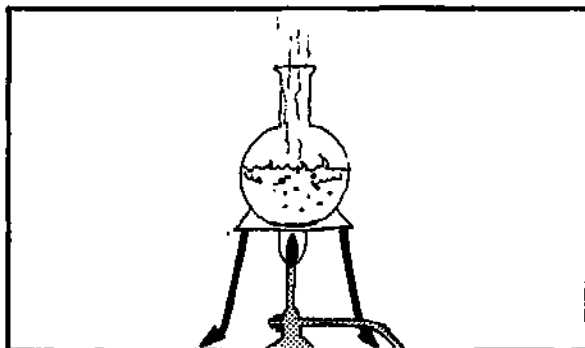

13. If the water is still acid after boiling:
- add 5 drops of phenol red for every litre of water
 - neutralize by adding a 2 g/l (0.2%) solution of sodium carbonate, one drop at a time, until the water turns pink.

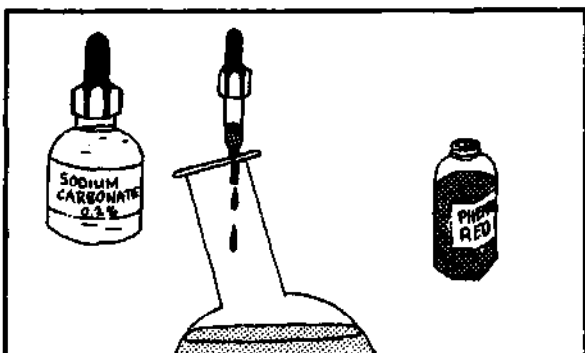

14. *pH above 7.2*: the water is alkaline.

Add 5 drops of phenol red for every litre of water.

Neutralize by adding a 5 g/l (0.5%) solution of acetic acid, one drop at a time, until the water turns orange.

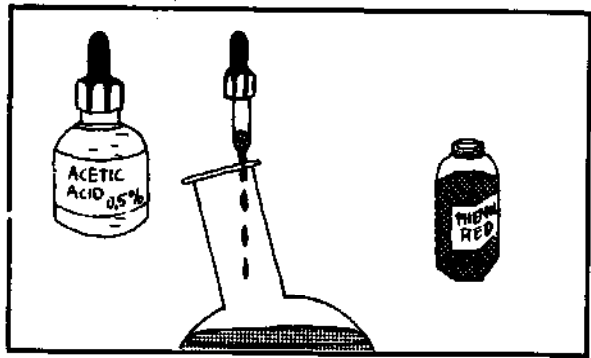

If no phosphate compounds are available:

- neutralize distilled or demineralized water directly, as shown in steps 12-14 above.

If no Lovibond comparator is available:

- use pH indicator papers (see instructions for use on page 309).

Note: The pH can also be corrected by adding small quantities of the buffer salts:

- disodium hydrogen phosphate to increase the pH if the water is acid (pH below 7.0)
- potassium dihydrogen phosphate to reduce the pH if the water is too alkaline (pH above 7.2).

10. Making Glass Equipment

Glass is produced by the fusion at a very high temperature of a mixture of sand and potassium (or sodium). This forms a silicate (*ordinary soda-lime glass*). Sometimes boric acid is added to the ingredients to produce borosilicate glass (Pyrex, etc.), which is less brittle and more resistant to heat. Certain pieces of equipment can be made in the medical laboratory by heating ordinary glass.

A. MATERIALS

1. Hollow glass tubing:
 - external diameter: 4–8 mm
 - thickness of wall: 0.9–1.0 mm
2. Glass rods:
 - diameter: 4–8 mm
3. Glass cutter, diamond pencil or file
4. Cloth
5. Bunsen burner (or, better, a small gas or petrol blow-lamp).

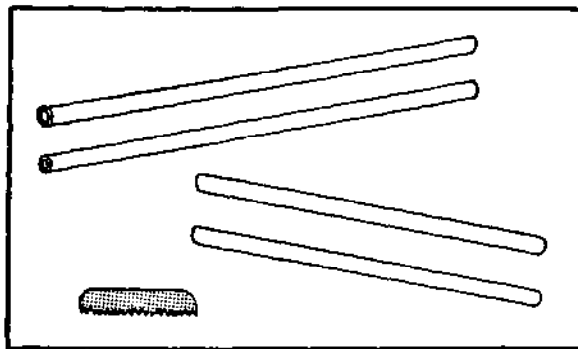

B. MAKING A PASTEUR PIPETTE

1. Use glass tubing 4–6 mm in diameter.
Using the file, mark off the required lengths of tubing:
 - 15 cm for small pipettes
 - 18–25 cm for large pipette:Etch the mark right round the tube, forming a circle.

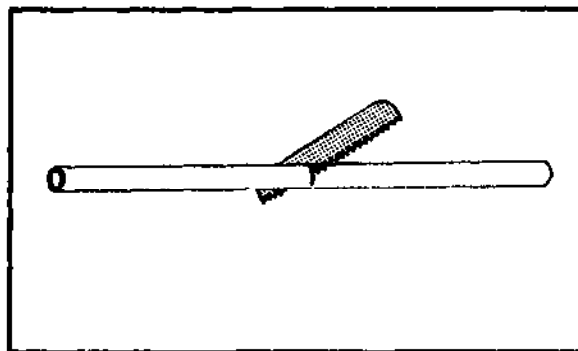

2. Wrap the part to be broken in a cloth. Hold the tube with both hands, one thumb on either side of the etched mark. Snap by pressing with your thumbs.

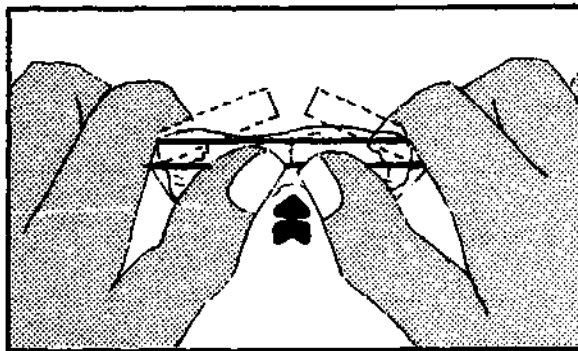

3. Round off the end of each piece of tubing as follows:
 - heat the end, holding the tube almost vertical just above the blue flame of the burner
 - keep turning slowly
 - stop when the glass becomes red hot.

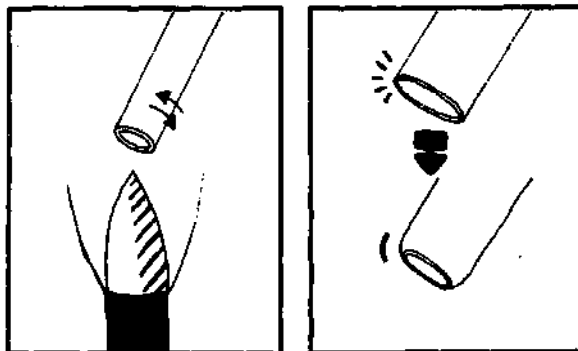

4. Stand the tubes in a beaker or a can, heated ends up, and leave to cool.

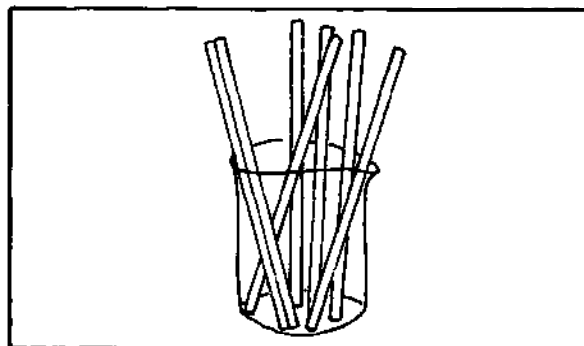

5. Wash all the pieces of tubing prepared (following the instructions given on page 30).
Rinse and dry.

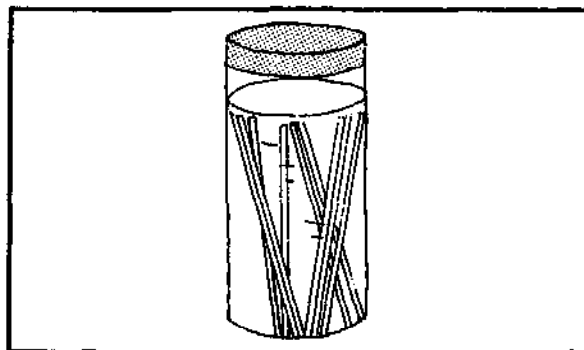

6. Pulling the pipette is carried out as follows:
- heat the middle of the length of tubing over the blue flame
 - keep rotating until the glass becomes reddish.
- At this moment the flame will turn yellow.

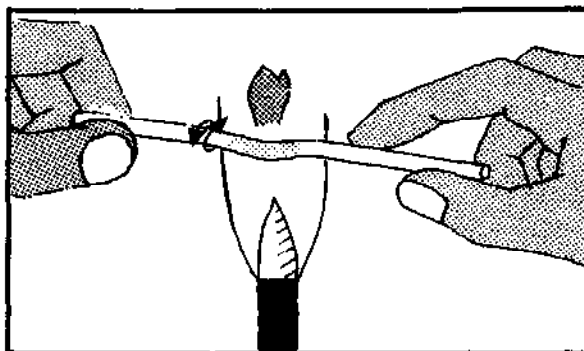

7. Remove the tubing from the flame, still rotating continuously, and pull the 2 ends apart slowly, keeping your hands perfectly level. The glass stretches.
- Pull to the length required (10-20 cm).

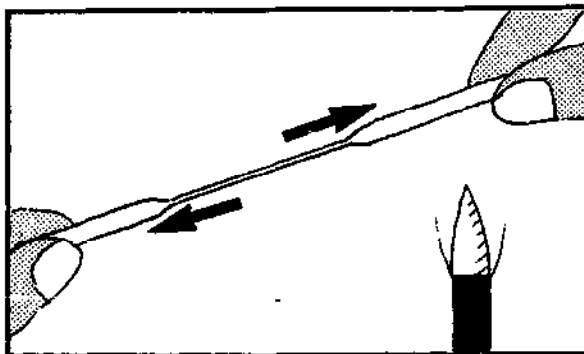

8. Leave to cool.
- Cut off the drawn portion at the exact length required.
- Round off the sharp edges by holding them for a few seconds in the flame.
- Alternatively, separate and seal the two pipettes by heating the pulled-out portion in the flame.

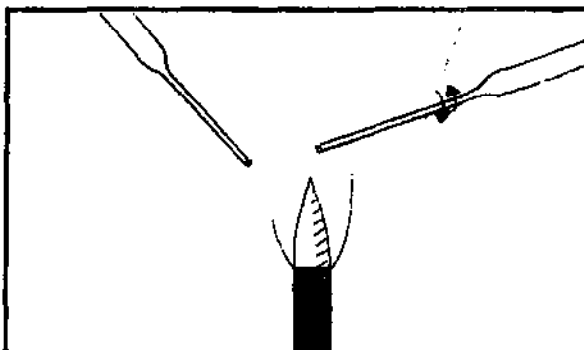

C. MAKING A STIRRING ROD

1. Use a solid glass rod about 5 mm in diameter.

Cut the rod into lengths of 15, 20 or 25 cm according to requirements, using a file. The cutting technique is the same as for glass tubing.

2. Round off the ends by rotating them over the blue flame of the burner, until about 1 cm of the rod is bright red.

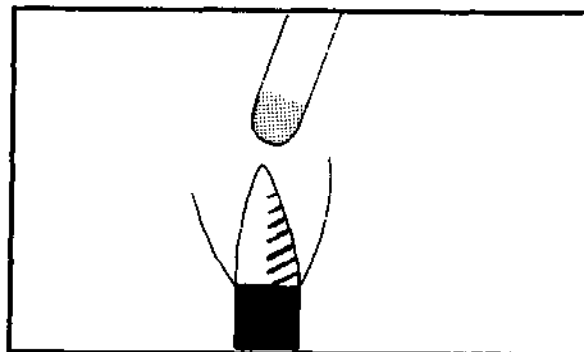

3. Flatten the heated end against the (dry) tiled working surface with a 500 g or 1 kg weight.

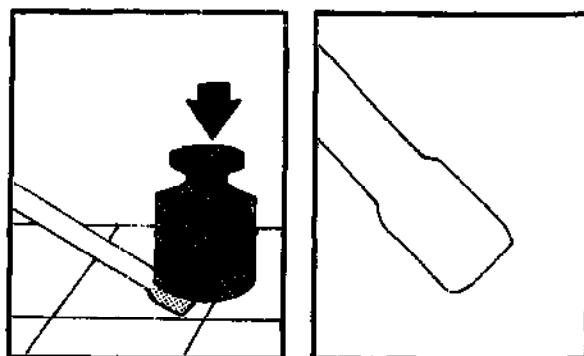

4. Heat the other end and press it gently down on the tiled surface.

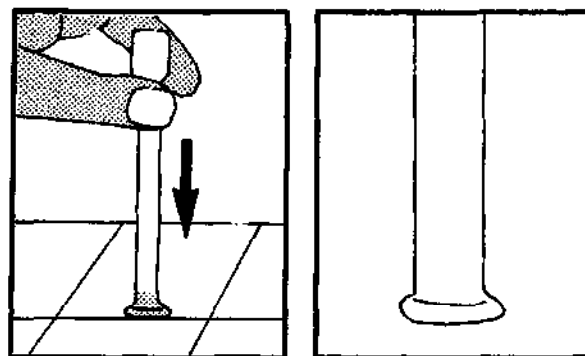

Glass rods can be used to decant liquids or to pour them slowly.

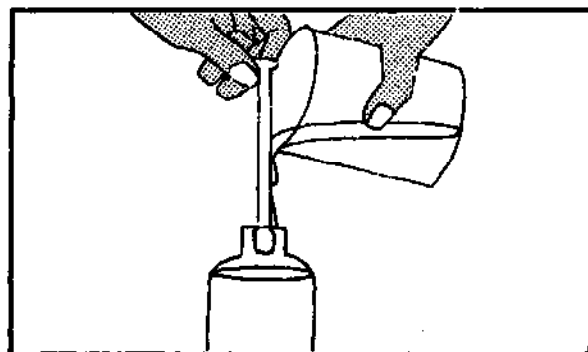

D. BENDING GLASS TUBING

1. Heat the spot where the bend is to be made, rotating the tubing over the flame until the glass turns pale red and sags.

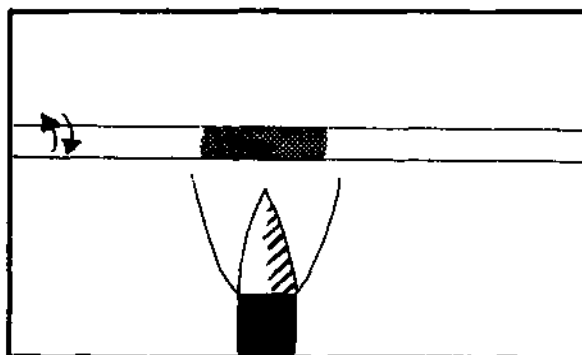

2. Bend slowly to make a right angle (follow the corner of a tile).

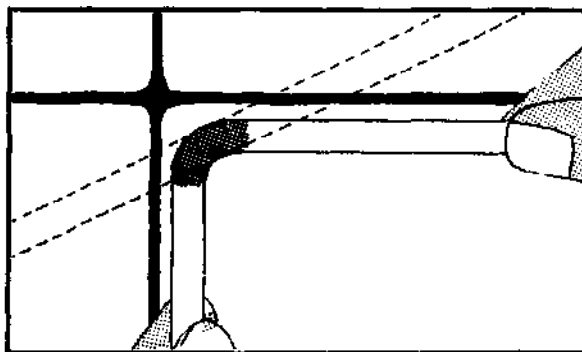

Poor bends

- (A) The glass was too hot.
(B) The glass was not hot enough.

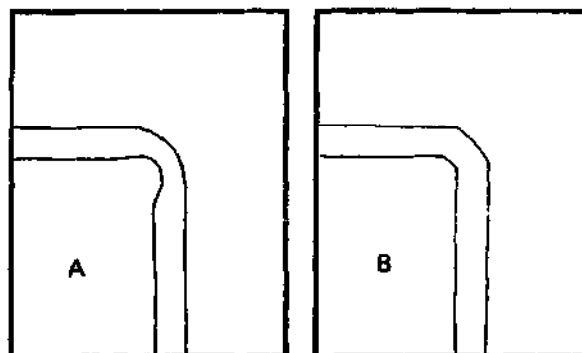

E. MAKING A WASH BOTTLE

You need:

- a round flask
- two pieces of glass tubing
- a cork or rubber stopper.

Pierce the stopper with a cork borer. Moisten the ends of the tubing with a few drops of water (for cork) or glycerol (for rubber) before inserting them in the holes. Protect your hand with a cloth.

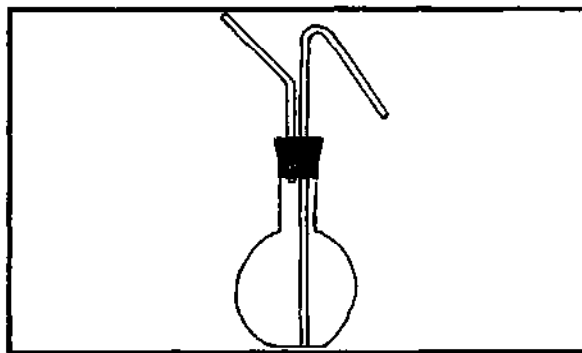

11. Specimen Containers

Different types of containers are used for the collection of specimens such as stools, blood, urine and sputum in the laboratory.

I. CONTAINERS FOR STOOLS

See pages 114 and 268.

II. BOTTLES AND TUBES FOR COLLECTING BLOOD SPECIMENS

A. Without anticoagulant

- Use clean dry tubes of 5-20 ml capacity, depending on requirements.
- Draw off the serum following clotting and centrifuging (see page 285).
- If the serum is to be sent to another laboratory, sterilize tubes and bottles.

The best type of tube to use is one that can be centrifuged: this avoids excessive handling of the specimen.

B. With anticoagulant

1. Anticoagulants for haematological tests

(a) EDTA dipotassium salt solution

Put 0.5 ml of the solution (reagent No. 18) in each of a series of 5 ml bottles (or 0.2 ml in 2 ml bottles). Leave the open bottles to dry at room temperature or place them in an incubator at 37°C if one is available. Use for:

- blood cell counts
- haemoglobin estimation
- blood grouping.

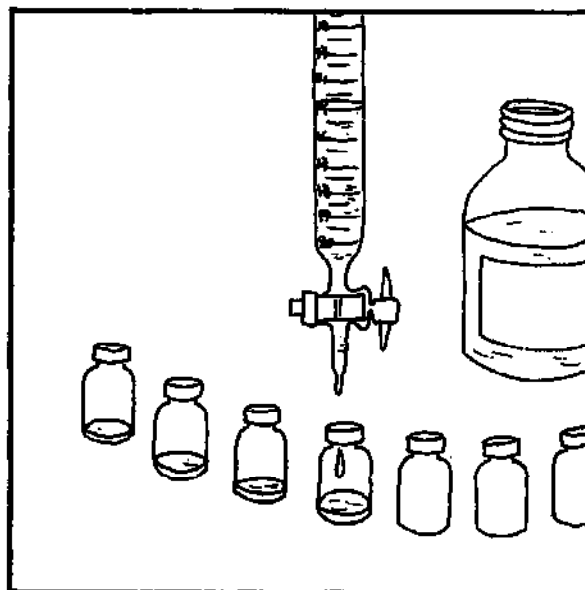

(b) *Heparinized tubes*

This anticoagulant is expensive and not very stable in hot climates. Heparinized tubes are usually obtained commercially or prepared by central laboratories and are already marked to show the level to which blood should be added.

(c) *3.8% trisodium citrate*

Preparation: see reagent No. 54.

Used for the determination of the erythrocyte sedimentation rate.

Use 1 ml trisodium citrate solution per 4 ml of blood (or 0.4 ml per 1.6 ml blood).

Important: Never carry out a blood cell count on citrated blood.

2. *Anticoagulant for biochemical tests*

The usual choice is:

- sodium fluoride (NaF).

Use 10 mg of fluoride powder per 10 ml blood, or 2 mg per 2 ml blood.

Used for:

- blood glucose estimation
- blood urea estimation (certain techniques).

Warning: Sodium fluoride is a poison.

3. *Precautions to be taken when using anticoagulants*

(a) Mix as soon as the blood is collected by inverting the bottle several times gently and evenly. *Do not shake.*

(b) Use clean bottles. Dry before adding anticoagulant. **Warning:** *Traces of detergent will dissolve the red blood cells.*

(c) Store bottles containing anticoagulants in a dry place. EDTA dipotassium salt solution and sodium fluoride are stable at room temperature but trisodium citrate and heparin must be kept in the refrigerator.

(d) Employ the correct proportions. Use bottles and tubes with a graduation mark, or stick on a label so that its upper edge corresponds to the required amount of blood (2 ml, 5 ml, etc.).

III. BOTTLES FOR COLLECTING OTHER SPECIMENS

The most satisfactory procedure is for patients to pass urine specimens close to the laboratory. Use clean dry wide-mouthed Erlenmeyer flasks of 250 ml capacity or clean wide-mouthed bottles for direct examination and routine biochemical tests (see page 305).

Collection of water for bacteriological examination (see page 279).

Bottles for collecting cerebrospinal fluid (see page 350).

IV. BOXES AND JARS FOR COLLECTING SPUTUM SPECIMENS

Glass, screw-top jars or disposable plastic jars with lids can be used, or small cartons can be made in the laboratory using cardboard and a stapler. These cartons can be used once only for sputum collected *in the laboratory*.

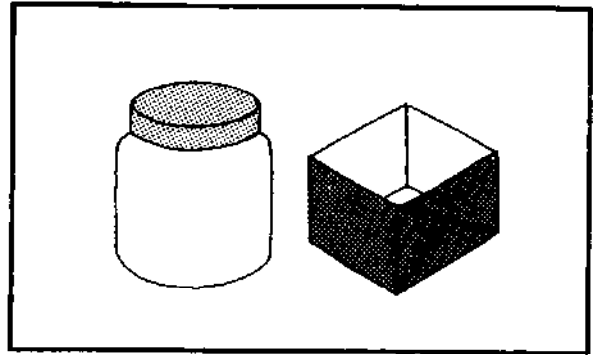

1. Cut out pieces of cardboard 18 cm square and fold them as shown in the diagram:
 - first from corner to corner
 - then into 9 equal squares.

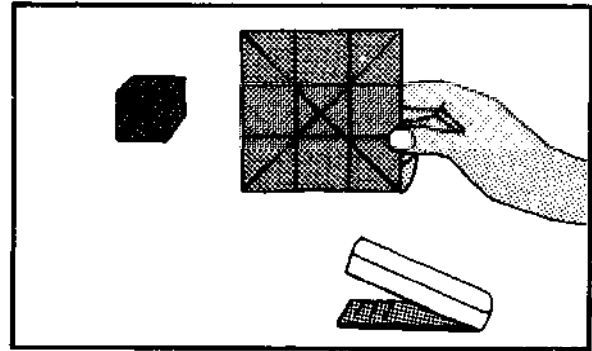

2. Fold the diagonal creases in each corner square inwards.

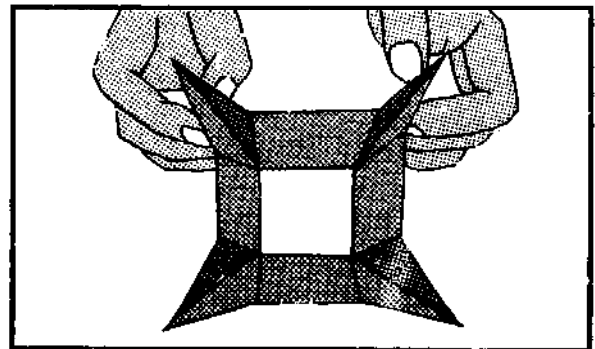

3. Fold 2 of the corners back against one side, and the other 2 against the other side.

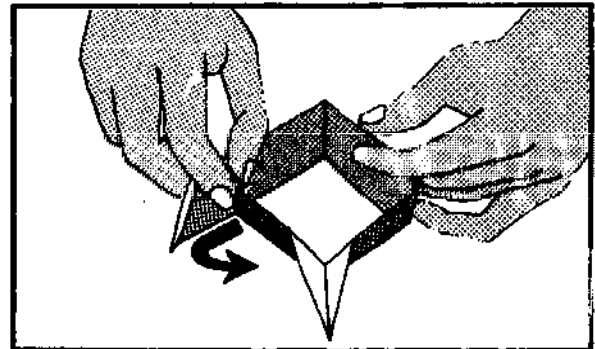

4. Staple the 2 folded corners on each side of the box, which is now ready to receive the specimen.

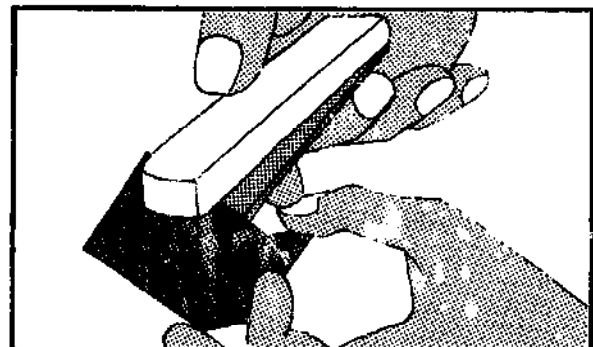

5. Burn these cartons and plastic jars after use, as described on page 39.

12. Dispatch of Specimens to a Reference Laboratory

The peripheral laboratory sends specimens to reference laboratories or more specialized laboratories for examinations that cannot be carried out locally. For example:

- serological examinations for treponematoses or typhoid; culture of stools for detection of the cholera vibrio;
- histological examination of biopsy material.

The following table shows, for each type of specimen and each examination:

- which container and preservative (where necessary) to use
- how much of the specimen to send
- how long the specimen will keep.

Type of specimen	Laboratory examination	Container and preservative	Amount of specimen	Preservation time
SPUTUM	Culture of tubercle bacillus	45-ml bottle with 25 ml of 0.6% solution of cetylpyridinium bromide (see page 255)		10 days
	Other organisms	No preservative		2 hours
THROAT SWABS	Culture of diphtheria bacillus	Tube of coagulated serum (see page 273)		24 hours
		Cotton wool swab		4 hours
CSF	Culture of meningococcus	Special bottle containing "Transgrow" medium (see page 350) or Stuart medium		4 days 24-48 hours
		CSF in a sterile airtight bottle sent in a vacuum flask filled with water at 37 °C	2 ml	12 hours
	Other organisms	Sterile bottle	2 ml	2 hours
	Chemical tests (glucose, protein, chloride, etc.)	Sterile bottle	2-4 ml	2 hours
URETHRAL PUS	Culture of gonococcus	See page 245		
		Special bottle of "Transgrow" medium or Stuart medium	1 swab of pus 1 swab of pus	4 days 24 hours
OTHER PUS	Bacteriological culture	1 sterile tube	1 ml	2 hours

Type of specimen	Laboratory examination	Container and preservative	Amount of specimen	Preservation time
BLOOD	Blood cell counts	EDTA dipotassium salt solution (reagent No. 18)	5 ml	12 hours
	Blood grouping	EDTA dipotassium salt solution or tube without anticoagulant	5 ml	12 hours
	Cross-matching	Tube without anticoagulant	5 ml	12 hours
	Prothrombin time (Quick's test)	0.5 ml trisodium citrate (state the anticoagulant used on the label)	4.5 ml	2 hours
	Thrombotest	Commercial plastic tubes containing 0.5 ml of 3.8% trisodium citrate (reagent No. 54)	4.5 ml	24 hours
	Serological examination for treponemes, salmonellae, etc.	Sterile tube without anticoagulant Send serum or dried drops of blood as appropriate (see pages 285 and 287)	10 ml	3 days
	Serological examination for viral infections	Send successive specimens of serum: - blood taken at the onset of the disease - blood taken after 2-4 weeks (to detect increase in antibodies)		
	Tests for glucose	5 mg sodium fluoride	5 ml	2 hours
	Other biochemical tests: bilirubin* cholesterol serum iron lipids proteins liver function uraemia	Bottle without anticoagulant Send serum	10 ml	48 hours
	Enzyme estimations: amylase phosphatases transaminases	Bottle without anticoagulant	5 ml	2 hours
Blood culture	Special sterile flask containing 50 ml broth raised as quickly as possible to 37 °C after adding the specimen	5 ml	24 hours	
STOOLS	All stool cultures including cholera vibrio	Cary-Blair transport medium (reagent No.14)		4 weeks
	All stool cultures except cholera vibrio	Buffered glycerol saline (reagent No.10)		2 weeks
	Examination for parasite eggs, larvae and cysts	30-ml bottle containing 15 ml of 10% formaldehyde solution (reagent No.26)	About 5 ml	Keeps almost indefinitely

* For bilirubin, store the specimen away from the light.

Type of specimen	Laboratory examination	Container and preservative	Amount of specimen	Preservation time
STOOLS (cont.)	Amoebae: vegetative forms	10-ml tube thiomersal, iodine and formaldehyde solution (reagent No.39) or PVA (see pages 173 and 174)		Keeps almost indefinitely
URINE	Biochemical tests: glucose, protein, acetone, etc.	Clean dry bottle (sealed)	20-50 ml (depending on number of tests)	2 hours
	Urinary deposits	Clean dry bottle or bottle containing 8 drops 10% formaldehyde solution (reagent No.26)	30 ml	2 hours
			30 ml	2 days
	Schistosome eggs	For concentration: 2 ml commercial bleach and 1 ml hydrochloric acid	100 ml	Keeps almost indefinitely
	Bacteriological culture	Sterile bottle	20 ml	1 hour
	Pregnancy test	Sterile bottle	20 ml (first urine of day)	12-24 hours (or 4 days in refrigerator)
	Hormone estimation	Bottle containing preservative supplied by the biochemistry laboratory with instructions regarding method of collection, amount needed and transport time		
Urinary calculus	Clean dry bottle		Keeps almost indefinitely	
BIOPSY TISSUE FROM AN ORGAN	Histological examination	See page 75 for details The following fixatives are used: - formaldehyde saline (reagent No.25) - Zenker fixative (reagent No. 61)		
HAIR, NAILS, CUTANEOUS TISSUE	Examination for fungus (mycosis)	Paper envelope or screw-capped bottle (do not use tubes with rubber stoppers or plugged with cotton wool)		At least a week (sometimes longer)

PACKING

Always observe the regulations in force in the country.
Double pack specimens.
Place the specimen in the bottle or tube and seal hermetically (fixing the stopper with sticking-plaster).
Check that the bottle is labelled with the patient's name.

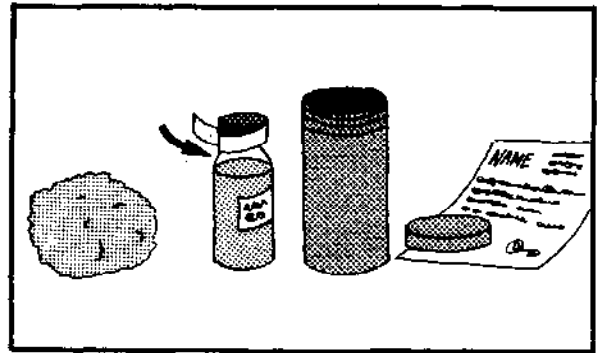

Place the sealed bottle in an aluminium tube with a screw cap. Wedge it in the tube with absorbent cotton wool.

Wrap the request form around the metal tube.
It should show:

- the patient's **NAME** (written in capital letters)
first name, sex and age
- the nature of the specimen
- the examinations required (with the physician's diagnosis, where appropriate).



Place the metal tube in a strong cardboard or wooden box for dispatch. Wedge it tightly with non-absorbent cotton wool.

Mark on the label on the outside of the box:

URGENT FRAGILE

and if appropriate:

INFECTIOUS MATERIAL

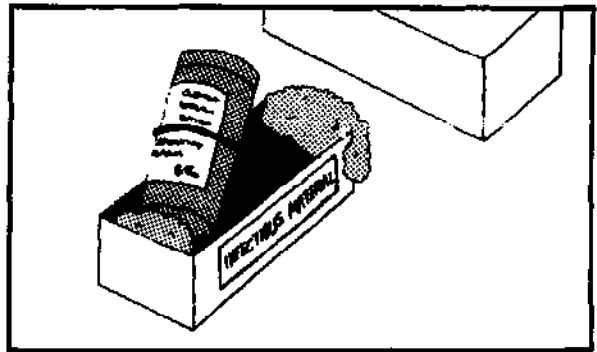

13. Fixation and Dispatch of Biopsy Material for Pathological Examination

Biopsy

To diagnose certain diseases of the organs, the physician removes a piece of tissue with forceps or a special scalpel. The piece of tissue is called a *biopsy specimen*. It is examined under the microscope after a thin section has been cut and treated with a special stain.

Histology – pathology

The cells of tissue and organ biopsy specimens can be studied under the microscope. Microscopical examination of the cells is called *histopathology*.

Pathology is the study of the changes and deformities in the cells caused by various diseases. This type of examination can be most important, particularly for the diagnosis of cancer.

The laboratory technician must be able to *fix the biopsy specimen*, to ensure that it is properly dispatched and arrives at the pathology laboratory in a good state of preservation.

A. FIXATION OF BIOPSY SPECIMENS

The piece of tissue is immersed in a fixative fluid. This procedure should preserve the tissue in a state as close to the living state as possible, by protecting it against bacterial action, autolysis, shrinkage, etc.

The most suitable type of specimen bottle used is a plastic-capped bottle with a wide mouth (pillbottle). It is obtainable in 60 ml, 45 ml, 30 ml and 15 ml sizes.

Fixatives

The most simple to prepare are:

- Formaldehyde saline (reagent No. 25)
 - Zenker fixative (reagent No. 61). Just before use, add 5 ml glacial acetic acid to every 100 ml of Zenker solution.
-

B. FIXATION TECHNIQUE

1. Amount of fixative

The volume of fixative required is about 50 times the volume of the biopsy tissue. Biopsy tissue is normally 3–5 mm thick (if it is thicker, fixation is difficult or impossible).

The area of the specimen, however, can vary and this is what determines the amount of fixative to be used.

Amount of fixative:

- specimen 0.5 x 0.5 cm: 6–10 ml
- specimen 0.5 x 1 cm: 10–15 ml
- specimen 1 x 1 cm: 20–25 ml
- specimen 2 x 1 cm: 30–40 ml
- specimen 2 x 2 cm: 90 ml.

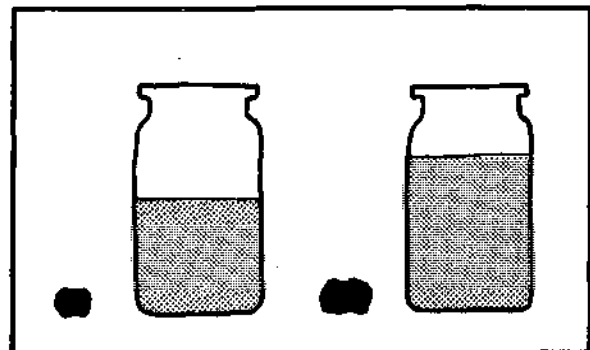

2. Preparation

It is essential to act quickly on receipt of the biopsy specimen. Never leave it until later.

First pour the fixative into the bottle.

Then pick up the biopsy specimen on a piece of stiff paper (do not use forceps, which may damage the tissue).

Drop the specimen into the bottle.

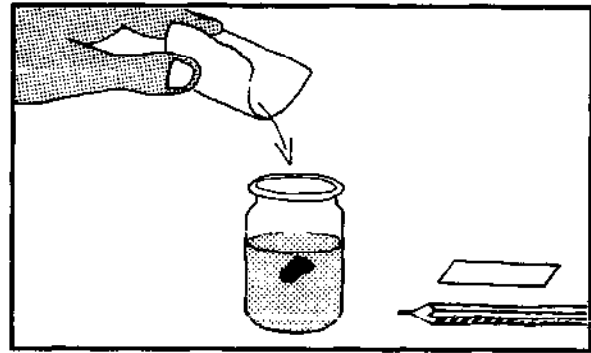

3. Labelling

Cut out a small rectangle (about 3 x 1 cm) of stiff paper. Using a *lead pencil*, write on it the name of the patient, the date of collection, etc. Place the slip of paper in the bottle with the fixative.

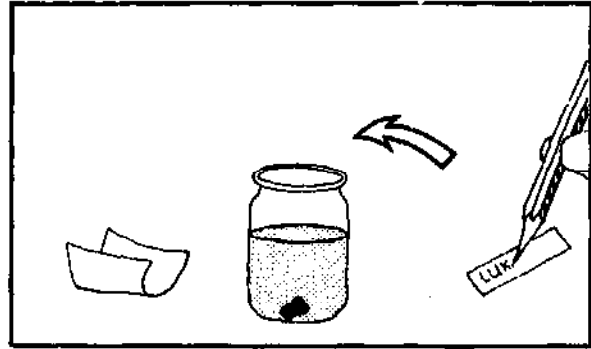

4. Fixation time

This will vary according to the fixative used. With the two fixatives mentioned above, 24 to 48 hours may pass before the specimen is cut and stained, but it can be left in the liquid for at least a week.

Fixed material should be dispatched to the pathology laboratory without delay, but a long transit period will not result in the deterioration of specimens.

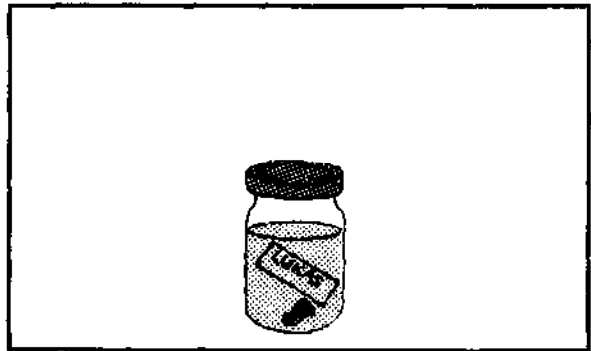

5. Dispatch

Secure the cap or stopper of the bottle with adhesive plaster.

Place the bottle in a metal tube or box, together with the report form (name, date, disease suspected, type of tissue sent, investigation requested).

Then place the tube or box and report in a small wooden or cardboard box, pack well with non-absorbent cotton wool and dispatch immediately.

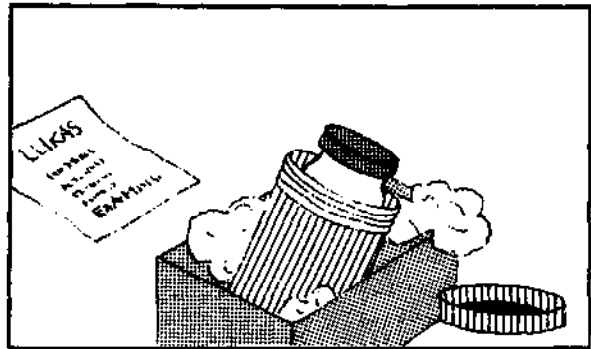

C. HISTOLOGICAL EXAMINATION TECHNIQUE: GENERAL OUTLINE

1. *Fixation of specimen: described on page 75*
2. *Embedding the tissue*

After being treated with various substances to dehydrate and clarify it, the piece of tissue is embedded in a solid block of paraffin wax.

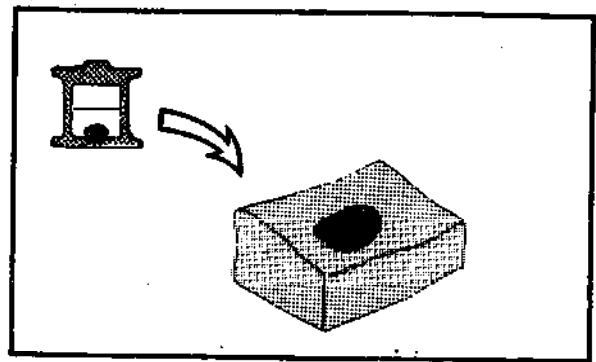

3. *Cutting*

The block in which the tissue is embedded is sliced into sections thin enough to permit examination under the microscope. The instrument used to cut the sections is called a "microtome" and is capable of cutting the very thin sections needed. The average thickness of the sections is 3–5 μm (micrometres).

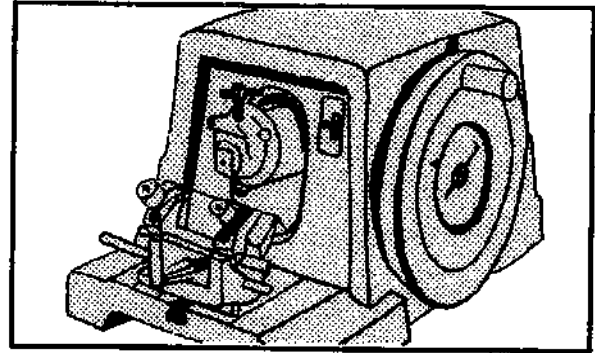

4. *Staining*

The sections are placed on slides and dried and the paraffin wax is removed with a solvent (e.g. xylene). Then the sections are dehydrated and stained. There are various kinds of stain; the pathologist makes his choice depending on the nature of the specimen and the disease suspected.

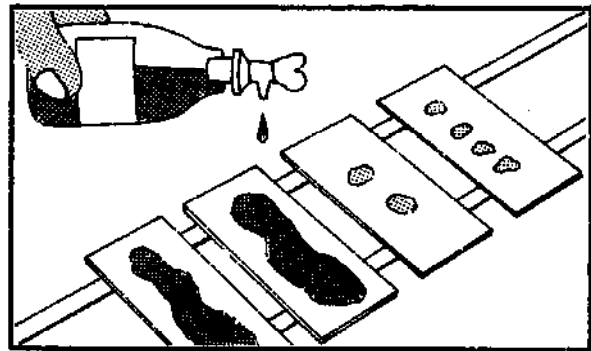

5. *Alternative procedure: frozen sections*

For rapid diagnosis the tissue is treated with a freezing microtome using liquid gas, which freezes the fresh unfixed specimen and cuts sections at the same time. This procedure is used during surgical operations.

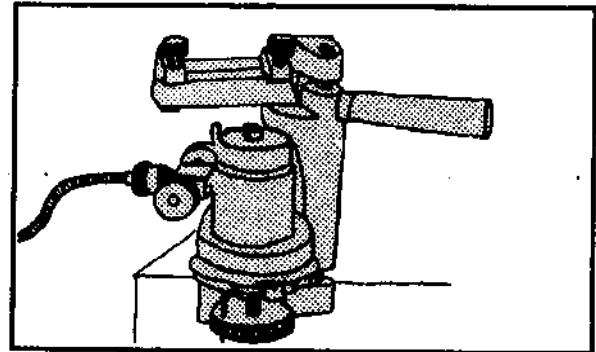

Dispatch of an organ or tumour

The same fixatives are used. Immerse the organ or tumour completely in a large bottle filled with fixative.

14. Registration of Specimens; Laboratory Records and Monthly Reports

All specimens must be registered and given numbers when they arrive at the laboratory, and the results of all investigations must be recorded. This will:

- avoid the risk of getting the specimens mixed up
- make it possible to look up a result
- make the results available for the promotion of public health.

The laboratory should have:

- examination request forms that accompany the specimen
- a register for recording details concerning the specimen and the results obtained
- monthly report forms.

A. NUMBERING THE SPECIMENS

Give each specimen a number as soon as it is received
Write this number immediately:

- on the request form
- on the specimen container (use grease pencil)
- on every test-tube used for the specimen
- on every microscope slide used for the specimen.

This will prevent any mistakes.

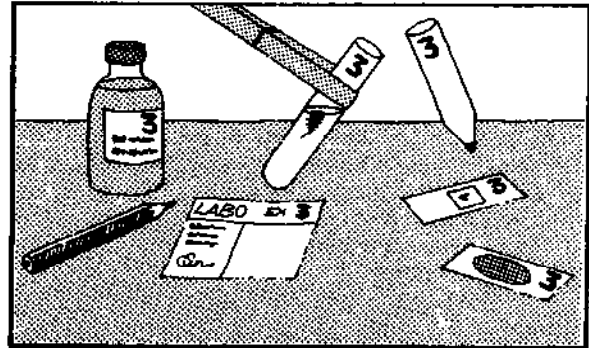

B. THE LABORATORY REGISTERS

The registers should be a series of notebooks with numbered pages and with strong hard covers. Each specimen should be numbered and recorded in the register for that type of specimen.

The following series of registers are suggested:

- Haematology
- Blood chemistry
- Blood transfusion
- Blood donors
- Parasitology
- Urine analysis, CSF, pregnancy tests
- Bacteriology, mycology, water analysis
- Serology (if the samples are few incorporate in the bacteriology register, otherwise keep a separate book).

The examples of these registers given on the following pages should be modified according to requirements. It may be necessary, for instance, to have separate registers for urine analysis, CSF, and pregnancy tests.

It is both helpful and time-saving to have rubber stamps made for the more common tests and results. Examples:

For VDRL: NON-REACTIVE

For parasitology: NO. OF OVA OR PARASITES SEEN

For bacteriology: NO. OF LEUKOCYTES _____

 NO. OF ERYTHROCYTES _____

 NO. OF EPITHELIAL CELLS _____

 NO. AND TYPE OF ORGANISMS _____

HAEMATOTOLOGY REGISTER*

Date	No.	Patient	Sent by	Hb ^a (g/l)	Erythrocytes				Retic. no. fract. ^b (x 10 ⁻²)	Mean ery. Hb conc. (g/l) ^c	Leukocytes					Malaria	Other tests	Results sent (date)	
					Vol. fract.	Sed. rate (mm/h)	No. conc. (x 10 ¹² /l)	Morphology			No. conc. (x 10 ⁹ /l)	Type number fraction							
												Neut.	Lymph.	Mono.	Eo.				Other
1 Jan.	1	MW...R	Dr R.	117	-	23	-	Aniso ++ Poik + Poly ++	124	-	4.2	0.48	0.35	0.13	0.04	Many <i>P. falciparum</i> trophs		1 Jan.	
1 Jan.	2	KA...S	OPD	58	0.21	52	-	Aniso ++ Poik ++ Hypo ++ Poly +	71	276	5.7	0.32	0.56	0.04	0.08	Moderate no. of <i>P. falciparum</i> trophs		1 Jan.	
1 Jan.	3	KI...A	Ward 1	125	-	-	-	-	-	-	-	-	-	-	-			1 Jan.	

* For explanation of the column headings, see the relevant sections of the text. The use of abbreviations in these headings is necessitated by limitations of space and is not to be taken as a recommendation that they be used in practice.

^a Haemoglobin may also be reported in terms of substance concentration: the column heading would then be "Hb(Fe) (mmol/l)". In this case, the values quoted in the examples (no. 1 and 2) would be 7.3 and 3.6, respectively.

^b Reticulocytes are here reported in terms of number fraction. They may also be reported in terms of number concentration, i.e. the number per litre. In this case the column heading would read "reticulocyte number concentration (x 10⁹/l)" and the values would depend on the erythrocyte number concentrations (which are not reported in the examples given in the table).

^c Mean erythrocyte haemoglobin concentration may also be reported in terms of substance concentration: the column heading would then be "Mean ery. Hb(Fe) conc. (mmol/l)". In this case, the example quoted (no. 2) would have a value of 17.1.

BLOOD CHEMISTRY REGISTER

Date	No.	Patient	Sent by	Urea (mmol/l)	Glucose (mmol/l)	Other tests	Results sent (date)
1 Jan.	1	KI...A	Ward 1	12.8	-		1 Jan.
1 Jan.	2	MW...A	Dr G.	-	5.3		1 Jan.

BLOOD TRANSFUSION REGISTER

Date	Number	Patient's name	Sent by	Patient's blood group							Group ABO Rhesus
				Anti-A	Anti-B	Anti-AB	Anti-D	A cells	B cells	O cells	
1 January	1	CH ... P	Ward 6	+	-	+	+	-	+	-	A Pos
1 January	2	MW... A	Ward 3	-	+	+	+	+	-	-	B Pos
1 January	3	KI ... T	Ward 2	-	-	-	+	+	+	-	O Pos
1 January	4	SI ... P	Ward 6	+	+	+	+	-	-	-	AB Pos

URINE ANALYSIS REGISTER

Date	Number	Patient's name	Sent by	Relative density	pH	Direct Examination
1 January	1	MO... C	Dr R	1.008	7.0	Leuko 20-30/HPF Few hyaline casts
1 January	2	LA... B	Med. Ward 2	1.012	6.8	Leuko 5-10/HPF Few epith. cells

CSF EXAMINATION (in urine analysis register or separate)

Date	Number	Patient's name	Sent by	Macroscopic appearance	Direct Microscopic Examination
2 January	1	FE... W	Dr G	Cloudy	Gram: many leukocytes A few Gram-neg. intracellular diplococci
17 January	2	LE... E	Dr C	Clear	-

Group of donor	Donor bottle number	Amount cross-matched	Crossmatch				Haemolysin test for GPO donors	Signature
			Saline	Albumin	Auto Saline	Auto Albumin		
A Pos	5	540 ml	-	-	-	-		
B Pbs	9	250 ml	-	-	-	-		
O Pos	4	540 ml	-	-	-	-		
O Pos	7	540 ml	-	-	-	-	Anti A - No haemolysis Anti B - No haemolysis	

Glucose sugar	Protein	Bile pigments	Urobilinogen	Ketones	Chemical test for blood	Others (pregnancy test, etc.)	Results sent (date)
Neg	Neg	-	-	-	-	-	1 Jan.
+++	Neg	-	-	+	-	Positive	1 Jan.

Leukocytes ($\times 10^9/l$)	Glucose (sugar) mmol/l	Total protein g/l	Pandy test for globulin	Others	Results sent (date)
30	1.5	0.45	+	Neutrophils 0.94, lymphs 0.06	2 Jan.
4	3.3	0.25	Neg	-	17 Jan.

BLOOD DONOR BOOK (small ruled exercise book)

Date	Name of donor	Blood group	Haemoglobin (g/l)	Donor number
1 January	DO . . . M	A Pos	141	1
2 January	LO . . . F	A Pos	132	2
2 January	FE . . . W	B Pos	129	3
4 January	CH . . . A	O Pos	133	4

BACTERIOLOGY REGISTER

Date	Number	Patient's name	Sent by	Specimen	Examination requested	Results	Results sent (date)
1 January	1	AL . . . J	Dr R	Sputum	Smear for TB	No acid-fast bacilli	1 Jan.
1 January	2	RE . . . A	Med. Ward 2	Pus from wound	Gram stain	Many leukocytes, few eryth., few epithelial cells, mod. no. Gram-neg. rods	1 Jan.
1 January	3	TO . . . L	OPD Dr M	Urethral pus	Gram stain	Mod. no. intracellular Gram-neg. diplococci seen; G.C.—positive	1 Jan.
2 January	4	Well on 3rd Street	Sanitarian RB	Water	Bacteriol.	Sent to Regional Public Health Laboratory	2 Jan.
2 January	5	AM . . . C	Dr B	Sputum	Smear for TB	No acid-fast bacilli seen	2 Jan.
3 January	6	LA . . . R	Med. Ward 1	CSF	Gram stain	Occ. leuko, no eryth. seen; occ. epithelial; no organisms seen	3 Jan.

PARASITOLOGY REGISTER

Date	Number	Patient's name	Sent by	Specimen	Examination requested	Results	Results sent (date)
1 January	1	CR ... M	Dr A	Stool	Parasites	Direct: Mod. no. <i>Ascaris lumbricoides</i> ova seen	1 Jan.
1 January	2	RA ... B	Dr C	Stool	Parasites	Direct: No ova or parasites seen. Conc: No ova or parasites seen	1 Jan.
2 January	3	NE ... L	Med. Ward 1	Skin	Oncho	No parasites seen	2 Jan.
2 January	4	MO ... T	Dr R	Stool	Parasites	Occult blood: positive Many trophs. of <i>E. histolytica</i> seen. A few hook-worm ova seen	2 Jan.

SEROLOGY REGISTER

Date	Number	Patient's name	Sent by	Specimen	Examination requested	Results	Results sent (date)
1 January	1	LA ... P	Prenatal clinic	Blood	VDRL	Non-reactive	1 Jan.
1 January	2	RO ... M	Prenatal clinic	Blood	VDRL	Non-reactive	1 Jan.
1 January	3	ME ... R	Prenatal clinic	Blood	VDRL	Non-reactive	1 Jan.
1 January	4	LE ... T	Prenatal clinic	Blood	VDRL	Non-reactive	1 Jan.
1 January	5	BI ... N	Dr M	Blood	VDRL	Reactive, 1:8	1 Jan.
1 January	6	ST ... C	Dr L	Blood	VDRL	Non-reactive	1 Jan.
1 January	7	HA ... J	OPD, Dr A	Blood	VDRL	Non-reactive	1 Jan.
4 January	8	MA ... S	Prenatal clinic	Blood	VDRL	Non-reactive	4 Jan.

C. THE MONTHLY REPORT

At the end of every month the laboratory should submit a monthly report to the director of laboratory services at the central level or, if there is none, to the department of public health at both the provincial and the central level.

Value of the report:

- (a) It helps to keep a check on the laboratory's activities and is useful for adequate staffing, for the ordering of supplies by the central stores, and for the preparation of the budget for laboratory services at the national level. Reports based on the number of tests done are the most suitable for laboratory management.
- (b) It is an aid in public health surveillance of the area covered by the laboratory since it reports the number of positive results obtained for various communicable diseases.

An example of a monthly report is given below.

LABORATORY	
MONTH ENDING	
LABORATORY	
1. Number of examinations carried out	
Haematology — general	1235
Blood chemistry	27
Blood donors	34
Blood transfusion service	38
Urine analysis:	
direct examination	287
chemistry	43
Pregnancy tests	17
CSF:	
direct examination	3
chemistry	3
Parasitology:	
stools	162
blood	802
other	2 (lymph glands for trypanosomes)
Bacteriology:	
Gram stains	63
A-F stains	41
Wayson stains	11
mycology	3
Serology:	
VDRL: qualitative	114
quantitative	16
2. Number of specimens sent to specialized laboratories	
Water for bacteriological analysis	8
Specimens for bacteriological culture	32
Sera for serology	0
Tissue biopsies	2
Other	0
COMMUNICABLE DISEASES RECORD*	
	No. of Positives
1. Bacteriological	
Gonorrhoea	11
Leprosy	0
Plague	0
Tuberculosis	7
2. Parasitological	
Amoebiasis	14
Ascariasis	22
Filariasis	1
Hookworm	80
Malaria	253
Onchocerciasis	0
Schistosomiasis	2

* The list of notifiable diseases varies from country to country. It is established by the central public health authority in the light of:

- (a) international regulations on reporting communicable diseases
- (b) diseases prevalent in the area.

15. Storage, Inventory, Ordering Supplies

A. STORAGE

1. Glassware

Keep glassware on the shelves of a cupboard away from dust. Erlenmeyer and round flasks should be plugged with non-absorbent cotton wool or covered with brown paper (or preferably with thin sheeting of paraffin wax or clinging plastic such as Parafilm or Saran, if available) and arranged by type and size. Graduated pipettes should be kept in drawers divided into sections.

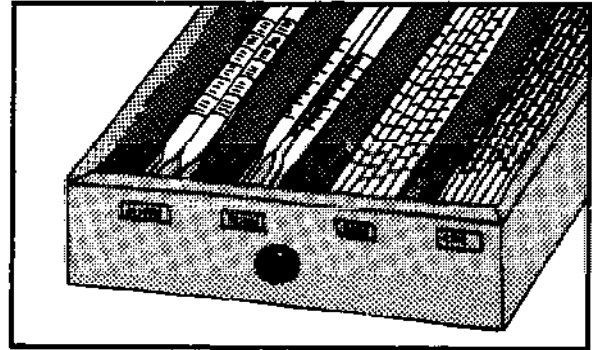

2. Chemicals and reagents

These should be arranged in *strict alphabetical order*, as indicated on page 465.

Acids and inflammable and dangerous chemicals (indicated by appropriately coloured labels) should be stored separately in a special section. Unopened stocks can be kept in crates filled with sawdust.

Poisons (also indicated by appropriately coloured labels) should be stored separately in a locked cupboard.

3. Heavy equipment

Some instruments, e.g. spectrophotometers, can be kept in an air-conditioned room if the climate is hot and humid. For storage of microscopes, pages 24 and 25.

B. STOREKEEPING AND INVENTORY

1. Stock cards

A stock card should be prepared for every chemical, stain, piece of glassware, etc. Here is a sample stock card:

STOCK CARD

Item: Giemsa stain (250 ml bottle)

Item No. 24

ORDERED FROM	ORDERED		RECEIVED		ISSUED		IN STOCK
	Date	Quantity	Date	Quantity	Date	Quantity	
							2 bottles
	1 May	2 bottles	20 May	1 bottle			3 bottles
					10 July	1 bottle	2 bottles
					3 Sept.	1 bottle	1 bottle
	15 June	2 bottles	10 Sept.	2 bottles			3 bottles

When you order an item, indicate:

- in the column headed "Ordered from" - where you sent the order
- in the column headed "Ordered" - the date and the quantity ordered.

When you receive an item, indicate:

- in the column headed "Received" - the date of receipt and the quantity received
- in the column headed "In stock" - the total in stock in the laboratory after the item has been received.

When an item has been used up (or broken), indicate:

- in the column headed "Issued" - the date of issue and the amount issued
- in the column headed "In stock" - the total left in stock after the item has been issued.

Classify the stock cards in strictly alphabetical order and keep them in a box or filing drawer. Each item can be given a number, which is then entered in the stock card after the heading "Item No."

2. Inventory

Make an inventory of all laboratory supplies every 6 months. Count the quantity or number of each item in stock and check that the figure corresponds to the one shown in the "In stock" column of the stock card.

C. ORDERING SUPPLIES

A well organized laboratory should submit an order to the central supply stores every 3 months. To draw up the order, check the stock cards one by one.

It makes it easier to estimate the quantities required if a table such as the following is added to the bottom of each stock card.

QUANTITY USED PER MONTH	Jan.	Feb.	March	April	May	June	July	Aug.	Sept.	Oct.	Nov.	Dec.
19...												
19...												
19...												

In the case of chemicals, stains and reagents, order the quantity used in a 3-month period, taking into account any recent increase or decrease in the amount used. For example:

- 8 bottles of Giemsa stain have been used in a year
- This gives an average of 2 bottles used every 3 months
- Order 2 bottles every 3 months (or 4 bottles every 6 months if orders are submitted twice a year).

Expiration dates

Some reagents (blood grouping antisera, VDRL and other antigens, etc.) have to be used before a certain date. Make a note of the expiration date on the stock card.

16. Electricity: Setting up Simple Electrical Equipment

A mains electricity supply is not essential in a peripheral laboratory; almost all the techniques described in this manual can be carried out without electricity from the mains by using battery-operated or gas-operated equipment. If the laboratory does have an electricity supply, however, the following valuable equipment can be used:

- an electric lamp for the microscope (stable illumination makes adjustment easier)
- an electric centrifuge (much faster than the manually operated type)
- a microhaematocrit centrifuge (rapid detection of anaemia)
- a spectrophotometer or colorimeter (much more accurate estimation of haemoglobin)
- an electric sterilizer, water bath
etc.

You may have to make simple connexions or repairs in the laboratory. The explanations given below are intended to help the laboratory technician to do this and are limited to the steps to follow in each case. It is recommended that inexperienced persons start by carrying out the procedures in the presence of an instructor.

NOTE: In many countries the electrical equipment will be different from that described here, which has been chosen as an example to illustrate the basic principles.

THE ELECTRICITY METER

This measures and records the amount of electricity used. It indicates:

- *the voltage* - measured in volts (220 V, 110 V, etc.)
- *the current strength* - measured in amperes (A)
- *the frequency* of the current, e.g. 50 hertz (Hz) (cycles per second).

Some types of meter have:

- a red button marked "OFF", or a flip-switch; when the button is pushed or the switch flipped, the electricity supply to the whole building is cut off (the mains fuse)
- a green button; when it is pushed or the switch flipped back the other way, the electricity supply is restored.

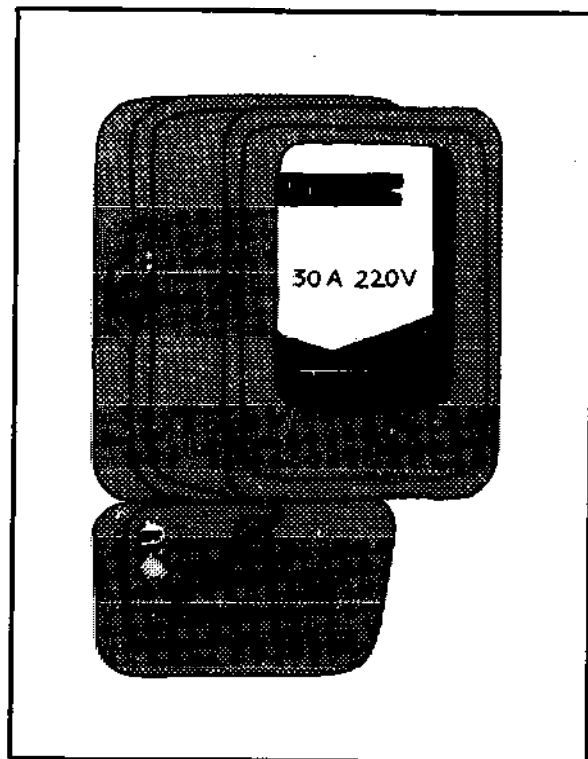

The "OFF" button or flip-switch may act as a circuit-breaker, automatically cutting off the current when the circuit is overloaded. When this happens, press the green button or flip the switch to restore the current after ascertaining and correcting the fault that caused the cut-off.

A. SETTING UP A NEW PIECE OF EQUIPMENT

1. Voltage

Check that the voltage marked on the instrument is the same as that of your electricity supply. The instrument has a place on it showing the voltage with which it must be used. The voltage of your electricity supply is marked on the meter.

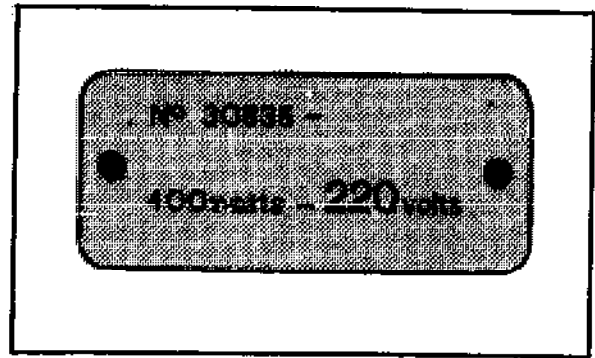

2. Dual voltage equipment

Some instruments can be used with 2 different voltages: these are dual voltage instruments.

There is a device on the instrument that enables you to select the appropriate voltage, i.e., the voltage marked on your electricity meter.

Depending on the instrument, this device may be:

- a lever that can be moved to the 110 V position or the 220 V position, etc.
- an unwired plug that can be transferred from the 110 V position to the 220 V position, etc.
- a screw that can be turned to the 110 V position or the 220 V position, etc.

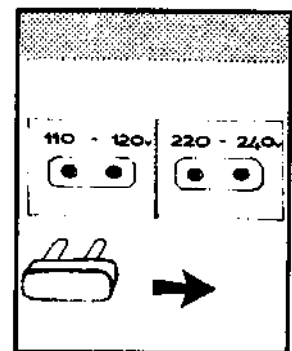
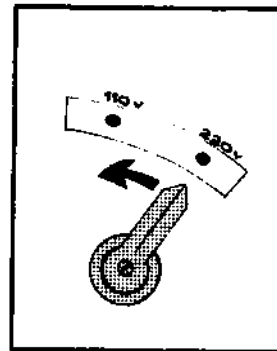

3. The wattage of the instrument

This is measured in watts (W) and is marked on the plate that shows the correct voltage for the instrument. Each piece of electrical equipment in the laboratory uses a certain amount of power. The total must not exceed the power of your electricity supply. The latter can be worked out from the figures shown on the meter: multiply the voltage (V) by the current strength (A). For example:

- voltage: 220 V
- current strength: 30 A
- wattage of the electricity supply: $220 \times 30 = 6600$ watts

4. Using a transformer

If the instrument provided is intended for use with a voltage different from that of the laboratory circuit, it can be used with a transformer. For example:

- the centrifuge provided only works at 110 V
- the voltage of your electricity supply is 220 V
- ask for a 110 V – 220 V transformer, indicating the wattage of the centrifuge

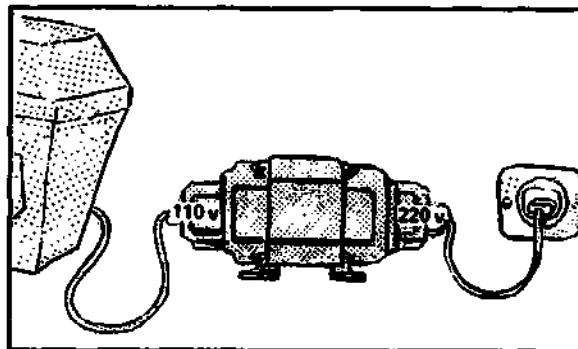

- plug the centrifuge into the 110 V connexion of the transformer supplied
- plug the 220 V lead from the transformer into the electricity supply (wall socket).

5. Switching off electrical equipment

After an instrument has been switched off, it must be unplugged from the wall socket. If left plugged in, it can cause a fire.

B. WHAT TO DO IN CASE OF ELECTRICITY FAILURE

If an instrument does not work, check the following:

1. the fuses
2. the plug at the end of the cable
3. the cable
4. the wall socket
5. the voltage of the instrument and that of the circuit.

Useful tools

- a screwdriver
- wire-cutters
- flat-nose or taper-nose pliers
- fuse wire
- various spare parts: plugs, switches, etc.

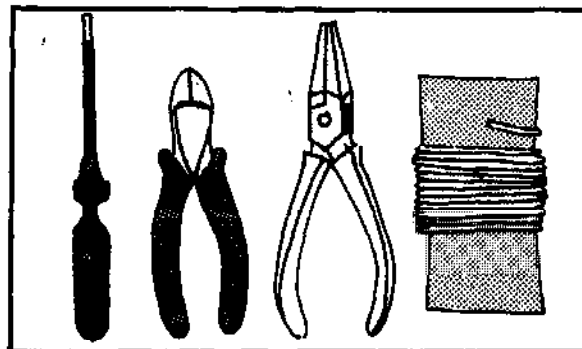

BEFORE DOING ANYTHING

Cut off the current:

- either by pressing the button or switch marked "OFF" on the meter
- or by removing the mains fuse.

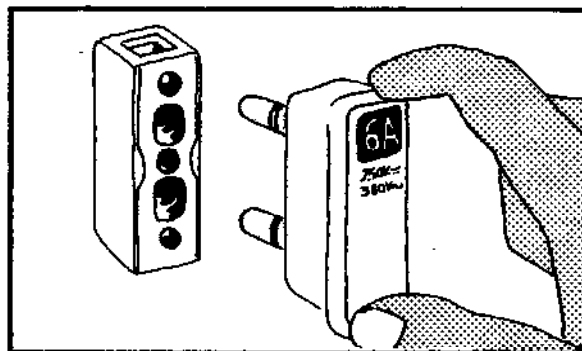

1. Changing a fuse

Remove the cover from the fuse-box.

If it is a screw-type fuse, the fuse wire is stretched between 2 screws. If the wire is broken or melted, the current no longer passes: the fuse has blown. Loosen the 2 screws. Remove the old fuse wire.

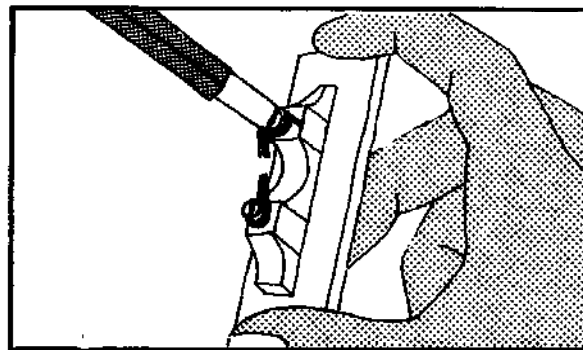

Replace it with new fuse wire of the same gauge (thickness), or with thinner wire if the same size is not available. Fix the wire in an "S" shape, with a loop at either end. If the fuse is of the screw-type (see diagram above), the wire must pass beneath the little washers under the screws.

If it is a two-pin fuse, fix the fuse wire to the base of the pins, and then tighten the pins with pliers.

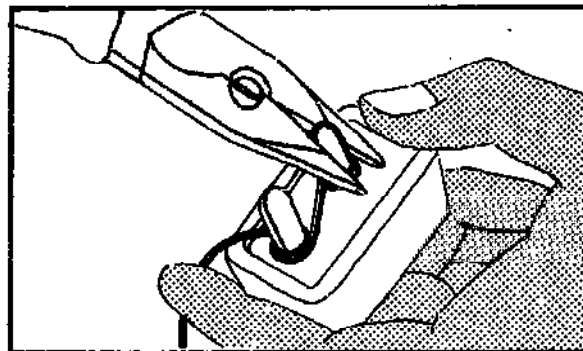

Once the fuse has been repaired, check the whole circuit before switching on the electric current.

2. The plug

If a fault is suspected in the plug at the end of the cable, the plug must be taken apart. There are many different types of plug. Some have a screw on the outside that can be unscrewed.

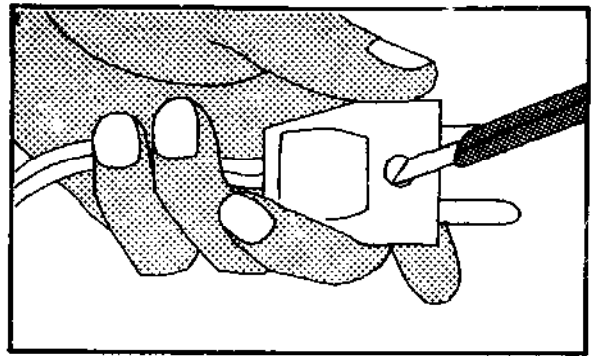

Inside the plug, the 2 wires of the cable are fixed to the terminals (T) of the contact pins (P). Check that the terminal screws are tightened. Sometimes this is all that is needed to repair the plug.

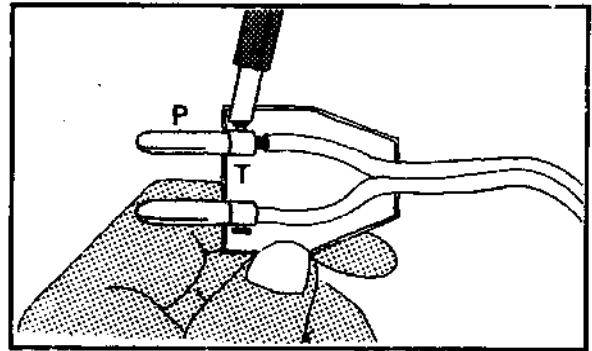

To fit a new plug, remove the insulating material for a length of 1–1.5 cm from each of the 2 wires making up the cable. This can be done by scraping with a knife but take care not to damage the wire inside.

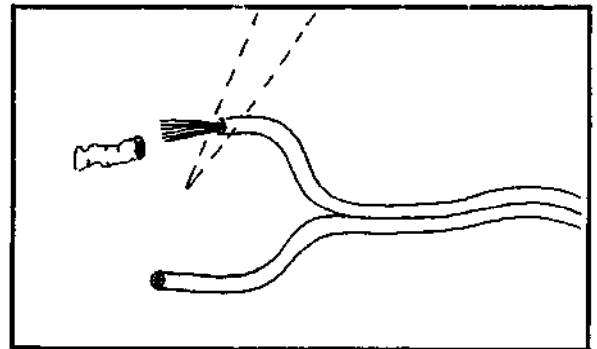

Twist the exposed ends of both wires to give a smooth core that will fit neatly into the terminal when the screw has been loosened.

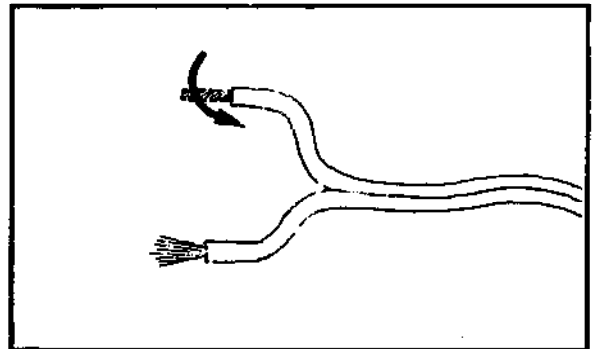

Insert each exposed end into one of the terminals of the plug. Tighten the terminal screws and replace the terminals. They should hold the wires firmly; check by pulling the wires gently.

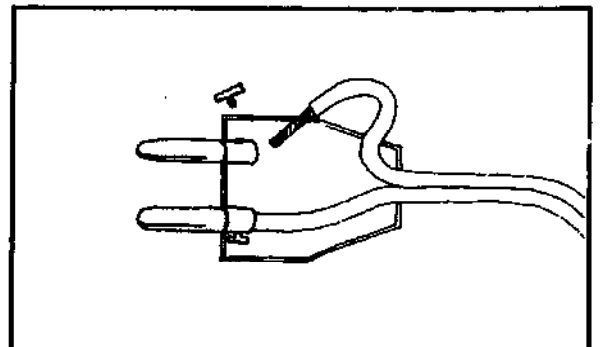

Three-pin plugs

Two of the pins are connected to the electric current; one is *live* and one is *neutral*. The third (usually the middle) pin is connected to the *ground*. It is most important to connect each of the three wires in the cable to the correct pin, and the plug usually contains instructions that should be strictly followed. If there is the slightest doubt, consult an electrician.

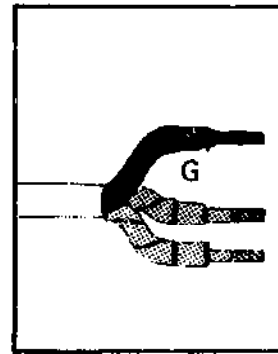
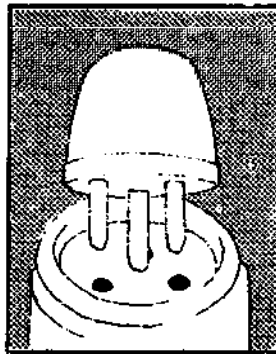

The ground wire is covered in *green* or *green and yellow* insulating material (G). It provides an escape for the electric current in case of poor insulation, thus avoiding passage of the current through the human body.

3. The cable (lead)

If the cable is burned or broken, ask an electrician to make the connexion in accordance with the safety regulations in force.

(a) Switches

There are many different types of switch. They have to be unscrewed and opened if you want to check that they are working properly. Make sure that the two incoming wires and the two outgoing wires are firmly fixed in their respective terminals by screws, 1, 2, 3 and 4.

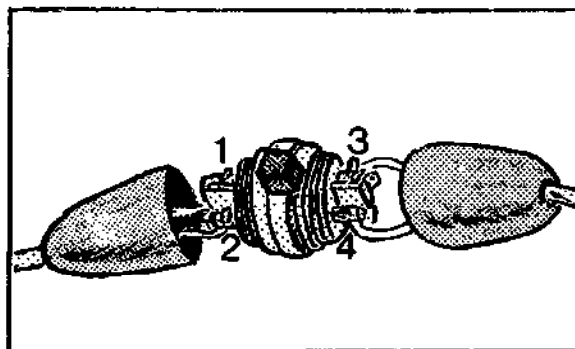

(b) Extension lead

An extension lead is a cable with a male plug (M) on one end and a female plug (F) on the other. The female plug is fixed to the cable by two terminals inside the plug, just like the normal male plug.

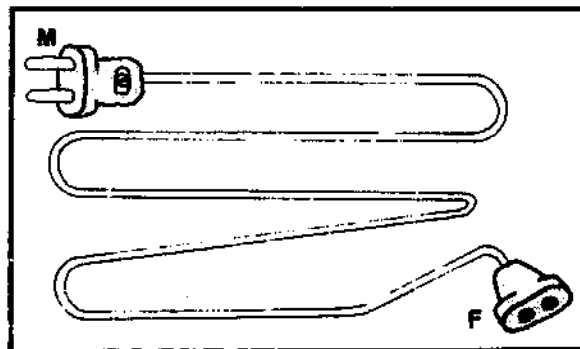

4. Wall sockets

To check a wall socket, plug in a lamp in good working order. Some sockets are fitted with a small replaceable fuse. If this is not the case, it is usually wise to call in an electrician to repair a wall socket.

C. SETTING UP A LAMP FOR THE MICROSCOPE

If you have a microscope with a mirror, a lamp can be made to provide illumination. A porcelain holder for a light bulb is fixed on a wooden base and the whole is encased in a wooden or tin box with an opening for the light. Cut slits in the top of the box to enable the bulb to cool.

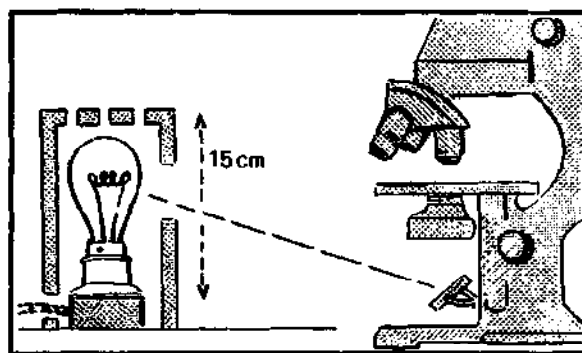

Alternatively, a flap can be fitted above the opening to serve as a shutter. Use an opaque electric bulb of the "daylight" type (blue-white):

- 60 watts for a monocular microscope
- 100 watts for a binocular microscope.

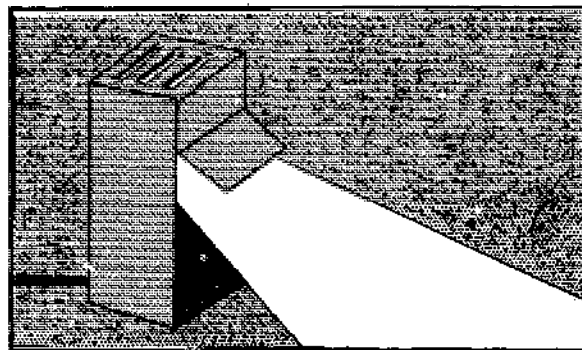

SOME THINGS NOT TO DO

1. Never take electrical equipment apart without first cutting off the current.
2. Never touch electrical equipment with wet hands (water is a good conductor of electricity).
3. Never plug a new piece of equipment into the electricity supply without first checking the plate to see whether the voltage marked is the same as that of the laboratory circuit (110 V, 220 V, etc.).
4. Never remove a plug from a socket by pulling the cable.
5. Never replace melted fuse wire by wire that is thicker.

17. Plumbing: Simple Procedures

A fault in the plumbing of the laboratory (a dripping tap, a blocked sink, etc.) can hamper laboratory work considerably. Some simple procedures to remedy the situation are described below, in case a plumber is not readily available.

A. MATERIALS

- An adjustable wrench
- A pipe wrench
- A set of screwdrivers
- A bottle brush
- Rubber washers for taps
- Rubber stoppers such as those used in penicillin bottles
- Plunger for clearing choked pipes
- Tow and jointing compound, if available.

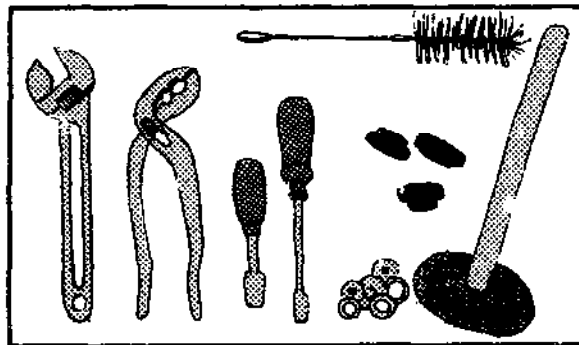

Important: Before starting any plumbing operation, cut off the water at the mains.

B. TAPS

Components of a tap

A tap is made up of two parts:

- the body B, through which the water flows
- the head H, which controls the flow of water by means of a rubber washer W.

Between the head and the body, there is a joint (J) of rubber or tow.

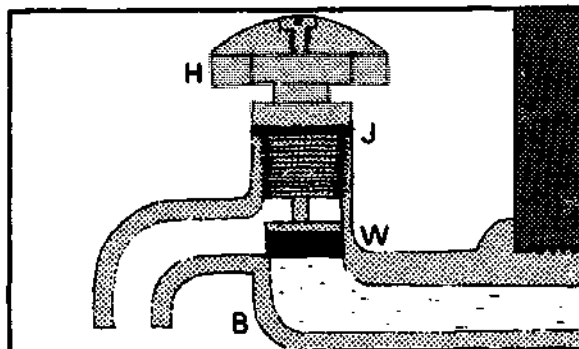

1. If the tap continues to flow when turned off

- the washer needs to be replaced.

(a) Unscrew the head of the tap using an adjustable wrench (turn in a counterclockwise direction).

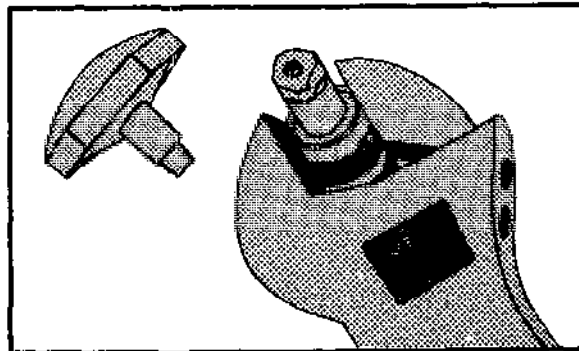

(b) Remove the worn washer from the base of the head (B). If the washer is embedded, pull it out. If it is screwed on, unscrew it.

(c) Replace it with a new washer of the same type.

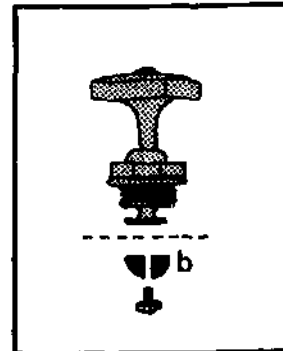
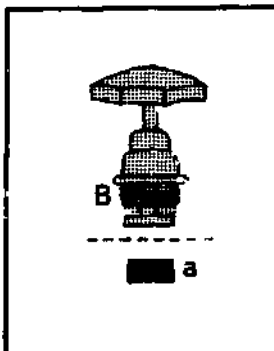

- (d) If the tap continues to leak after the washer has been replaced, the seating (S) that receives the washer is probably faulty. In this case place a rubber stopper in the hole. This will act as a temporary seal until a plumber can be called in.

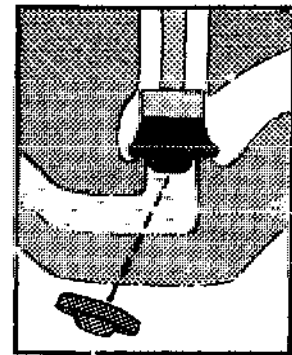
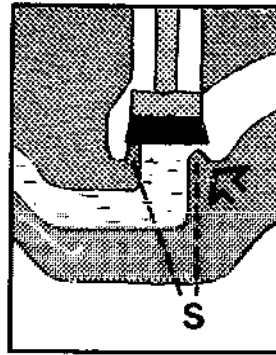

2. If water leaks out of the head of the tap

- the joint needs to be replaced.
- (a) Unscrew the head of the tap using an adjustable wrench.
- (b) Replace the joint with a new one of the same type.

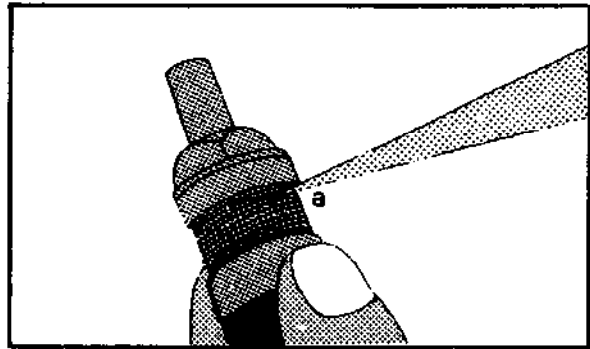

- If the joint is made of tow:
- (a) Remove the old joint, scraping the screw thread with a pointed knife.

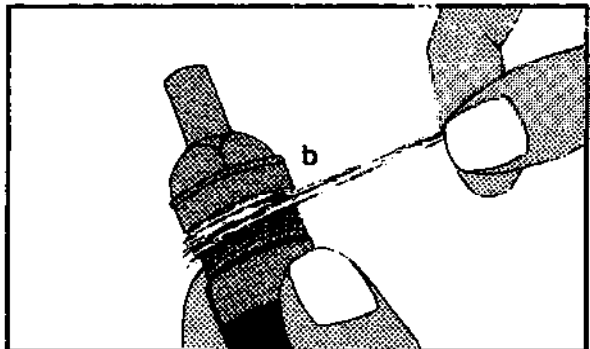

- (b) Wind new tow around the screw thread, starting at the top and winding in a clockwise direction.

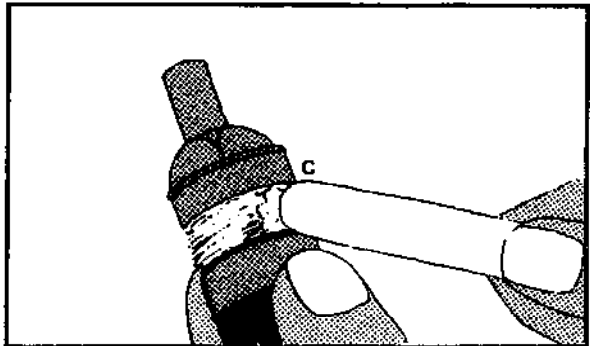

- (c) Smear jointing compound over the tow.
- (d) Replace the head of the tap on the body and screw down as far as it will go.

3. Replacing the whole tap

Unscrew the faulty tap, using a pipe wrench (turn in a counterclockwise direction).

Take the new tap; the body ends in a large screw (S). Wind tow around the thread and smear with jointing compound as described above.

Screw the new tap into the water pipe in the wall in place of the old one.

Tighten with the wrench.

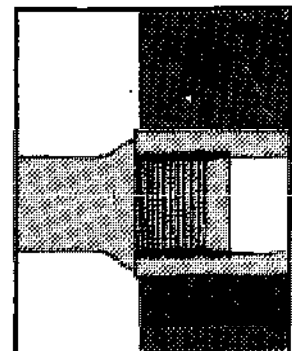
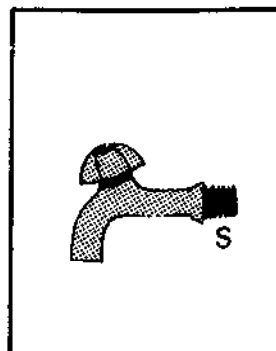

C. SINK TRAPS

Components of a sink trap

The sink trap consists of:

- the body, fixed to the sink outflow by a joint J1
- the swan neck of the U-shaped trap, fixed to the body by joint J2.

The whole is attached to the waste pipe by joint J3. The waste water flows into the trap, which is permanently filled with water (the seal). This prevents foul air from the waste pipes and sewers from coming up into the sink.

Sink traps may become blocked so that waste water from the sink or basin cannot drain away.

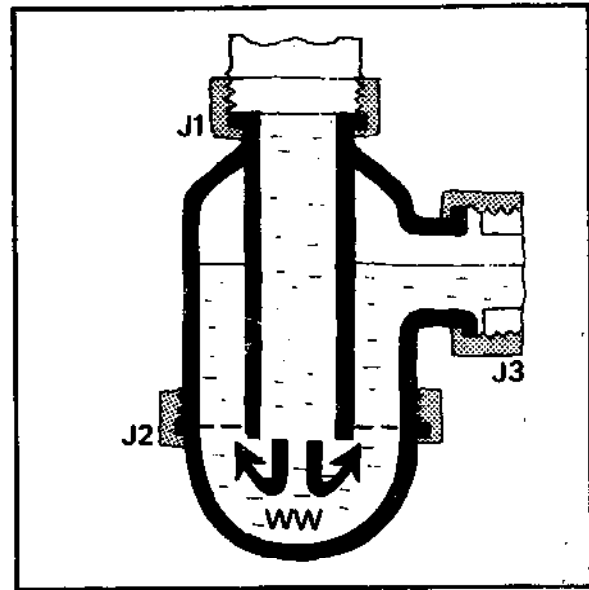

Unblocking with a plunger

Place the plunger over the waste pipe. Let a little water flow around it to help it stick. Press down on the wooden handle to flatten the plunger. Pull it up and then push it down hard again. Repeat this procedure several times, as fast as you can. The suction caused may break up whatever is blocking the sink.

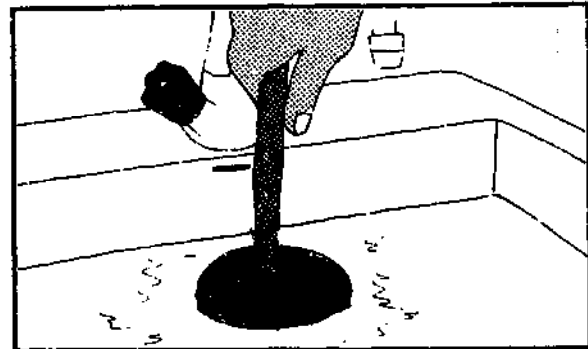

Unblocking with chemicals

Use a commercial product intended for the purpose. If this is not available, use 250 g of sodium hydroxide pellets. Put them in the bottom of the sink or basin, over the waste pipe.

Pour two litres of boiling water on to the pellets (avoid splashing).

Leave to act for 5 minutes.

Rinse thoroughly with cold water from the tap.

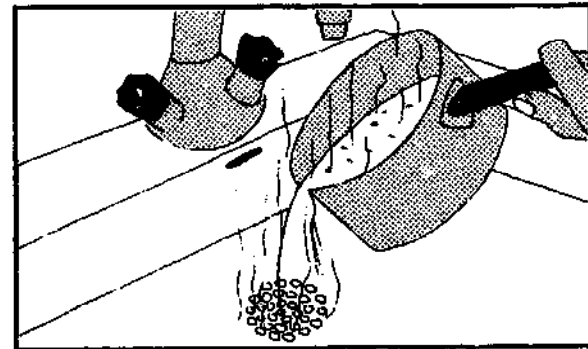

Unblocking by emptying the sink trap

Place a bucket beneath the trap. Unscrew joint J2 using the adjustable spanner. Clean the trap with a bottle brush or piece of wire. Clear away all waste material.

If there is a white deposit (limestone) in the trap, take it apart completely. Heat the components in diluted acetic acid (20 ml acid per litre of water).

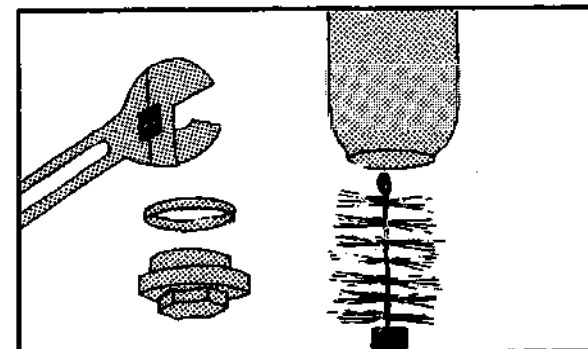

If the trap is leaking

If foul smells come up through the waste pipe of the sink, the permanent reservoir of water (the seal) at the bottom of the trap must have leaked because of a fault in joint J2. Screw the joint down tightly, or replace it with a new one.

Important: Never pour strong acids down a sink.

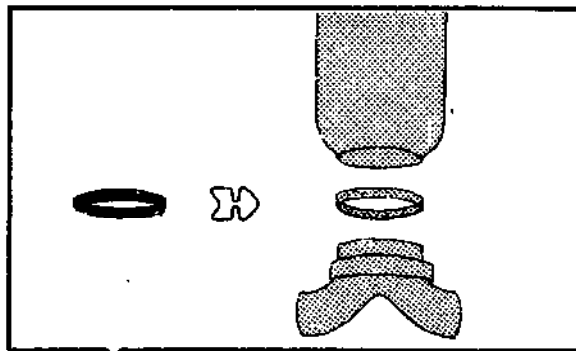

18. First Aid in Laboratory Accidents

ACCIDENTS IN THE LABORATORY

Accidents in the medical laboratory may be caused by:

1. *Acids*
or
2. *Alkalis*
 - splashes on the skin
 - splashes in the eye
 - swallowing.
3. *Toxic substances*
4. *Heat*
 - open flames
 - hot liquids
 - inflammable liquids
 - explosions.
5. *Broken glass*

In addition to the above, there may be injuries involving infected material, bodily damage by electric shock, etc.

Useful first aid equipment

- 5% aqueous sodium carbonate
- 2% aqueous sodium bicarbonate (in an eyedrop bottle)
- 5% acetic acid
- Saturated solution of boric acid (in an eyedrop bottle)
- Soap powder solution: 5 g per litre of water
- Cotton wool and gauze
- Merbromin (Mercurochrome) and tincture of iodine.

These items should be readily available in the laboratory. They must not be kept in a locked cupboard.

Acid burns

(Nitric, sulfuric, hydrochloric and trichloroacetic acids)

In all cases: Wash immediately with large quantities of water.

1. *Acid splashes on the skin*
 - (a) Wash thoroughly and repeatedly with water.
 - (b) Bathe the affected skin with cotton wool soaked in 5% aqueous sodium carbonate.

2. *Acid splashes in the eye*

- (a) Wash the eye immediately with large quantities of water sprayed from a wash bottle (or rubber bulb); squirt the water into the corner of the eye near the nose.

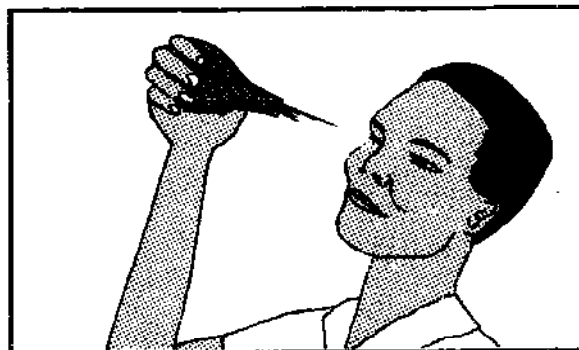

Alternatively, hold the eye under the running tap.

- (b) After washing, put 4 drops of 2% aqueous sodium bicarbonate into the eye.
- (c) Refer the patient to a physician. Continue to apply bicarbonate solution to the eye pending the physician's arrival.

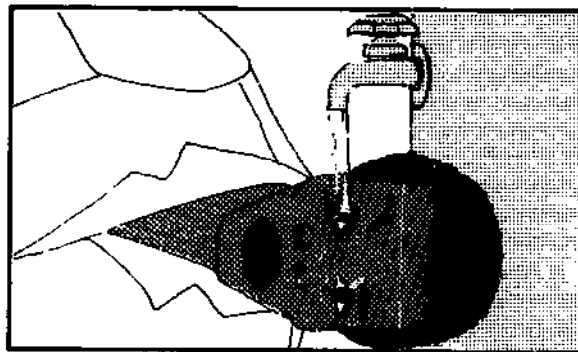

3. Swallowing acids

Accidental swallowing while using a pipette:

- (a) Call a physician.
- (b) Make the patient drink some 5% soap solution immediately (alternatively, give him 2 whites of egg mixed with 500 ml of water or milk). If neither of these is available, he should drink ordinary water.
- (c) Make him gargle with the soap solution.
- (d) Give him 3 or 4 glasses of ordinary water.
- (e) If the lips and tongue are burned by the acid:
 - rinse thoroughly with water
 - bathe with 2% aqueous sodium bicarbonate.

Alkali burns

(Sodium, potassium and ammonium hydroxide)

In all cases: Wash immediately with large quantities of water.

Important: Alkali burns are as serious as, and often more serious than, acid burns.

1. Alkali splashes on the skin

- (a) Wash thoroughly and repeatedly with water.
- (b) Bathe the affected skin with cotton soaked in 5% acetic acid (or undiluted vinegar).

2. Alkali splashes in the eye

- (a) Wash immediately with large quantities of water sprayed from a wash bottle (or rubber bulb); squirt the water into the corner of the eye near the nose.
- (b) After washing with water, wash the eye with a saturated solution of boric acid (apply drops repeatedly).
- (c) Refer the patient to a physician at once.

3. Swallowing alkalis

Accidental swallowing while using a pipette:

- (a) Send for a physician.
- (b) Make the patient drink at once:
 - a 5% solution of acetic acid (or lemon juice, or dilute vinegar: 1 part vinegar to 3 parts water).
- (c) Make him gargle with the same acid solution.
- (d) Give him 3 or 4 glasses of ordinary water.
- (e) If the lips and tongue are burned by the alkali:
 - rinse thoroughly with water
 - bathe with 5% acetic acid.

Poisoning

This can be caused by:

- inhaling toxic vapours or gases (e.g. chloroform)
- accidental swallowing while pipetting a poisonous solution.

In all cases:

- (a) Send for a physician or qualified nurse, specifying the toxic substance involved.
 - (b) Place the victim in the open air while waiting for the physician.
-

Burns caused by heat

These fall into two categories:

1. *Severe burns* affecting large areas of skin (e.g. burns caused when burning ether or boiling water is spilled over the victim).
2. *Minor burns* affecting a small area of skin (e.g. burns caused by hot glassware or a Bunsen flame).

1. *Severe burns*

- (a) If the victim is on fire (e.g. splashed with burning ether or other inflammable solvent), roll him in a blanket or overall to smother the flames.
- (b) Inform the physician on duty at the casualty department immediately, specifying that a patient with severe burns will have to be moved.
- (c) Lay the victim on the ground. Do not remove his clothing. Cover him if he is cold.
- (d) Do not apply any treatment to the burns: this must be left to the physician.

2. *Minor burns*

- (a) Plunge the affected part into cold water or ice-water to soothe the pain.
 - (b) Apply merbromin (or tincture of iodine) to the burn.
 - (c) Apply a dry gauze dressing loosely.
 - (d) If the burn becomes infected or does not heal, refer the patient to a physician. Never tear off the blisters that form over burns.
-

Injuries caused by broken glass

1. *Clean glass*

- (a) Disinfect the skin in the normal way (using merbromin, tincture of iodine, etc.).
- (b) Cover with an adhesive dressing (ready-made type).
- (c) If the cut bleeds profusely, stop the bleeding by pressing down on it with a compress. Refer the patient to the casualty department.
- (d) If the cut bleeds heavily with the blood spurting out at intervals, try to stop the bleeding with a compress and call a physician or qualified nurse.
- (e) Continue to press on the wound while awaiting the physician's or nurse's arrival. (He or she will decide whether a tourniquet should be applied.)

2. *Glass containing infected material*

Glassware containing stools, pus, bacterial cultures, etc.:

- (a) Check whether the cut is bleeding; if not, squeeze hard to make it bleed for several minutes.
 - (b) Bathe the whole area (the edges of the cut and inside the cut) with tincture of iodine or a surgical antiseptic.
 - (c) Wash thoroughly with soapy water.
 - (d) Bathe again with tincture of iodine.
 - (e) Refer the victim to the physician if the material involved is known to be very infective (bacterial cultures, pus, etc.).
-

Bodily damage by electric shock

A low-voltage alternating electric current (120 or 220 V) is usually used in the laboratory and electric shocks are rare. They may occur when faulty equipment is being handled, particularly with wet hands. The symptoms are fainting and asphyxia.

- (a) Before doing anything else, cut off the electricity at the mains fuse.
- (b) Send for a physician.
- (c) Begin giving artificial respiration immediately (mouth to mouth), and massage the heart externally if necessary.

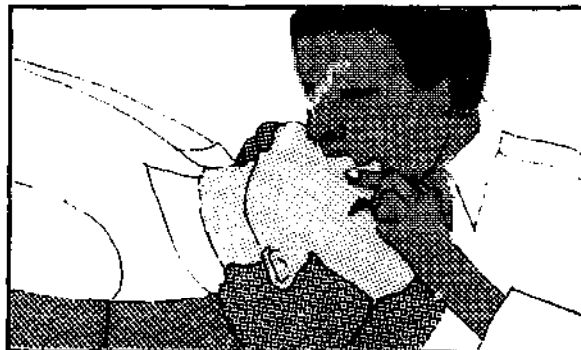

PRECAUTIONS FOR THE AVOIDANCE OF ACCIDENTS

Handling acids and alkalis

1. *Diluting sulfuric acid with water*

Always add the sulfuric acid to the water drop by drop, stirring the mixture after each drop. Do this preferably in a sink. *Never pour water into sulfuric acid* (because of the danger of splashing).

2. *Bottles of acids and alkalis*

Keep them on the lower shelves of the cupboards. When you take one out, hold it firmly upright with a dry hand. Do not keep acids and alkalis in bottles with ground glass stoppers (they may get stuck).

3. *Pipetting*

Where possible, use small measuring cylinders for measuring acids and alkalis. If more accurate measurement is required, use a pipette plugged with non-absorbent cotton wool or with a rubber tube attached. Pipette slowly, watching the level of the liquid.

Heating glassware and liquids

1. *Test-tubes*

Never heat the bottom of a test-tube; the liquid inside might sputter. Heat the middle of the tube, shaking gently. The mouth of the tube should be facing away from the worker and any other person, towards an empty work space or a sink.

2. *Ordinary glass and Pyrex*

Only Pyrex glassware and porcelain receptacles can be heated over a Bunsen flame. Ordinary glass will break.

3. *Inflammable liquids*

Only small quantities of inflammable liquids such as ether, ethanol, acetone, benzene, toluene and carbon disulfide should be kept in the laboratory.

WARNING: Ether will ignite at a distance of several metres from a flame. Never place a bottle of ether on a workbench where there is an open flame (Bunsen burner, spirit lamp, etc.). Carbon disulfide is even more dangerous.

4. *Butane gas*

When lighting a gas burner, always light the match and hold it to the burner before turning on the gas tap. Turn off the main valves of all bottles of butane gas every evening. Replace the rubber connecting pipes once a year.

19. Plan of a Peripheral Medical Laboratory

The plan below sets out the possible arrangement of a peripheral medical laboratory attached to a health centre. It shows a laboratory capable of carrying out some or all of the techniques described in the manual. The plan is limited to *one room*, since often this is all that is available for the laboratory. The room should be at least 5 metres by 6.

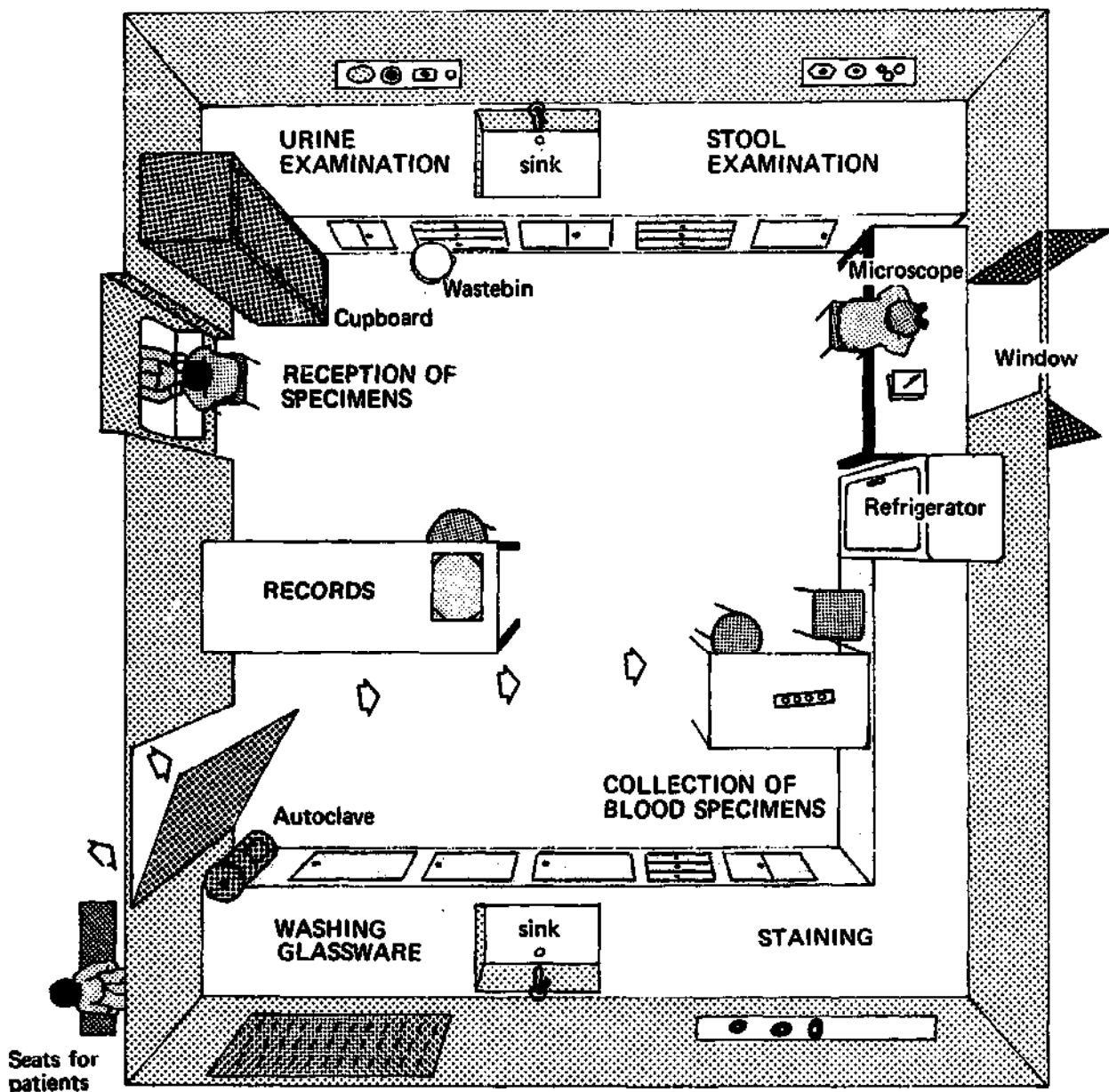

If 2 rooms are available, it is recommended that the blood transfusion service be placed in the second room. If there is no transfusion service, the second room can be used for washing and sterilization. Dirty and/or contaminated material should be removed from the laboratory working area as quickly as possible both for the safety of the workers and to avoid errors and cross-contamination.

This illustration indicates another possible arrangement of a peripheral laboratory. It will obviously be modified by circumstances.

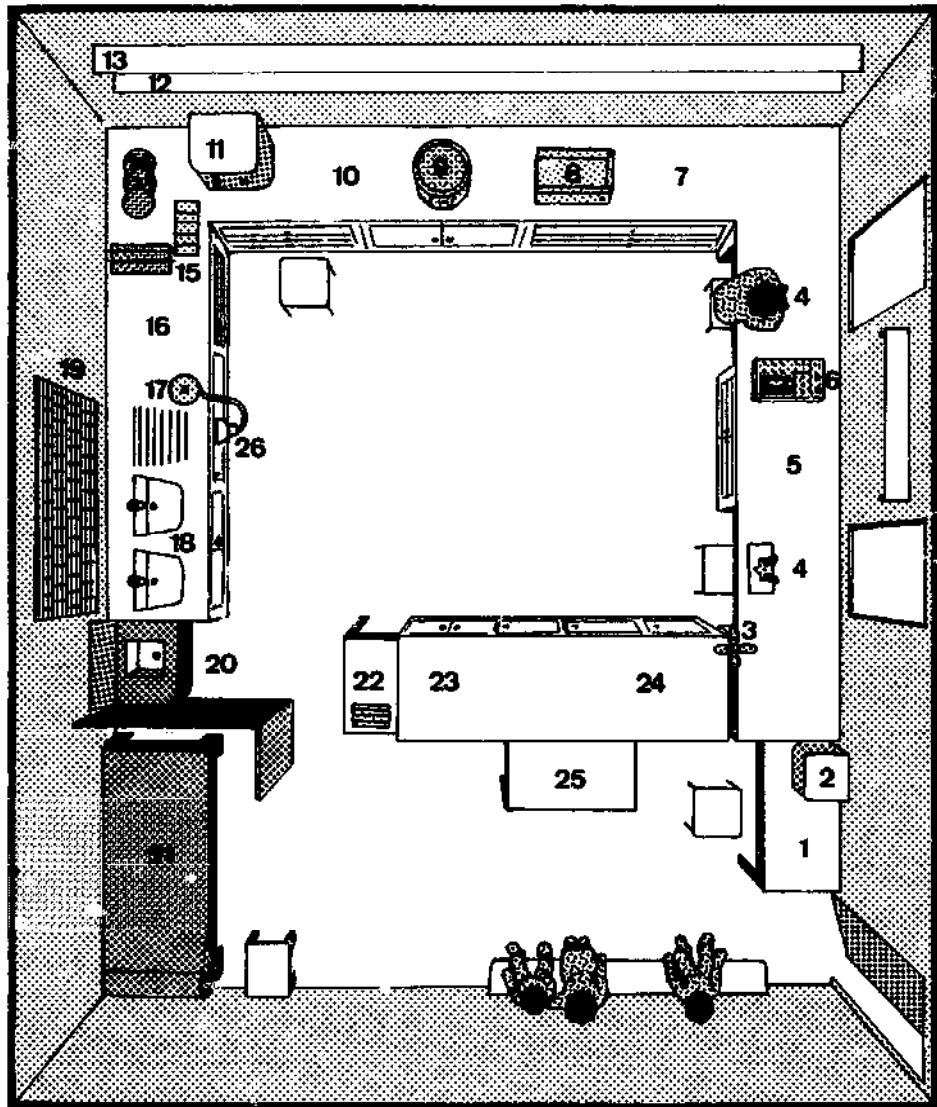

- | | |
|---|----------------------------|
| 1. Outpatient's table | 14. Balance |
| 2. Blood bank refrigerator | 15. Staining box |
| 3. Hand centrifuge | 16. Sputum area |
| 4. Microscopes | 17. Bunsen burner |
| 5. Haematology area | 18. Sinks |
| 6. Colorimeter | 19. Drying pegs |
| 7. Blood transfusion area | 20. Waste sink |
| 8. Water bath | 21. Blood donor bed |
| 9. Centrifuge | 22. Records |
| 10. Syphilis serology and biochemistry area | 23. Stool preparation area |
| 11. Reagent refrigerator | 24. Urine preparation area |
| 12. Reagent shelf | 25. Reception of specimens |
| 13. Glassware shelf | 26. Gas bottle |

20. List of Apparatus Needed to Equip a Peripheral Laboratory

The following is a list of the apparatus needed to equip a laboratory capable of carrying out all the examinations described in the manual. Such a laboratory would usually be located in a small rural hospital (district level) which might have between 60 and 100 beds. A health centre laboratory not attached to a hospital would require less equipment as it would probably not carry out blood transfusion work, VDRL, etc.

The quantities of the different expendable items proposed are sufficient to enable a laboratory with one or two technicians to perform 20–50 examinations per day for a period of 6 months.

I. LABORATORY INSTRUMENTS

A. Essential items

1. *The microscopes*

- One microscope with an inclined binocular tube, a mechanical stage, three objectives (x 10, x 40, x 100), eyepieces (x 5, x 10), condenser and plane/concave mirror. If mains electricity is available, an electric microscope lamp, for use in haematology.
- One microscope with an inclined monocular tube and accessories as listed above, for use in the other sections of the laboratory (parasitology, urine analysis, bacteriology, etc.).

At the health centre level one monocular microscope is sufficient.

2. *The centrifuge*

- An electric centrifuge with microhaematocrit head attachment and reader.
- A hand-operated centrifuge with 4 buckets.

3. *The balance*

An analytical balance is necessary if reagents are to be prepared in the laboratory. Accessories: a set of weights.

4. *Refrigerators*

Wherever a transfusion service is established a separate refrigerator must be set aside for this service. Other reagents (VDRL and pregnancy tests, etc.) and materials (some transport media, specimens, etc.) can be kept in a compartment of the hospital's or health centre's refrigerator.

5. *A thermostatically controlled water bath (37°C–56°C)*

Used for cross-matching, VDRL tests, inactivation of sera, and other tests where a constant temperature is needed over a relatively long period.

6. *A rotating machine for VDRL tests*

Essential in any laboratory where the VDRL test is done routinely.

7. *A differential counter*

Although a hand tally counter can be used, the differential counter saves time and improves efficiency.

8. *A photometer or colorimeter*

Necessary for blood chemistry and for accurate haemoglobin determination. A battery-powered model is supplied by UNICEF (ref. 09-309-98 or 09-310-00).

B. Additional items

1. *The autoclave*

When the laboratory is in a hospital, the hospital sterilization service can be used. If the laboratory is in a health centre one of the following is needed:

- a pressure cooker
- a small autoclave (electric or heated by oil stove or butane gas).

2. *A hot air oven*

If the laboratory is fairly large, a small hot air oven is useful for drying glassware and for sterilization in conjunction with the autoclave.

3. Balances

If the laboratory is required to prepare a wide range of reagents, a two-pan balance with the corresponding set of weights might be acquired.

4. A de-ionizer or a still for making distilled water

The de-ionizer is an apparatus for demineralizing water by means of cartridges of ion-exchange resins (see page 59).

A still can be used instead of a demineralizer. A model supplied by UNICEF (ref. 01-680-02) is made of stainless steel and is therefore durable.

If all the reagents are supplied ready for use or if distilled water is provided, this item may be withdrawn from the list.

II. EQUIPMENT FOR COLLECTION OF SPECIMENS

Syringes, graduated, 20 ml	2
Syringes, graduated, 10 ml	10
Syringes, graduated, 5 ml	20
Needles (hubs to fit syringes) size 18G (1.2 mm) x 40 mm	6 x 12
Needles (hubs to fit syringes) size 19G (1.0-1.1 mm) x 40 mm	6 x 12
Needles (hubs to fit syringes) size 20G (0.9 mm) x 40 mm	2 x 12
Needles (hubs to fit syringes) size 22G (0.7 mm) x 40 mm	6 x 12
Needles (hubs to fit syringes) size 23G (0.6 mm) x 32 mm	2 x 12
Needles (hubs to fit syringes) size 25G (0.5 mm) x 16 mm	3 x 12
Rubber tubing for tourniquet, 2-5 mm bore	2 pieces
Lancets for taking capillary blood	10 x 12
Cotton wool, white, absorbent	2 x 500 g
Cotton wool, non-absorbent	2 x 500 g
Bottles, previously containing antibiotics, reagents, etc. for injection (5, 10, 20 ml)	As many as possible

Additional equipment desirable

Needles, sterile, disposable, for taking blood	as needed
Needles, stop, 18G	12
Lancets, sterile, disposable, for taking capillary blood	as needed
Scalpel with disposable blades (for leprosy)	1
Curved clamp forceps without teeth (for leprosy)	1
Boxes, plastic or cardboard, disposable, for stool collection	500
Applicators, wooden (12 cm x 1 mm) (can be made locally)	500
Bottles, 2.5 ml and 5 ml, preferably plastic	50
Bottles, white glass, wide-mouthed, 50 ml, with metal screw cap and rubber washer, for sputum collection	25
Bottles, white glass, 25 ml, with metal screw cap and rubber washer, for various specimens	25
Bottles, wide mouth, all varieties, for urine collection	20-40
Forceps, punch for skin biopsies (for onchocerciasis)	1
Tongue depressors, wooden	50

III. GLASSWARE

Glass rods, solid 6 mm diameter	3
Beakers, flat:	
- plastic 50 ml	4
- plastic 100 ml	4
- plastic 250 ml	4
Staining troughs, rectangular, for 20 slides	4
Funnel, glass, 60 mm diameter	1
Funnels, glass, 90 mm diameter	2
Funnel, plastic, 200 mm diameter	1
Measuring cylinders, graduated, with stoppers, glass:	
- 25 ml	3
- 100 ml	3
- 250 ml	2
- 500 ml	1
- 1000 ml	1
Flasks, Erlenmeyer, Pyrex, wide-mouthed, 250 ml	3
Flasks, Erlenmeyer, Pyrex, wide-mouthed, 500 ml	2
Drop bottles, plastic or glass, 100 ml	12
Drop bottles, brown glass, 100 ml	3
Reagent bottles, plastic or glass:	
- 100 ml	20
- 500 ml	10
- 1000 ml	10

Flasks, volumetric, glass, with stoppers:	
— 100 ml	4
— 250 ml	2
— 500 ml	2
— 1 litre	1
Microscope slides, 25 x 75 mm (1.1 to 1.3 mm thick)	2 x 1000
Coverslips, square, 20 x 20 mm (0.13 to 0.16 mm thick)	20 x 100
Wash bottles, plastic, 500 ml	2
Wash bottles, plastic, 1000 ml	2
Watch glasses, 50 mm diameter	2
Pipettes, graduated from the top and not to tip:	
— 1 ml (subdivided 0.01 ml)	12
— 2 ml (subdivided 0.01 ml)	10
— 5 ml (subdivided 0.1 ml)	10
— 10 ml (subdivided 0.1 ml)	6
Pipettes, Pasteur	2 x 144
Test-tubes, Pyrex, 150 x 16 mm	50
Test-tubes, Pyrex, 85 x 15 mm (Kahn tube)	100
Test-tubes, Pyrex, 50 x 6 mm (cross-matching tube)	20
Centrifuge tube, conical, 15 ml	40
Centrifuge tube, conical, 15 ml, graduated in 0.1 ml	6
Glass tubing, wall 1 to 1.5 mm, diameter 7 to 8 mm	1 kg

Additional items

Petri dishes, glass:	
— 112 mm diameter	4
— 156 mm diameter	4
Evaporating dishes, 75 mm (75 ml)	2
For the VDRL test:	
— Bottles, clear glass, 30 ml, with ground glass stoppers, 35 mm diameter, flat-bottomed	3
— Pipettes, graduated to tip: 1 ml (subdivided 0.1 ml)	5
0.2 ml (subdivided 0.05 ml)	30

IV. HAEMATOLOGICAL APPARATUS

Pipettes, Sahli, 0.02 ml, with rubber tubing	30
Pipettes, blood, 0.05 ml	20
Counting chambers:	
— Improved Neubauer (bright line if possible)	3
— Fuchs-Rosenthal	1
Coverglasses, optically plane, for counting chambers	12
Tally counter	1
Tubes, Westergren, for erythrocyte sedimentation rate	30
Stands, for Westergren tubes	2
Microhaematocrit capillary tubes, heparinized	1000
Microhaematocrit tube sealing compound	1 set (10 trays)
Blood-collecting bottles, for transfusion	300
Blood-collecting sets	30
Opal blood-grouping tiles	3

V. BACTERIOLOGICAL AND BIOCHEMICAL APPARATUS

Nickel-chromium alloy (nichrome) wire, 1 mm diameter	1 metre
Loop holders	4
Wooden block for loopholders	1
Protein standard tubes	1 set
Test-tube racks, large, 12 tubes	4
Test-tube racks, small, 12 tubes	4
Wooden test-tube holders	2
Forceps, stainless steel, for slides	2
Bunsen burner for use with butane gas	1
Butane gas cylinders	as needed
Tripod with asbestos gauze	1
Urinometer	1
Spatulas, various sizes, for reagent weighing	3

VI. LABORATORY RECORDS AND REPORTS

Record books, hardbacked, large	6
Record book, hardbacked, small (for blood donors)	1
Glass-marking pencils, wax, red	12
Glass-marking pencils, wax, blue	12
Glass marker, diamond point	1
Pencils, lead	12
Pens, ballpoint, black or blue ink	3
Pens, ballpoint, red ink (for recording positives)	2
Cellophane tape	3 rolls
Adhesive tape, white	3 rolls
Labels for patients' bottles	1000
Prepared laboratory request forms (preferably standardized centrally)	as needed

VII. MISCELLANEOUS

Timer, 0-60 min, with alarm	1
Spirit lamp	1
Hammer	1
Pliers	1 pair
Pliers, electrician's	1 pair
Screwdrivers (small, medium, large)	3
Round metal file, 5 mm	1
Small ampoule files	12
Saucepan, flat-bottomed with lid, 30 cm	1
Hot plate	1
Mortar and pestle (10 cm)	1
Bowls, plastic, 50 x 30 cm	3
Bucket, plastic, 12 litres	1
Rubber bulb (for cleaning pipettes)	1
Scissors (medium, large)	2
Vacuum pump, metal	1
Thermometer, 0-100 °C	1
Stoppers, rubber	1 set
Stoppers, cork	1 set
Corkscrew	1
Test-tube and bottle-cleaning brushes (various sizes)	6
Filter paper, 15 cm, No.1	4 boxes
pH paper, narrow range (6.8-7.2)	6 books
pH paper, wide range (0-12)	6 books
Litmus paper	6 vials
Lens paper	2 packets
Toilet tissue	2 rolls
Towels and clean rags	as needed
Immersion oil	6 bottles (10 ml each)

PART II

A. PARASITOLOGY

Introduction

The study of parasites that cause disease in man is called medical parasitology. A parasite is an organism that lives in or on another living organism of a different species and obtains its food from it.

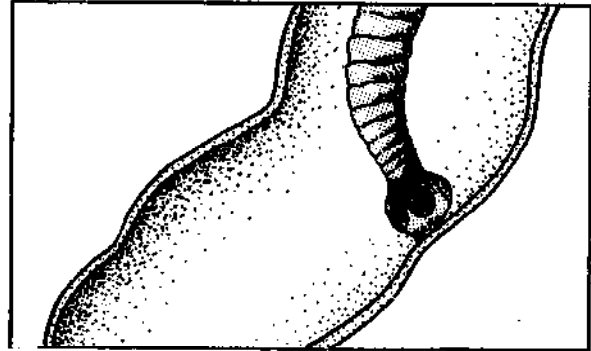

The organism from which the parasite takes its food is called the host.

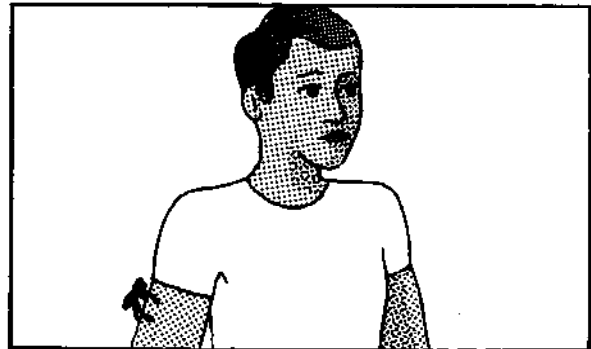

A parasite such as a tick that lives *on* its host is called an ectoparasite.

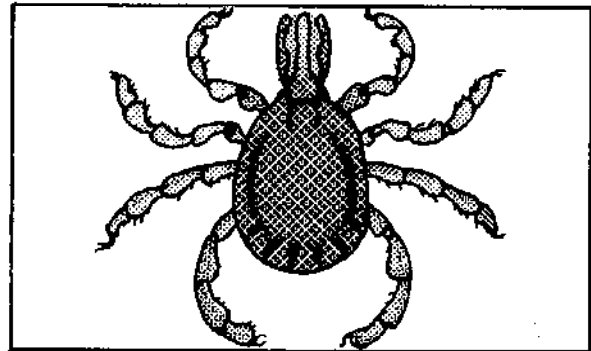

A parasite that lives *in* its host, such as a hookworm or an amoeba, is called an endoparasite.

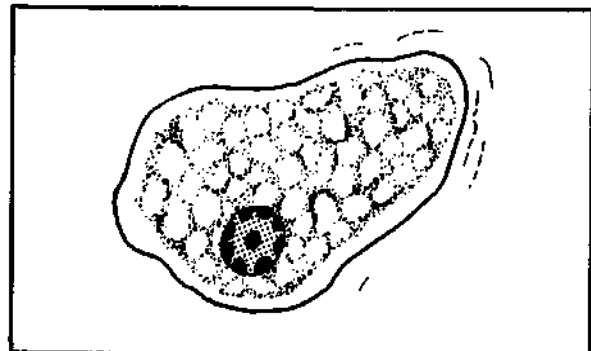

Laboratory diagnosis in medical parasitology may include examination of stools, urine, sputum, blood, cerebrospinal fluid (CSF), and other secretions or tissues.

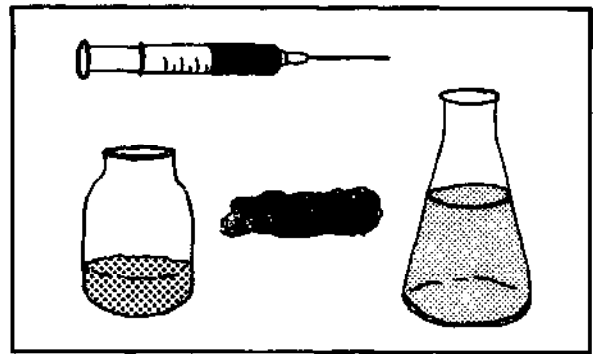

1. What to Look For. Collection of Stools.

The following stool examinations are carried out in the laboratory:

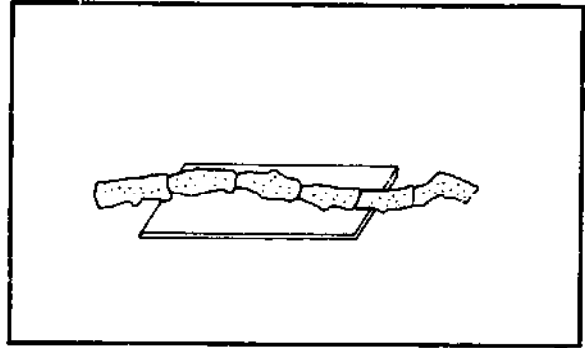

1. PARASITOLOGICAL EXAMINATION

This is the detection of parasites such as:

(a) *worms* visible to the naked eye (see page 143).

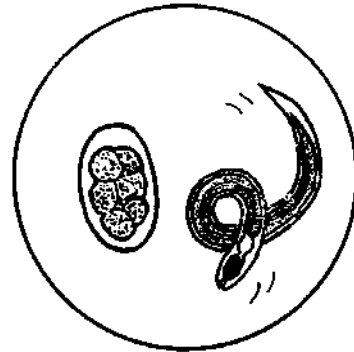

(b) *eggs or larvae of those worms*, visible only under the microscope (see page 122).

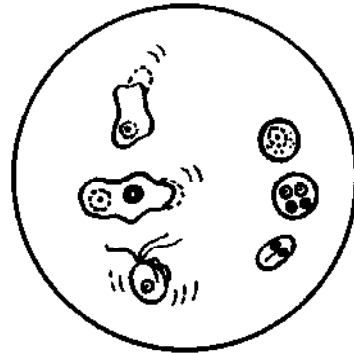

(c) *protozoa* (single-celled microorganisms), which may be found in a motile (vegetative) form (see page 147) or in a non-motile, resistant form as cysts (see page 156).

2. BACTERIOLOGICAL EXAMINATION

This is the detection of bacteria that cause disease by the culture of stools (see page 258).

3. CHEMICAL EXAMINATION

This is principally carried out to detect the presence of occult blood (see page 175).

Other chemical tests are less frequent.

COLLECTION OF STOOLS

The reliability of the results obtained will depend largely on the care taken in collecting the stools. The following precautions should be taken in collecting stools for parasitological examination.

1. Collection of a sufficient quantity

This is necessary in order:

- to permit detection of parasites, if in low concentration
- to prevent rapid drying of stools.

The specimen should contain at least 4 ml (4 cm³).

2. Provision of a container for the patient's use

Every effort should be made to give the patient one of the following types of container for collection of the specimen:

- (a) a waxed cardboard box
- (b) an empty tin with a lid

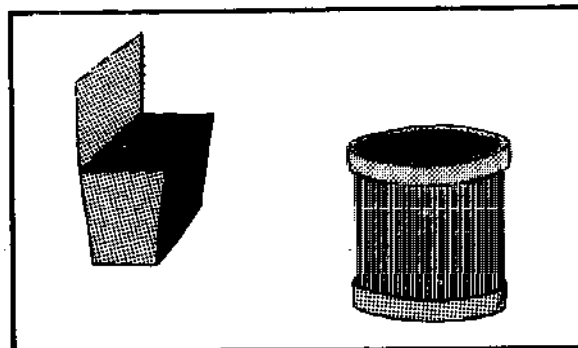

- (c) a light plastic box

- (d) a glass jar especially designed for stool collection, with a spoon attached to the stopper.

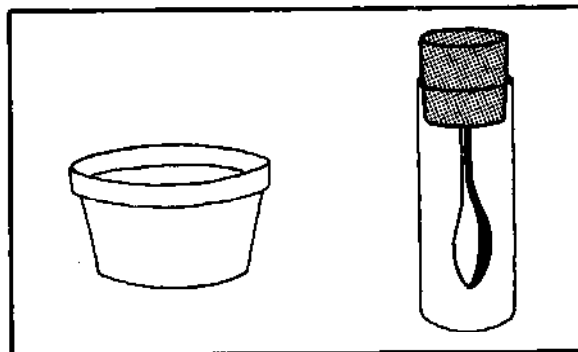

3. Examination of stools while fresh

- (a) Stools must be examined within one hour of collection.

- (b) If a number of specimens are received at the same time, pick out liquid stools and those containing mucus or blood and *examine these first*, for they may contain motile amoebae that die quickly.

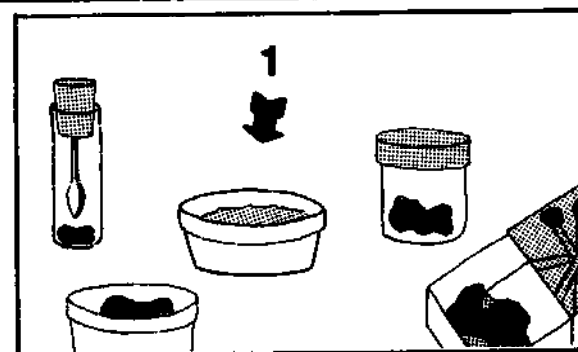

THINGS NOT TO DO

1. Never leave stool specimens exposed to the air in containers without lids.
2. Never set aside stool specimens for examination at the end of the morning (i.e., 2 or 3 hours later).
3. Never accept stools mixed with urine (e.g. in a chamber pot or bedpan).
4. Never place the container with the stool specimen on the examination request form.

For collection of stool specimens with preservatives for bacteriological examination (cholera culture, culture for other bacteria causing dysentery) see page 268.

2. Slide Preparation

MATERIALS

- Microscope slides
- Coverslips, 20 mm x 20 mm
- Wooden applicators, or wire loops (0.46 mm nickel-chromium alloy wire)
- Grease pencils
- Sodium chloride solution (reagent No. 45)
- Lugol iodine solution (reagent No. 36), diluted 5 times.

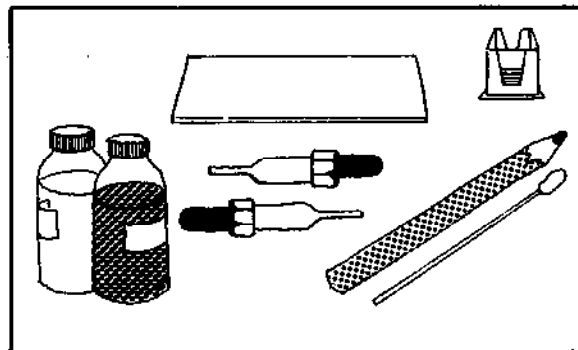

METHOD

1. Take a slide and put:
 - 1 drop of sodium chloride solution *in the middle of the left half*
 - 1 drop of the iodine solution *in the middle of the right half*.

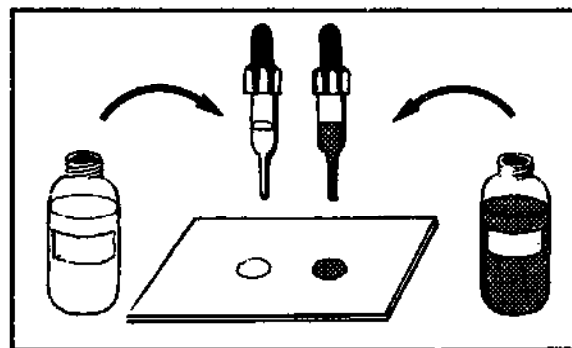

2. Using an applicator or wire loop, take a small portion (about this size: O) of the stool. If the stools:
 - are formed, take the portion from well inside the sample (parasite eggs?) and from the surface

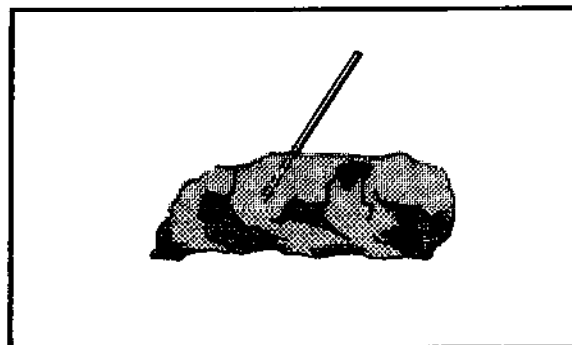

- contain mucus or are liquid, take the portion from the bloodstained mucus on the surface or from the surface of the liquid (amoebae?).

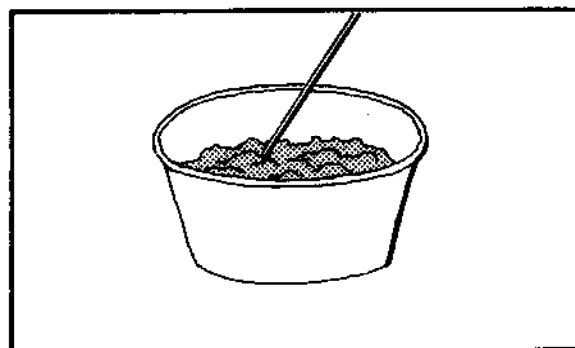

3. Mix the sample with the drop of sodium chloride solution on the slide.

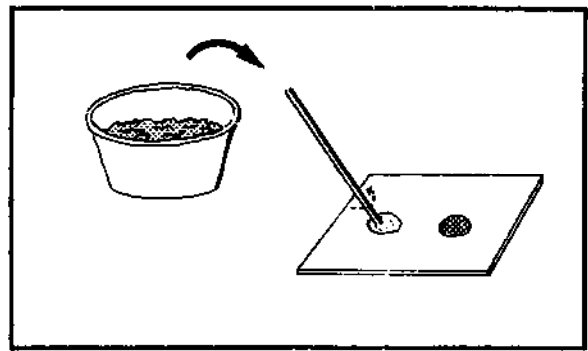

4. Using the applicator or wire loop, take a second portion of stool from the specimen and mix it with the drop of the iodine solution.

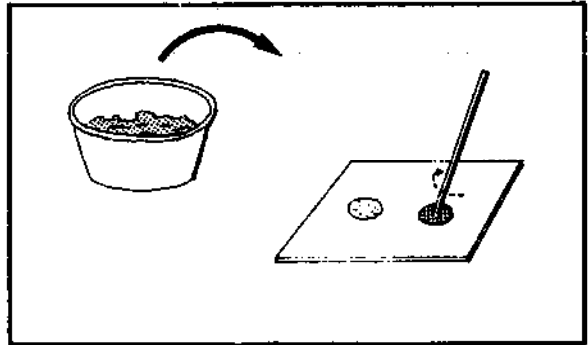

5. Place a coverslip over each drop (apply coverslips as shown to avoid the formation of air bubbles).

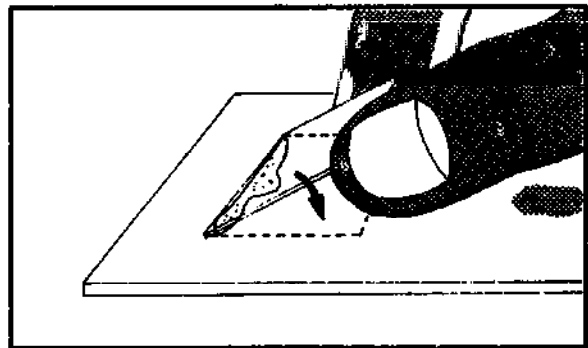

6. Mark the number of the specimen on the slide with a grease pencil.

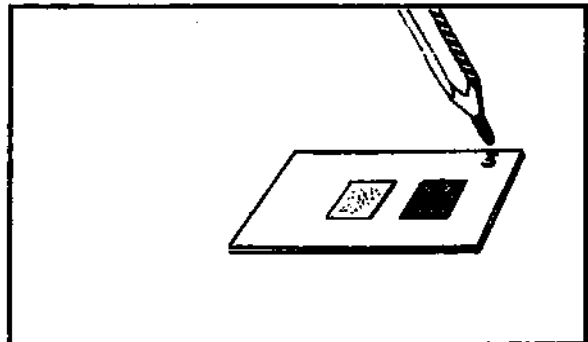

7. Examine the preparations under the microscope. For the saline preparation use x 10 and x 40 objectives and a x 5 or x 6 eyepiece. For the iodine solution preparation use a x 40 objective. As the eggs and cysts are colourless, reduce the amount of light using the condenser aperture or lower the condenser to increase the contrast.

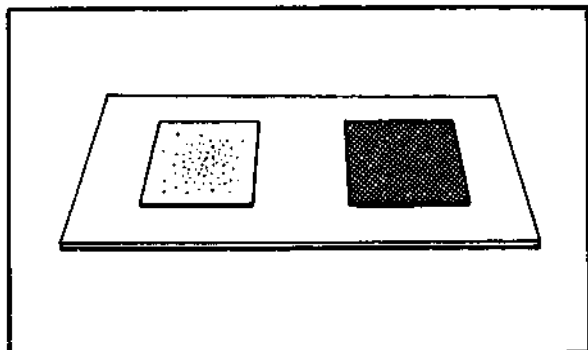

8. Examine the first preparation with the x 10 objective, starting at the top left-hand corner as indicated.

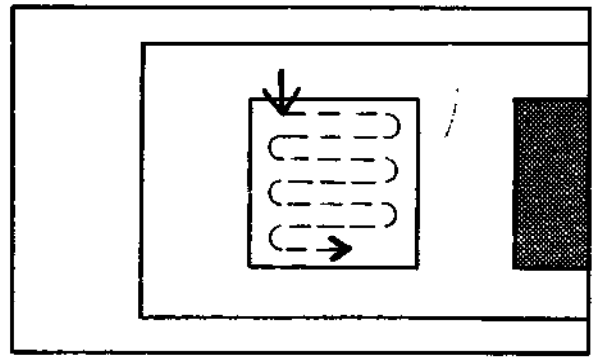

To ensure that no field is overlooked, pick an object on the edge of the field of view and move the slide across the microscope stage, examining the field, until the object reaches the other edge of the field. Repeat the procedure over the whole area.

For each field examined change at least once to the x 40 objective to check for the presence of protozoa, which are very small.

Then examine the iodine solution preparation with the x 40 objective.

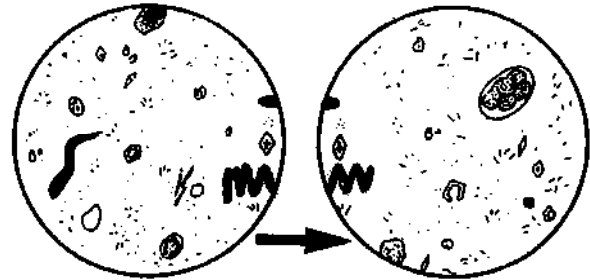

3. Special Technique for Pinworm Eggs

Principle

The eggs of the pinworm (*Enterobius vermicularis*) are usually collected (particularly in children) in the folds of skin around the anus. They rarely appear in the stools.

MATERIALS

- Adhesive cellophane tape
- Spoon 10 cm long or, better, a wooden tongue depressor
- Slide
- Microscope.

METHOD

1. Place a strip of cellophane tape, sticky side down, on a slide, as shown in the diagram.

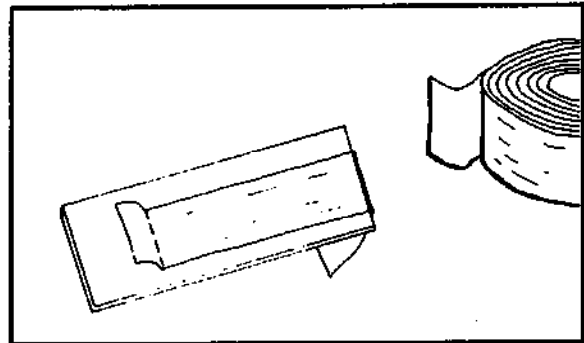

2. Place the spoon handle flat against the underside of the slide.

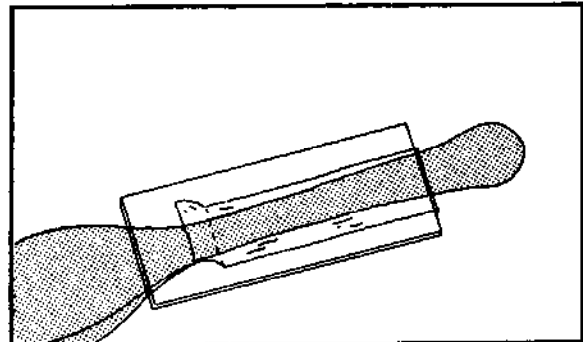

3. Gently pull the tape away from the slide and loop it over the end of the spoon handle.

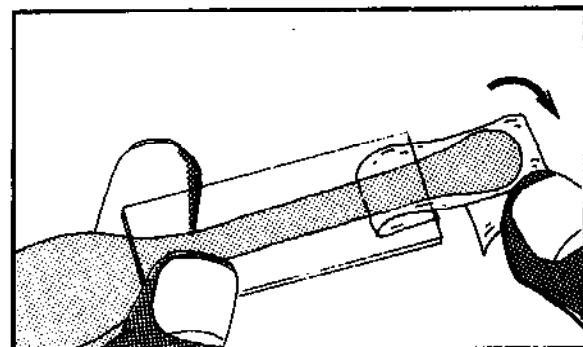

4. Hold the completed tape swab in your right hand, pressing the slide firmly against the spoon.

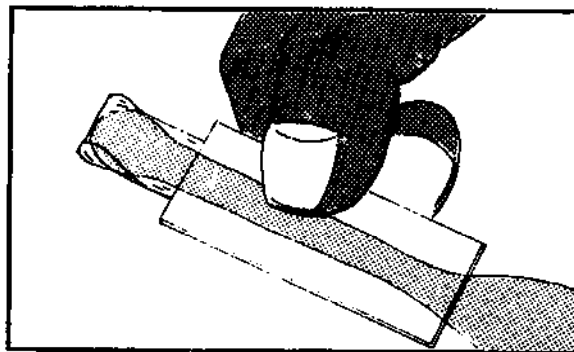

5. Separate the patient's buttocks with your left hand. Press the end of the spoon covered with tape against the skin round the anus in several places.

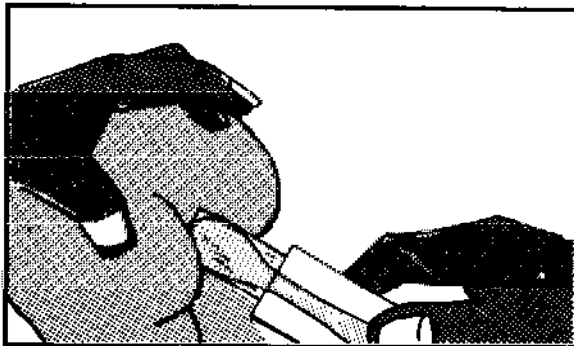

6. Take the slide and fold the tape back on to it, sticky side down.

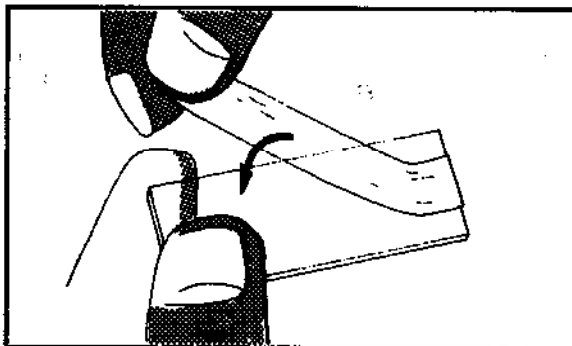

7. Make sure that the tape is firmly stuck flat to the slide by pressing it with a piece of cotton wool.

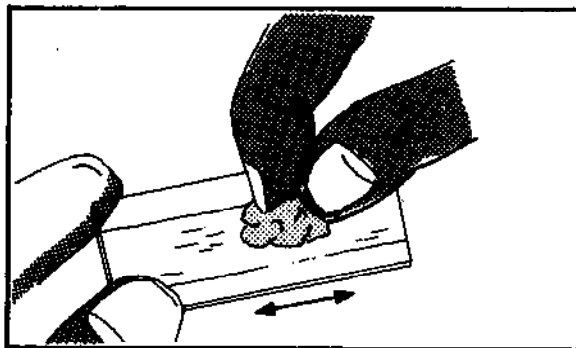

8. Examine under the microscope, with reduced condenser aperture, using a x 10 objective, for *E. vermicularis* eggs which have the following characteristics:

Shape: oval but asymmetrical (flattened on one side, rounded on the other)

Size: 50-60 μm

Shell: smooth and thin, but double line visible

Content: either a granular mass (1) or a curled-up embryo of the worm (2)

Colour: transparent, colourless.

For photographs of eggs see page 129.

(After the method of Melvin, D. & Brooke, M. *Laboratory procedures for the diagnosis of intestinal parasites*. Atlanta, US Department of Health, Education, and Welfare, Center for Disease Control, 1969, p. 138)

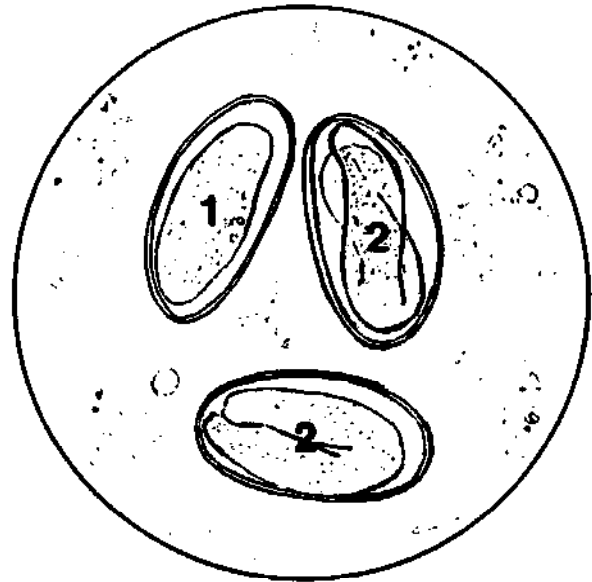

If no cellophane tape is available

1. Use a cotton wool swab.
2. Wipe round the anus (but not inside) with the swab.

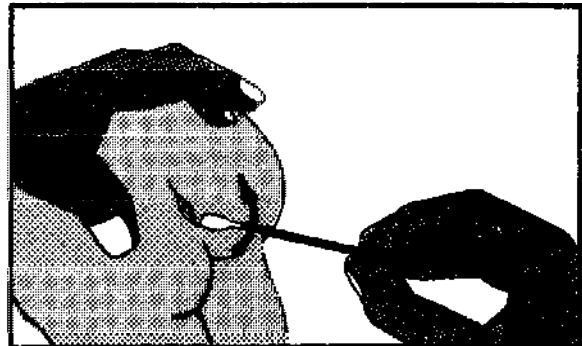

3. Dip the swab into a test tube containing about 0.5 ml (10 drops) of sodium chloride solution (reagent No. 45). Rinse the swab well in the solution.
4. Draw up the liquid with a Pasteur pipette. Transfer it to a slide, cover with a coverslip and examine as described in step 8 of the previous method (page 118).

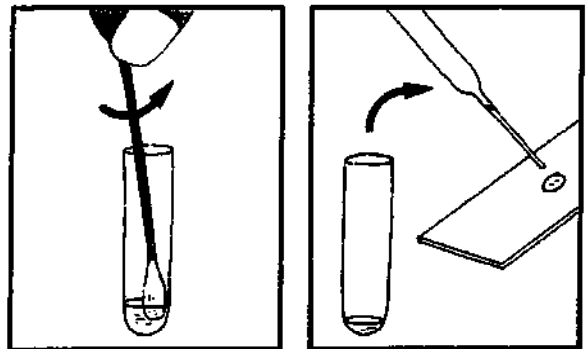

4. Eggs and Larvae of Intestinal Parasites

A. CHARACTERISTICS OF EGGS

Eggs laid by parasitic worms and found in stools are identified by:

- size
 - shape
 - shell
 - content
- and occasionally by
- colour
 - external features.

For example: the egg of *Schistosoma mansoni*

Size:	150 μm
Shape:	oval
Shell:	external shell, thin and turgid; internal shell, thin, membranous and less distinct
Content:	1 ciliated embryo
Colour:	pale yellow
External feature:	1 lateral spine

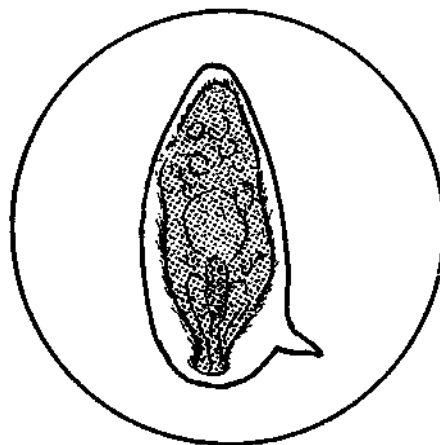

B. SIZE OF EGGS

The size can be estimated by comparison with that of a red blood cell, which measures 7.5-8 μm

$$1 \text{ micrometre (1 } \mu\text{m)} = \frac{1}{1000} \text{ of a mm.}$$

The size in μm given in this manual is that of the long side of the egg.

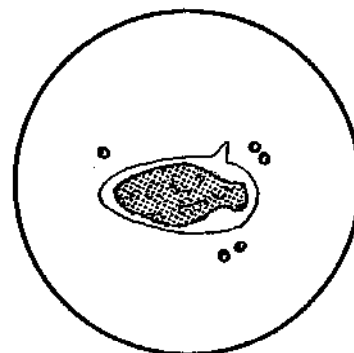

The size can also be assessed in relation to the microscopic field:

- using a x 10 objective, this egg takes up 1/10 of the field
- using a x 40 objective, this egg takes up 1/3 of the field.

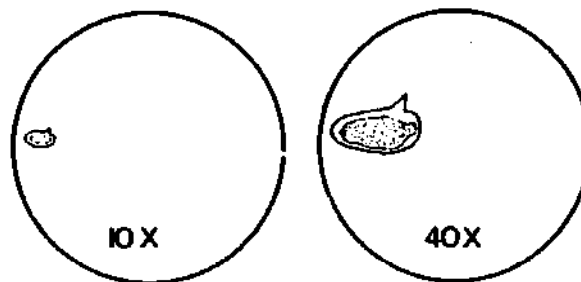

The egg can be measured by inserting a micrometer scale slide in the eyepiece of the microscope.

Another method is to compare the egg with one of another species common in the locality whose size under the microscope is known (hookworm, roundworm, etc.).

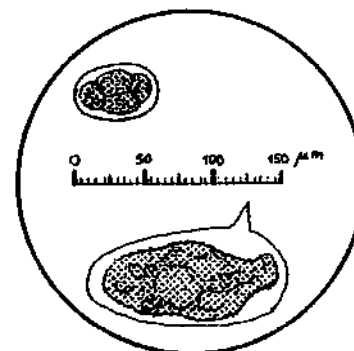

HOW TO RECOGNIZE EGGS

The method recommended is:

- (a) establish the probable identity of the egg from its general appearance
- (b) make a systematic study of all the characteristics of the egg to confirm its identity.

In order to gain experience (if possible, under the guidance of an instructor):

- study the different eggs found in the locality
 - identify, *one by one*, all the characteristics of each egg as described in the manual.
-

ALPHABETICAL LIST OF PARASITIC WORMS WHOSE EGGS ARE FOUND IN STOOLS

Alphabetical order

The parasites are set out in alphabetical order and not according to size, shape or other features, since methods of recognition by elimination can lead inexperienced technicians into error.

Numerical order

The eggs are numbered according to alphabetical order and described and illustrated in that order. At the end of the section (pages 140 and 141) the eggs are shown in a comprehensive table that can be used for a first rapid search.

Areas of the world

The area of the world where each egg is most commonly found is indicated. To avoid mistakes, always consult this information when you think you have found a rare species.

INTERNATIONAL SCIENTIFIC NAME (generic name & name of species)	COMMON NAME (English)
● 1. <i>Ancylostoma duodenale</i>	Hookworm
● 2. <i>Ascaris lumbricoides</i>	Roundworm, ascaris
3. <i>Clonorchis sinensis</i>	Chinese liver fluke
4. <i>Dicrocoelium</i> (various species)	Lancet fluke
5. <i>Diphyllobothrium latum</i>	Fish tapeworm
6. <i>Dipylidium caninum</i>	Dog tapeworm
7. <i>Enterobius vermicularis</i>	Pinworm, oxyuris
8. <i>Fasciola hepatica</i> (or <i>gigantica</i>)	Giant liver fluke
9. <i>Fasciolopsis buski</i>	Giant intestinal fluke
10. <i>Heterophyes heterophyes</i>	Small oriental fluke
11. <i>Hymenolepis diminuta</i>	Rat tapeworm
●12. <i>Hymenolepis nana</i>	Dwarf tapeworm
●13. <i>Necator americanus</i>	Hookworm
14. <i>Metagonimus yokogawai</i>	Japanese fluke
15. <i>Opisthorchis felineus</i>	Cat liver fluke
16. <i>Paragonimus westermani</i> *	Oriental lung fluke
17. <i>Schistosoma bovis</i>	—
●18. <i>Schistosoma haematobium</i> **	Schistosome (vesical)
●19. <i>Schistosoma intercalatum</i>	Schistosome (rectal)
●20. <i>Schistosoma japonicum</i>	Schistosome (oriental)
●21. <i>Schistosoma mansoni</i>	Schistosome (intestinal)
●22. <i>Strongyloides stercoralis</i> ***	Threadworm
23. <i>Taenia saginata</i>	Beef tapeworm
24. <i>Taenia solium</i>	Pork tapeworm
25. <i>Trichostrongylus</i> (various species)	—
●26. <i>Trichuris trichiura</i>	Whipworm

● = commonly found in many countries

* found chiefly in sputum

** found chiefly in urine

*** found chiefly as larvae in stools

Terms used for identification of eggs

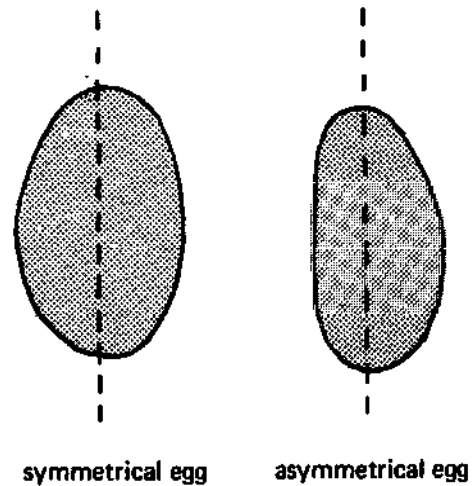
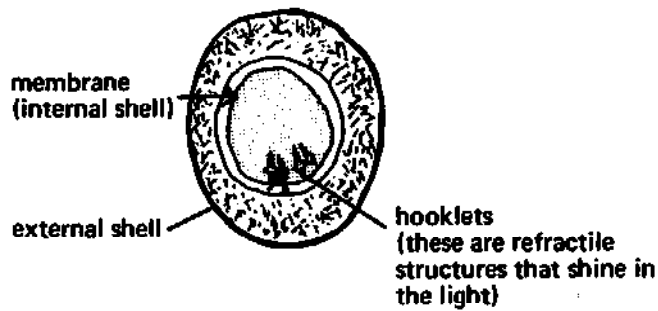
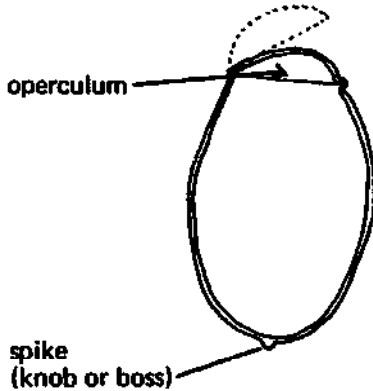
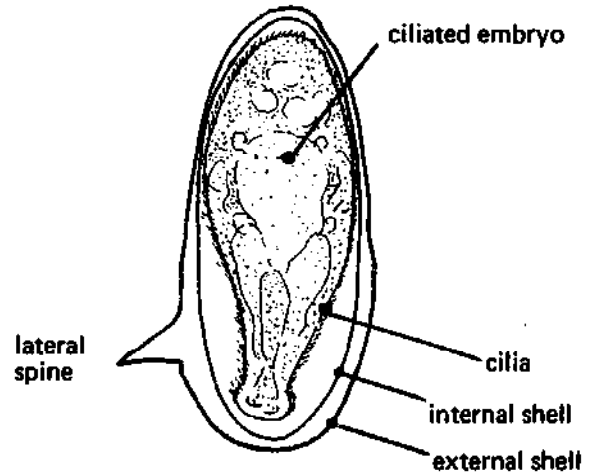
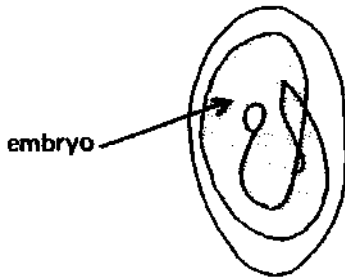
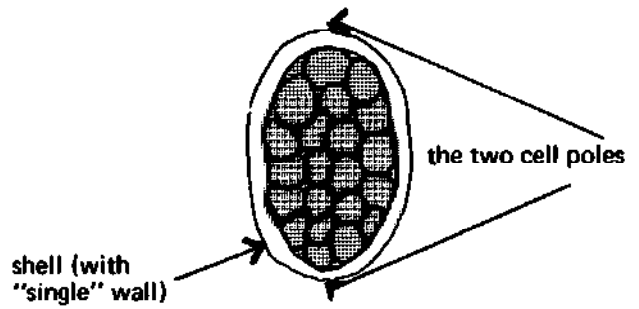
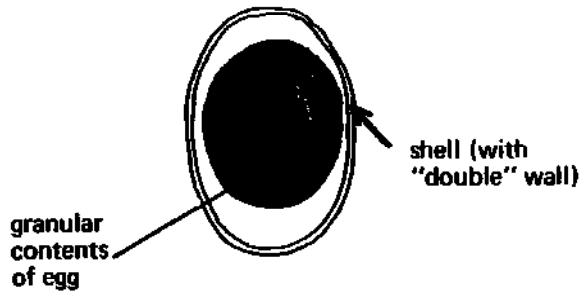

1 μm (micrometre) = $\frac{1}{1000}$ of a millimetre

1 red cell measures about 8 μm

Key to the identification of the most prevalent helminth eggs in tropical areas

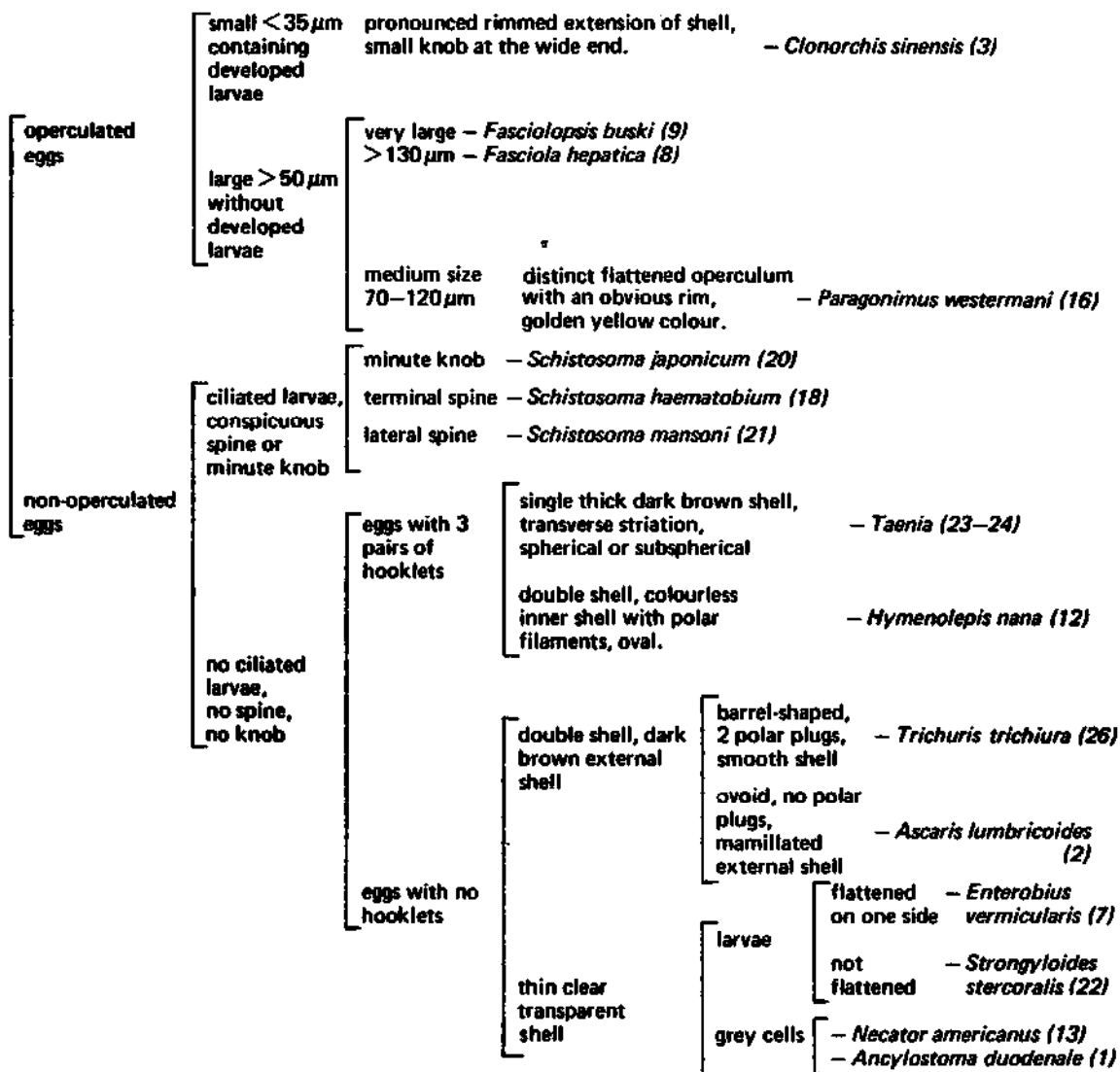



1. *Ancylostoma duodenale*

- Size** 50–60 μm
Shape oval with rounded slightly flattened poles (one pole often more flattened than the other)
Shell very thin; appears as a black line
Colour the cells inside are pale grey (iodine solution turns them dark brown)
Content varies according to the degree of maturity.

Type A (fresh stools):

4; 8 or 16 grey granular cells, clear but not refractile (blastomeres).

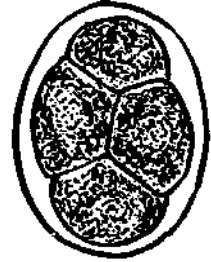

A

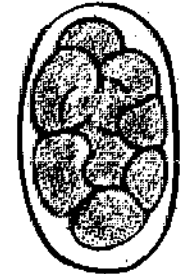

B

Type B (stools a few hours old):

A uniform mass of many small grey granular cells.

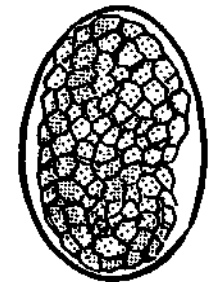

C

Type C (stools 12–48 hours old):

The whole of the egg is filled by a small larva (the future worm), wrapped around itself. The egg is "embryonate".

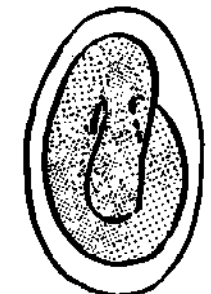
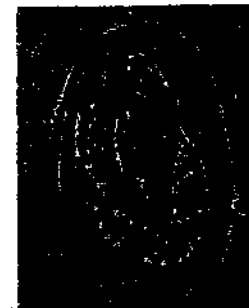

Roundworm
(Ascaris)

Whole world 

2. *Ascaris lumbricoides*

There are four types of ascaris egg:

- A. Fertilized egg with double shell
- B. Unfertilized egg with double shell
- C. Semi-decorticated fertilized egg (less frequent)
- D. Semi-decorticated unfertilized egg (very rare).

A. *Fertilized egg with double shell*

Size about 70 μm
Shape oval, or sometimes round
Shell the two shells are distinct:
 - the external shell is rough, brown, covered with little lumps (mammillated)
 - the internal shell is smooth, thick, colourless
Colour the external shell is brown and the contents of the egg are colourless or pale yellow
Content a single round granular central mass.

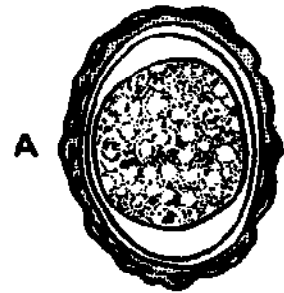
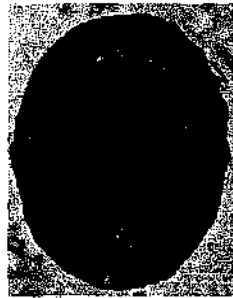

B. *Unfertilized egg with double shell*

Size about 80-90 μm (larger than type A)
Shape more elongated (elliptical or irregular)
Shell the two shells are indistinct:
 - the external shell is brown and puffy, with rather jagged lumps
 - the internal shell is thin (one or two lines may be visible)
Content the egg is full of large round very refractile (shiny) granules.

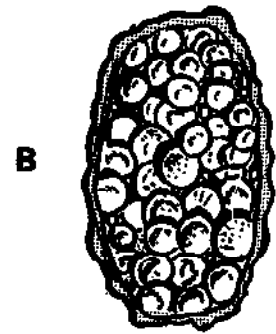

C. *Semi-decorticated fertilized egg*

Similar to type A but without the external shell.

Shell single, smooth, thick and colourless (or very pale yellow)
Content a single round colourless granular central mass.

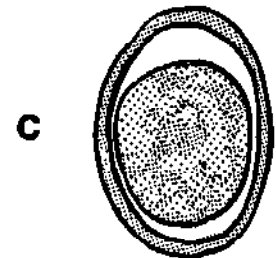

D. *Semi-decorticated unfertilized egg*

Shell a single smooth thin colourless shell (double line)
Content large roundish colourless refractile granules.
Caution: Do not confuse type D with the egg of *Ancylostoma* or the giant fluke.

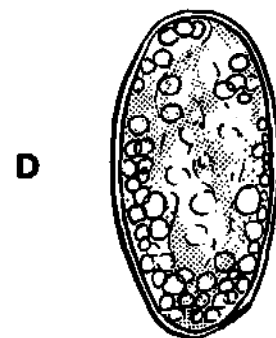



3. *Clonorchis sinensis*

Size	25–30 μm
Shape	distinctive (see illustration opposite)
Shell	fine and smooth but quite thick (double line)
Operculum	easily visible at the narrow end of the egg, fitting into a thickened rim of the shell
Boss	a small knob at the wide end of the egg (P)
Content	a well-organized ciliated embryo
Colour	shell yellowish-brown, contents pale yellow.

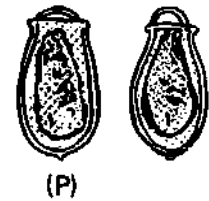

4. *Dicrocoelium* (various species)

Size	45–50 μm
Shape	oval, rather asymmetrical
Shell	thick, smooth, yellow, orange or light brown
Operculum	easily visible (O).

A. Eggs in passage* (form most often found):

The shell varies in colour; it may be yellow, orange or light brown. The egg contains an indistinct dark yellow oval mass, often with 1–4 refractile globules.

B. Eggs from infected patient (very rare):

The shell is a uniform dark brown. The egg contains a ciliated embryo.

Small fluke

Whole world

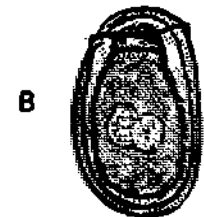
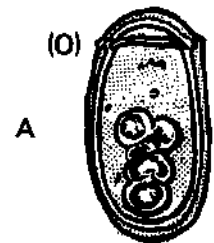
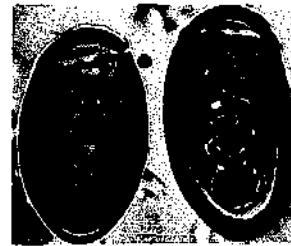

*Eggs in passage: The patient has eaten sheep or beef liver infected by the flukes. The eggs of the flukes are not digested and, although they appear in the patient's stools, he is not infected. Repeat the examination 8 days later, telling the patient not to eat liver or liver products in the meantime.

Fish tapeworm

Cold countries (especially)



5. *Diphyllobothrium latum*

Size	70 μm
Shape	regular oval
Shell	smooth and thin
Operculum	scarcely visible when not raised
Boss	very small, at the opposite end to the operculum
Content	a mass of small cells round a large central cell
Colour	pale yellow.

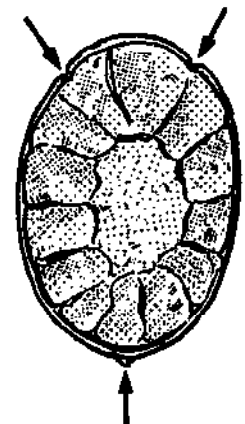

6. *Dipylidium caninum*

The eggs are found in clusters of 6-20 enclosed in a fine membrane.

Size	of the cluster: 150-300 μm of the egg: 30-40 μm
Shape	round
Shell	thick, slightly granulated, without striations
Content	a single uniform granular mass with 3 pairs of refractile hooklets arranged in the shape of a fan
Colour	yellow or pale grey.

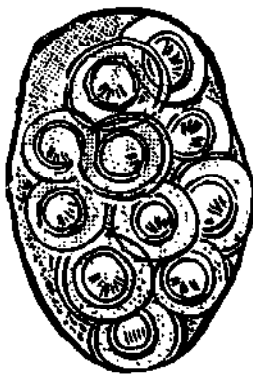
**7. *Enterobius vermicularis***

Size	50-60 μm
Shape	oval but clearly asymmetrical (flattened on one side, rounded on the other)
Shell	smooth and thin, but a double line is visible
Content	either (A) a small, granular mass in the shape of an irregular oval, or (B) the embryo of the worm, a small curled up larva
Colour	transparent, colourless.

The egg is usually more easily found in the folds of skin round the anus (see page 119).

Pinworm
(*Oxyuris*)Whole world 

A

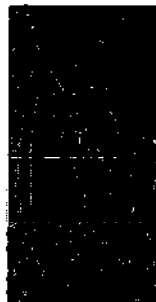
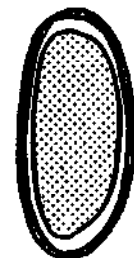

B



8. *Fasciola hepatica* (or *gigantica**)

- Size** *F. hepatica* – 130 μm
F. gigantica – 150 μm
- Shape** oval with rounded poles
- Shell** smooth and fine with a double line
- Content** a mass of large indistinct cells with clear, granular nuclei (adjust the screw of the microscope to change the focus)
- Colour** ranges from yellow to dark brown
- Other features** finely marked operculum (O) at one pole; the cell wall may be visibly retracted. Thickening (E) of a small part of the wall at the other pole.

The eggs are in small numbers in the stools (a search can be made by duodenal aspiration in doubtful cases). Cases of transmitted eggs are rare.

**F. gigantica*: found in tropical areas of Africa and Asia.

Giant liver fluke

Whole world

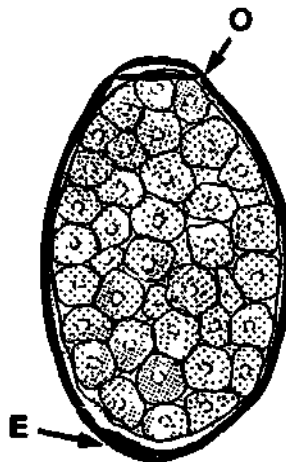
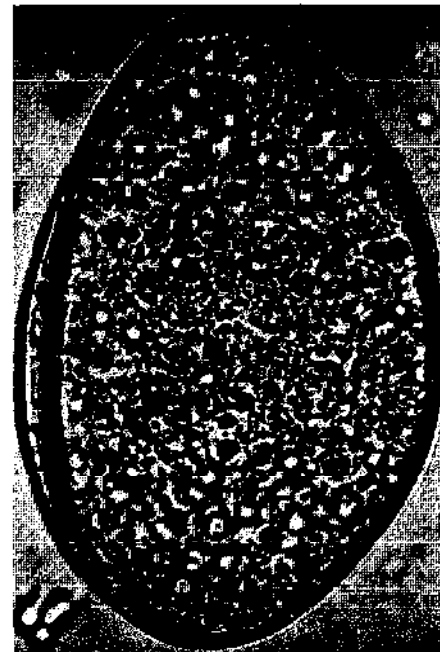

Giant intestinal fluke

Asia

9. *Fasciolopsis buski*

- Size** 140 μm
- Shape** oval
- Operculum** slightly smaller (O) than that of *Fasciola hepatica*.

Very similar to the egg of *Fasciola hepatica* but with the following differences:

- (a) **Shell** thinner, single line, with a marked thickening (E) of the wall at the opposite pole to the operculum
- (b) **Operculum** slightly smaller
- (c) **Content** cells may be refractile with one clear cell in the centre of the egg
- (d) **Quantity** the eggs are often present in large numbers in stools.

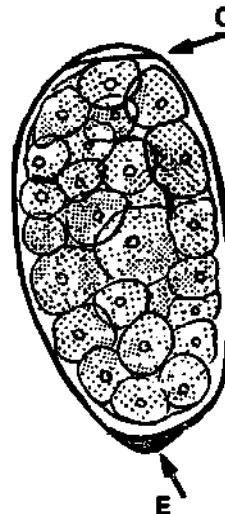

Asia
(mainly)



10. *Heterophyes heterophyes*

Similar to the egg of *Clonorchis sinensis*.

- Size** 25-30 μm
Shape more oval; the operculum does not overlap
Colour yellow to dark brown
Shell slightly thicker than that of *C. sinensis*
Boss tiny and wart-shaped, at the wider end of the egg; not always visible
Content a mass of cells, sometimes with large refractile granules (unfertilized) or a ciliated embryo.



Rat tapeworm

Whole
world



11. *Hymenolepis diminuta*

Rare species (found in children's stools)

- Size** 70-80 μm (much larger than *H. nana*)
Shape round
Colour transparent or pale yellow
Shell very thick:
- thin external shell with transverse lines
- very thick inner shell without filaments
Content a rounded embryo containing 6 hooklets arranged in fan shape.

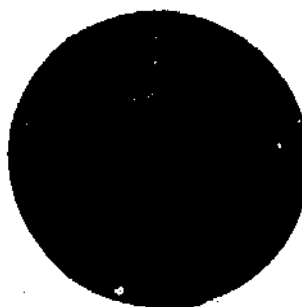

12. *Hymenolepis nana*

- Size** 45-50 μm
Shape oval, almost round
Shell double; external membrane thin and internal membrane often thicker at the poles, with filaments coming away from both poles (reduce light to see them), mixed with granules occupying the space between the two membranes
Colour very pale grey
Content rounded mass (embryo) with 6 refractile hooklets arranged in fan shape and often some well defined granules in the centre.

Important: Record whether there are many or few eggs present.

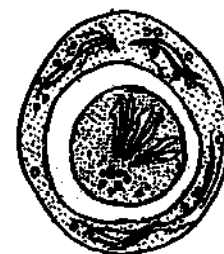
**Hookworm**Hot
countries **13. *Necator americanus***

The egg is almost identical with that of *Ancylostoma duodenale*.

- Size** a little longer (70 μm)
Shape poles more flattened
Content always contains at least 8 cells (never 4 like *A. duodenale* in fresh stools).

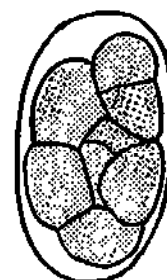
**14. *Metagonimus yokogawai***

Similar to the eggs of *Clonorchis sinensis* and *Heterophyes heterophyes*

- Size** 25-30 μm
Shape oval, with no marked bulge
Shell quite thick (the thickest of the three)
Operculum more rounded than in *H. heterophyes*; overlapping less than in *C. sinensis*
Boss at the other pole, tiny or invisible
Content a ciliated embryo.

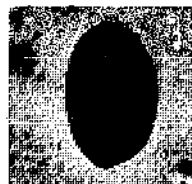
Far East 

15. *Opisthorchis felineus*

Also similar to the egg of *Clonorchis sinensis*

Size identical (25–30 μm)
Content a ciliated embryo

Some differences:

- (a) **Shape** Slightly less wide at the base and with less bulge; some eggs asymmetrical
- (b) **Operculum** less overlap
- (c) **Boss** rarely visible.



It is very difficult to differentiate between the eggs of the four oriental flukes:

- Clonorchis sinensis* squat shape, operculum with distinct overlap
- Heterophyes heterophyes* squat shape, darker colour
- Metagonimus yokogawai* thicker shell
- Opisthorchis felineus* narrow, often asymmetrical shape, boss not visible.

Oriental lung fluke

16. *Paragonimus westermani*

Eggs mainly found in sputum (if swallowed they pass into the stools).

- Size** 100 μm (smaller than the egg of the giant fluke)
- Shape** oval, often slightly flattened on one side
- Operculum** quite distinct, with an obvious rim (like a flat cap)
- Shell** distinct thickening at opposite end to operculum
- Colour** golden brown
- Content** clear central space surrounded by squarish cells.



17. *Schistosoma bovis*

Eggs found in the stools of patients who have eaten infected beef.

- Size** very large (200 μm)
- Shape** spindle-shaped, with narrowed extremities extending beyond the embryo
- Spine** long terminal spine
- Content** small round embryo lying in the centre of the egg but not filling it.

This worm does not cause disease in man.



Scale
reduced
by half



Schistosome (vesical)

Africa
Eastern Mediterranean

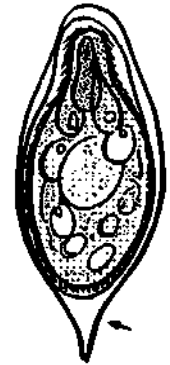

18. *Schistosoma haematobium*

Eggs found in urine (for detection, see page 178) and occasionally in stools.

- Size** 120-150 μm
- Shape** oval, with one well rounded pole
- Spine** terminal, and situated at the other pole
- Shell** smooth, very thin
- Colour** grey or pale yellow
- Content** a well-formed broad ciliated embryo surrounded by a membrane (internal shell).

Schistosome (rectal)

Africa

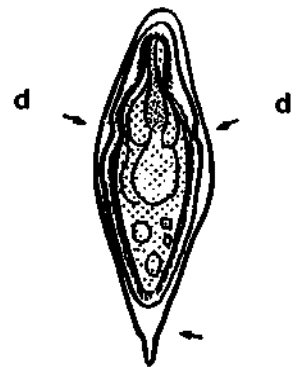

19. *Schistosoma intercalatum*

Similar in appearance to eggs of *S. haematobium*, but found in stools.

There are some differences:

- Size** slightly larger (150-180 μm)
- Spine** terminal spine longer and more tapered
- Shape** spindle-shaped; less broad (sides particularly flattened towards the rounded pole)
- Content** a ciliated embryo surrounded by a membrane with 2 depressions (d) or indentations, one on each side near the middle.

Schistosoma (oriental)



20. *Schistosoma japonicum*

- Size** 70-80 μm
Shape oval, almost round
Colour transparent or pale yellow
Spine difficult to see, lateral and very small; may be hidden by small granules (P) often found on the surface of the egg
Content a broad ciliated embryo.

Schistosoma (intestinal)

Africa south of the Sahara
Tropical America

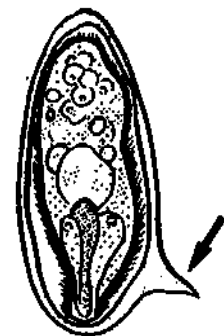
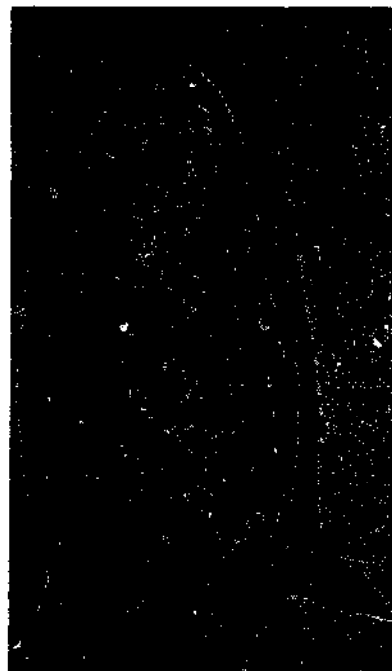

21. *Schistosoma mansoni*

- Size** 150 μm (= 3 eggs of *Ancylostoma*)
Shape oval, with one well rounded pole and one more conical pole
Spine lateral, near the rounded pole; large and triangular (if hidden underneath, adjust the focus of the microscope)
Shell smooth, very thin
Colour pale yellow
Content a broad ciliated embryo, surrounded by a membrane (internal shell) as in all *Schistosoma* species.

Threadworm

Hot
countries

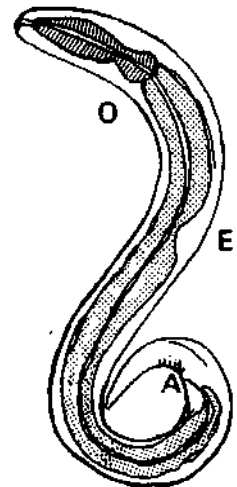

22. *Strongyloides stercoralis*: A. Larvae

The larvae are highly motile in the stools.

Size	200-300 μm long, 15 μm thick
Tail	moderately tapered
Mouth	short
Digestive tube	easily visible, with an oesophagus (O) with two swellings at one end and an anal pore (A) at the other

Genital primordium a rounded clear space near the middle of the larva (E).



Strongyloides stercoralis: B. Eggs

Threadworm eggs are seldom seen in formed stools because they hatch before evacuation to produce the larvae described above. They may, however, be found in *liquid stools* (and occasionally in the formed stools of carriers of certain strains).

The eggs are very similar to those of *Ancylostoma duodenale*.

Size	50 μm (slightly smaller)
Shape	similar to that of <i>Ancylostoma</i>
Shell	similar to that of <i>Ancylostoma</i>
Colour	similar to that of <i>Ancylostoma</i>
Content	a thick larva curled around itself one or more times and sometimes motile.

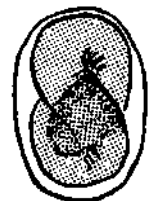
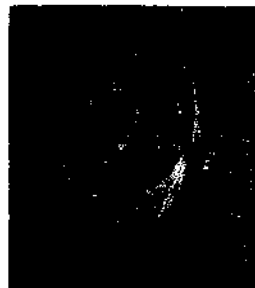

23. *Taenia saginata*

24. *Taenia solium**

The "eggs"*** of these two tapeworms are practically identical. They may be found in stools and *T. saginata* eggs can also be collected from the skin around the anus (see page 119).

- Size** 30–40 μm
Shape round
Shell very thick, smooth, with transverse lines (reduce illumination)
Colour – shell: dark yellowish-brown
– content: light yellowish-grey
Content a round granular mass enclosed by a fine membrane, with 3 x 2 refractile lancet-shaped hooklets (adjust the focus)
External sac sometimes the egg is enclosed in a floating transparent sac.

**Taenia solium* infection is mainly restricted to regions of low socioeconomic development in central and southern Africa, Latin America and Southern Africa.

**The correct term for these "eggs" is "embryophore": an embryonate egg that has lost its outer sac.

Tapeworms

Whole world 

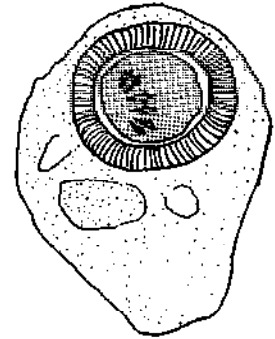
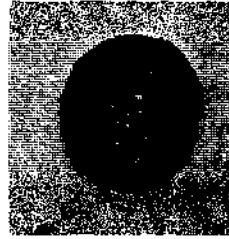

25. *Trichostrongylus* (several species)

Quite similar to eggs of *Ancylostoma duodenale*

- Size** 80–90 μm (slightly larger than *A. duodenale*)
Shape oval, asymmetrical:
– one pole rounded
– one pole narrower
Shell very thin, like *Ancylostoma* shell
Content in fresh stools: a mass of at least 20 small round granular cells. The egg quickly develops into an embryo.

Asia 

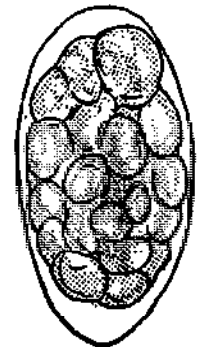

Whipworm

Whole world 

26. *Trichuris trichiura*

- Size** 50 μm
Shape barrel-shaped
Shell fairly thick and smooth, with two layers
Colour shell orange, content yellow
Other features a rounded, transparent plug at each pole
Content a uniform granular mass (sometimes divided in old stools).

Important: it is important to specify whether there are many or few whipworm eggs present.



NOT TO BE MISTAKEN FOR EGGS

1. Starch granules from plants

- Size** 50-100 μm
Shape round or oval and elongated, but the outline is *always irregular*, with rough indentations thick in places, very irregular, with cracks
Shell whitish or greyish-yellow; iodine solution turns it to violet
Content masses of starch packed closely.

These granules are the residue of starchy foods such as potatoes, beans, yams, cassava.

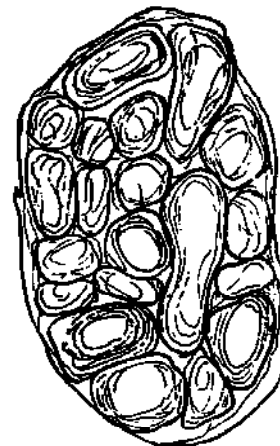

2. Digested meat fibres

- Size** 100-200 μm
Shape oval or rectangular with rounded corners
Colour yellow
Content transparent with no granulations or lines (or residual lines where meat is not properly digested).

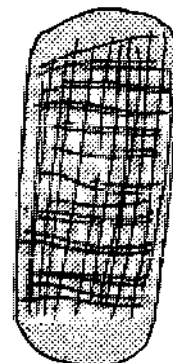
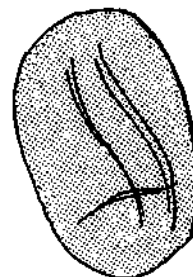

3. Soaps

- Size** 20-100 μm
Shape round, oval or irregular (like a section of a tree trunk)
Colour brownish-yellow or colourless
Content lines radiating from the centre and visible near the rim; nothing in centre.

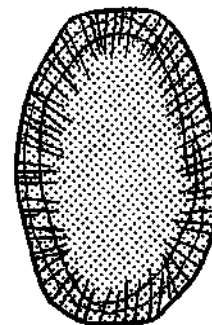

4. Air bubbles – oil droplets

- Size** variable (can be any size)
Shape perfectly round
False shell a circular ring, very refractile (several layers in the case of oil)
Content none.

Note the great differences of size present in the preparation.

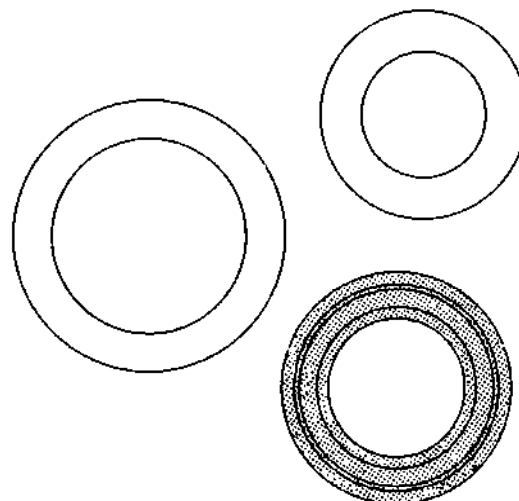



5. Plant hairs (50–300 μm)

Size very variable (50–300 μm)

Shape rather rigid, often curved; wide and clean-cut at one end, tapered at the other

Colour pale yellow







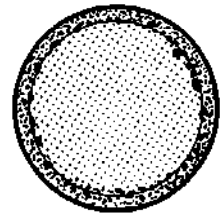
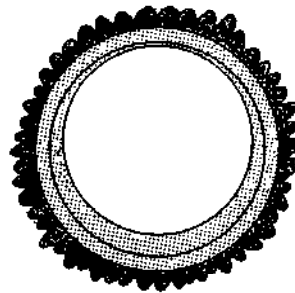
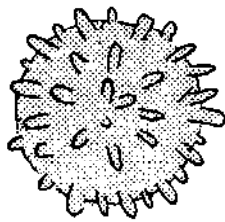





Content a narrow empty central canal between two transparent refractile layers.





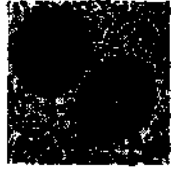



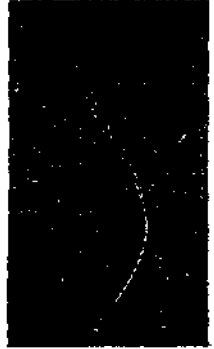



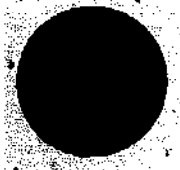

6. Pollen grains and fungus spores

Vary widely according to the part of the world and the diet. Their peculiar and distinctive geometrical shapes and other features (saw-like or rounded projections, etc.) help to distinguish them from the eggs of parasites.



COMMON EGGS and some confusing microscopical structures

<p style="text-align: right;">1 13</p>  <p style="text-align: center;">Hookworm</p>	<p style="text-align: right;">2</p>  <p style="text-align: center;">Roundworm (fertilized)</p>	<p style="text-align: right;">2</p>  <p style="text-align: center;">Roundworm (unfertilized)</p>	
 <p style="text-align: center;">Starch granule</p>	 <p style="text-align: center;">Soap</p>	<p style="text-align: right;">2</p>  <p style="text-align: center;">Roundworm (fertilized; semi-decorticated)</p>	<p style="text-align: right;">2</p>  <p style="text-align: center;">Roundworm (unfertilized; semi-decorticated)</p>
<p style="text-align: right;">26</p>  <p style="text-align: center;">Whipworm</p>	<p style="text-align: right;">12</p>  <p style="text-align: center;"><i>H. nana</i></p>	<p style="text-align: right;">23 24</p>  <p style="text-align: center;">Tapeworm</p>	<p style="text-align: right;">7</p>  <p style="text-align: center;">Pinworm</p>
<p style="text-align: right;">18</p>  <p style="text-align: center;"><i>S. haematobium</i></p>	<p style="text-align: right;">21</p>  <p style="text-align: center;"><i>S. mansoni</i></p>	<p style="text-align: right;">22</p>  <p style="text-align: center;">Threadworm (larva)</p>	 <p style="text-align: center;">Plant hair</p>

<p>4</p>  <p>Lancet fluke (from infected person)</p>	<p>4</p>  <p>Lancet fluke (in passage)</p>	<p>20</p>  <p><i>S. japonicum</i> (common)</p>	<p>3</p>  <p><i>C. sinensis</i> (common)</p>
<p>5</p>  <p>Fish tapeworm</p>	<p>11</p>  <p><i>H. diminuta</i></p>	<p>10</p>  <p><i>H. heterophyes</i></p>	<p>15</p>  <p><i>O. felinus</i></p>
<p>22</p>  <p>Threadworm (egg)</p>	<p>11</p>  <p>Fragment of meat (muscle fibre)</p>	<p>25</p>  <p><i>Trichostrongylus</i></p>	<p>14</p>  <p><i>M. yokogawai</i></p>
<p>19</p>  <p><i>S. intercalatum</i></p>	<p>16</p>  <p>Lung fluke</p>	<p>8</p>  <p>Giant liver fluke</p>	<p>9</p>  <p>Giant intestinal fluke</p>

HOW INFECTION BY INTESTINAL PARASITES OCCURS

It is useful for the laboratory technician to understand the ways in which infection by intestinal parasites can occur, so that he can give advice on hygiene to those around him and avoid infection himself, particularly in the laboratory.

Hookworm	by walking barefoot on ground contaminated by stools; by playing on the ground (children)
Roundworm	by eating raw vegetables and salads without washing them well; by playing on infected ground (children)
Threadworm	by walking barefoot on ground contaminated by stools; by autoinfection;* <i>in the laboratory</i> , by touching stools with the hands
Schistosomes	by bathing in streams or ponds contaminated by stools or urine
Fish tapeworm	by eating undercooked lake or river fish
Flukes:	
– <i>giant flukes</i>	by eating unwashed salads
– <i>lung flukes</i>	by eating undercooked river crabs
– <i>lancet flukes</i>	by swallowing infected ants (in unwashed salads or in playing in grass — children)
– <i>oriental flukes</i>	by eating undercooked river fish
Pinworm	by contact with infected persons with dirty hands (children playing together) and by auto-infection
Beef and pork tapeworms	by eating undercooked infected meat
Cysticercus of pork tapeworm	by eating raw, unwashed vegetables or by autoinfection
Dog tapeworm	by swallowing the fleas of an infected dog (children)
Dwarf tapeworm	by eating contaminated vegetables; by contact with persons who have infected themselves; and <i>in the laboratory</i>
Rat tapeworm	by swallowing rat fleas
Whipworm	by eating unwashed vegetables and salads
Trichostrongylus	by eating unwashed salads (Asia).

Protozoa**

Entamoeba histolytica and *Giardia lamblia*

by drinking contaminated water, eating unwashed salads, contact with infected persons with dirty hands, and failure to observe the rules of cleanliness *in the laboratory*

Balantidium coli by eating unwashed vegetables; by contact with pigs (farms).

*Auto- or self-infection: the patient reinfects himself, thus perpetuating his disease.

**For identification of intestinal protozoa, see pages 147 and 155.

5. Adult Worms Found in Stools

Worms brought to the laboratory for identification may have been found in stools, in clothing or bedlinen, or during a surgical operation.

What to examine:

- their length
- their shape
- whether flat, segmented or not
- whether cylindrical (round) or not.

A. COMMON ROUNDWORMS

1. Large Roundworm – Ascaris

Colour pinkish
Thickness 0.3-0.5 cm
Length male – about 15 cm, with a curled tail
female – 20-25 cm, with a straight tail

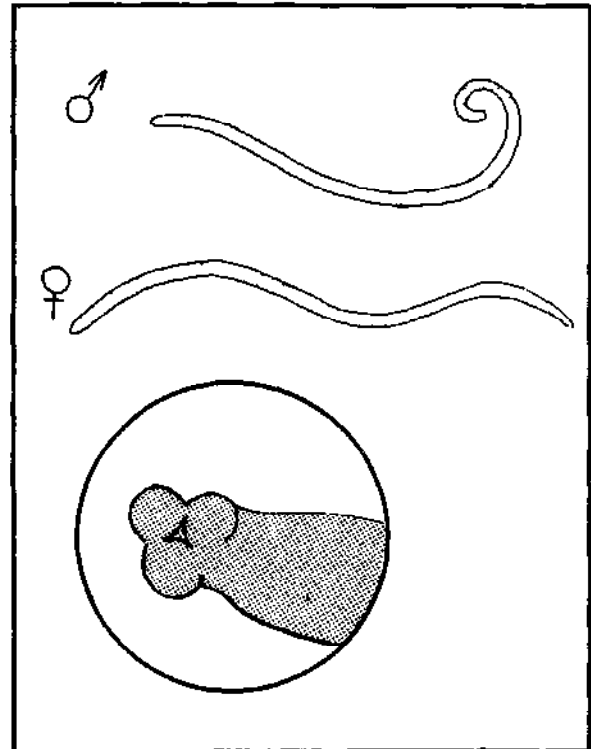

2. Small Roundworm – Pinworm

Colour white
Length female – 1 cm, with a very pointed tail
male – 0.5 cm (males are less common).

Pinworms are found in large numbers, especially in children's stools, and are motile. They may also be found in the folds of skin round the anus, where they are collected with a strip of adhesive cellophane tape (see page 119).

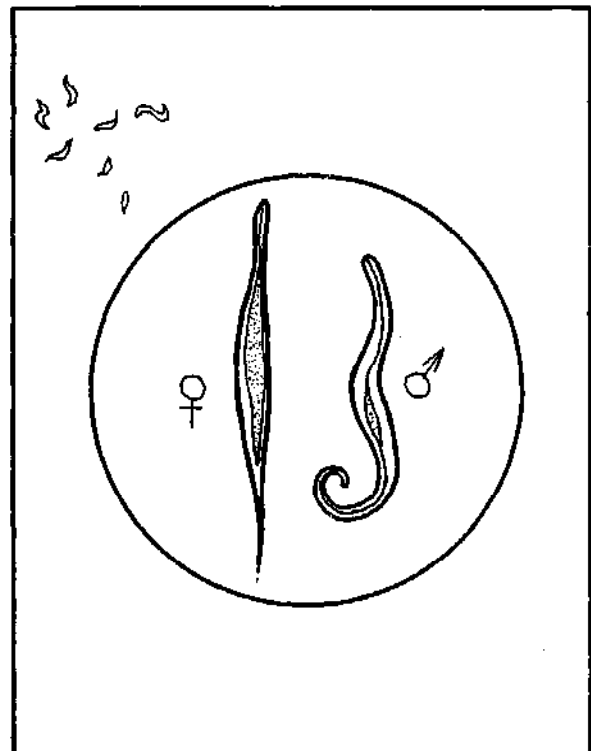

B. SEGMENTED FLATWORMS – TAENIAE

Colour ivory white or pale blue
Length total worm, 3–10 m; but single mature segments (1–3 cm long) or fragments of the chain, quite variable in length, are usually presented for examination.

Important

If there is a delay in examination, separate pieces may dry up and roll around themselves, looking like roundworms. Moisten them with water to restore their shape.

Examination

1. Examine a *chain of segments* to observe the arrangement of the lateral pores.
2. Examine a *single segment* gently flattened between two slides.

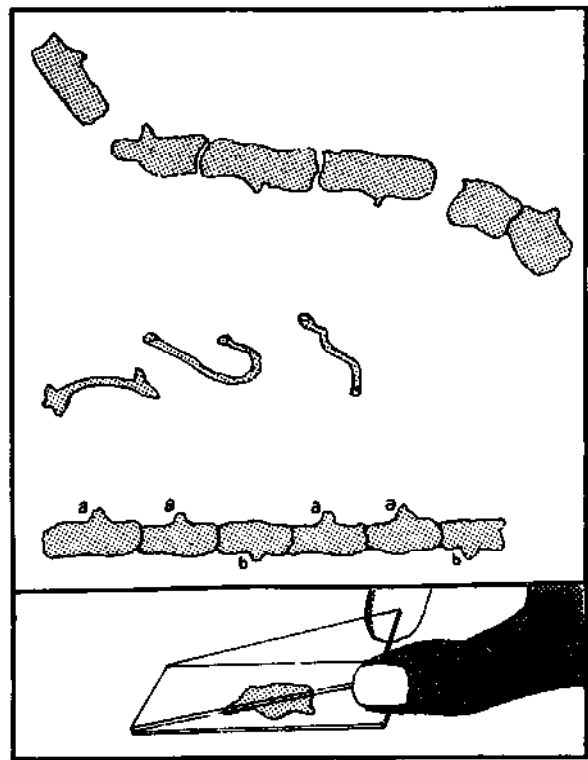

Hold the slide against the light to observe and count the uterine branches with the naked eye.

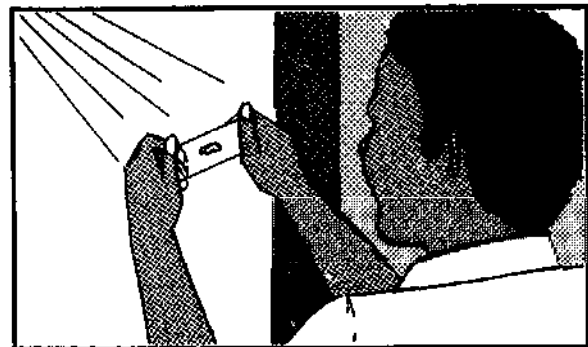

3. *To examine the head (scolex):*



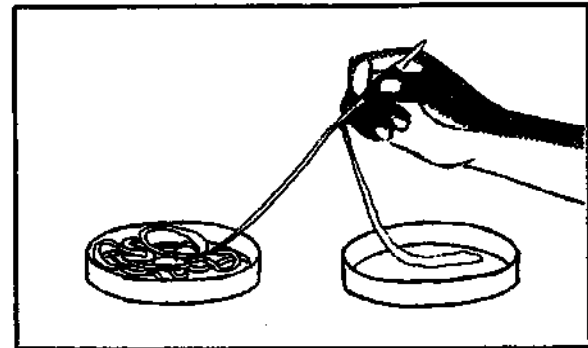



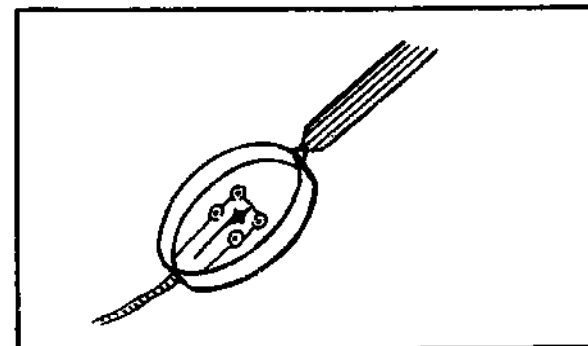

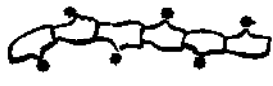

- place the whole worm in a Petri dish filled with water (or on a plate)
- using forceps, transfer the worm little by little into another dish; untangle it, starting with the thicker end



- if at the end of a very narrow section (the neck) a swelling the size of a small pinhead is found, examine it with a magnifying glass or under the microscope (x 10 objective). The head is rarely found.

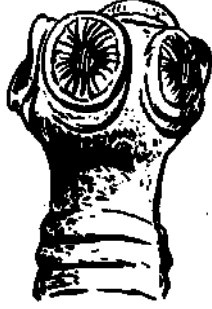

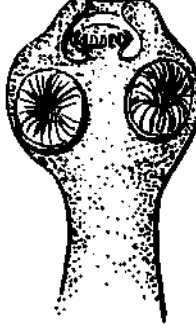
C. FLATWORMS – TAPEWORMS – HOW TO IDENTIFY

Most common	Less common		
BEEF TAPEWORM <i>(Taenia saginata)</i>	PORK TAPEWORM <i>(Taenia solium)</i>	DWARF TAPEWORM <i>(Hymenolepis nana)</i>	DOG TAPEWORM <i>(Dipylidium caninum)</i>
<p>Single rectangular segments found in underclothes and in the bed; they pass through the anus independently of the stools</p> <p>They are part of an intestinal worm 3-5 m long</p>	<p>Small chains of 3-4 rectangular segments found in the stools</p>	<p>A small worm 2-4 cm long</p>	<p>A worm 5-30 cm long</p>
 <p>Pores arranged in irregular alternation</p>	 <p>Pores generally arranged in regular alternation</p>	 <p>Pores all on the same side</p>	 <p>Two pores on opposite sides of each segment</p>
<p>Ivory white segment of 1-2 cm</p>  <p>About 20 uterine branches</p>	<p>Pale blue segment of 0.5-1.5 cm</p>  <p>About 10 uterine branches</p>	<p>1 mm wide</p>  <p>Uterine branches hardly visible</p>	<p>Reddish segment of 0.3-0.5 cm</p>  <p>Two bunches of uterine branches</p>
 <p>4 suckers (2 mm diameter) Very thin neck</p>	 <p>2 crowns of hooklets – 4 suckers (1 mm diameter)</p>	 <p>1 invaginated crown of hooklets – 4 suckers (0.5 mm diameter)</p>	 <p>4 external crowns of hooklets – 4 suckers (0.5 mm diameter)</p>

OTHER TAPEWORMS:

Dibothriocephalus is found mainly in cold climates.

Echinococcus is found in dogs; only the hydatid cyst is found in man.

D. OTHER WORMS

Rarely found in the stools. Occasionally found in a patient's organs during a surgical operation. Flukes are found in the liver and intestines.

Hookworm

A small round worm (like a piece of thread).

Length 1-1.5 cm

Colour white, or red if it contains blood.

Resembles the pinworm.

Examine the head under the microscope (x 10 objective).

Actual size

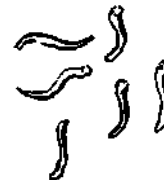

Under a magnifying glass (or microscope)

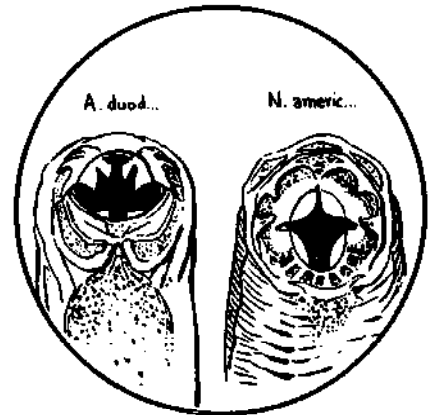

Whipworm

A small thin worm.

Length 3-5 cm

Colour white.

Looks like a tiny whip, one third being relatively thick and the rest thread-like.

The worm lives in the wall of the caecum or, occasionally, the rectum.

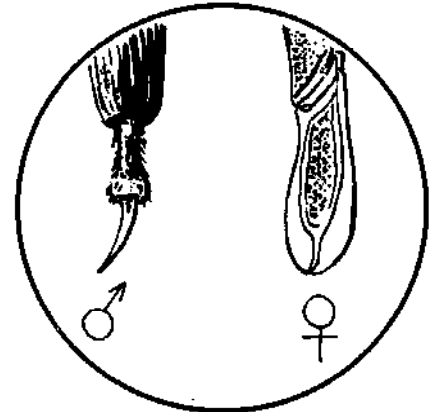

Fluke

A flat worm with two suckers; looks like a leaf.

Large fluke 2-3 cm long, fairly broad, brownish-red or dull white (LF)

Small fluke 0.5-1 cm long, narrower, transparent, greyish-red (SF).

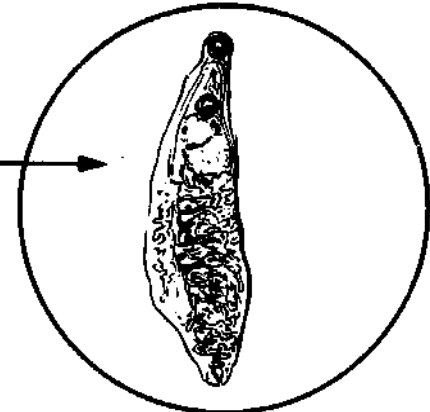

Schistosome

A small thin worm.

Length 0.5-1.5 cm

Colour white.

The flat male is rolled around the thread-like female worm, which is a little longer. Each worm has two suckers near the head.

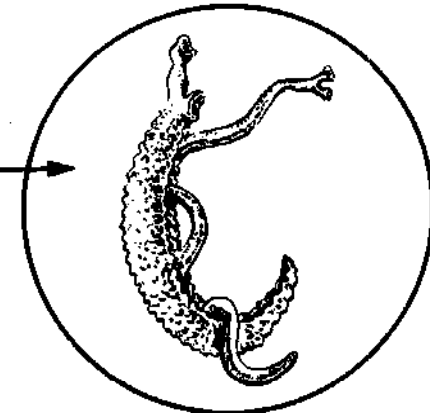

6. Amoebae, Flagellates and Ciliates: Motile Forms

Definitions

Protozoa are microorganisms consisting of a single cell. They may be found in stools in their motile form (trophozoites) or as cysts.

The trophozoites of protozoa are motile:

- either because of slow movements of the cell (amoebae)
- or because they have rapidly moving flagella (long whip-like threads) or cilia (numerous short hairs).

Protozoa in motile form are chiefly found in:

- fluid stools
- stools containing mucus
- soft unformed stools.

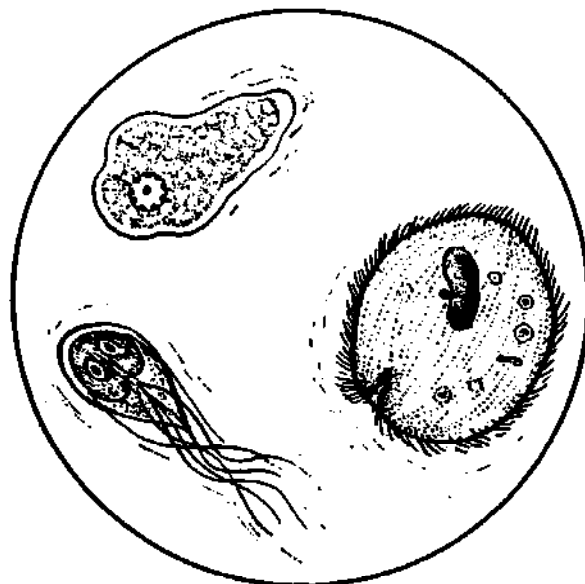

Classification

Without flagella or cilia	AMOEBAE
With flagella	FLAGELLATES
With cilia	CILIATES

Preparation of slides for examination

1. Examine only fresh stools (maximum 1 hour old; amoebae become non-motile very quickly).
2. If you receive a number of stool specimens at once, begin by examining the most fluid specimens containing mucus.
3. Take a portion from the outside of the stool where mucus appears.
4. Examine in a sodium chloride solution (reagent No. 45), warming slightly in low temperatures, or examine directly if the stools are very liquid. Use the x 40 objective.
5. In iodine solution (reagent No. 36) the trophozoite forms become non-motile. The nucleus is clearly stained but it may be difficult to distinguish between trophozoite and cystic forms.
6. If a drop of eosin, 20 g/l solution in saline (reagent No. 21) is added, the whole field becomes stained except for the protozoa (particularly amoebae), which remain colourless and are thus easily recognized.

List of intestinal protozoa

Some intestinal protozoa are pathogenic; others are less so or are harmless. All these parasites are found throughout the world.

A. AMOEBAE

1. *Entamoeba histolytica* This amoeba, which may cause dysentery or abscesses, is the only amoeba that is commonly pathogenic in man
2. *Entamoeba coli* Non-pathogenic, but very common
3. *Other amoebae:* Non-pathogenic.
 - *Entamoeba hartmanni* They are difficult to differentiate but differentiation is not really necessary; it is enough to be able to distinguish them from *E. histolytica*.
 - *Endolimax nana*
 - *Iodamoeba butschli*
 - *Dientamoeba fragilis*

B. FLAGELLATES

1. *Giardia lamblia* Pathogenic
2. *Trichomonas hominis* Non-pathogenic
3. *Chilomastix mesnili* Non-pathogenic.

C. CILIATES

1. *Balantidium coli* Pathogenic.

The chief problem for the laboratory, therefore is:

- the precise identification of: *E. histolytica*
G. lamblia
B. coli

Some features useful for the recognition of motile forms of intestinal protozoa

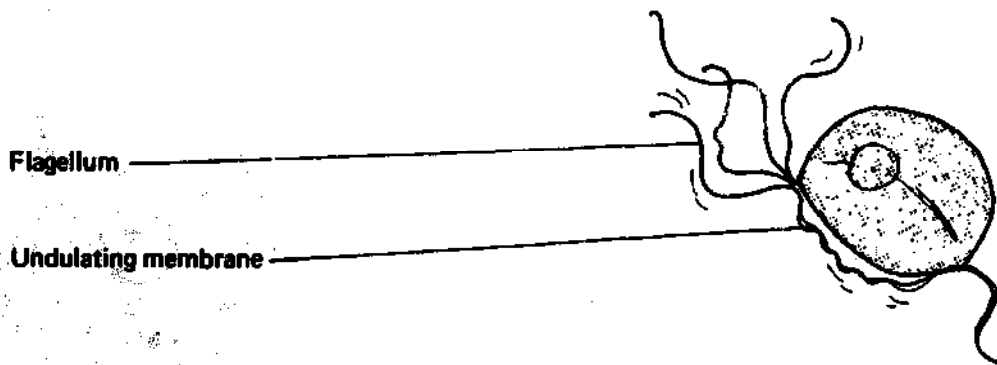
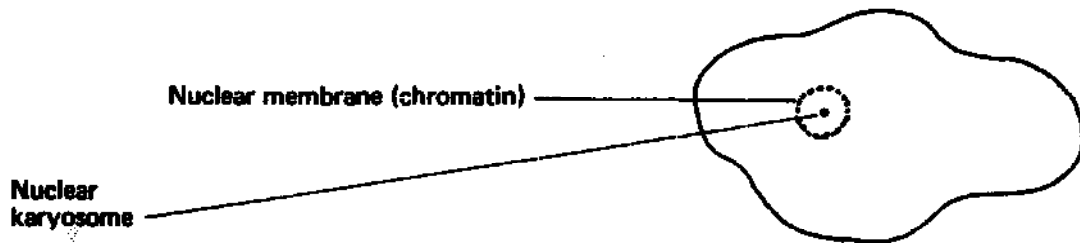
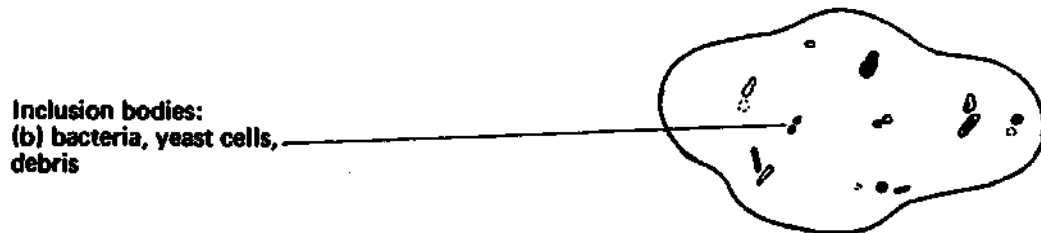
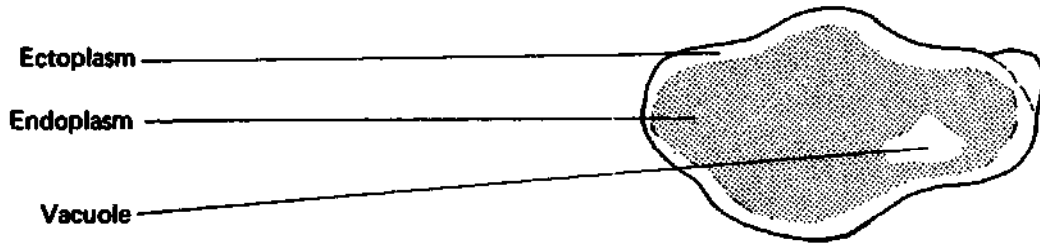
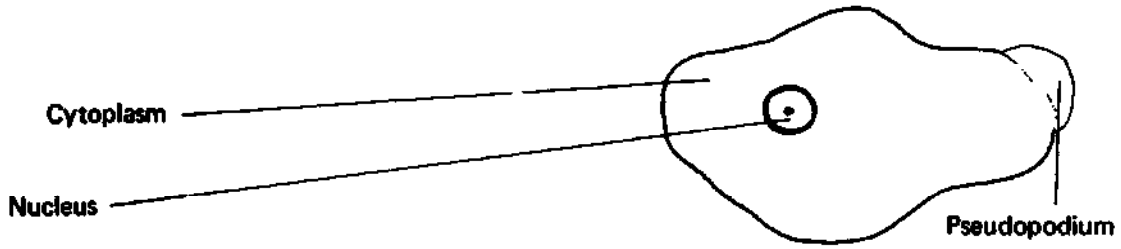

A. AMOEBAE

1. *Entamoeba histolytica* (dysentery amoeba)

Size	varies from 12 to 35 μm (usually as long as 3 or 4 red blood cells)
Shape	when moving, elongated and changing; when not moving, round
Motility	moves in <i>one direction</i> ; a pseudopodium pushes forward and the endoplasm flows quite rapidly into it
Cytoplasm	the ectoplasm is <i>transparent</i> , quite different from the fine granular texture of the endoplasm (greyish, shot with yellowish-green), which may contain vacuoles
Nucleus	not visible in the motile form, but when stained with iodine solution clearly seen to have a regular membrane and a small dense central karyosome (a black dot).

Two motile forms of *E. histolytica* can be found in liquid or diarrhoeal faeces:

- the *magna* form, measuring 20–35 μm , with vacuoles containing more or less digested red blood cells (1 to 20 of different sizes) indicating haematophagous (blood-eating) activity and so pathogenic capability;
- the *minuta* form, non-pathogenic, thriving in the intestinal cavity, where it eats bacteria or other local material that can be seen inside the vacuoles; measures 12–20 μm .

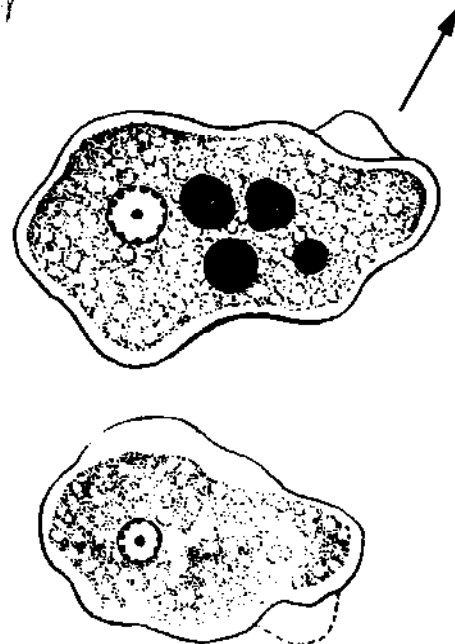

2. *Entamoeba coli*

Size	20–40 μm (usually bigger than <i>E. histolytica</i>)
Shape	oval or elongated, rather irregular
Motility	often non-motile or moving very slowly, putting out blunt pseudopodia in all directions, gropingly
Cytoplasm	both the ectoplasm and the endoplasm granular and difficult to differentiate
Inclusion bodies	numerous and varied (bacteria, yeast cells, debris of all sorts), but never red blood cells
Nucleus	visible in the fresh state, without staining. The membrane is irregular and granular (like a bead necklace), the karyosome large and eccentric.

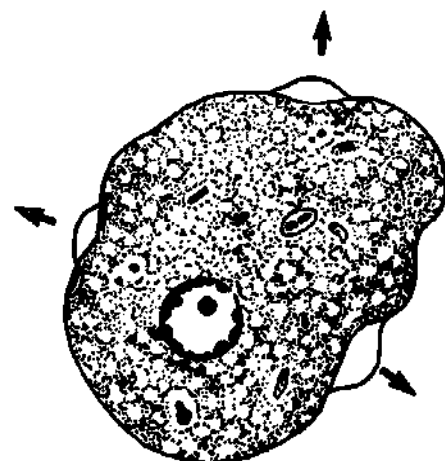

	Dysentery amoeba <i>Entamoeba histolytica</i>	Amoeba of the colon <i>Entamoeba coli</i>
Motion	In a definite direction	Haphazard
Motility	Fairly motile	Non-motile or barely motile
Ectoplasm	Transparent, quite different from the endoplasm	Little or no differentiation from the endoplasm
Inclusion bodies	Red blood cells if haematophagous	Bacteria, yeast cells and various debris, no red blood cells
Nucleus (fresh state)	Invisible	Visible (nuclear membrane like a bead necklace)
Nucleus (after staining with iodine solution)	Regular membrane Small dense central karyosome	Irregular membrane Large eccentric karyosome

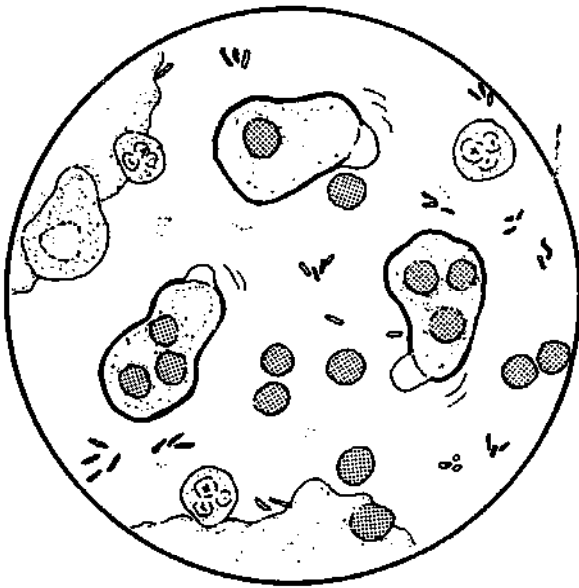

Entamoeba histolytica

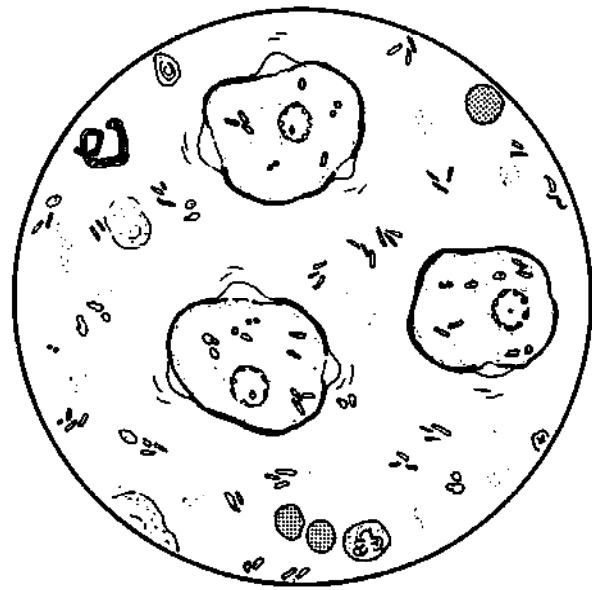

Entamoeba coli

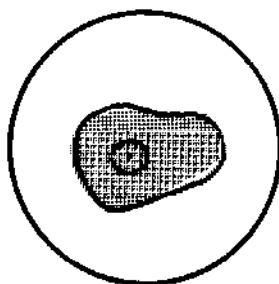

(stained with iodine solution)

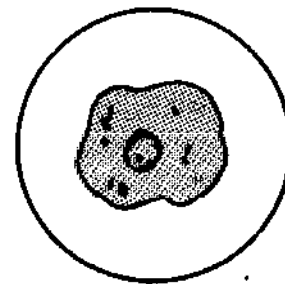

3. Other Amoebae

Entamoeba hartmanni

Size small, always less than 10 μm (about the size of a red blood cell)

All characteristics similar to those of *E. histolytica* but never contains red blood cells. There may be distinct vacuoles.

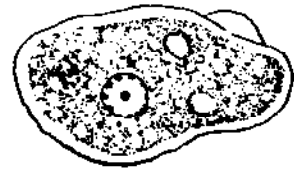

Endolimax nana

Size small, 6-10 μm

Motility many small rounded pseudopodia moving slowly in all directions

Cytoplasm very granular with small vacuoles

Inclusion bodies various (mainly bacteria)

Nucleus (iodine solution) karyosome like an ink-spot.

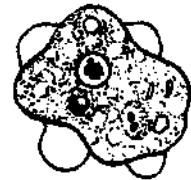

Iodamoeba butschli

Size medium-sized, 10-15 μm

Shape compact, leaf-like

Motility very slow; clear, rounded or finger-shaped pseudopodia

Inclusion bodies bacteria, large vacuoles

Nucleus (iodine solution) a large oval karyosome next to a group of granules.

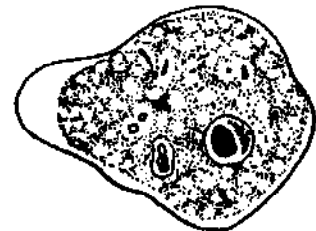

I. butschli amoebae are rarely seen in stools.

Dientamoeba fragilis

Size small, round, 6-15 μm

Motility either non-motile (most often), or very motile (in very fresh fluid stools), with pseudopodia like the blades of an electric fan; quickly becomes non-motile under the coverslip

Cytoplasm clear ectoplasm

Inclusion bodies bacteria

Nucleus (iodine solution) 1 or 2 nuclei; karyosomes split into 4-6 granules (membrane hardly visible).



B. FLAGELLATES

All these parasites, with the exception of *Trichomonas hominis*, can appear in an active flagellate vegetative form or as inactive cysts. The cysts are described on page 158).

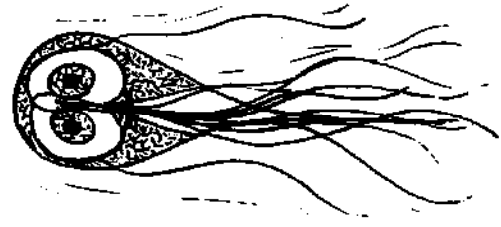

1. *Giardia lamblia* (the longest flagellate)

Size 10-18 μm (size of 2 red blood cells)
Shape rather elongated:
front view: like a pear
side view: spoon-shaped
Motility either moves forward in little rapid jerks in a definite direction, sometimes turning in a loop (fluid stools), or hardly motile
Content 2 large oval nuclei, faintly visible.

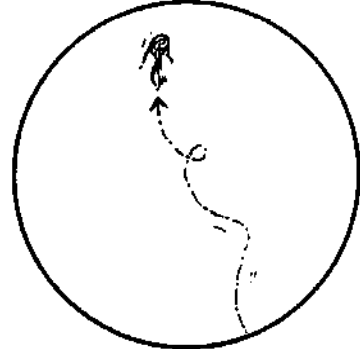

Important:

- the characteristic movement is seen only in fresh liquid stools
- flakes of mucus in fluid stools often contain clusters of *G. lamblia* in large numbers
- the vegetative and cystic forms of *G. lamblia* are often found together in soft stools.

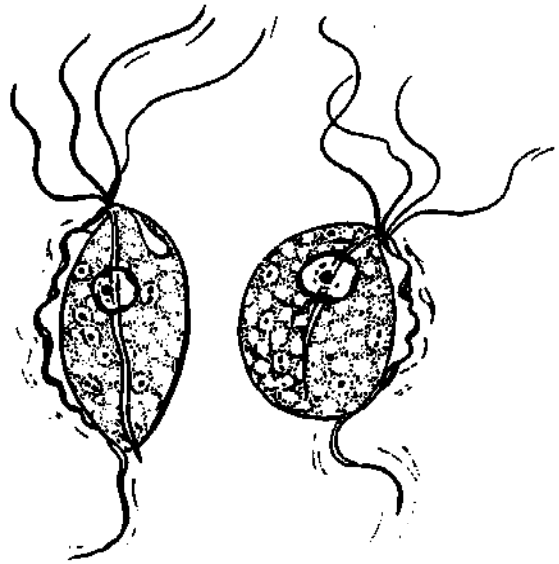

2. *Trichomonas hominis*

Size 10-15 μm (slightly smaller than *G. lamblia*)
Shape oval with 2 pointed poles
Motility whirls and turns in all directions, seeming to vibrate
Undulating membrane present on one side only; extremely motile (a rapid wavy movement)
Nucleus 1 nucleus, difficult to see
Flagella usually 4.

Trichomonas is the most resistant flagellate. It remains motile even in old stools.

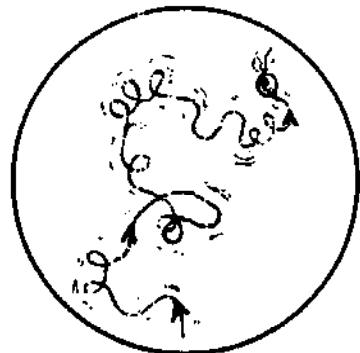

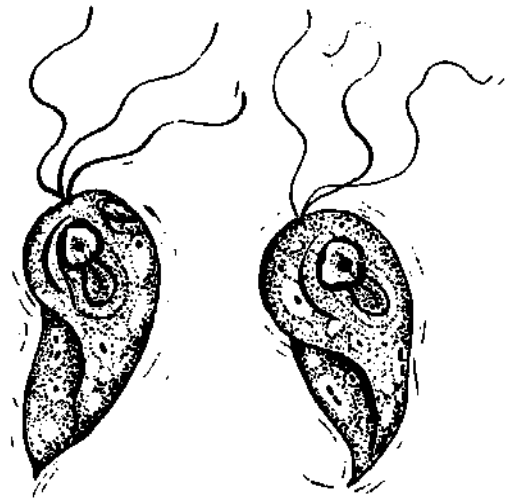

3. *Chilomastix mesnili*

- Size** 10-15 μm
Shape triangular and tapered at one end, looking twisted
Motility moves in one definite direction, in a spiral
Cytoplasm greyish-green with:
 - towards the tapered end: a distinct spiral marking, around which the flagellate turns (figure-of-eight)
 - near the rounded end: a mouth-like cleft (faintly visible cytostome)
Nucleus one nucleus, easily visible in unstained preparations.

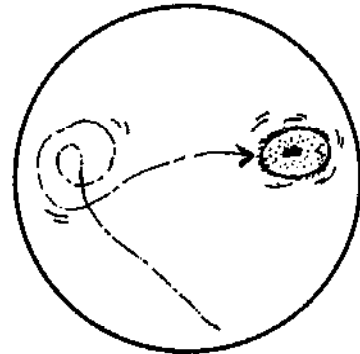
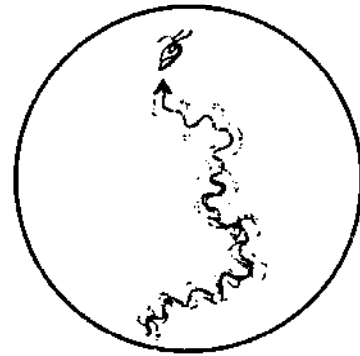

C. CILIATES

1. *Balantidium coli* (rare)

- Size** very large - 50 μm (often as big as or bigger than a roundworm egg)
Shape oval, with one pole more rounded than the other, transparent
Cilia covered with many small cilia, which move with rapid strokes
Motility moves very rapidly in stools, crossing the field in a definite direction and sometimes turning in circles
Nucleus a large kidney-shaped nucleus next to a small round nucleus
"Mouth" the cytostome: a sort of mouth that contracts and expands, drawing in debris.

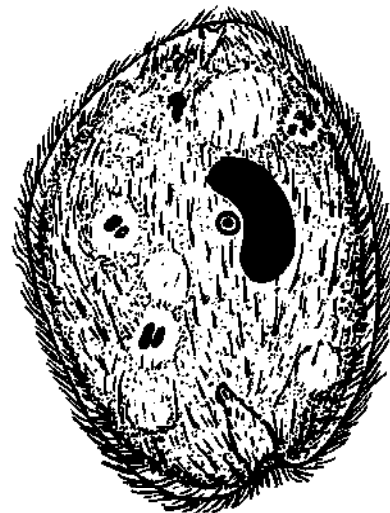

Important: If stools are left exposed to the air, without a lid, organisms of the infusoria type may fall on to them from the atmosphere. These look rather like *Balantidium coli*.

7. Amoebae, Flagellates and Ciliates: Cysts

Cysts are the small round non-motile resistant forms of certain intestinal protozoa (see page 147 for motile forms). Cysts may have one or several nuclei.

Importance of cysts

(a) *Clinical importance*

The clinical importance of cysts varies from country to country. The essential thing is to be able to find and recognize cysts of *Entamoeba histolytica*, *Giardia lamblia* and *Balantidium coli*, although their presence in the stools is of less immediate significance than the presence of the vegetative forms. Healthy persons may be carriers of cysts.

(b) *Importance for public health*

The cyst is the infective form. Carriers of cysts, therefore, are a public health hazard. Detection of cysts may also be of epidemiological value.

Stools containing cysts

Cysts are usually found in both soft and hard stools.

Slide examination

1. *Preparation in sodium chloride solution* (reagent No. 45)
Cysts can be seen as transparent refractile globules standing out clearly against the grey background. They have well-defined shells.
2. *Preparation in iodine solution* (reagent No. 36 diluted 5 times)
The nuclei become stained. Examine under the x 40 objective.
3. *Counting the nuclei*
Turn the fine adjustment screw of the microscope.
4. *Identification*
It is never enough to recognize a single cyst; identification depends on the observation of *several* in succession.
5. *Concentration*
If necessary, use the formaldehyde-ether concentration method (see page-165) to examine a larger number of cysts for surer identification.

Cysts of several different species may be found in the same stool specification.

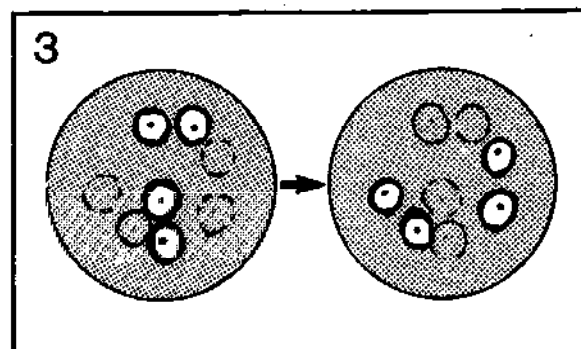
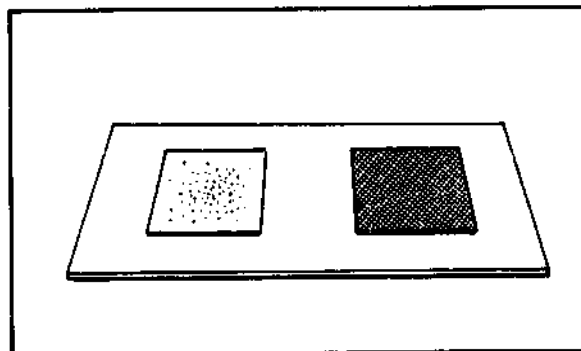

Some features useful for the recognition of cysts of intestinal protozoa

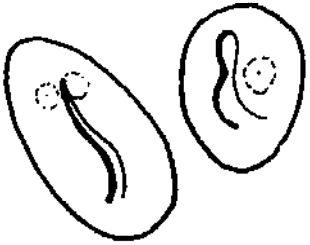
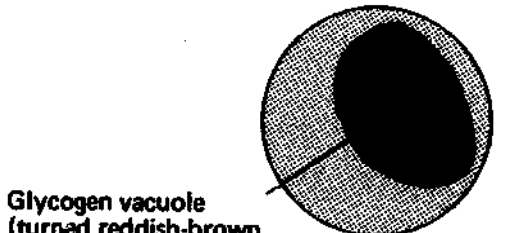
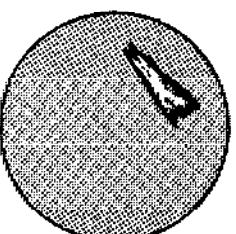
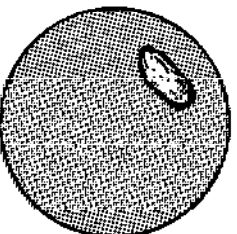
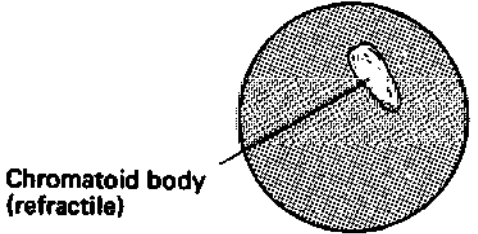
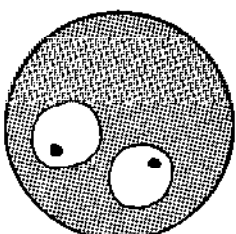
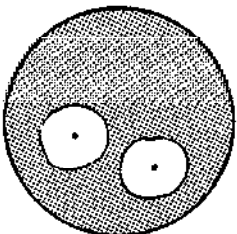
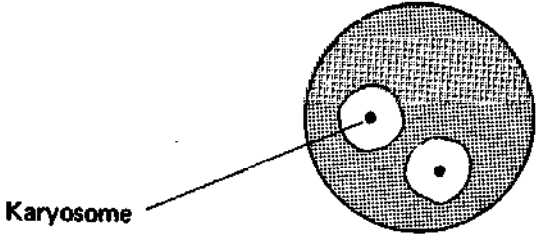
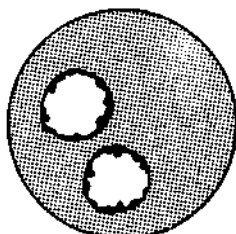
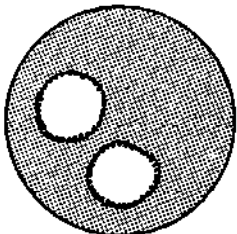
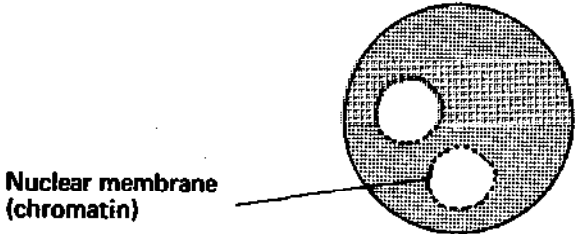
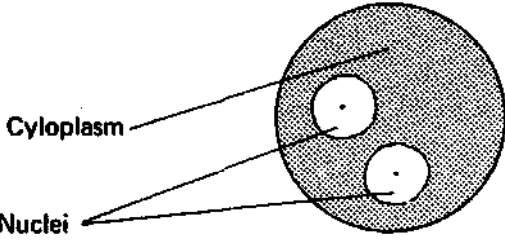

CYSTS OF AMOEBAE

Entamoeba histolytica

This amoeba causes dysentery.

Size	12-15 μm (1½-2 red blood cells)
Shape	round
Nuclei	1-4 nuclei: - membrane thin, regular, circular - karyosome small, compact, central (like a black dot)
Cytoplasm	(iodine solution) yellowish-grey and granular; looks "dirty"
Chromatoid bodies	oblong, rounded at ends (sausage-shaped); not found in all cysts
Vacuole	sometimes a large glycogen vacuole (stained reddish-brown by iodine solution) in young cysts with 1 or 2 nuclei.

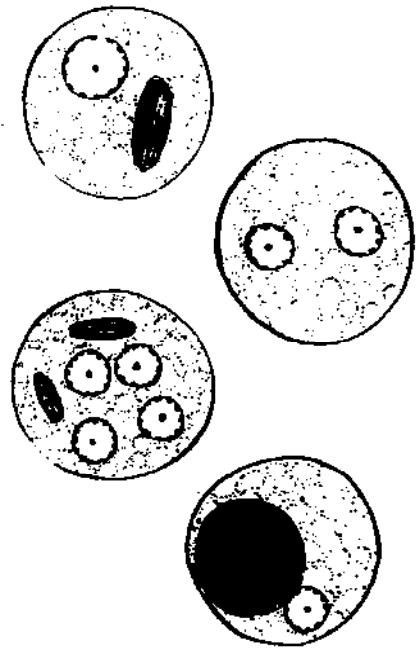

Cysts of other amoebae that do not cause disease

Identification difficult. The main thing is to differentiate between them and the cysts of *E. histolytica*.

1. *Entamoeba coli*

Size	12-20 μm (2-2½ red blood cells; a little larger than the cyst of <i>E. histolytica</i>)
Shape	round or slightly oval, sometimes irregular
Nuclei	1-8 nuclei: - membrane irregular, thick in parts, not a perfect circle - karyosome large, diffuse, often eccentric
Cytoplasm	(iodine solution) pale yellow, bright (as compared with <i>E. histolytica</i>)
Chromatoid bodies	sharp or jagged ends (dagger-shaped or needle-shaped); not found in all cysts
Vacuole	sometimes a very large vacuole (stained brownish-red by iodine solution) compressing two nuclei, one at either pole.

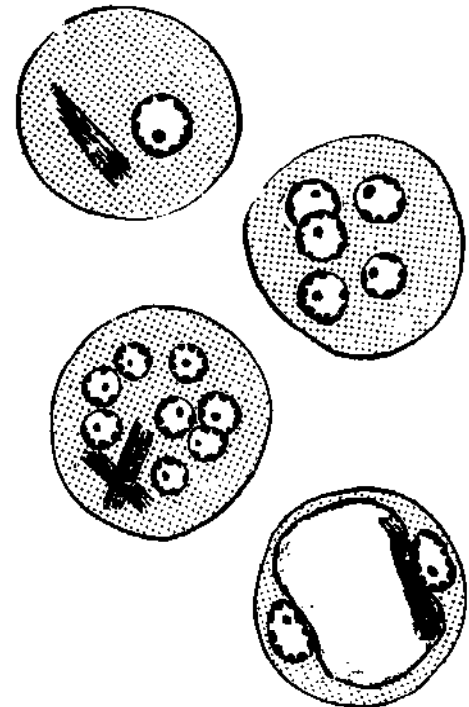

2. *Entamoeba hartmanni*

Size	small cyst, 4-8 μm (½ to same diameter as red blood cell)
Nuclei	1-4, identical with those of <i>E. histolytica</i> .

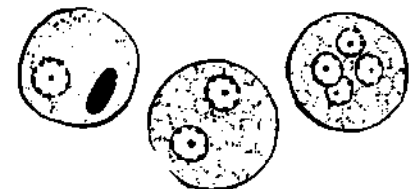

3. *Endolimax nana*

- Size** quite small, 8–10 μm
Shape more or less oval
Nuclei 1–4
– *membrane*: cannot be seen
– *karyosome*: large, irregular outline
Cytoplasm clear, without granules; turned deep yellow by iodine solution.

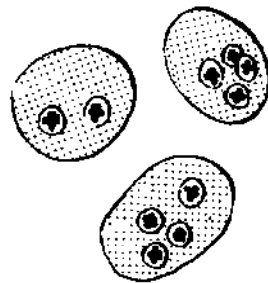

4. *Iodamoeba butschlii*

- Size** small cyst, 8–10 μm
Shape varies (round, oval or irregular)
Nucleus almost always a single nucleus
– *membrane*: cannot be seen
– *karyosome*: very large, oval, pressed against a cluster of granules
Vacuole a very large glycogen vacuole (stained brownish-red by iodine solution, hence the name *Iodamoeba*), often taking up half of the cyst.

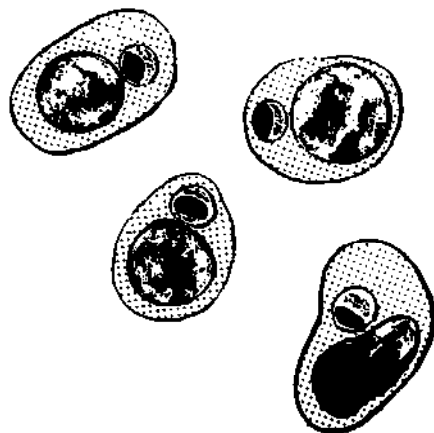

5. *Dientamoeba fragilis*

Not found in cyst form.

CYSTS OF FLAGELLATES AND CILIATES

1. *Giardia lamblia*

- Size** 8–12 μm
Shape oval, one pole more rounded than the other
Shell often appears to be a thick shell with a double wall; in fact, the second wall is the membrane of the cytoplasm
Nuclei 2–4 oval nuclei:
– *membrane*: very fine
– *karyosome*: small, central, faintly coloured
Cytoplasm clear, refractile when unstained, pale yellowish-green or bluish in iodine solution
Fibril refractile, hair-like line, folded in two or S-shaped, placed lengthwise in the centre of the cyst (adjust microscope).

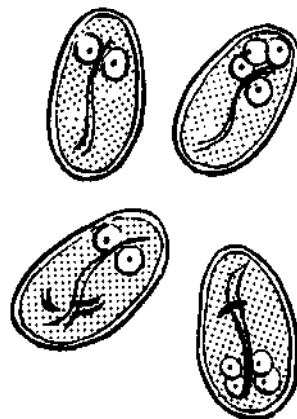

2. *Chilomastix mesnili*

- Size** small cyst, 6–8 μm
Shape round, one pole tapered (like a pear)
Nucleus a single, large nucleus:
– *membrane*: clearly seen, thick in parts
– *karyosome*: small and central
Fibril twisted, like a curled hair.

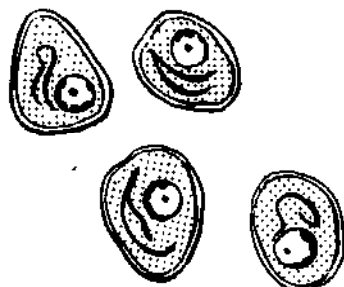

3. *Balantidium coli*

Size	very large cyst, 50-70 μm (the size of a roundworm egg)
Shape	round
Shell	thin, double wall
Nuclei	1 large kidney-shaped nucleus 1 small nucleus like a thick dot beside the large nucleus
Cytoplasm	granular, greenish, filled with inclusion bodies.

Often the ciliated, organized and slightly motile *Balantidium* trophozoite can be seen faintly inside.



Conclusion

It is most important to be able to identify:

- cysts of *ENTAMOEBIA HISTOLYTICA*
- cysts of *GIARDIA LAMBLIA*
- and cysts of *BALANTIDIUM COLI*.

ARTIFACTS* NOT TO BE MISTAKEN FOR CYSTS

1. Blastocystis

- Size** varies from 5 to 20 μm (average 10 μm)
Shape round or oval, sometimes with angular irregular edges
Content one large vacuole taking up almost the whole cell; the compressed cytoplasm forms a granular ring round it
Colour very refractile when unstained; the vacuole is not stained by iodine solution, but the periphery is pale yellow.

Some physicians request that the presence of *Blastocystis* be reported, particularly in children's stools.

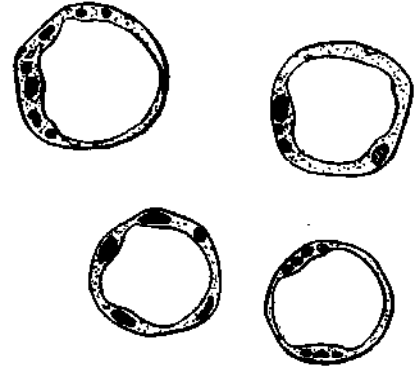

2. Yeasts

- Size** small (5-8 μm)
Shape oval, often with buds
Content often an eccentric cluster of 3-6 small granules
Colour (iodine solution) brownish red.

Some related forms of yeast are rectangular, with a very clear oval cytoplasm inside: arthrospores.

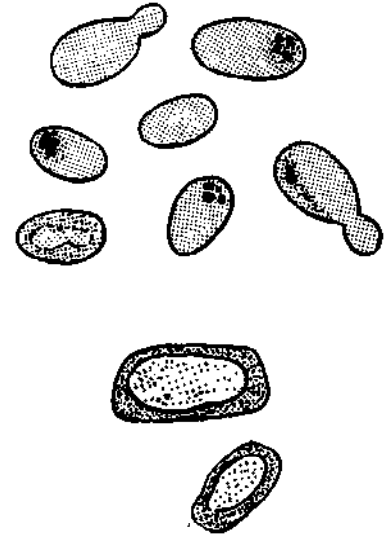

3. Leukocytes

- Size** 10-20 μm
Shape round or slightly elongated, with an irregular outline
Content refractile cytoplasm, clear and granular with tiny vacuoles
Nucleus indistinct, sometimes with a star-shaped "false karyosome".

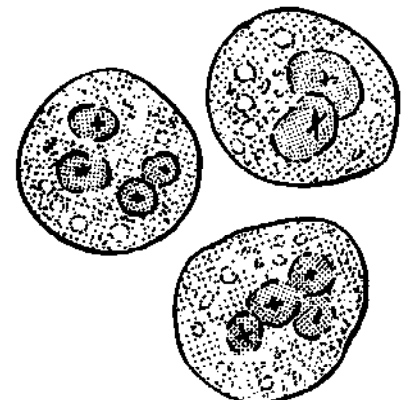

*Artifact: other things, living or artificial, present in the stool that are not parasites and could mislead the laboratory worker.

4. Pus

Pus can be seen by the naked eye as opaque, greyish streaks (not transparent like mucus). Under the microscope it appears as a mass of more or less degenerate leukocytes (report its presence).

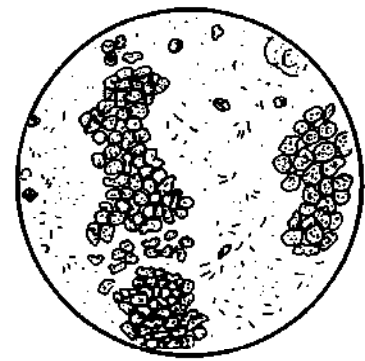

5. Coccidia

These are protozoa that may be parasites of man (without causing any significant pathogenic effects) or may be found in transit in the stools following the consumption of infected food (fish, rabbit, etc.). They appear in the stools in a form resembling cysts (called oocysts or sporocysts).

Size 15-20 μm , depending on the species

Shape an elongated oval, sometimes tapered at one pole

Colour colourless and transparent (or occasionally pale yellow)

Shell a quite distinct, slightly refractile double line; sometimes a sort of operculum at one pole

Content three types:

- (a) 4 sporozoites (small banana-shaped rods), each containing a small round nucleus; sometimes a few large granules massed at one pole
- (b) one large round granular cell
- (c) refractile granules completely filling the interior.

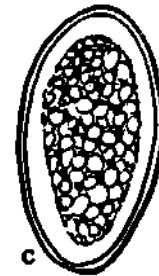
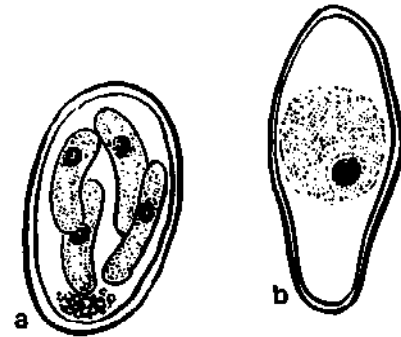

8. Choice of Method for Concentration of Parasites

Advantages of concentration

Concentration of parasites, sometimes called the "enrichment technique", makes it possible to:

- examine a greater quantity of stools in less volume
 - detect parasites present in very small numbers.
-

Important:

A direct microscopical examination of stools must always be made before preparing a concentration. (Motile forms of protozoa are not found in concentrated preparations.)

TECHNIQUES

Three different concentration techniques are described:

1. Willis sodium chloride solution technique
2. Formaldehyde-ether or MIF technique
3. Harada-Mori technique for *Strongyloides* larvae

The appropriate technique is chosen according to:

- (a) the equipment available
 - (b) the parasites sought
 - (c) the time available
 - (d) other considerations (such as cost-benefit factors in surveys).
-

9. Concentration Method using Sodium Chloride Solution (Willis)

Recommended for:

Eggs of hookworm, roundworm, *H. nana*, *Taenia*, whipworm (best method for detecting the presence of hookworm).

Not suitable for:

Eggs of flukes and schistosomes, larvae of threadworm, protozoa.

Principle

The stools are mixed with a saturated solution of sodium chloride (increasing the specific gravity). The eggs are lighter in weight and float to the surface, where they can be collected.

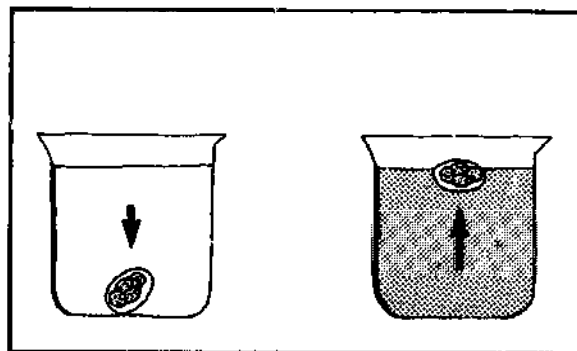

MATERIALS

- 10 ml (penicillin) bottles
- Wooden applicators
- Glass coverslips
- Ethanol
- Ether
- Petri dish
- Willis solution (reagent No. 58).

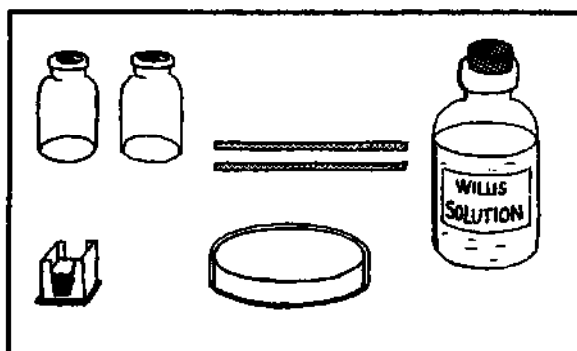

METHOD

Preparation of grease-free coverslips

- Mix in cylinder:
 - 10 ml 95% ethanol and 10 ml ether
- Pour into a Petri dish and in it place 30 coverslips, one by one; shake and leave for 10 minutes
- Take the coverslips out one by one and dry them with gauze
- Keep them in a dry Petri dish.

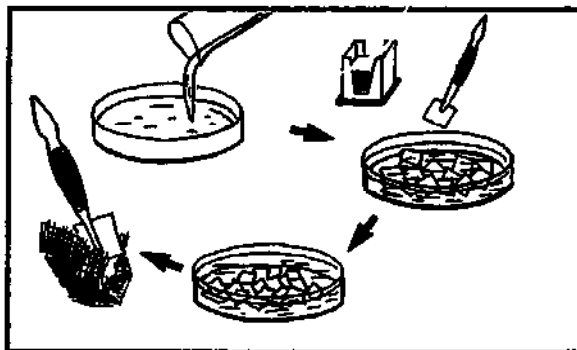

- Place a portion of stool, approximately 2 ml (2 cm³), in a penicillin bottle. Quarter-fill the bottle with Willis solution.

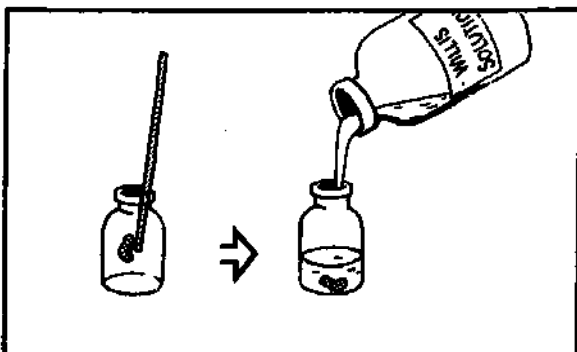

2. Using an applicator, crush the portion of stool and mix it well with the solution. Then fill the bottle to the top with Willis solution. The suspension should be completely uniform.

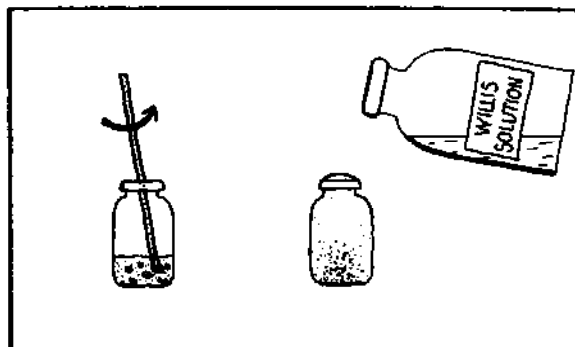

3. Place a coverslip carefully over the mouth of the bottle.

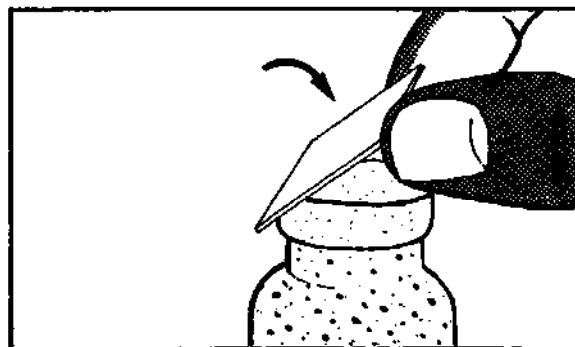

4. Check that the coverslip is in contact with the liquid, with no air bubbles. Leave for 10 minutes.

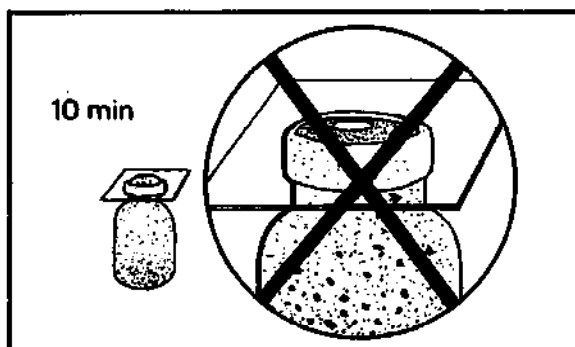

5. Remove the coverslip with care; a drop of liquid should remain on it. Place the coverslip on a slide and examine under the microscope at once, for the preparation dries very quickly. Otherwise seal the coverslip with petroleum jelly (Vaseline) and wax.

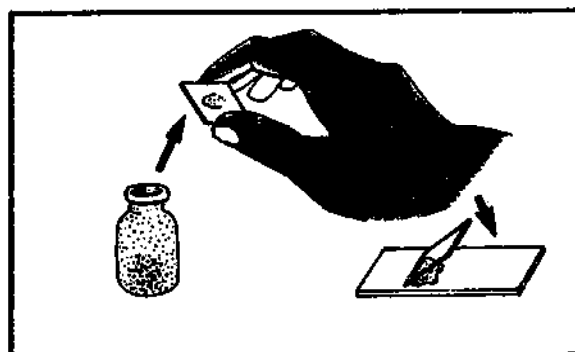

Use the fine adjustment of the microscope to examine every object visible in the field (for eggs tend to stick to the coverslip and are not immediately distinct).

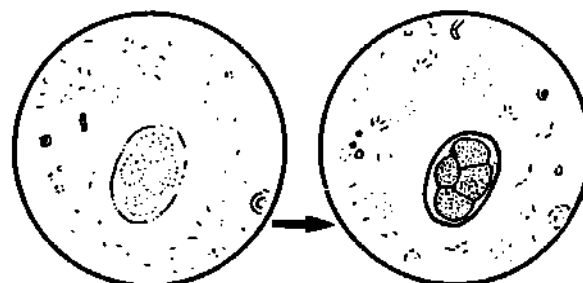

10. Concentration Method using Formaldehyde-ether or MIF

Recommended for:

All eggs and larvae, and especially *cysts of protozoa*.

Not suitable for:

Motile forms of amoebae and flagellates.

MATERIALS

- Electric centrifuge
- 15 ml conical centrifuge tubes with stoppers
- Penicillin bottles
- Funnel
- Gauze
- Graduated cylinder
- Cotton wool swab.

REAGENTS

Formaldehyde solution (reagent No. 26)
Pure ether (if unavailable, ordinary petrol (gasoline))
Sodium chloride solution (reagent No. 45)
Lugol iodine solution (reagent No. 36)
MIF (reagent No. 39), if available.

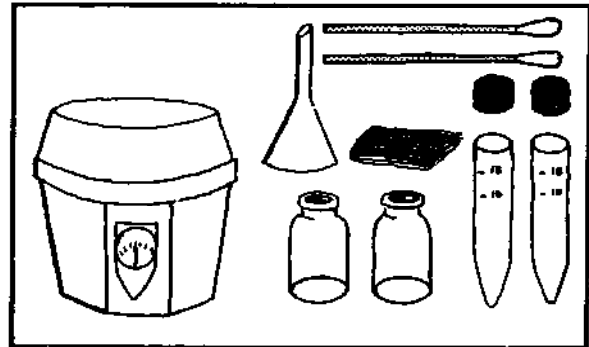

FORMALDEHYDE-ETHER METHOD

1. Take about 2 ml (2 cm³) of stool. Crush and mix it in about 10 ml (10 cm³) of sodium chloride solution.

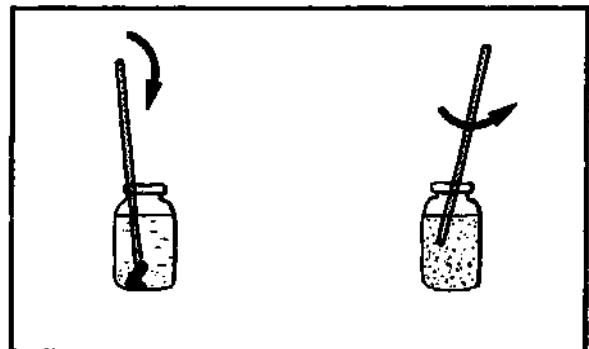

2. Filter through two layers of gauze into a centrifuge tube graduated with 10 ml and 13 ml marks.

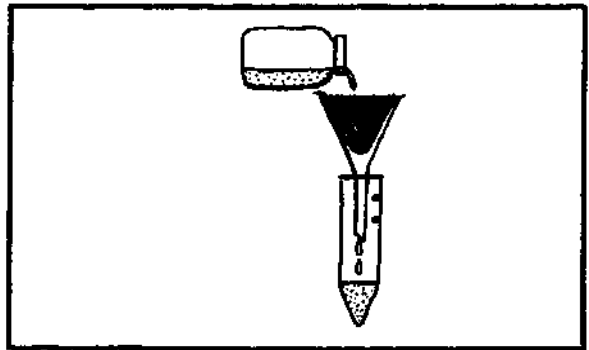

3. Centrifuge for one minute at medium speed. Pour off the supernatant fluid. If the supernatant fluid is very cloudy, wash the deposit again, i.e., mix it with 10 ml of sodium chloride solution, centrifuge for one minute at medium speed and pour off the supernatant fluid.

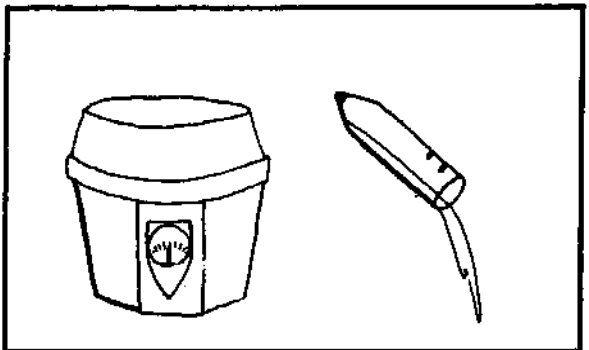

4. Add 10 ml of formaldehyde solution (reagent No. 26) to the deposit (up to the 10 ml mark).

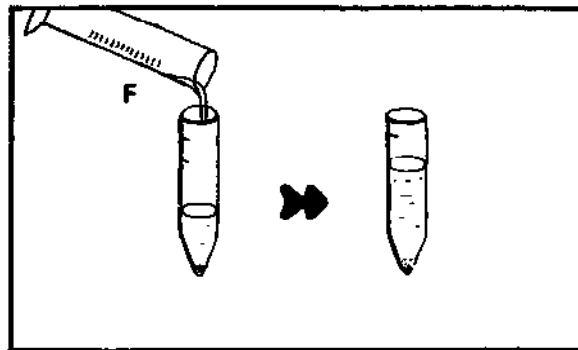

5. Stir the mixture well and let it stand for 5 minutes.

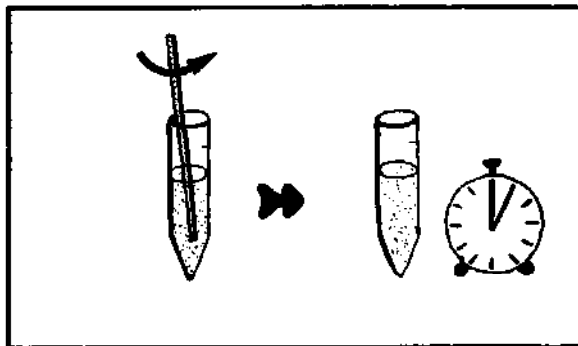

6. Add 3 ml ether or petrol (up to the 13 ml mark). *Important:* make sure there is no open flame in the laboratory.

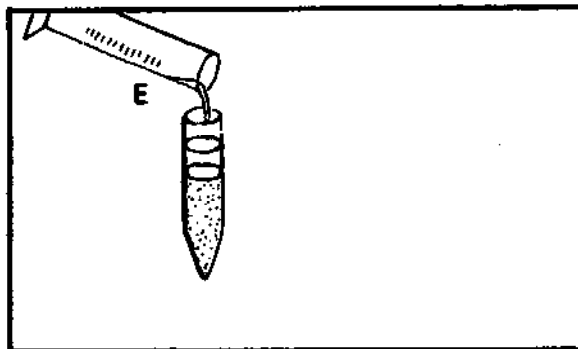

7. Stopper the tube. Turn it on its side and shake vigorously for 30 seconds.

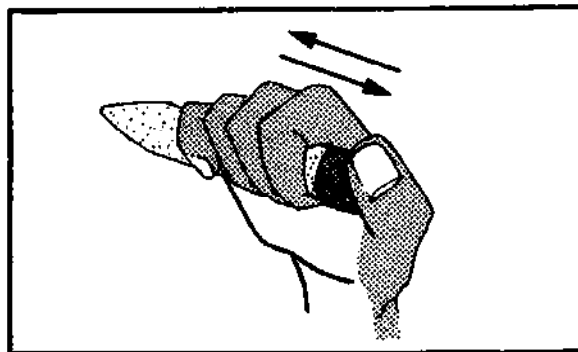

8. Remove the stopper carefully. Centrifuge for one minute at low speed.

There will be four layers in the tube:

- 1st layer: ether
- 2nd layer: debris
- 3rd layer: formaldehyde solution
- 4th layer: the deposit, containing the eggs and cysts of parasites.

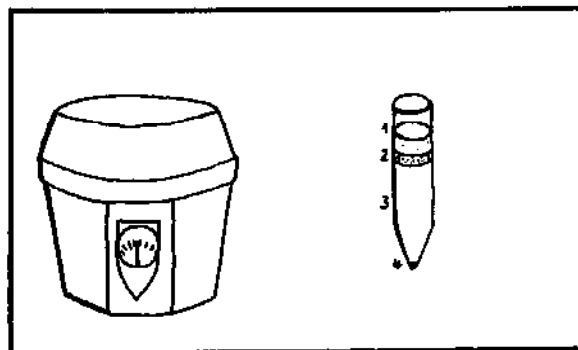

9. Free the layer of debris by rotating the tip of a wooden applicator between it and the sides of the tube. Tilt the tube and pour off all the supernatant fluid. Use a cotton swab to remove any debris adhering to the side of the tube.

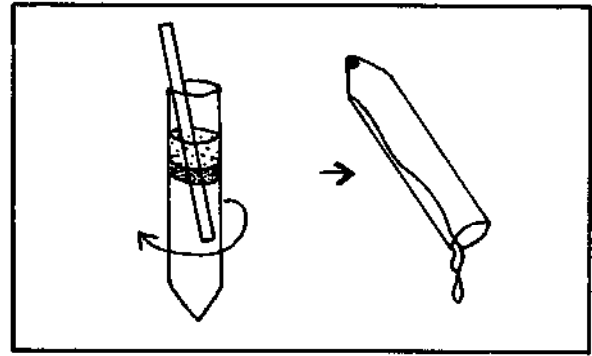

10. Mix the remaining fluid well with the deposit by tapping the tube gently.

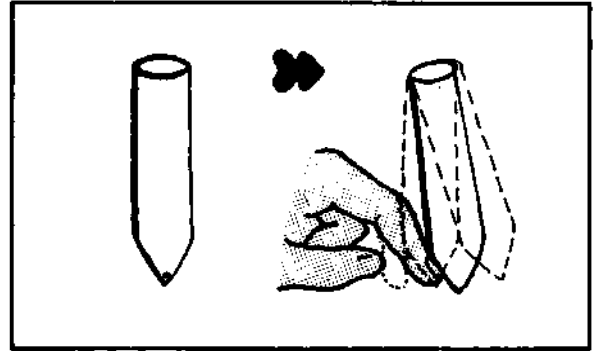

11. Place two drops of the deposit on a slide. Add a small drop of iodine solution to the second drop of deposit only.

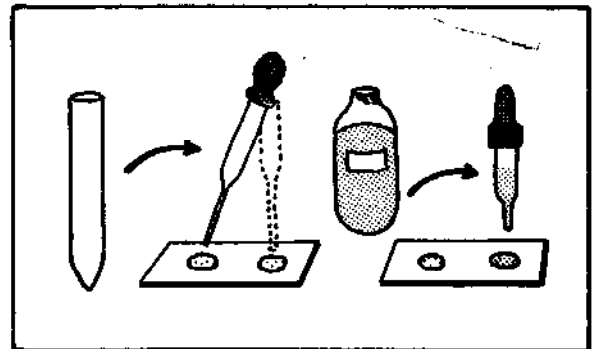

12. Place coverslips over both drops.
Examine under the microscope.
Preparation 1 (unstained): use x 10 x 40 objectives (eggs, larvae?).
Preparation 2 (stained): use x 40 (cysts?).

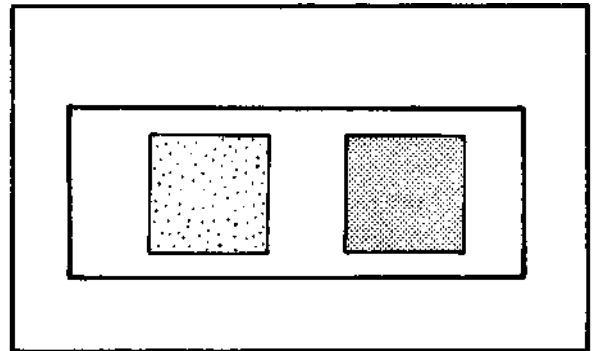

Stools received in formaldehyde preservative:

Follow the same method, but in step 1 use distilled water instead of sodium chloride solution.

METHOD USING MIF

Follow the same steps as for the formaldehyde-ether method, but replace the 10 ml of 10% formaldehyde solution with 10 ml of MIF. Then continue, adding 3 ml of ether, etc.

This is an excellent method of preserving the vegetative forms of amoebae, but the reagent is expensive.

11. Concentration Method for *Strongyloides* larvae (Harada-Mori)

Principle

Strongyloides larvae in stools migrate against the current of capillary water that rises in a paper strip that is partially submerged in a test-tube, and they accumulate at the bottom of the tube.

MATERIALS

- Test-tubes (20 x 200 mm)
 - Strips of filter paper (30 x 150 mm)
 - Spatula.
-

TECHNIQUE

- (a) With the spatula spread a small quantity of faecal specimen along a strip of filter paper (previously folded lengthwise to keep it straight) but leave the last 4 or 5 cm clean to be put into water.
- (b) Put the strip of filter paper, clean end first, into a test-tube containing filtered or boiled water 2.5 to 3 cm deep; the bottom of the strip should not touch the bottom of the tube.
- (c) Record the serial number or name of the patient indelibly on the tube.
- (d) Keep the tube for 7-8 days at laboratory temperature with a cotton stopper or, preferably, sealed with cellophane tape.
- (e) Look for the larvae at the bottom of the tube and examine them, after treatment with iodine solution, to differentiate *Strongyloides* from hookworm larvae (see next page).

Note: *Strongyloides* larvae can attain the infective stage in these conditions (producing filariform larvae) or can become adult worms.

LARVAE FOUND IN STOOLS

The larvae most commonly found in stools are those of *Strongyloides* (threadworm). Occasionally those of *Ancylostoma* (hookworm) are found.

- Threadworm larvae: in both fresh and old stools.
- Hookworm larvae: in old stools (24-48 hours) only.

The difference between them can be seen under the microscope after staining with iodine solution.

LARVAE	THREADWORM	HOOKWORM
length	200-300 μ	200-300 μ
breadth	15 μ	15 μ
oesophagus (O)	two swellings*	two swellings*
mouth (M)	short: 4 μ ($\frac{1}{2}$ red cell)	long 15 μ (2 red cells)
posterior end	slightly tapered	very tapered
genital rudiment (GR)	large and distinct (22 μ)	small (7 μ)
anal pore (AP)	50 μ from posterior end	80 μ from posterior end

*Larvae with two oesophageal swellings are called *rhabditiform* larvae.

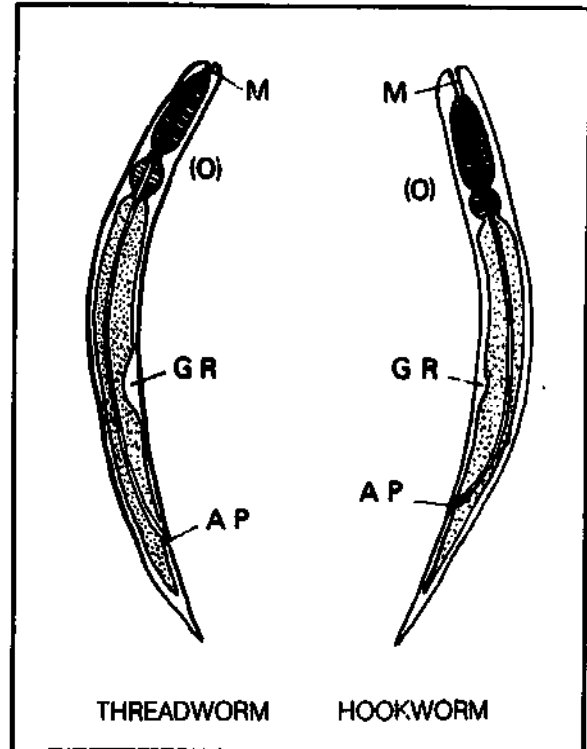

12. How to Record the Results of Stool Examinations

Example:

Mr Amala — Stool examination — 8.5.79.

The following details should be given when recording the results of a stool examination:

1. Consistency of stools
2. Abnormal features seen with the naked eye
3. Parasites found by microscopic examination specifying:
 - species
 - stage of development
 - quantity

Soft, unformed stools
Flakes of mucus present
Presence of:
Giardia lamblia
Vegetative forms
Numerous

1. CONSISTENCY OF STOOLS

They may be:

- hard and dry
- firm and formed
- soft and formed
- soft and unformed
- semi-liquid (muddy)
- liquid and watery.

2. ABNORMAL FEATURES

The following may be seen with the naked eye:

- flakes of mucus (colourless slimy substance like phlegm)
- mucous membranes
- bloodstained mucus
- streaks of pus
- blood superimposed on the stools, which then are red in parts.

3. PARASITES

Species worm eggs: give the common English name (together with the Latin name in the case of schistosomes, flukes and tapeworms).
protozoa: give the scientific Latin name.

Scientific name first name (the genus): write with a capital letter, e.g. *Schistosoma*.
second name (the species): write with a small letter, e.g. *mansoni*.

Stage eggs, larvae, vegetative forms, worm segments, etc. When describing *E. histolytica*, always specify whether it contains ingested red blood cells.

Quantity occasional (1–2 eggs per slide); a few (3–5); a moderate number (6–12); many (more than 12).

If no parasites are found, state: "No ova or parasites seen", and specify whether this result was obtained by direct examination or by a concentration method (name method used). Never state categorically: "No parasites".

EXAMPLES OF REPORTS ON STOOL EXAMINATIONS

- Mr A** Stools hard and dry.
Few eggs of *Trichuris trichiura* found by direct examination.
- Mr B** Liquid stools, showing bloodstained mucus.
Moderate number of vegetative forms of *E. histolytica*, a few eggs of hookworm.
- Mr C** Firm, formed stools.
Direct examination: no ova or parasites seen.
- Mrs D** Soft, unformed stools.
No ova or parasites seen by direct examination or after concentration (formaldehyde-ether method).
- Mr E** Semi-liquid, muddy stools.
A few larvae of *Strongyloides stercoralis* found by direct examination.
- Mr F** Stools soft and formed, showing streaks of blood.
Occasional eggs of schistosomes (*S. mansoni*) present.
- Mrs G** Firm, formed stools.
A few segments of *Taenia saginata* present.
- Mr H** Stool specimen received very small and dried-up.
Direct examination: no ova or parasites seen.
State of specimen made examination for vegetative forms of protozoa impossible.
-

MODEL STOOL EXAMINATION REPORT FORM

The technician ticks the appropriate word(s) and fills in the spaces.

PARASITOLOGICAL EXAMINATION OF STOOLS	
Name
Patient no.	Ward (or outpatient dept.)
Date of receipt
APPEARANCE OF STOOLS	
Hard dry Firm well-formed Soft Semi-liquid Liquid	Presence of: - pus - mucus - bloodstained mucus - fresh blood - occult blood
MICROSCOPICAL EXAMINATION	
No ova or parasites seen	by direct examination after concentration (method(s):
Parasites present	by direct examination
	after concentration (method(s):
ADULT WORMS SEEN WITH THE NAKED EYE	
.....	
Date	Signed

In some countries the report forms include a list of the principal types of parasite that occur.

Parasites present:	The technician checks the appropriate word(s) as follows
Eggs of hookworm	+ (some eggs)
Eggs of <i>Ascaris</i>	++ (eggs fairly numerous)
Eggs of <i>H. nana</i>	+++ (eggs very numerous)
Eggs of <i>S. mansoni</i>	<i>E. histolytica</i> (veg. form) (with/without ingested red cells)
Eggs of <i>Trichuris</i>	<i>E. histolytica</i> (cyst)

13. Dispatch of Stools for Detection of Parasites

Stools may be sent to a specialized laboratory for the identification of rare parasites that are difficult to recognize.

Preservatives used:

1. 10% formaldehyde solution (reagent No. 26), for wet mounting
2. MIF (reagent No. 39), for wet mounting
3. PVA (poly(vinyl alcohol)), for permanent staining.

1. USING 10% FORMALDEHYDE SOLUTION

Prepare a mixture containing about 1 part of stool to 3 parts of formaldehyde solution.

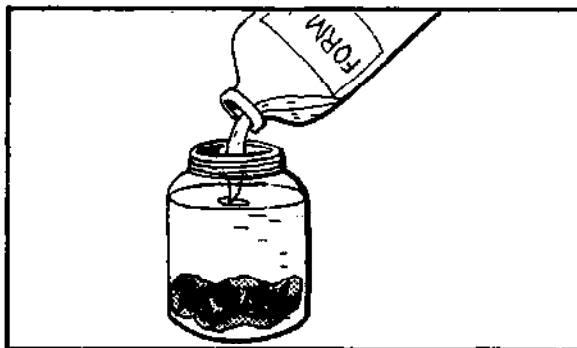

Crush the stool thoroughly with a glass rod.

Preserves eggs and cysts of parasites.
Does not preserve vegetative forms of protozoa, which are destroyed after a few days.

Preserves specimens indefinitely if the bottle is tightly closed.

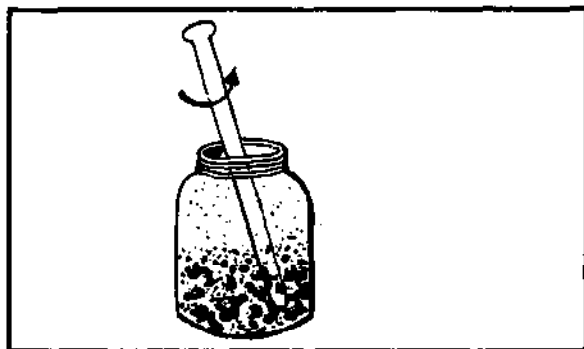

2. USING MIF

Just before dispatch, mix in a tube or a small bottle:

- 4.7 ml of MIF solution
- 0.3 ml of Lugol iodine solution (reagent No. 36).

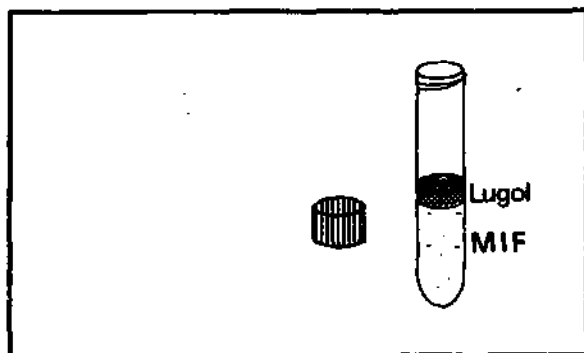

Add a portion of stool, approximately 2 ml (2 cm³).

Crush well with a glass rod.

Preserves all forms of parasites, including vegetative forms of amoebae (those of flagellates deteriorate slightly).

Preserves specimens indefinitely.

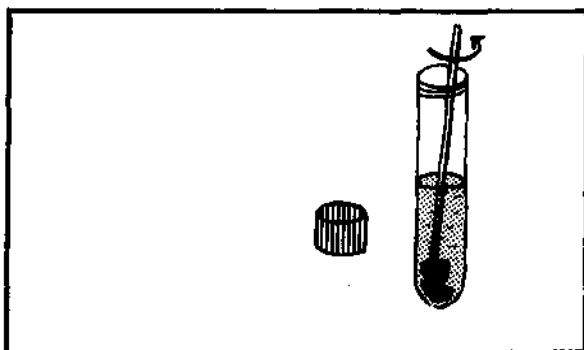

3. USING PVA

(a) In a bottle

1. Pour about 30 ml of PVA fixative into a bottle, which should be three-quarters full.

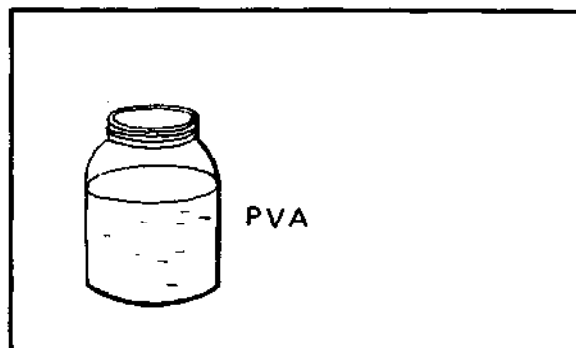

2. Add enough *fresh* stools to fill the last quarter of the bottle, which should now be full.
3. Break up the stools thoroughly with a glass rod. *Preserves* all forms of parasites indefinitely.

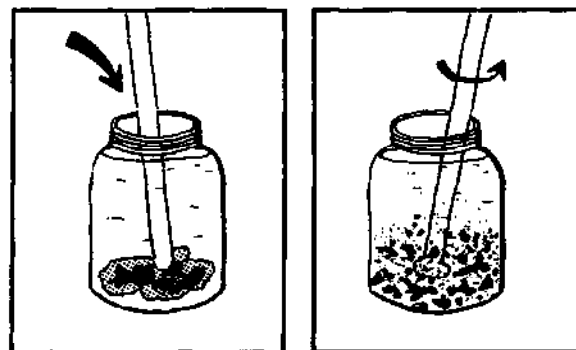

(b) On a slide

1. To examine for amoebae and flagellates, place a small portion of the stool on one end of the slide.

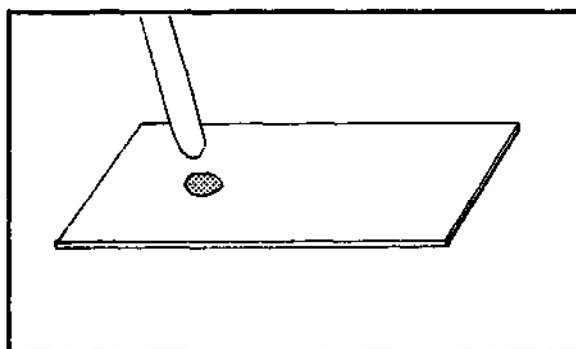

2. Add to the stool:
 - 3 drops of PVA.

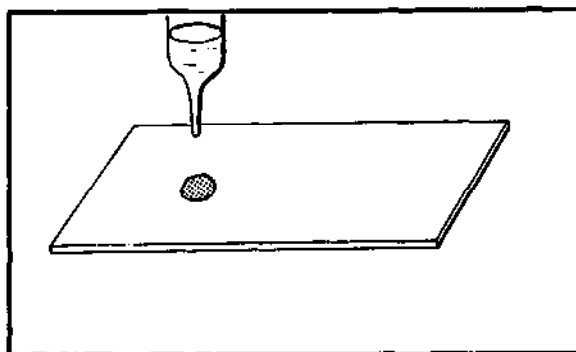

3. Spread carefully with a glass rod over about half of the slide.
Leave to dry for 12 hours (preferably at 37 °C).
Slides can be kept for about 3 months.
They can be stained on arrival at the specialized laboratory.

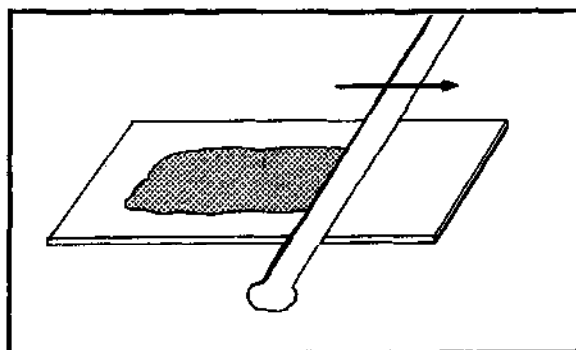

14. Chemical Test for Occult Blood in Stools

Principle

Oxygen is produced when the haemoglobin in blood comes into contact with hydrogen peroxide. The liberated oxygen reacts with aminophenazone (aminopyrine) to yield a blue colour.

MATERIALS AND REAGENTS

- Centrifuge
- Conical centrifuge tube
- Applicators
- 20-ml measuring cylinder
- Test-tubes
- 10% acetic acid (reagent No. 2)
- Hydrogen peroxide (fresh 10-vol. solution)
- 95% ethanol
- Aminophenazone, crystalline.

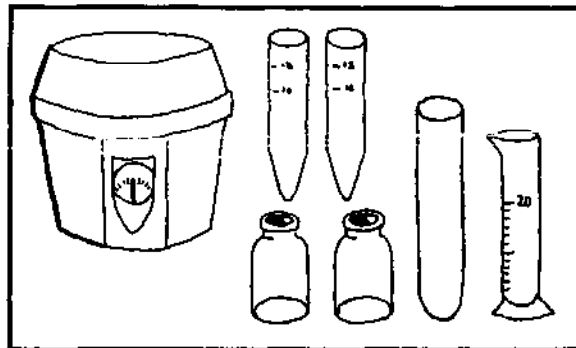

METHOD

1. Immediately before carrying out the test, prepare a solution of aminophenazone:
 - put about 0.25 g of aminophenazone in the bottom of a test-tube
 - add 5 ml of 95% ethanol.

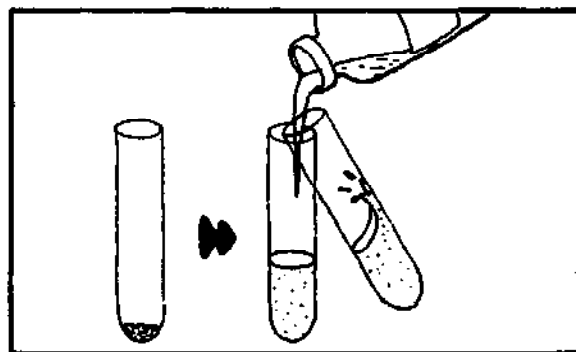

2. Put a portion of stool, approximately 4 ml (4 cm³), in a centrifuge tube.

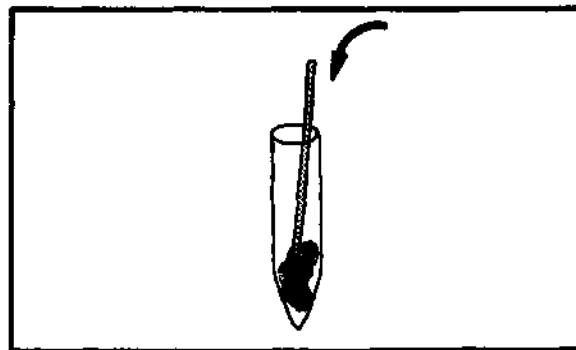

3. Add 7 ml of distilled water to the stool and mix thoroughly.

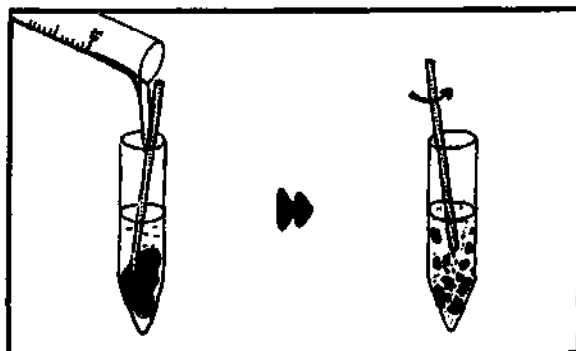

4. Centrifuge at a low speed for about 5 minutes, or until the solids are precipitated (a hand-powered centrifuge can be used).

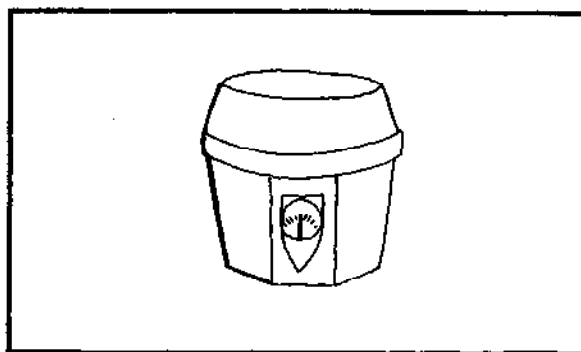

5. Decant the supernatant fluid into another test-tube and keep it.

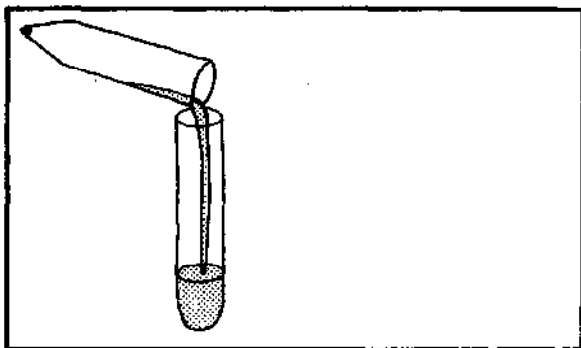

6. Add to the test-tube containing the supernatant fluid, without mixing:

- 10 drops of 10% acetic acid
- 5 ml of the aminophenazone solution.

To prevent mixing, add with the tip of the pipette against the inside wall of the test tube.

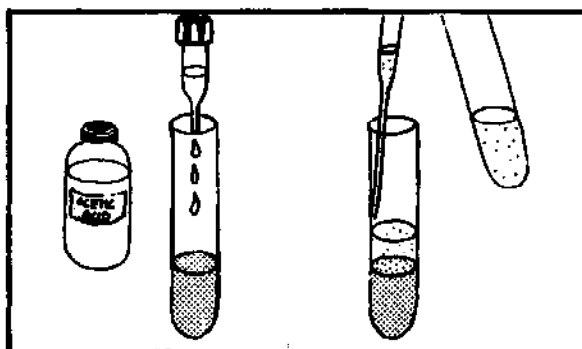

7. Then add:

- 10 drops of the 10-vol. hydrogen peroxide solution.

Do not mix.

Let stand for one minute.

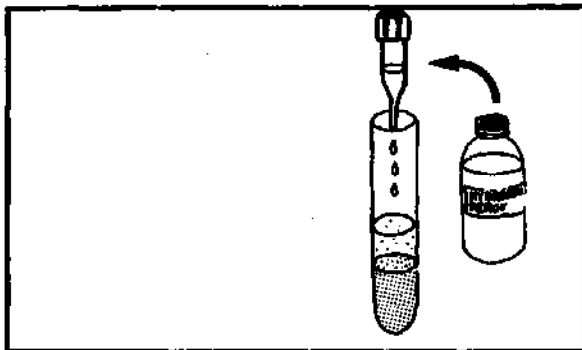

Positive reaction

A blue colour appears between the two layers of liquid:

- pale blue = positive reaction +
- dark blue = strong positive reaction ++
- blue-black = very strong positive reaction +++.

Negative reaction

No change in colour.

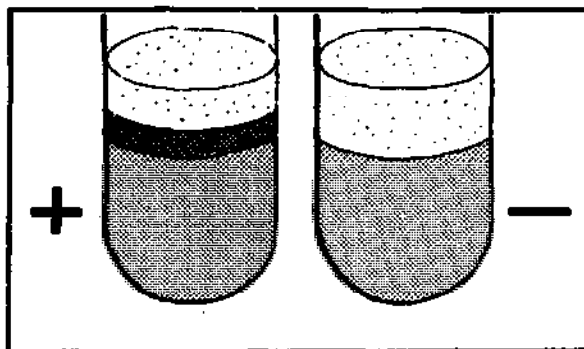

PRECAUTIONS IN THE LABORATORY

The glassware used must be clean (no trace of blood).

The result must be read within 5 minutes.

Control tests may be set up:

- negative: with distilled water
 - positive: with water containing 1% blood.
-

PRECAUTIONS FOR THE PATIENT

For one day before the examination, the patient should not:

- eat any meat
- take any drug containing iron compounds
- brush his teeth vigorously.

Note: The benzidine test is no longer recommended because of the carcinogenic properties of that substance.

15. Examination of Urine for Eggs of *Schistosoma haematobium*

The schistosome (bilharzia) worm, the cause of the vesical schistosomiasis found in Africa and the Middle East, lays its eggs in the blood vessels of the bladder wall. The eggs pass into the urine, often accompanied by blood.

Direct examination (after centrifuging)

The urine is centrifuged and the deposit examined for eggs.

MATERIALS

- Centrifuge and conical tube, 100, 200 and 1000 ml cylinders
- Clearing agent: 10% sodium hydroxide (reagent No. 47)
- Preservatives: hydrochloric acid and commercial bleach.

COLLECTION OF SPECIMEN

Collect the urine between 11 h and 17 h; a greater concentration of eggs is found in the urine during this period, particularly in the last drops.

Preliminary exercise

Just before the specimen is taken, ask the patient to perform 20 rapid knee-bends, run 100 yards, or run up and down the stairs several times (this results in the excretion of more eggs).

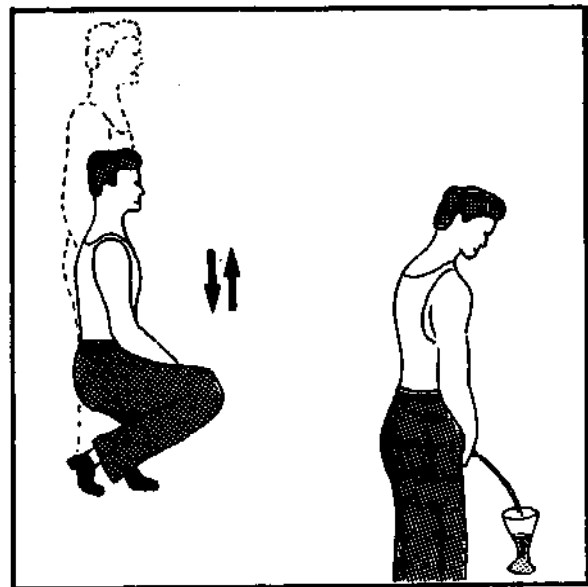

Preservation of urine

If there is any delay in examining the urine, add for every 100 ml of urine:

- 1 ml of hydrochloric acid (20 drops)
- 2 ml of commercial bleach (40 drops).

The urine can then be kept at room temperature indefinitely.

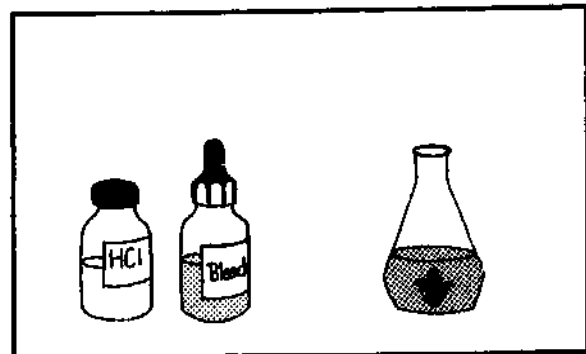

A. DIRECT EXAMINATION

Centrifuge the urine in conical tubes (10–15 ml) for 5 minutes at low speed or with the hand centrifuge.

(If the urine is bloodstained, treat as described under B below).

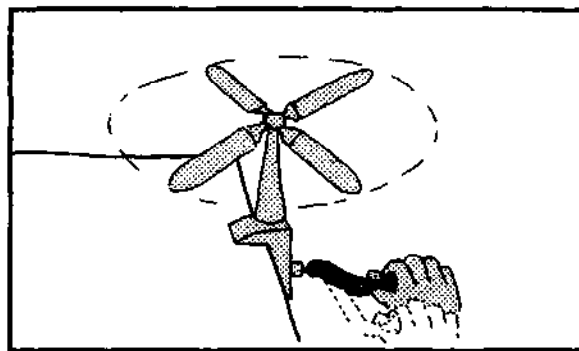

After centrifuging, discard the supernatant urine.

Mix the deposit evenly by drawing it up and blowing it out with a dropping pipette.

Take a drop of the homogeneous deposit and place it between a slide and coverslip. Examine under the x 10 objective.

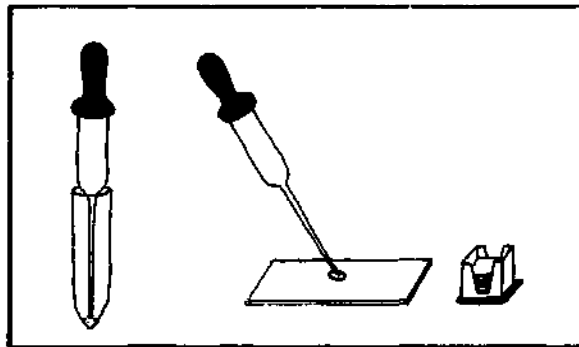

Egg of *Schistosoma haematobium*

Size 120–150 μm

Shape oval, with one well-rounded pole

Shell smooth, very thin

Terminal spine at one pole

Colour grey or pale yellow

Content a broad well-formed embryo with tiny cilia around the edges.

The egg is often surrounded by a mass of leukocytes, which may conceal the terminal spine. (See photograph of egg on page 134).

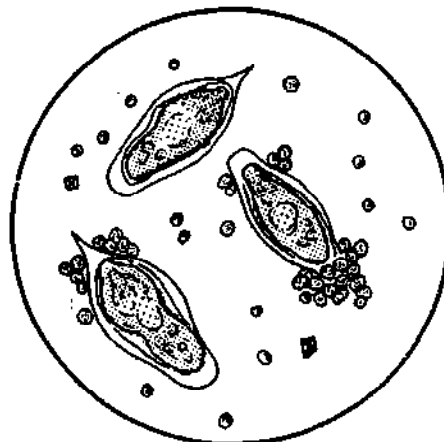

Viability of eggs

The viability of eggs can be determined only in fresh untreated urine. The egg is viable if it is still "alive"; if so, the patient is still infected with living worms.

Examine the egg under the x 40 or x 100 objective (seal the preparation with melted wax). Observe whether the embryo is moving slightly within the egg. If not, look for the *flame cells*: there are 4 of them, one at each corner of the embryo. A continuous and rapid movement of the cilia in these cells can be detected, stirring up the fluid in the egg. This shows that the egg is alive.

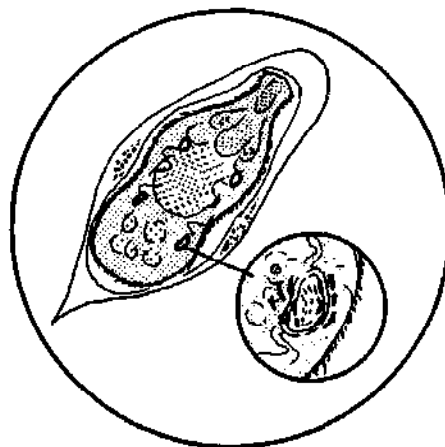

B. BLOODSTAINED URINE

If a lot of blood is present, examination is difficult since the masses of red cells may conceal the eggs.

Add 5 drops of 10% sodium hydroxide (reagent No. 47) to the centrifuge tube of urine. This will lyse (dissolve) the red cells and leave the deposit clear. The eggs are also affected, but the shells remain recognizable.

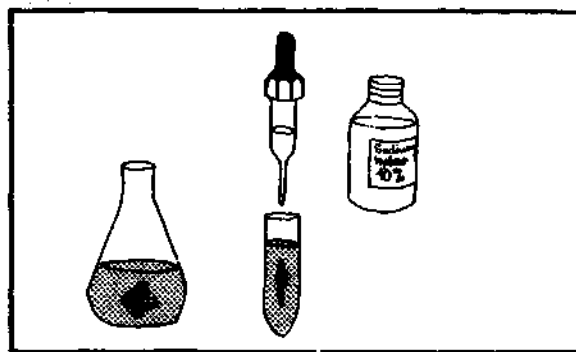

Egg of *Schistosoma mansoni*

This may be found exceptionally in the urine. It has a lateral spine: see description, page 135.

C. EGG-COUNTING TECHNIQUE

1. Collect whole bladder content and take 10 ml of the well-shaken specimen.
2. Centrifuge for 3 minutes at medium speed in a graduated centrifuge tube.
3. Remove the supernatant fluid to the 0.2 ml mark.
4. Mix the residue very well and transfer to a slide (with a graduated pipette) 0.1 ml of it.
5. Count the eggs under the microscope, using a low-power scanning objective and the x 5-6 eyepiece.
6. Multiply the result by 2 to obtain the egg concentration in 10 ml of urine.

Examination of rectal biopsy material

The physician may ask the laboratory to look for schistosome eggs in biopsy material taken from the rectum. The physician performs rectal biopsies to diagnose different schistosome infections or as a follow-up to treatment.

Examine in a wet preparation.

Flatten a small fragment of the biopsy material between a slide and a coverslip.

Examine under the microscope (x 10 objective).

Schistosome eggs are easy to see and recognize.

Examination of rectal biopsy material is often useful for the detection of *S. haematobium*. A positive result may be obtained when nothing is found in the urine.

16. Other Parasites Found in Urine

Apart from schistosome eggs (see page 178), found in Africa and the Middle East, parasites are *rarely* found in the urine.

The following may be found in urine deposit after centrifuging:

1. Flagellated protozoa *Trichomonas vaginalis*
2. Microfilariae *Wuchereria bancrofti* and others
3. Spirochaetes *Leptospira icterohaemorrhagiae*

1. FLAGELLATED PROTOZOA

Trichomonas vaginalis

These protozoa are detected in genitourinary discharges (see page 186).

They may, however, be found still motile and recognizable in the deposit of *fresh* urine.

Size	15 μm
Shape	round, globular
Motility	whirls and turns, vibrates
Undulating membrane	like the fin of a fish, on one side, very motile
Flagella	4 flagella.

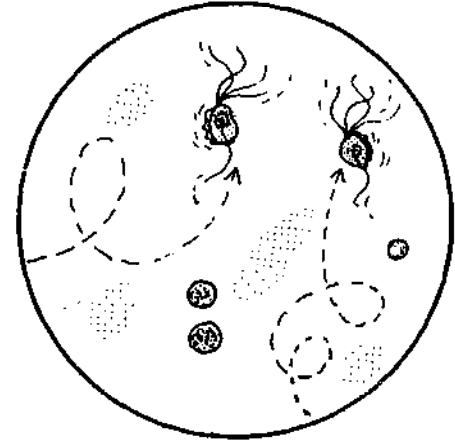

2. MICROFILARIAE

Wuchereria bancrofti

Appearance of urine: *milky*, because chyle is present (it comes from the damaged lymphatic vessels in a condition called "chyluria"). The microfilariae are still motile (size: 200–300 μm long, 8 μm thick). They move in regular curves. For description see page 212.

The sheath of the organism is visible in the urine. Usually large numbers of leukocytes are also present.

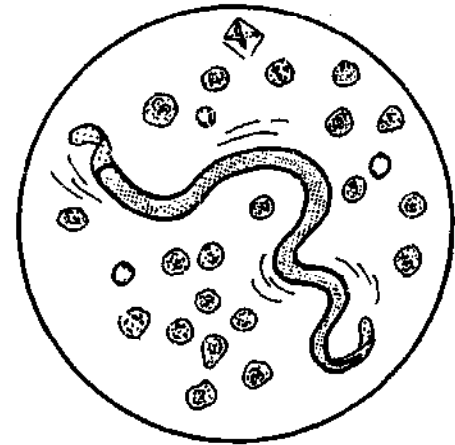

Onchocerca volvulus

Very occasionally (in about 5–10% of cases), microfilariae of onchocerciasis pass into the urine.

They are found still motile.

Size: 200–300 μm long, 8 μm thick.

Rigid curves. No sheath. The head is broader: see description, page 218.

Identification can be confirmed by examining a cutaneous smear in a wet preparation.

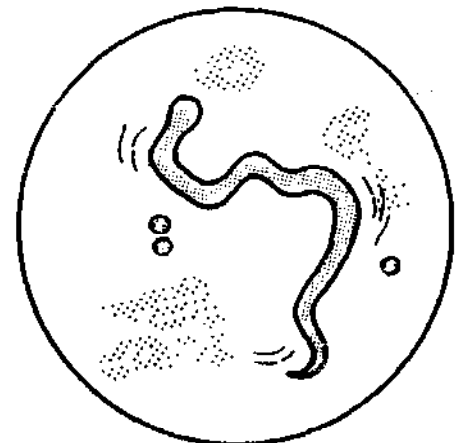

Accidental blood microfilariae

Patients with schistosomiasis may also be infected with filariae. The schistosome infection causes loss of blood into the urine and the blood carries with it blood microfilariae such as *W. bancrofti*, *Loa loa* and *D. perstans* (see description on pages 212 and 213). A large number of red cells will be present.

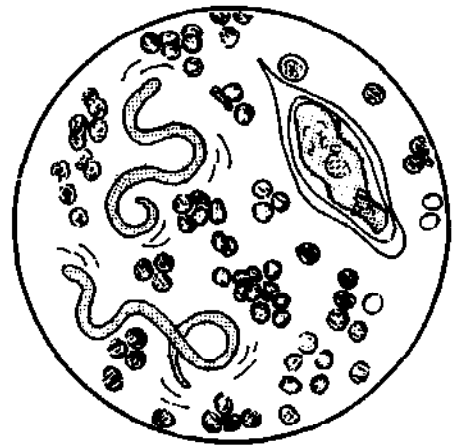

3. SPIROCHAETES

Leptospira icterohaemorrhagiae

Leptospirosis is transmitted by rats. The disease is found most frequently in Asia. If leptospirosis is suspected, the urine deposit can be examined directly as a wet preparation using darkground illumination, or as a Giemsa-stained preparation.

Length varies greatly; 10–20 μm on average
Shape spiral: 20–40 spirals; looks like a squashed spring
Ends tapered, often hooked
Motility undulates and rotates
Staining weakly Gram positive; stains better with Giemsa stain.

Leptospira can be isolated by culture, using special media.

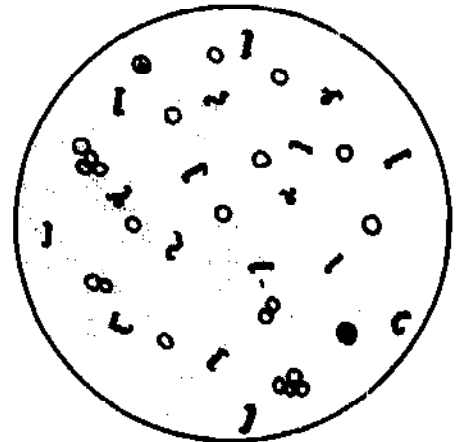

Do not mistake for parasites:

Spermatozoa, which may be found still motile in the deposit of fresh urine from males (see description on page 329).

Contamination of urine with stool:

If urine is contaminated with stool, parasites which can be found in stool specimens may also be found in urine deposits.

17. Eggs of Pulmonary Flukes; Other Parasites

PULMONARY FLUKE – *Paragonimus westermani*

This flatworm, shaped like a coffee bean, attaches itself to the bronchi. The patient is infected by eating under-cooked river crabs. The sputum of infected patients is rust-brown.

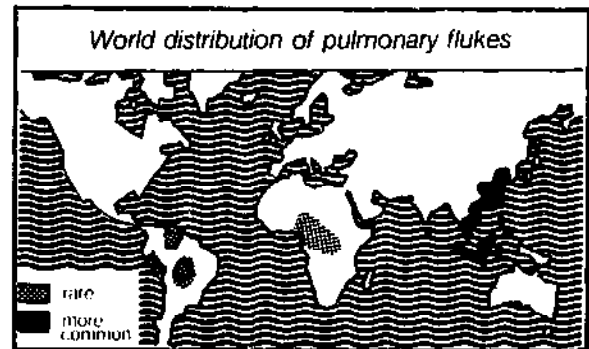

Materials

- Centrifuge
- Conical centrifuge tubes
- Glass rod
- Inoculating loop
- Slide
- Coverslips
- 3% solution of sodium hydroxide (reagent No. 46).

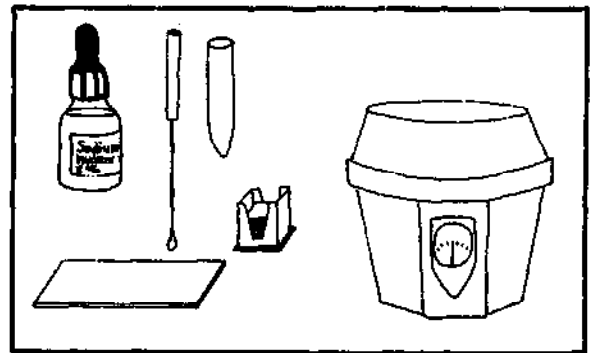

Method

1. Add to the sputum in its receptacle an *equal* quantity of 3% sodium hydroxide.

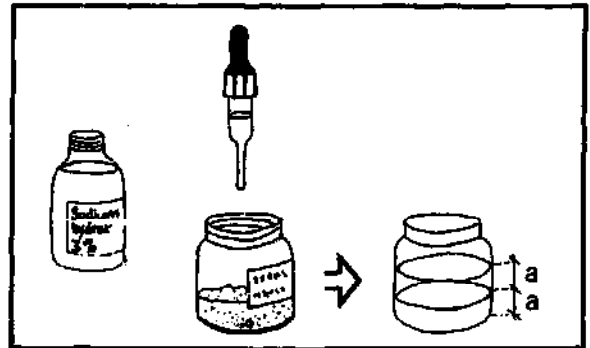

2. Mix well for 3 minutes.

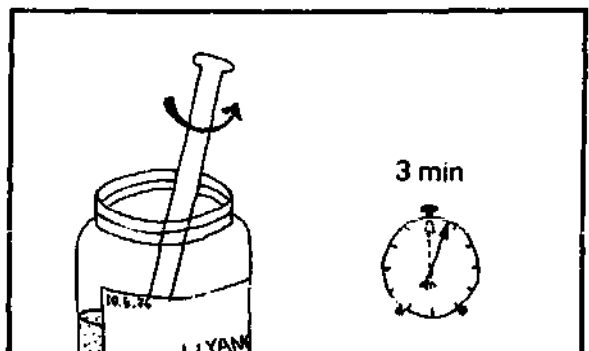

3. Pour all of the mixture into a centrifuge tube. Centrifuge for 5 minutes at high speed.

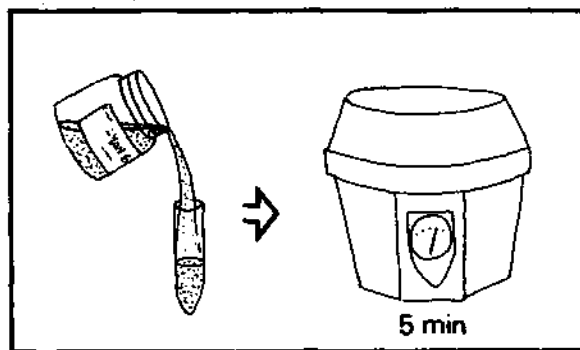

4. Pour off the supernatant fluid.

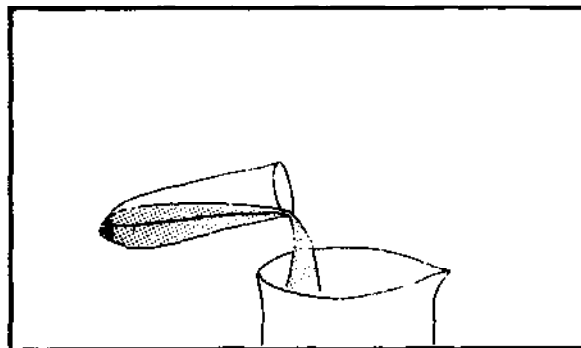

5. Remove a drop of the deposit with an inoculating loop and place it on a slide. Examine between the slide and a coverslip under the microscope (x 10 and x 40 objectives).

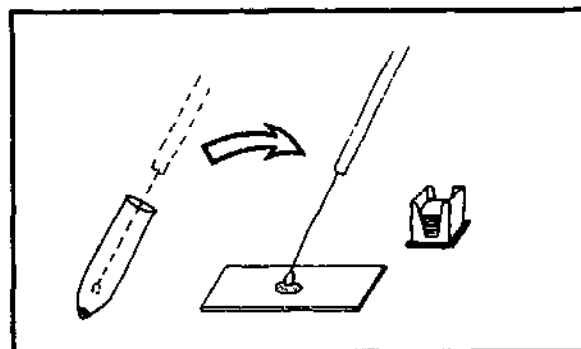

Eggs of the pulmonary fluke

- Size** 100 μm long
Shape oval, one side often slightly flattened
Colour golden brown
Operculum (O) flattened, with a visible rim, like a tiny hat placed on the egg
Shell smooth, with a marked thickening (T) at the opposite end to the operculum
Content clear central space surrounded by cells.
 (see photograph of egg of the lung fluke, page 141)

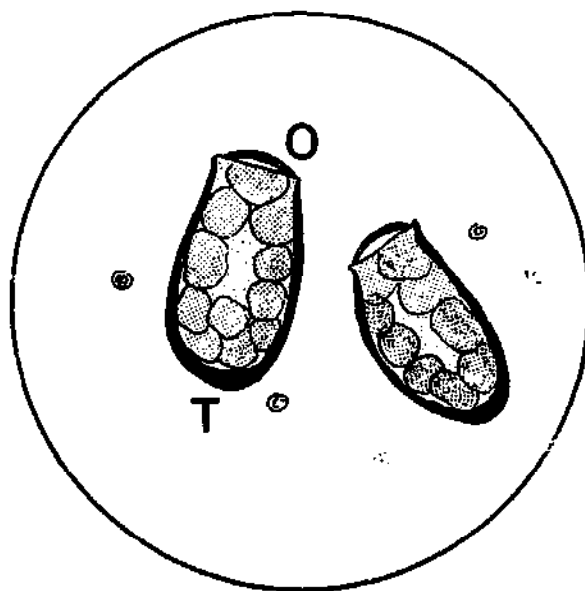

OTHER PARASITES FOUND IN SPUTUM

Hydatid scolex

Patients infected with *Echinococcus granulosus* (tapeworm caught from dogs) may sometimes have a *hydatid cyst of the lung*. If the cyst ruptures in the bronchi, scolices will be found in the sputum, which may be bloodstained.

Size about 150 μm

Shape round, irregular or oval, with one pole slightly flattened

Content colourless and transparent, then fine granules, but with a distinct *ring of hooklets* (10-30 hooklets).

Hydatid disease occurs in sheep-breeding areas: e.g. Argentina, Australia, Chile, Egypt, New Zealand, North Africa, Saudi Arabia, Uruguay.

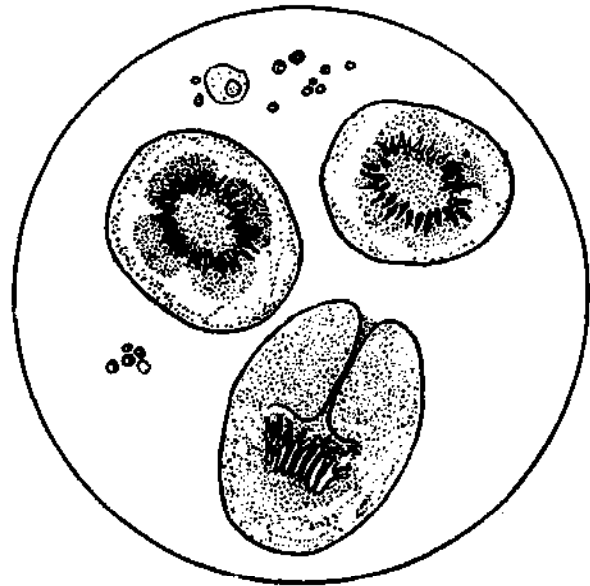

18. *Trichomonas*: Direct Examination of Genitourinary Discharge, etc.

Principle

Trichomonas vaginalis is a protozoon that can give rise to a genitourinary discharge (exudate), chiefly in women but occasionally in men. It can be detected under the microscope in wet preparations.

The discharge is fairly clear and whitish or may be greenish grey, foamy or frothy.

MATERIALS

- Glass slides
- Coverslips
- Warm (37 °C if possible) sodium chloride solution (reagent No. 45)
- Inoculating loop.

COLLECTION OF SPECIMEN

Females: The discharge must be taken to the laboratory immediately after being collected (in a tube or on a slide). Best on a swab placed in sodium chloride solution in a test-tube; the trichomonas remains motile for some time (usually several hours).

Males: Collect in the laboratory using the method described for gonococci (see page 243). Examine immediately.

METHOD

1. Place a drop of the discharge on a slide.

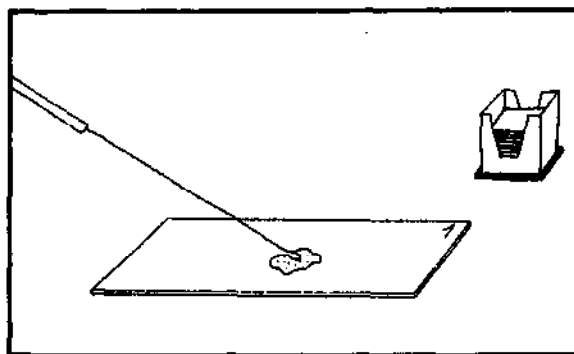

2. Add a drop of lukewarm sodium chloride solution. Mix and apply a coverslip.

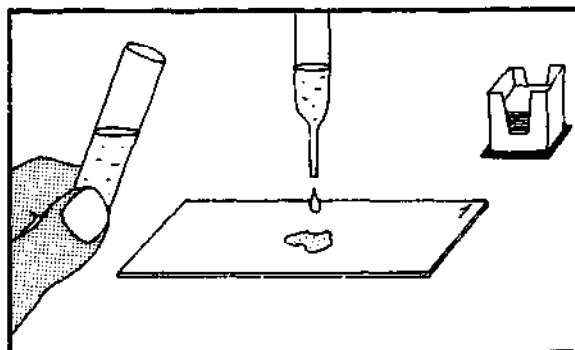

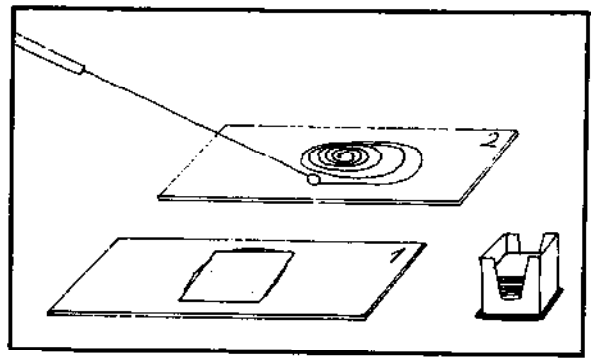

3. Make a large very thin smear of the discharge on another slide.

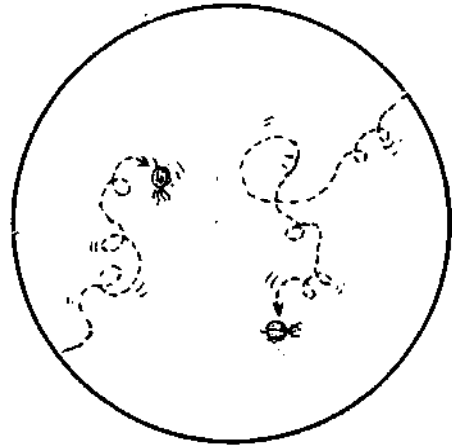

4. Examine at once under $\times 10$ objective

Look for tiny round transparent organisms, the size of a white cell, moving rapidly in jerks and loops.

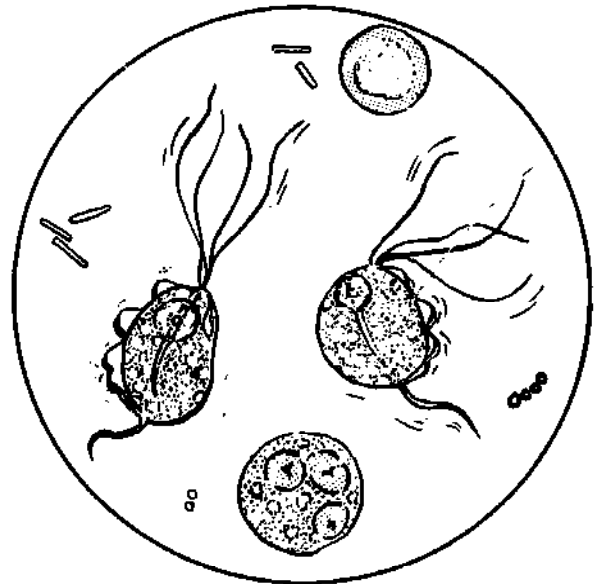

5. Examine using $\times 40$ objective to observe the trichomonas.

Size about $15\ \mu\text{m}$ ($10\text{--}20\ \mu\text{m}$)

Shape round, globular

Motility whirls and turns, seeming to vibrate

Undulating membrane: like the fin of a fish, on one side only; very motile (a rapid undulating movement)

4 flagella: whip-like, very motile; the main impression is one of movement.

Slide with smear

If nothing is found in the drop examined between the slide and coverslip, stain the dry smear on the second slide with Gram stain. Look for bacteria (gonococci?).

Fungi

Found in thick white (occasionally yellow or colourless) discharge. Using the x 40 objective, look for:

(a) Yeasts

- round or oval bodies
- non-motile
- varying in size (2-6 μm)
- some show buds.

(b) Mycelium filaments (occasionally)

- filaments with rounded ends
- varying in length (20-100 μm)
- 2-4 μm in breadth.

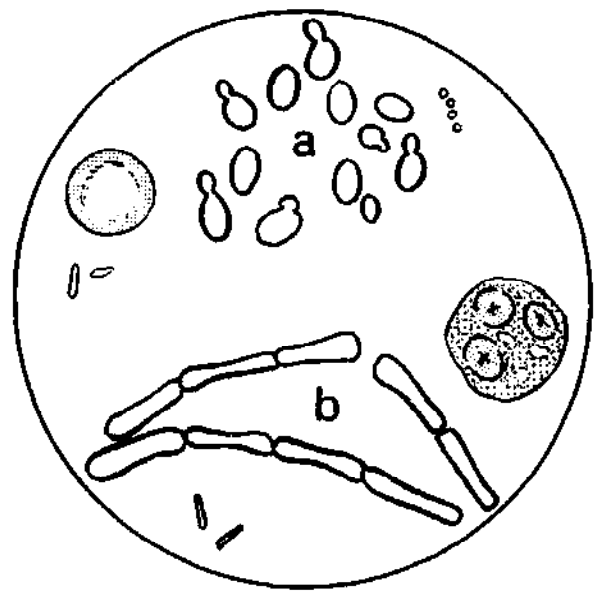

19. Preparation of Thick Blood Film and Staining with Field Stain

Purpose

Detection of parasites in the blood

1. A drop of blood from the finger is placed on a slide, spread and dried.
2. It is stained and examined under the microscope for the following:
 - malaria parasites
 - microfilariae
 - trypanosomes
 - borreliae.
3. The thick film method makes it possible to find parasites:
 - more quickly
 - if there are only a few present.

Principle

1. During staining of the drop of dried blood, the haemoglobin in the red cells dissolves and is washed out by the water in the staining solution.

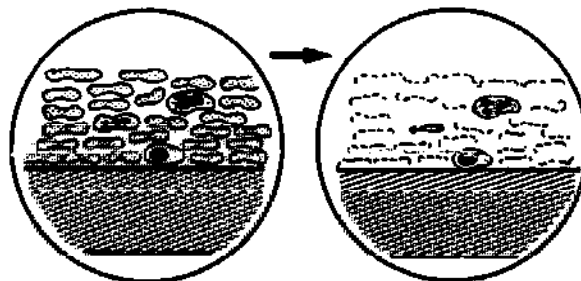

2. All that remain are:

- the parasites and
- the white cells

which can be seen under the microscope.

PREPARATION OF THICK FILM

Materials

- Clean glass slides (see cleaning procedures, page 31)
- Sterile lancet
- Methanol
- Cotton wool
- Grease pencil.

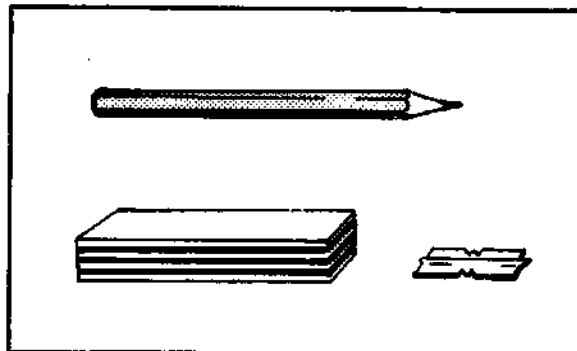

Method

Pricking the finger

1. Find a spot:
 - on the 3rd or 4th finger of the left hand
 - at the side of the finger, which is less sensitive than the tip, as shown.

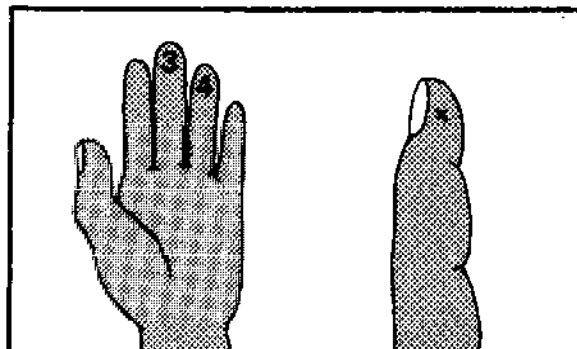

In babies under 6 months:

- prick the heel or big toe.

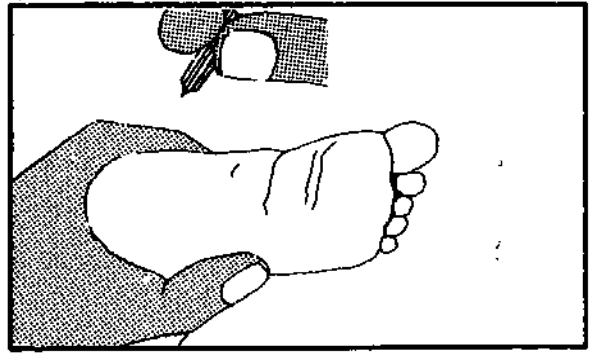

2. Clean the site:

- first with a cotton wool swab dipped in ethanol
- then with a second dry cotton wool swab or pledget, to remove any ethanol remaining.

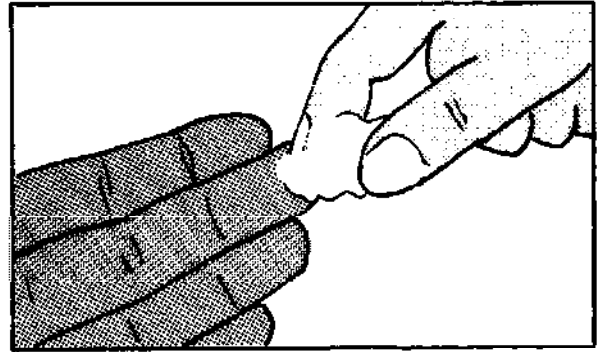

3. Prick the finger firmly and rapidly.

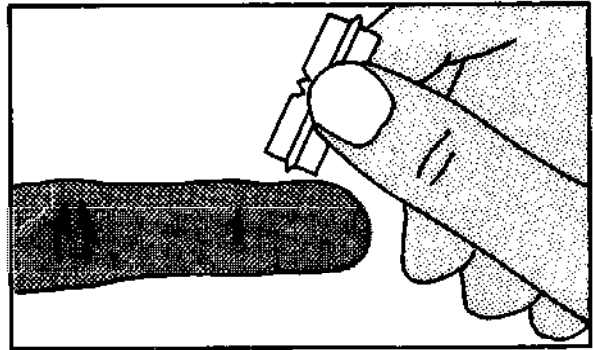

4. Wipe away the 1st drop of blood with dry cotton wool.

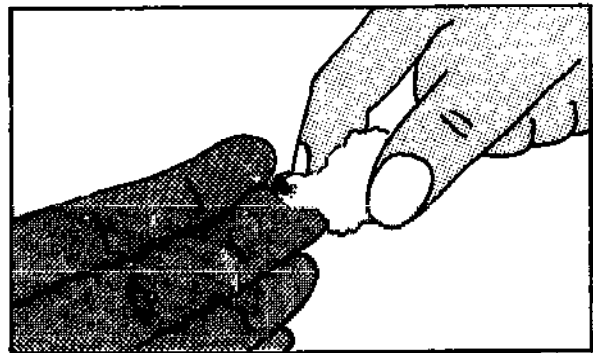

5. With your right hand:

- take a slide, holding it by the edges.

With your left hand:

- press the finger to produce a drop of blood, about this size: O

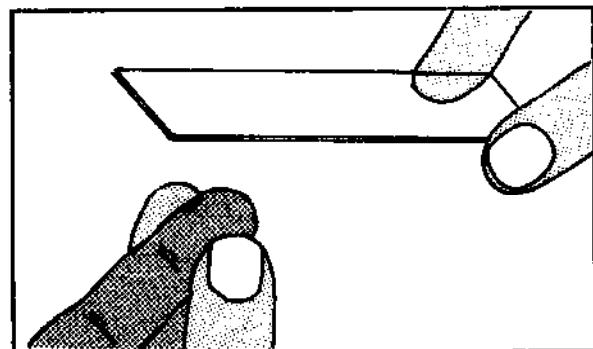

Preparing the film

6. Make a thick smear in the centre of the slide. Spread the blood with the corner of a clean slide to an even thickness; smears that are too thick or too thin will not stain well.

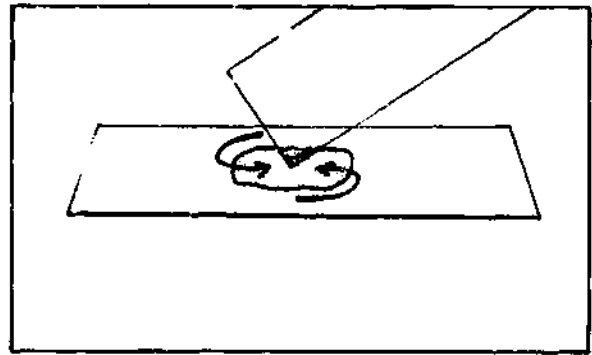

A correct thickness enables the hands, but not the figures, of a watch to be seen through the smear.

[A thin blood film may be useful if the identification of a species of malaria parasite proves difficult. Spread a thin film as described on page 387.]

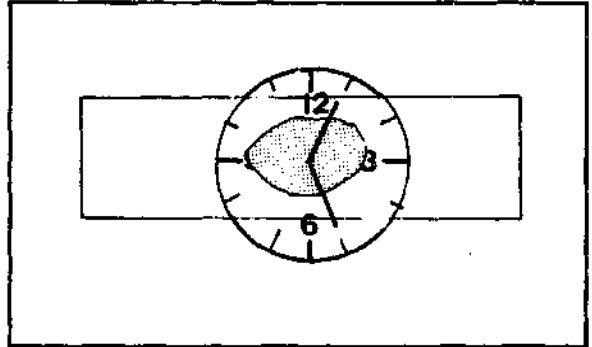

7. Label the end of the slide with the patient's number, using a grease pencil. Leave the thick film to dry in the air. A warm sunny bench is suitable, provided the smear is protected from flies and dust. An electric fan, if available, will speed up drying and keep flies away.

Thin films should be dried in the air and immediately fixed with methanol (methyl alcohol).

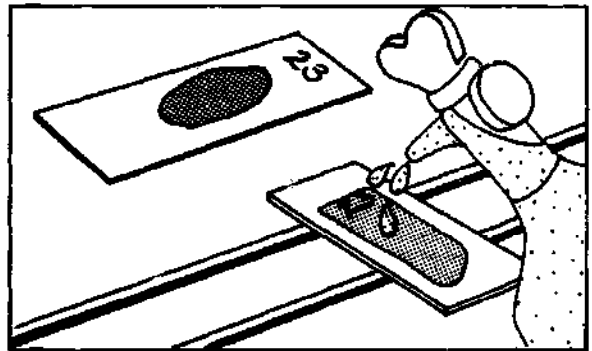

STAINING OF THICK BLOOD SMEARS USING FIELD RAPID STAINS

In many parts of the world Field stains A and B are used for thick blood smears, because:

- staining is rapid
- no dilution of the stains is necessary
- the stains can be used for several days (filter every two days; change when the results are no longer good)
- no buffered water is necessary; clean tap water can be used for washing the smears.

Diluted Giemsa stain, as used for thin films, can also be used for thick smears (see page 393).

Materials

- Field stain A (reagent No. 22A)
- Field stain B (reagent No. 22B)
- Two containers of clean tap water
- Draining rack.

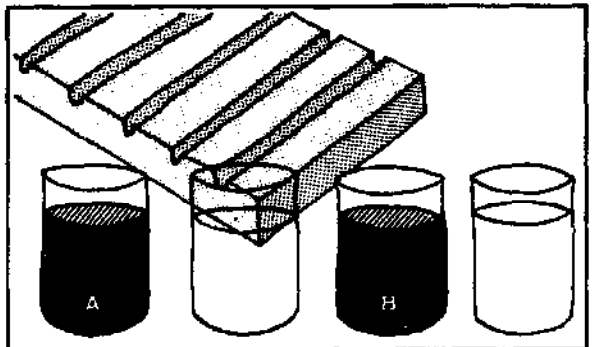

Method

1. Dip the dried thick smear into Field stain A:
 - count up to 10.

Drain the smear.
Wash in a container of tap water.

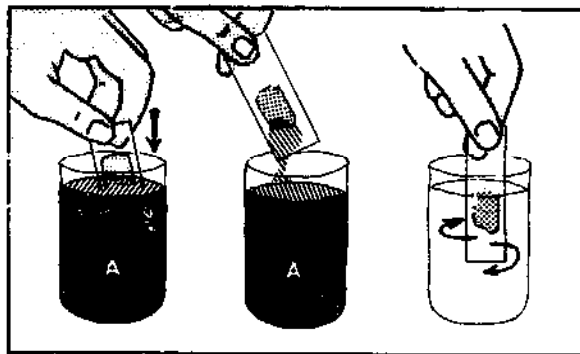

2. Dip into a container of Field stain B:
 - count up to 10.

Drain the smear.
Wash well in a container of clean tap water.

Note: The staining times may need altering.

If the smear is too blue:

- stain for a longer time with Field stain B.

If the smear is too pink:

- stain for a longer time with Field stain A.

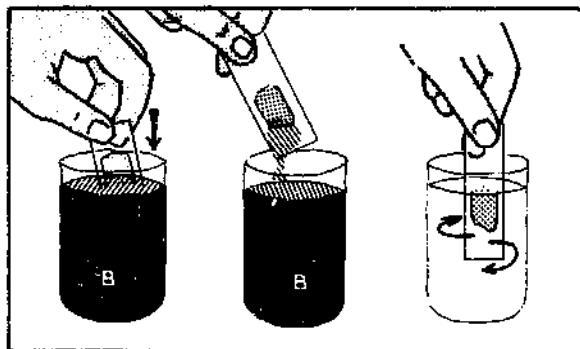

3. Dry the smear in the air in a draining rack (with the side with the smear facing down).

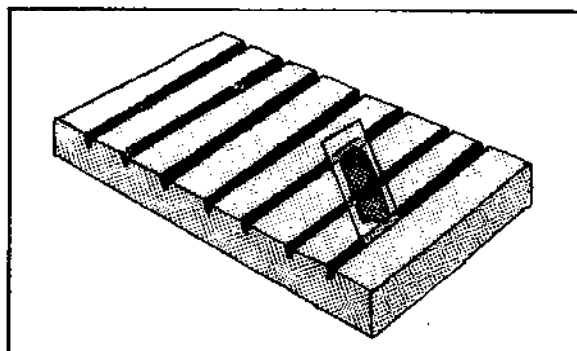

RESULTS

The smear should appear mauve. This will enable a malaria trophozoite to be recognized:

- the cytoplasm ring stains blue
- the chromatin dot stains dark red.

For species diagnosis see pages 200 and 201.

Also recognized in thick films:

- white cells, type and approximate number
- nuclei of normoblasts, staining dark red
- reticulocytes, appearing as circular areas of blue dots.

20. Staining of Thick and Thin films with Giemsa Stain

Important:

For a leukocyte type number fraction ("differential leukocyte count"), films are best stained with May-Grünwald and Giemsa stains (see page 393).

MATERIALS

- 10, 50 and 100 ml measuring cylinders
- 50 and 250 ml beakers
- Staining troughs
- Glass rod
- Wash bottle
- Slide forceps
- Slide rack
- Timer
- Giemsa stain (reagent No. 28)
- Methanol in a drop bottle
- Buffered water (for preparation, see page 61).

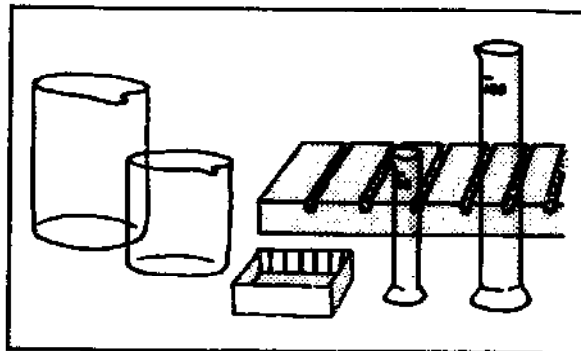

METHOD for less than 10 smears.

Important:

Stain thick film preparations at once with diluted Giemsa.
First fix thin films for 2-3 minutes in methanol (see page 391).

1. Make a 1 in 10 dilution of Giemsa stain.

Example

Use 18 ml buffered water and 2 ml stain; this will be sufficient for 4 smears. Increase the volume if more smears are to be stained.

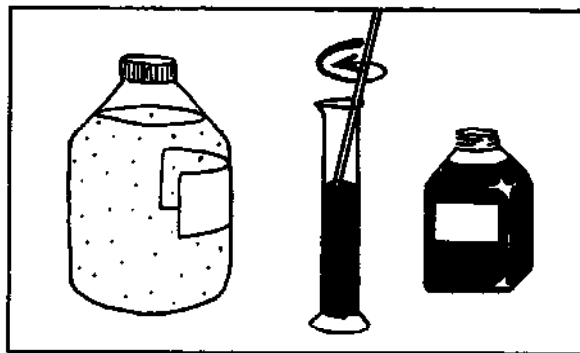
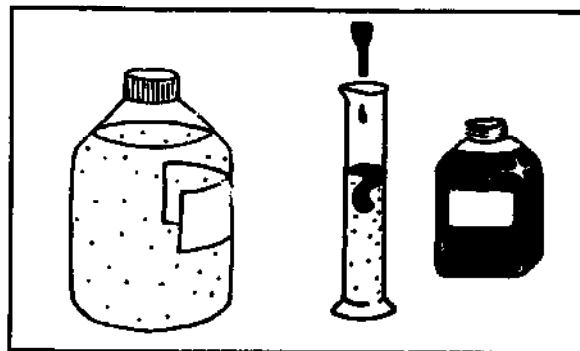

2. Mix gently with a glass rod.

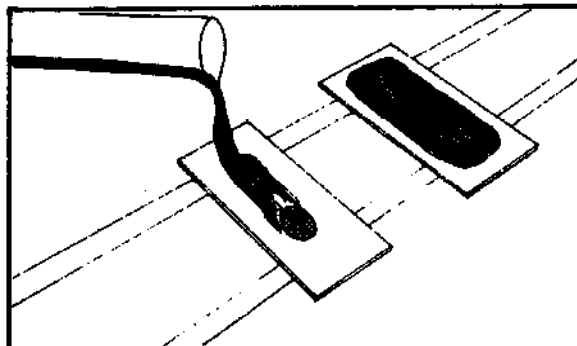

3. Place the slides across 2 glass rods. Cover them with diluted Giemsa stain.

4. Leave for 30 minutes.
(The staining time is given by the manufacturer: you may wish to adjust it when you have used the technique several times. If the film is too pale, the staining time has not been long enough.)

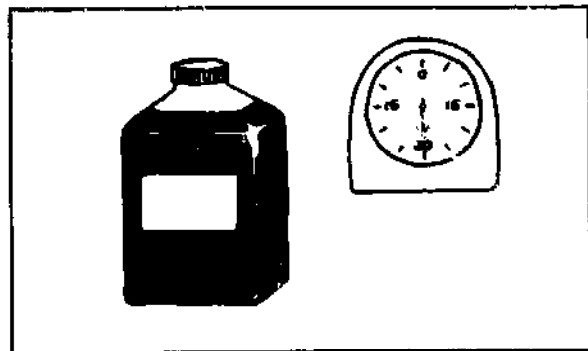

5. Wash off the stain with buffered water. Do not tip off the stain and then wash, as this will leave a deposit of stain over the smear.

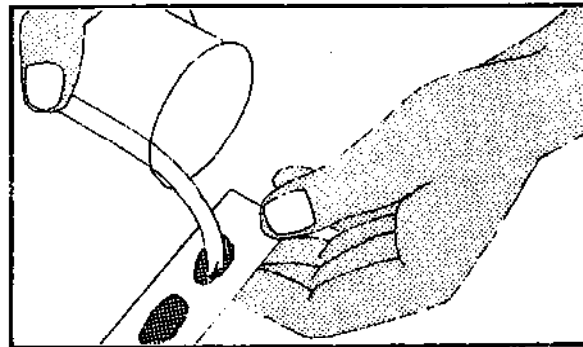

6. Drain off the water. Place the slides in a rack to dry. Place them in a sloping position, the slides with the stained films facing downwards to protect them from dust in the air. Drying stained slides by blotting them between sheets of filter paper is *not* recommended.

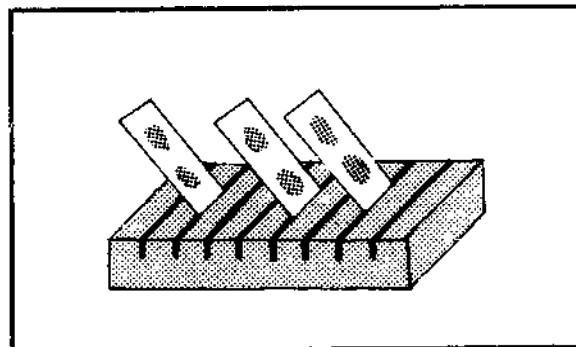

METHOD for large numbers of smears

1. Using forceps, pick up the slides one by one and slot them into the rack of the staining trough, in a Z pattern.
(Thin films have first to be fixed for 2-3 minutes in methanol.)

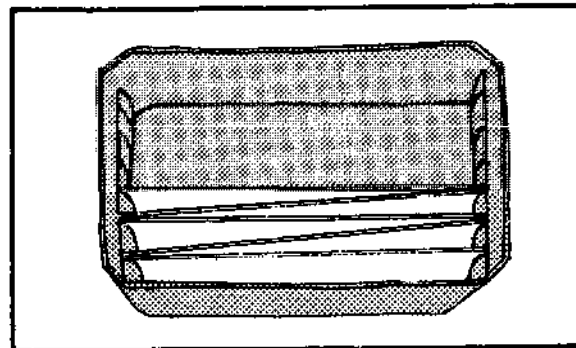

2. Make up sufficient stain to fill the staining trough. Slowly fill the staining trough containing the slides. Cover.
Leave for 30 minutes out of the sunlight.

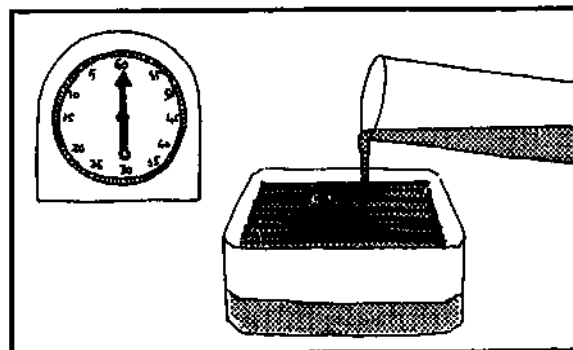

3. Remove the lid.

Slowly pour clean water from a beaker into the trough, to remove the deposit on the surface of the staining solution.

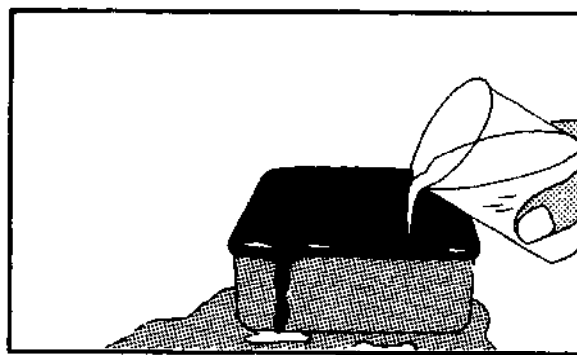

4. Gently pour off all the staining solution from the trough.

In some laboratories with limited supplies the dilute Giemsa is kept for reuse; if it is, it must be used on the same day.

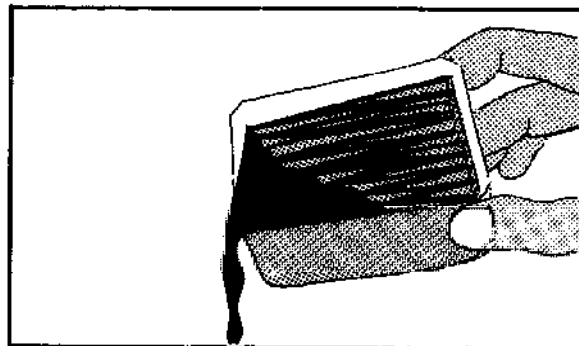

5. Fill the staining trough with buffered water.

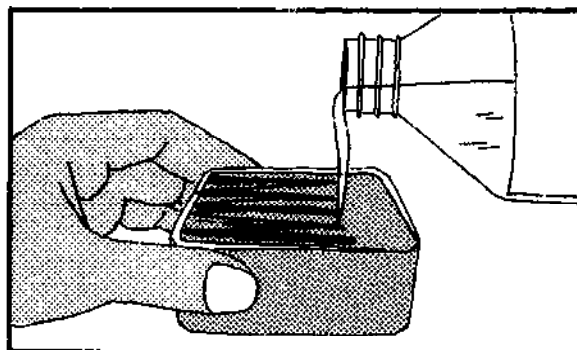

6. Take out the slides one by one, using forceps.

Dip each slide in a beaker of ordinary water, gently so that the stained preparation does not become unstuck.

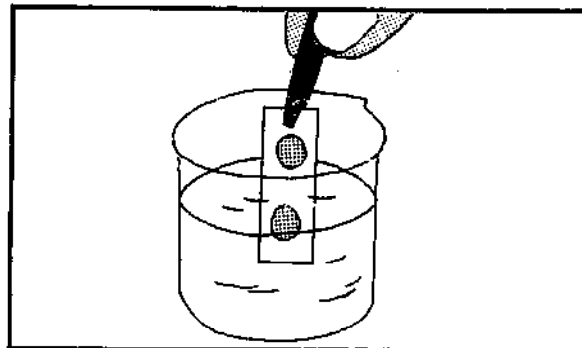

7. Drain the slides.

Place them in a rack to dry (the side with blood film facing downwards).

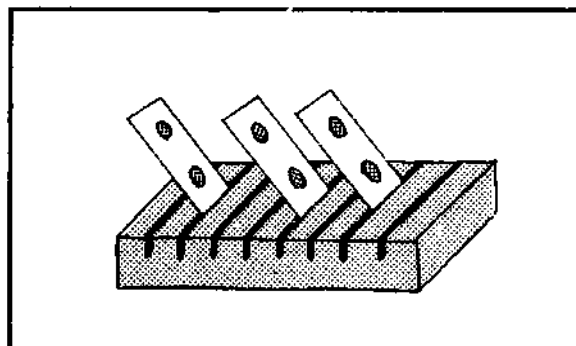

21. Identification of Malaria Parasites

The parasites that cause malaria are found in the blood; part of their development takes place within the red blood cells. Malaria parasites are detected in blood films stained by Field or Giemsa stain.

PREPARATION OF BLOOD FILMS

1. *When to collect the specimen*

The parasites are usually most numerous in the blood towards the end of an attack of fever.

Always collect the blood *before* antimalarial drugs are given.

2. *For individual patients*

Prepare:

- 1 slide with a thin blood film (see page 387) for the detailed examination of species if required, and
- 1 slide with a thick film (see page 189) for the detection of parasites.

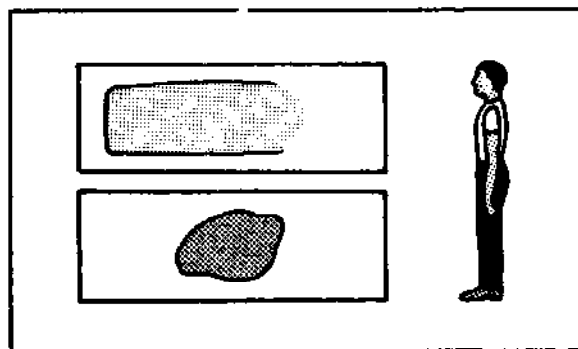

3. *For mass surveys*

Prepare:

- 1 slide only per person, with 1 thick film and 1 thin film on each.

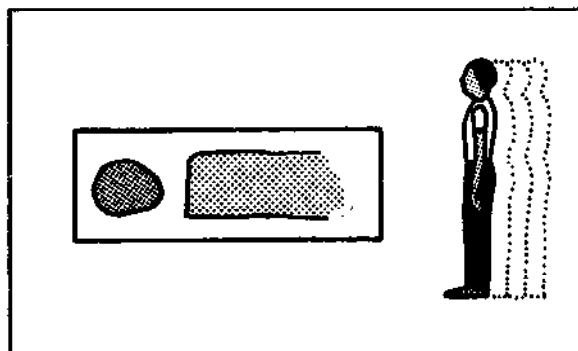

4. *Preservation of slides*

Keeping slides more than 4 days before staining is not recommended.

Field stain is recommended for smears stained straight away and Giemsa stain for smears to be stained after a few days.

STAINING

Fixation

Prior to staining, fix thin films only in methanol. Take care not to let the alcohol touch the thick film.

(See staining techniques, pages 191 and 393).

IDENTIFICATION OF MALARIA PARASITES

MALARIA PARASITE (stained)

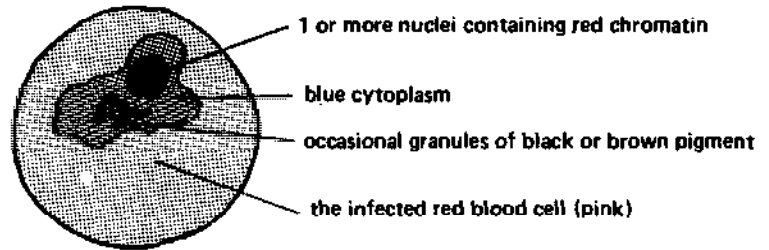

STAGES OF DEVELOPMENT

Parasites found in the blood are at different stages of development

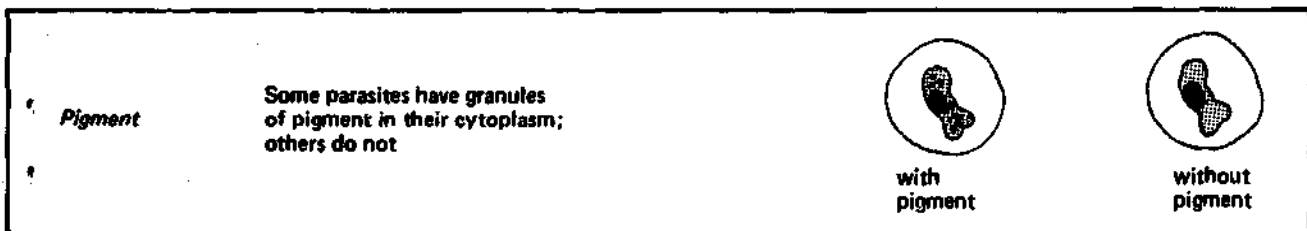
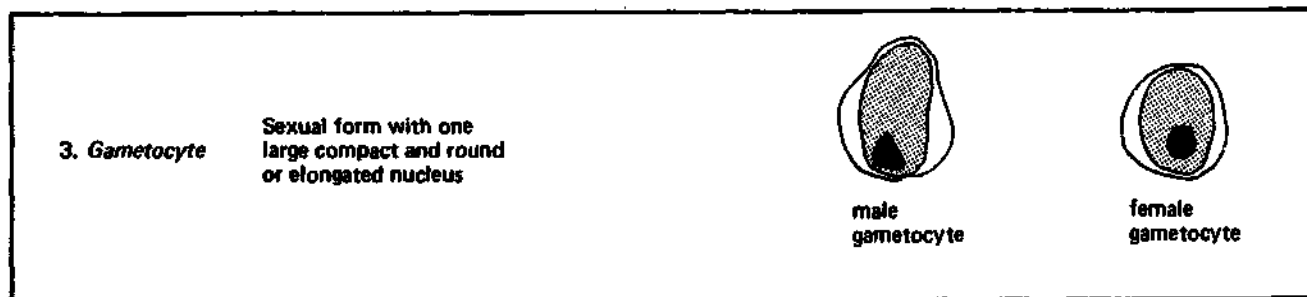
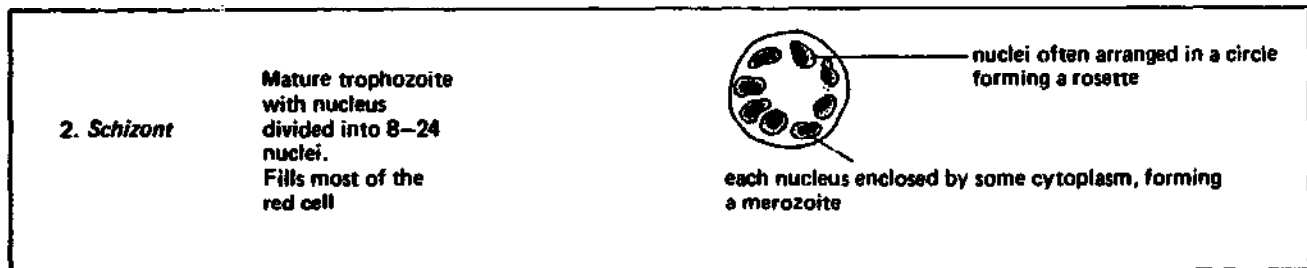
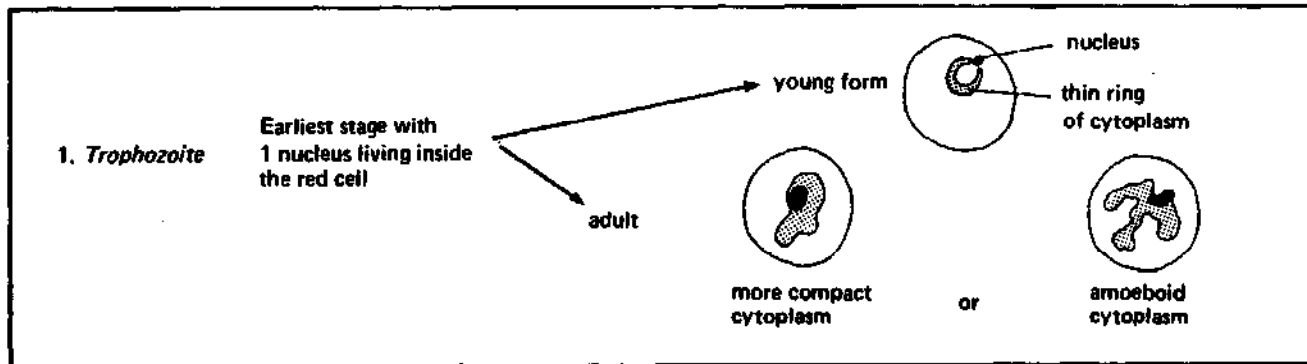

INFECTED RED CELLS

In thin films

The infected red cells may remain the same, may have changed colour or shape, or may contain pink spots (Schüffner's dots).

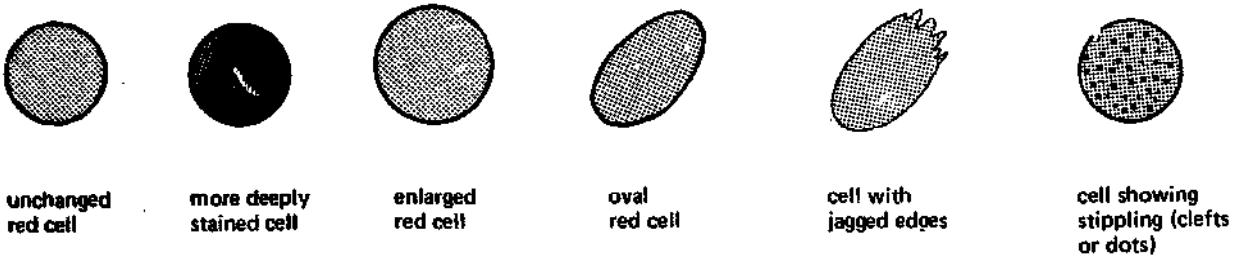

In thick films

The red cells have practically disappeared.

The pink Schüffner's dots can still be seen around the parasite.

The leukocytes remain unchanged.

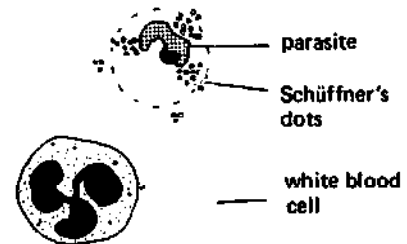

PARASITE DENSITY

This is the number of parasites counted in each microscopical field.

It usually varies according to species and it might therefore be useful to consider the density *in the thick film*.

It is important to report the parasite density (see page 203).

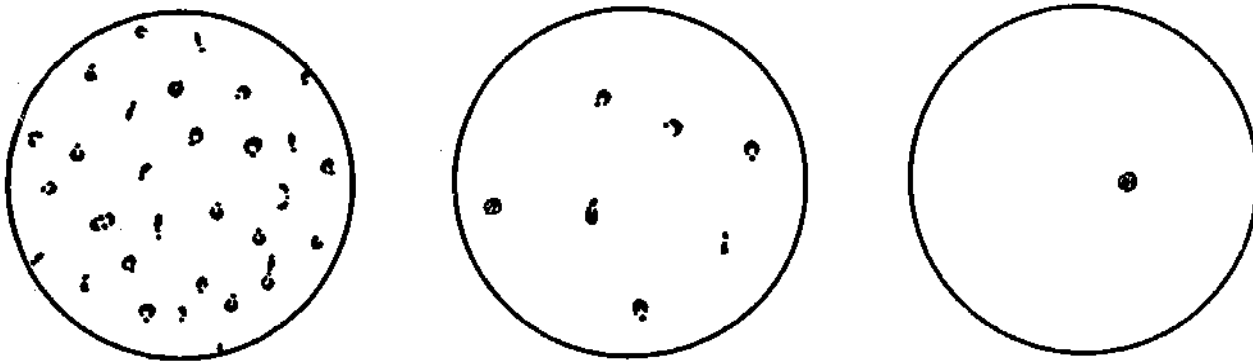

high density:
20 (or more) parasites
per field

medium density:
2-19 parasites
per field

low density:
1 (or less) parasite
per field

PARASITE SPECIES

There are 4 different species of human malaria parasite.

Plasmodium falciparum
Plasmodium malariae
Plasmodium ovale
Plasmodium vivax

It is important for the prognosis and treatment of the disease that the species involved be identified in the laboratory. However, if you cannot identify the species, always report the presence of any malaria parasites you see.

For example:

Malaria caused by *P. falciparum* is much more serious than malaria caused by *P. malariae* and sometimes causes death.

If not properly treated, however, a *P. malariae* infection can last much longer than a *P. falciparum* infection.

A patient can harbour more than one species of malaria parasite at the same time.

For example:

Plasmodium falciparum and
Plasmodium malariae

Plasmodium falciparum and
Plasmodium vivax

GEOGRAPHICAL DISTRIBUTION











	<i>P. falciparum</i>	<i>P. malariae</i>	<i>P. ovale</i>	<i>P. vivax</i>
North Africa	Common	Common	—	Predominant
West Africa	Predominant	Not common	Common	Very rare
Central Africa	Predominant	Common	Rare	Very rare
East Africa	Predominant	Common	Rare	Rare
Madagascar, Indian Ocean	Predominant	Common	Rare	Not common
Middle America	Common	Rare	—	Common
South America	Common	Rare	—	Predominant
South West Asia	Common	Not common	—	Predominant
India to Indochina	Predominant	Not common	—	Common
Indonesia	Predominant	Not common	Rare	Common
Pacific Islands	Common	Not common	Rare	Common

IDENTIFICATION OF THE FOUR SPECIES OF MALARIA



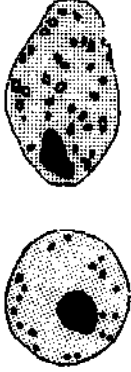

	<i>PLASMODIUM FALCIPARUM</i>	<i>PLASMODIUM MALARIAE</i>
YOUNG TROPHOZOITE	<p>(Stage frequently found)</p> <p><i>Cytoplasm:</i> small fine pale blue ring</p> <p><i>Chromatin:</i> 1 or 2 small red dots</p>	<p>(Stage frequently found)</p> <p><i>Cytoplasm:</i> thick, dense, blue ring with some granules of black pigment</p> <p><i>Chromatin:</i> 1 large red dot</p>
MATURE TROPHOZOITE	<p>(Stage frequently found)</p> <p><i>Cytoplasm:</i> rather thin blue ring, or shaped like a comma or exclamation mark</p> <p><i>Chromatin:</i> 1 or 2 medium-sized red dots</p>	<p>(Stage frequently found)</p> <p><i>Cytoplasm:</i> either (1) round, compact, dark blue, with many black particles of pigment, or (2) in band form (in thin films only)</p> <p><i>Chromatin:</i> a round dot or a red band</p>
SCHIZONT	<p>(Very rare)</p> <p>Hardly ever found in blood films (except in very serious cases)</p> <p><i>Merozoites:</i> 18-32</p> <p><i>Pigment:</i> dark brownish-black</p>	<p>(Fairly frequently found)</p> <p><i>Merozoites:</i> 8-10</p> <p>Each one a large red spot enclosed by pale cytoplasm; the 8 spots may be arranged irregularly (young form) or in a rosette</p> <p><i>Pigment:</i> always seen</p>
GAMETOCYTE	<p>(Fairly frequently found)</p> <p><i>Shape:</i> like a banana or sickle</p> <p><i>Colour:</i> blue (male) or dense blue (female)</p> <p><i>Nucleus:</i> reddish-pink</p> <p><i>Pigment:</i> a few blue-black granules in the centre of the cytoplasm or scattered through it</p>	<p>(Fairly frequently found)</p> <p><i>Shape:</i> large, oval or rounded</p> <p><i>Colour:</i> dense blue (female) or pale blue (male)</p> <p><i>Nucleus:</i> 1 round spot of red chromatin against one edge</p> <p><i>Pigment:</i> large black granules in the cytoplasm</p>
RED CELLS	<p>Normal in size</p> <p>May show crenation cells containing mature trophozoites; often contain a few red dots, irregular in size and shape</p>	<p>Normal in size and shape</p> <p>No red dots usually seen</p>
PARASITE DENSITY	<p>often very high density</p>	<p>Low density</p>

* The parasite density in any area depends mainly on whether the malaria is seasonal or endemic. Adults, especially, build up immunity in endemic areas and the parasite density is often low.

PARASITES IN BLOOD FILMS

	<i>PLASMODIUM VIVAX</i>	<i>PLASMODIUM OVALE</i>	Identity of <i>P. ovale</i> must be confirmed by examination of a thin blood film
YOUNG TROPHOZOITE	<p>(Stage frequently found)</p> <p><i>Cytoplasm:</i> irregular blue quite thick ring</p> <p><i>Chromatin:</i> 1 rather large red dot</p>		<p><i>Cytoplasm:</i> regular dense blue ring</p> <p><i>Chromatin:</i> 1 medium-sized red dot</p> 
MATURE TROPHOZOITE	<p>(Not frequently found)</p> <p><i>Cytoplasm:</i> large, blue, irregular (sometimes divided into 2, 3 or 4); small particles of brownish-orange pigment</p> <p><i>Chromatin:</i> 1 red dot</p>		<p><i>Cytoplasm:</i> round, compact, very blue with a few particles of brown pigment</p> <p><i>Chromatin:</i> 1 large red dot</p> 
SCHIZONT	<p>(Quite frequently found)</p> <p><i>Merozoites:</i> 12-18 large compact red granules seen against the pale blue cytoplasm</p>		<p><i>Merozoites:</i> 8-14 large red granules in a rosette, round a central mass of particles of brown pigment</p> 
GAMETOCYTE	<p>(Frequently found)</p> <p><i>Female:</i> oval or rounded, dense blue</p> <p>A dense red triangular nucleus, often at one end; many particles of orange pigment in the cytoplasm</p> <p><i>Male:</i> rounded, pale blue</p> <p>A round central pale red nucleus; some particles of orange pigment in the cytoplasm</p>		<p><i>Shape:</i> large, oval or round, dense blue</p> <p><i>Nucleus:</i> 1 round red spot</p> <p><i>Pigment:</i> a few brown particles in the cytoplasm</p> <p><i>Differentiated from:</i></p> <ul style="list-style-type: none"> - <i>P. vivax</i> by its brown pigment - <i>P. malariae</i> by the presence of Schüffner dots 
RED CELLS	<p>Enlarged, often pale-staining Schüffner dots, especially around mature trophozoites</p>		<p>May appear oval with jagged ends</p> <p>Easily seen large red James dots</p> 
PARASITE DENSITY	<p>Medium density</p> 	<p>Medium density</p> 	

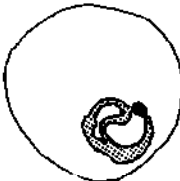
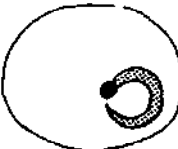
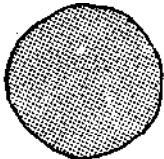
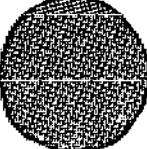
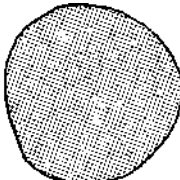
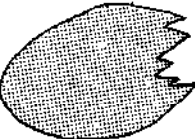
COMPARISON OF INFECTED CELLS IN THE THIN BLOOD FILM

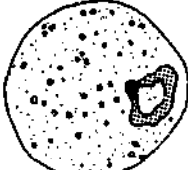
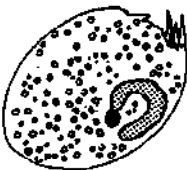
	<i>P. falciparum</i>	<i>P. malariae</i>	<i>P. vivax</i>	<i>P. ovale</i>
SIZE of young trophozoite in comparison with diameter of red cell (at the same stage of development)	 1/5 to 1/3 of diameter	 1/4 to 2/3 of diameter, but often band form seen	 1/4 to 2/3 of diameter	 1/4 to 2/3 of diameter
APPEARANCE of infected red cell	 Remains unchanged	 Remains unchanged or becomes smaller and sometimes more deeply coloured	 Enlarged and often pale-staining	 Enlarged, oval, with torn jagged edges
DOTS in the infected red cell	 Often none*	 None	 Small pink, Schüffner dots	 Large James dots always present
STAGES found	Trophozoites or gametocytes or both together; many trophozoites can be found in one cell	All forms found in the same film	All forms found in the same film	All forms found in the same film

NOTE:

Appearance of monocytes (in malaria cases of long duration):

- the cytoplasm often contains brown or greenish-black bodies (siderophils).

Appearance of malaria parasites following injection of an antimalarial drug:

- the parasites stain poorly and look distorted and indistinct.

* In some red cells infected with adult trophozoites of *P. falciparum* a few fairly large pink granules called "Maurer clefts" can be found.

REPORTING RESULTS

Positive result

Specify:

1. The species of parasites found
2. The stage of development of the parasite
3. The parasite density*.

Example

Examination for malaria parasites positive.

- *Plasmodium falciparum*
- many trophozoites
- a few gametocytes.

Negative result

State: no parasites found.

Important: Do not mistake platelets superimposed upon red cells for malaria parasites (for platelets, see page 351).

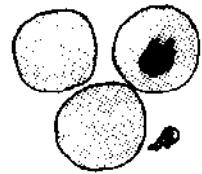

*When the parasites are very numerous (very high parasite density), the patient requires urgent treatment. Therefore, if you find a high parasite density, state the result clearly in your report and send it without delay to the physician.

22. Blood Microfilariae: Examination of Wet Preparation, Concentration

Principle

Capillary blood

Mix a fresh smear of capillary blood from the finger with sodium chloride solution, place between a slide and coverslip, and examine for motile microfilariae under the microscope.

Venous blood

The microfilariae can also be concentrated using venous blood.

A. EXAMINATION OF CAPILLARY BLOOD

The examination should be carried out at the right time of day.

Some species of microfilariae appear in the blood at night only, others only during the day.

Species	When to take a specimen*	Part of world
<i>W. bancrofti</i>	At night (between 22 h and 4 h)	Tropical Africa, Asia, Middle and South America, Indian Ocean
<i>W. bancrofti</i> (var. <i>pacifica</i>)	Any time	Pacific Ocean
<i>B. malayi</i>	Mainly at night (between 22 h and 4 h)	Asia
<i>Loa loa</i>	During the day (between 10 h and 16 h)	West and Central Africa
Doubtfully pathogenic filariae: — <i>D. perstans</i> — <i>M. ozzardi</i>	Any time Any time	Tropical Africa Tropical America

*These periods are not invariable.

Materials

- Blood lancet
- Cotton wool swabs
- Slide
- Coverslip
- Sodium chloride solution (reagent No. 45)

5. Prepare 2 thick films on another slide using 2 drops more of blood, for the identification of stained microfilariae (see page 189).

Examine the fresh smear systematically under the microscope (x 10 objective with reduced condenser aperture).

The first sign of the presence of microfilariae is rapid movement among the red cells.

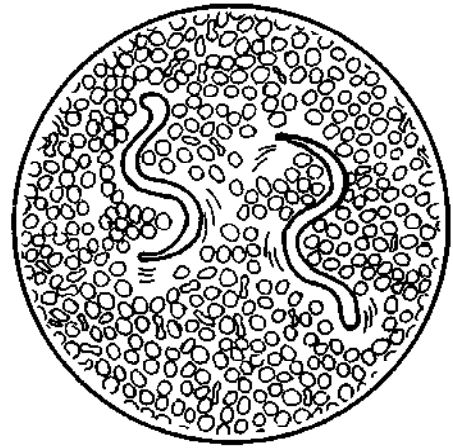

Microfilariae in fresh blood smears

Microfilariae are identified in stained smears. It is possible, however, to gain some indication from a fresh smear:

- of the species seen and its pathogenicity.

Pathogenic

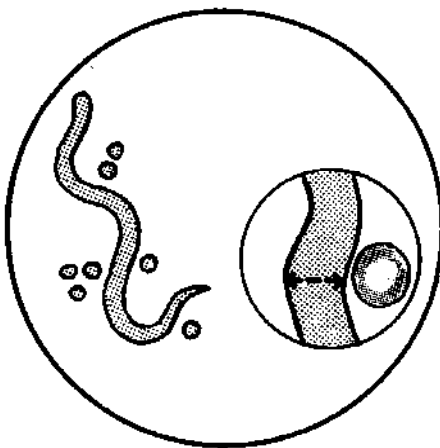

Thickness: usually 6-8 μm
(diameter of a red cell)
Length: usually 250-300 μm
($\frac{1}{2}$ the field in the diagram)

W. bancrofti, *Loa loa*, *B. malayi*

Doubtful pathogenicity

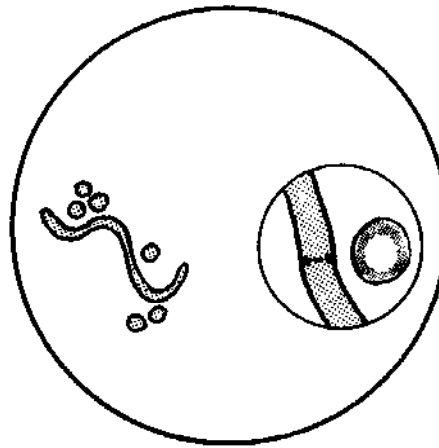

Thickness: usually 4 μm
($\frac{1}{2}$ the diameter of a red cell)
Length: usually 150 μm
($\frac{1}{4}$ of the field in the diagram)

D. perstans, *M. ozzardi*

6. Identify the species of microfilariae by staining the preparation, see page 209.

B. EXAMINATION OF VENOUS BLOOD CONCENTRATION FOLLOWING HAEMOLYSIS

Materials

- 5 ml syringe
- Needles for venepuncture
- Anticoagulant: 2% trisodium citrate solution (reagent No. 53)
- 2% formaldehyde solution
- Centrifuge
- Conical centrifuge tubes.

Method

1. Collect 4 ml of venous blood.
Expel into a bottle containing 1 ml of citrate solution.
Mix.

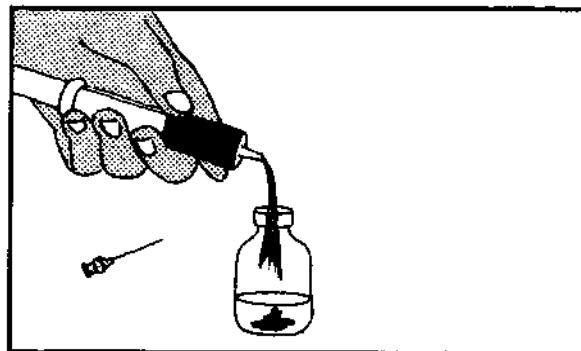

2. Measure into a conical centrifuge tube:
 - 10 ml 2% formaldehyde solutionAdd:
 - 1 ml of citrated blood.Mix. Wait 5 minutes for the red cells to haemolyse.

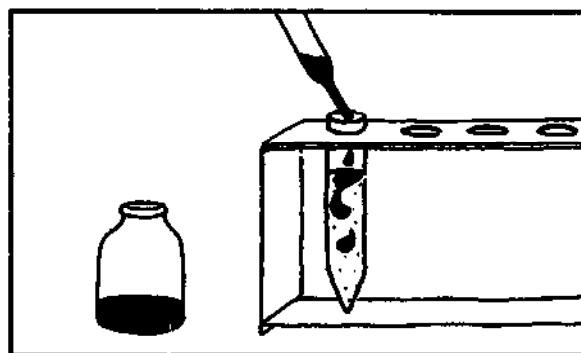

3. Centrifuge for 5 minutes at high speed.
Pour off the supernatant fluid.
Tap the tube to mix the deposit.

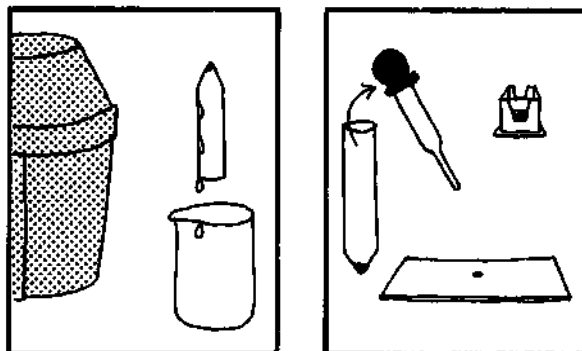

4. Place 1 drop of the deposit on a slide.
Spread the drop to form a thin smear.
Leave to dry in the air.
Fix the smear using ether and ethanol in equal parts.
Leave to dry for 2 minutes.
Stain immediately with Giemsa stain (see page 193).
The microfilariae stain well (for identification, see pages 212 and 213).

C. TECHNIQUE USING A MICROHAEMATOCRIT CENTRIFUGE

Collect venous blood from the patient into a citrated bottle as shown above, or take 2 drops of capillary blood from the finger and mix with 1 drop of 2% trisodium citrate solution.

1. Three-quarters fill a microhaematocrit capillary tube with the citrated blood. Seal one end of the tube with plastic modelling clay or by heating.
2. Centrifuge in a microhaematocrit centrifuge at high speed for 2 minutes.
3. Lay the capillary tube on a slide and secure the 2 ends with adhesive tape.

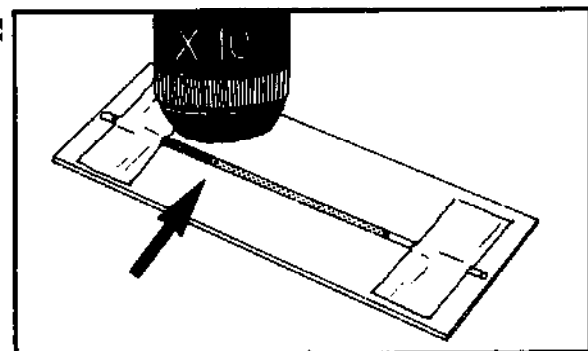

Examine the dividing line between the blood cells and the plasma under the microscope, using the x 10 objective with reduced condenser aperture.

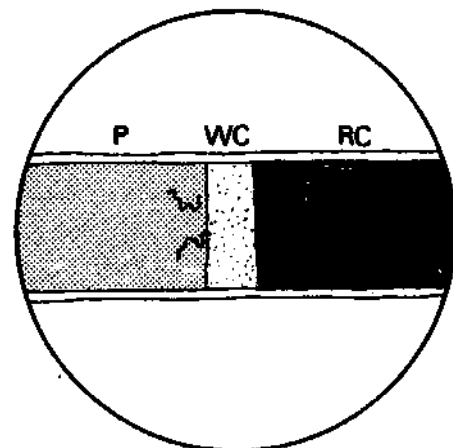

Motile microfilariae will be seen at the bottom of the column of plasma, just above the layer of white cells.

The tube can be snapped at this point. With the 1st drop from each piece of the broken tube, a thick film can be prepared. Stain with Giemsa to identify the species.

23. Blood Microfilariae: Staining and Identification

Principle

Microfilariae must be stained before they can be identified with certainty.

MATERIALS – REAGENT

- Blood lancets
- Slides
- Sodium chloride solution (reagent No. 45)
- Staining trough
- Dropping pipette
- Beakers
- 10 ml measuring cylinder
- Giemsa stain.

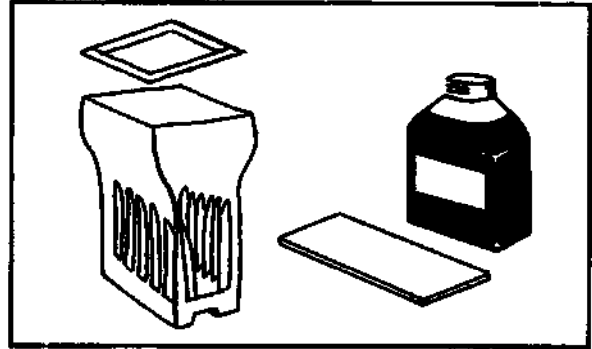

A. THICK FILM

Take 1 drop of capillary blood at the right time of day (see table, page 204).

Make a thick smear as described on page 189).

B. REMOVAL OF HAEMOGLOBIN

- (a) Place the slides vertically in the staining trough filled with clean water (if no trough is available, use a beaker).
- (b) Leave for 10 minutes (the haemoglobin sinks gradually to the bottom).
- (c) Take the slides out and drain them.

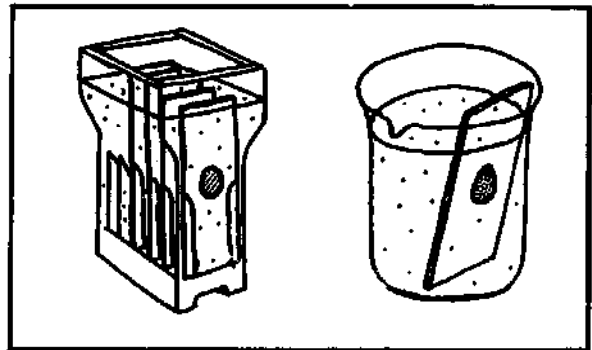

C. STAINING WITH GIEMSA STAIN

Stain for 30 minutes using a 1 in 10 dilution of Giemsa, as described on page 193.

D. MICROSCOPICAL EXAMINATION

- (a) Cover the stained smear with a thin film of immersion oil.
- (b) Look for microfilariae using the x 10 objective: they should stand out well.
- (c) Examine the microfilariae found with the x 100 oil-immersion objective.

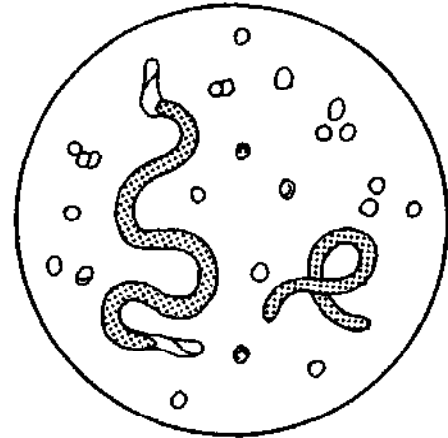

E. IDENTIFICATION: SOME USEFUL CHARACTERISTICS

Study in order of importance:

- (a) *The size of the microfilaria:*
 - its length (in relation to the field)
 - its thickness (in relation to the leukocytes)
 - as thick as 1 white cell (1)
 - as thick as ½ a white cell (2).

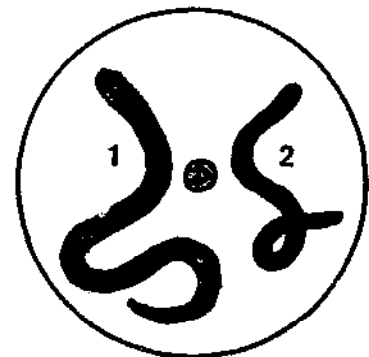

- (b) *The sheath of the microfilaria*

In the diagram opposite the sheath of the microfilaria is present in (3) and absent in (4). The sheath may be stained red by Giemsa stain or remain colourless, depending on the species.

(Important: the sheath is sometimes torn and difficult to see. Positive identification cannot be based on this characteristic alone.)

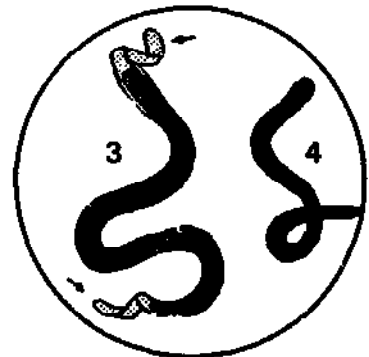

- (c) *The curves of the microfilaria*

There are several types of curve:

- large curves (5)
- many small curves (6)
- few small curves (7).

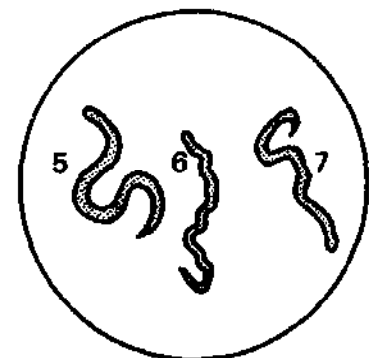

(d) *The tail of the microfilaria and its nuclei*

The following features may be seen:

- nuclei extending to the tip of the tail (8) or not (9)
- a tapered tail (10)
- a rounded tail (11)
- a hooked tail (12).

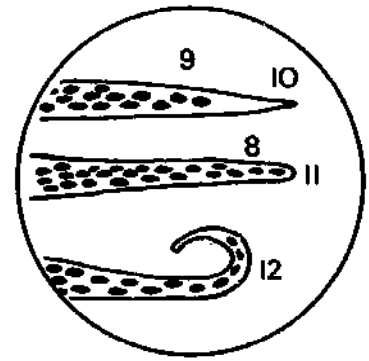







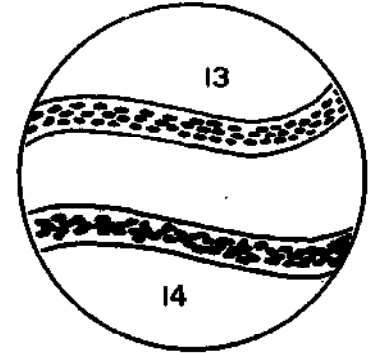

(e) *The nuclei in the body*

These stain purple with Giemsa stain. They may be:

- well separated (13)
- overlapping (14).



IDENTIFICATION OF MICROFILARIAE













	<i>Wuchereria bancrofti</i>	<i>Loa loa</i>
Where	Tropical Africa Asia Tropical America Indian Ocean Pacific Ocean	Central Africa West Africa (from Nigeria to Gabon)
When	At night*	During the day
Length	200-300 μm	250-300 μm
Thickness	8 μm (about 1 leukocyte**) 	8 μm (about 1 leukocyte) 
Sheath	Pink sheath 	Almost colourless sheath 
Body curves	Regular, large 	Irregular, small 
Tail	No nuclei at end***  Rather straight tapered tail	Nuclei right to tip  Curved tapered tail
Body nuclei	Round medium-sized nuclei, well separated	Large round nuclei crowded together and overlapping

*Except var. *pacifica*: any time.

**In thick films the leukocytes always shrink and measure 8-11 μm .

***The tail is sometimes broken or coiled, giving a false impression that there are nuclei right to the tip.

STAINED WITH GIEMSA STAIN

<i>Dipetalonema perstans</i>	<i>Brugia malayi</i>	<i>Mansonella ozzardi</i>
Tropical Africa South America	Asia	Central America South America
Any time	Chiefly at night	Any time
150-200 μm	220-250 μm	150-200 μm
4 μm (½ leukocyte)	6 μm (almost 1 leukocyte)	4 μm (½ leukocyte)
		
No sheath	Very pink sheath	No sheath
		
Regular, look like loops in string	Small, irregular and many	Few and small
		
Double row of nuclei right to the tip	2 widely spaced nuclei at the end of tail	1 row of nuclei extending almost to tip
		
Straight tail with rounded tip	Curved very tapered tail	Straight tapered tail
Small nuclei squeezed together; indistinct (plaited appearance)	Small angular nuclei, squeezed together and not very distinct	Small round nuclei packed closely in a double or triple row

SOME POINTS TO REMEMBER WHEN IDENTIFYING MICROFILARIAE

Identification of species can be difficult and experience has shown that mistakes are frequently made. Nevertheless, if a systematic study is made of *all the characteristics mentioned*, it should be possible to identify with certainty the species observed. The identification must not be based on a single characteristic but on all the features taken together.

Examples of some mistakes

1. The tail

If the tail of *W. bancrofti* is broken or folded over, it appears to have nuclei extending to the tip like *Loa loa*.

2. The sheath

The sheath is sometimes torn or almost colourless. In *Loa loa*, for example, it is seen only as a colourless space between the tail and the blood cells.

3. Size

Some *D. perstans* are very long (200 μm); and some *W. bancrofti* and *Loa loa* are small (250 μm).

4. The curves

If damaged when the film is being made, *W. bancrofti* may appear twisted and *Loa loa* may show a few curves.

5. Geographical distribution

Always bear in mind where the patient comes from. If he is from:

- The Zaire river basin, Eastern Nigeria or Cameroon, the parasite is probably *Loa loa*
- Senegal, Ghana, the West Indies or India, the parasite is probably *W. bancrofti*
- Thailand, the parasite is probably *B. malayi*
- Guyana, the parasite is probably *M. ozzardi*.

6. Thin films

Identification of microfilariae in stained thin-films is not recommended; the microfilariae are shrunken, distorted and difficult to recognize.

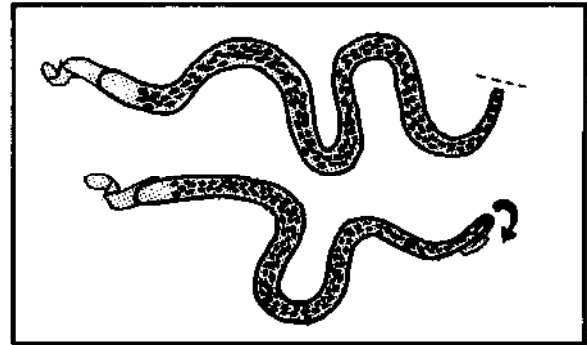

24. Onchocerciasis: Examination for Skin Microfilariae

Onchocerciasis (river blindness) is a parasitic disease caused by the worm *Onchocerca volvulus*. The male and female worms live in the subcutaneous tissues of man, massed in nodules. The female worms lay larvae (the microfilariae) that migrate under the skin.

Onchocerciasis is prevalent in tropical Africa and in parts of Arabia and Middle and South America. It is transmitted by a small blackfly, *Simulium*.

Laboratory examination

A very small piece of the patient's skin is collected. To see the highly motile microfilariae, it is examined as a wet preparation between a slide and coverslip under the microscope.

MATERIALS

- Needle (for intramuscular injection 22-gauge (0.7 mm) x 40 mm or for subcutaneous injection 22-gauge x 25 mm)
- Scalpel or razor blade
- Sodium chloride solution (reagent No. 45)
- Slides, coverslips
- Ethanol.

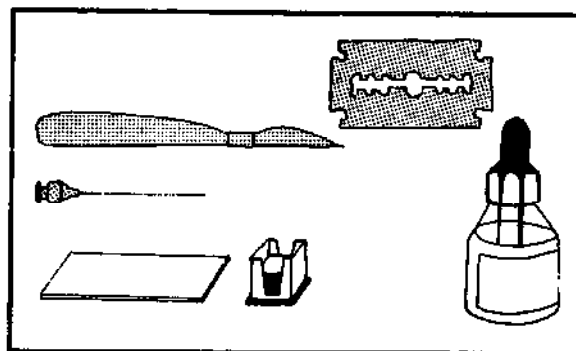

WHERE TO COLLECT THE SPECIMEN

(a) Patients with nodules

Look for nodules:

- on the chest (over the ribs)
- on the hips
- on the legs (tibia)
- on the back (shoulder-blades).

The nodules are round and hard, 1–5 cm in diameter; when pushed with the fingertips they slide about under the skin. Take the specimen from the skin in the centre of the nodule.

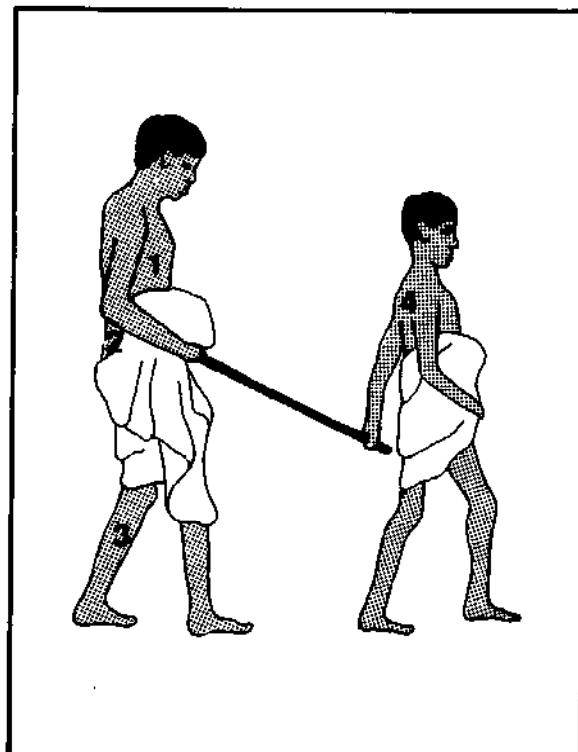

(b) Patients without nodules

Take the skin specimen from:

- the top of the buttocks (the upper outer part where intramuscular injections are given).

If the examination gives a negative result, take specimens from:

- the calf (upper outer part)
- the back (centre of shoulder-blade).

It is recommended that 6 specimens (2 from buttocks, 2 from calves, 2 from shoulder-blades) be examined before reporting a negative result.

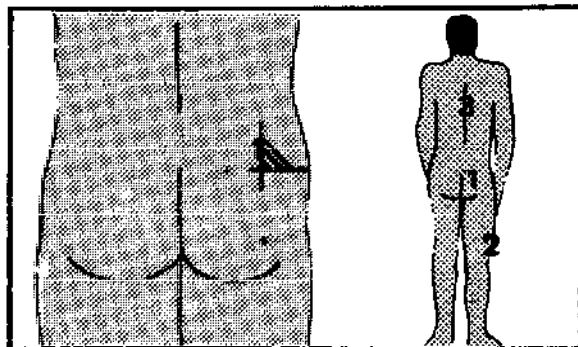

COLLECTION OF SPECIMEN

(a) Preparations

1. Flame the scalpel (or razor blade) and the needle with ethanol.
2. Place one drop of sodium chloride solution on a slide.
3. Disinfect the chosen area with a gauze pad dipped in ethanol.

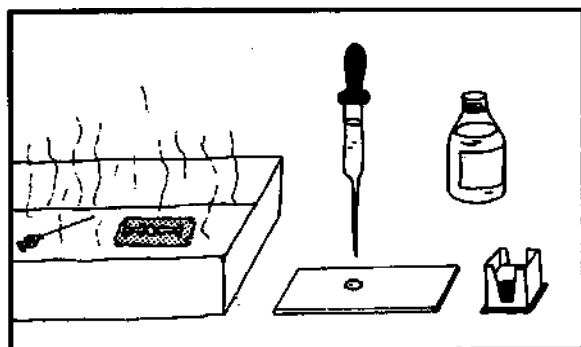

(b) Method

1. Using your left hand, pierce the skin with the point of the needle to a depth of 2 or 3 mm.

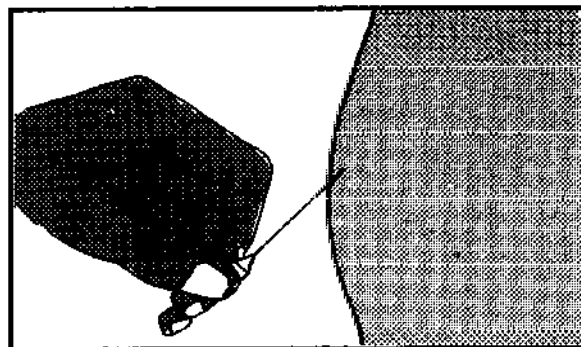

2. Pull the skin away from the flesh with the point of the needle.

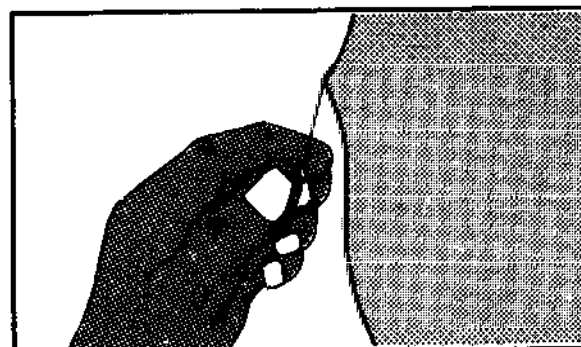

3. Place the cutting edge of the scalpel or razor blade on the stretched skin above the point of the needle (using your right hand).

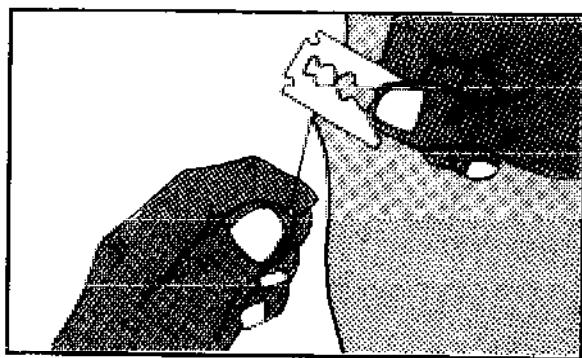

4. Cut with a quick stroke the piece of skin pulled up by the point of the needle, as close to the needle as possible. The specimen should be about this size: ●.
(2-3 mm)

It should remain attached to the tip of the needle. The specimen should not be bloodstained; the biopsy must be bloodless.

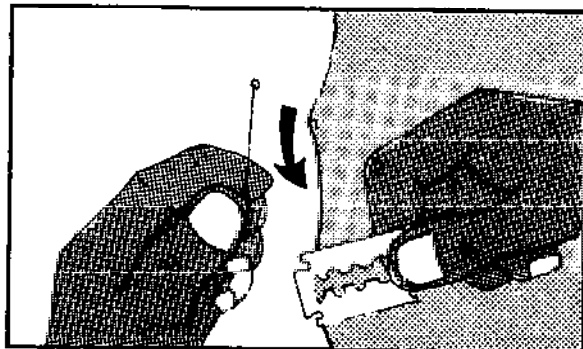

5. Place the fragment of skin in the drop of sodium chloride solution on the slide (using the scalpel or razor blade if necessary). Do not flatten the piece of skin; if only one microfilaria is present, it might be damaged.

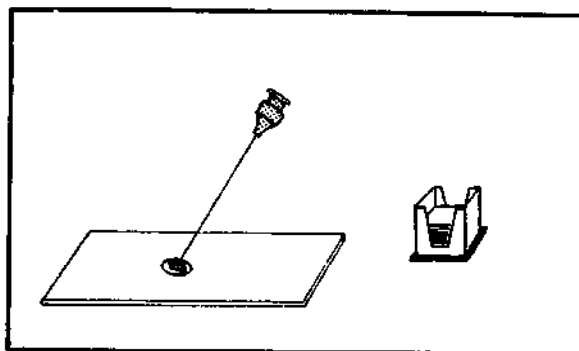

6. Cover with a coverslip. If any part of the specimen is not in contact with the liquid, add more solution, injecting it under the coverslip with a Pasteur pipette, until the whole area underneath the coverslip is wet.

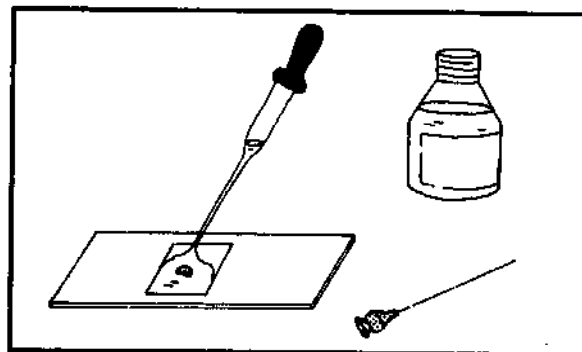

7. Wait 2-3 minutes. Meanwhile, clean the spot from which the specimen was taken with ethanol. Apply an adhesive dressing.

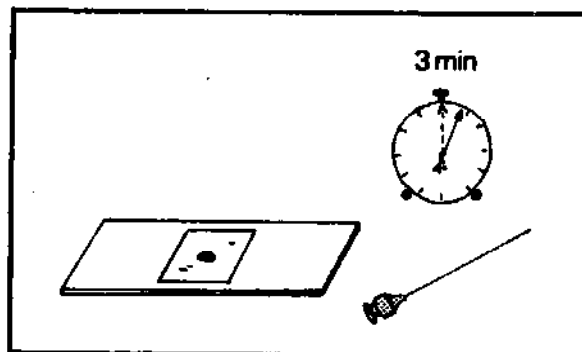

MICROSCOPIC EXAMINATION

Use the x 10 objective with reduced condenser aperture. Examine the edges of the piece of skin. The microfilariae are seen struggling out towards the water. They are highly motile.

Length 200-300 μm
Breadth 8 μm (1 red blood cell)
Curvature of the body rather angular
Front end slightly broader
Tail curved and tapered.

When the specimen contains very few microfilariae, wait 10 minutes.

If no microfilariae emerge, look inside the piece of skin; by looking through it a microfilaria may be seen moving.

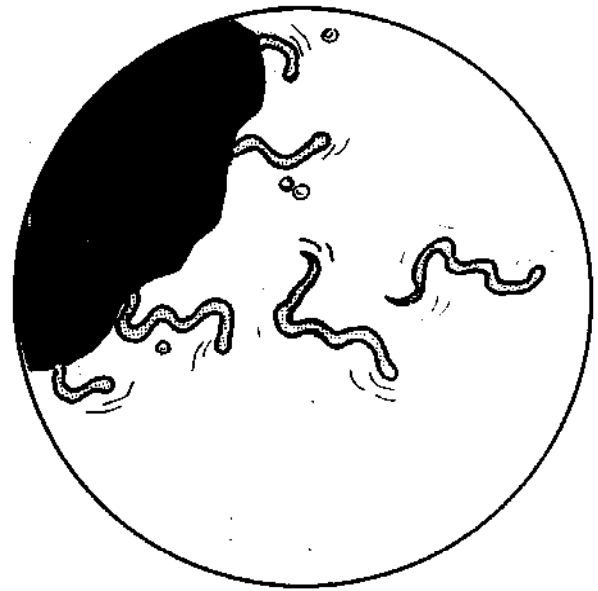

PROCEDURE FOR OBTAINING A STAINED SPECIMEN

A smear is made on a slide by crushing the skin specimen. It is fixed using methanol and stained with Giemsa stain (see page 193).

The microfilaria of *Onchocerca volvulus* shows the following features:

- it has no sheath
- its front end is broad
- the body shows rigid curves
- the tail tapers gradually and ends in a sharp curve
- it contains large oval nuclei, elongated and stained blue-black; they are well separated and do not extend to the tip of the tail.

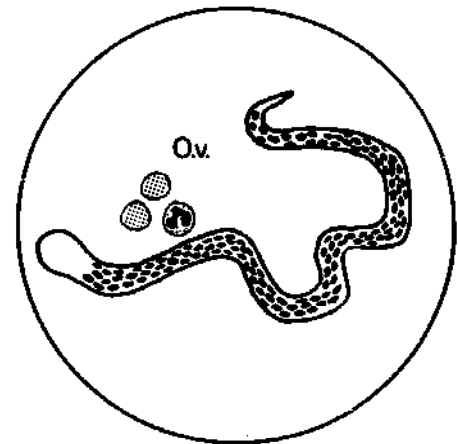

ANOTHER MICROFILARIA FOUND IN SKIN BIOPSIES

Dipetalonema streptocerca

This quite rare worm may not be pathogenic. Its microfilaria is found in the skin and shows the following features:

- it is less broad (5 μm : $\frac{1}{2}$ red blood cell)
- it is slightly shorter (200 μm)
- the front end is not broadened
- the tail ends in a rounded crook
- the nuclei are smaller and reach the tip of the tail.

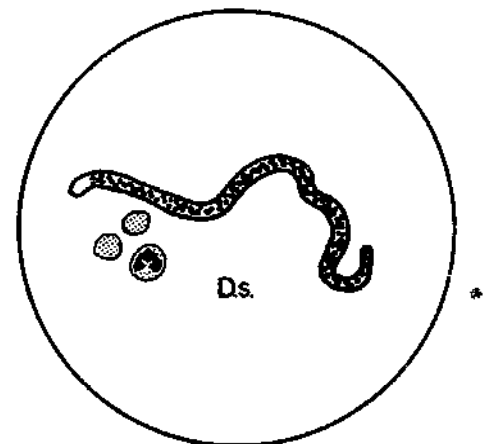

IN CASE OF DOUBT

1. Examine a fresh blood specimen taken from the finger between a slide and coverslip to look for blood microfilariae (see page 205).
2. If the examination is positive, make a stained skin smear and a stained thick blood film (see page 193) to identify the species.

COLLECTION OF SPECIMENS IN THE FIELD

If no microscope is available, or during mass epidemiological surveys:

1. Place the piece of skin in a small penicillin bottle containing 2 ml of sodium chloride solution.
2. Wait 15 minutes for the microfilariae to leave the skin.

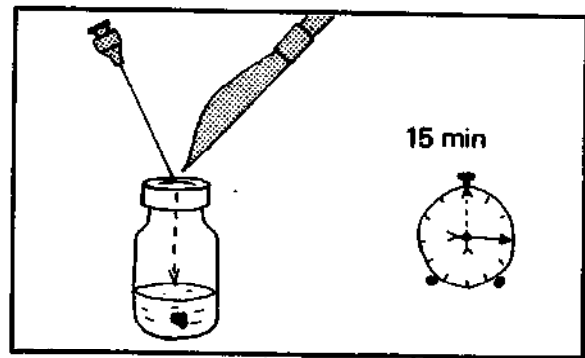

3. When the 15 minutes are up, fix by adding 2 ml of 10% formaldehyde solution (reagent No. 26). Mix and replace the cap on the bottle. Preservation time: several months.

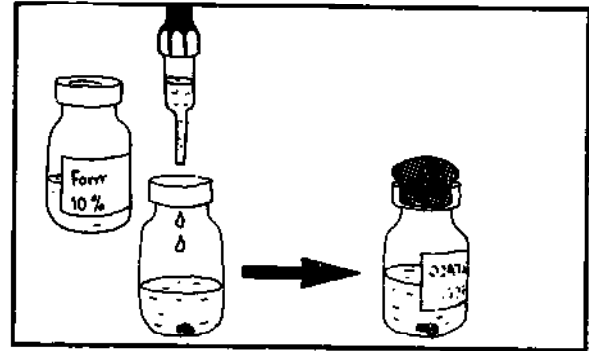

4. When you return to the laboratory, shake the bottle well.

Centrifuge the liquid (after removing the piece of skin) at medium speed (or use a hand-powered centrifuge).

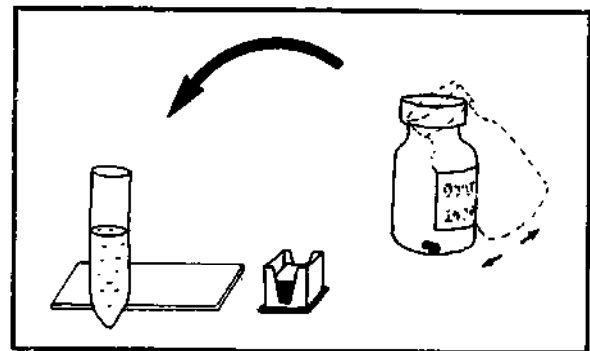

5. Examine the deposit in the centrifuge tube between a slide and a coverslip under the microscope.

The dead microfilariae are clearly visible unstained, with their characteristic angular curves.

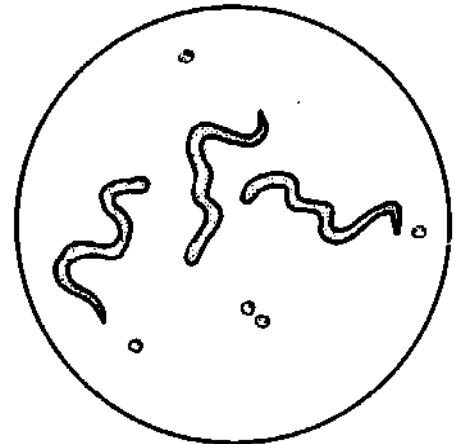

MICROFILARIAE OF THE EYE

Microfilariae sometimes migrate to the eye, where they can be detected by an ophthalmologist using a special instrument.

25. Trypanosomes: Detection in the Blood, Concentration

Principle

Trypanosomes are detected in the blood:

- in wet preparations
- in thick films after staining
- following concentration by repeated centrifuging.

Trypanosomes can be found in the blood of patients:

- with African trypanosomiasis (sleeping sickness)
- with South American trypanosomiasis (Chagas' disease)

Important:

In African trypanosomiasis trypanosomes appear in the blood at intervals for a period of a few days, mainly during the first 3 months of the disease and especially during bouts of fever.

A. DIRECT EXAMINATION

MATERIALS

- Blood lancet
- Ethanol
- Slides
- Coverslips
- Sodium chloride solution (reagent No. 45)
- Giemsa stain
- Buffered or neutral water
- Filter paper.

METHOD

1. After sterilizing the pad of the 3rd finger, prick with the blood lancet. Wipe away the 1st drop of blood with filter paper. Collect 2 drops of blood:
 - 1 drop on one slide
 - 1 drop on a second slide.

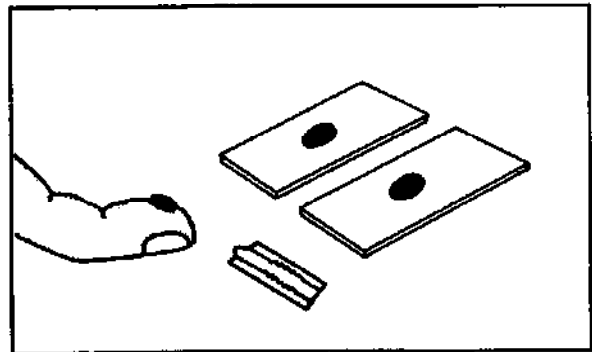

2. Collect 2 drops of blood on a strip of filter paper. Leave to dry.

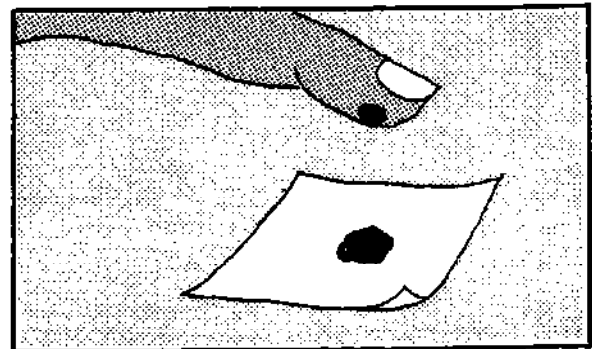

3. On the 1st slide, place:
 - 1 drop of sodium chloride solution beside the drop of bloodMix, using the corner of a coverslip. Cover with the coverslip.

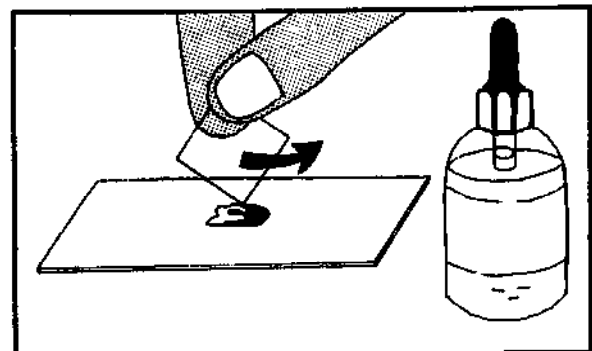

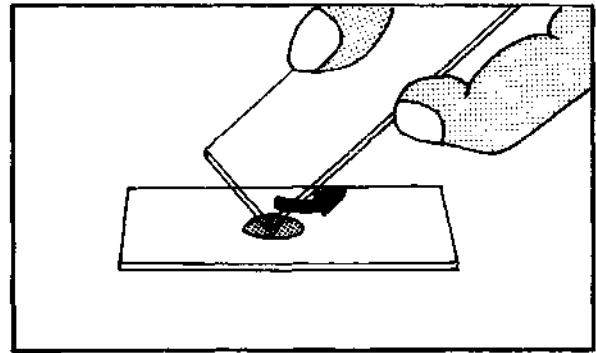

4. On the other slide:
- spread the blood to make a thick film (see technique, page 189).

5. Examine the 1st slide with the wet preparation under the microscope, using the x 40 objective and reducing the condenser aperture.

Examine the edges of the smear first.

Look for movement among the red cells; the trypanosome displaces them with its flagellum as it moves forward.

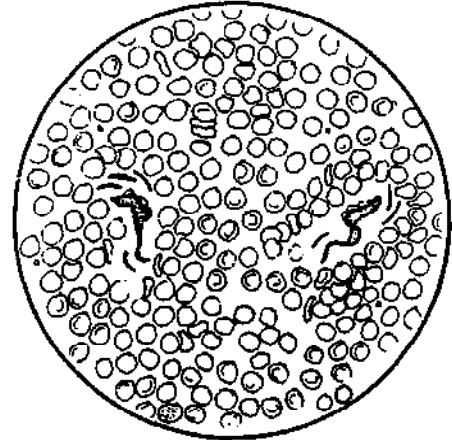

Make sure that it is a trypanosome:

Length 15–25 μm (2–3 red cells)

Breadth 3 μm ($\frac{1}{2}$ red cell)

Shape like an elongated fish

Motility moves rapidly, advancing and contracting like a snake, and has an *undulating membrane* extending from a motile flagellum at the anterior end.

Do not confuse with a microfilaria, which is much bigger (100–300 μm , as long as 10–40 red cells).

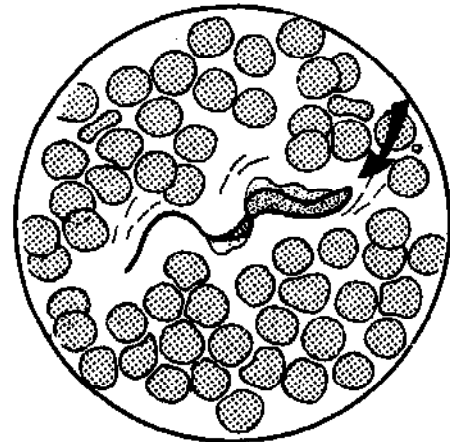

6. Examination of thick films

Thick films must always be examined, even if the examination of the wet preparation seems positive, to make sure that the motile organism seen is in fact a trypanosome. Stain with Geimsa stain (see page 193), or with Field stain (see page 191).

Description of stained trypanosome (*T. gambiense* or *T. rhodesiense*)*

Length	15-25 μm (1-2 leukocytes)
Cytoplasm	pale blue
Nucleus	large central nucleus, stained reddish-purple
Granules	1 compact red body at the posterior end: the kinetoplast (K)
Undulating membrane (M)	reddish-pink, starting at the kinetoplast
Flagellum (F)	pink, extending 5 μm beyond the undulating membrane.

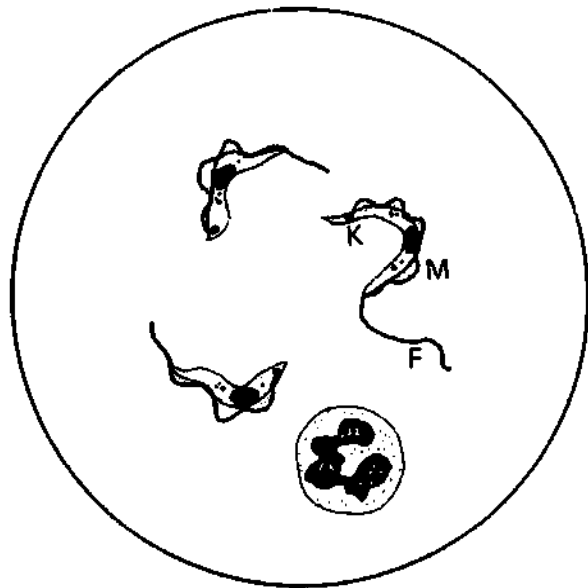

* *T. gambiense* (West and Central Africa) and *T. rhodesiense* (East Africa) are identical in appearance.

7. If the examination is negative:

- repeat the tests for up to 7 days.

Send the *dried drop of blood* on the strip of filter paper to an immunological reference laboratory for testing for immunoglobulin M (IgM) and FAT antibodies.

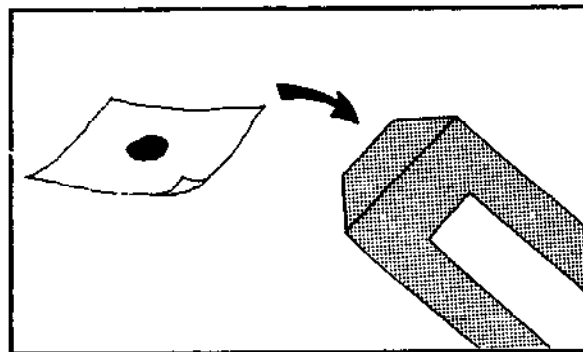

B. CONCENTRATION METHOD USING VENOUS BLOOD

Examination after centrifuging 3 times

Materials

- Electric centrifuge
- Conical centrifuge tubes
- Pasteur pipette
- 3.8% trisodium citrate solution (reagent No. 54).

1. Take a conical centrifuge tube with a 10 ml mark. Measure into it:
 - 1 ml of citrate solution.

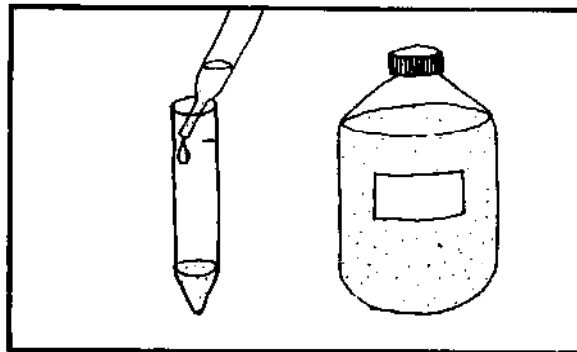

2. Collect:
 - 9 ml of venous blood,and add it to the citrate (i.e., up to the 10 ml mark).

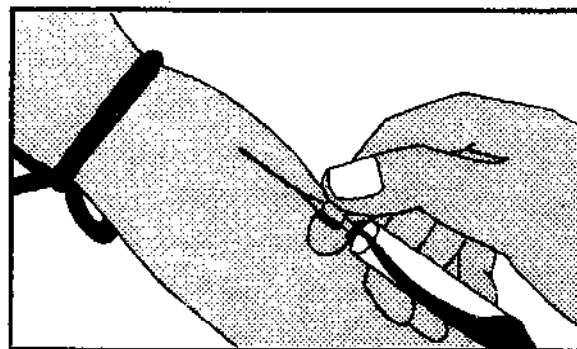

3. Mix and immediately centrifuge at medium speed for 3 minutes.

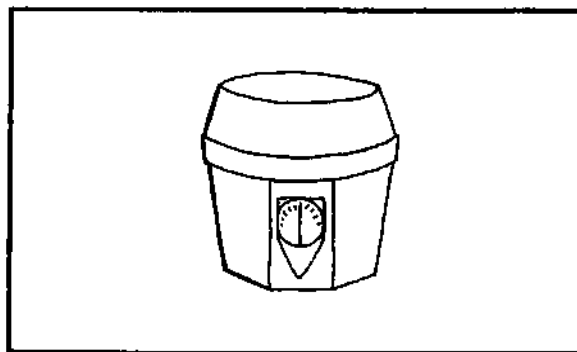

4. Draw off all the supernatant plasma and the layer of leukocytes above the red cell deposit.
Expel this supernatant liquid into another tube (tube 2). Centrifuge at medium speed for 5 minutes.

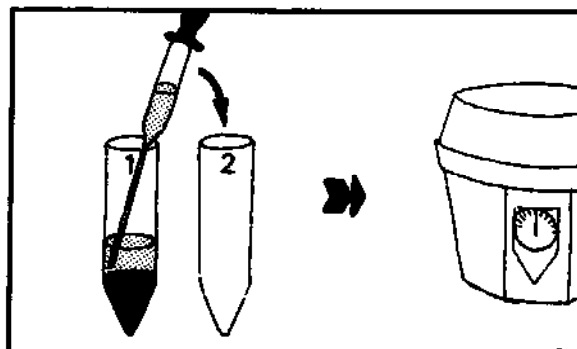

5. Draw off all the supernatant fluid (but keep the deposit of tube 2).

Expel the supernatant fluid into a third tube (tube 3).

Centrifuge at high speed for 10 minutes.

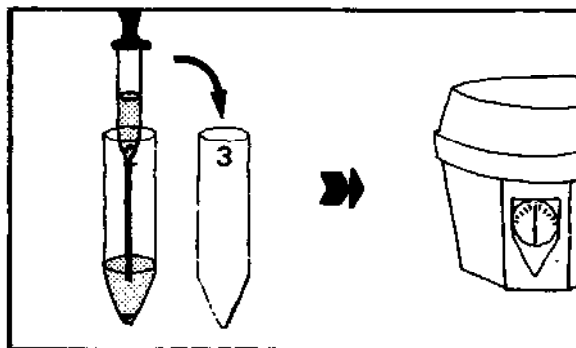

6. Examine the deposits of tubes 2 and 3 between a slide and coverslip under the microscope.

The trypanosomes will appear in the deposit from tube 3 (and occasionally in that of tube 2).

Microfilariae will be found in the deposit from tube 2.

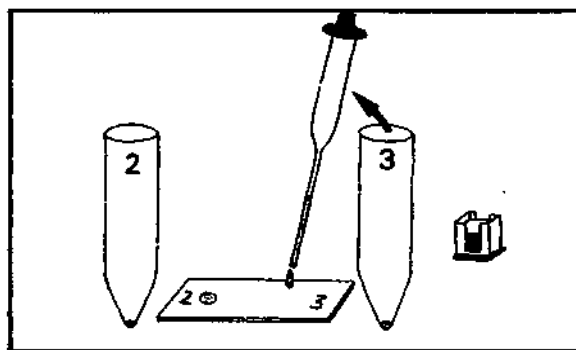

Microhaematocrit centrifuge method

If a microhaematocrit centrifuge is available, anticoagulated venous or capillary blood can be collected into a microhaematocrit capillary tube. The method of collection and examination is as for microfilariae given on page 208. Motile trypanosomes, if present, can be found in the plasma just above the layer of leukocytes. Movement can first be detected using the x 10 objective with reduced condenser aperture, and the trypanosomes can be seen more clearly using the x 40 objective.

Other examinations for trypanosomiasis

African trypanosomiasis is also diagnosed in the laboratory by:

- examination for trypanosomes in lymph node fluid (see page 226)
- testing dried blood collected on filter paper for IgM and antibodies (see method of collection, page 287)
- immediate inoculation of the patient's heparinized blood into rats or mice (in specialized laboratories)
- examination for trypanosomes in the CSF (see page 347).

C. SOUTH AMERICAN TRYPANOSOMIASIS: CHAGAS' DISEASE

Chagas' disease, which occurs in Middle and South America, is caused by *Trypanosoma cruzi* and is transmitted by bugs. Another trypanosome, *T. rangeli*, can be found infecting man in almost the same areas. Although it is not pathogenic, it must be identified and distinguished from *T. cruzi* for the diagnosis of Chagas' disease.

Important:

Motile trypanosomes are found in the blood during the acute phase of the disease, and rarely thereafter. During the chronic stage the diagnosis is based essentially on immunological methods.

Examination techniques

The trypanosomes that cause Chagas' disease are difficult to find in the blood. The same techniques are used as for African trypanosomiasis.

1. Examination of wet preparations (rarely positive during the chronic stage of the disease).
 2. Examination of thick films repeated several days in succession.
 3. Triple centrifuging and microhaematocrit centrifuge technique if possible.
 4. Detection of antibodies (complement fixation test).
-

Appearance of *Trypanosoma cruzi*

Description of stained *T. cruzi*:

Shape	Broad forms "C"-shaped; also slender forms, generally "S"-shaped
Length	about 15 μm in broad forms and 20 μm in slender forms
Cytoplasm	pale blue
Nucleus	large, central and red
Kinetoplast	large and round granule, dark red or purple, near the posterior extremity
Undulating membrane	narrow, reddish-pink
Flagellum	pink, extending beyond the undulating membrane

Appearance of *Trypanosoma rangeli*

Description of stained *T. rangeli*

Shape	Only slender forms, with tapering extremities
Length	25-35 μm
Nucleus	red, near the central part of the cell body
Kinetoplast	small, like a dark red dot, far away from the posterior extremity
Undulating membrane	visible, narrow
Flagellum	extending beyond the undulating membrane.

26. Trypanosomes: Examination of Lymph Node Fluid

African human trypanosomiasis

In cases of African human trypanosomiasis (also called "sleeping sickness"), trypanosomes are found in the lymph glands (in *T. gambiense* infections) in the early stages, i.e., 2-3 weeks after injection of the parasites by the tsetse fly (*Glossina*). They disappear from the glands within 2-6 months.

Principle of examination

A drop of fluid from the lymph node is collected with a needle. It is examined at once as a wet preparation between a slide and coverslip. The trypanosomes, which are motile flagellate protozoa, are easily seen under the microscope.

MATERIALS

- Needle (for subcutaneous injection), 25-gauge (0.5 mm) x 16 mm
- 5 or 10 ml syringe (both syringe and needle must be perfectly dry)
- Slides
- Coverslips
- Tincture of iodine
- Sodium chloride solution (reagent No. 45).

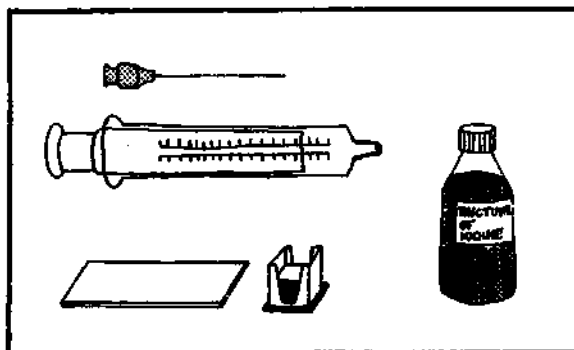

FINDING A LYMPH GLAND

Lymph nodes are found among the cervical glands of the neck. Feel both right and left sides of the neck, from the base of the neck up to the ear.

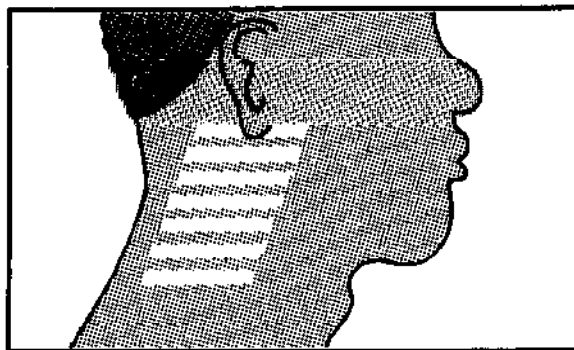

Affected glands are swollen and form a round lump 2-4 cm across. They are elastic and slide under the skin, offering little resistance to pressure. They do not become hard (except in chronic cases).

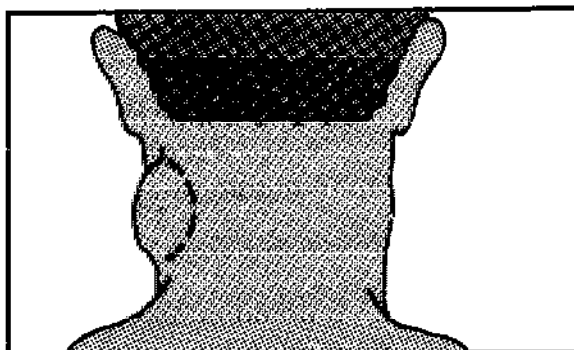

COLLECTION OF SPECIMEN

Preparations

Prepare the syringe, pulling the piston as far back as possible.

Prepare 3 slides, putting a drop of sodium chloride solution on each.

Wash your hands with soap.

Have the patient sit down.

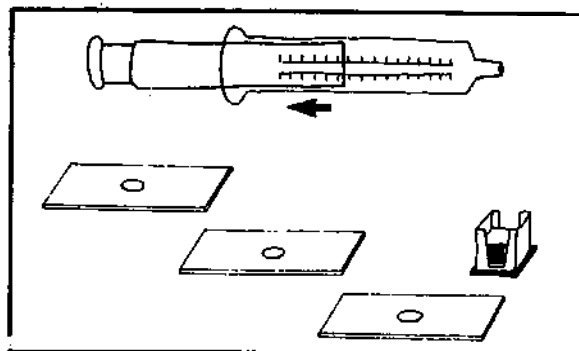

1. Disinfect the chosen site on the neck with tincture of iodine.*

Take the gland between the thumb and index finger of the left hand.

Hold it steady, at the same time making it stand out.

*Iodine must be washed off with ethanol to prevent burns. Disinfectants such as thiomersal can be used.

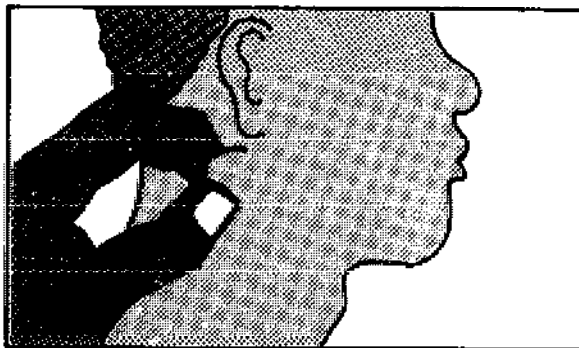

2. Introduce the needle at right angles into the centre of the gland, in two stages:

- first pierce the skin
- then penetrate the gland.

(Make sure that you avoid the jugular veins and arteries.)

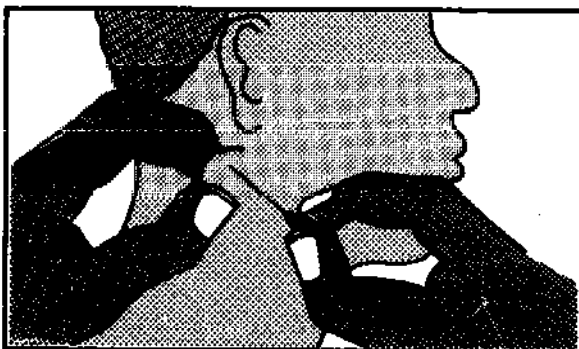

3. *With your left hand:*

- gently knead the gland.

With your right hand:

- revolve the needle in both directions.

The glandular fluid will ooze into the needle. The operation should last about 1½ minutes.

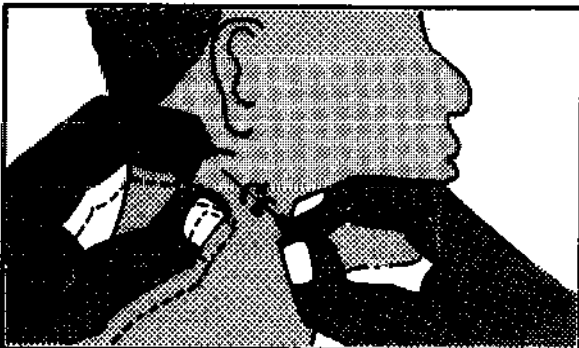

4. Withdraw the needle in one rapid movement, holding your thumb over the hub. Then apply a swab dipped in tincture of iodine to the point of entry.

(Never apply the iodine swab before withdrawing the needle, for some disinfectant might get on to the tip of the needle, make its way into the fluid from the gland and make the trypanosomes non-motile).

If the gland is hardened, draw up the glandular fluid directly into a syringe.

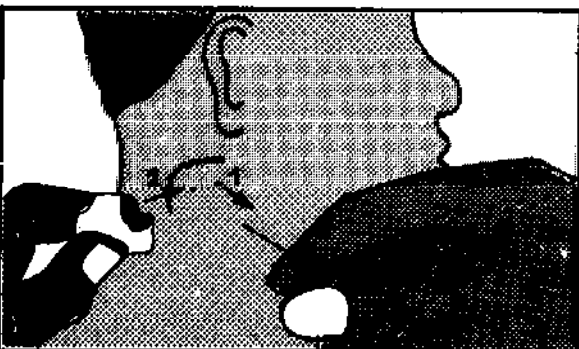

Preparation of slides

1. Attach the syringe (piston pulled back) to the needle.

Place the point of the needle in the drop of sodium chloride solution on the first slide. Push the piston gently half way down the barrel to discharge the glandular fluid contained in the needle on to the slide.

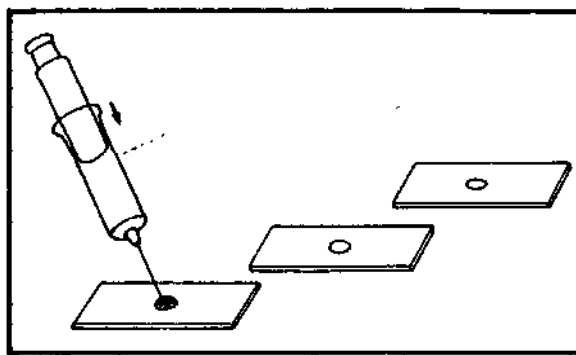

2. Repeat the procedure with the second slide, pushing the piston to the end of the barrel to discharge the rest of the fluid.

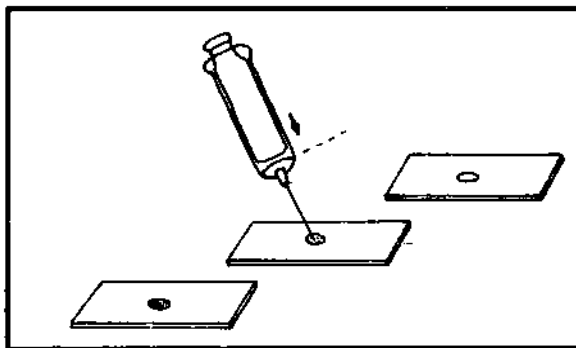

3. For the third slide draw the drop of sodium chloride solution up into the needle. Force it out and aspirate it several times to rinse the needle thoroughly and collect the last traces of glandular fluid.

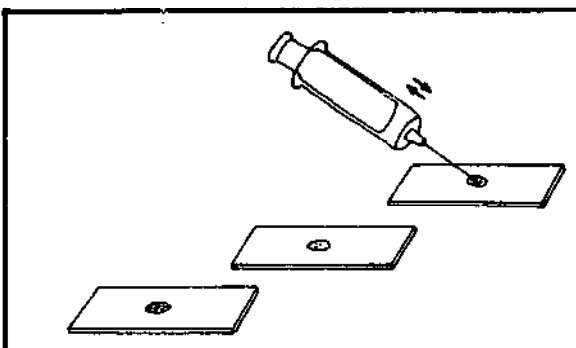

Cover each of the 3 preparations with a coverslip. Examine at once under the microscope (x 40 objective).

Wait until the convection currents stop.

Begin by examining the *periphery* of the preparation, near the edges of the coverslip, towards which the trypanosomes tend to make their way.

Then examine the rest of the preparation, repeating the procedure with the other two slides.

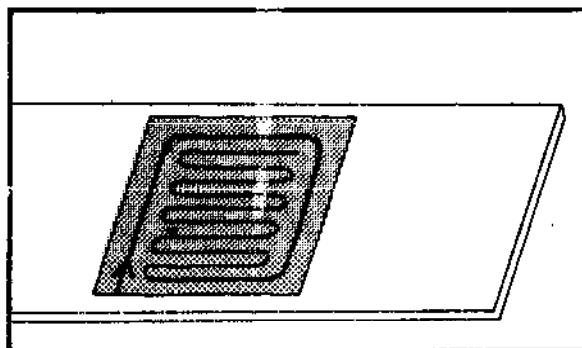

The preparation will contain red blood cells, leukocytes and lymph cells. If any movement is detected between the different cells, look very carefully to see if it is caused by a trypanosome. The organism is about $20\ \mu\text{m}$ long and is often hidden by the cellular elements, which are disturbed by its flagellum as it moves.

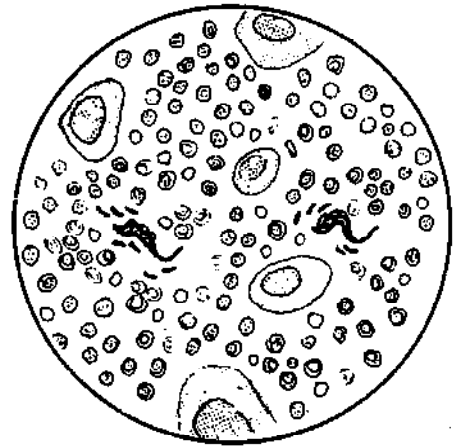

The trypanosome

Size 15-25 μm (2-3 times as long as a red blood cell)
Shape like a long undulating fish
Appearance (in wet preparations) clear, very refractile.

Flagellum and undulating membrane

In wet preparations, it is chiefly the movements of the flagellum located at the front of the trypanosome that can be seen. The trypanosome weaves among the cellular elements, following a zigzag course.

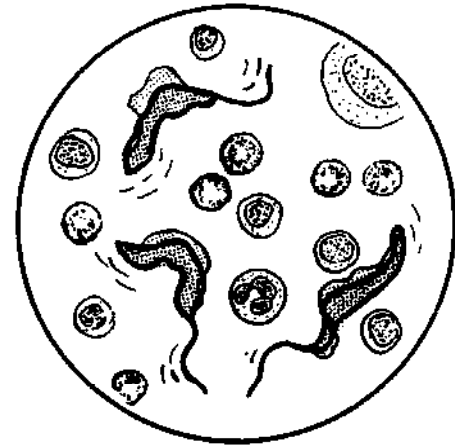

STAINED SMEARS OF GLANDULAR FLUID

If the specimen is collected in the field and no microscope is available, make a large thin smear using the corner of a slide.

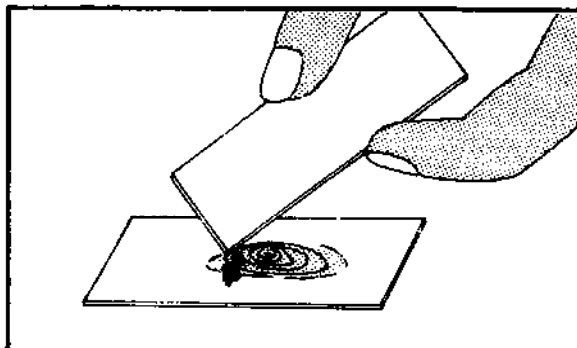

Leave to dry. Fix with methanol. On return to the laboratory, stain the smears with Giemsa stain (see page 193). A description of trypanosomes in stained preparations is given on page 222.

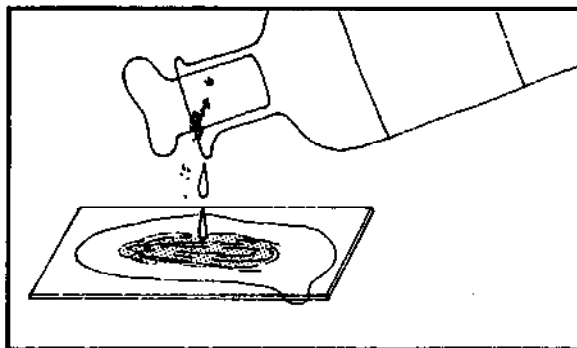

MICROFILARIAE IN GLANDULAR FLUID

These cannot be confused with trypanosomes as they are much larger (100-300 μm). They may be microfilariae of the blood (see page 204) or they may be skin microfilariae (see page 215) picked up by the needle.

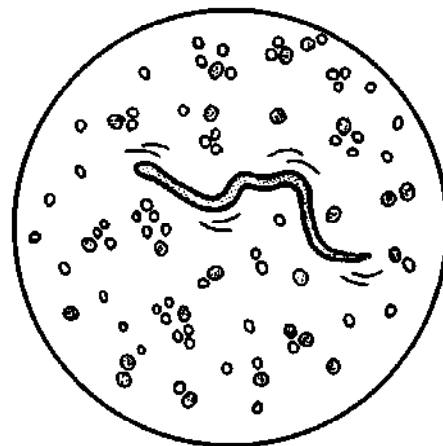

B. BACTERIOLOGY

Introduction

Direct examination of bacterial smears is generally not sufficient to identify a bacterial species; precise identification can only be obtained by culture. This shows the importance of collecting and dispatching specimens to referral laboratories. Nevertheless, direct microscopical examination of stained smears is an efficient way of studying the presence of bacteria in biological fluids that are normally sterile, such as cerebrospinal fluid (CSF) and pleural fluid, and in specimens from other sources. It may provide information of great value for the diagnosis, immediate treatment and control of the disease. For example:

- in specimens from cases of male urethritis at an early stage gonococcal infection can be diagnosed with reasonable certainty (in females it is much more difficult)
- direct microscopy is believed to be the most practical and effective technique for the detection of infectious cases of tuberculosis, and it is therefore of high epidemiological importance
- microscopical examination of stained smears and of spinal fluid and study of the morphology of any bacteria present may assist in identifying meningitis (meningococcal, pneumococcal or *M. tuberculosis* meningitis).

The diagnosis of some diseases is also possible through serology; an example is syphilis. Serological techniques are also important for seroepidemiological surveillance.

27. Preparation of Smears. Fixation

Principle

The sample to be examined (pus, sputum, urine centrifugate, cerebrospinal fluid, etc.) is treated as follows:

- it is spread in a thin layer on a glass slide
- it is dried completely
- it is fixed on the slide by heating before being stained.

MATERIALS

Inoculating loop: this is a metal wire (usually made of nickel-chromium alloy) fixed on to a handle and bent into a loop at the other end.

Make the loop with forceps, taking care that it is centred.

The actual size of the loop should be as follows:  2 mm

Glass slides: clean with an ethanol-ether mixture and wipe with gauze.

Bunsen burner.

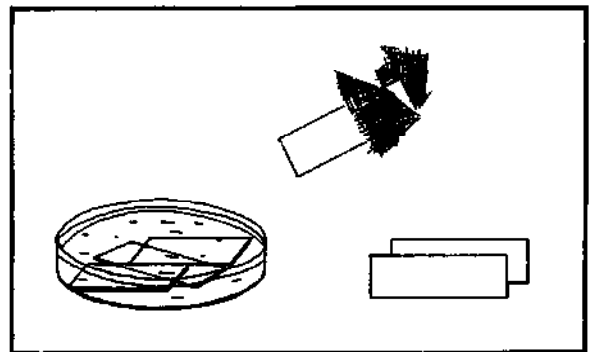
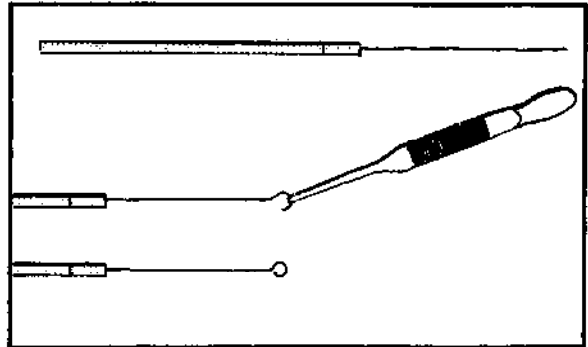

PREPARATION OF SMEAR

1. Flame the loop until it is red-hot:

- hold the loop just above the blue part of the flame
- hold the instrument as nearly vertical as possible.

Allow to cool (count to 20).

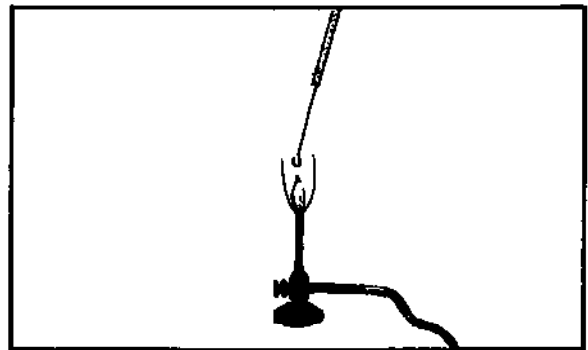

2. Take a portion of the specimen to be examined for pus, by placing the loop flat on the surface of the liquid.

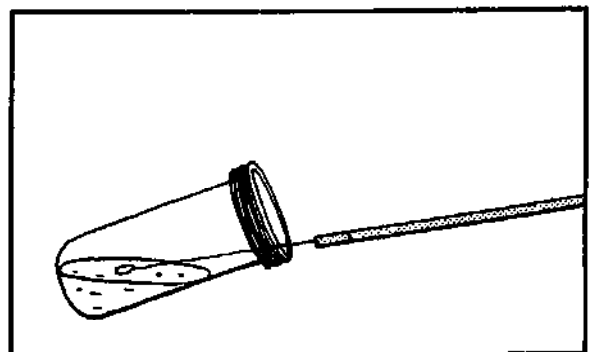

3. Place the loop on the slide and press slightly flat and in the centre (the slide should be numbered).

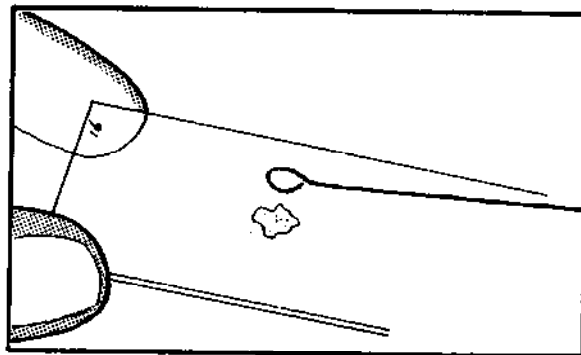

4. Still holding it flat against the slide, move the loop in an oval spiral, outwards from the centre.

Leave a space between the specimen and each of the 4 sides of the slide.

Let the slide dry completely in the air.

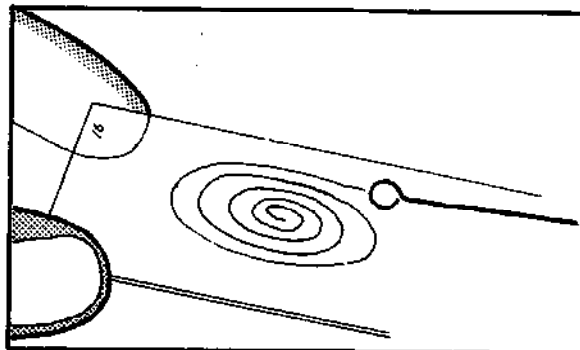

5. Flame the loop again until it is red-hot to destroy any bacteria.

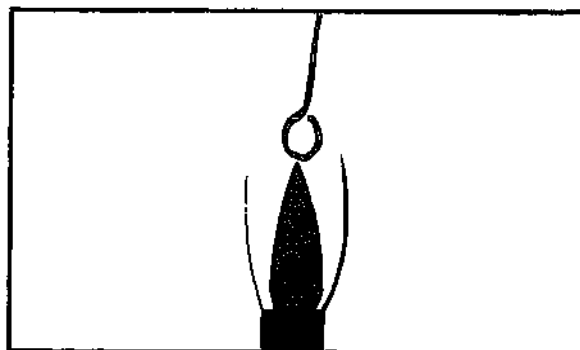

Unmarked smears are sometimes received in the laboratory from outside sources.

To find out on which side of an unmarked slide the smear has been made:

- turn the slide so that it reflects the light from the window
- the side without the smear will shine
- the side with the smear will not reflect the light.

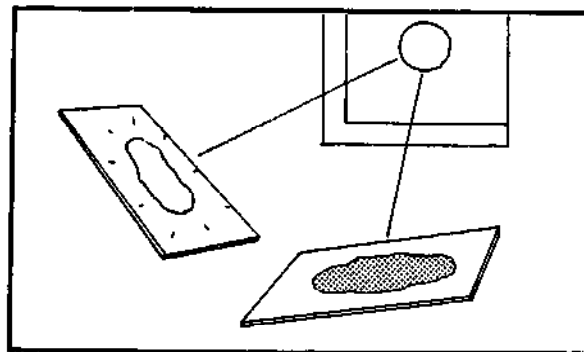

FIXATION

Check that the smear is completely air-dried.

Pass the slide through the flame of a Bunsen burner, with the smear uppermost. Pass it through the flame three times.

Allow to cool before staining.

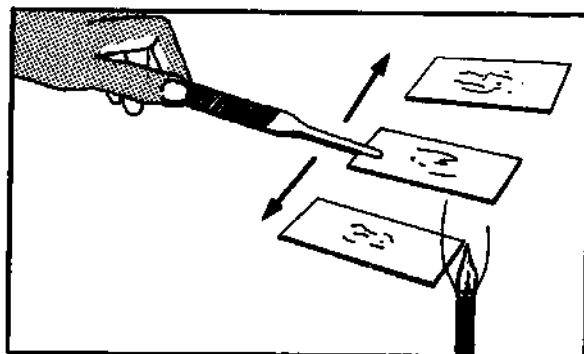

It is sometimes useful to draw a circle around the smear with a grease pencil, so that it can be seen more easily.

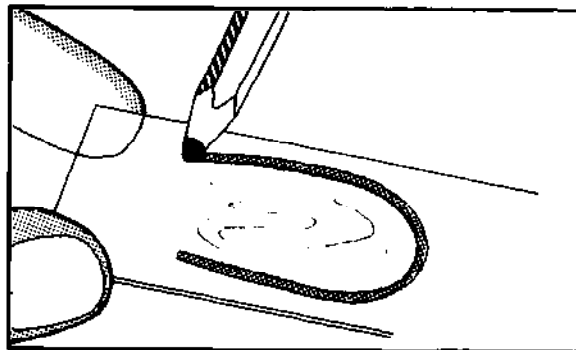

Staining of fixed smears

Gram stain, see page 235.

Ziehl-Neelsen, see page 249.

Reading of stained direct smears, see page 238.

28. Gram Staining

Advantages

Gram staining makes it possible to classify bacteria into two groups:

- *Gram positive* stained dark purple
- *Gram negative* stained pink.

This makes identification easier.

GRAM STAINING REAGENTS

Modified Hucker crystal violet (reagent No. 15)

Gram iodine solution (reagent No. 31)

95% ethanol

Safranine solution (reagent No. 42)

Tap water.

TECHNIQUE

Fix the smear and allow to cool.

1. *Crystal violet* – 1 minute

Pour the crystal violet on to the slide.

Cover the slide completely.

Leave for 1 minute.

Rinse with tap water and drain.

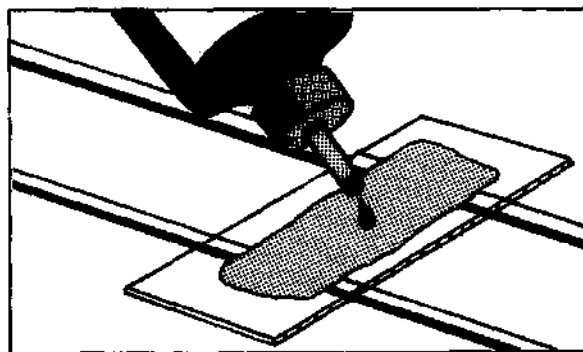

2. *Gram iodine solution* – 1 minute

Flood the slide with Gram iodine solution and let it stand for 1 minute.

Drain off the solution and rinse with tap water.

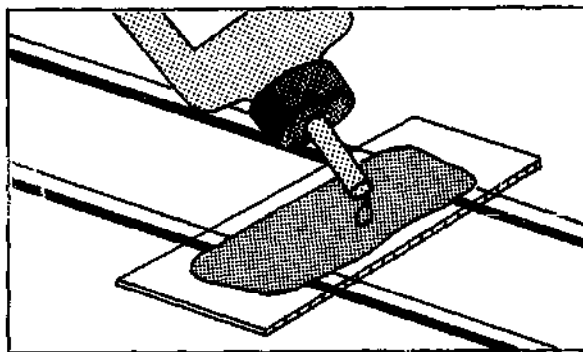

3. *95% ethanol* – 1 minute

Cover the slide completely.

Leave for 1 minute.

Flood with water and drain.

Look at the smear:

- if violet patches remain, treat again with ethanol for 15 to 30 seconds.

Rinse well with water and drain.

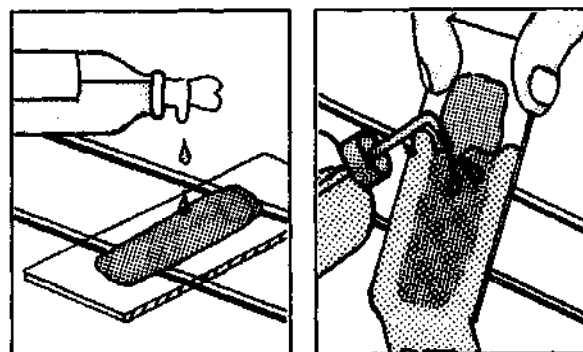

4. *Safranine solution* – 10 seconds

Leave on the slide for 10 seconds.

Wash briefly with tap water at once.

Drain and allow to dry in the air.

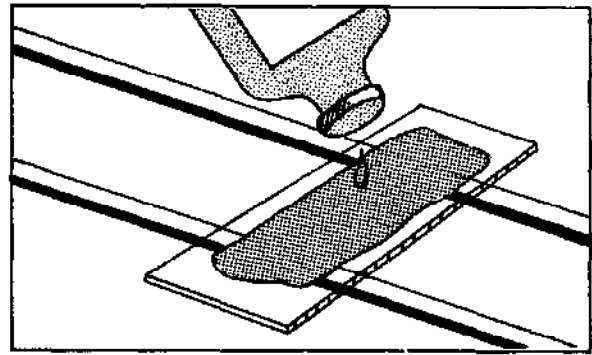

WHAT TO LOOK FOR

Bacteria – stained deep violet: Gram positive, e.g. staphylococci, streptococci, micrococci, pneumococci, enterococci, diphtheria bacilli, anthrax bacilli.

Bacteria – stained pink: Gram negative, e.g. gonococci, meningococci, coliform bacilli, shigellae, salmonellae, cholera vibrios.

See page 238 for direct examination for bacteria.

PRINCIPLE OF THE STAINING REACTION

1. The violet colour stains all bacteria deep violet.

Gram negative bacteria Gram positive bacteria



2. Iodine solution fixes the violet colour more or less strongly in the bacteria.

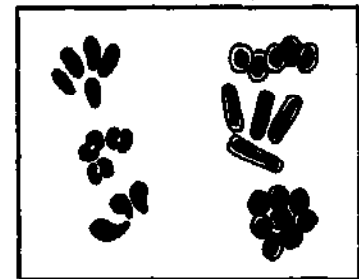

3. 95% ethanol:

- Decolorizes certain bacteria when the violet stain is not strongly fixed by iodine solution
- Does not decolorize other bacteria when the violet stain is strongly fixed by iodine solution.

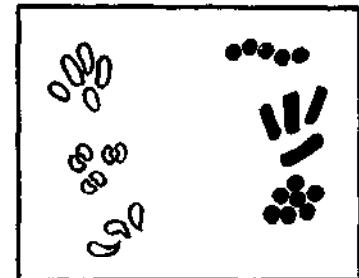

4. Safranine solution (pink):

- Re-stains (pink) the bacteria discoloured by ethanol
- Has no effect on the other bacteria, which remain dark violet.



SOURCES OF ERROR

A false Gram positive reaction may occur because:

- the smear was fixed before it was dry
- the smear was too thick
- there was sediment in the bottle of crystal violet (filter before using)
- the Gram iodine solution was not thoroughly drained off
- the ethanol was not left long enough
- the safranin solution was too strong or left on the slide too long.

A false Gram negative reaction may occur because:

- the Gram iodine solution was not left long enough
 - the ethanol was left on too long and not washed off properly.
-

29. Microorganisms Found by Direct Film Examination

Germs are very small microorganisms (0.5–5 μm ; 10 μm at the most). Most of those you will look for either microscopically or in culture are bacteria and that is why the examination is called a "bacteriological examination". Other types of germ (rickettsiae, viruses, etc.) are looked for in specialized laboratories.

A distinction is made between the following:

*Pathogenic bacteria**

These can cause disease. They are found in the body they are infecting and detected by laboratory examination.

Non-pathogenic bacteria

These are harmless and exist in countless numbers in nature. Some multiply normally in man without affecting his health and are known as "saprophytes".

HOW BACTERIA ARE DETECTED IN THE LABORATORY

1. *By direct microscopical examination* of smears (of specimens of pus, urine, sputum, skin, CSF, nose or throat) made on slides and stained (by Gram or Ziehl-Neelsen stains).

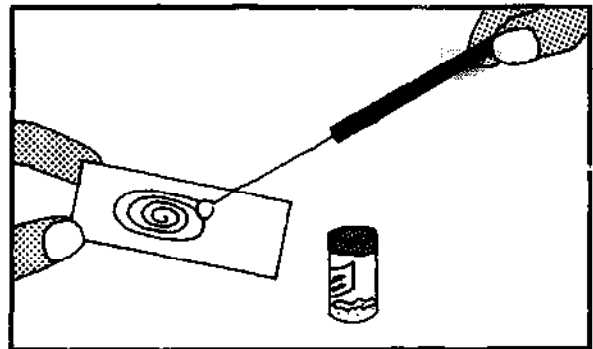

2. *By bacterial culture:*

- on solid culture media (agar in a Petri dish or test-tube)
- in liquid media (tubes of broth).

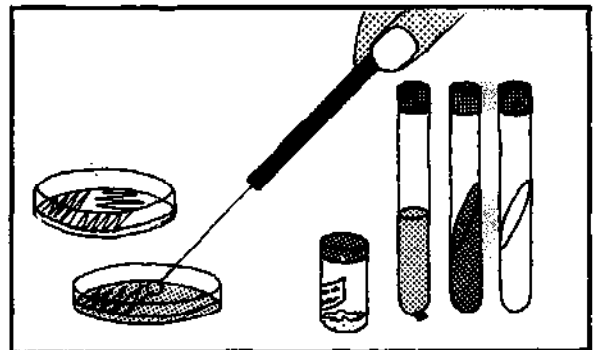

Cultures are *essential* to determine the exact identity of bacteria and, more particularly, to determine whether the organisms found in the specimen are pathogenic or non-pathogenic. Biochemical, serological (agglutination) and other tests are used to identify the organisms cultured.

Never fail to send specimens to a more specialized laboratory for culture whenever necessary (for dispatch of specimens see pages 268 and 273).

**Note: Obligatory and facultative pathogens.* Obligatory pathogens are those that always cause disease (e.g. tubercle bacilli). Facultative pathogens are harmless in certain areas of the body (e.g. coliform bacilli, a normal saprophyte of the intestine) but can cause disease when they invade other areas (the coliform bacillus may infect the urinary tract).

Value of direct examination

Direct examinations are most useful in obtaining an indication of the type of organism involved or, in some cases, in establishing a diagnosis of the disease (tuberculosis, leprosy, gonorrhoea, etc.).

For this purpose, it is essential to give a detailed description of the organisms seen as well as of any other elements present (leukocytes, red blood cells, epithelial cells, etc.) (see page 242).

**VARIOUS GROUPS OF BACTERIA SEEN UNDER THE MICROSCOPE
(DIRECT EXAMINATION BY GRAM STAIN)**

1. Gram positive cocci – rounded shape

May be arranged:

- in clusters (staphylococci)
- in chains (streptococci)
- in pairs
- in fours, etc.

Found in pus, urine, blood and other specimens.

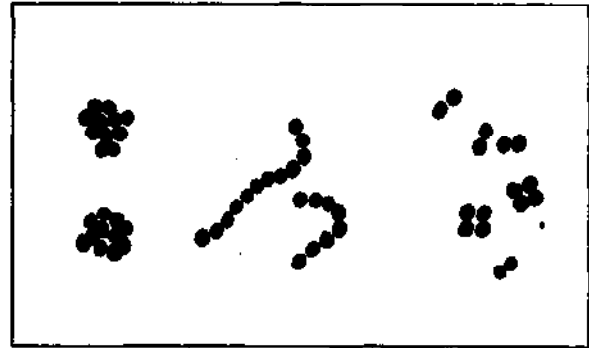

2. Gram negative diplococci – rounded shape in pairs

May:

- be shaped like coffee beans
- cluster in the cytoplasm of the leukocyte.

Found in urethral pus (gonococci) and the CSF (meningococci).

There are other Gram negative diplococci that are generally non-pathogenic. They may be seen in throat swabs or sputum specimens.

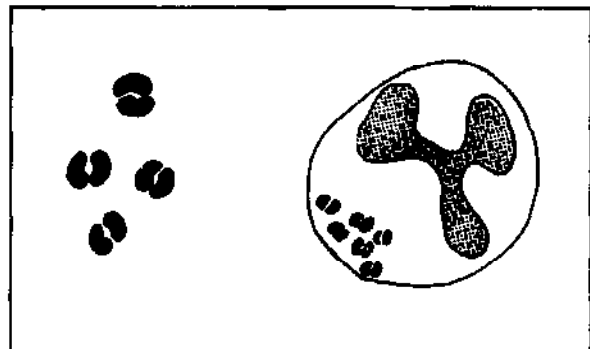

3. Gram positive bacilli – rod-shaped

(a) Gram positive bacilli – with spores

Long and thick and may have square ends (anthrax) or rounded ends (tetanus, saprophytes). The spore appears as a large uncoloured area inside the bacillus as it does not stain with Gram stain.

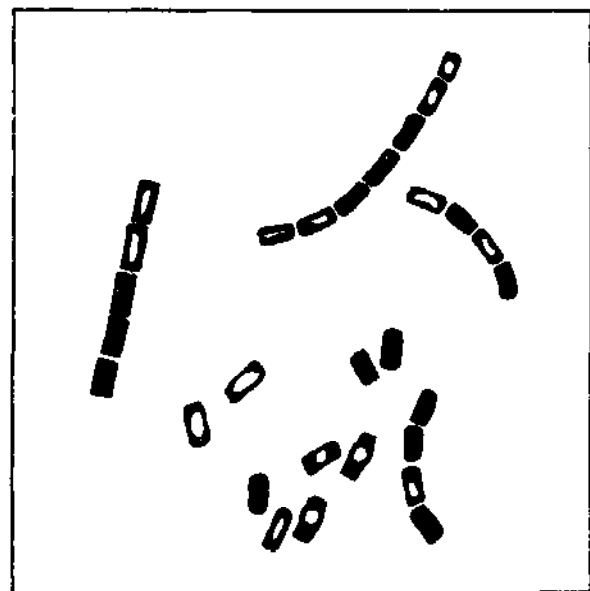

(b) *Gram positive bacilli — without spores*

Usually small and variable in shape; the ends may be swollen and be arranged in rows or like letters. Found in throat specimens, blood, skin, etc. (diphtheria, diphtheroids, *Listeria*).

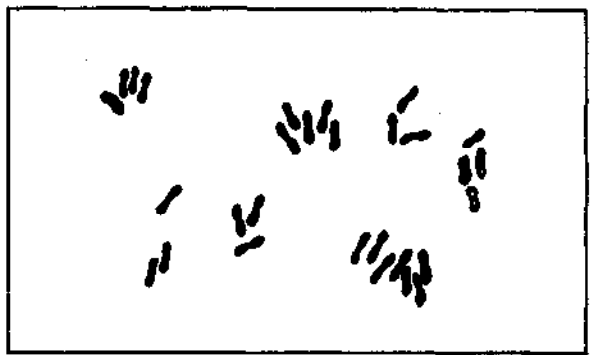

4. *Gram negative bacilli*

Variable in size, ends rounded or pointed. May be large and straight (coliform bacilli), comma-shaped (vibrio) or short and fat (Proteus). This group includes many species.

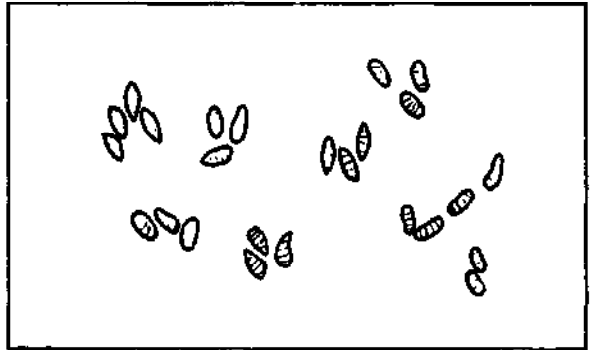

5. *Gram negative coccobacilli*

Quite variable in shape, not as round as cocci but not as long as normal bacilli (plague, *Haemophilus*). Found in a variety of body specimens.

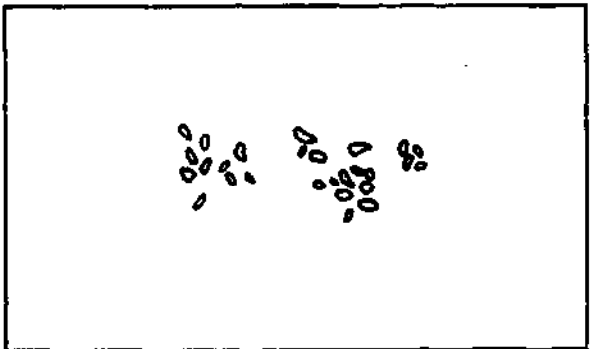

6. *Yeasts and actinomycetes*

(a) *Yeasts*

Vary in size but are larger than bacteria. May be seen in process of budding. Usually present as contaminants but sometimes pathogenic (genital discharge, sputum, etc.).



(b) *Actinomycetes*

Large granules, sometimes visible to the naked eye (white to yellow colour).

The centre is Gram negative, the periphery Gram positive. Found in pus from skin, sputum, etc.

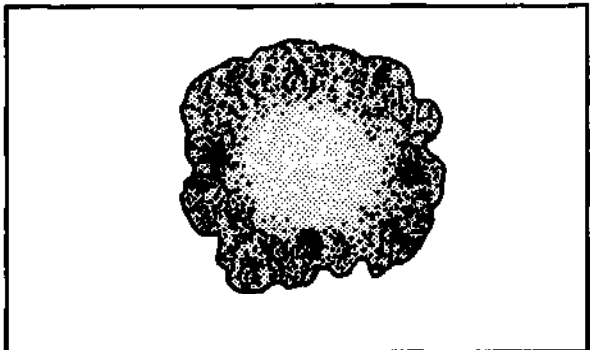

7. Spirochaetes

Treponema and Borrelia

Irregular loose spiral – weakly staining Gram negative.

(a) *Treponema vincentii* (formerly *Borrelia vincenti*)

Found together with cigar-shaped Gram negative rods (fusiform bacilli) in throat and mouth specimens (Vincent's angina) (see page 272).

(b) *Borrelia recurrentis*

Found in blood films stained with Giemsa stain. Agent of relapsing fever.

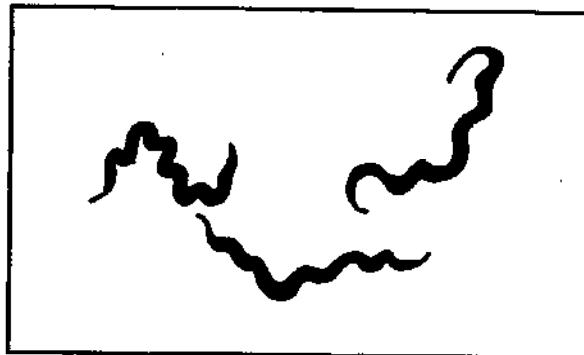

STERILE BODY CAVITIES, FLUIDS, AND TISSUES	NON-STERILE BODY CAVITIES, FLUIDS, AND TISSUES
<p>In healthy persons the following are sterile:</p> <ul style="list-style-type: none"> - blood - cerebrospinal fluid - subcutaneous tissue - internal organs (heart, liver, kidney, etc.) 	<p>In healthy persons the following may contain many non-pathogenic organisms (saprophytes):</p> <ul style="list-style-type: none"> - respiratory tract (mouth, nose, throat, sputum) - gastrointestinal tract - skin, ear, and eye - urogenital tract (vagina, anterior urethra)
<p>In disease all of these areas may be infected by pathogenic organisms</p>	

RECORDING THE RESULTS OF DIRECT BACTERIOLOGICAL EXAMINATIONS

The laboratory report must give a detailed description of all the elements and organisms found and their number.

Elements

Type: leukocytes, red blood cells, epithelial cells.

Organisms

<i>Shape</i>	cocci, bacilli, etc
<i>Arrangement</i>	pairs, chains, clusters
<i>Staining properties</i>	Gram, Ziehl-Neelsen
<i>Special characteristics</i>	spores, granules, etc.
<i>Quantity</i>	occasional, a few, a moderate number, many.

Examples of reports

1. Pus from abscess (direct bacteriological examination) (Gram stain):
 - many leukocytes
 - a few red blood cells
 - a few epithelial cells
 - a moderate number of Gram positive cocci in clusters.
 2. Urine (direct bacteriological examination) (Gram stain):
 - a few leukocytes
 - occasional red blood cells
 - a few epithelial cells
 - a few Gram negative bacilli.
 3. Sputum (direct bacteriological examination) (Ziehl-Neelsen):
 - 5 acid-fast bacilli found/10 fields (2+).
 4. Throat specimens (direct bacteriological examination) (Gram stain):
 - a few leukocytes
 - a few red blood cells
 - a few epithelial cells
 - many Gram positive cocci in chains
 - a few Gram positive rods without spores (diphtheroids)
 - a few Gram negative diplococci
 - occasional Gram negative bacilli.
-

Important:

It is rarely possible to diagnose a disease in the laboratory on the basis of the identification of the organisms found by direct bacteriological examination of a specimen. The results of such an examination, however, can help the physician to establish a diagnosis when taken together with the symptoms shown by the patient.

30. Gonococci: Direct Examination of Urethral Pus. Syphilis

GONORRHOEA

The gonococcus *Neisseria gonorrhoeae* is the cause of gonorrhoea, a very common venereal disease. Its incubation period is 4 to 8 days.

Genitourinary discharge

Thick yellow pus: gonococcus?
Clear whitish fluid: *Trichomonas**
Thick white exudate: fungus?*

Other exudates: non-specific urethritis
(not identifiable by direct examination).

*For *Trichomonas* and fungi, see page 186.

Principle

Smears of urethral pus are stained with Gram stain. Gonococci can be recognized by three characteristics: they are

1. diplococci (in pairs)
2. Gram negative
3. intracellular (inside the leukocytes).

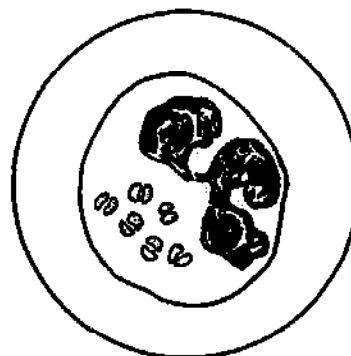

Collection of specimen from male

1. If possible, take the specimen first thing in the morning before the patient has urinated. If necessary clean the meatus with a swab moistened with sterile sodium chloride solution.
2. Exert a slight pressure on the penis so that a drop of pus appears at the meatus.
3. Remove the pus with a sterile inoculating loop or apply directly to a clean slide.
4. If no pus appears, insert the sterile loop approximately 2.5 cm up the urethral canal to obtain a specimen.

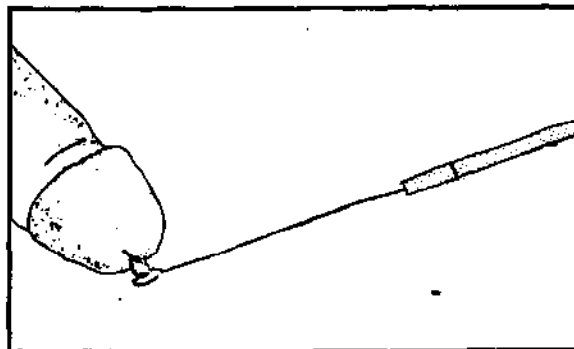

5. Prepare two smears that:

- are as thin as possible
- cover as much of the slide as possible.

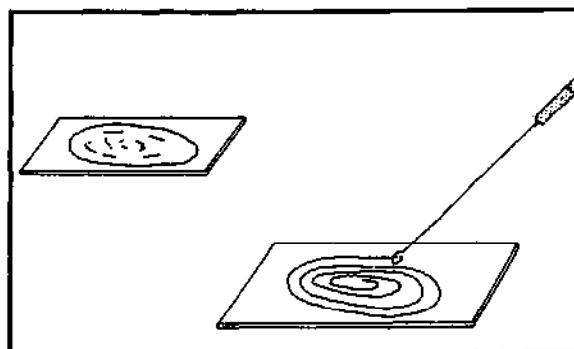

Collection of specimen from female

The specimen should be taken by the physician or specialist nurse from the cervical canal. In cases of chronic gonorrhoea, the specimen should be taken just before or just after the menstrual period.

Direct examination is of great value for the diagnosis of gonorrhoea in males; it is much less so in females. *Culture is therefore necessary* to isolate and identify the gonococci in specimens from females.

Staining the smears

Stain with Gram stain (see page 235).

Treat thoroughly with ethanol after applying Gram iodine solution (reagent No. 31).

Wash with water at once after final staining with safranin solution (reagent No. 42).

Examination of slides

Pay particular attention to the edges of the smear, where the elements are spread more thinly and are easier to see and the stain is less concentrated.

Pus (Note whether there are many masses of degenerate leukocytes. The nuclei are bright pink and the cytoplasm is colourless.)

Gonococci oval, kidney-shaped, Gram negative (pale pink), arranged in pairs

Intracellular massed inside the cytoplasm of the leukocytes (1)

Extracellular clusters seen between the leukocytes or near ruptured leukocytes (2).

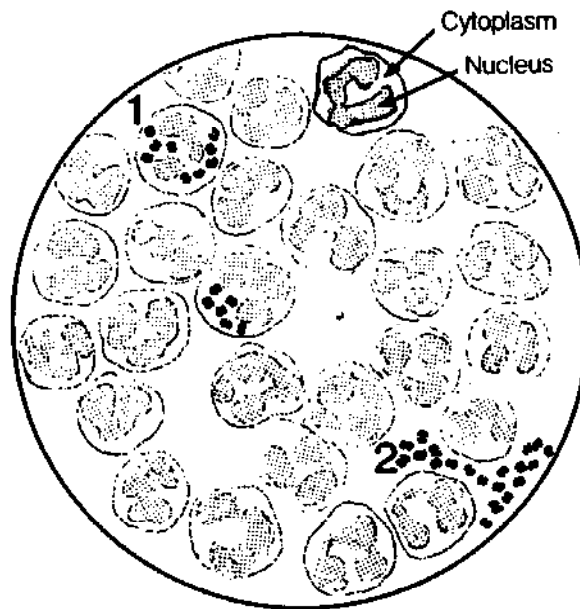

Evaluation of results of direct bacteriological examination of pus from urethra

Many leukocytes.
A few red blood cells.
A few epithelial cells.
A moderate number of Gram negative intracellular diplococci.

OR

Many leukocytes.
A few red blood cells.
A few epithelial cells.
No Gram negative intracellular diplococci.
A few Gram negative extracellular diplococci.

OR

Many leukocytes.
A few red blood cells.
A few epithelial cells.
No Gram negative intracellular diplococci.
No Gram negative extracellular diplococci.

CONCLUSION

Gonococci – positive

Gonococci – suspicion

Gonococci – negative

Other bacteria causing urethral infections

Male

Numbers of the following may occasionally be seen in smears of urethral pus:

- Gram positive cocci (staphylococci)
- Gram positive bacilli (diphtheroids)
- Gram negative bacilli.

The organisms are described on pages 239 and 240.

Never make a direct examination for gonococci on a smear of a urinary deposit.

Female

All kinds of organisms are found in the smears, particularly:

- Gram positive bacilli
- Gram negative cocci (saprophytes).

Culture is therefore *essential*.

Dispatch of specimens for culture

A. Using Martin & Lester's "Transgrow" medium*

This is the best method, if the medium can be obtained from a specialized laboratory.

30-ml bottles contain 8 ml of solid medium (along one side of the bottle) are filled with a mixture of air (90%) and carbon dioxide (10%). The bottle should remain open for as short a time as possible to prevent the escape of gas.

Note: This medium is usually supplied in flat bottles for convenience, but round bottles, as shown here, may also be used.

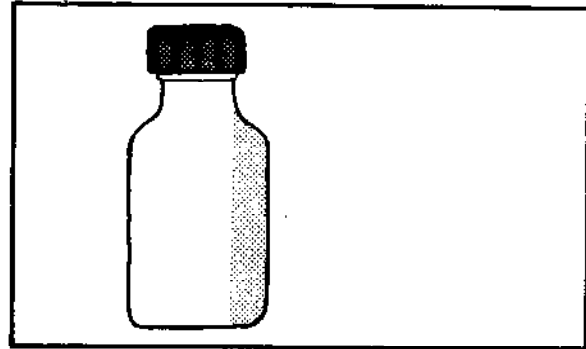

1. Place the bottle upright.
Collect the pus specimen on a swab.
Unscrew the bottle cap.

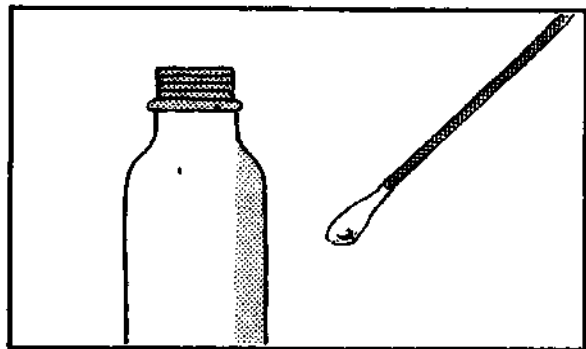

2. Holding the bottle as upright as possible (to prevent the gas escaping), rub the swab of pus over the whole surface of the solid medium, from one side of the bottle to the other, starting from the bottom.

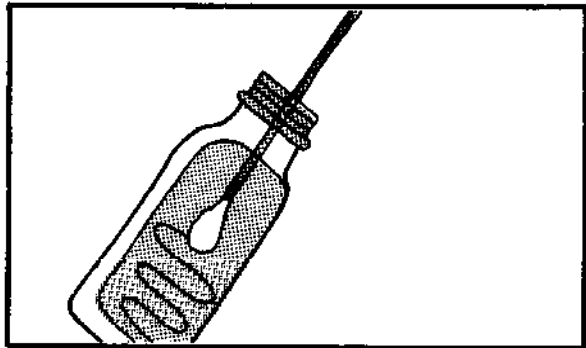

3. Replace the cap on the bottle at once.
Dispatch at normal temperature.
Preservation time: up to 3 days, but the shorter the delay the better.
This transport medium is also suitable for meningococci.

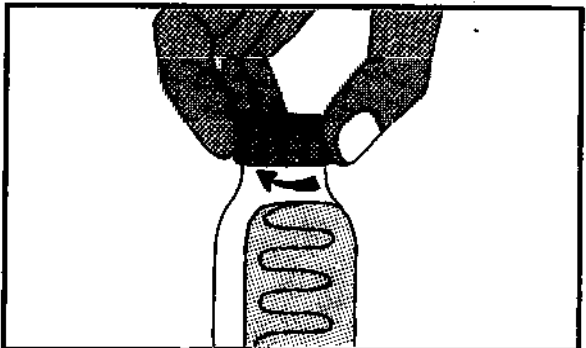

*US Department of Health, HMSHA Health Reports, 1971, Vol. 86, No. 1, page 30.

- B. Using semi-solid transport medium for gonococci**
Stuart transport medium (reagent No. 50), can be used in small 5-ml bottles with stoppers.

1. Collect the pus specimen on a sterile cotton wool swab held in sterile (flamed) forceps.

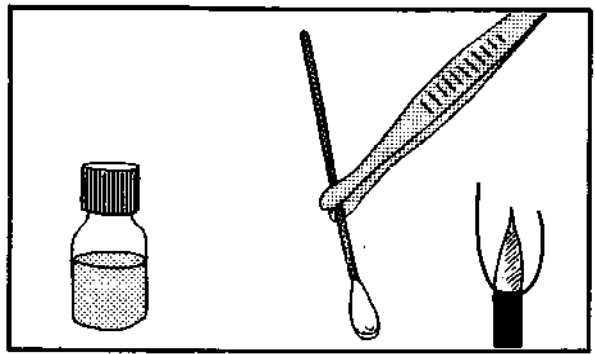

2. Put the swab into the transport medium in the bottle.
3. Cut off the protruding portion of the swab stick with sterile (flamed) scissors.
4. Screw the cap on the bottle at once.

Preservation time: 6 hours only at normal temperatures.

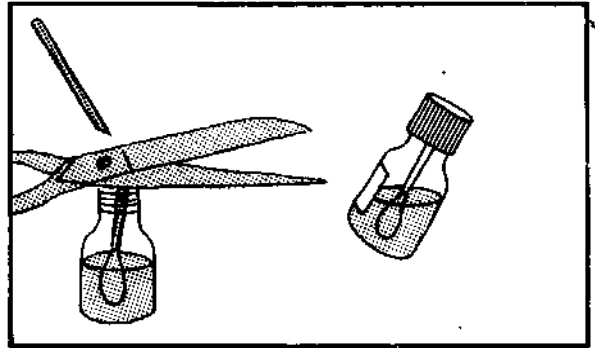

C. Using a Pasteur pipette

1. Draw the pus specimen into a sterile Pasteur pipette plugged with cotton wool.
2. Place the pipette as it is in a sterile tube, padded and plugged with cotton wool, as shown in the diagram.

Preservation time: 6 hours only at normal temperatures.

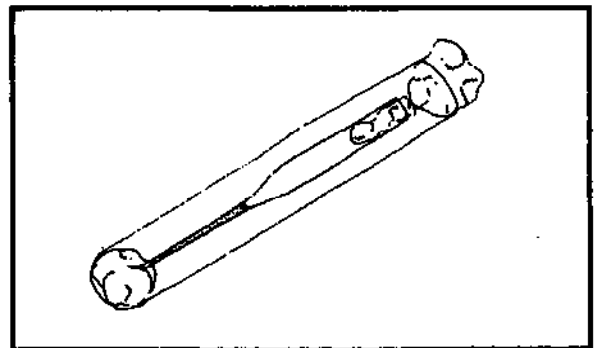

There are other media; in each case observe the instructions given by the specialized laboratory.

SYPHILIS

Syphilis is another venereal disease, caused by a spirochaete: the pale treponeme (*Treponema pallidum*).

The incubation period is about one month.

The first sign of the disease then appears, usually on the genital organs, as a chancre, round or oval, 1 or 2 cm in diameter, red with hard edges.

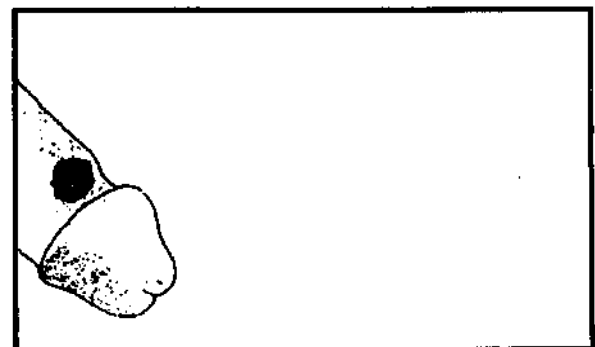

Non-venereal (endemic) syphilis

This form of the disease is found in semi-desert regions such as the Sahel belt south of the Sahara and the Eastern Mediterranean area. It mainly affects children.

Yaws

This is a non-venereal disease found in humid tropical climates. It is caused by a different treponeme (*T. pertenue*), which looks identical to *T. pallidum*.

Direct wet examination for treponemes in syphilis and yaws

This can be carried out only by experienced personnel in a laboratory equipped with a dark-ground condenser microscope.

The examination is of no value when the patient has treated the lesion with ointment. In that case, wait 3 days before making the examination.

1. Clean the chancre with gauze moistened with sterile sodium chloride solution. Dry it.



2. Scrape the edges of the chancre several times with the flat blade of a sterile lancet. Do not draw blood.

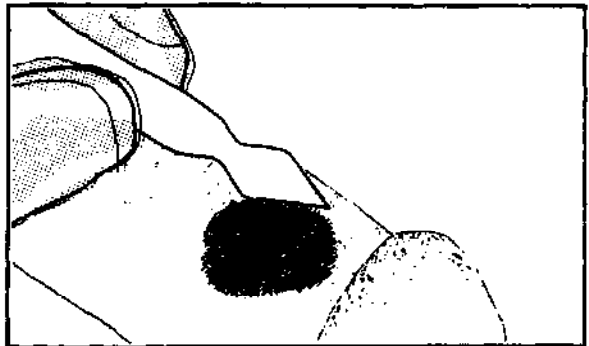

3. Press with dry sterile gauze.

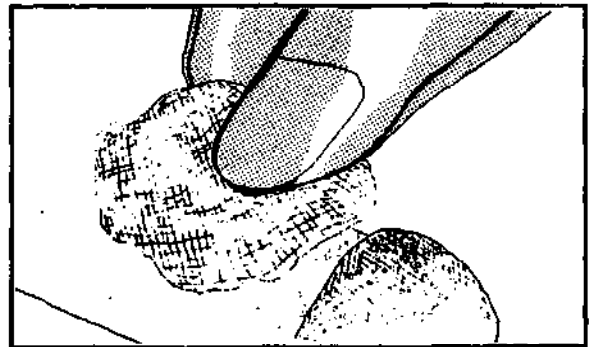

4. Remove the swab and wait a few minutes until a pinkish serous fluid appears. Draw off the fluid with a Pasteur pipette with a teat.

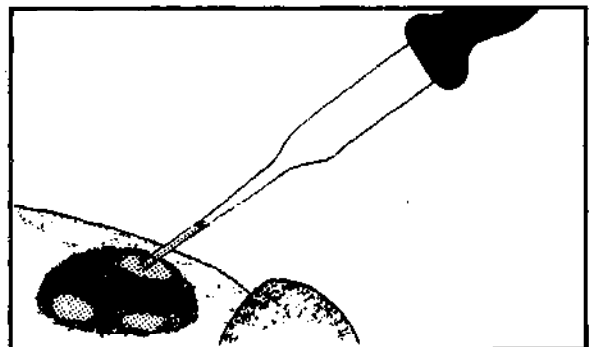

5. Place a drop of the fluid on a thin glass slide (designed especially for dark-ground microscopy).

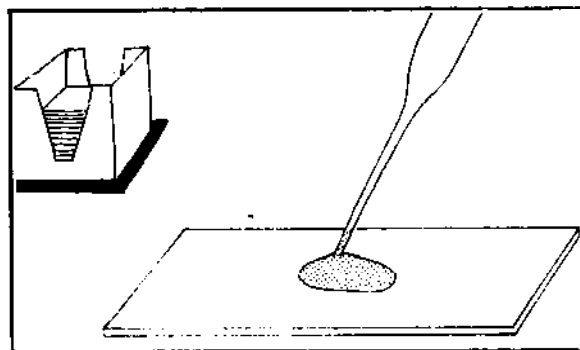

6. Examine under the microscope using a dark-ground condenser.

The treponemes of syphilis and yaws can be distinguished from saprophytic treponemes of the skin by their very thin bodies and characteristic movement.

The technician needs special training to recognize them.

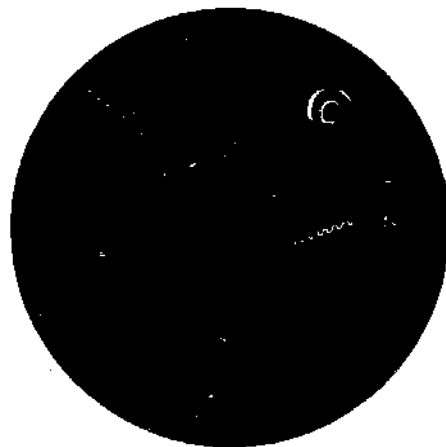

Examination of dried and stained smears

This is not recommended because of the presence of saprophytic treponemes on the skin and in the mucous membranes.

Serological examination for syphilis and yaws, see VDRL test, page 288. This test should be repeated after 3-4 weeks if the examination for treponemes is negative.

31. Tubercle Bacilli. Ziehl-Neelsen Stain: Hot Method

Principle

The tubercle bacillus *Mycobacterium tuberculosis* is acid-fast and stains red with Ziehl-Neelsen stain (see page 253), while almost all other organisms stain blue.

The technique described below is based on Smithwick, R.W. *Laboratory manual for acid-fast microscopy*, 2nd ed., Atlanta, US Department of Health, Education, and Welfare, Center for Disease Control, 1976. See also International Union against Tuberculosis. *Technical guide for collection, storage and transport of sputum specimens and examination for tuberculosis by direct microscopy*, Paris, IUAT, 1976.

Collection of sputum

The quality of the specimen is very important; see page 254 for method of collection for direct examination and page 255 if the specimen is to be dispatched for culture.

MATERIALS

- Glass slides (new if possible, unscratched)
- Inoculating loop
- Cotton wool plug on metal wire for flaming
- Alarm clock (timer).

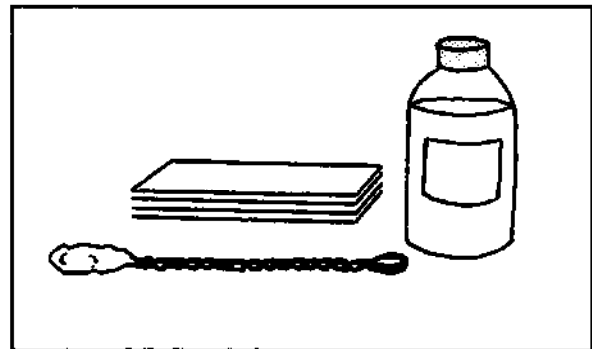

REAGENTS

- Carbon fuchsin for Ziehl-Neelsen stain (reagent No. 13)
- Acid-ethanol (reagent No. 3)
- Aqueous methylene blue (reagent No. 38)
- Methylated spirit (for burning)
- Wash bottle of distilled water.

PREPARATION OF SPUTUM SMEAR

1. Prepare two slides.

Take a purulent portion of the sputum, one for each slide, using either one sterile inoculating loop or two to form tongs.

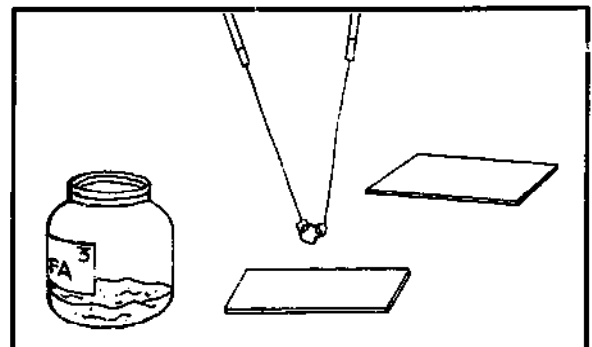

2. Make the smears:

- as thin as possible
- covering as large an area as possible, tracing concentric circles well separated but not reaching the edges of the slide.

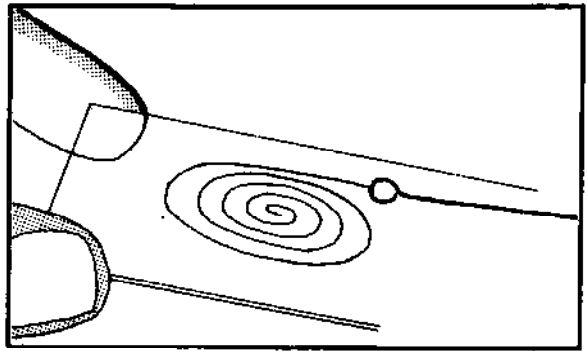

Important:

When the smears are completed, plunge the inoculating loops into liquid disinfectant and shake to remove any sputum. Then bring the loop near the flame, wait until it is dry, then pass it through the flame. This prevents infected sputum from being sprayed into the air on exposure to the flame.

3. Fixation

Dry in the air and then fix the smears by passing the slides three times through the flame.

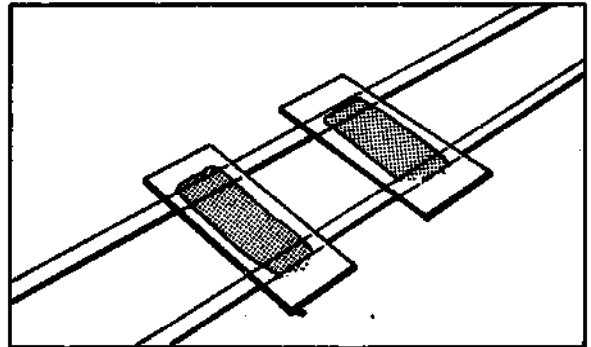

- 4. Place the numbered slides on two glass rods over the sink.**

5. Carbol fuchsin staining – 5 minutes with heat

Cover the slides with carbol fuchsin, filtered before use.

Dip the cotton wool swab in the methylated spirit, ignite and pass slowly under the slides to heat them.

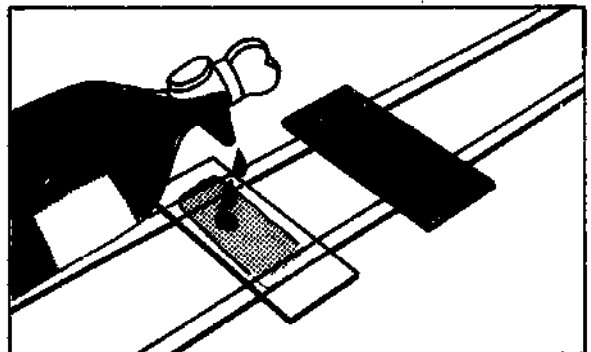

6. As soon as steam begins to rise, set the timer at 5 minutes.
Continue to heat so that steam is seen, but without boiling, for 5 minutes.
If the filtered stain starts to dry during heating, add more fuchsin immediately to avoid drying.

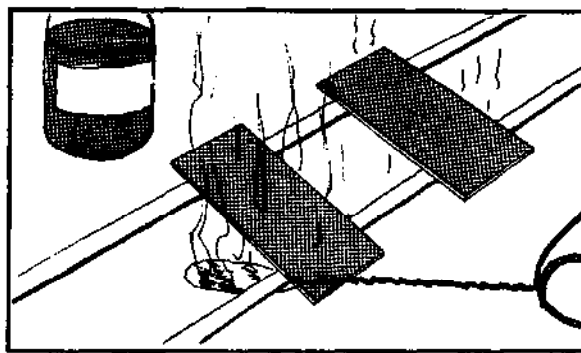

7. *Wash with distilled water*

Cool. Wash the slides gently with water until the water that runs off is colourless.

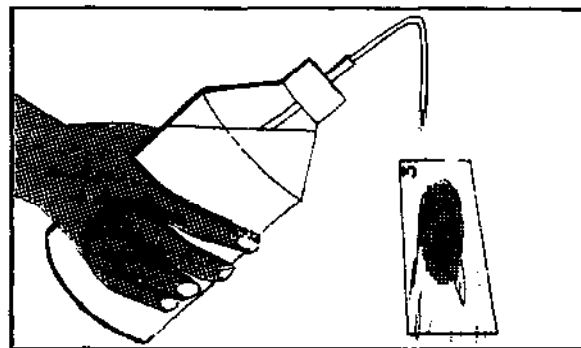

8. *Decolorization with acid-ethanol*

Cover the slides with acid-ethanol.

Leave for 3 minutes.

Wash the slides in ordinary tap water and drain.

Examine the slides; if they are completely decolorized, stain with methylene blue as indicated under 10 below.

If traces of fuchsin can still be seen (thick smear), apply acid-ethanol again and leave for 1 minute.

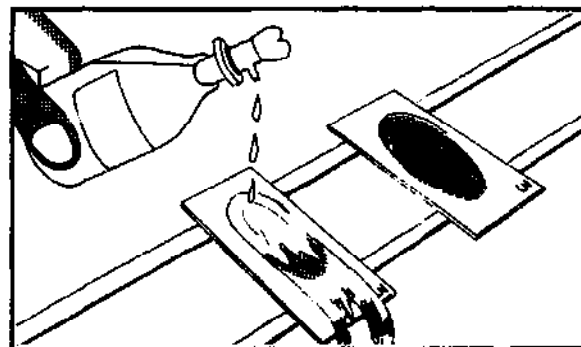

9. *Wash with water*

Check that the slides are completely decolorized.

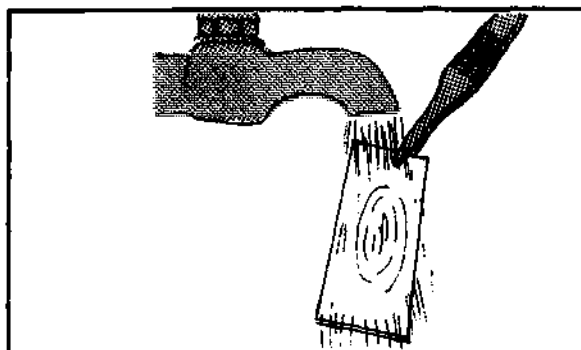

10. *Methylene blue staining – 30 seconds*

Cover the slides with the stain. Leave for 30 seconds.

Wash with tap water for 1 minute.

Drain and leave to dry on a slide rack.

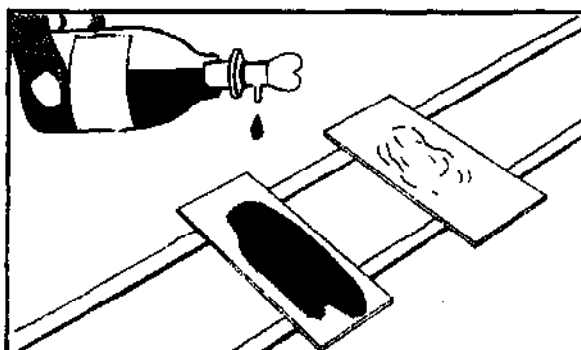

SLIDE EXAMINATION

Use the oil-immersion objective.

Tubercle bacilli are:

- bright red on a blue background
- straight or slightly curved
- quite short (1-4 μm)
- often granular
- arranged in groups of 3-10 bacilli close together, like bits of string, or forming letters or forked shapes (they are often found near threads of fibrin).

A 0.2% solution of malachite green in distilled water can be used instead of methylene blue solution. The procedure is the same. Malachite green stains the background green; the tubercle bacilli stain red.

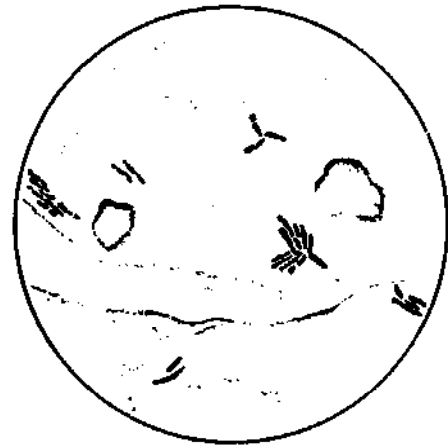

Do not mistake the following for tubercle bacilli:

1. Yeasts, stained more or less red. When heated they often break up into groups of large red granules.
2. Spots of stain deposit (when the slide is not properly decolorized).

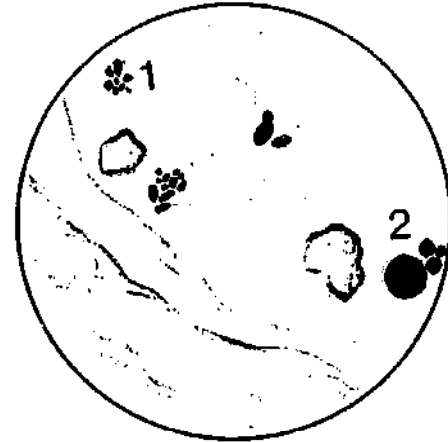

Important:

Another pathogenic acid-fast bacillus is the leprosy bacillus (see page 262). Various bacilli that are more or less acid-fast are found in nature, even in tap water. These sometimes lead to an incorrect laboratory result.

How to examine slides

Make a complete examination of the first slide using the oil-immersion objective (maximum illumination, no colour filter), proceeding as shown in the diagram.

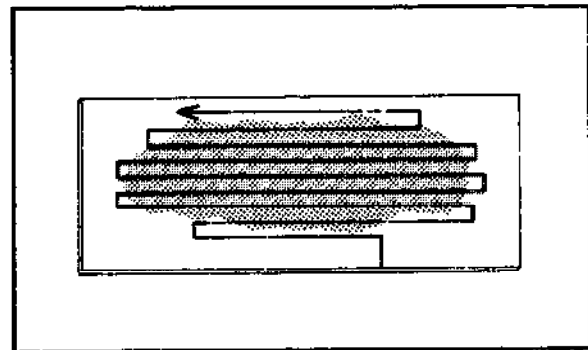

Positive slide

When you have seen about 10 acid-fast bacilli on the first slide, examine the second one to confirm the finding.

Negative slide

Examine the first slide thoroughly (10 minutes), then repeat with the second slide (10 minutes).

RECORDING OF RESULTS

Number of acid-fast bacilli (AFB) found*	Report	Alternatively
0	Negative for AFB	-
1-2/300 fields	Number seen	±
1-9/100 fields	Number/100 fields	1+
1-9/10 fields	Number/10 fields	2+
1-9/field	Number/field	3+
9/field	9/field	4+

* Method of Center for Disease Control and WHO in: Smithwick, R.W. *Laboratory manual for acid-fast microscopy*, 2nd ed., Atlanta, US Department of Health, Education, and Welfare, Center for Disease Control, 1976.

PRINCIPLE OF ZIEHL-NEELEN STAINING METHOD

The bacillus responsible for tuberculosis in man is *Mycobacterium tuberculosis*:

- human type
- bovine type and avian type (rare).

The bacilli are acid-fast, i.e., once they are stained red by carbol fuchsin they cannot be decolorized by acid or by ethanol.

Organisms that are not acid-fast Tubercle bacilli

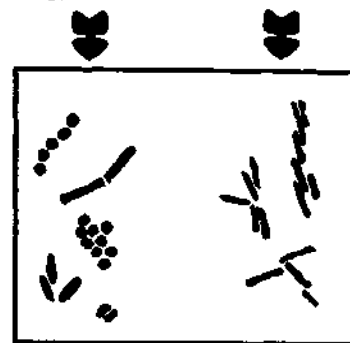

Carbol fuchsin:

- stains all the organisms in the sputum red.

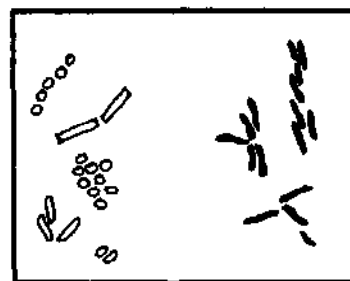

Acid-ethanol mixture:

- decolorizes all organisms and cellular elements except acid-fast bacilli (tubercle bacilli).



Methylene blue:

- stains blue all the organisms and elements decolorized by the acid-ethanol mixture, but the acid-fast bacilli remain red.

OTHER PATHOGENIC ORGANISMS FOUND IN SPUTUM

Culture is always necessary for their identification. However, the presence of some species may be suspected in direct examinations (Gram stain). (See page 239.)

- Pneumococci*: Gram positive diplococci. Each pair is surrounded by a capsule that remains colourless.
- Fungi*: yeasts, filaments of mycelium with or without pores. They may be pathogenic (identification by a specialized laboratory necessary) or saprophytes that have multiplied in the specimen after collection.
- Actinomyces (granules)*: See page 240.

Parasites may be found in unstained preparations: eggs of pulmonary flukes and, very rarely, eggs of schistosomes and *Syngamus*.



COLLECTION OF SPECIMEN

Collect the first sputum of the morning.

The nurse or laboratory technician must be present and the following procedure should be followed:

1. The patient should be standing, if possible.

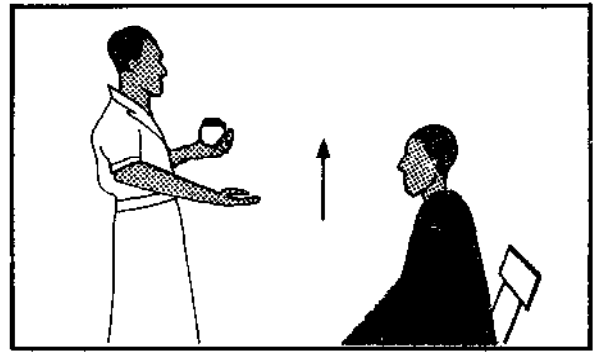

2. He should take a very deep breath, filling his lungs.



3. He should empty his lungs in one breath, coughing as hard and deeply as he can.



4. He should spit what he brings up into the jar.

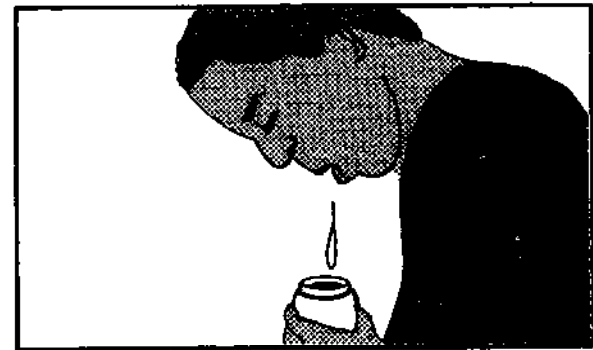

5. Label the jar clearly with his name and the date.

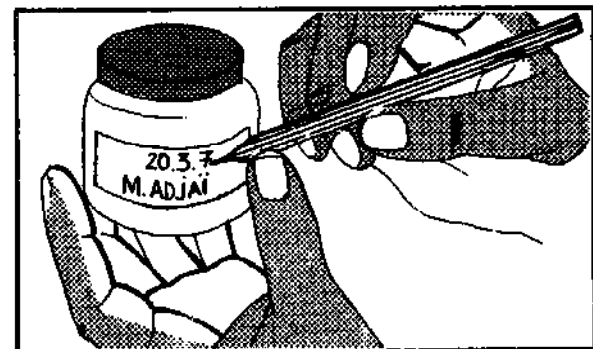

Jars and boxes used to collect sputum

Use reusable jars or stiff paper boxes made in the laboratory for on-the-spot collection (see page 70). For cleaning and disinfecting of receptacles, see page 40.

After collection

Check that a sufficient amount of sputum has been produced.

The sputum of an infected person usually contains:

- thick mucus with air bubbles
 - threads of fibrin
 - patches of pus
 - occasional brownish streaks of blood.
-

Important:

Liquid frothy saliva and secretions from the nose and pharynx are not acceptable expectorations. Have the patient produce another specimen.

DISPATCH OF SPUTUM

Sputum is sent away for the culture of tubercle bacilli, which takes 1-2 months, for the establishment of anti-biograms or for the inoculation of guinea pigs.

Fluid transport medium

A wide-mouthed, screw-top bottle containing:

25 ml of a solution of 0.6% cetylpyridinium bromide in distilled water.

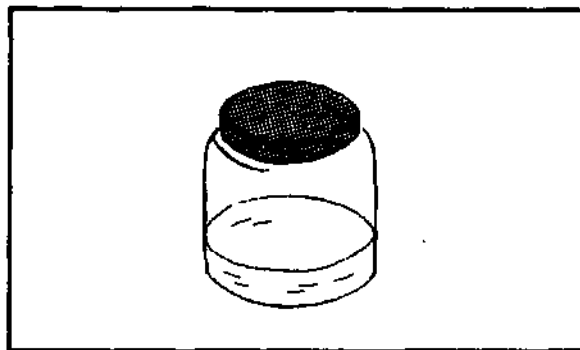

Collection

The patient should expectorate directly into the liquid in the bottle. Screw on the cap and dispatch.

Preservation time: at least 10 days.

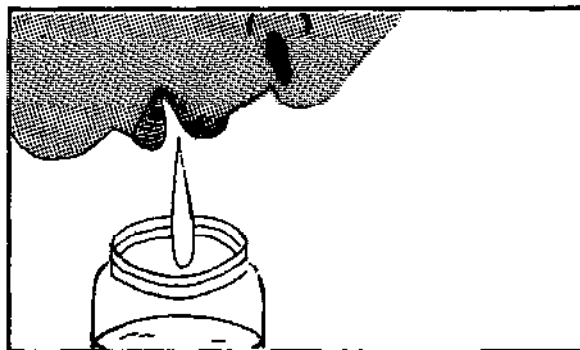

Pulmonary tuberculosis can also be diagnosed by:

1. **Direct examination (and culture) of gastric lavage fluids** (particularly in children): centrifuge the fluids at high speed for 20 minutes, make a smear of the deposit and stain like sputum.
2. **Culture of laryngeal swabs.**

For other sites of infection, bacilli are sought in:

1. **Urine (renal tuberculosis):** see page 305.
2. **The pus of cold closed abscesses (tuberculosis of bone).**
3. **The cerebrospinal fluid (tuberculous meningitis, especially in children):** see page 349.
4. **Fluid aspirated from glands.**

Examination of stools for tubercle bacilli is not recommended.

32. Tubercle Bacilli. Kinyoun Stain: Cold Method

Principle

The same reagents are needed for the cold staining method but a more concentrated solution of carbol fuchsin is used, making heating unnecessary.

Tubercle (and leprosy) bacilli remain red on a blue background.

Advantages

The technique is simpler and faster than the hot staining method (see page 249). It facilitates examination of large numbers of specimens (e.g. in epidemiological surveys).

It does, however, use up a lot of carbol fuchsin. For routine work in a general laboratory the hot method seems more suitable.

MATERIALS

- Timer
 - Kinyoun carbol fuchsin (reagent No. 33)
 - Acid-ethanol (reagent No. 3)
 - Methylene blue (reagent No. 38).
-

PREPARATION OF SMEARS

Follow the instructions given on page 249.

STAINING

Place the slides on two glass rods over the sink.

Do not treat more than 6 slides at a time.

Shake the bottle of fuchsin well just before using it.

Method

1. *Kinyoun carbol fuchsin* – 5 minutes
(do not heat).

Pour the fuchsin on to the slides. Each slide must be completely covered.

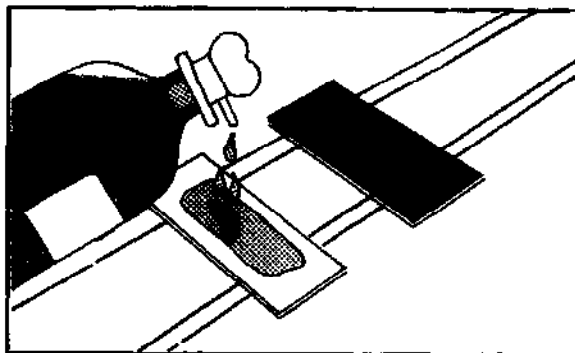

2. Wash gently with water.

Rinse each slide thoroughly under the tap or in a stream of water from a wash bottle.

Drain well.

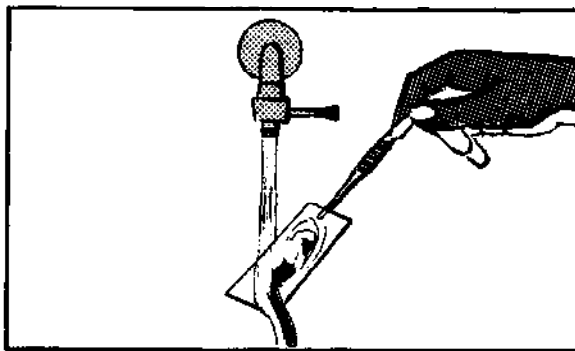

3. Decolorize with *acid-ethanol* – 2 minutes

Cover each slide.

Leave for 2 minutes (thin or thick smears) or until no more colour appears in the washing.

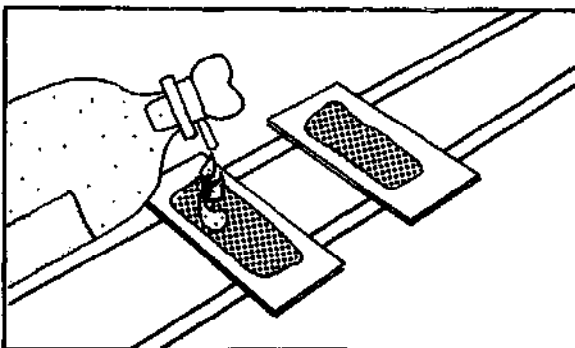

4. Wash gently with water.

Rinse each slide under the tap.

5. Counterstain with *methylene blue* – 30 seconds

Wash gently in running water.

Dry in air.

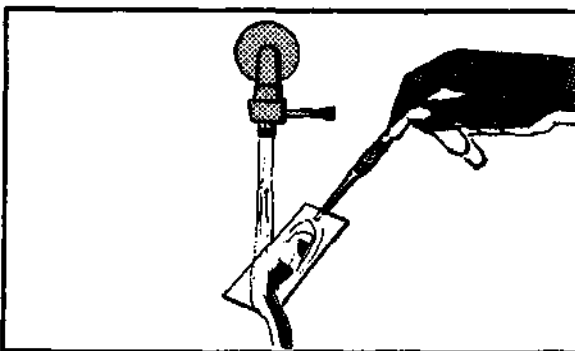

SLIDE EXAMINATION – RECORDING RESULTS

Follow the instructions given for the hot staining method (page 252).

33. Leprosy: Examination for the Bacillus in Nodules and Skin Lesions

Principle

Cases of lepromatous leprosy show:

- small nodules on the lobes and rims of the ears
- nodules and larger patches on the face and body.

Leprosy bacilli are often present in large numbers in lepromatous lesions, but are usually very sparse or not seen at all in tuberculoid lesions. The bacillus is known as *Mycobacterium leprae* or Hansen's bacillus.

A lesion is incised superficially without causing bleeding. Serous material from the incision is spread on a slide, air-dried, fixed for 3 minutes in formaldehyde fumes, and examined under a microscope after staining by a modified Ziehl-Neelsen method. *Mycobacterium leprae* is acid-fast.

MATERIALS

- Scalpel
- If available, forceps with rounded ends and no teeth, or curved clamp forceps with no teeth, or tissue forceps
- Large Petri dish
- Slides
- Gauze
- Ethanol
- Commercial formaldehyde (37%)
- Reagents needed for modified Ziehl-Neelsen staining, listed below.

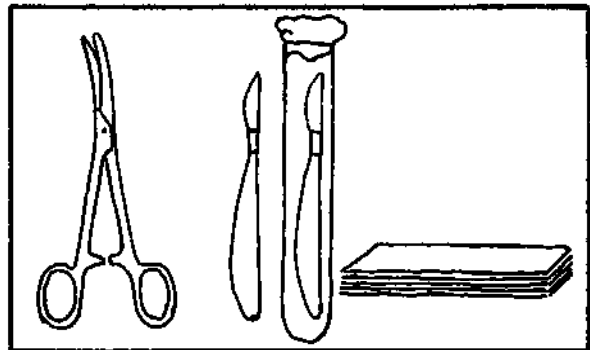

REAGENTS

- Carbol fuchsin (reagent No. 13) with solution A *modified* to contain 10 g (instead of 3 g) basic fuchsin
 - Acid-ethanol (reagent No. 3) *modified* to contain 1 ml concentrated hydrochloric acid, 66 ml 95% ethanol, and 33 ml distilled water
 - Methylene blue solution (reagent No. 38) *modified* to contain 30 ml 95% ethanol and 70 ml distilled water.
-

SPECIMEN FROM EAR

1. Examine each ear in good light beamed from the side:
Look for lesions: small swellings (infiltration) with a shiny surface, of different sizes.
Select the most congested lesion or nodule.

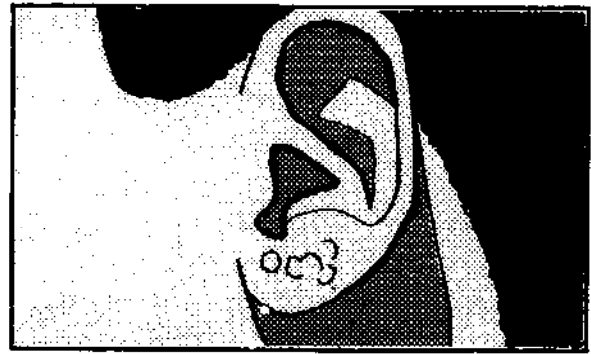

2. Clean the area with a gauze swab moistened with ethanol. Flame the forceps and scalpel. Scalpels can be sterilized beforehand in small glass tubes plugged with non-absorbent cotton wool. Avoid iodine.

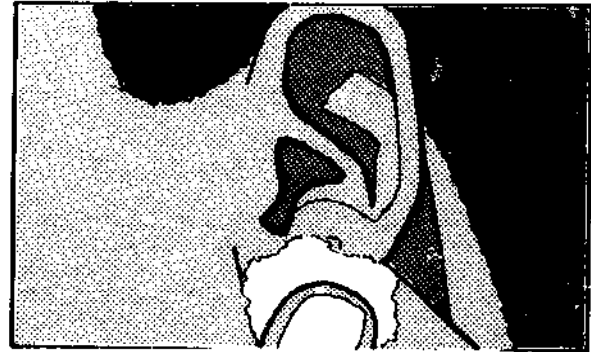

3. Squeeze the ear lobe hard between the blades of the forceps to *stop the flow of blood to the area*.

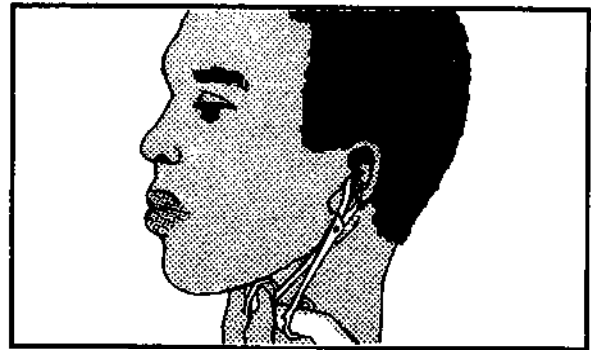

4. Holding the forceps firmly, make a superficial incision lengthwise in the middle of the lesion:
 - about 0.5 cm long
 - 2-3 mm deep.
5. Still squeezing with the forceps, scrape the bottom and edges of the incision with the point and blade of the scalpel. Collect on the scalpel the colourless or pinkish serous material from the lesion. Do not draw blood.

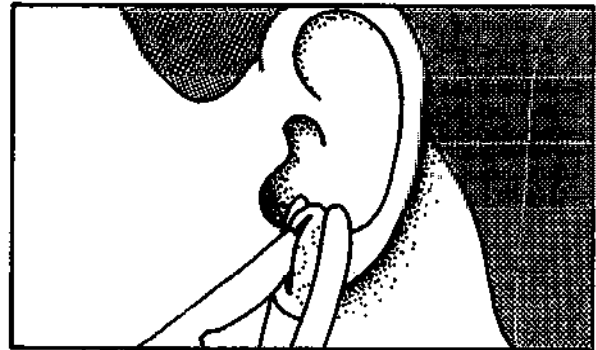

6. With the flat of the blade spread the serous material in a circular motion over an area 5-7 mm in diameter on a slide numbered with a diamond pencil. 2-4 smears from the same patient may be put on a single slide.

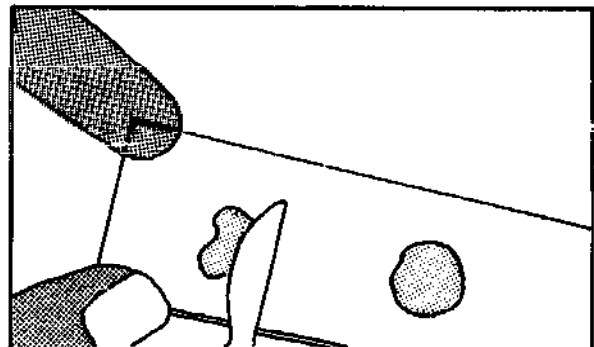

7. Leave the slide to dry in a dust-free place. When the smears are completely dry, fix them with formaldehyde fumes in a large Petri dish containing a rack. Add enough formaldehyde solution to cover the bottom. Place the slides on the rack. Cover the Petri dish and leave for 3 minutes.

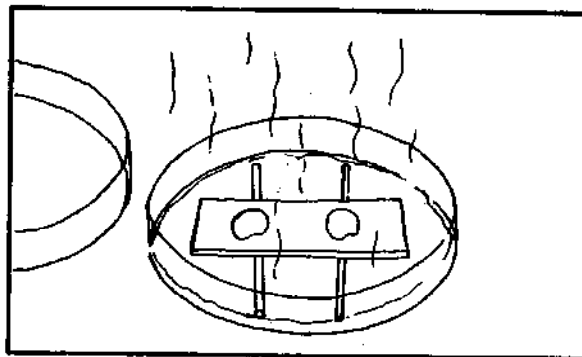

8. Staining the smears:

- Flood each slide with freshly filtered carbol fuchsin and allow to stand for 20 minutes.
- Wash the slides gently in tap water (in a beaker with the smear away from the stream of water); they may be allowed to stand in the beaker until decolorization.
- Decolorize one slide at a time by gently streaming with acid-ethanol until this flows clear and colourless.
- Wash the slides again in tap water and allow them to stand wet until counterstaining.
- Counterstain with methylene blue solution for 1 minute (see page 251).

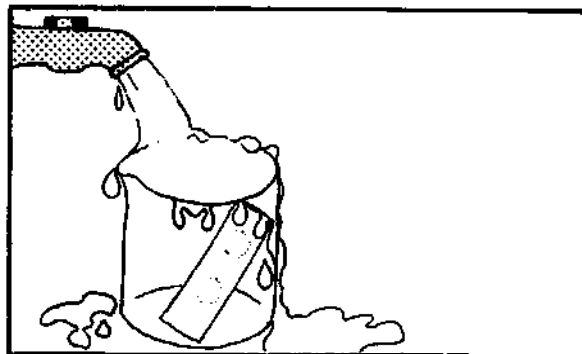

Note: For description of *Mycobacterium leprae*, see page 262.

SPECIMENS FROM THE BODY AND FACE

Examine the body and face for:

- A lesions similar to those found on the ear, but often larger
- B papules, flat patches (maculae), or plaques; they are lighter in colour or thickened areas of skin looking like orange peel, infiltrated.

A sample can also be taken from an area of skin just showing signs of leprous infiltration.

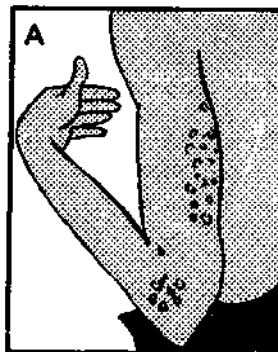

Choose the most acutely infiltrated lesion and select a site for collection of the specimen. This should be:

- just inside the edge of the patch, where the skin appears to be altering most rapidly. (This is important, to ensure that bacilli are detected.)

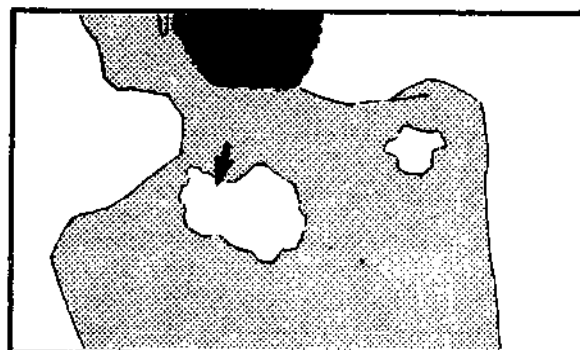

1. Disinfect the area with gauze dipped in ethanol. Pinch the site hard with clamp forceps without teeth.

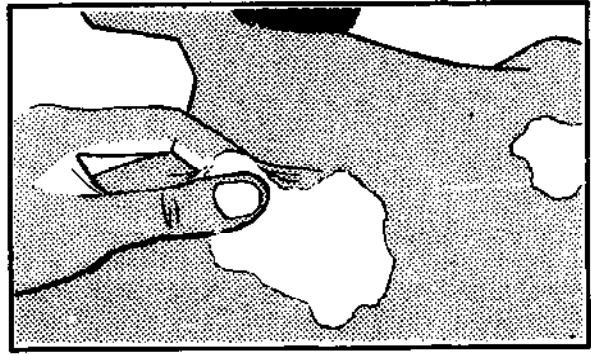

2. Continue to hold firmly. With the tip of a scalpel make an incision:
 - 0.5 cm long
 - 2-3 mm deep
3. Scrape the bottom and edges of the incision with the tip of the scalpel. Collect a quantity of pulp and serous material. (Continue to squeeze to prevent bleeding.)

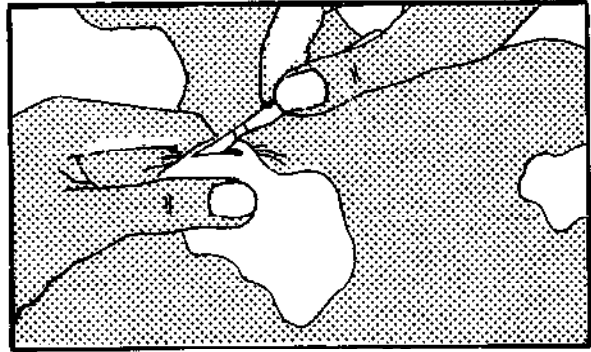

4. With the scalpel spread the specimen in a circular motion over an area 5-7 mm in diameter on a glass slide numbered with a diamond pencil.
 - 3-6 specimens from different lesions can be put on the same slide.
 - Dry and fix the smears as indicated on page 261.
 - Stain as indicated on page 261.
 - Clean the incision with ether or ethanol and apply a dressing if there is bleeding.

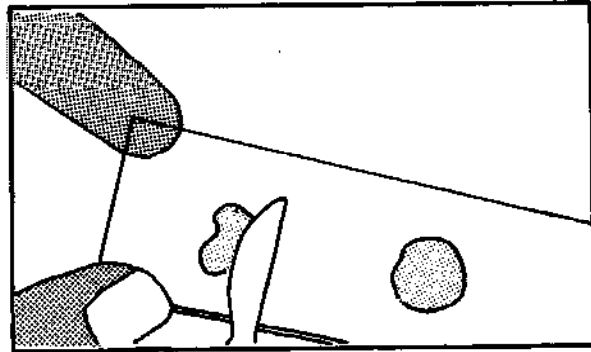

DESCRIPTION OF LEPROSY BACILLUS

Similar in appearance to the tubercle bacillus. Like the latter, it is acid-fast and stains red on a blue background with the modified Ziehl-Neelsen technique.

Size	1-8 μ m
Shape	longish rods straight or slightly curved with rounded ends
Granulation	often granular, with bright red granules separated by colourless spaces
Arrangement	(a) either in groups of 2-5 arranged in parallel (b) or in larger groups or clusters (c) or in large numbers in circular masses called "globi".

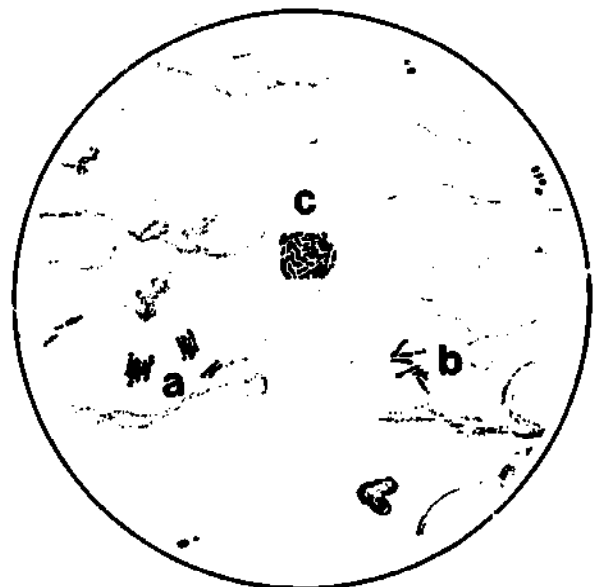

RECORDING THE RESULT

Record the result as follows:

- specimen from plaques or nodules on ear, etc.
- examination with the x 100 objective, using the x 6 eyepiece: no acid-fast bacilli seen
- or, shows acid-fast bacilli (specify whether in globi)

Indicate degree of positivity:

No bacillus per 100 fields	0
1-10 bacilli per 100 fields	1+
1-10 bacilli per 10 fields	2+
1-10 bacilli per 1 field.	3+
1-100 bacilli per 1 field.	4+
More than 100 bacilli per 1 field	5+

Importance of examination of plaques or nodules

Always begin by examining specimens from plaques or nodules, if any.

Bacteriological and morphological indexes

These indexes can be calculated on the request of the physician.

(a) *Bacteriological index.* Add all the positive findings from all body sites where a sample has been taken and divide the total number of positives by the number of sites. For example:

site 1 = right ear	+++
site 2 = left arm	+
site 3 = back	++
<hr/>	
total	6+
<hr/>	
bacteriological index 6/3 =	2+

(b) *Morphological index.* Examine 100 bacilli on the prepared slides. Count the number of bacilli that are uniformly stained red down their length ("viable bacilli"). If the number of viable bacilli is, for example, 8, the morphological index is 8%. This index is used for the first diagnosis and follow-up of multibacillary patients.

Culture

There is no method available for the *in vitro* culture of *Mycobacterium leprae*. The organism can multiply, however, in the foot pads of mice and in the armadillo.

34. Leprosy: Examination for the Bacillus in Nasal Smears

MATERIALS

- Plastic or cellophane sheet, thin
- Cotton wool swab on stick (the wisp of cotton wool should be as small as possible)
- Slides, numbered with a diamond pencil
- Tube of sodium chloride solution (reagent No. 45)
- Reagents necessary for staining by the modified Ziehl-Neelsen method: see page 259.

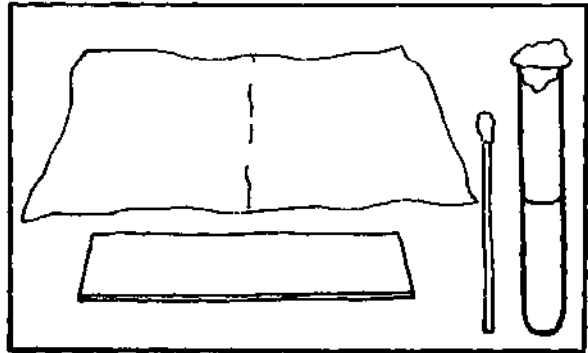

Specimens are best prepared from an early-morning "nose blow". The patient blows his nose thoroughly into a small clean dry sheet of cellophane or plastic.

1. With a small cotton wool swab, slightly moistened in sodium chloride solution, transfer some of the opaque material from the plastic sheet to a labelled microscope slide.
2. Spread the material as evenly as possible on the slide. Two or more smears of the same material may be made on one slide.
3. Leave the smears to dry.
4. When completely dry, fix with formaldehyde fumes (see page 261).
5. Stain by the modified Ziehl-Neelsen technique (see page 261).
6. Examine under the microscope and record the results as indicated for examination for the bacillus in nodules and skin lesions (see page 263).

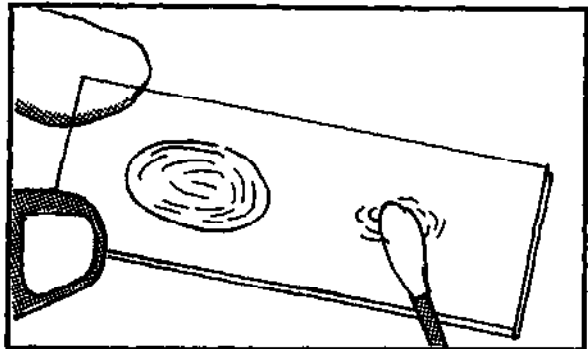
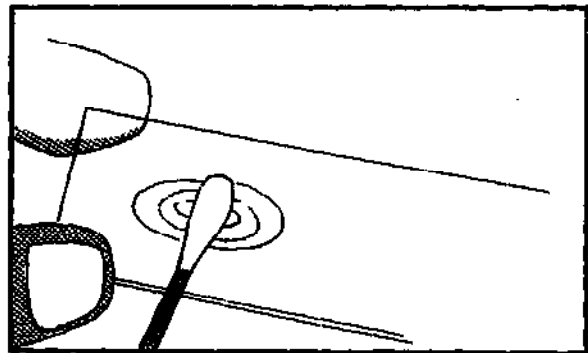

INTERPRETING THE RESULTS OF EXAMINATION OF NASAL SMEAR

<i>Type of leprosy</i>	<i>Result of examination</i>
- lepromatous	very often positive
- borderline	often positive
- tuberculoid	usually negative
- indeterminate	often negative

Important:

Examinations for the leprosy bacillus should be carried out chiefly on scrapings from skin lesions (ears, face, body). This technique is described on page 259. Examination of nasal smears is also a routine requirement.

Note, however, that nasal smears sometimes contain non-pathogenic acid-fast bacilli that are not leprosy bacilli.

35. Plague: Examination for the Bacillus

Principle

Confirmation of plague infection requires the isolation and identification of the plague bacillus, *Yersinia pestis*. During epidemics or epizootics it is often possible to reach a presumptive diagnosis on the basis of the presence of the characteristic bipolar stained plague bacilli using Wayson stain (reagent No. 57), in specimens collected from a bubo by aspiration.

1. COLLECTION OF SPECIMENS

Materials

- 10 ml or 20 ml syringe with 18-gauge (1.2 mm) or 19-gauge (1.0-1.1 mm) needle
- Tincture of iodine
- 70% ethanol
- Sodium chloride solution (reagent No. 45)
- Glass slides

Method

1. Disinfect the skin of the bubo with tincture of iodine.
2. Draw a few millimetres of sodium chloride solution into the syringe through the needle.
3. Holding the syringe between the thumb and finger of the right hand, insert the needle into the bubo.
4. With the left hand, pull back the piston of the syringe slowly. Fluid (which may be bloodstained) should appear in the syringe. If no fluid appears in the syringe, inject the sodium chloride solution into the bubo by pressing gently on the piston with your thumb. Move the needle about in the bubo with a circular motion. Then slowly pull back the piston again, until the syringe is about half full, if possible.
5. Withdraw the syringe, and swab the puncture site with cotton wool impregnated with ethanol.
6. Holding the syringe upright, let 1 or 2 drops flow from the needle on to a slide, and prepare a smear as described on page 232.
7. If bubo fluid is to be sent to a specialized laboratory for culture, a few millilitres should be inoculated into Cary-Blair transport medium (reagent No. 14) and the sealed screw-capped bottle should be dispatched in a double container (see page 74).
8. Immerse the syringe and needle in 5% phenol, withdrawing the plunger gently (see page 39 for disposal of infected material).

Important: When handling bubo material, the greatest care must be taken to avoid the production of an aerosol (the dispersion of minute droplets in the air), which might lead to the accidental infection of others and the spread of pneumonic plague.

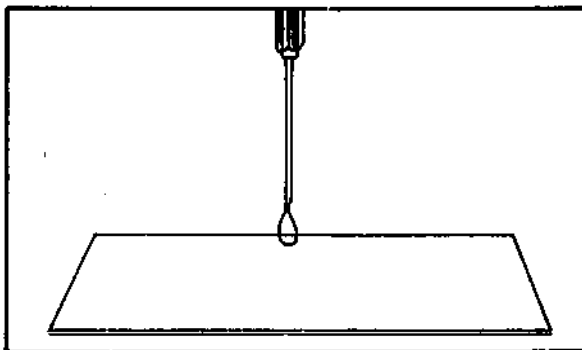

2. EXAMINATION FOR THE BACILLUS

Materials

- Methanol (chemically pure)
- Glass slides
- Wayson stain (reagent No. 57)
- Tap water.

Method

1. Fixation

- (a) Place the air-dried smears in a staining jar filled with chemically pure methanol for 5 minutes.

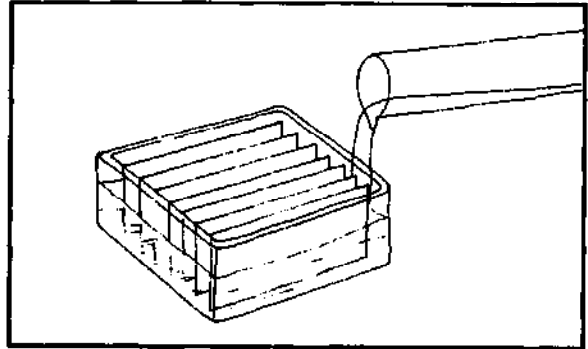

- (b) Remove the slides and allow them to dry in the air before staining.

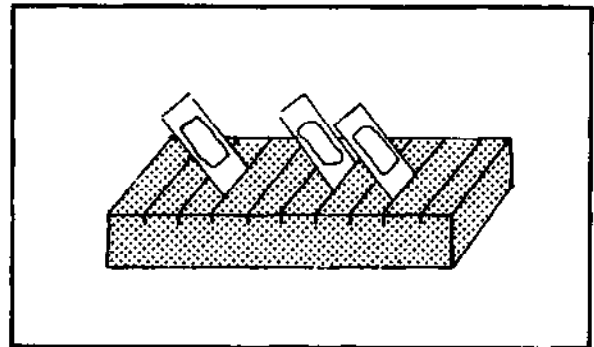

2. Staining

- (a) Cover fixed smears with Wayson stain for 10-20 seconds.

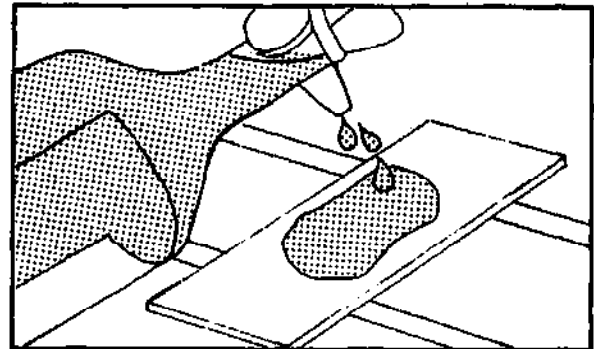

- (b) Carefully wash the slides in tap water.

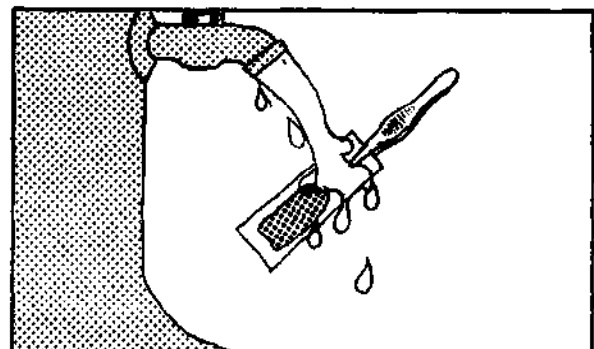

(c) Allow to dry and then examine under the oil immersion lens (x 100), looking at thin areas of the stained films for the characteristic plague bacilli.

Results

With Wayson stain the polar bodies of *Y. pestis* are blue and the remainder of the smear is reddish.

36. Dispatch of Stool Specimens

It is often necessary to send stools elsewhere for bacteriological culture:

- for the detection of cholera vibrios
- for the detection of other bacteria causing dysentery (*Salmonella*, *Shigella*, etc.)

The same method of transport may be used for both if Cary-Blair transport medium (reagent No. 14) is used.

USING CARY-BLAIR TRANSPORT MEDIUM

Cary-Blair transport medium will preserve many kinds of enteric bacteria (cholera vibrios, other vibrios, salmonella, shigella, etc.) for up to 4 weeks. The uninoculated medium may be stored at room temperature for 8-12 weeks before use, if in a sealed bottle.

1. Dip a sterile cotton wool swab in the stool specimen.

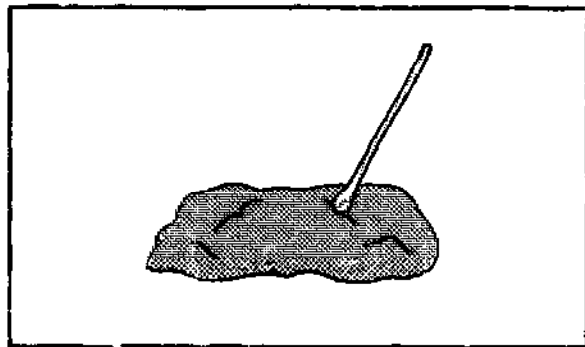

2. For infants or other patients without a stool specimen take a rectal swab. Moisten the swab with sodium chloride solution and introduce the swab into the rectum. Turn the swab several times with a circular movement.

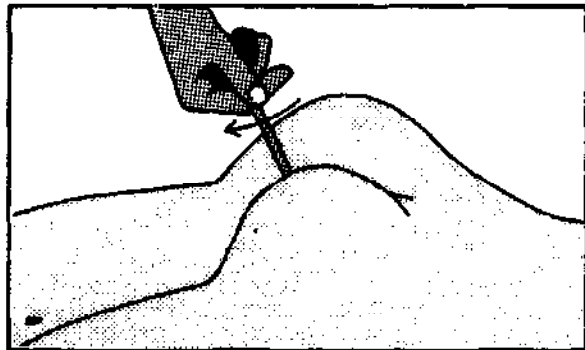

3. Place the swab in a bottle containing Cary-Blair medium (¾ full). If a delay is unavoidable store at room temperature.

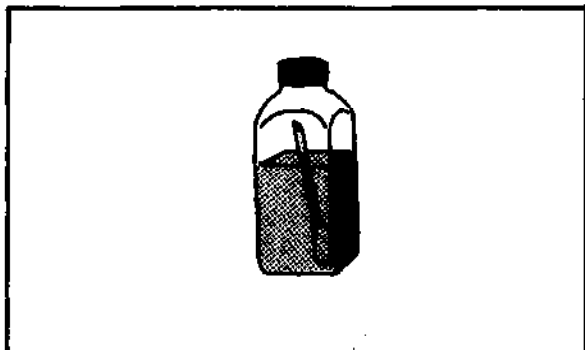

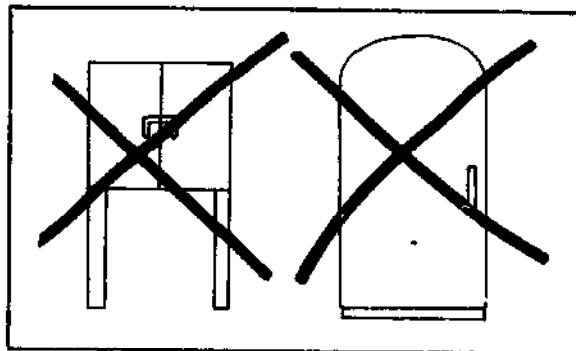

Important:

1. Never store in the incubator.
 2. Never store in the refrigerator.
-

USING BUFFERED GLYCEROL SALINE

When specimens are to be sent for culture of enteric organisms other than cholera vibrios and Cary-Blair transport medium is not available, buffered glycerol saline may be used (reagent No. 10).

Note: If the buffered glycerol saline in the bijou bottle has changed colour from pink to yellow, discard it and prepare a fresh solution.

1. A bijou bottle with a capacity of 7.5 ml is recommended. Fill it to within 2 cm of the top.
 2. Place the stool swab or rectal swab in the medium and then send it directly to the bacteriology laboratory.
-

37. Direct Examination of Specimens from the Throat. Dispatch of Specimens

Advantages

Direct microscopical examination of a stained smear prepared from a throat specimen sometimes gives an indication of the organism causing an infection. Bacterial culture is needed to establish the identity of the organism with certainty.

Organisms responsible for throat infections

- diphtheria bacilli (*Corynebacterium diphtheriae*)
- streptococci
- a combination of spirochaetal and fusiform organisms
- *Candida* (a fungus)
- various other less common species.

MATERIALS

- Sterile cotton wool swabs in test-tubes for the collection of specimens (for preparation of swabs, see page 274)
- Tongue depressor or spoon
- Reagents for Gram staining (see page 235).

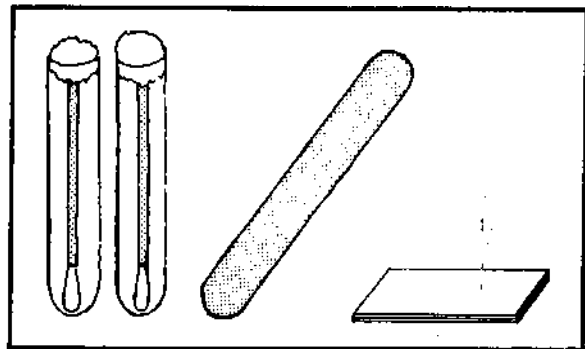

COLLECTION OF SPECIMEN

Ideally this should be done by the physician or nurse, but the laboratory technician may be called upon to take the specimen.

1. The patient should sit facing the light (or an electric torch can be used).
2. Tell the patient to open his mouth without putting out his tongue, and to say "Ahhhh...".
3. While he is saying "Ahhhh..." press the outer 2/3 of the tongue down with the tongue depressor, using the left hand. The tonsils (T) and the back of the throat framed by the arches (A) should be visible.
4. Introduce the swab with your right hand. Do not touch the tongue, which is coated with organisms.
5. Locate the infected (inflamed) part of the throat. It will be very red or white depending on the case. Usually the infection is located in the tonsils or fauces.
6. Rub the swab firmly against the inflamed part, turning it round, and collect membranes, if present.
7. If nothing abnormal is seen, swab the tonsils, the fauces and the back of the soft palate.

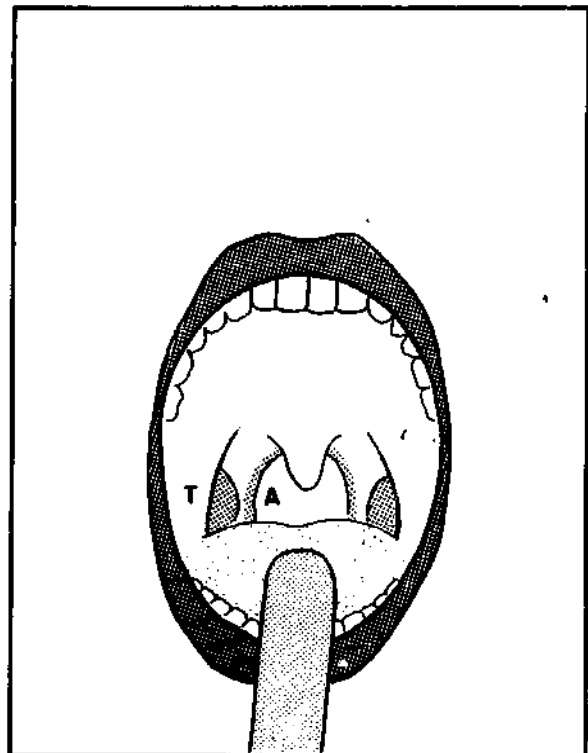

PREPARATION OF SMEAR

Streak 2 or 3 slides with the swab, using a rolling movement to make sufficiently thick broad smears.

If the smear is to be inoculated on a culture medium or dispatched in a transport medium, take two swabs:

- the first for the medium
- the second for preparing smears for direct examination.

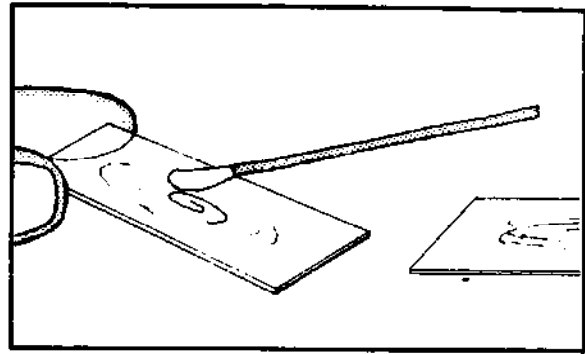

BACTERIAL EXAMINATION — DETECTION OF DIPHTHERIA BACILLUS

In all cases a smear should be stained by the Gram method (see page 235). If diphtheria is suspected a swab should be placed on Loeffler culture medium* and sent to a specialized laboratory.

*Obtainable from the national reference laboratory.

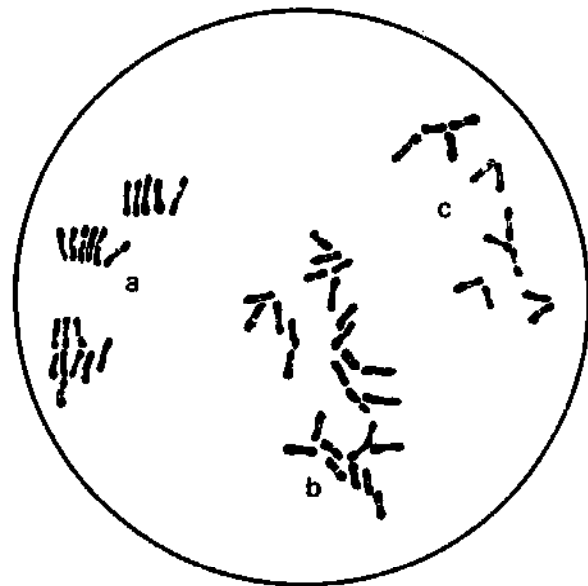

Description of diphtheria bacilli

Narrow Gram positive rods, straight or slightly curved and often enlarged at one end or both ends. They are arranged:

- in rows (a)
- or scattered (b)
- or in V formations (c).

Reporting the result

When reporting the presence of diphtheria-like bacilli in a throat swab, state that it shows the presence of Gram positive bacilli resembling *Corynebacterium diphtheriae*. The reason for this is that diphtheria bacilli can only be identified with certainty following culture.

Other varieties of bacteria

Direct examination is of little use if a mixture of different species is found. They may be pathogenic or non-pathogenic and include:

- streptococci (a)
- pneumococci (b)
- Gram negative diplococci (*Neisseria*) (c)
- Gram negative bacilli (d)
- staphylococci (e), etc.

The report should give a full description of the organisms found (quantity, appearance, reaction to Gram stain).

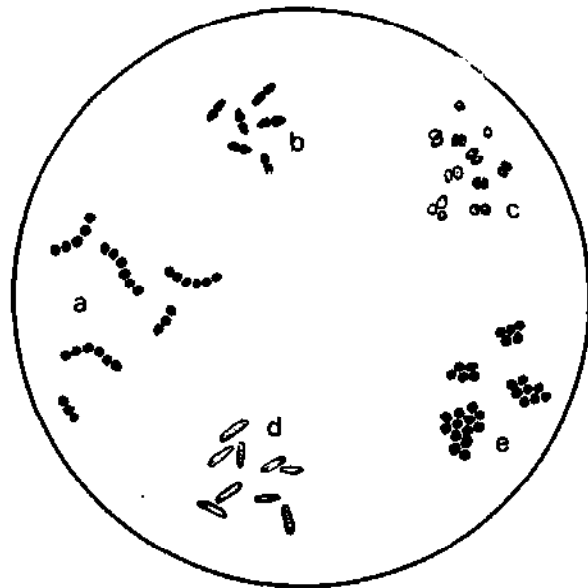

Combination of spirochaetal and fusiform organisms

Responsible for the necrotic ulceration of the mouth and throat known as Vincent's angina. Large numbers of the following are found, mixed and in equal quantities:

1. *Fusiform bacilli*: Gram negative, long, with tapering ends.
2. *Treponema vincentii*: Gram negative spirochaetes, often poorly stained, 10-25 μm long, in 5-7 loose irregular spirals (often curled at the end).

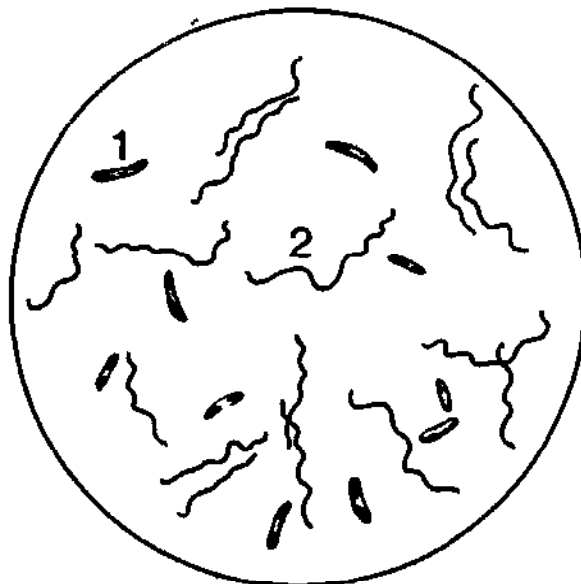

Candida

A fungus responsible for thrush or moniliasis (chiefly in infants). The following may be found:

- (a) *Yeasts*: oval or round spores, 2-4 μm in diameter, thin-walled, budding. They are strongly Gram positive.
- (b) *Mycelium-like filaments*: varying in length, 4 μm in breadth, with rounded ends.

To obtain a better presentation of these forms, make a wet preparation by dipping the swab in a drop of sodium chloride solution and examine between a slide and coverslip.

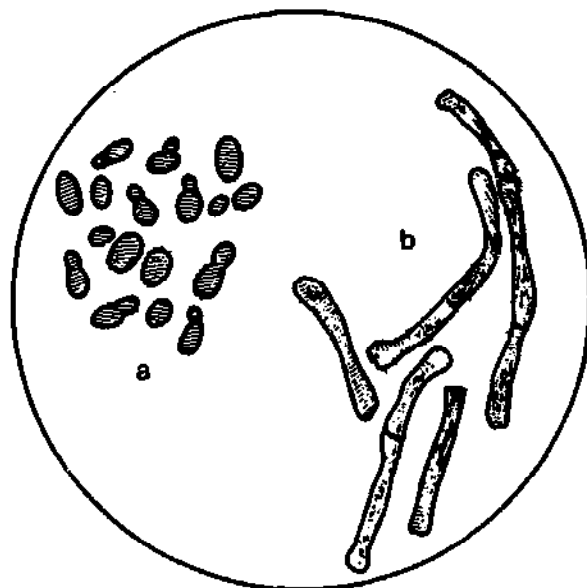

**DISPATCH OF THROAT SPECIMENS
(to a bacteriology laboratory for culture)**

1. Dispatch of swab alone

As soon as the specimen has been collected, replace the swab in its sterile tube and send as it is to the bacteriology laboratory.

Preservation time: 4 hours at the maximum.

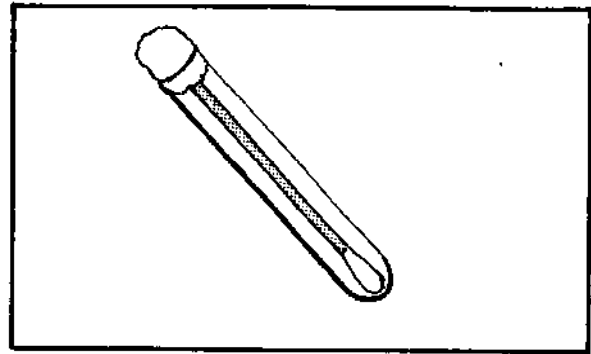

2. Dispatch for the detection of diphtheria bacilli

(a) Using tubes of coagulated serum (which must be stored in the refrigerator):

Rub the swab over the slanted surface of the serum, starting from the bottom and not applying pressure. Send the same day.

Maximum transport time: 24 hours.

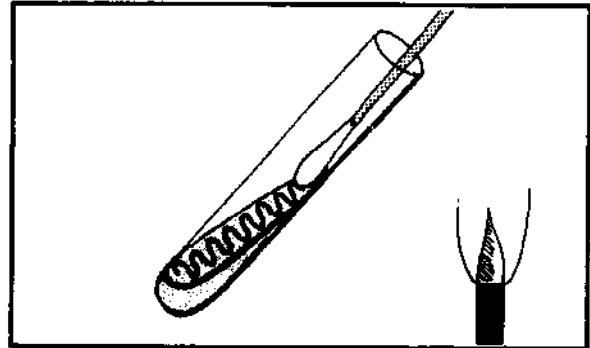

(b) Using Loeffler medium in a special tube for swabs:
Insert the swab immediately after collection of the specimen in the cylindrical space in the centre of the medium. Send the same day.

Maximum transport time: 24 hours.

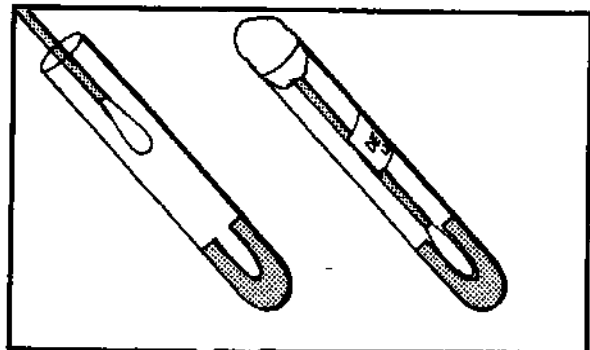

3. Dispatch for the detection of meningococci

This is seldom necessary, except during epidemiological surveys looking for carriers of meningococci. If possible, use the "Transgrow" medium or Stuart medium (see page 245).

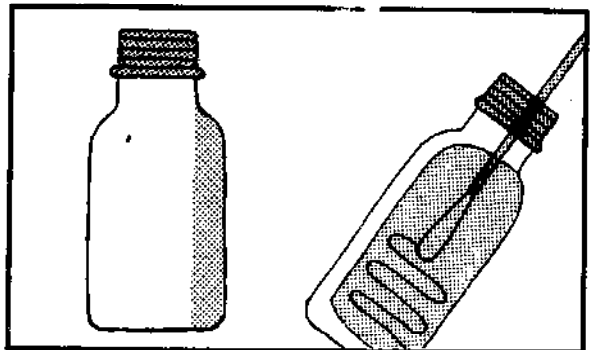

PREPARATION OF SWABS

If possible, swabs should be prepared at the central level using a detoxifying technique; if not possible, the following technique might be used.

1. Prepare some thin sticks of wood (or aluminium wire), 18 cm long and 2 mm in diameter.

Prepare strips of cotton wool, 6 cm long by 3 cm wide and as thin as possible.

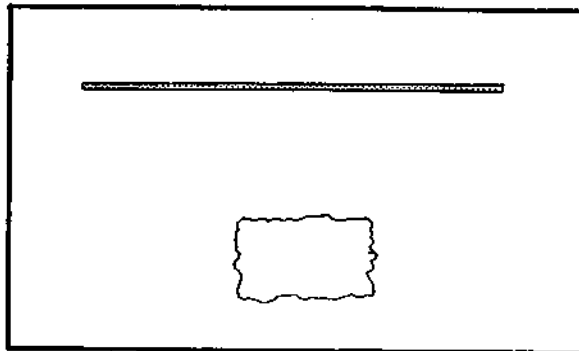

2. Roll the cotton wool round one end of the stick. If metal wire is used, flatten the end first.
3. Mould the swab in a conical shape.

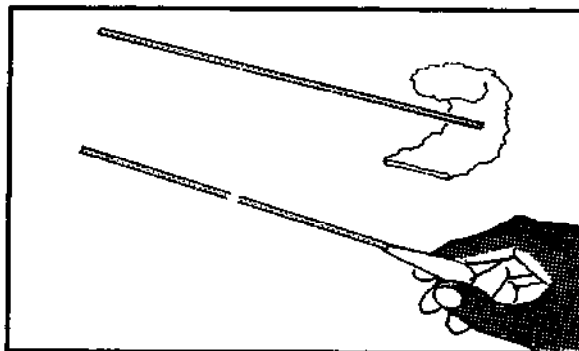

4. Place in a thick Pyrex tube. Plug with non-absorbent cotton wool. Sterilize.

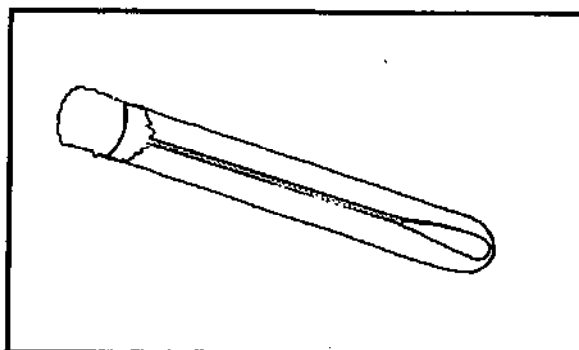

38. Direct Bacteriological Examination of Urine

Value

In healthy persons the urine contains practically no organisms. Bacteria may be found:

- where there is an infection of some part of the urinary tract (lower tract: urethritis; bladder: cystitis; kidneys: nephritis)
- or where bacteria from an infection elsewhere in the body are excreted in the urine.

Principle of direct examination

The urine is centrifuged at high speed. Microscopical examination of the urinary sediment as described on page 325 is essential and the most important part of the analysis. However, the deposit may also be used to make smears that are:

- dried and fixed
- stained by Gram and Ziehl-Neelsen stains
- examined under the microscope.

Culture is always essential for precise determination of the identity of the organisms found and the quantity present.

MATERIALS - REAGENTS

- Sterile 250 ml Erlenmeyer flask with stopper
- Electric centrifuge
- Sterile conical centrifuge tubes with stoppers
- Slides
- Inoculating loop
- Bunsen burner
- Reagents needed for Gram staining (see page 235) and Ziehl-Neelsen staining (see page 249).

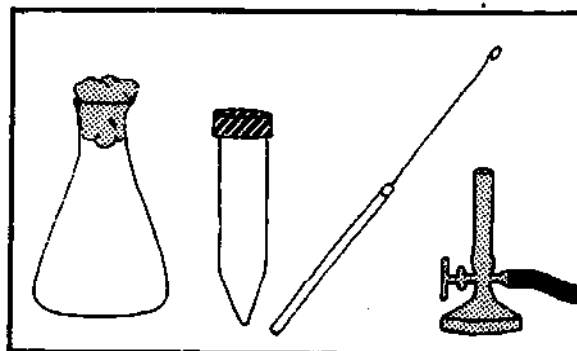

COLLECTION OF URINE

The genitalia should be cleansed beforehand (see instructions on page 306).

Collect a *midstream specimen* in the sterile flask. Examine as quickly as possible. (Another way is to collect the urine in a conical tube only rinsed in boiling water, and to examine immediately.)

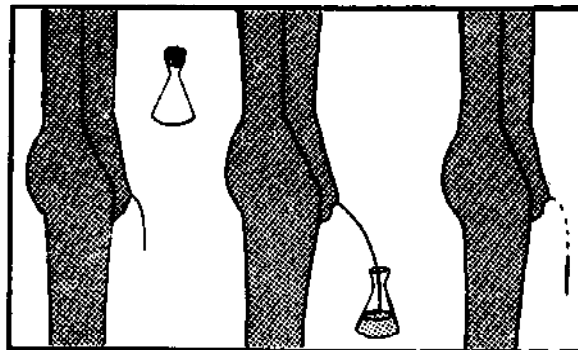

METHOD

1. In a sterile tube, stoppered either with a screw-cap or with a plug of sterile cotton wool fixed with gauze and string, centrifuge:

10 ml of fresh urine

at average speed for 10 minutes.

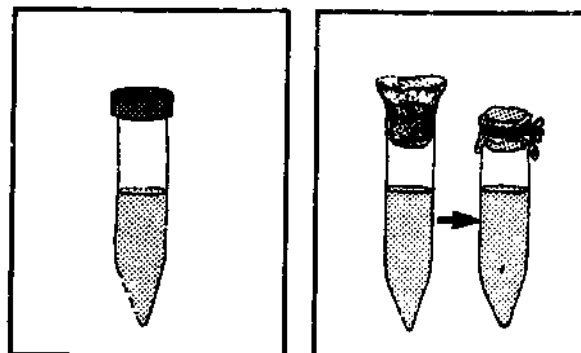

2. Pour off the supernatant urine.

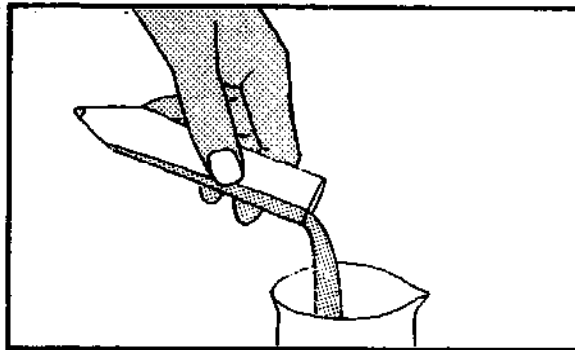

3. Mix the deposit, using the inoculating loop (sterilized by flaming), until it forms a homogeneous suspension.

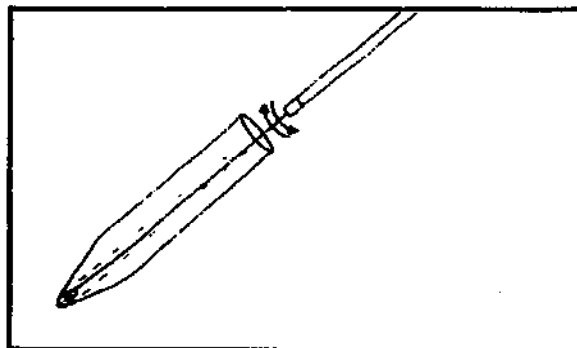

4. Make 2 smears. Let the 2 slides dry.
Fix by flooding with ethanol and flaming or by heating.

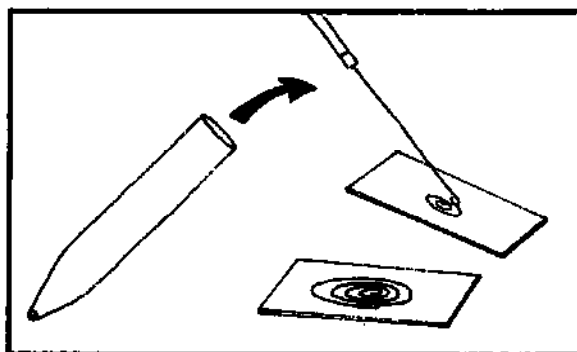

5. To stain:

slide 1 – Gram stain (see page 235)
slide 2 – Ziehl-Neelsen stain (see page 249).

Examine under the microscope (x 100 oil-immersion objective).

Look for pus: many leukocytes stained red by Gram stain.

Look for organisms such as:

1. Gram negative bacilli
2. Gram positive cocci
3. Gram positive diphtheroid bacilli
4. Gram positive yeasts.

See page 239 for descriptions of the above organisms.

Tubercle bacilli: see below.

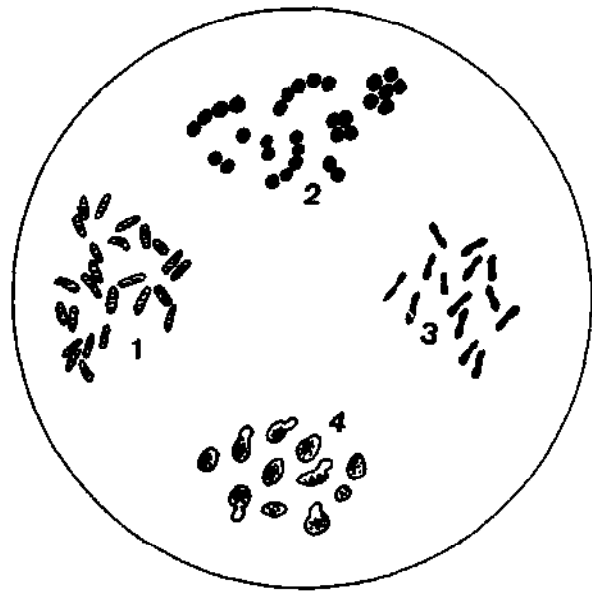

RESULTS

State whether there are leukocytes or pus present. Give a precise description of the organisms found.

Example

Many leukocytes
A few red blood cells
A few epithelial cells
Many Gram positive cocci in clusters.

Or

A few leukocytes
Occasional red blood cells
A few epithelial cells
A few Gram negative bacilli.

Gonococci

Never give a diagnosis of gonococci on the basis of an examination of a urinary deposit. Look for gonococci in urethral pus (see page 243).

TUBERCLE BACILLI

The slide stained by Ziehl-Neelsen stain is examined for tubercle bacilli.

If this examination is specifically requested:

- centrifuge 10 ml of urine at high speed for 20 minutes.

The bacilli stain dark red.

They are arranged in rows.

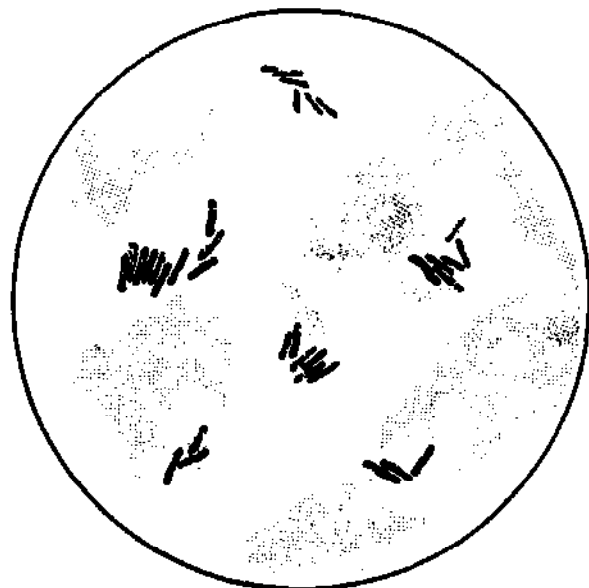

URINE CULTURES

Urinary deposits are inoculated on selective culture media. Another simple technique has been recently described using direct microscopical examination after Gram staining of urine that has not been centrifuged. The numbers of pus cells should be recorded as well as the appearance and effect of staining with Gram stain on the bacteria found. The following table indicates how the results may be interpreted.

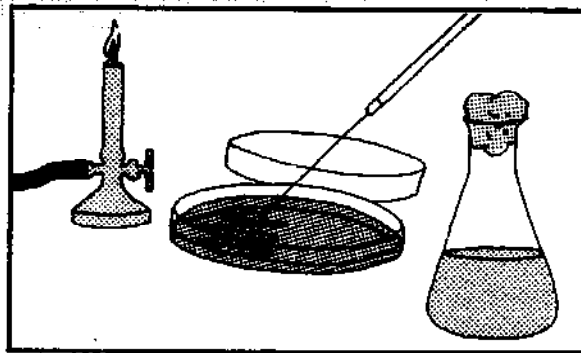

Pus cells*	Bacteria	Possible interpretation
>3	Gram positive cocci or Gram negative bacilli	Presence of urinary tract infection
<3	Gram positive bacilli or mixed flora	Contaminated or not fresh specimens
<3	Gram positive cocci or Gram negative bacilli but not mixed	Bacteriuria without pyuria
>3	None	Urinary tract infection after antibacterial therapy – tuberculosis – mycoplasma

*In the high-power field.

This procedure is essential:

- to identify the species of bacteria
- to determine the numbers of bacteria present (if they result from contamination of the specimen after collection, very few will be present)
- to isolate small numbers of organisms
- to establish the most effective antibiotic for treatment (antimicrobial susceptibility tests).

39. Water Sampling for Bacteriological Analysis

Principle

Various bacteriological tests must be carried out to determine whether water is safe for humans to drink. These tests are designed to identify and count the number of organisms that contaminate the water. They are usually performed in specialized laboratories.

Technicians working in field laboratories must be able to collect water samples properly and send them to the appropriate laboratory (bacteriology, public health, etc.) for analysis.

The water sample must be collected under sterile conditions to be sure that no outside organisms contaminate it.

MATERIALS

- 250 ml white glass bottle with ground glass stopper, washed and rinsed with distilled water
- Brown wrapping paper
- String
- 30 g/l solution of sodium thiosulfate (reagent No. 49)
- Cotton wool
- 70% ethanol
- Thermometer 0-50 °C.

The water sample may be taken from:

- a tap
- a well
- an open water source such as a lake or river.

METHOD

Sampling tap water

A. Preparations

1. Place in 250 ml sampling bottle:
 - 2 drops of sodium thiosulfate solution.

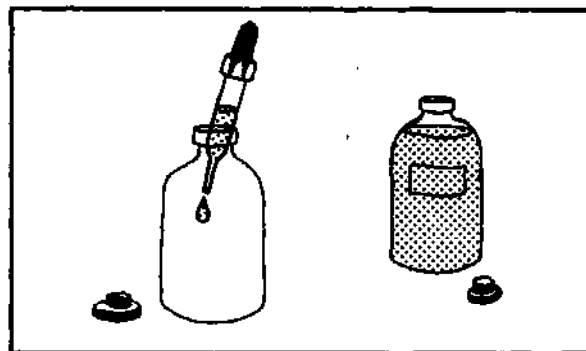

2. Replace the ground glass stopper. Cover the stopper with a piece of wrapping paper and tie it on firmly with string.

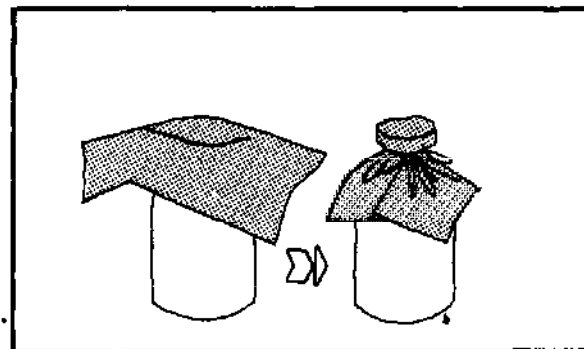

3. Sterilize in the autoclave for 30 minutes at 120 °C at a pressure of about 100 kPa (about 1 atm, 1 kgf/cm², or 15 lbf/in²).

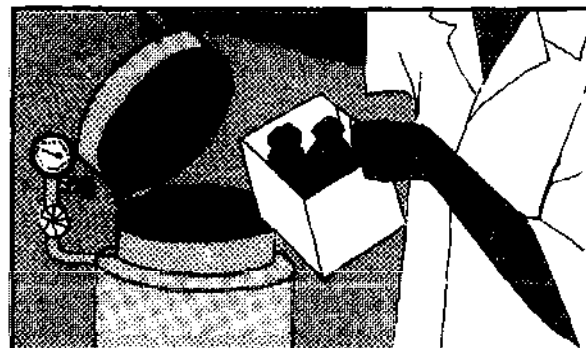

B. Taking the sample

1. Dip a cotton wool swab in 70% ethanol. Disinfect the tap by lighting the swab and holding it under the tap.

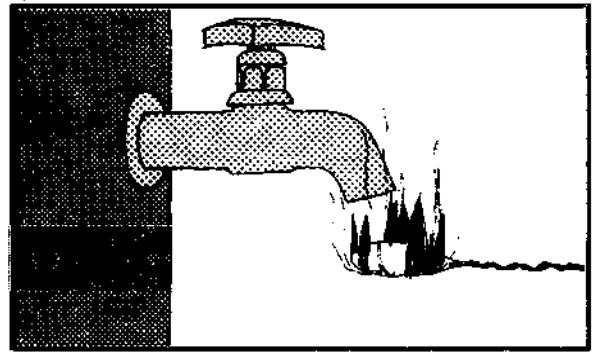

2. Turn on the tap and let the water flow for 2 minutes.

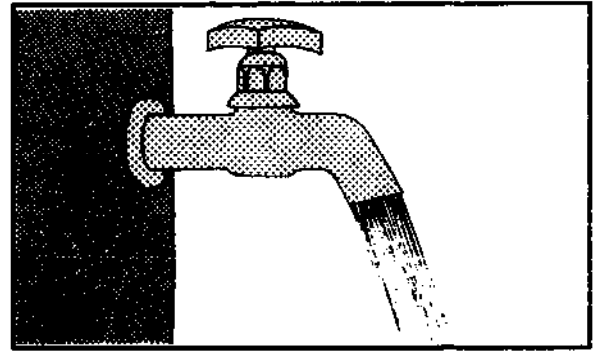

3. Remove the stopper from the bottle with your left hand. Hold the bottle in your right hand under the tap until it is $\frac{3}{4}$ full of water.

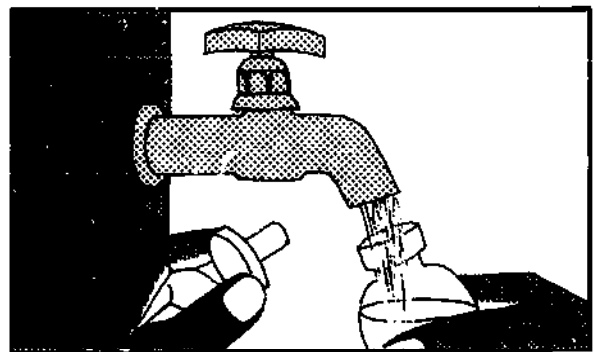

4. Replace the stopper in the bottle immediately. Put the paper back over the stopper and tie it around the neck of the bottle.

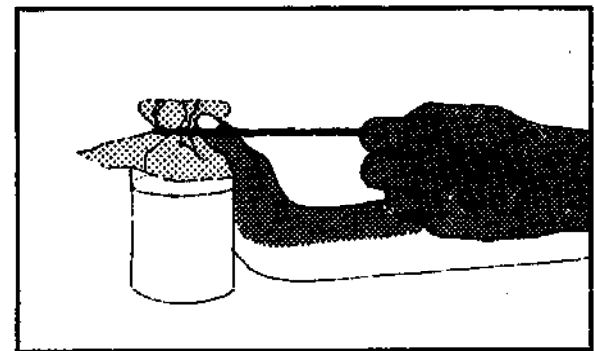

5. Fill in the information sheet (see model, page 284). If possible, collect a second sample from the tap and take the temperature of the water.

Pack the bottle of water upright in a box.

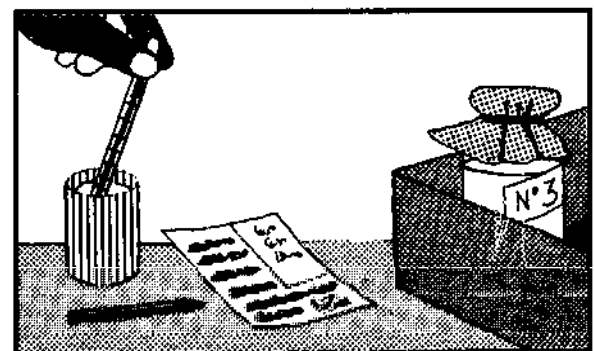

Sampling well-water

A. Preparations

1. Attach a suitably-sized stone with string to the middle of the bottle.

Take a 20 metre length of string rolled round a stick, and tie one end round the neck of the bottle.

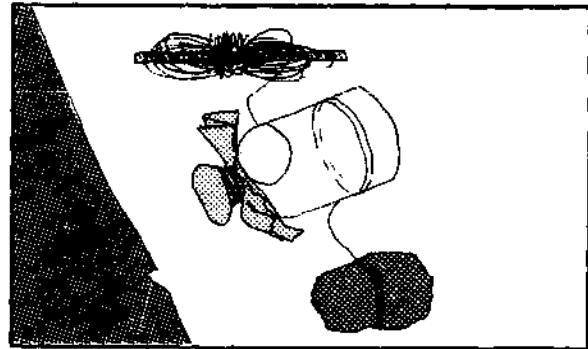

2. Wrap brown paper round the stopper and fix with string.

Wrap everything in a large sheet of paper and place in the autoclave for 30 minutes at 120 °C.

B. Taking the sample

1. At the well, open the sterile package without touching the contents.

Rub your hands with 70% ethanol.

Remove the stopper from the sampling bottle. Place the stopper on the sterile wrapping paper.

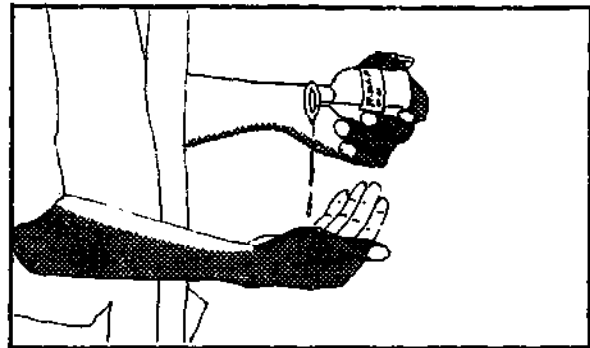

2. Lower the bottle, weighted by the stone, into the well, unwinding the string slowly. Do not allow the bottle to touch the sides of the well.

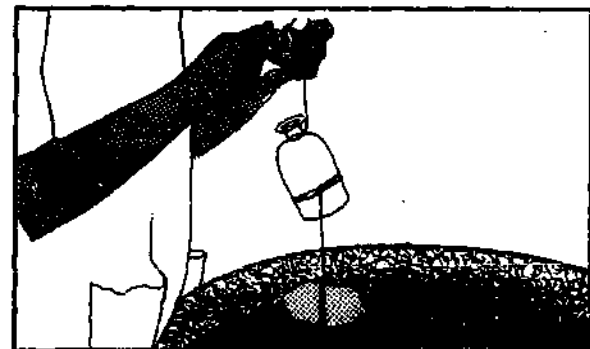

3. Immerse the bottle completely in the water at the bottom of the well.

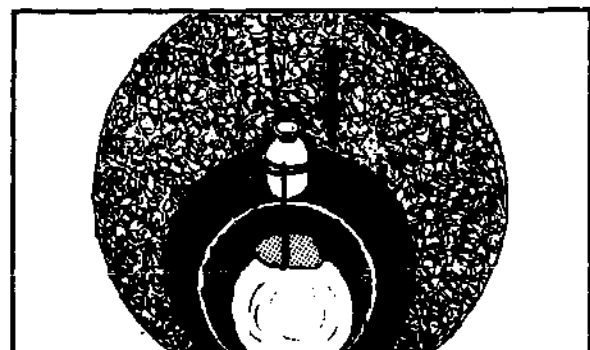

4. Rewind the string round the stick to bring up the bottle full of water.

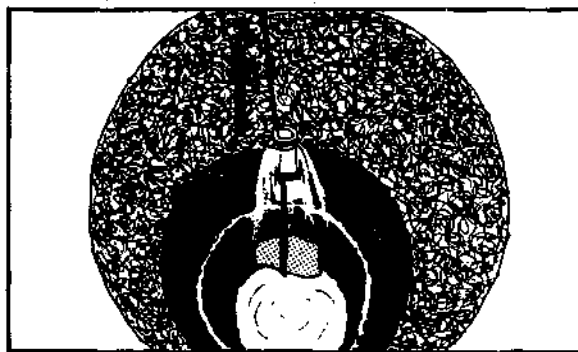

5. Pour off the top ¼ of the water collected in the bottle.

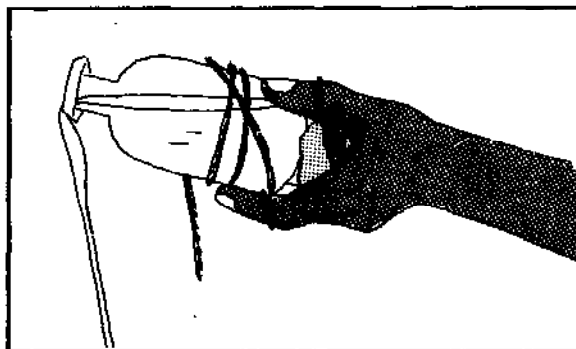

6. Replace the stopper.
Put the wrapping paper back over the stopper and tie around the neck of the bottle.
Fill in the details on the information sheet.

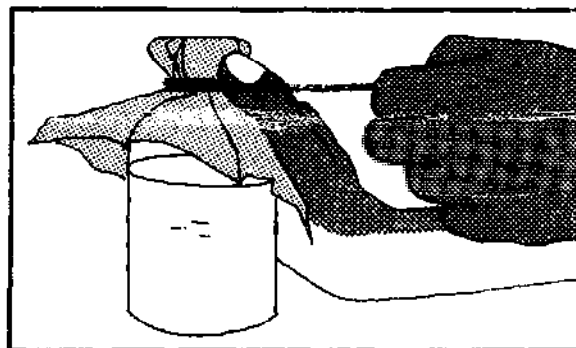

Sampling open water sources: lakes, streams, rivers, etc.

A. Preparation

1. A sterile 250 ml sampling bottle without sodium thiosulfate solution can be used.

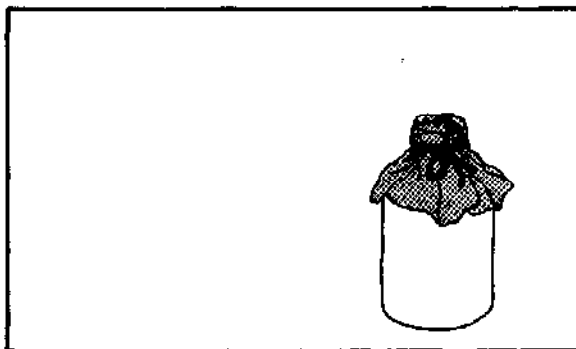

B. Taking the sample

1. Hold the bottle near the bottom and plunge it, neck downward, below the surface to a level of about 20 cm.

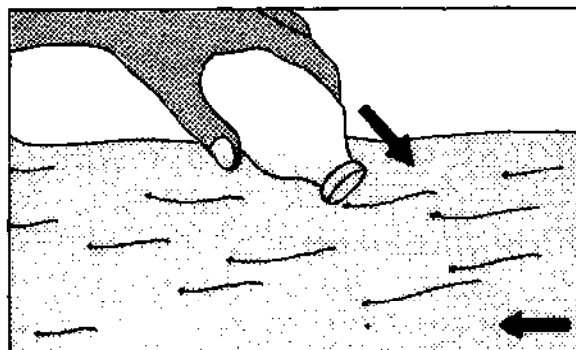

2. Turn the bottle until the neck points slightly upwards, with the mouth facing the direction of the current, if any.

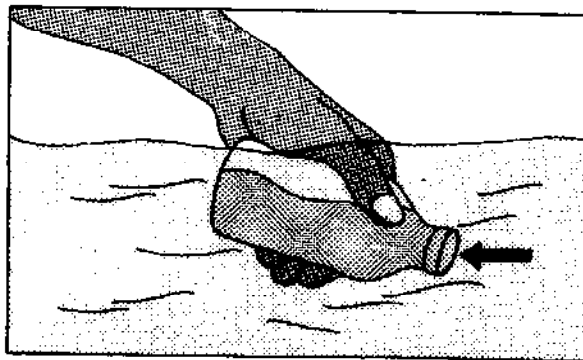

3. When the sample is collected, stopper the bottle. Put the wrapping paper back over the stopper and tie round the neck of the bottle. Label the bottle clearly and send it to the laboratory without delay.

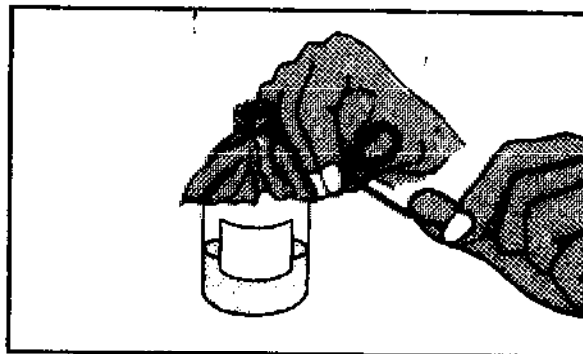

Dispatch

Dispatch the sample the same day. Keep water samples in the refrigerator before dispatch.

1. Pack in a wooden box:

- with a lid
- with wooden supports inside to keep the bottles upright.

Mark on the outside of the box:

UP

DOWN

URGENT

2. Special metal containers are available for the dispatch of water specimens without spillage or breakage.

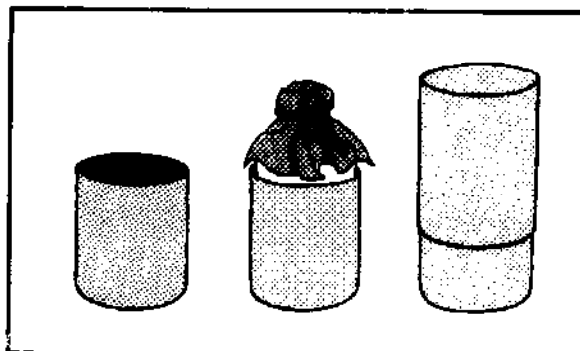

MODEL REQUEST FORM

This form must be filled in and sent with the water samples.

Water collected at							(locality)	(exact spot)
Source of supply:	Tap	Standpipe with pump	Well	Spring	Storage tank	River			
Is the water used for drinking?									
Are there latrines in the vicinity?		No	Yes: metres away					
Temperature of the water*									°C
Name of sampling technician				Signature					

*Water temperature at the site. Do not measure the temperature of the water in the sample bottle!

C. SEROLOGY

40. Dispatch of Serum and Dried Blood Specimens for Serological Examination

Serum

Serological examinations are carried out to determine whether the blood contains antibodies against various infectious diseases.

The blood is centrifuged to separate the serum from the clotted red cells. The serum must be kept sterile.

Dried blood

Some serological tests can be carried out on drops of blood collected on filter paper and dried. Just before the test, the blood is absorbed into a solvent.

SERUM

Materials

- Equipment for taking blood
- Centrifuge
- Sterile round-bottomed 10 ml centrifuge tube with screw cap or rubber stopper, sterile Vacutainer tube, or sterile dry syringe
- Sterile Pasteur pipettes
- Teats
- Forceps
- Sterile 10 ml bottle with airtight screw cap (rubber liner)
- Bunsen burner.

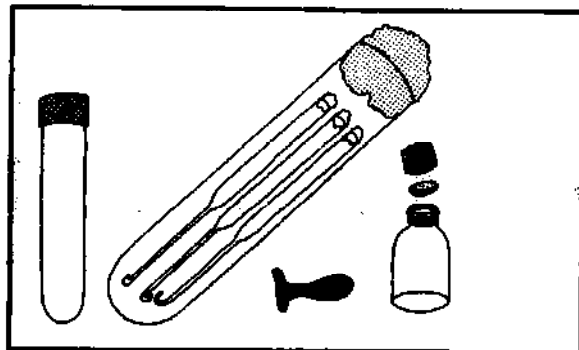

Collection of serum

1. Collect 10 ml of venous blood from the arm.

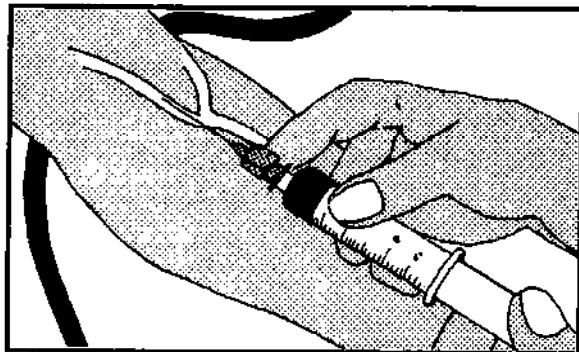

2. Remove the needle from the syringe. Expel the blood into the centrifuge tube. Stopper the tube of blood immediately.
3. Leave the blood to clot at room temperature.

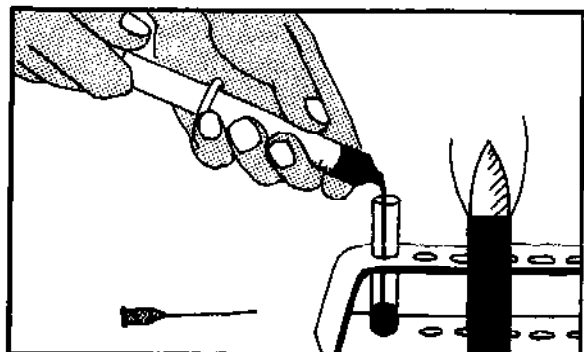

4. After 30 minutes to 2 hours, but not more, centrifuge at high speed for 10 minutes.

If no centrifuge is available, the blood can be left in the refrigerator for several hours; the clot will separate from the serum.

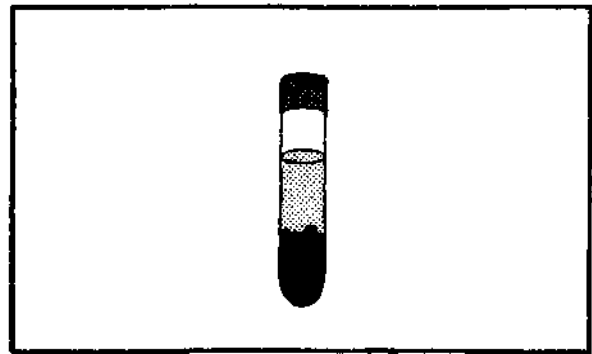

5. Unstopper the tube of blood. Draw off the serum into a sterile Pasteur pipette.

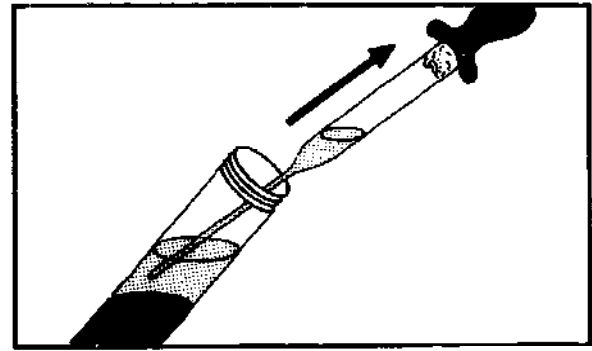

6. Expel the serum into the sterile 10 ml bottle. Replace the cap immediately.

For some serological examinations, an antiseptic preservative can be added to the specimen (e.g. thiomersal)*. Follow the instructions given by the reference laboratory.

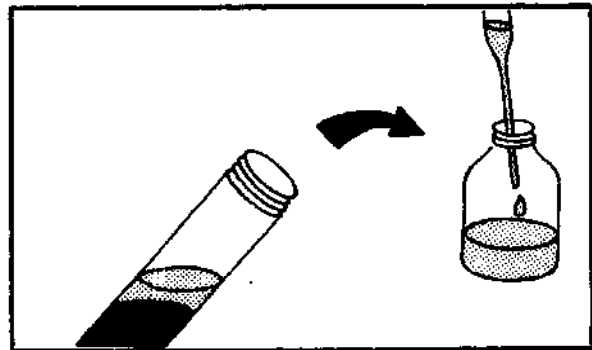

*Also known as merthiolate and as thimerosal.

Dispatch

1. Label the bottle with the patient's name and the date.
2. Seal the stopper with sticking plaster.
3. Wrap the bottle in absorbent paper or gauze.
4. Place in an aluminium container and wedge with 2 pads of cotton wool.
5. Place the container in a cardboard or wooden box.
6. Make sure that the transport time does not exceed 3 days.

Specimens sent by car should be packed in an ice box.



Preservation

Sera for most serological examinations can be kept in the freezer compartment of the refrigerator at -2°C or lower for at least 1 month.

COLLECTION AND DISPATCH OF DRIED BLOOD

Materials

- Sterile blood lancets
- Whatman No. 4 filter paper (or ordinary thin filter paper), cut into rectangles of 4 x 3 cm
- Small plastic bags, if available.

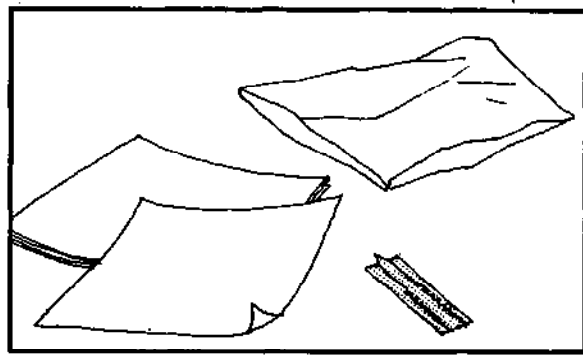

Method

1. Take capillary blood from the finger in the usual way (page 189).
2. Collect a large drop of blood in the middle of the strip of paper. Let the paper absorb the drop of blood completely. Leave to dry in the air.

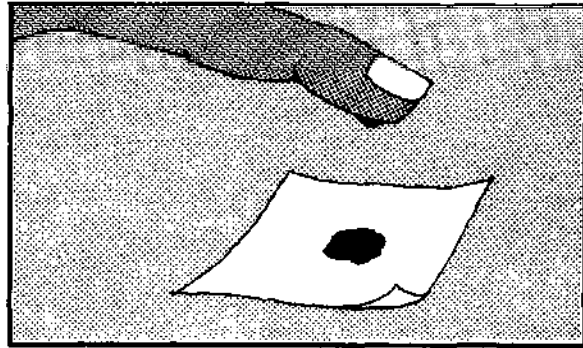

Dispatch

Write the patient's name and the specimen number on the paper. Place it in a small plastic bag or an ordinary envelope.

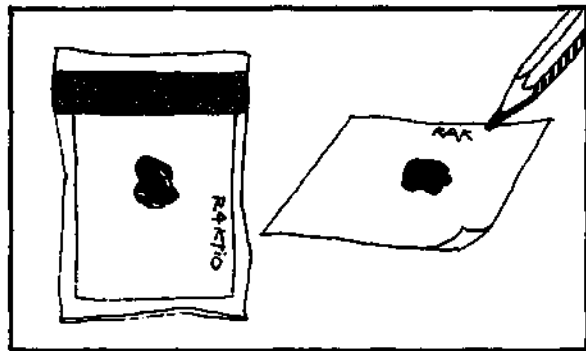

The strips of paper can also be stuck on pins set in small blocks of plastic foam in a box with numbered compartments (mass surveys).

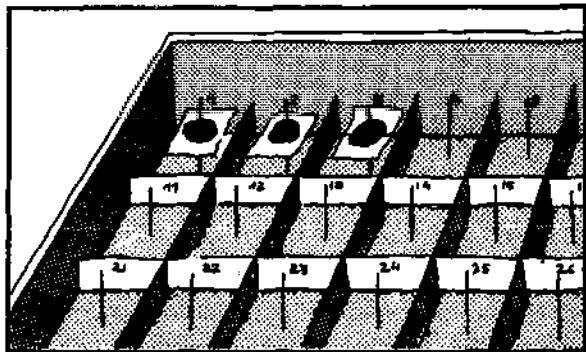

Preservation

Specimens will keep at least 2-3 weeks at room temperature in all climates.

Purpose

Dried blood is used in particular for :

- the serodiagnosis of yaws and syphilis (immunofluorescence test with treponemes)
- the detection of IgM in trypanosomiasis, etc.

41. VDRL Test

VDRL stands for Venereal Disease Research Laboratory, where the test was developed.

Principle

1. The serum is examined for the presence of *reagins*, antibodies that appear in the treponematoses (syphilis, yaws, pinta).
2. The presence of these antibodies is revealed by a lipoid (non-treponemal) antigen, which is a suspension of tiny particles.
3. The reaction between the antigen and the antibodies results in *flocculation* of the suspension (micro-agglutination) to tropical conditions the VDRL test should be preferably carried out at a temperature of 23-29 °C.

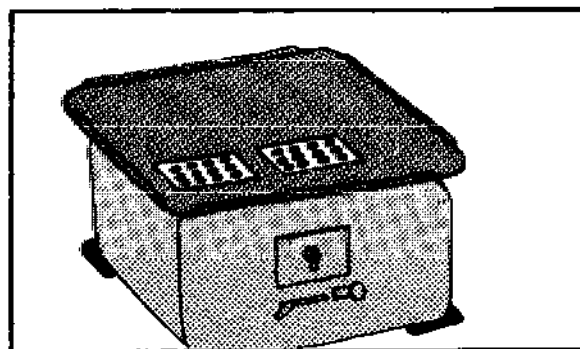
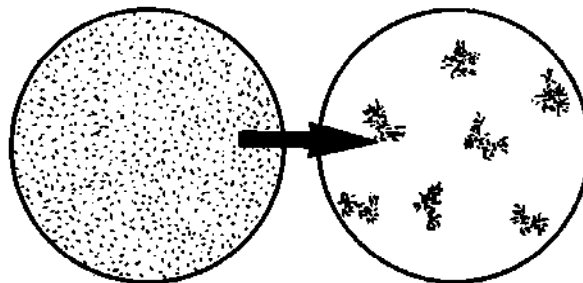

Materials

- Water bath at 56°C
- Rotating machine (180 r/min)
- Microscope with x 4 to x 6 eyepiece, x 10 objective and mechanical stage.
- Glass VDRL plates with flat-bottomed ceramic or paraffin rings 14 mm in diameter
- 2 ml syringe (insulin type)
- Special needle without bevel delivering 60 drops per ml (18-gauge (1.2 mm) needle sawn off at the tip or capillary Pasteur pipette calibrated to deliver 60 drops per ml)
- 0.2 ml pipettes graduated in 0.05 ml (or 1.0 ml pipettes graduated in 1/100)
- Beakers.

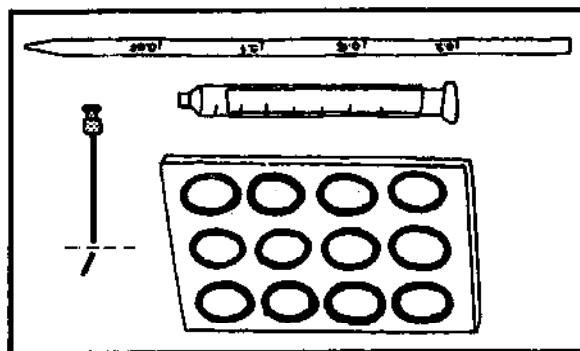

Reagents

VDRL antigen, prepared on the day of use.

Known positive sera: positive and weak positive controls

Known negative sera: negative control.

Preparation of antigen suspension for VDRL test

1. The antigen is an alcoholic solution of lipids (cardiolipin and lecithin) and cholesterol. These substances are not soluble in water.
2. The antigen suspension is prepared by mixing the antigen with the buffer solution for the VDRL test. The fats are precipitated when they come into contact with the water and form minute particles that go into suspension when the mixture is shaken. The solution should completely cover the bottom of the bottle.

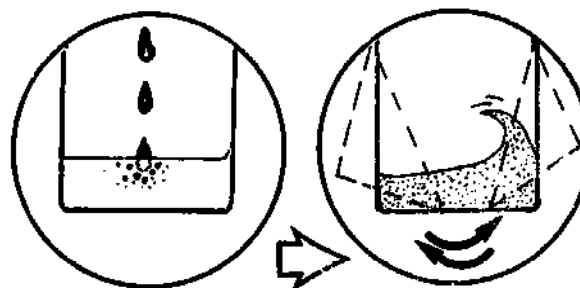

Materials for preparation of the antigen suspension

- 30 ml narrow-mouthed bottle with ground glass stopper, 35 mm diameter at the bottom
- 1 graduated pipette, 5 ml capacity
- 2 graduated pipettes, 1 ml capacity
- Watch with second hand
- VDRL antigen
- VDRL buffer solution, usually supplied with the antigen (reagent No. 11).

Examine the antigen by holding it against the light. If it contains particles or precipitate it should not be used.

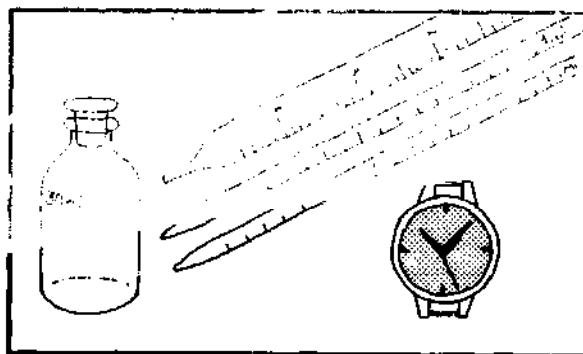

1. Check that the bottom of the bottle is perfectly flat inside. If not, discard the bottle.

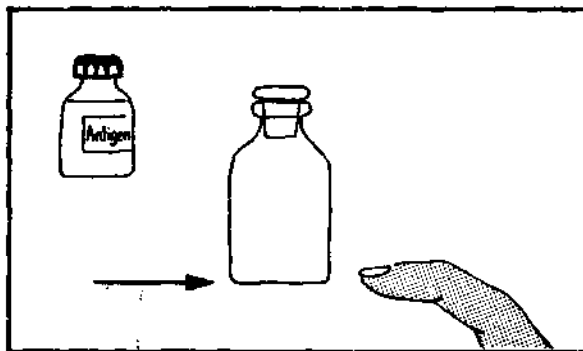

2. Using a 1 ml pipette, measure 0.4 ml of VDRL buffer solution, as follows:
 - place the tip of the pipette against the bottom of the bottle
 - let the solution flow into the bottle.

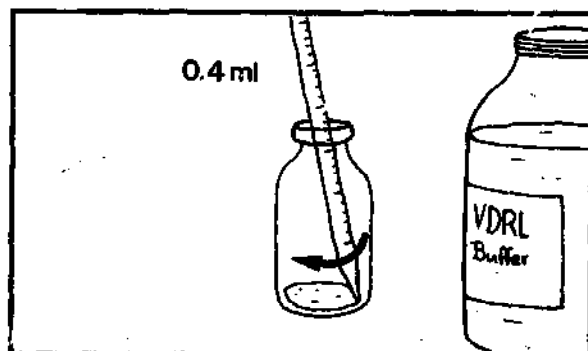

3. Using the 1 ml pipette, measure 0.5 ml of antigen into the lower half of a 1 ml pipette graduated to the tip. Check that the antigen in the pipette is perfectly clear (no precipitate).

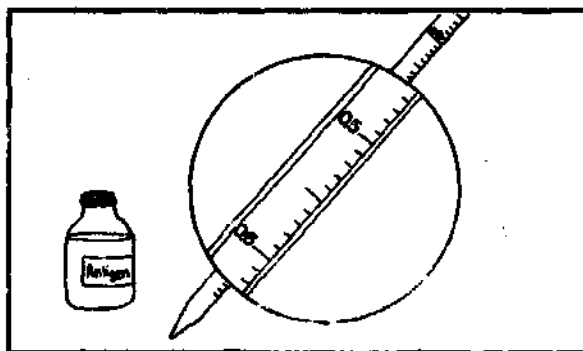

4. Keeping the mouth of the pipette tightly closed, insert the tip into the upper third of the bottle.

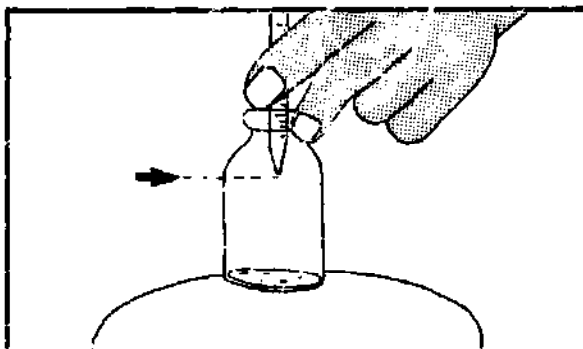

5. Begin rotating the bottle, held flat, on the bench top.

6. While continuing to rotate the bottle, gradually relax the pressure of the finger sealing the mouth of the pipette so that the 0.5 ml of antigen falls drop by drop without splashing up on to the pipette.

(This should take about 6 seconds, or 18-20 turns round a circle of 5 cm diameter.)

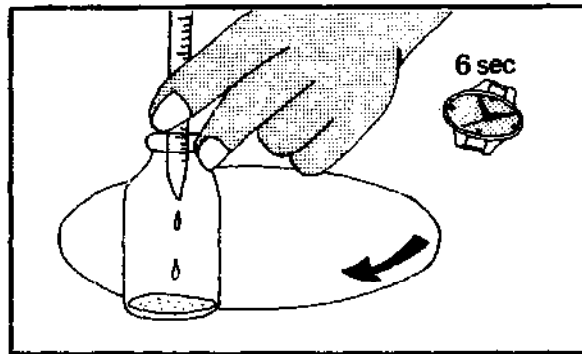

7. Blow out the last drop of antigen (without touching the solution with the pipette)

Continue to rotate the bottle, held flat, for a further 10 seconds.

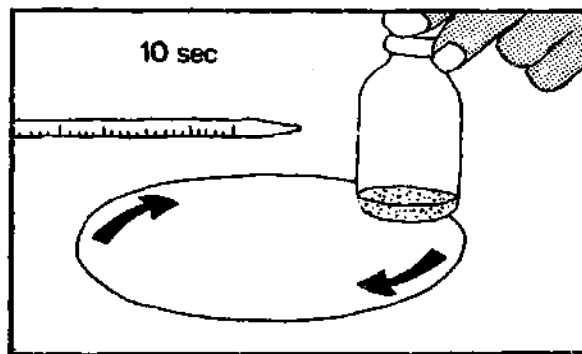

8. Using the 5 ml pipette, add at once:
- 4.1 ml of VDRL buffer solution.

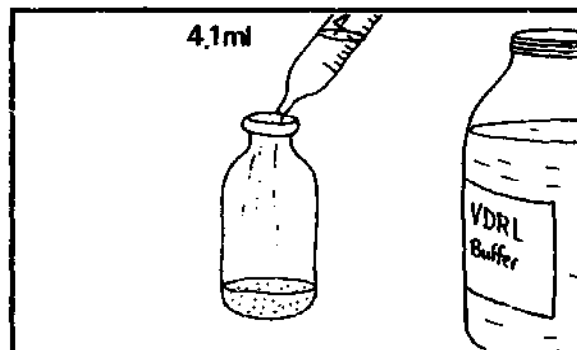

9. Replace the ground glass stopper in the bottle. Shake the bottle up and down about 30 times for 10 seconds.

The antigen suspension is ready for use and must be used the same day.

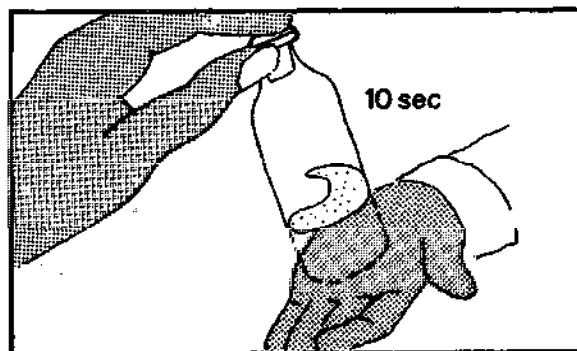

Preliminary testing of antigen suspension

1. The control sera of graded reactivity (known reactive, weakly reactive, non-reactive) are tested against the antigen suspension.
2. Reactions with control sera should produce the expected reactivity pattern. The non-reactive serum should show complete dispersion of the antigen particles.
3. Do not use an unsatisfactory antigen suspension.

A. VDRL SLIDE QUALITATIVE TEST ON SERUM

1. Examine the serum to be tested, to see if it is:

- clear
- cloudy
- haemolysed (pink; do not use).

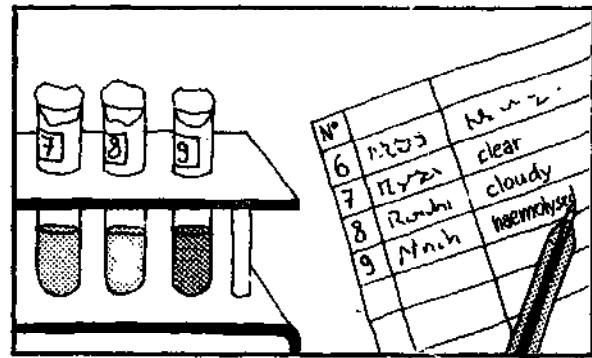

2. Set the water bath at 56 °C.

Leave the tubes (plugged with non-absorbent cotton wool and numbered) in the water bath for 30 minutes.

Examine all the sera when removed from the water bath and centrifuge again those in which there is a deposit.

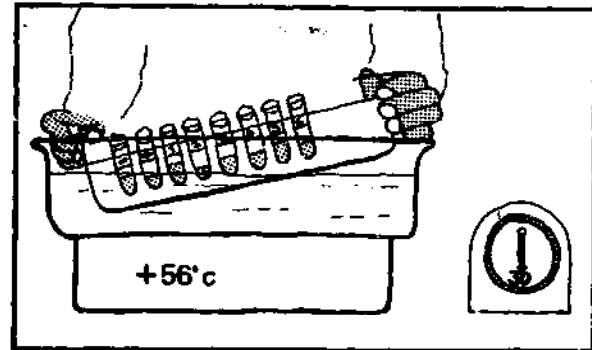

3. Meanwhile, check the speed of the rotating machine: 180 r/min, or 15 revolutions per 5 seconds.

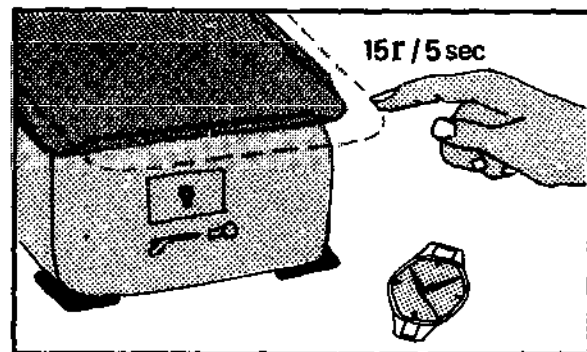

4. Number the rings on the VDRL plate, using a grease or diamond pencil, in the sequence shown in the diagram.

Make a note of the numbers of the tubes corresponding to the numbers of the rings.

For example:

Sodium chloride solution: ring 1
 Standard non-reactive serum: ring 2
 Standard reactive serum: ring 3.

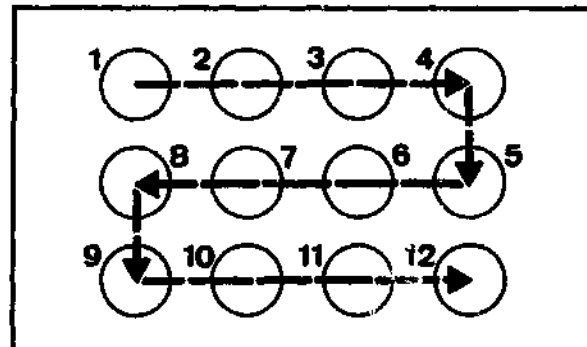

5. Leave the sera to cool to room temperature before starting the test (15 minutes after removal from the water bath).

6. Pipette into each ring:

- 0.05 ml of the corresponding serum.

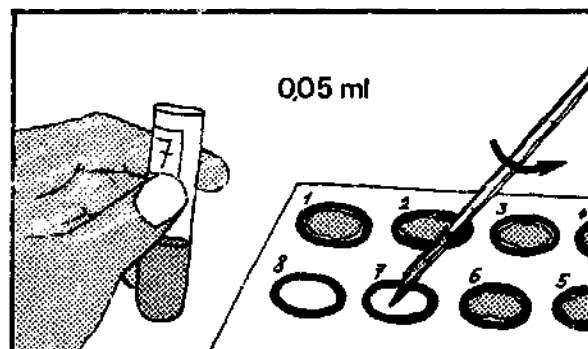

7. Shake the bottle of antigen suspension gently and immediately, in a single movement, draw about 0.5 ml of the suspension into the syringe with the specially prepared 18-gauge needle.

Let the 1st drop of suspension fall back into the bottle.

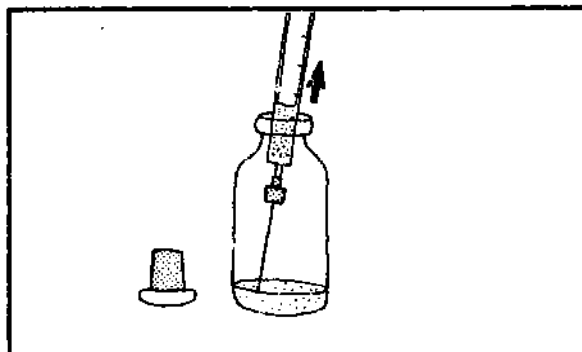

8. Add 1 drop of the suspension to each ring containing serum.

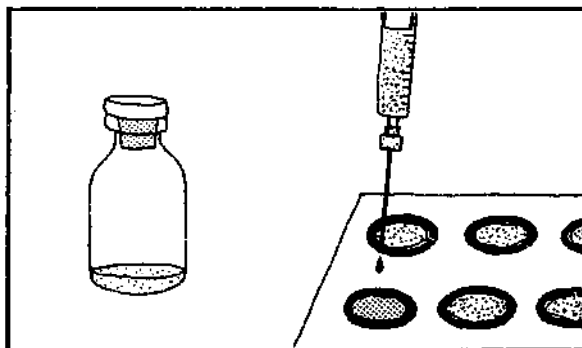

9. Place the plate on the rotating machine at once. Rotate for 4 minutes.

Alternatively, rotate the plate by hand, in the horizontal plane, at the same speed.

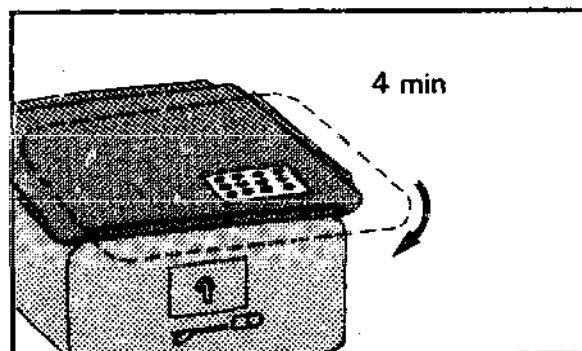

10. As soon as the 4 minutes are up, place the plate on the stage of the microscope.

Examine the rings in numerical order, under the x 10 objective (eyepiece x 10).

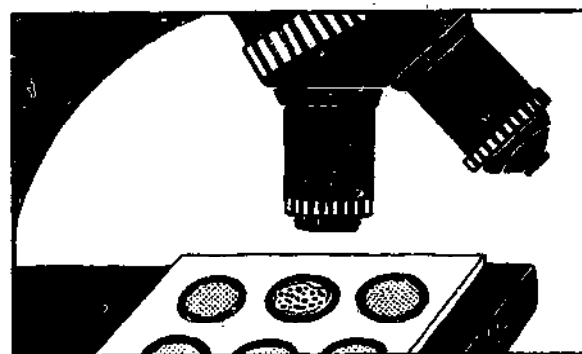

Microscope reading

Non-reactive serum (NR)

A homogeneous suspension of fine short needle-like particles.

Reactive serum (R)

Relatively large clumps of particles on a clear background.

Weakly reactive serum (WR)

Many small clumps among free particles that have not been agglutinated. Check this weak reaction by a quantitative VDRL test.

A prozone reaction is occasionally encountered. This happens when inhibition of reactivity occurs with undiluted serum and maximum reactivity is obtained only from diluted serum; thus a weakly reactive or non-reactive result in the qualitative test may be given by a serum that will be strongly reactive when diluted. All weakly reactive sera should be retested using the quantitative procedure before the results are submitted.

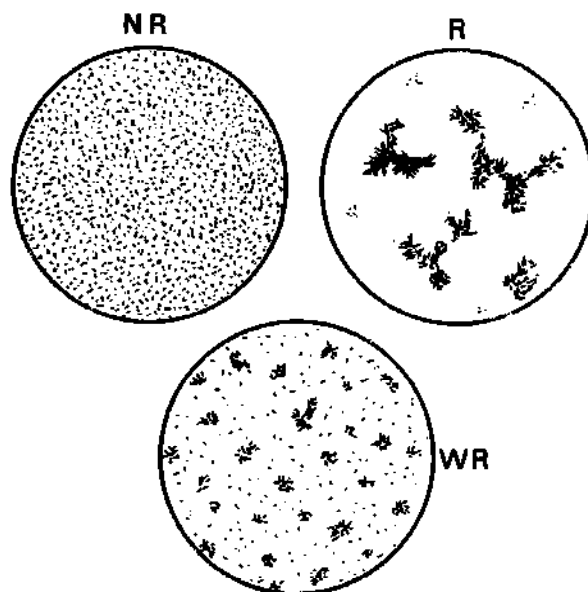

Record the results as follows

VDRL qualitative test:

- serum reactive
- serum non-reactive
- serum weakly reactive.

In cases of syphilis

the VDRL test normally gives positive results:

- 3 weeks after the appearance of the primary chancre, i.e.:
- 6 weeks after exposure to the infection.

Important: false positive reactions

Reagins may occasionally be found in small amounts in persons who have not contracted a treponematosis but whose sera give positive results. It is therefore advisable to carry out the quantitative VDRL test on all sera found reactive.

B. VDRL SLIDE QUANTITATIVE TEST ON SERUM

Retest quantitatively all sera that produce reactive and weakly reactive results in the qualitative VDRL slide test. The dilutions of the serum to be tested are: undiluted (1:1), 1:2, 1:4, 1:8, 1:16, and 1:32. Two tests may be set up on one slide.

Materials

Additional equipment needed for the quantitative test:

- Test-tubes and racks
- 0.2 ml pipettes graduated in 0.01 ml subdivisions
- 1.0 ml graduated pipettes
- 19-gauge (1.0-1.1 mm) needle without bevel (should deliver 75 drops of antigen suspension per millilitre, when syringe and needle are held vertically, but this

should be checked for each needle before testing is started)

- 23-gauge (0.6 mm) needle without bevel (should deliver 100 drops of sodium chloride solution per millilitre when syringe and needle are held vertically, but this should be checked for each needle before testing is started)
- sodium chloride solution.

Method

1. Place the tubes of serum for quantitation in the front row of a rack with a tube containing 0.7 ml of sodium chloride solution directly behind each.

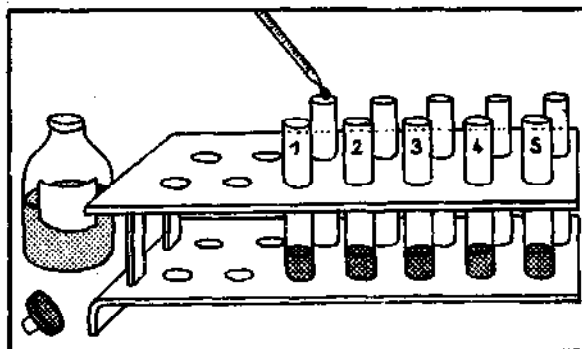

2. Prepare a 1:8 dilution of each serum as follows:

- add 0.1 ml of serum to the tubes containing 0.7 ml of sodium chloride solution

Use a 0.2 ml pipette graduated in 0.01 ml subdivisions.

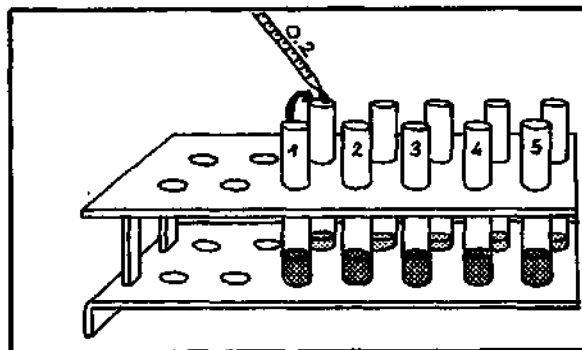

3. Mix thoroughly and leave the pipette in the dilution tube until all the dilutions are completed.

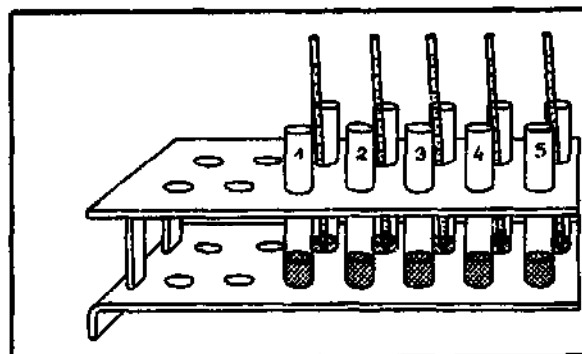

4. Using the pipette from the dilution tube, transfer 0.04 ml, 0.02 ml, and 0.01 ml of the 1:8 serum dilution into rings 4, 5 and 6 respectively of a new VDRL plate with the rings numbered as shown in the illustration. Blow out the remaining serum dilution into the dilution tube.

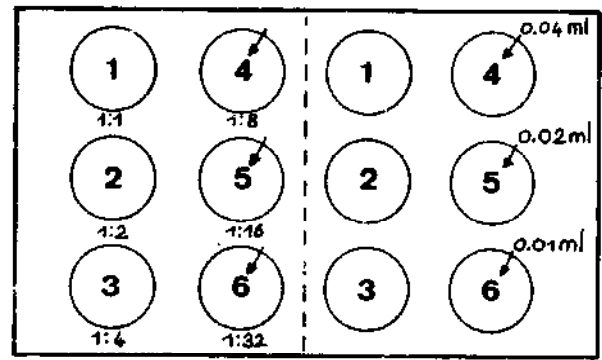

5. Using the same pipette, add 0.04 ml, 0.02 ml and 0.01 ml of the undiluted serum to rings 1, 2, and 3 respectively.

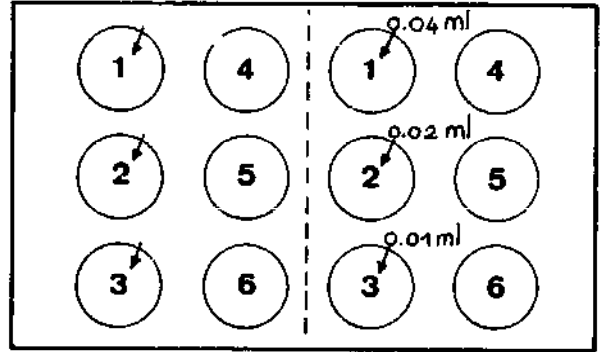

6. Add two drops of sodium chloride solution to rings 2 and 5 of each serum with a 23-gauge needle and syringe.

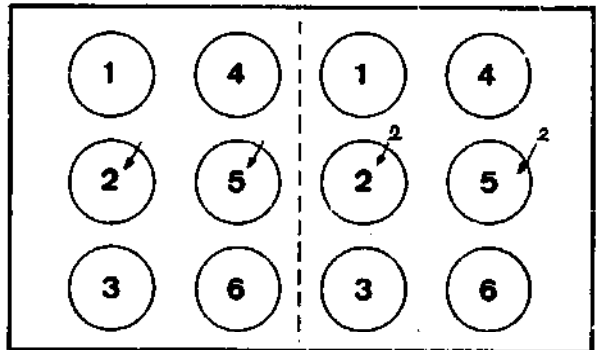

7. Add three drops of sodium chloride solution to rings 3 and 6 of each serum with a 23-gauge needle and syringe.

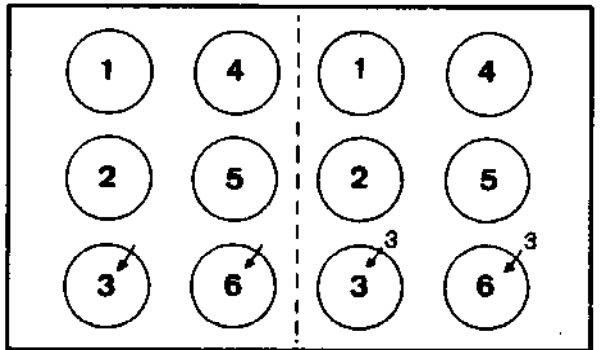

8. Rotate the plates gently by hand for about 15 seconds to mix the serum and solution.

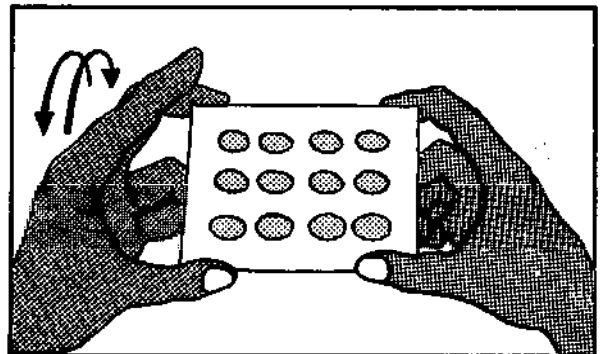

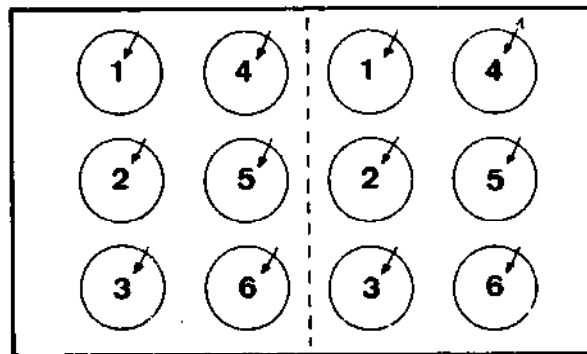

9. Add one drop of antigen suspension to each ring with the special 19-gauge needle and syringe.

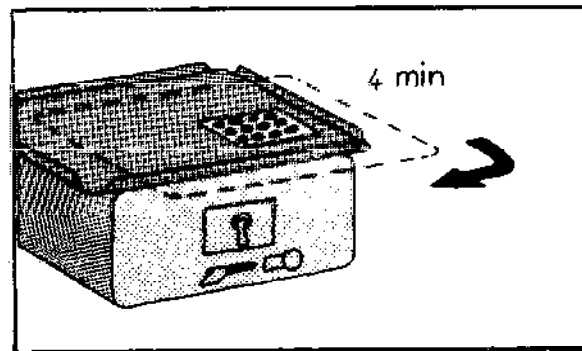

10. Rotate the plates for 4 minutes (at 180 r/min). Read the results microscopically immediately after rotation.

Results

Report the results in terms of the greatest serum dilution that produces a reactive result.

Example

Undiluted serum	Serum dilutions					
	1:2	1:4	1:8	1:16	1:32	
R	R	R	W	N	N	Reactive, 1:4 dilution
W	W	R	R	W	N	Reactive, 1:8 dilution
N (rough)	W	R	R	R	N	Reactive, 1:16 dilution
W	N	N	N	N	N	Weakly reactive, undiluted only

R = reactive
 W = weakly reactive
 N = non-reactive

D. MYCOLOGY

42. Pityriasis Versicolor: Direct Examination

Pityriasis versicolor is a common skin disease in hot climates, caused by the fungus *Pityrosporum furfur*. The face and body are covered with patches:

- pale and discoloured in black-skinned patients
- yellowish-brown in white-skinned patients.



MATERIALS

- Adhesive cellophane tape
- Slide
- Forceps
- Pad of gauze.

If possible, a 10 g/l (1%) aqueous solution of eosin (reagent No. 20). Otherwise, examine without staining.

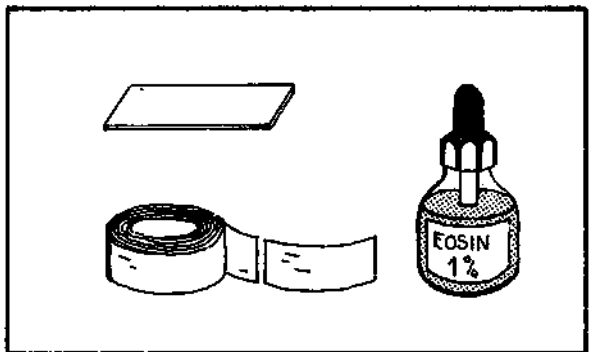

METHOD

1. Choose a rapidly developing patch of infected skin. Moisten it with a gauze pad dipped in the eosin solution.

Leave to dry for 1 minute.

(Do not take the specimen if talcum powder has been used on the skin. Wash first.)



2. Cut a strip of adhesive tape about 5 cm long. Place it over the patch so that it overlaps one edge.

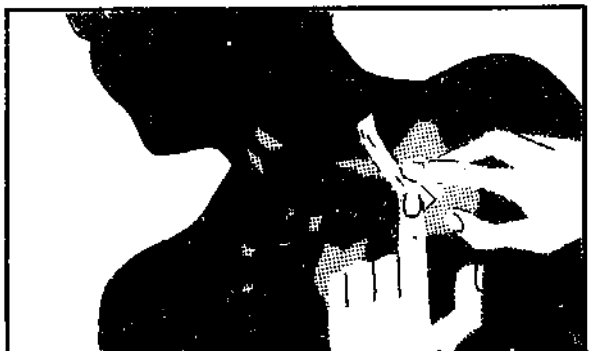

3. Stick the tape on the skin and press firmly from one end to the other, passing a tongue depressor or glass rod over it several times.

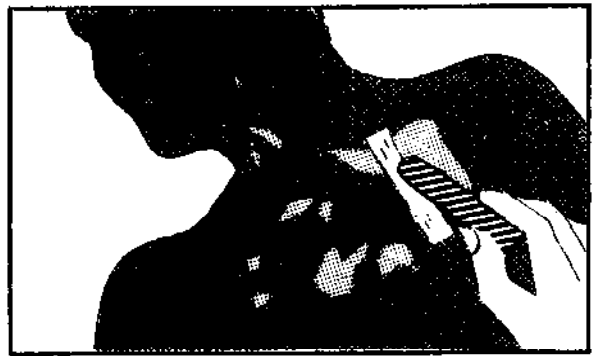

Pull the adhesive tape away with forceps. Place it at once on a slide, sticky side down.

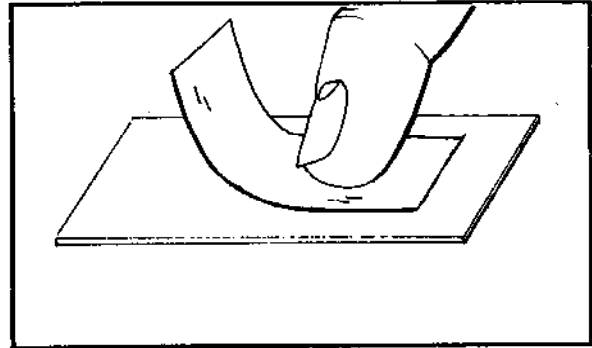

Examine the whole slide under the microscope (x 40 objective) until a cluster of large granules (the spores) is seen. They are white on a pink background if the skin was treated with eosin, and are also visible in unstained preparations.

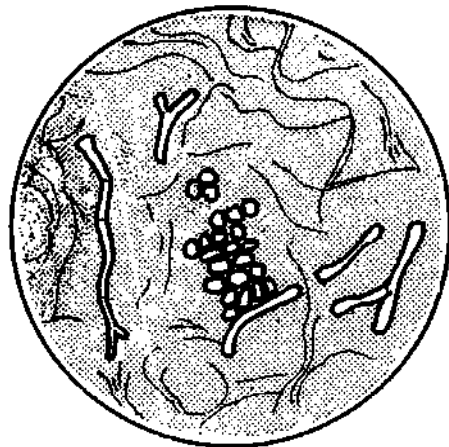

Change to the oil-immersion objective to examine the details:

(a) *The spores:*

- in a bunch or cluster
- round or slightly rectangular
- 3-8 μm in diameter
- rather thick wall
- budding sometimes visible.

(b) *Mycelium filaments* (more difficult to see):

- long rods, bent and twisted
- 20-40 μm long
- 5 μm wide
- resemble fingers and have branches.

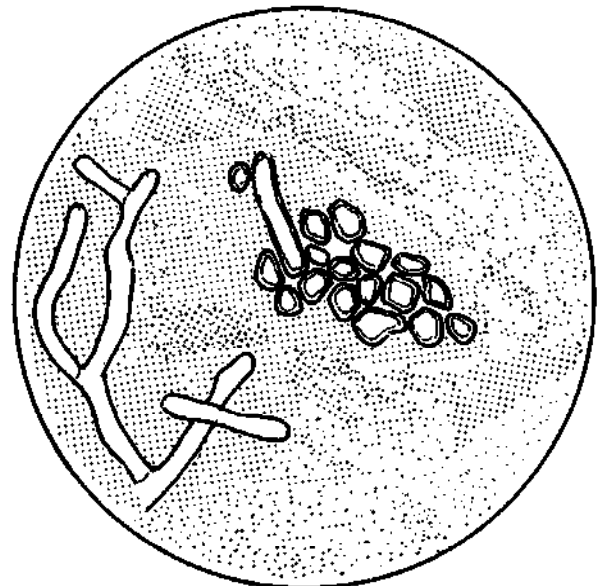

REPORTING THE RESULT

Direct examination for pityriasis versicolor: clusters of spores (and, if applicable, mycelium filaments) present.

Culture

No culture has yet been possible.

Staining with iodine solution. Iodine solution scales the skin and mycelium filaments are mainly found. The method is not recommended.

43. Tinea: Direct Examination

Tinea is an infection of the scalp caused by different fungi and mainly affecting children. Patients lose their hair in round patches of varying size.

In the laboratory the fungi can be detected by direct examination of hair under the microscope.

The fungi can also be cultured and identified in specialized laboratories (mycological culture).

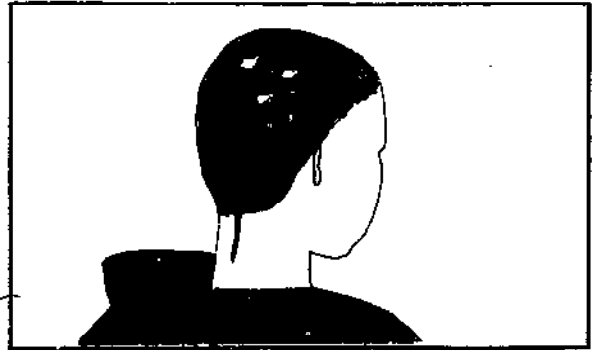

MATERIALS

- Sterile (flamed) tweezers
- Slide
- Coverslip
- Lactophenol cotton blue (reagent No. 34), if available
- 200 g/l (20%) potassium hydroxide (reagent No. 41)
- Spirit lamp.

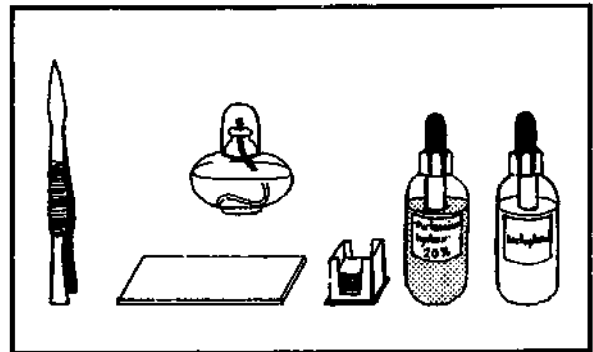

COLLECTION OF SPECIMEN

Choose a likely hair from inside the bald patch, but near the edge. Infected hairs are short, broken, twisted and duller than the rest; sometimes there is a sort of dry pus at their roots.

Apply the tweezers right at the base of the hair. Pull the hair out firmly but gradually. Affected hairs are usually loosely fixed in their follicles and brittle.

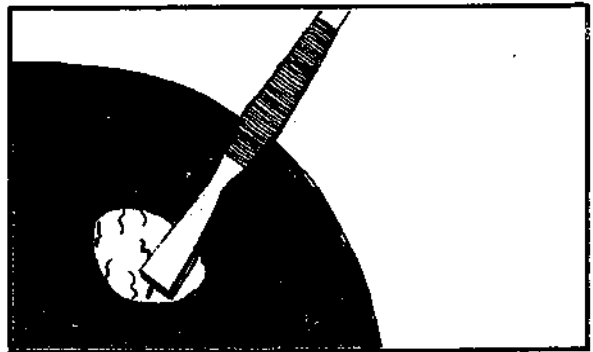

Place the hair in the centre of a slide. It is advisable to take hairs from several patches (about 10 hairs altogether). Three or four can be placed on one slide.

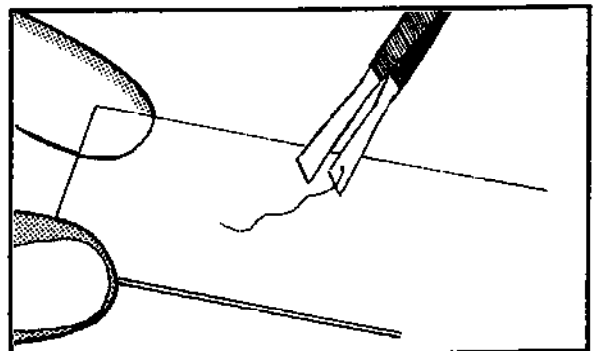

PREPARATION OF SLIDES

1. Place one drop of lactophenol blue or 20% potassium hydroxide on the hairs. Cover with a coverslip.

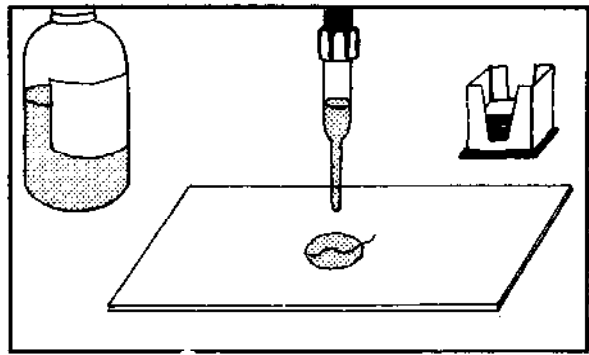

2. Pass the slide rapidly through a Bunsen burner flame 4 times, to warm it (or hold it over the flame of a spirit lamp for ½ minute).

Warning: The stain and particularly the potassium hydroxide may boil suddenly and spit. Keep your face well away from the slide when heating it.

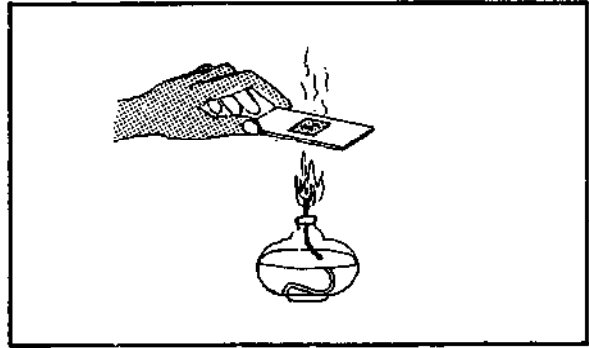

MICROSCOPICAL EXAMINATION

Examine under the x 40 (high power) objective, then use oil immersion if necessary. Look for spores (large round granules with a transparent membrane) round or inside the hair.

1. Spores found outside the hair

These are called *ectothrix*. Forming a sheath around the base of the hair the following may be found:

- (a) *Small-spored ectothrix*: very small spores (2–3 μm) in several layers (microspores)
- (b) *Large-spored ectothrix*: large spores (5–8 μm) in 1 or 2 layers (megaspores).

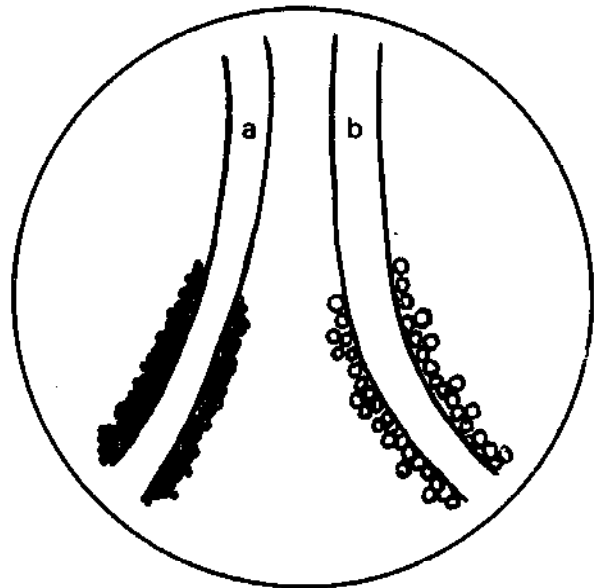

2. Spores and filaments found inside the hair

These are called *endothrix*. The following may be found in the hair:

- (a) *Endothrix*: chains of large spores (4–8 μm), often in conjunction with mycelium filaments.
- (b) *Mycelium filaments*: clear thick filaments 4–5 μm broad, twisted and fragmented, surrounded by air bubbles in the hair, particularly in potassium hydroxide preparations. On the scalp, small yellow crusts form at the base of each infected hair.

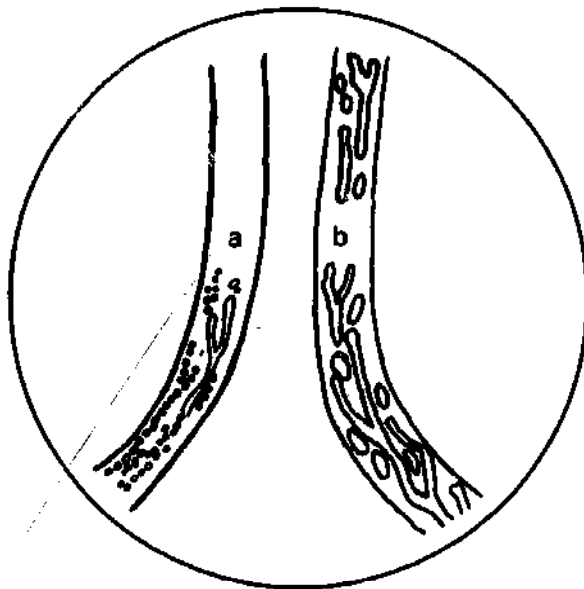

Important:

These examinations can be difficult, particularly in the early stages of the disease.

If in doubt, take an apparently normal hair of the same length and place it next to the infected hair on the slide for comparison. Only culture can establish the exact species of fungus involved.

RECORDING THE RESULT

Direct microscopic examination of hair:

- Ectothrix microspores present.
- Endothrix filaments present with air bubbles in the hair.

Collection of specimens using ultraviolet light

In specialized laboratories, hair specimens are collected in a dark-room. The patient's head is examined under ultraviolet light. The hairs infected with tinea are often fluorescent and thus easily seen.

PART III

A. EXAMINATION OF URINE

1. Collection of Urine Specimens and Appearance

Urine specimens must be collected:

- in the correct way
- in suitable containers.

If the specimen is not collected properly, the laboratory findings will be unreliable.

TIME OF COLLECTION

In hospital: where only one specimen is needed, the best time to collect it is first thing in the morning (the urine is concentrated).

At the dispensary: have the patient pass the specimen in the dispensary, if possible.

Schistosomiasis: the best time for collection of specimens to be examined for schistosome eggs is between 11 h and 17 h (see page 178).

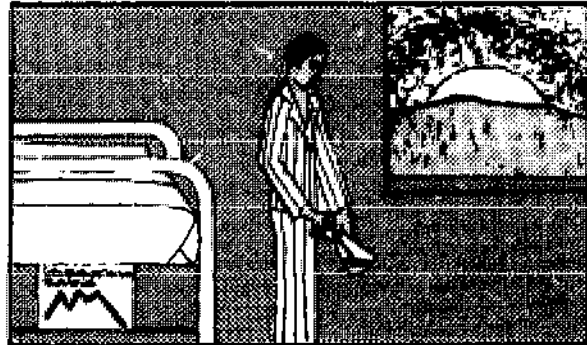

24-HOUR SPECIMENS (occasionally requested)

The urine is collected in a clear 2-litre bottle with a stopper. The patient gets up and urinates; this urine is not collected. All the urine passed during the rest of the day is collected in the bottle. All the urine passed during the night is also collected in the bottle. The patient gets up and collects the first urine of the morning in the bottle. The bottle should be taken immediately to the laboratory. Measure the volume of urine with a measuring cylinder and record it.

SPECIMEN CONTAINERS

For urine collected in the patient's room use a:

- wide-mouthed bottle with stopper.
- (If the specimen is intended for bacteriological examination a sterile container must be used.)

For urine collected in the laboratory use a:

- clean conical urine jar
- or any clean glass container or bottle.

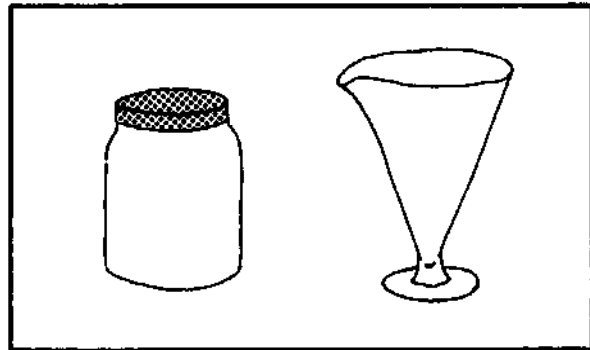

QUANTITY OF URINE TO COLLECT

Collect at least 50 ml in a suitable bottle.

PERSONAL HYGIENE BEFORE COLLECTION OF URINE

- Women:** Patients should wash the genital area in all cases.
Avoid collecting urine specimens during the menstrual period.
- Men:** Washing is necessary only for bacteriological examinations.

COLLECTION METHODS

Midstream specimens:
These are required for all examinations.

3 separate specimens:
These are sometimes requested by the physician. The patient urinates without stopping into 3 successive urine jars, marked 1, 2 and 3. It can then be determined, for example, which jar contains the most blood, pus, etc.

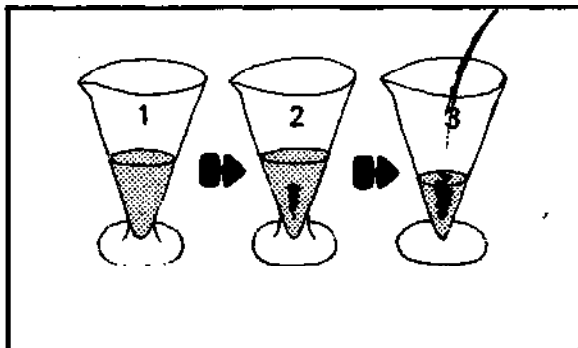

Catheter specimens:

Collection of urine using a catheter must be carried out by a qualified physician or nurse. The procedure is used for certain bacteriological tests, mainly in women. Usually, however, a specimen collected in the normal way following thorough local cleansing is acceptable for this purpose.

Infants:

Urine can be collected into a plastic bag with an adhesive mouth. The bag is fixed around the baby's genitalia and left in place for 1-3 hours, depending on the examination requested. Colostomy bags can be used.

APPEARANCE OF THE URINE

Describe the appearance of the urine:

- the colour, whether yellow, dark yellow, brown or colourless
- whether clear or cloudy.

2. Specific Gravity and pH of Urine

SPECIFIC GRAVITY (SG)

Specific gravity is measured by means of a urinometer calibrated from 1.000 to 1.060. (The specific gravity of distilled water is 1.000 at a temperature of 20 °C).

The temperature of the urine must also be measured for correct calculation of the specific gravity.

Value of the test

The specific gravity of urine varies according to kidney function.

- Concentrated urine = high SG.
- Dilute urine = low SG.

Materials

- 1 urinometer
- 1 thermometer (0-50 °C)
- 1 measuring cylinder (50 ml).

At least 40 ml of urine is required.

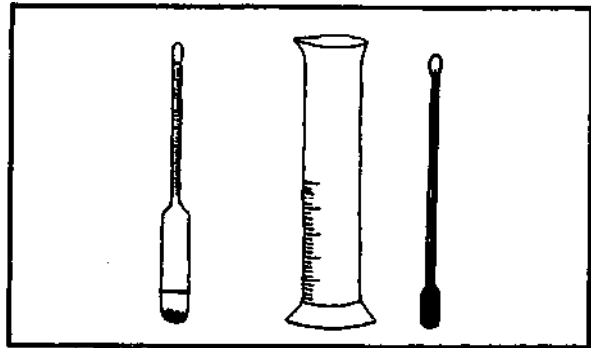

Method

1. Pour about 40 ml of urine into the cylinder.
2. Lower the urinometer gently into the urine and release.
3. Wait for it to settle. It must not be in contact with the sides or bottom of the cylinder.

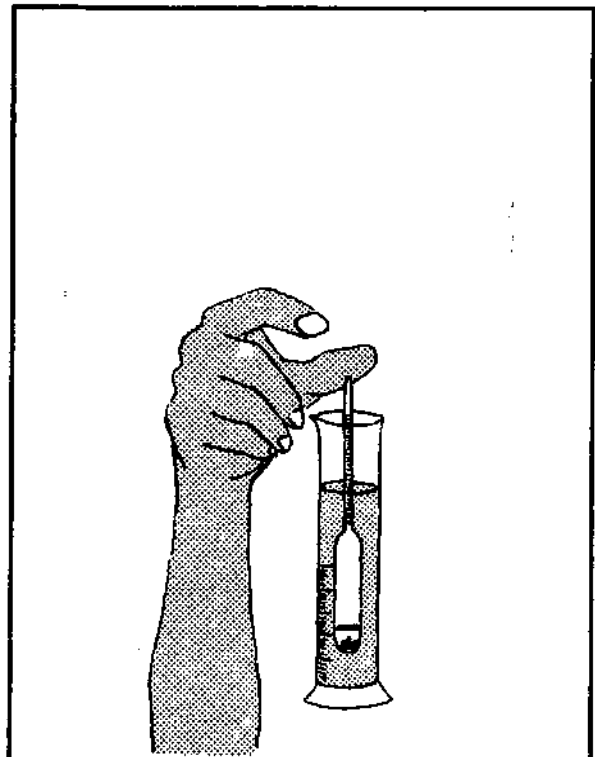

4. Read off the SG given on the scale at the surface of the urine (lowest point of the meniscus).
5. Remove the urinometer. Take the temperature of the urine at once with the thermometer.

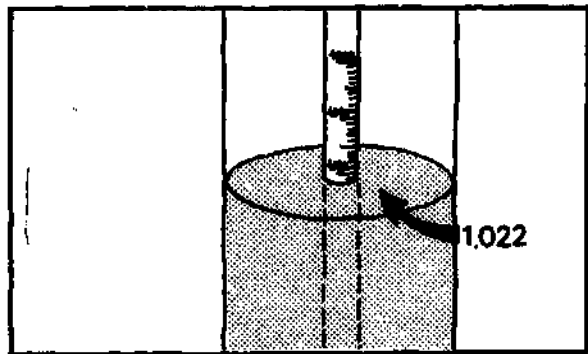

Calculation

Check the temperature at which the urinometer is calibrated (marked on the instrument by the manufacturer). It is usually 20 °C.

The temperature of the urine has been recorded.

Add to the SG recorded:

- 0.001 for every 3 °C that the urine temperature is above the calibration temperature.

Alternatively, subtract from the SG recorded:

- 0.001 for every 3 °C below the calibration temperature.

Example

The urinometer is calibrated at 20 °C.

The temperature of the urine is 26 °C.

The SG measured is 1.021.

The temperature of the urine is 6 °C higher than the calibration temperature.

Add to the SG figure:

$$\frac{6}{3} \times 0.001 = 2 \times 0.001 = 0.002$$

The actual SG of the urine, therefore, is:

$$1.021 + 0.002 = 1.023.$$

Results

Normal SG: 1.020 (normal range: 1.010–1.025).

Low SG: below 1.010* (kidney or endocrine disorder).

High SG: above 1.025 (glycosuria, proteinuria).

*A low figure is of no significance if the patient has drunk a large amount of liquid before the test.

Checking the urinometer

Every 3 months check the accuracy of the urinometer in distilled water at the temperature of calibration. The reading should be 1.000.

MEASUREMENT OF pH

Value of test

Normal freshly passed urine is slightly acid, with a pH of around 6.0.
In certain diseases the pH of the urine may increase or decrease.

Principle

Coloured indicator papers are dipped in the urine.
The colour changes according to the pH.
The papers are then compared with a standard control chart giving the corresponding figures.

Materials

- Watch glasses
- Dropper
- Forceps
- Universal indicator papers (for measuring pH from 1 to 10)
- Indicator papers of limited pH range:
for the 5.0-7.0 range and for the 6.0-8.0 range.

The urine tested must be *fresh*.

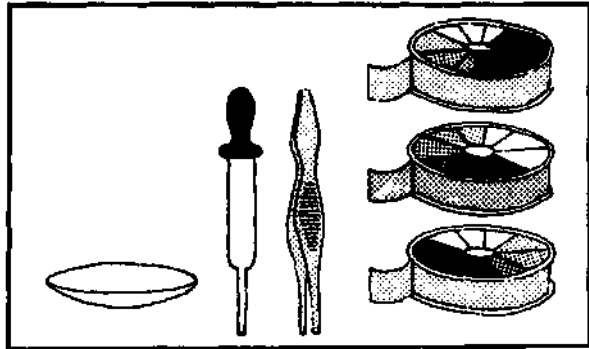

Method

1. Place in a watch glass 1 strip of universal indicator paper (pH 1-10).
Let a few drops of fresh urine fall on to the paper.

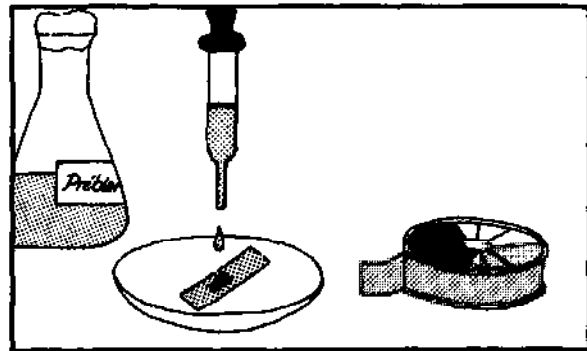

2. Pick the strip of paper up with forceps.
Compare the colour obtained with those shown on the standard chart. Read off the pH unit given for the colour most closely matching the test paper.

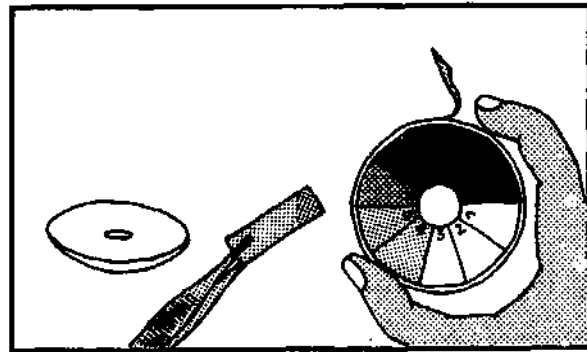

3. According to the result obtained, select a strip of indicator paper for the corresponding limited range.

Example:

- pH 6: indicator paper for the range 5.0-7.0
- pH 8: indicator paper for the range 6.0-8.0.

4. Repeat the test in another watch glass, using the limited-range paper.
Read off the pH of the urine on the standard chart.
Example: pH = 6.2; or pH = 7.5.

The test paper can also be dipped directly into the urine in the receptacle to obtain a reading of the pH.

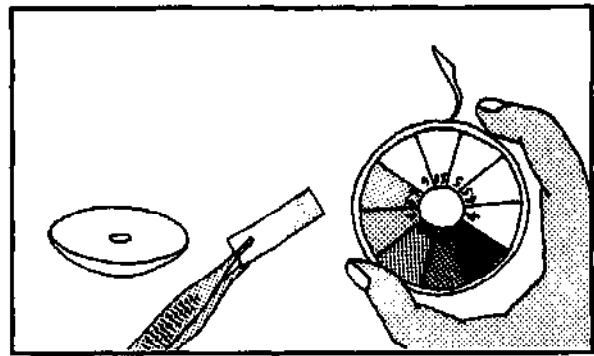

Results

Normal pH about 6.0 (limit of normal range from 5.0 to 7.0 during the day).

Acid pH 4.5-5.5 (if persistent: some forms of diabetes, muscular fatigue, acidosis).

Alkaline pH 7.8-8.0 (infections of the urinary tract, vegetarian diet).

pH and crystalline deposits

Determination of the pH of urine is useful for the identification of crystalline deposits (see pages 332-335).

Some crystals are deposited in acid urine only, others in alkaline urine only.

For example:

- Acid urine: oxalates, uric acid.
- Alkaline urine: phosphates, carbonates.

Reminder: Acid fluids have a pH of 0-7 (0 being the most acid).
Alkaline fluids have a pH of 7-14 (14 being the most alkaline).

3. Detection and Estimation of Glucose in Urine

Principle

Glucose (sugar found in the urine of diabetics) is a reducing substance: it reduces the *blue* copper sulfate of Benedict solution to *red* copper oxide, which is insoluble.

BENEDICT METHOD

Materials

- Pyrex test-tubes
- Wooden test-tube holder
- Beaker
- Bunsen burner
- Penicillin bottles
- Pipette
- Benedict qualitative solution (reagent No. 6).

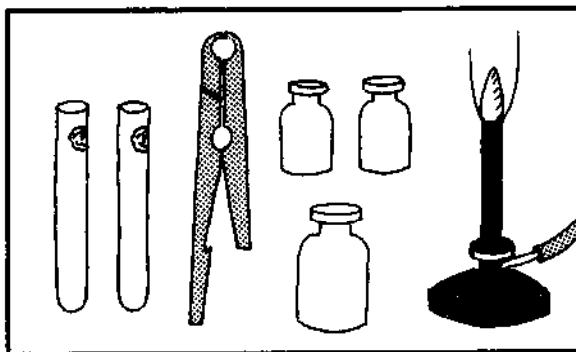

Method

1. Pipette 5 ml of Benedict solution into a test-tube.

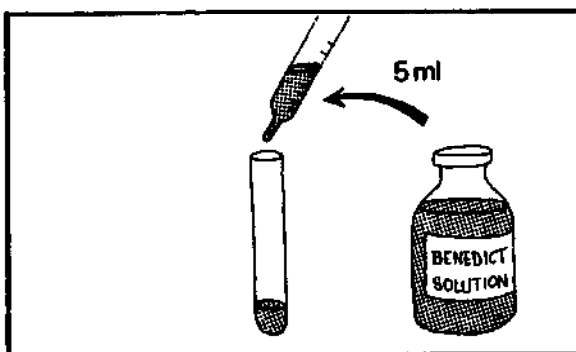

2. Add 8 drops of urine and mix well.

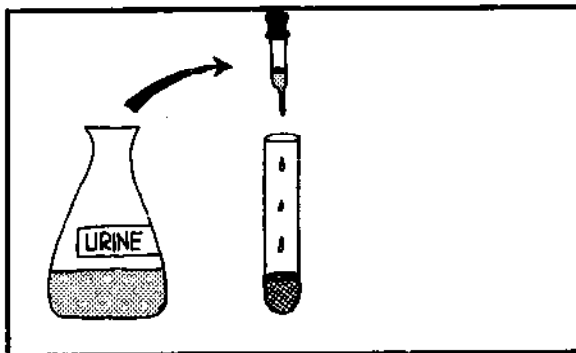

3. Boil over a Bunsen burner or spirit lamp for 2 minutes, or stand the tube in a beaker or can of boiling water for 5 minutes.

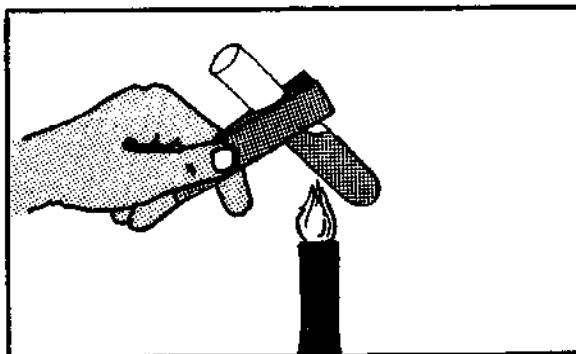

4. Leave the mixture to cool to room temperature.

Reading the result

Examine the mixture for any colour change and for precipitate.

Colour	Result (glucose present)	Approximate concentration (mmol/litre)
Blue	Negative	0
Green	A trace	14
Green with yellow precipitate	+	28
Yellow to dark green	++	56
Brown	+++	83
Orange to brick-red	++++	111 or more

Note: For detecting sugar in urine using reagent strips, see page 323.

4. Detection and Estimation of Protein in Urine

DETECTION OF PROTEIN IN URINE

METHOD USING 30% SULFOSALICYLIC ACID

Principle

When sulfosalicylic acid is added to urine containing protein, a white precipitate is formed.

Urine

The urine must be clear. If it is cloudy, filter it through filter paper, or use the supernatant fluid from a centrifuged urine specimen.

Materials

- Test-tubes
- Graduated 5 ml pipette
- Sulfosalicylic acid 300 g/l aqueous solution (reagent No. 51).

Method

1. Pipette 5 ml of urine into a test-tube.

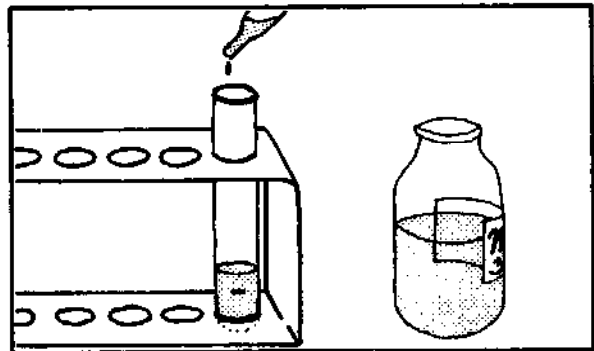

2. Using a dropping pipette, add 2 drops of sulfosalicylic acid solution to the urine.

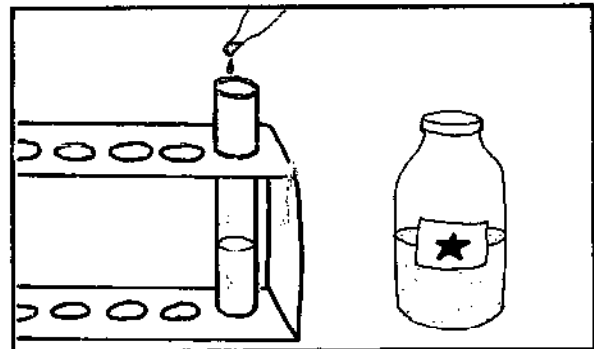

3. Compare with a tube of untreated urine against a black background.

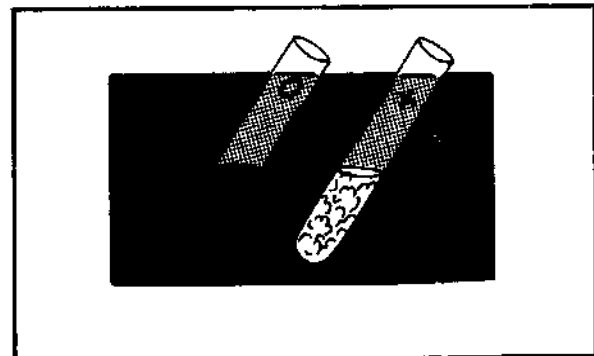

Results

Positive result

A white precipitate forms on addition of the reagent. This is a useful technique when large numbers of urine specimens have to be tested. Report the results as follows:

+	trace
++	small amount
+++	moderate amount
++++	large amount (opaque).

Negative result

No white precipitate forms on addition of the reagent.

Note: For the detection of protein using reagent strips, see page 323.

ESTIMATION OF PROTEIN IN URINE

Principle

This is a quantitative test using the sulfosalicylic acid method and protein standard tubes (proteinometer) as a visual comparison method for estimating albumin.

Materials

- 30 g/l (3%) sulfosalicylic acid solution (reagent No. 52)
- protein standard tubes.

Method

1. Pipette 1 ml of urine into a small tube of the same bore size as that of the standard tubes.
2. Add 3 ml of the sulfosalicylic acid solution. Mix and leave for 5 minutes.

3. Compare the cloudiness of the test with that of the standard tubes.

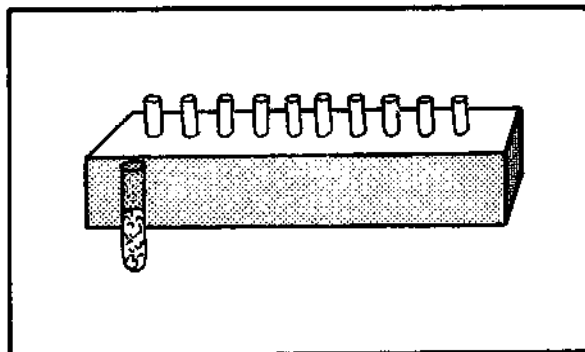

Results

Report the amount of albumin in g/l.* If the reading is over 1 g/l, the urine is diluted with sodium chloride solution and the test repeated, with the necessary adjustments in the calculations.

Example:

For a 1 in 4 dilution of the urine, use 0.25 ml urine and 0.75 ml of sodium chloride solution. Mix. Multiply the result obtained by 4.

*To convert values in mg/100 ml to values in g/l, divide by 100.
Example: $100 \text{ mg}/100 \text{ ml} \times 0.01 = 1 \text{ g/l}$.

5. Bile Pigments in Urine

Value of test

The bile secreted by the liver contains greenish-yellow substances: bile pigments.

In certain liver diseases (jaundice), anaemias and infectious conditions, bile pigments may pass into the blood stream and be excreted in the urine.

Principle

When iodine (Lugol iodine solution or tincture of iodine) is added to urine containing bile pigments, a green colour is produced.

A. LUGOL IODINE TEST

Materials

- Test-tubes and rack
- 10 ml measuring cylinder
- Lugol iodine solution (reagent No. 36)
- Dropping pipette.

Method

1. Pour into a test-tube:
 - 4 ml of urine.

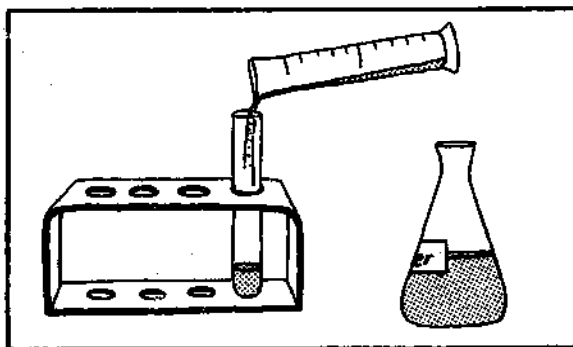

2. Add:
 - 4 drops of Lugol iodine solution.

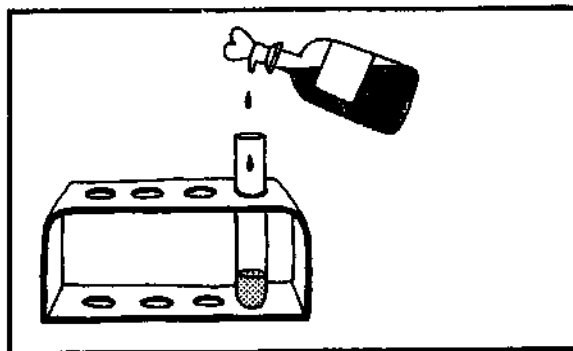

3. Shake the tube.
Observe the colour produced at once.

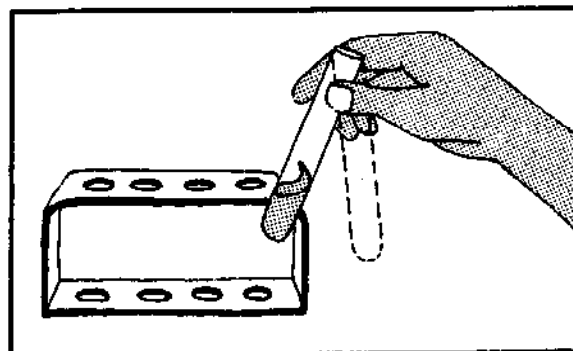

Results

Negative result

Faint yellowish-brown colour.

Positive result

Green colour:

- pale green: +
- intense green: ++

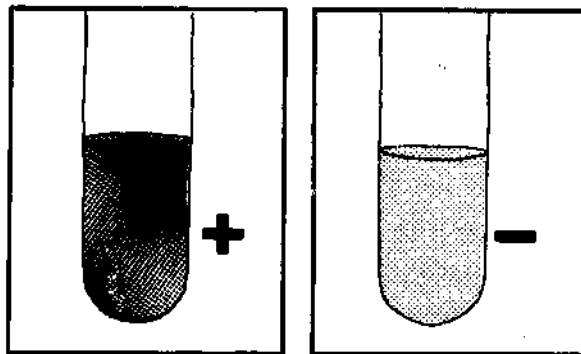

B. TEST USING FOUCHET REAGENT

This is a more sensitive test and will confirm results obtained by the iodine technique.

Materials

- Test-tubes
- Funnel
- Filter paper
- Dropping pipette or drop bottle
- 10 ml measuring cylinder
- 100 g/l (10%) barium chloride aqueous solution (reagent No. 5).
- Fouchet reagent (reagent No. 27).

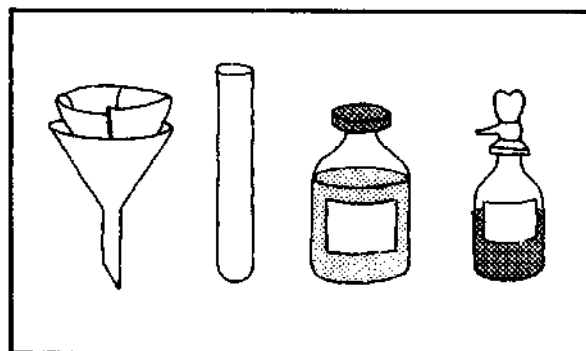

Method

1. Mix in a test-tube:
 - 5 ml of urine
 - 2.5 ml of barium chloride solution.

A precipitate forms.

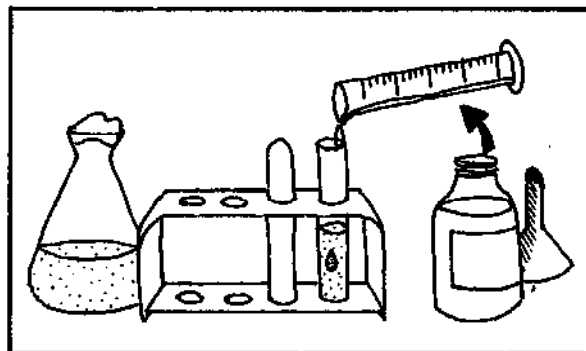

2. Filter the mixture.

The precipitate (which contains the bile pigments) remains on the filter paper.

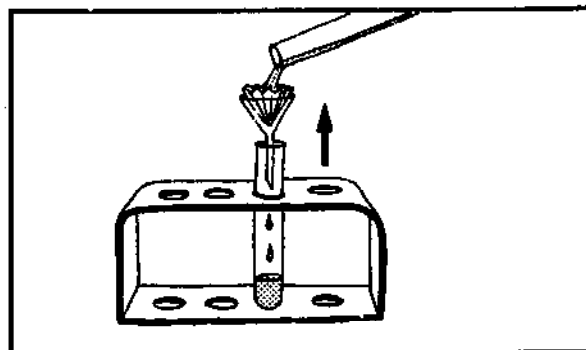

3. Unfold the filter paper.

Add to the precipitate on the filter paper:
– 2 drops of Fouchet reagent.

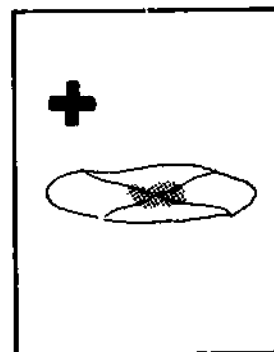
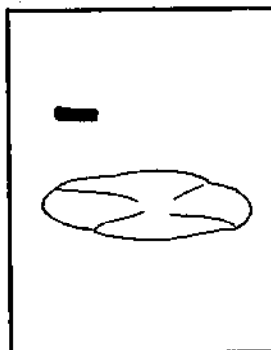
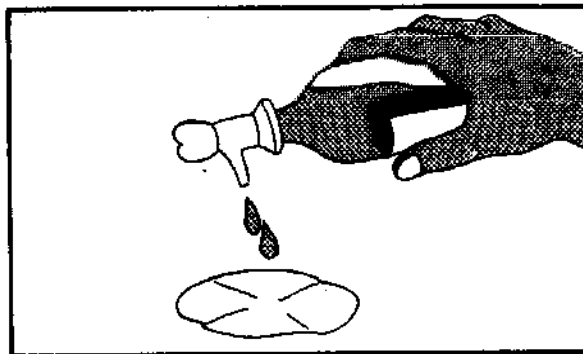

Results

Negative result: no colour change.

Positive result: the precipitate turns green.

6. Urobilinogen in Urine

MATERIALS

- Ehrlich reagent (see reagent No. 19).
- Test-tube.

METHOD

1. Pipette 5 ml of a fresh urine specimen into a test-tube. (If the urine is allowed to stand the urobilinogen will be oxidized and form urobilin, which is not detected by Ehrlich reagent.)

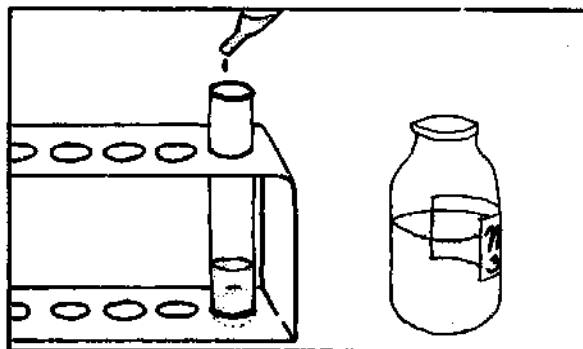

2. Add 0.5 ml of Ehrlich reagent.

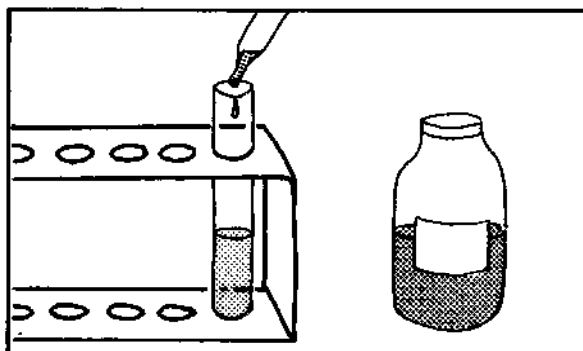

3. Allow to stand for 5 minutes.

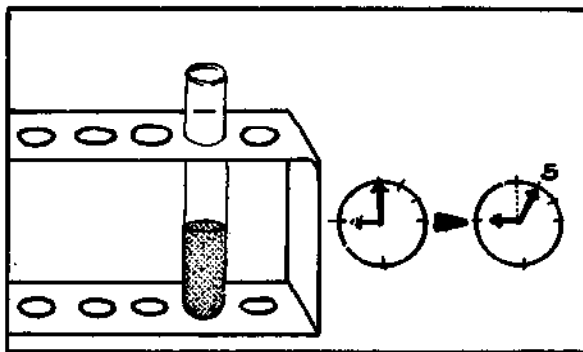

RESULTS

A deep red colour – indicates increased amounts of urobilinogen.

A faint pink or brown colour – indicates that urobilinogen is present in normal amounts.

Note: For test using tablets, see page 324.

7. Ketone Substances in Urine

Value of test

Normal urine does not contain ketone bodies.

Acetone and other ketone bodies may appear in the urine:

- in severe or untreated diabetes
- in certain other conditions (dehydration, vomiting, malnutrition or after violent exercise).

Principle

When sodium pentacyanonitrosylferrate(2-) (also called sodium nitroprusside)* is added to urine containing ketone bodies, a purple colour is produced.

MATERIALS

- Test-tubes
- Rack
- 10 ml measuring cylinder
- Dropping pipette
- Sodium pentacyanonitrosylferrate(2-) (crystals)
- Glacial acetic acid (+)
- Ammonia.

METHOD

1. Preparation of sodium pentacyanonitrosylferrate(2-) solution

Just before carrying out the test, place a few crystals of sodium pentacyanonitrosylferrate(2-) in a test-tube (enough to cover the bottom of the tube).

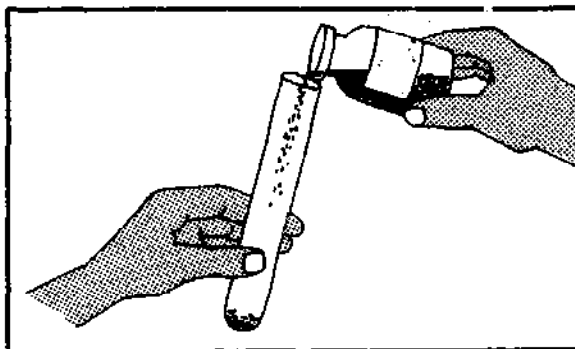

2. Add 5 ml of distilled water.

Shake well until the crystals are almost dissolved. Not all of the crystals are expected to dissolve as the solution is saturated.

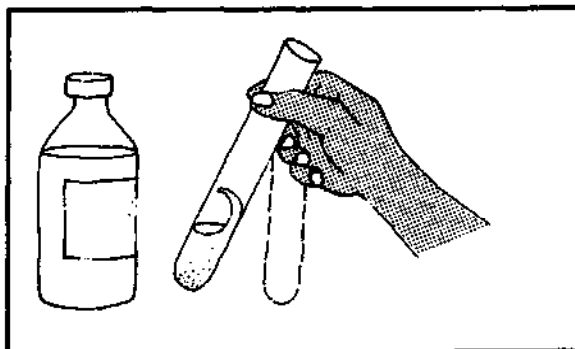

* The bottle available in your laboratory may be labelled with the internationally recommended name sodium pentacyanonitrosylferrate(2-) or with the older, more widely used, but not recommended name sodium nitroprusside. Both names refer to the same substance, but the labelling practice of different manufacturers varies.

3. Into another test-tube, measure:
– 10 ml of urine.

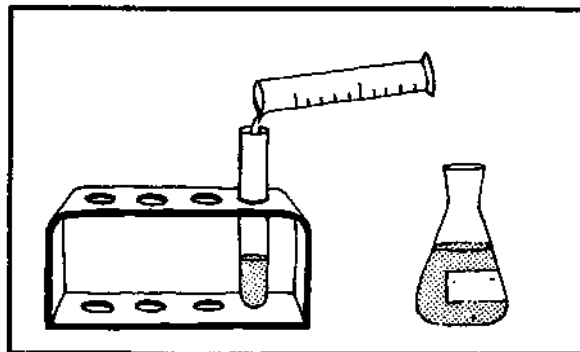

4. Add to the urine:
– 10 drops of acetic acid.

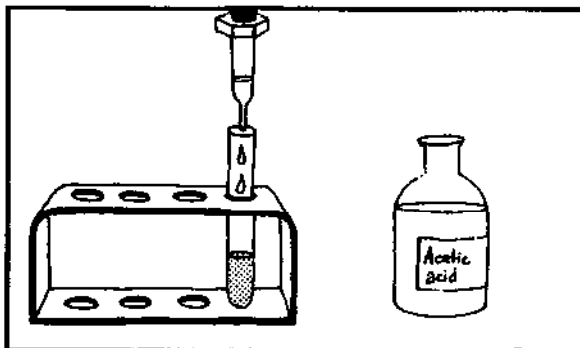

5. Then add:
– 10 drops of the freshly prepared sodium pentacyanonitrosylferrate(2-) solution.

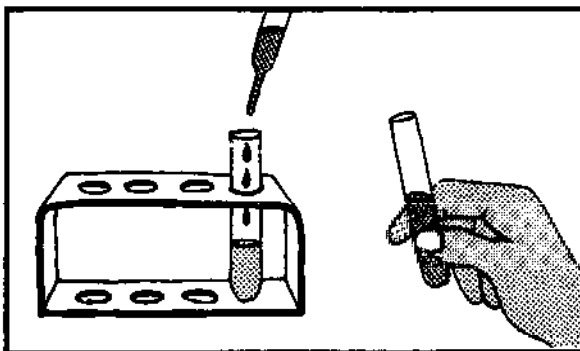

6. Mix well.

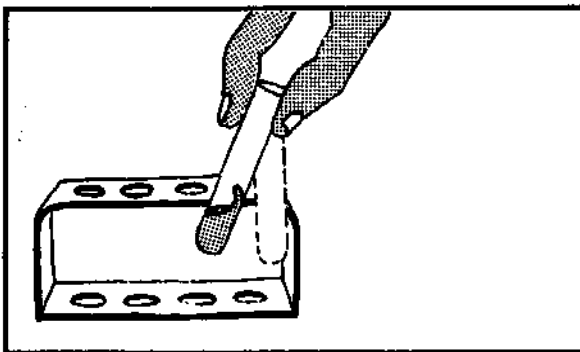

7. Holding the tip of the pipette against the side of the tube, let 20 drops (1 ml) of ammonia solution flow on to the surface of the liquid.
Wait 5 minutes.

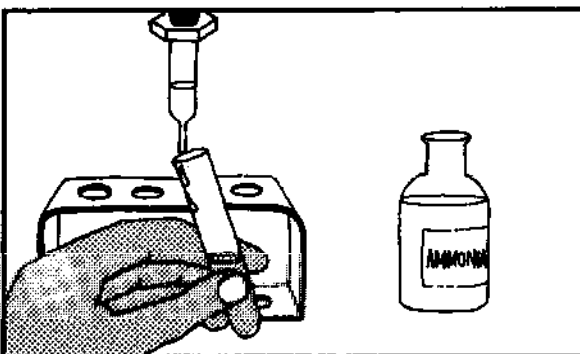

RESULTS

Negative result: no change in colour.

Positive result: purple ring at the top of the urine.

Pinkish ring: +. Red ring: ++. Deep violet: +++.

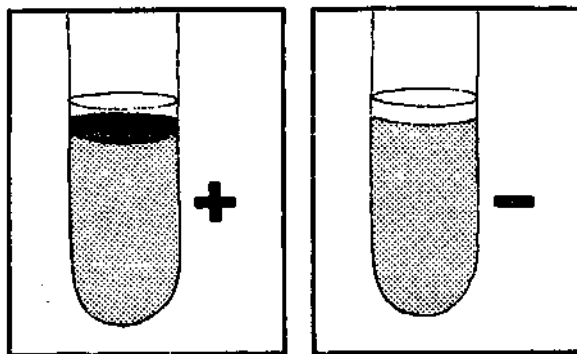

Note: For test using indicator papers or tablets, see page 324.

8. Use of Indicator Papers and Tablets for Urine Examination

Principle

The reagents are commercial products. They may be:

- strips of paper that are dipped in the urine
- tablets on which drops of urine are deposited
- tablets that are put in contact with the urine.

A change of colour occurs when the result is positive.

Instructions for use and precautions

Storage: Keep in a very dry place. Replace the stopper of the bottle immediately after use.

Follow the manufacturer's instructions.

Value

Advantages: The method is quick and easy and does not need glassware, balances, or chemicals.

Disadvantages: The reagents are often expensive. Some results are difficult to interpret. Some of the strips and tablets are not stable and may fail to react.

A. Reagent strips ("dipsticks")

Follow the manufacturer's instructions.

B. Tablets

The method of use depends on the test required: see below.

TYPES OF INDICATOR PAPERS AND TABLETS*

1. Test for glycosuria

Test papers (usually impregnated with glucose oxidase and colour reagents).

Positive result: the paper usually turns bluish-purple.

Advantage

Reagent strips treated with glucose oxidase are specific for glucose. They can be used to confirm a weakly positive result obtained by non-specific tests.

2. Test for proteinuria

Test papers (impregnated with tetrabromophenol blue).

Positive result: the paper usually turns yellowish-green (traces of protein) or blue-green (strong positive).

Disadvantage

Test papers for protein are often too sensitive; they can give weakly positive results that are false.

* In all cases, follow the manufacturer's instructions closely.

3. Test for ketone bodies

Test papers (impregnated with sodium pentacyanonitrosylferrate(2-)).

Positive result: the paper turns violet within 30 seconds.

Tablets (usual method):

- place the tablet in a watch glass
- let a drop of urine fall on to the tablet.

Positive result: a violet colour appears within 30 seconds.

4. Test for urobilinogen

(*p*-dimethylaminobenzaldehyde).

Tablets. The most commonly found tablets are used as follows:

1. Place a small strip of filter paper on a watch glass.
2. Add 5 drops of urine to the paper.
3. Place 1 tablet in the centre of the strip of paper.
4. Let 2 drops of water fall on to the tablet.

Positive result: a red ring appears on the paper round the tablet.

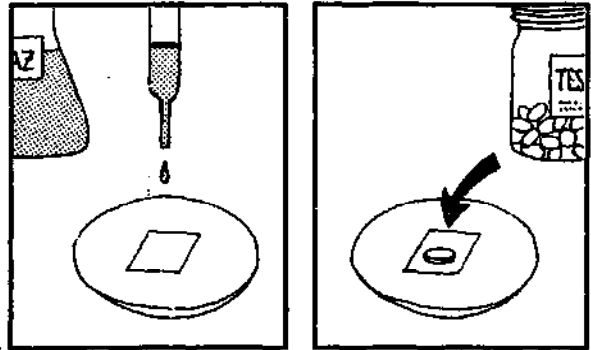

5. Test for blood

Test papers (impregnated with orthotolidine).

Positive result: the paper usually turns blue within 1 minute.

9. Urinary Deposits

Principle

Urine contains microscopic elements in suspension (cells, crystals, etc.). These elements are collected by centrifuging and a drop of the deposit is examined between a slide and coverslip.

As all these elements in suspension would sediment in the urine if left for a few hours, they are called urinary deposits.

Collection of urine

Examine a specimen passed in a single urination.

Examine a mid-stream specimen of fresh urine as soon as possible; it should be

- collected in the laboratory
- or brought quickly from the patient's room (within 2 hours of voiding).

The receptacle should be provided by the laboratory.

Women should be instructed to wash the genitalia beforehand (see page 525).

Never carry out the examination on urine kept in the refrigerator.

Value

In certain diseases of the urinary tract the urinary deposits are considerably altered. The following elements may be found:

- pus
- an abnormal number of red cells
- abnormal crystals, etc.
- parasitic forms.

Preservation of urine with formaldehyde solution

Urine can be preserved for examination of the deposit by adding:

- 8 drops of 10% formaldehyde solution per 300 ml of urine.

Urine treated in this way cannot be used for any other laboratory tests.

MATERIALS

- Electric or hand centrifuge
- 15 ml conical centrifuge tube
- Capillary dropping pipette (Pasteur pipette), if possible calibrated to deliver 50 drops per ml
- Slide and coverslip, 20 x 20 mm
- If necessary, 10% formaldehyde solution (reagent No. 26).

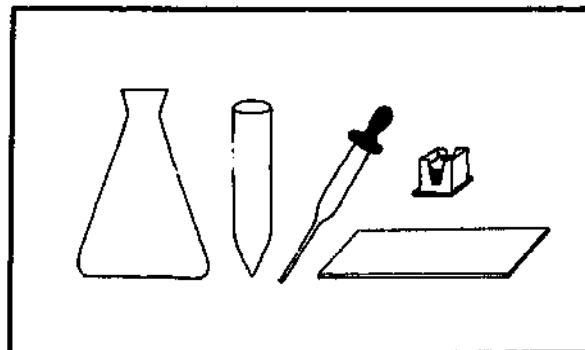

PREPARATION OF THE DEPOSIT

1. Mix the urine gently.
2. Pour immediately into a centrifuge tube until it is $\frac{3}{4}$ full.
3. Centrifuge at medium speed for 5 minutes.

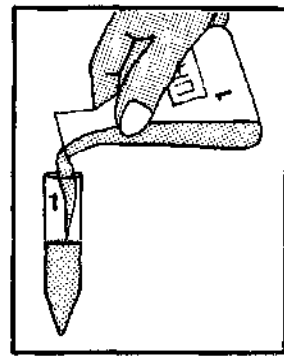
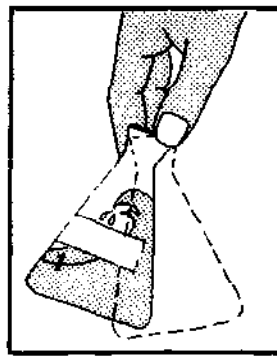

4. Pour off the supernatant urine by inverting the tube quickly without shaking.

(The supernatant urine can be used for chemical tests).

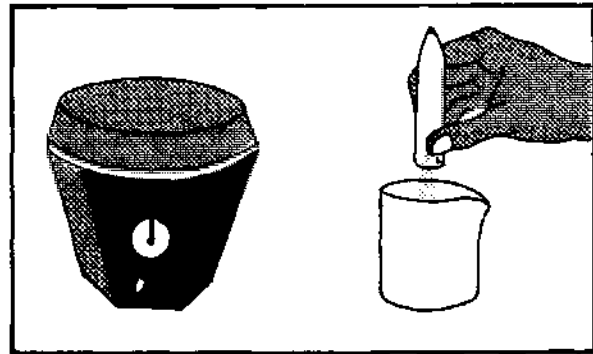

5. Shake the tube to resuspend the deposit.

Draw a few drops of the deposit into a pipette. Place 1 drop on a slide and cover with a coverslip. Number the slide with the number of the specimen.

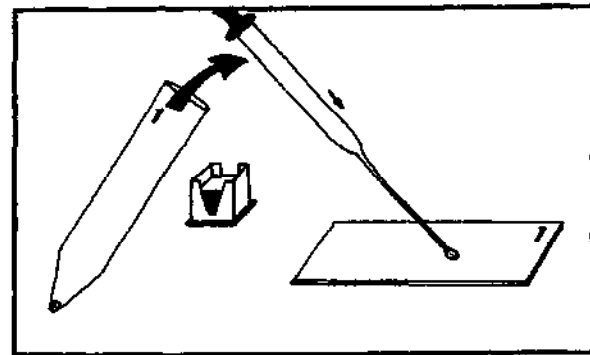

6. Examine under the microscope at once:

- first using the x 10 objective
- then using the x 40 objective
- without a colour filter
- with the condenser lowered enough (or the condenser aperture reduced) to make transparent elements visible.

THE FOLLOWING MAY BE FOUND IN URINE DEPOSITS:

- red blood cells
- leukocytes
- yeasts
- trichomonas
- spermatozoa
- epithelial cells
- casts
- parasitic egg and larvae
- crystals.

A. Red blood cells

They may be:

- (a) intact: small yellowish discs, darker at the edges ($8\ \mu\text{m}$)
- (b) crenated: spiky edges, reduced diameter ($5\text{--}6\ \mu\text{m}$)
- (c) swollen: thin circles, increased diameter ($9\text{--}10\ \mu\text{m}$).

There are normally no red cells in the urine.

Note: Red cells can be found in the urine of women if the specimen has been taken during the menstrual period.

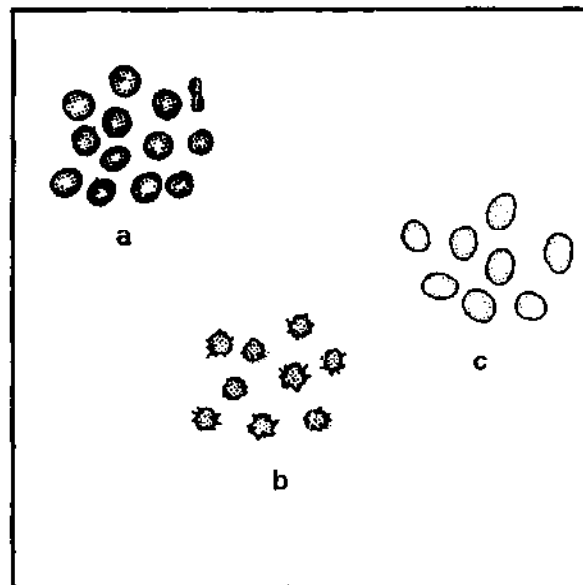

B. Leukocytes (white cells)

They may be:

- (a) intact: clear granular discs, $10\text{--}15\ \mu\text{m}$ (the nuclei may be visible)
- (b) degenerate: distorted shape, shrunken, less granular
- (c) pus: clumps of numerous degenerate cells.

The presence of many leukocytes, especially if in clumps, usually indicates a urinary tract infection.

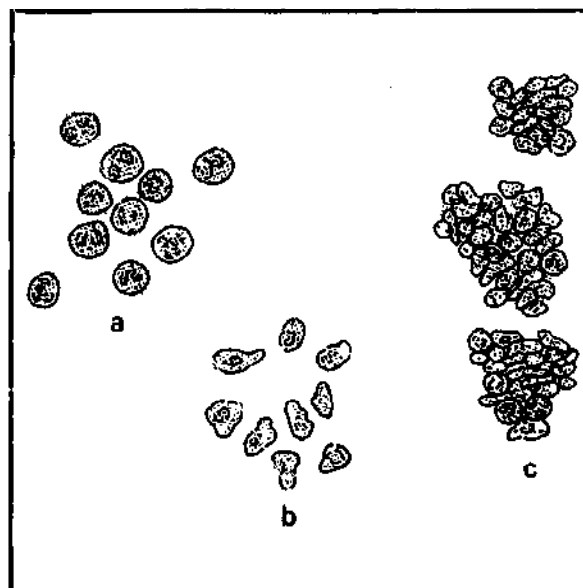

How to express the quantity of red and white cells found in urine deposits

It is important to mention the *quantity* of the various elements found.

It is important always to use the same method of expressing quantities found.

With:

- 1 drop of urine deposit (1/50 ml)
- 1 coverslip, 20 x 20 mm
- x 40 objective; eyepiece x 5 or x 6

examine microscopically:

Red cells

0-10 red cells per field



few red cells
(normal)

10-30 red cells per field



moderate number of red cells

Over 30 red cells per field



many red cells

Leukocytes

0-10 leukocytes per field



Few leukocytes
(normal)

10-20 leukocytes per field



Moderate number of leukocytes

20-30 leukocytes per field



Many leukocytes

Clumps of more than 20 degenerate leukocytes



Many leukocytes seen in clumps

Clumps and many degenerate leukocytes



Full field

C. Yeasts

Do not confuse with red cells.

Size 5-12 μ m

Shape round or oval bodies of *various* sizes found together. Budding may be seen.

They are not soluble in acetic acid.

Yeasts are occasionally present in urine containing glucose. Check that the urine is fresh.

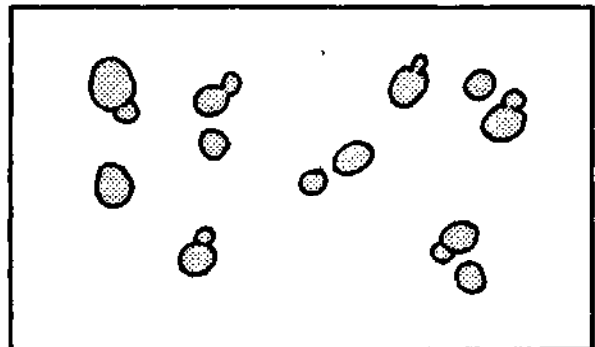

D. Trichomonas

Size	15 μm (2 red cells)
Shape	round, globular
Motility	motile in fresh urine (they whirl and turn)
Undulating membrane	on one side
Flagella	4 flagella, more or less visible.

See also page 187.

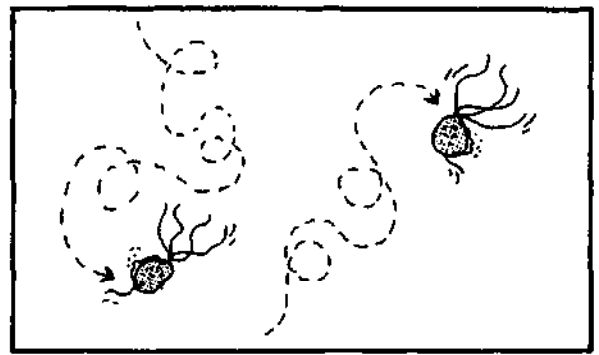

E. Spermatozoa

Occasionally found in the urine of males.

Head	very small (5 μm)
Flagellum	long and flexible (50 μm)
Motility	motile in very fresh urine.

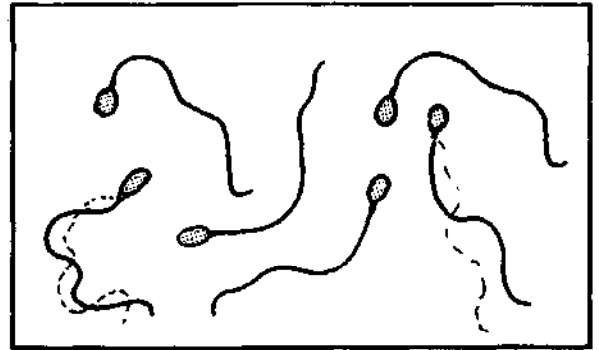

F. Epithelial cells

1. Squamous epithelial cells

Large rectangular cells, the product of desquamation (the shedding of cells from the epithelium of the urinary tract and organs).

They come from:

- the ureter or
- the vagina.

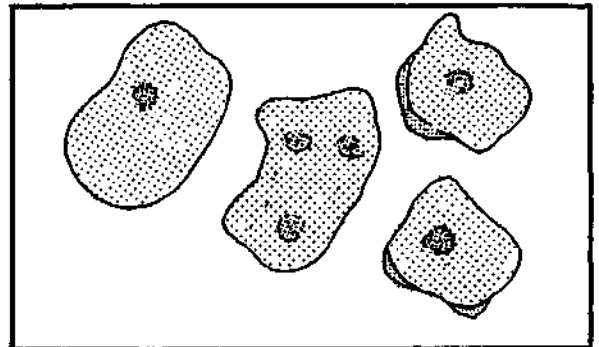

2. Bladder cells

Large cells, often diamond-shaped, with a distinct nucleus.

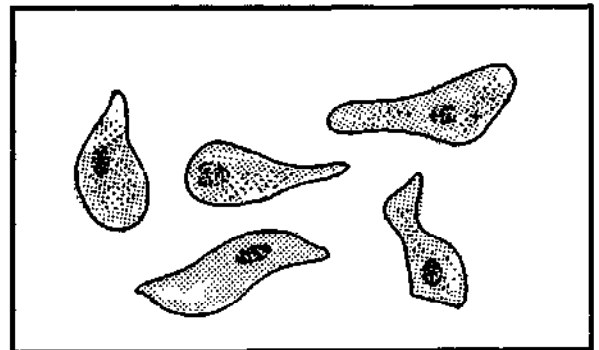

3. Cells from the pelvis of the kidney

Medium-sized cells (the size of 3 leukocytes), granular, with a sort of tail.

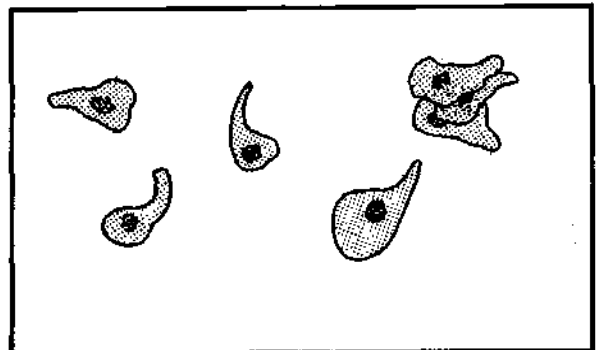

4. *Cells from the ureter and pelvis of the kidney*
 Medium-sized oval cells with a distinct nucleus.
 If many are present together with leukocytes and filaments, they may be from the ureter.
 If few are present, with no leukocytes, they may be pelvic cells.

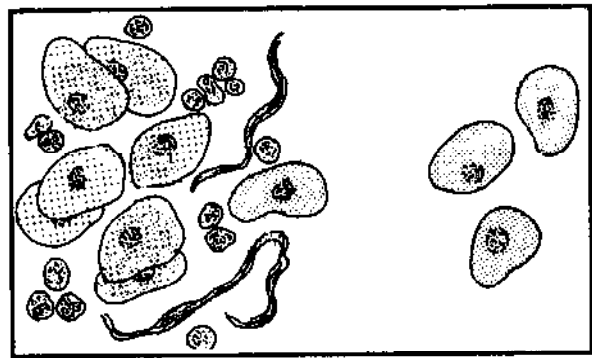

5. *Renal cells*
 Renal cells are small. They are:
 – the size of 1-2 leukocytes (L)
 – very granular.
 The nucleus is refractile and clearly visible. They are almost always present with protein in the urine.

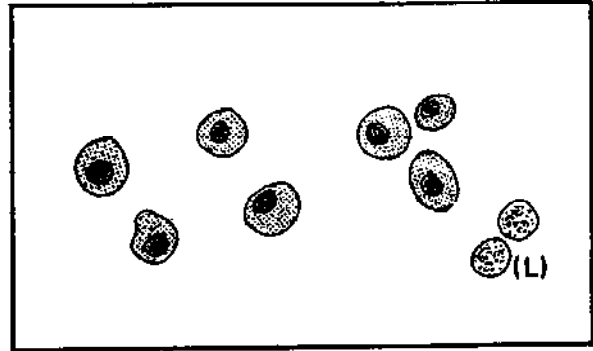

G. Casts

Casts are cylindrical in shape and long, crossing almost the whole field when examined under the x 40 objective. They are formed during disease in the renal tubules, which may fill with blood and other cells and chemical deposits.

1. *Hyaline casts*

Transparent and slightly refractile, the ends rounded or tapered.
 (They may be found in healthy persons after strenuous muscular effort.)

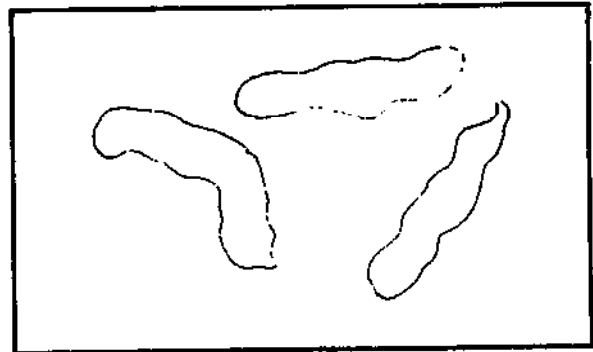

2. *Granular casts*

Rather short casts filled with large granules, pale yellow in colour, with rounded ends.
 (The granules come from degenerate epithelial cells from the tubules of the kidney.)



3. *Fine granular casts*

The granules are smaller and do not fill the cast. Do not confuse with hyaline casts (H), partly covered by amorphous phosphate crystals.



4. *Blood casts*

Casts filled with more or less degenerate red blood cells, brownish in colour.

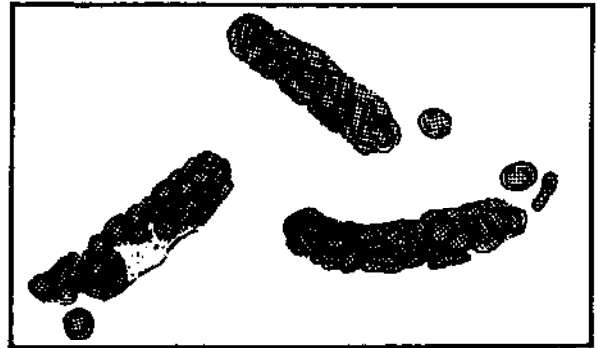

5. *Pus casts*

Casts filled with degenerate leukocytes. True pus casts are completely filled with leukocytes (a). Hyaline casts may contain a few leukocytes (b).

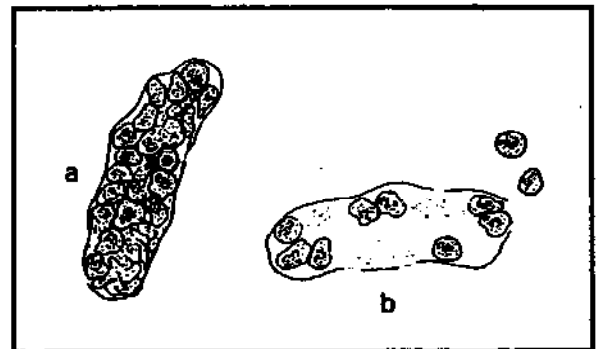

6. *Epithelial casts*

Casts filled with pale yellow epithelial cells. (To make the cells more distinct, add a drop of 100 g/l (10%) acetic acid to the deposit.)

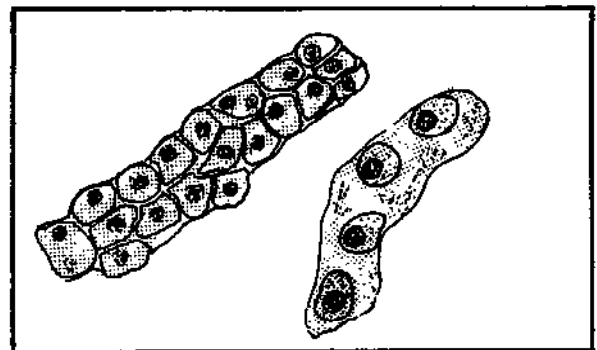

7. *Fatty casts (rare)*

Very refractile yellowish casts, the edges indented and distinct, the ends rounded. Fatty casts are soluble in ether but not in acetic acid.

(They are found in cases of severe kidney disease.)

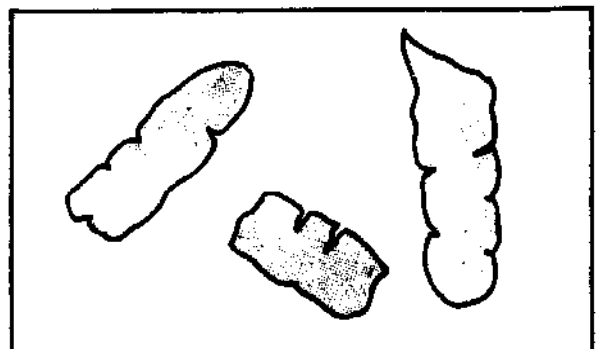

8. False casts

Do not mistake for casts:

- masses of phosphate crystals, short and clear-cut (a)
- masses of translucent mucus, the ends tapering into threads (b).

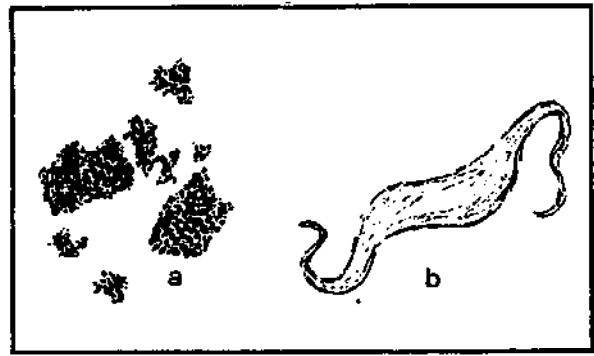

9. Miscellaneous foreign substances

If dirty receptacles or slides are used or if the urine specimen is left exposed to the air, the following may be found:

- (a) oil droplets (refractile)
- (b) starch granules (blue-black with Lugol iodine solution)
- (c) grains of pollen from flowers
- (d) hairs
- (e) cotton fibres
- (f) air bubbles.

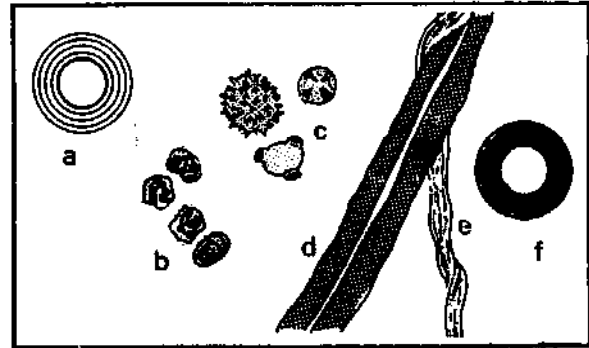

H. Eggs and larvae of parasites

(See page 122)

1. *Eggs of Schistosoma haematobium*: found together with red cells.
2. *Microfilaria of W. bancrofti*: the urine appears white and cloudy.



I. Crystals

Crystals have regular geometric shapes (A), unlike amorphous debris, which is made up of clumps of small granules with no definite shape (B).

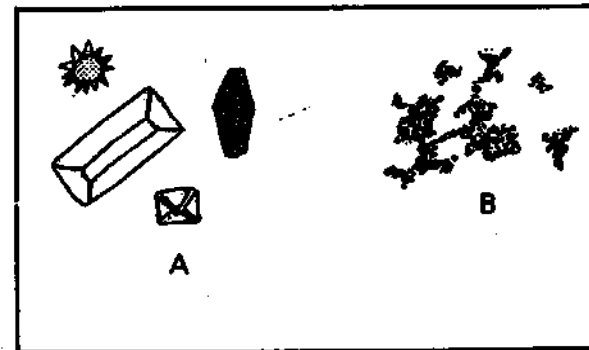

(a) NORMAL CRYSTALLINE DEPOSITS

1. Calcium oxalate (acid urine)

- (a) Shape like an envelope
Size 10-20 μm (1-2 red cells)

or

- (b) Shape like a whole peanut
Size about 50 μm , very refractile.

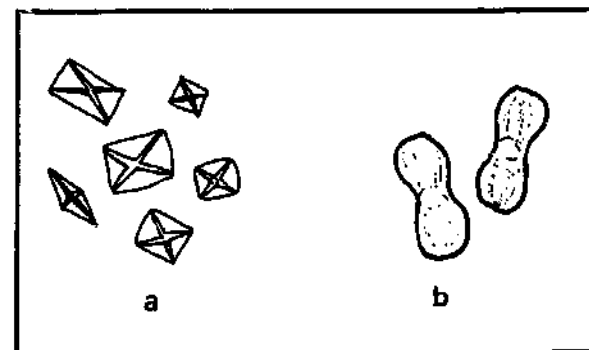

2. *Uric acid (acid urine)*

Shape varies (square, diamond-shaped, cubical or rose-shaped)

Size 30-150 μm

Colour yellow or brownish-red.

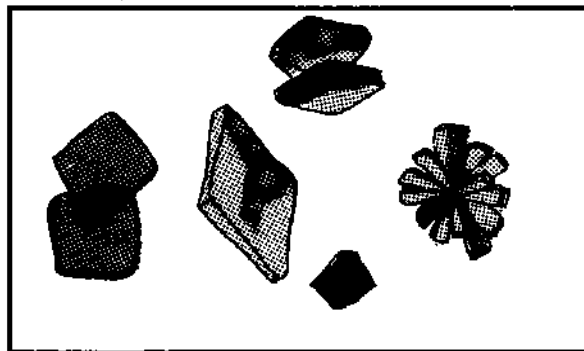

3. *Triple phosphates (neutral or alkaline urine)*

Shape rectangular (1) or like a fern leaf or star (2)

Size 30-150 μm

Colour colourless, refractile.

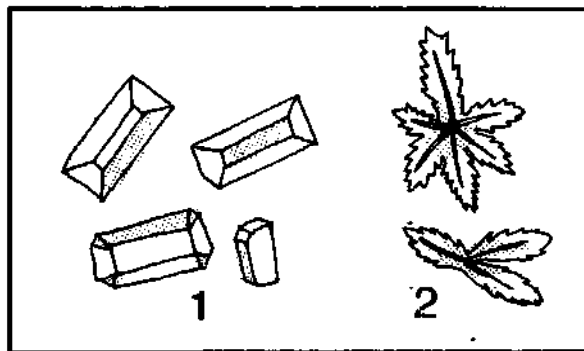

4. *Urates (alkaline urine)*

Shape like a cactus (1) or a bundle of needles (2)

Size about 20 μm (2-3 red cells)

Colour yellow, refractile.

(Often found together with phosphates.)

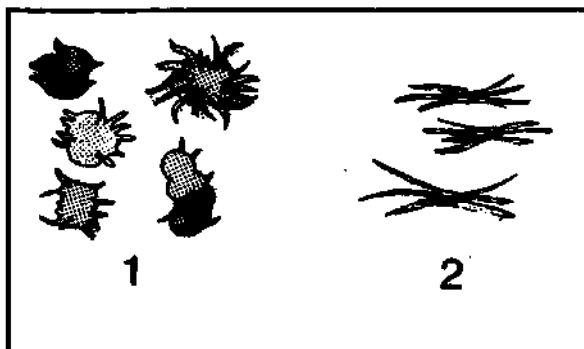

5. *Less common crystals*

A. *Calcium phosphate (neutral or alkaline urine)*

Shape star-shaped

Size 30-40 μm

Colour none.

B. *Calcium carbonate (neutral or alkaline urine)*

Crystals very small, like millet or corn grains, grouped in pairs

Colour none.

(If 100 g/l (10%) acetic acid is added they dissolve, giving off bubbles of gas.)

C. *Calcium sulfate (acid urine)*

Shape long prisms or flat blades, separate or in bundles

Size 50-100 μm .

(They can be distinguished from calcium phosphate crystals by measuring the pH of the urine.)

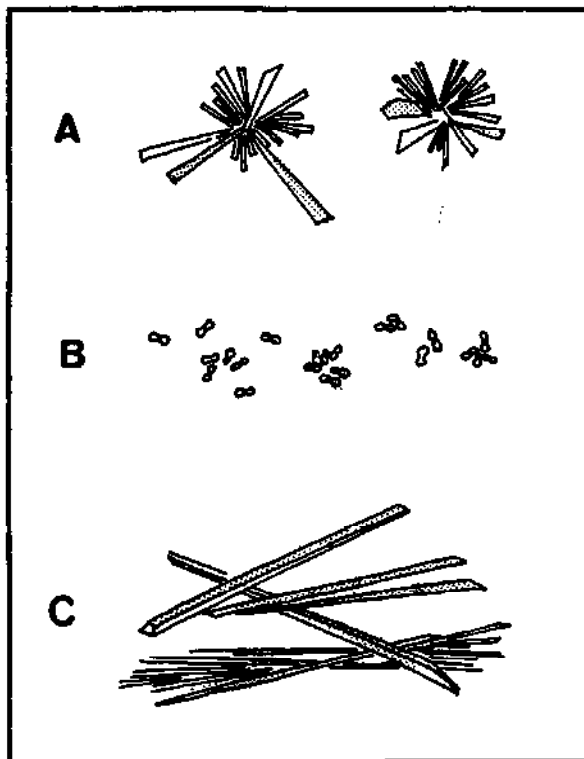

(b) **AMORPHOUS DEBRIS**

1. **Amorphous phosphates (alkaline urine)**

Granules small, whitish, often scattered.

They are soluble in 100 g/l acetic acid (1 drop per drop of deposit).

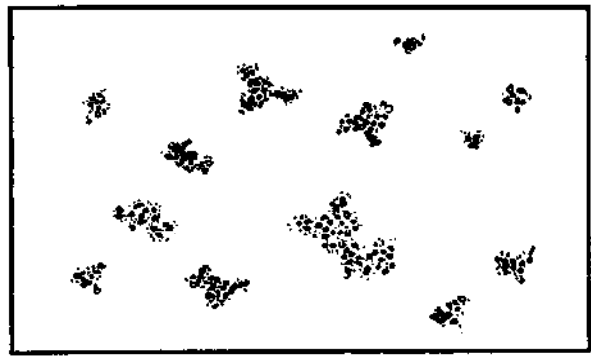

2. **Amorphous urates (acid urine)**

Granules very small, yellowish, grouped in compact clusters.

They are not soluble in 100 g/l acetic acid, but dissolve if the urine is gently heated.

(Urine kept in the refrigerator often shows a heavy precipitate of urates.)

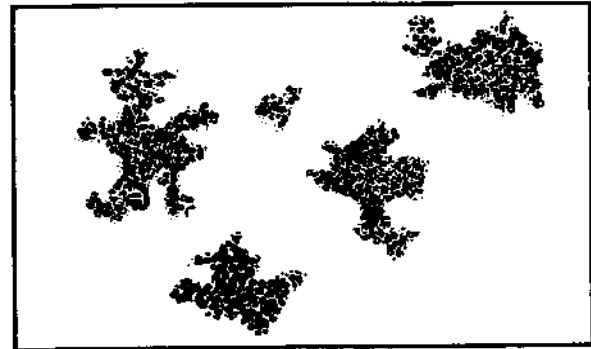

(c) **OTHER CRYSTALLINE DEPOSITS**

The following are *rarely* found in the urine. When present, however, they are found in large quantities.

1. **Cystine (acid urine)**

Shape hexagonal plates

Size 30–60 μm

Colour colourless, very refractile.

Found only in fresh urine, as they are soluble in ammonia.

(Found in cystinuria, a hereditary disease.)

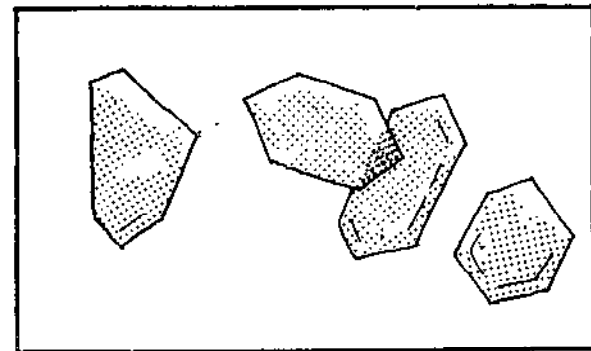

2. **Cholesterol (acid urine)**

Shape squarish plates, with notches on one side

Size 50–100 μm

Colour colourless, refractile.

Soluble in ether.

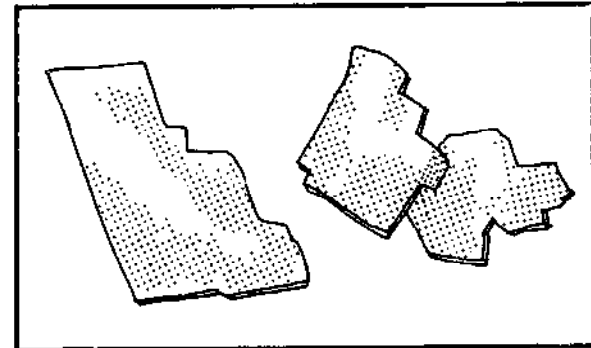

3. **Bilirubin (very rare)**

Shape various tiny crystals, square or like beads or needles

Size 5 μm (about $\frac{1}{2}$ red cell)

Colour brown.

(The chemical test for bile pigments is positive.)

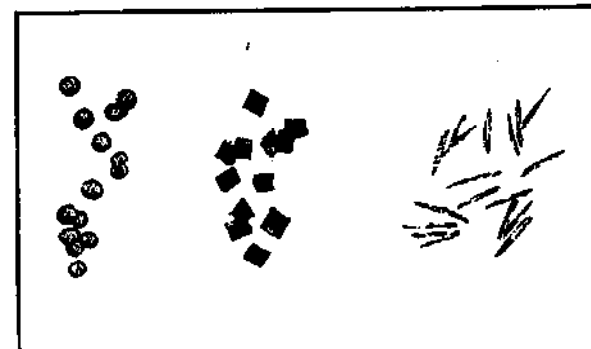

4. Acetyl sulfonamides (neutral or acid urine)

Found in patients following treatment with sulfonamide drugs.

Sulfonamide crystals are varied in shape but most frequently like sheaves of needles. If large quantities of unidentified crystals are seen find out whether the patient is on sulfonamide therapy.

The presence of these crystals should be reported because they can cause kidney damage.

10. Pregnancy Tests

It can be determined whether or not a woman is pregnant by testing her urine:

- either using commercial reagents (immunochemical test)
- or injecting the urine into a laboratory animal (biological test).

Collection and preservation of urine

For pregnancy tests the specimen must be *collected first thing in the morning*. Collect the first urine of the day into a clean bottle, rinsed with distilled water. Any traces of detergent may lead to a false result. The test should be performed without delay. If this is not possible, keep the urine in the refrigerator.

A. IMMUNOCHEMICAL TEST

There are many commercial reagents available for this test, which may be carried out:

- in a test-tube
- or on a slide.

1. Test-tube method

Always follow the manufacturer's instructions closely.

Positive result

The most common commercial reagents produce a regular brownish-red ring in the bottom of the tube.

Negative result

The liquid remains homogeneous; no ring forms.

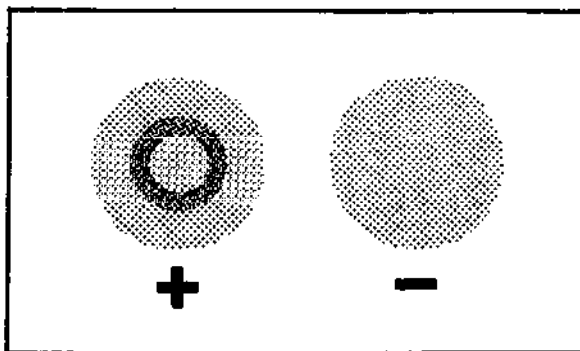

2. Slide method

Follow the manufacturer's instructions. One of the reagents consists largely of a suspension of latex particles.

If the test is negative, the latex particles agglutinate on the slide.

If the test is positive, no agglutination is seen; it is prevented by substances in the pregnant women's urine.

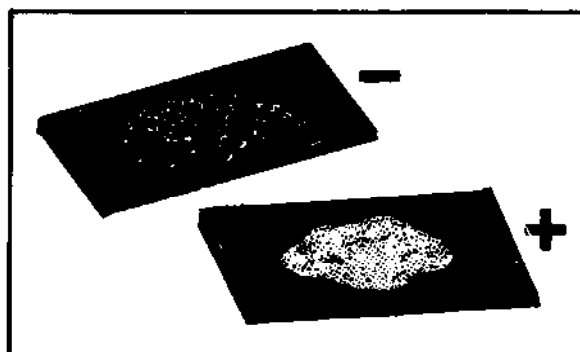

B. BIOLOGICAL TEST

Various animals are used, two of the most frequently used being the male toad and the male frog. The urine to be tested is injected into the toad. If the woman is pregnant the hormones in her urine stimulate the toad or frog, which passes spermatozoa visible under the microscope. Laboratory technicians must be carefully trained in this procedure by a qualified instructor and must follow his directions as to the choice of toad or frog, the amount of urine to inject, the incubation period, and microscopical examination of the cloacal fluid of the toad or frog.

When does the test become positive?

Positive results are obtained 9-15 days after the first menstrual period has been missed, depending on the reagents and test used.

DETECTION OF BLOOD IN URINE

Whole blood can be detected in fresh urine by examining microscopically for red cells the deposit from a centrifuged specimen (see page 325).

Chemical tests using benzidine are not recommended, as this chemical is known to be carcinogenic.

Reagent strips are available for detecting blood in urine (see page 324).

B. EXAMINATION OF CEREBROSPINAL FLUID

11. Collection of CSF: Appearance

CSF = Cerebrospinal fluid

Where is CSF found?

CSF is contained in the cavity that surrounds the brain in the skull and the spinal cord in the spinal column. It nourishes the tissues of the central nervous system and helps to protect the brain and spinal cord from injury.

Meningitis is an inflammation of the meninges, the membranes lining the skull and covering the brain and spinal column.

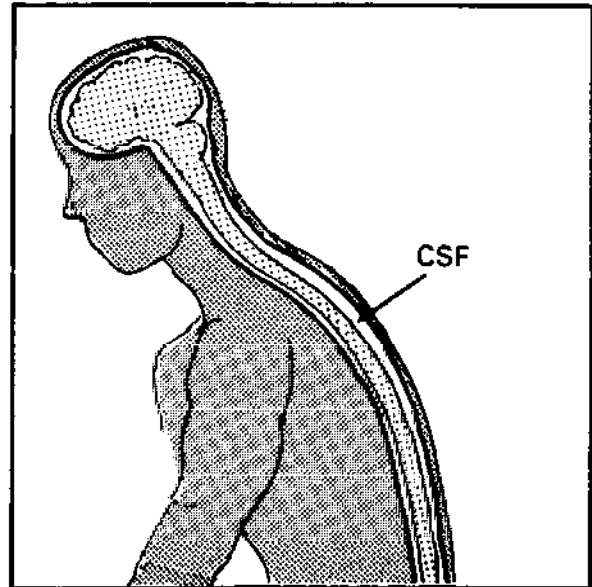

Volume of CSF

The volume of the CSF in adults is 100-150 ml.

COLLECTION INTO 2 TUBES

The specimen may be collected only by:

- a physician or
- a specially trained nurse.

1. The lumbar puncture needle is inserted between the 4th and 5th lumbar vertebrae to a depth of 4-5 cm. The stylet is withdrawn and the fluid flows through the needle.

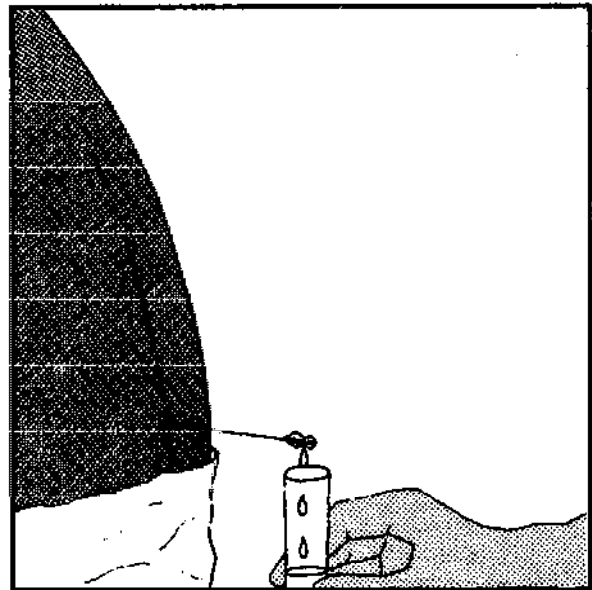

2. The CSF is collected in 2 tubes, numbered 1 and 2:
 - tube 1: a few drops in a sterile container
 - tube 2: 6-7 ml.

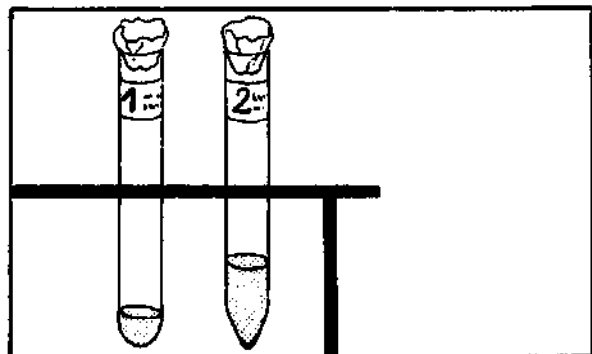

Tube 1 is discarded if it contains many red cells.

Tube 2 is used for:

- a description of the appearance
- the leukocyte concentration
- glucose estimation
- total protein testing
- Pandy test for globulin
- microscopical examination:
 - (a) a wet preparation for trypanosomes
 - (b) a Gram-stained preparation for other organisms
 - (c) Ziehl-Neelsen-stained preparations for acid-fast bacilli.

APPEARANCE OF THE CSF

This should be mentioned in the report.

- A. *Clear CSF*: normally the CSF is clear and colourless.
- B. *Cloudy CSF*: it may be slightly cloudy or greyish-white, showing that pus is present.
- C. *Bloodstained CSF*: the fluid is cloudy and pink or reddish
- either because of injury to blood vessels in the course of the puncture (in this case there is more blood in tube 1 than in tube 2)
 - or because of a subarachnoid haemorrhage (in this case both tubes are the same colour).

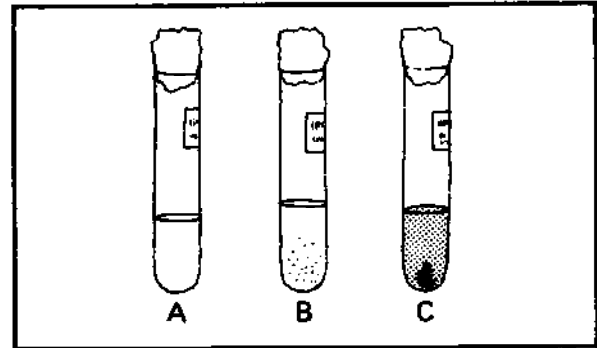

If only one tube of CSF is available, wait for the red cells to settle (or centrifuge) and examine the supernatant fluid.

1. If the supernatant fluid is clear, the blood is there because of accidental injury to a blood vessel.
2. If the supernatant fluid is stained, the blood is there because of a subarachnoid haemorrhage.

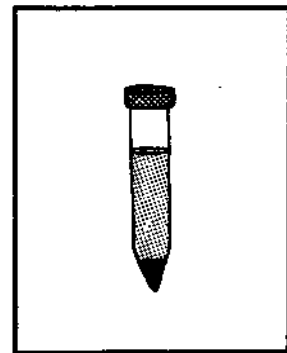
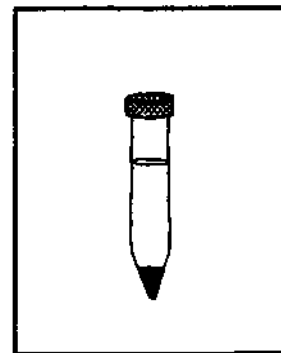

- D. *Xanthochromia*: yellow discoloration of the CSF. This may be caused by:
- an old haemorrhage
 - severe jaundice
 - spinal constriction.

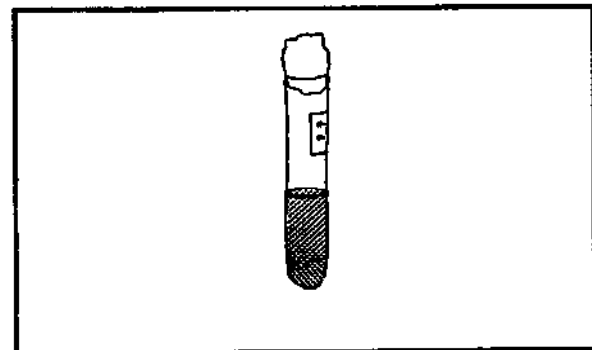

- E. *Clot formation* (Mention the presence of clots in the report.)

Examine the tubes of CSF 10 minutes after collection to see whether clots have formed:

1. Normal CSF: no clots.
2. Clots may be found in certain diseases:
 - tuberculous meningitis: single or numerous fine small clots that can easily be overlooked
 - purulent meningitis: a large clot
 - spinal constriction: the CSF clots completely.

PRECAUTIONS TO BE TAKEN WHEN EXAMINING THE CSF IN THE LABORATORY

1. *Do not delay in testing the CSF*

Cells and trypanosomes are rapidly lysed once the CSF is removed. Glucose too is rapidly destroyed, unless preserved with fluoride oxalate (see page 344).

2. *Work carefully and economically*

Often only a small quantity of CSF is available for examination. The specimen is difficult to collect so do not waste any of it.

3. *The fluid may contain virulent organisms*

Therefore use pipettes plugged with non-absorbent cotton wool, or use a rubber bulb to draw up the fluid in the pipette.

12. Leukocyte Concentration in the CSF

Principle

The CSF may contain leukocytes in varying quantities in certain diseases.

The fluid is examined to determine:

1. the total number of leukocytes – the white cell concentration ("count") (using a counting chamber)
2. the types of leukocyte present – identification (after staining with a Romanowsky stain).

Important:

The cell count must be carried out as soon as possible after collection of the specimen, since the cells are rapidly lysed.

TOTAL LEUKOCYTE CONCENTRATION IN THE CSF

Materials

- Fuchs-Rosenthal counting chamber (if not available, an improved Neubauer counting chamber may be used)
- Pasteur pipette with rubber teat
- Türk solution (reagent No. 55).

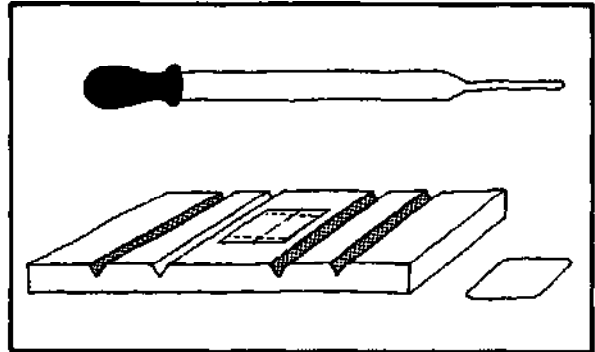

Method

1. Cover the counting chamber with the coverglass supplied.

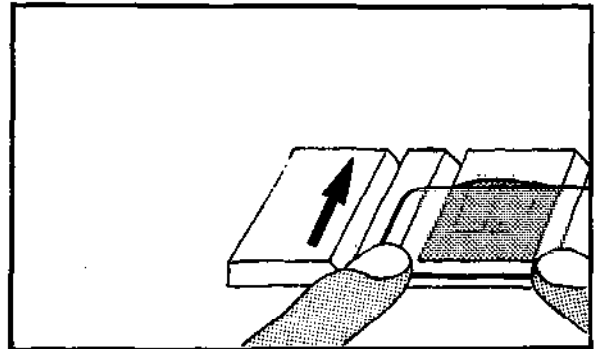

2. Gently mix the CSF.

Fill the chamber with the fluid:

- undiluted, if the CSF appears clear
- diluted, if the CSF appears cloudy.

Make a 1 in 20 dilution using 0.05 ml of the CSF and 0.95 ml of Türk solution. Pipette into a small bottle and mix.

3. Leave the counting chamber on the bench for 5 minutes to allow the cells to settle. Place the chamber on the microscope stage.

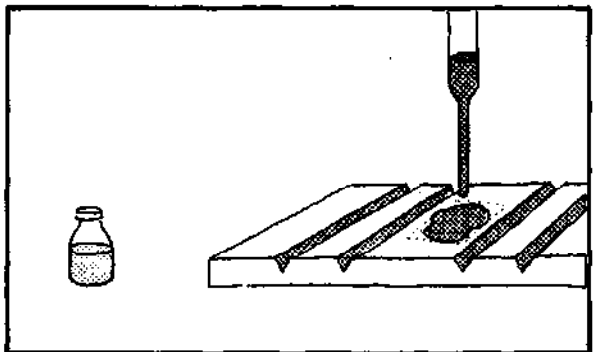

4. Count the cells in 1 cubic millimetre of CSF, using the x 10 objective. When reporting in SI units, report as "number x 10⁶/l"; the value does not change. Example: 150 cells per mm³ are reported as "150 x 10⁶/l".

Important:

If using undiluted CSF, examine the cells using the x 40 objective to make sure that the cells are leukocytes. If red cells are present, make the count using the x 40 objective.

The Fuchs-Rosenthal ruled counting chamber has an area of 9 mm^2 (modified chamber) or 16 mm^2 . The depth of the chamber is 0.2 mm .

Count the cells in 5 mm^2 using squares 1, 4, 7, 13 and 16.

Using undiluted CSF no calculation is necessary; the number of cells counted gives the number per cubic millimetre of CSF.

Using diluted CSF, the number of cells counted multiplied by 20 gives the number of cells per mm^3 of CSF.

Using an improved Neubauer chamber, count the cells within the entire ruled area, which is 9 mm^2 .

Using undiluted CSF, multiply the cells counted by 10 and divide by 9 to give the number of cells per mm^3 of CSF.

Using diluted CSF, multiply the cells counted by 20 and divide by 9 to give the number of cells per mm^3 of CSF.

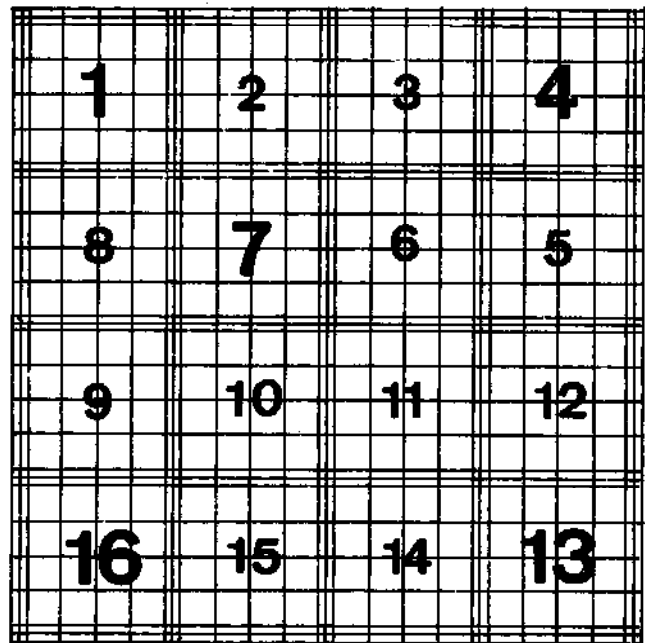

LEUKOCYTE-TYPE NUMBER FRACTION ("DIFFERENTIAL WHITE CELL COUNT")

If the CSF does not contain many cells (under $200 \times 10^6/\text{l}$):

1. Centrifuge the CSF at high speed for 10 minutes. Remove the supernatant fluid into another tube (to be used for other tests).

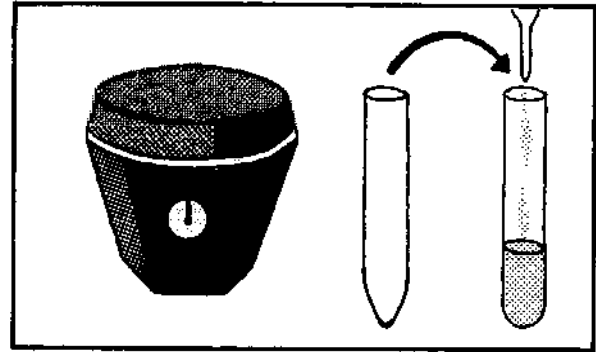

2. Mix the deposit by tapping the end of the tube. Spread on a clean slide and leave to dry. Fix with methanol and stain with a Romanowsky stain as described on page 393. Examine the cells.

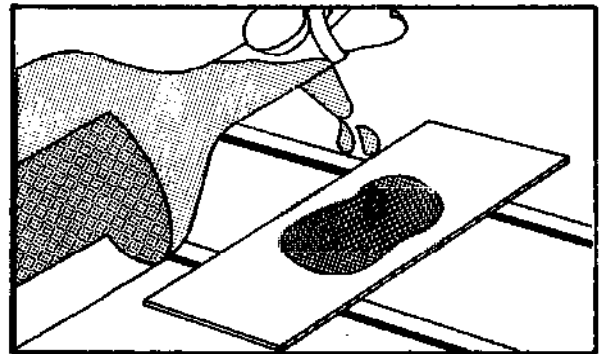

If there are many cells in the CSF:

- pipette 1 drop of uncentrifuged, mixed CSF on to a slide
- make a thin smear and leave to dry
- fix and stain as described on page 393.

Results

Normal CSF: less than 5×10^6 white cells per litre (less than 5 per mm^3)

Increased number of cells can be found in:

- | | |
|--|--|
| Bacterial meningitis
(meningococcal, <i>H. influenzae</i> , pneumococcal) | - mostly neutrophils |
| Tuberculous and viral meningitis | - mostly lymphocytes |
| African trypanosomiasis | - mostly lymphocytes, but Mott cells may be seen, as well as trypanosomes. |

13. Glucose Estimation in the CSF

Principle

In meningitis (especially purulent meningitis) the glucose in the CSF is greatly reduced.

MATERIALS

As described under blood glucose estimation (see page 429).

METHOD

As described under blood glucose estimation, except that four times the amount of CSF is used as compared with blood.

The CSF glucose in the healthy individual is 2.5–4.2 mmol/l.*

Important:

As the glucose in the CSF is rapidly destroyed once the fluid is collected, it is important to carry out glucose estimation as soon as possible.

If there is likely to be a delay, the CSF should be preserved in fluoride oxalate (see reagent No. 23).

* In traditional units, 45–75 mg/100 ml.

14. Protein in the CSF

Principle

The total protein in the CSF is measured by diluting the CSF in 3% sulfosalicylic acid and comparing the cloudiness produced against a set of protein standards.

A raised globulin level in the CSF is shown by adding the CSF to a phenol solution, in the Pandy test.

MATERIALS

- CSF: centrifuge the CSF and use the supernatant fluid
- 30 g/l sulfosalicylic acid (reagent No. 52)
- Pandy reagent (reagent No. 40)
- Graduated pipettes
- Protein standards (see page 314).

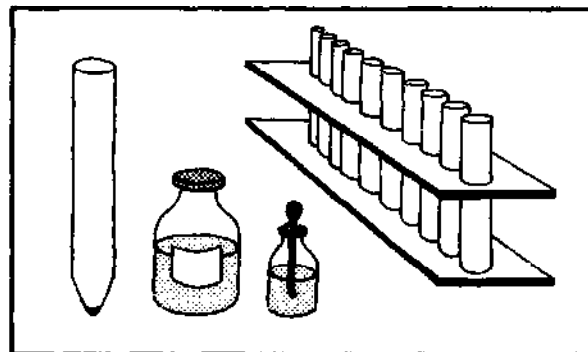

METHOD FOR TOTAL PROTEIN

1. Pipette 3 ml of 30 g/l sulfosalicylic acid into a test-tube that matches those of the standard tubes.

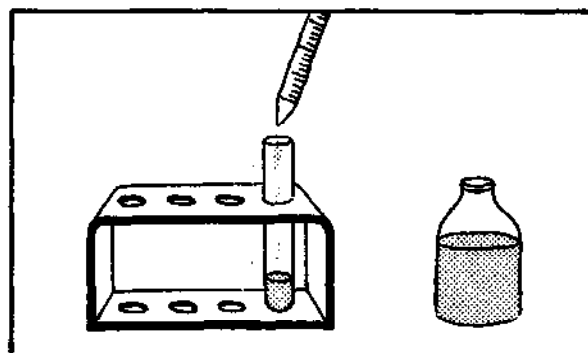

2. Add 1 ml of clear CSF supernatant fluid and mix. Leave the tube for 5 minutes.
3. Compare the cloudiness of the test against the protein standards. Record the CSF protein in g/l.

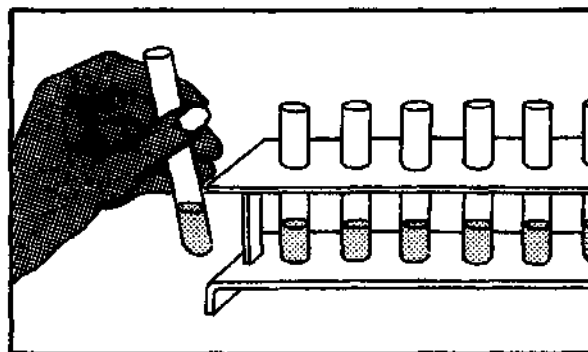

Results

The normal CSF protein is 0.1–0.45 g/l.*

The CSF protein is increased in:

- meningitis, subarachnoid haemorrhage or spinal constriction
- African trypanosomiasis.

* In traditional units, 10–45 mg/100 ml.

PANDY TEST FOR GLOBULIN

Method

1. Measure into a small test-tube:
 - 1 ml of Pandy reagent.

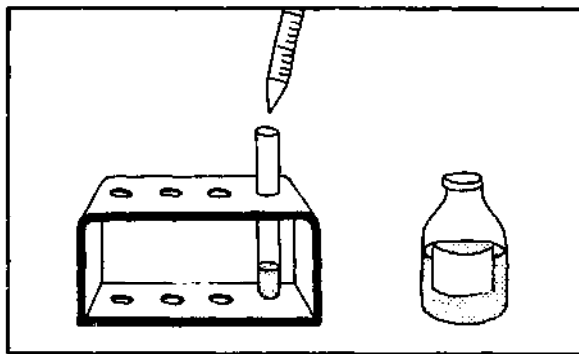

2. Place the tube in front of a piece of black cardboard.
3. Using the dropping pipette, slowly add:
 - 3 drops of CSF.Examine the solution after the addition of each drop.

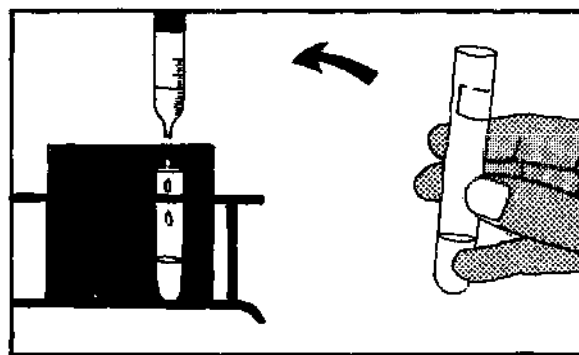

4. Read the results immediately.

Results

Positive test

A white cloud forms as the drops of CSF mix with the reagent.

Negative test

No white cloud forms as the drops of CSF mix with the reagent, or there is a slight cloudiness that redissolves.

Report the test as "Pandy test positive"
or "Pandy test negative".



15. Microscopical Examination of the CSF

Microscopical examination of CSF includes:

1. Examination of a direct wet preparation for trypanosomes in areas where African trypanosomiasis occurs.
2. Examination of a Gram smear for organisms that cause meningitis, e.g. meningococcus, pneumococcus, *Haemophilus influenzae*.
3. Examination of a Ziehl-Neelsen smear if tuberculous meningitis is suspected.
4. Examination for fungi, if suspected.

The above examinations are made using the deposit from centrifuged CSF.

1. DIRECT WET PREPARATION FOR TRYPANOSOMES

Place 1 drop of CSF deposit on a slide and cover with a coverglass.
Examine the preparation using the x 40 objective.

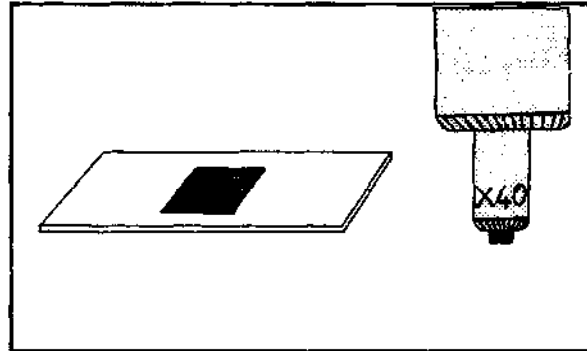

Results

The finding of motile trypanosomes in the CSF means that the later stage of the disease has been reached, in which the central nervous system has become infected. The CSF protein is raised with a positive Pandy test. The fluid also contains increased number of leukocytes.

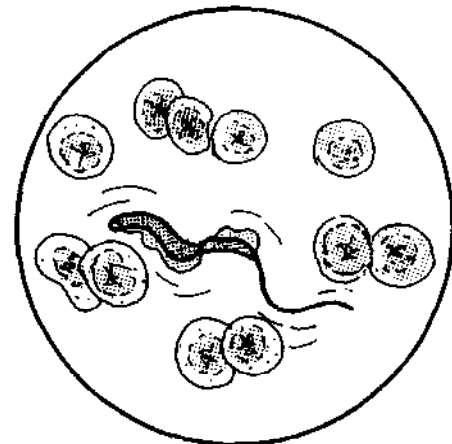

In a stained preparation the leukocytes can be identified as lymphocytes, and Mott cells can often be seen (M). These are large cells containing vacuoles and large amounts of immunoglobulin M that stain dark with the eosin part of Romanowsky stains (see page 391).

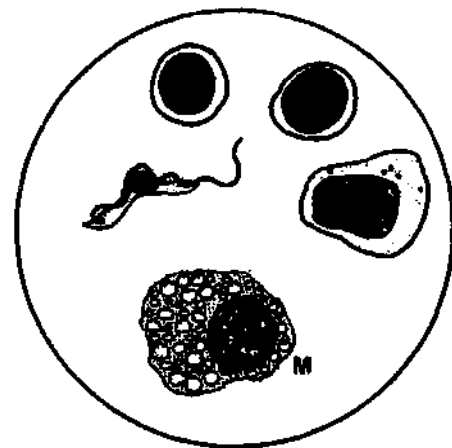

2. GRAM SMEAR FOR MENINGITIS

Make a smear of the CSF deposit and allow to dry in the air.
Stain the smear by the Gram method as described on page 235.

Results

Any organisms seen in the Gram smear are reported by their:

- Gram reaction: positive or negative
- morphology: cocci, diplococci, bacilli, etc.
- numbers found.

A definite species identification cannot be made from a stained smear only. Culture of the organisms is necessary.

The organisms that cause meningitis include:

A. *Meningococci*

- Gram negative
- diplococci, lying side by side
- intracellular, inside the neutrophils.

They may occasionally be seen outside the cells and may be few in number.

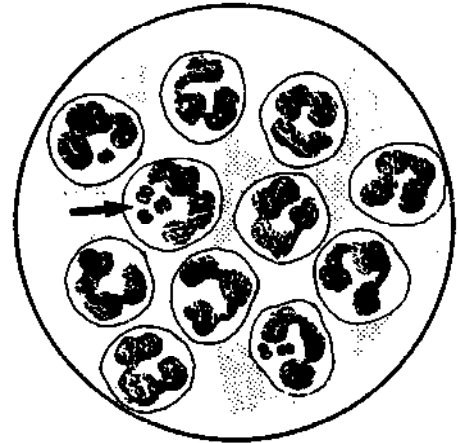

B. *Pneumococci*

- Gram positive
- diplococci, lying end to end
- surrounded by a capsule, which is not visible by Gram stain
- usually many.

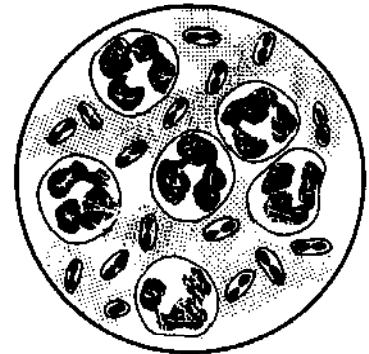

C. *Haemophilus influenzae* (especially in young children)

- Gram negative
- small bacilli (coccobacilli)
- not intracellular
- often numerous.



In all the above-mentioned forms of meningitis the leukocytes present are neutrophils.

Gram positive bacilli

Very rarely found. May belong to the *Listeria* group. Culture is essential.

3. ZIEHL-NEELSEN PREPARATION FOR TUBERCULOUS MENINGITIS

If tuberculous meningitis is suspected the CSF is allowed to stand and a delicate clot may form. This should be removed, spread on a slide and stained by the Ziehl-Neelsen methods, as described on page 249.

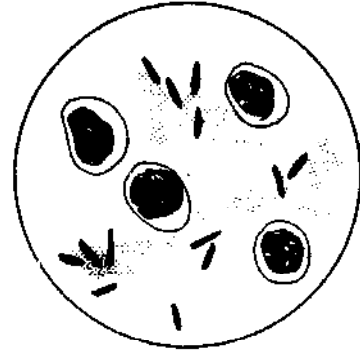

Results

If organisms are seen, report the smear as "AFB present".

4. FUNGI IN THE CSF

Fungi (very rare) may be observed in the smear stained by the Gram method.

Cryptococcus neoformans (cloudy CSF with lymphocytes)

Add:

- 1 drop of centrifuged CSF deposit
- 1 drop of Indian ink.

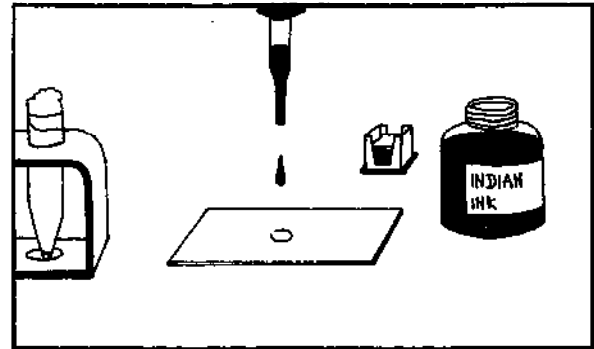

Examine the mixture between a slide and coverslip.

The fungus appears as follows:

- round budding spores containing greyish granulations
- each group of 1-3 spores surrounded by a colourless capsule.

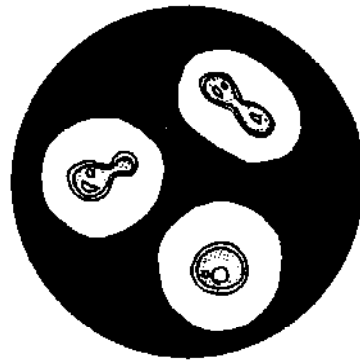

Candida (clear with a few leukocytes)

In an unstained wet preparation, the following are seen:

- oval budding spores
- short mycelium filaments.

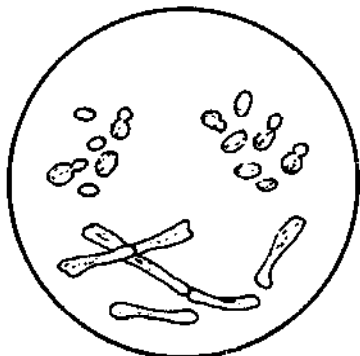

DISPATCH OF CSF FOR BACTERIAL CULTURE

Before dispatch, keep the CSF in the incubator at 37 °C. Do not put it in the refrigerator.

Use "Transgrow" medium if available, otherwise use Stuart transport medium (reagent No. 50).

Using "Transgrow" medium (for the isolation of meningococci)

This is the best method, if bottles of the medium are available. The medium is supplied as follows:

- in 30 ml bottles
- containing 8 ml of solid medium (along one side of the flat bottle)
- filled with a mixture of air (90%) and carbon dioxide (10%).

Follow the instructions given for gonococci on page 245.

If possible, sow centrifuged CSF deposit on the medium; otherwise use untreated CSF.

Preservation time: up to 4 days at room temperature.

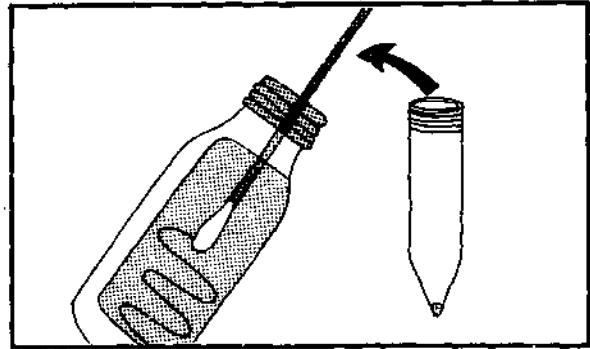

16. The Blood Cells

Haematology is the study of the blood, which includes the blood cells and the fluid surrounding them.

THE BLOOD CELLS

Blood cells can be examined under the microscope.
There are 3 different types:

1. *Red blood cells, also called erythrocytes*

Appearance	round cells filled with haemoglobin Red cells on their side look like biconcave discs; they do not contain nuclei
Size	7.5 μm
Number concentration	about 5×10^{12} per litre (5 000 000 per mm^3) of blood
Function	The red cells carry haemoglobin, which combines with and carries oxygen from the lungs to the tissues. They also carry carbon dioxide from the tissues to the lungs, thus removing the principal material to which most organic substances are metabolized in the body.

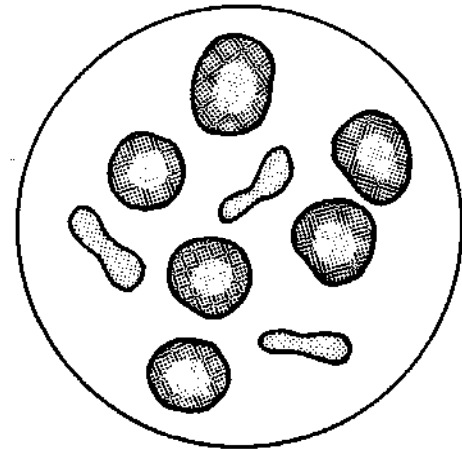
2. *White blood cells, also called leukocytes*

Appearance	round, each containing one nucleus and a few granules
Size	9-20 μm
Number concentration	about 8×10^9 per litre (8000 per mm^3) of blood
Function	defence of the body against infection.

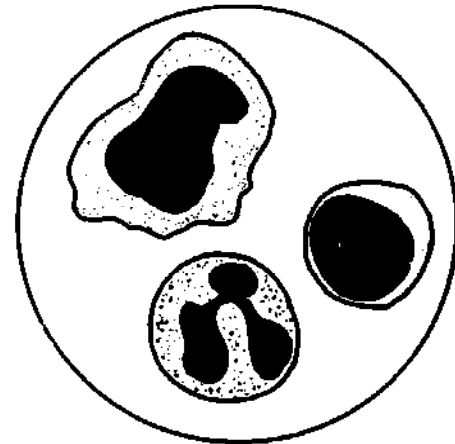
3. *Platelets, also called thrombocytes*

Appearance	fragments of cells of various shapes (triangular, star-shaped, oval, etc.), with granules
Size	2-5 μm
Number concentration	about 300×10^9 per litre (300 000 per mm^3) of blood
Function	important in the clotting of the blood.

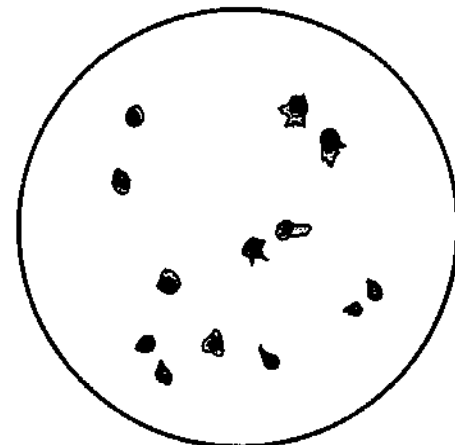

Volume of blood in the human body

An adult weighing 60 kilograms has about $\frac{1}{2}$ litres of blood.

There is therefore no danger involved in taking $\frac{1}{2}$ litre of blood for transfusion, and no risk in taking two 10 ml tubes or more for analysis. Make this clear to anxious patients when you take their blood.

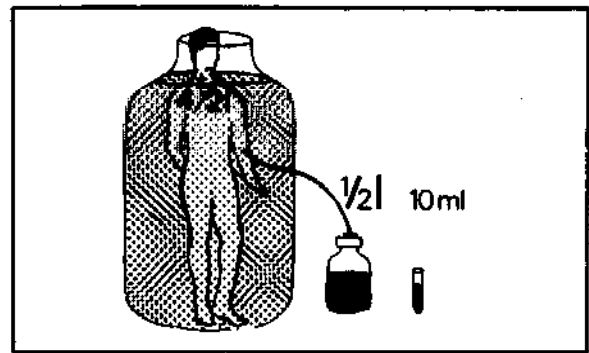

Clotting of blood

When blood is collected in a glass tube it solidifies within 5–10 minutes, forming a clot; it has coagulated.

If a special anticoagulant is added to the blood as soon as it is collected, clotting is prevented and the blood remains fluid. Examples of anticoagulants: fluoride oxalate, trisodium citrate, EDTA dipotassium salt solution, Wintrobe mixture (see page 465 *et seq.*).

What happens to clotted blood

After several hours, clotted blood separates into two components:

1. *the serum*, a yellow liquid
2. *the clot*, a solid red mass.

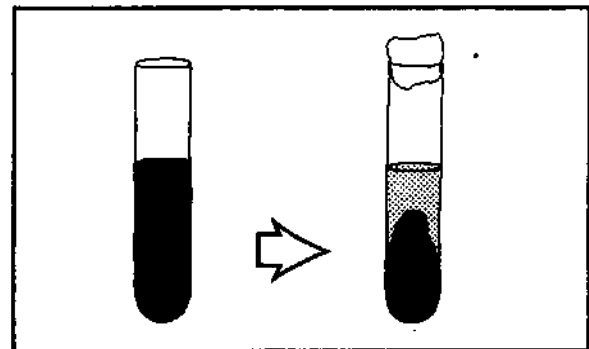

What happens to unclotted blood

Blood treated with an anticoagulant separates into two liquid components:

1. *the plasma*, a yellow liquid
2. *the blood cells*, which sediment:
 - a thin layer of white cells and a deposit of red cells.

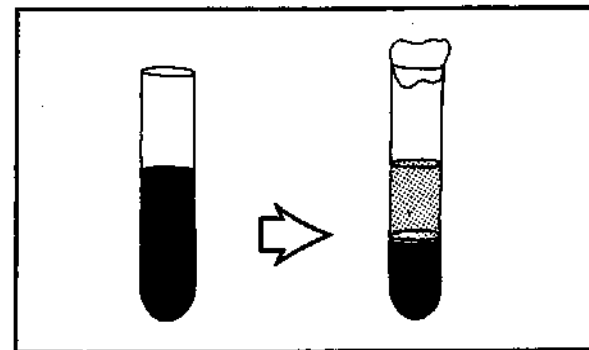

What is the difference between plasma and serum?

- Plasma contains a soluble protein called fibrinogen.
- Serum does not contain this protein. The fibrinogen is changed into insoluble fibrin, which together with the red cells forms the clot.

17. Collection of Venous Blood

Principle

Venous blood is collected from a vein in the arm with a needle and syringe.

MATERIALS

For disinfecting the skin

- 70% ethanol, or tincture of iodine
- Cotton wool.

For the venepuncture

- A tourniquet of soft rubber tubing, 2-5 mm bore.
- Needles
 - length: 30-40 mm
 - diameter or gauge: 0.9 mm (20 gauge)
 - 1.0 mm } (19 gauge)
 - 1.1 mm }
 - 1.2 mm (18 gauge)
- bevel: medium.

(Needle sizes are usually indicated by length and diameter.)
For taking blood from children under five, 23 gauge (0.6 mm) or 25 gauge (0.5 mm) needles can be used.

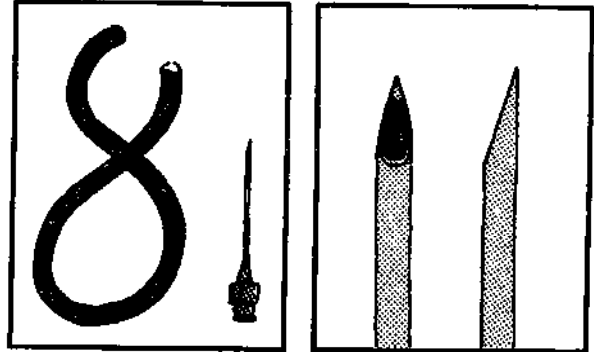

Keep a stock of sterile needles in small glass tubes: the point should rest on a pad of non-absorbent cotton wool and the tube be plugged with the same material.

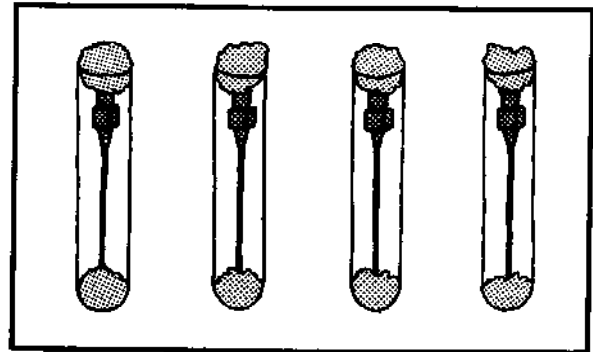

For collection of blood

(a) Syringes (of 2, 5, 10 or 20 ml capacity)

Check that the end of each syringe fits into the needle.

- P. = Pravaz-Record syringe
- L. = Luer syringe (American)
- LL. = Luer-Lok syringe.

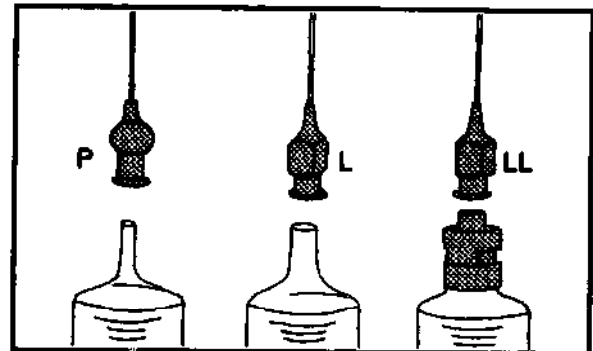

(b) Bottles or tubes

These should either be empty or contain an anticoagulant (for anticoagulants see pages 68-69), and should bear a mark corresponding to the required amount of blood (e.g. at the 5 ml level).

METHOD

Read carefully the patient's request form.

- Decide how much blood is needed.
- Prepare the correct bottle or tube to be used for each test.

Before taking the blood, wash your hands with soap and water.

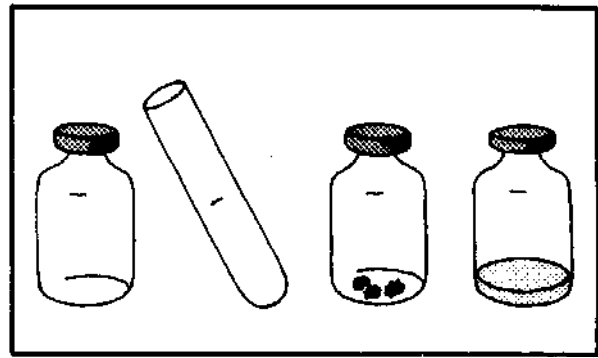

Patient in the laboratory

Ask the patient to sit alongside the table used for taking blood.

Lay his arm on the table, palm upwards, and support it by placing a small cushion under the elbow.

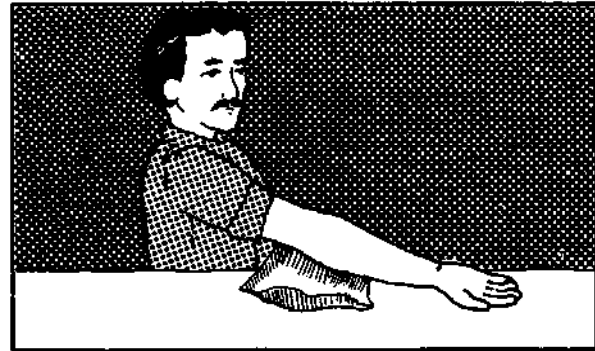

Patient in bed

Lay the patient's arm in an outstretched position.



Where to take the blood

The correct site is the vein in the bend of the elbow, at its thickest and most easily visible point, preferably one of the branches forming a Y just above their junction (1).

If necessary, points 2, 3 and 4 can be used as alternatives.

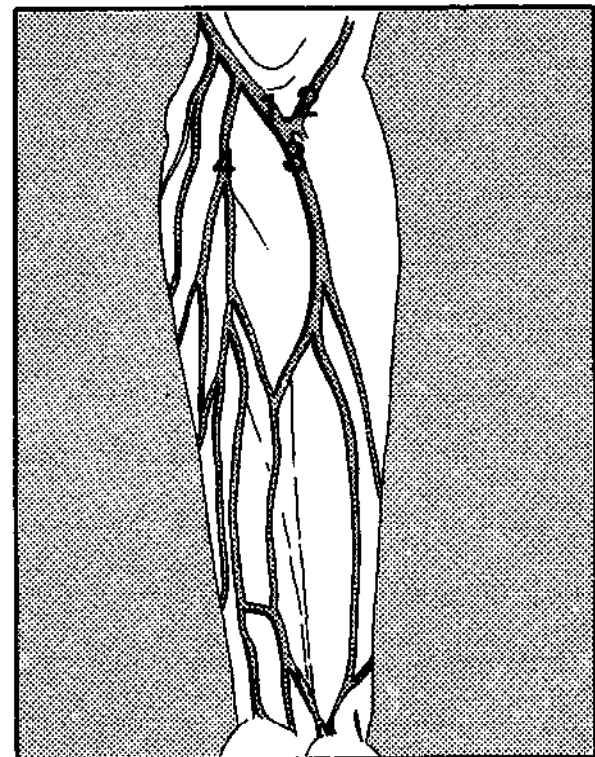

Using a syringe

1. Fix the needle on to the syringe, touching only the top of the needle. Test the needle and syringe to make sure that the needle is not blocked and the syringe is airtight.

Place the end of the needle in the sterile tube until ready for use.

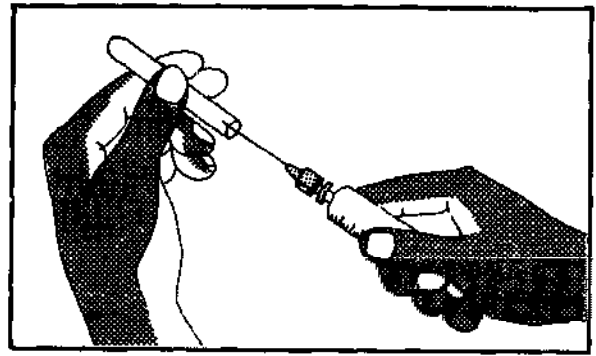

Apply the tourniquet.

2. With the right hand, wrap the tourniquet firmly round the arm and hold the ends.

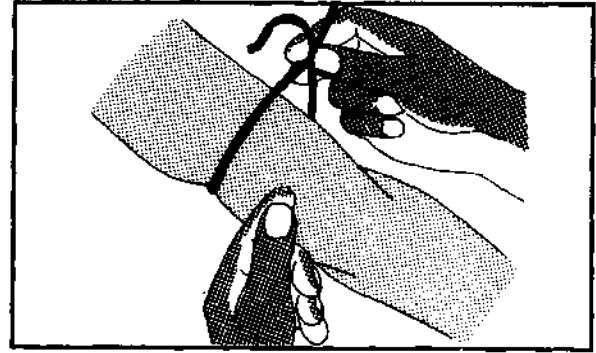

3. With the left hand, pull one of the ends across.

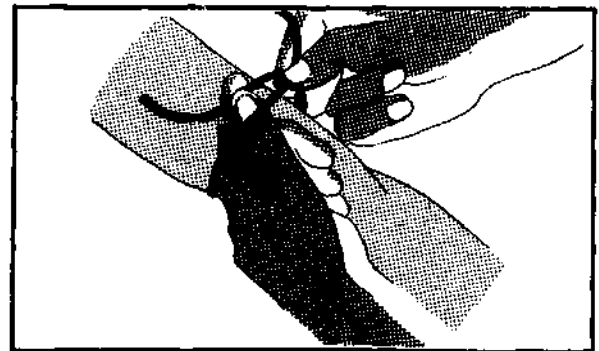

4. Loop it under the main part of the tourniquet. The tourniquet should be just tight enough to slow down the blood flow in and distend the veins, but it must not be so tight that the blood flow in the arteries is diminished.

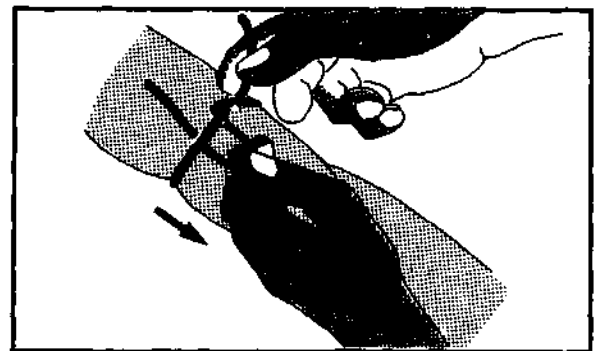

5. Ask the patient to open and close his hand several times, to swell the veins.

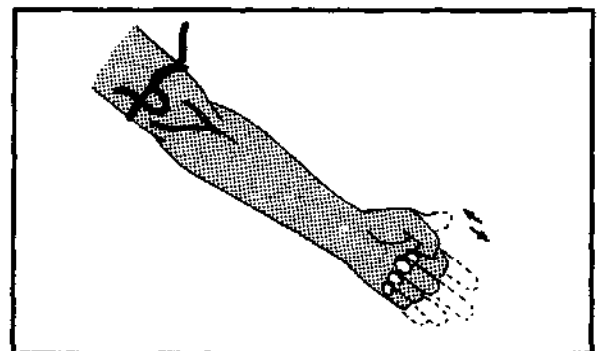

6. Using the index finger of your left hand, feel for the vein where you will introduce the needle.

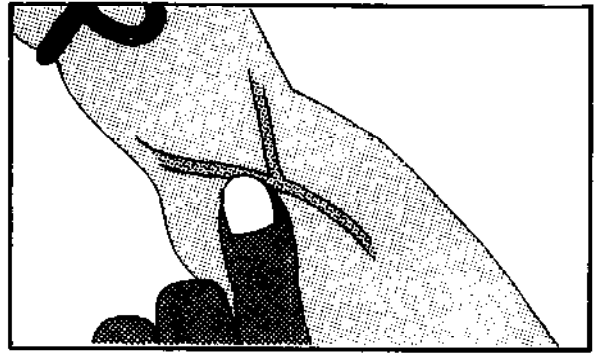

7. Disinfect the skin with a swab dipped in tincture of iodine or ethanol.

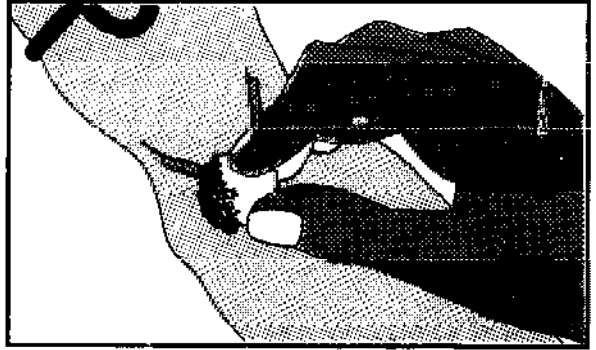

8. Take the syringe in the right hand, holding your index finger against the top of the needle.

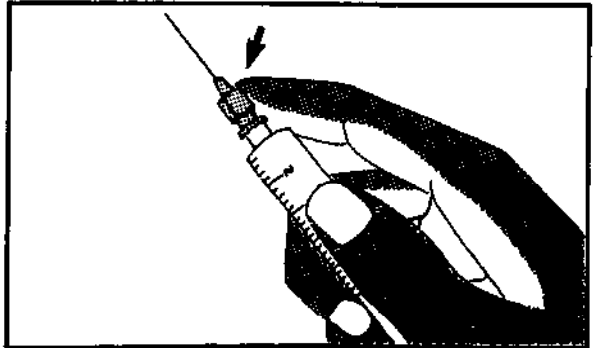

9. Position the needle with the bevel uppermost. Make the venepuncture entering the centre of the vein without hesitation.

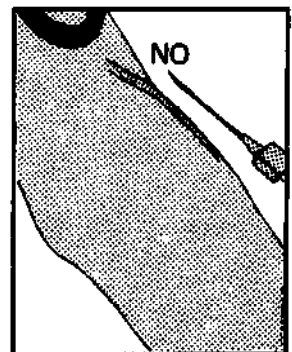
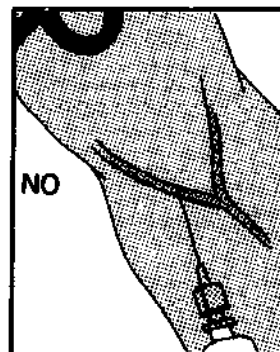
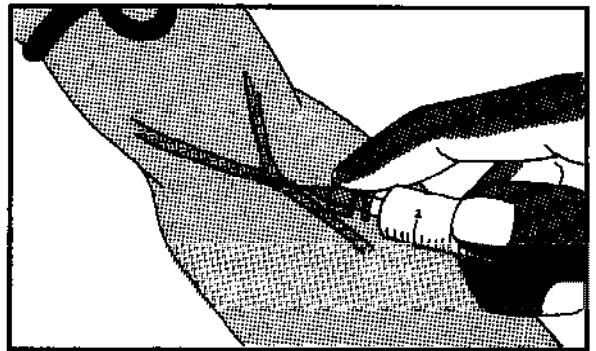

Important:

Never approach a vein from the side.
Never introduce a needle with the bevel downwards.

You will feel the needle going through:

- (a) the layer of skin, which is resistant
- (b) then the wall of the vein, which is less resistant (more flexible).

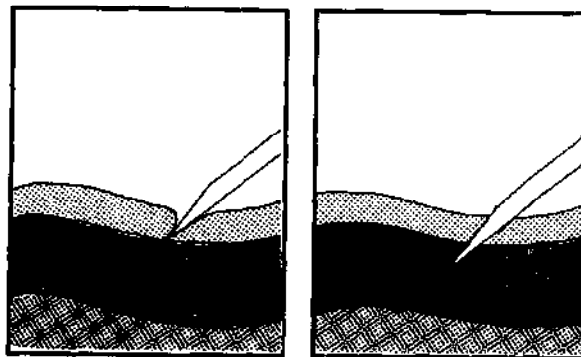

10. Push the needle along the line of the vein to a depth of 1-1.5 cm.

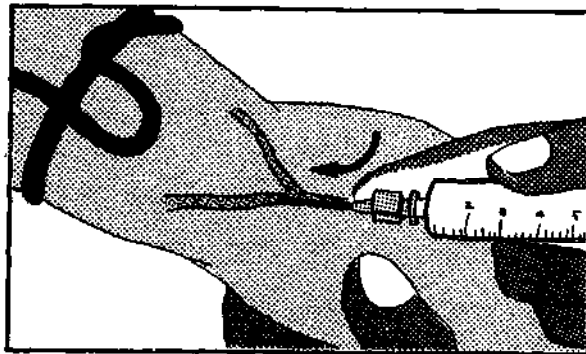

11. With your left hand pull back the piston of the syringe slowly. Blood should appear in the syringe. Continue to withdraw the piston to fill the syringe with the amount of blood required.

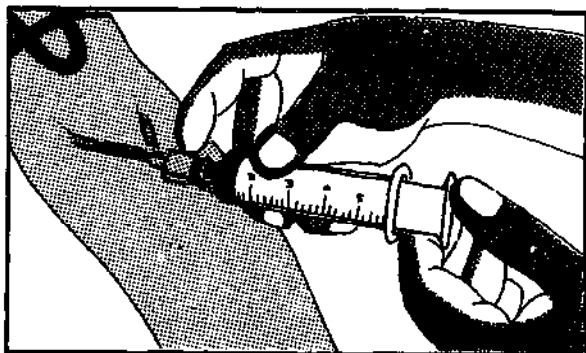

12. Remove the tourniquet by pulling on the looped end.

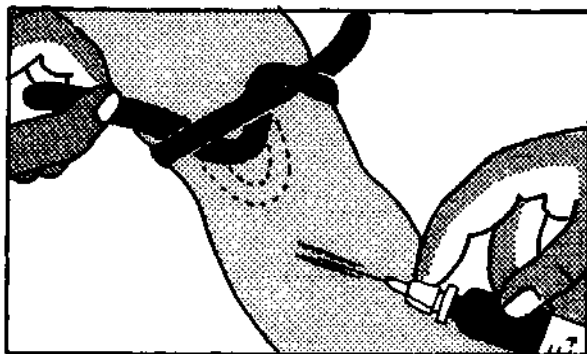

13. Apply a dry swab over the hidden point of the needle. Withdraw the needle in one rapid movement from under the swab.

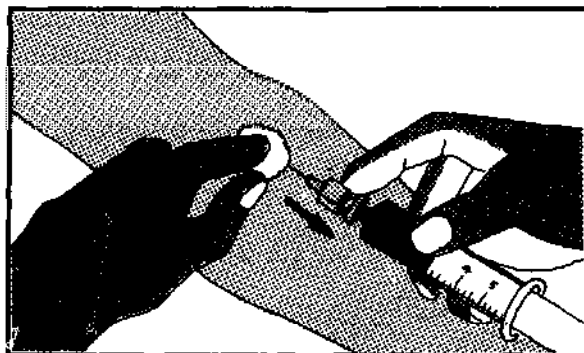

14. Ask the patient to press firmly on the cotton wool swab for 3 minutes, keeping his arm outstretched.
Bending the arm back over the swab is no longer recommended (because of the risk of a haematoma).

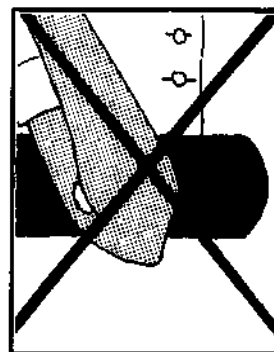
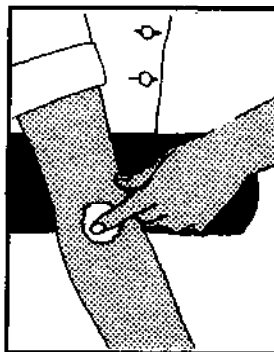

15. Remove the needle from the syringe.
Fill the specimen tubes or bottles with the blood up to the mark.
Invert the bottles that contain anticoagulant several times.

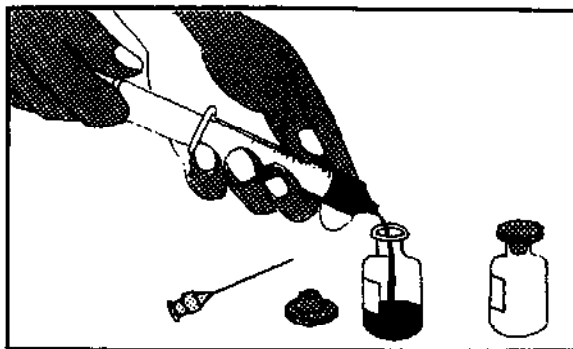

16. Label the bottles clearly with:
- the patient's name
 - the date
 - the patient's outpatient or hospital number, if this is available.

Rinse the needle and syringe at once with cold water.

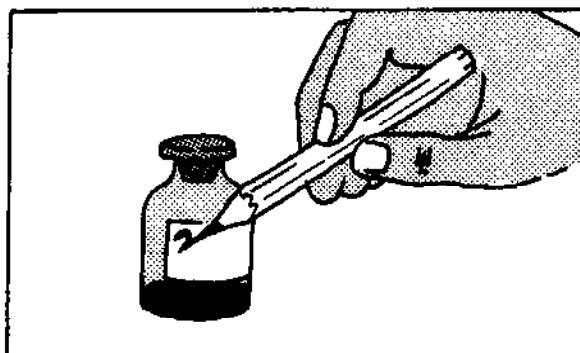

COLLECTION OF CAPILLARY BLOOD

A few drops of blood taken from the finger (or toe in infants) are enough for certain laboratory examinations.

Examples:

- blood cell number concentrations ("count")
- erythrocyte volume fractions
- haemoglobin estimation
- detection of parasites.

The following may be used:

- disposable blood lancets
- sterile lancets
- Hagedorn needles (No. 7 or 8).

For the method of collecting capillary blood, see page 189.

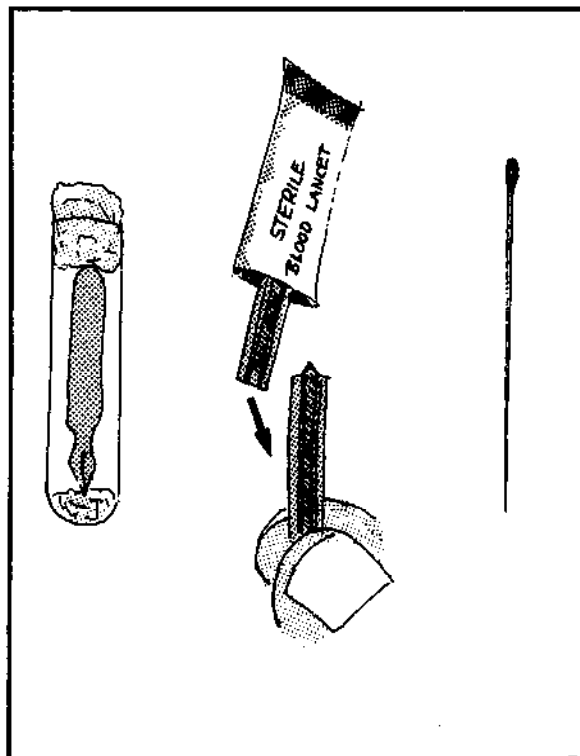

STERILIZING OF LANCETS AND NEEDLES

Clean lancets and needles are placed in small glass tubes plugged with non-absorbent cotton wool and sterilized in the autoclave or the dry-heat sterilizer.

18. Leukocyte Number Concentration

The number of leukocytes (white cells) contained in 1 litre of blood is called the leukocyte number concentration. (In traditional units, it is expressed as the number of cells per cubic millimetre and is called the leukocyte or white cell "count".)

Principle

The blood is diluted in a leukocyte diluting fluid which:

- haemolyses (destroys) the red cells
- leaves the white cells intact.

The leukocytes (white cells) are then counted in a counting chamber under the microscope, and the number of cells in every litre of blood is calculated.

Purposes

In certain diseases the number of leukocytes in the blood is altered. For example, in some infections there is a marked increase.

MATERIALS

Pipettes

1. Blood pipette graduated to the 50 μl (0.05 ml or 50 mm^3) mark with rubber tubing and mouthpiece.

The use of bulb pipettes is not recommended as they are inaccurate, difficult to use and clean, and more expensive.

2. 1 ml graduated pipette.

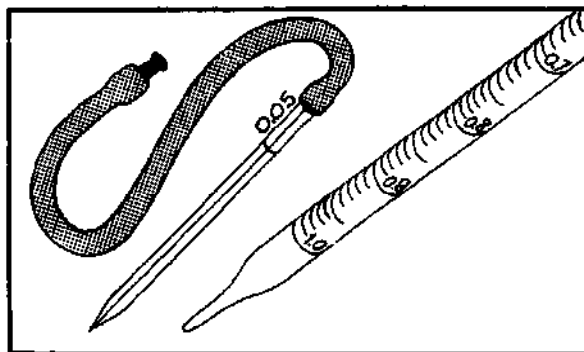

Different types of ruled chamber can be used, including:

- improved Neubauer, preferably "bright-line"
- Bürker.

The Thoma chamber has a small ruled area and is therefore not recommended for leukocyte counts.

The counting chamber is covered with a special cover glass supplied with the chamber.

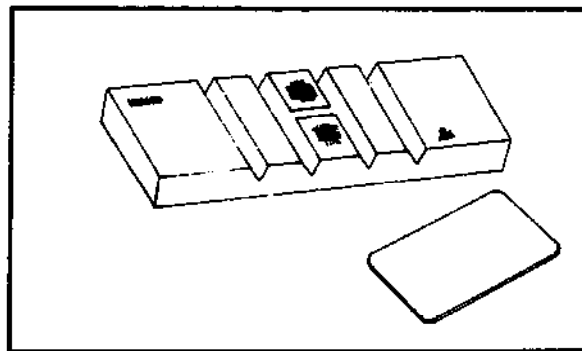

Diluting fluid

- Türk solution (reagent No. 55).

Hand tally counter, if possible.

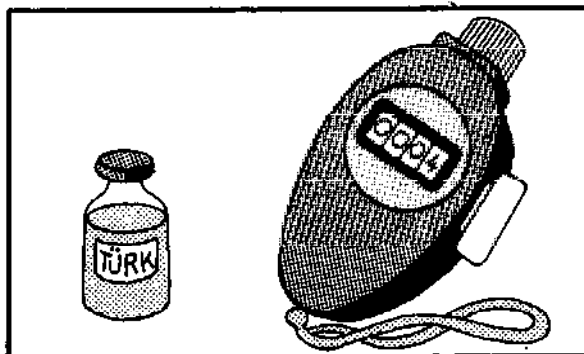

METHOD

1. Pipette 0.95 ml of diluting fluid into a small bottle, using the 1 ml graduated pipette.

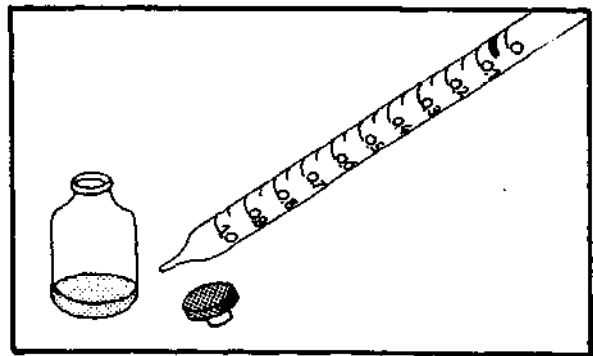

2. Draw venous or capillary blood to the 0.05 ml mark of the blood pipette. Do not allow air bubbles to enter. With venous blood ensure that it is well mixed by inverting the bottle containing it and the anticoagulant (see page 68) repeatedly for about 1 minute immediately before pipetting it.

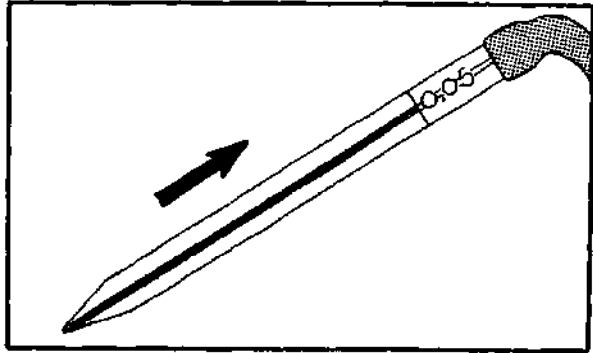

3. Wipe the outside of the pipette with absorbent paper. Check that the blood is still on the mark.

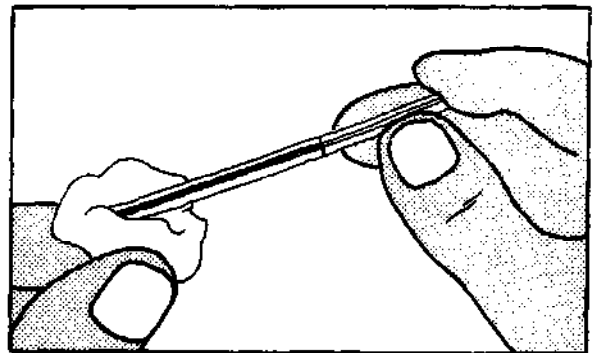

4. Blow the blood into the bottle of diluting fluid. Rinse the pipette by drawing in and blowing out the fluid 3 times. The dilution of the blood is 1 in 20. Label the bottle with the patient's name or number.

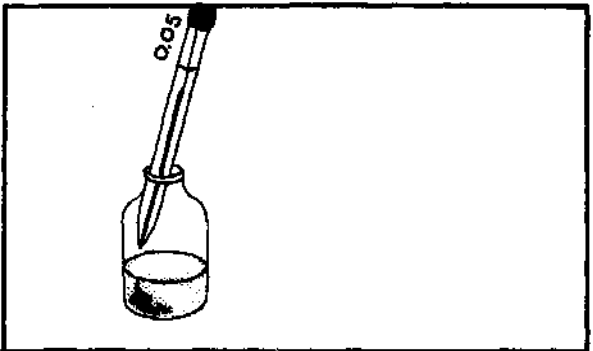

5. Attach the coverglass to the counting chamber, pressing it carefully into place.

When the coverglass is properly attached, coloured bands, called Newton's rings, appear between the two glass surfaces.

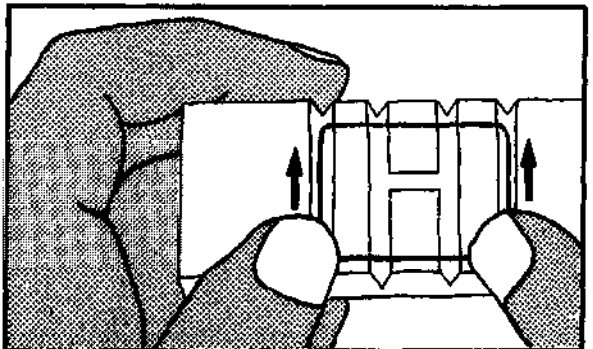

6. Mix well the diluted blood.
Using a Pasteur pipette fill the counting chamber.
Take care not to overfill beyond the ruled area.

Important: If the liquid overflows into the channel between the 2 chambers, you must start again: remove the coverglass, clean it and the counting chamber, and refill with another drop.

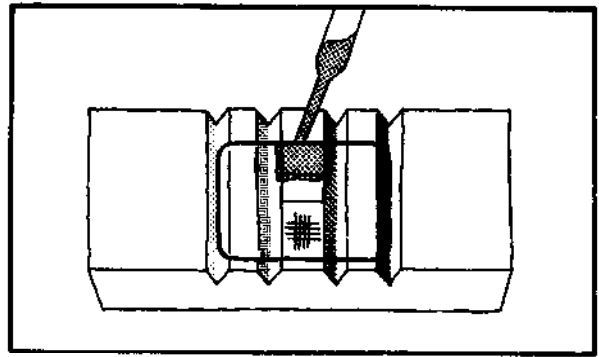

7. Leave the counting chamber on the bench for 3 minutes to allow the cells to settle.
8. Place the chamber on the stage of the microscope.
Use the x 10 objective (x 6 or x 10 eyepieces).
Reduce the amount of light entering the condenser by adjusting the iris diaphragm. Focus the rulings of the chamber and the leukocytes.
Do not mistake pieces of dust for leukocytes.

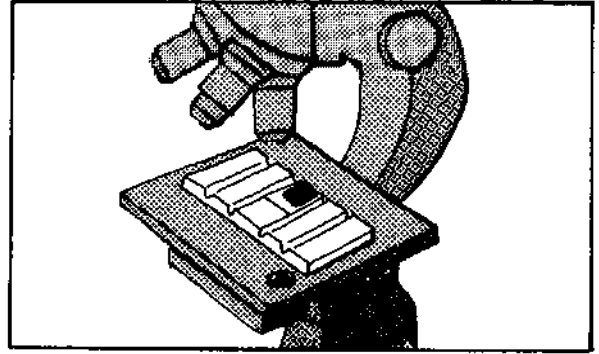

Counting of leukocytes

(a) Using the improved Neubauer ruled chamber

- Area of chamber = 9 mm^2
- Depth of chamber = 0.1 mm

Count the cells in an area of 4 mm^2 using the squares numbered 1, 3, 7 and 9 as shown in the diagram.

Include in the count the cells seen on the lines of two sides of each square counted, as shown below.

This square represents one of the four counted, i.e. 1, 3, 7 and 9.

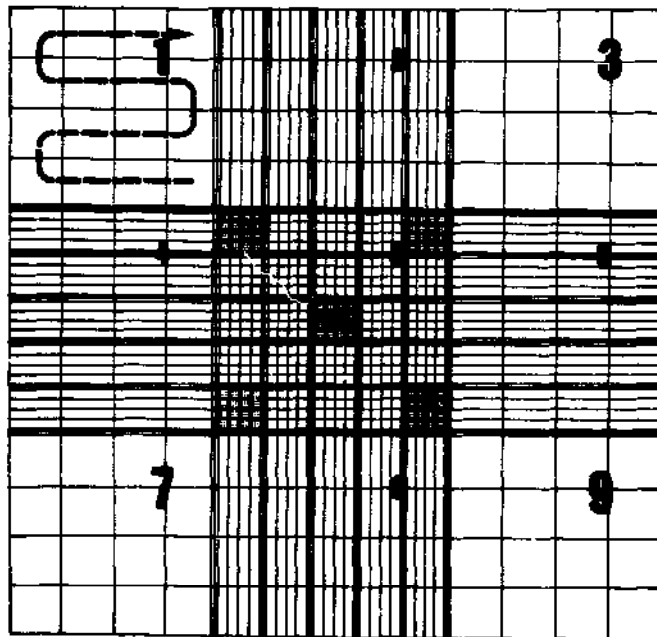
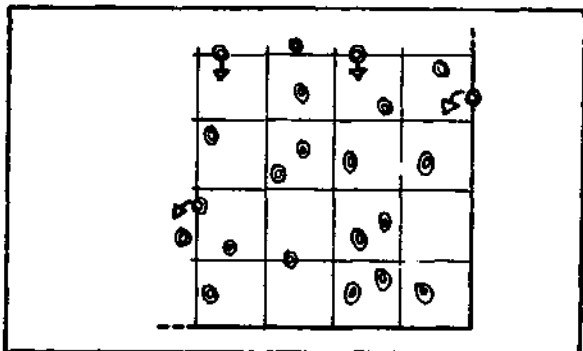

Calculate the number of cells in 1 litre of blood:*

- Multiply the number of cells counted in the four squares by 0.05
- Report the result as "number $\times 10^9$ / l"

Example:

Number of cells counted = 188

Cells in 1 litre = $(188 \times 0.05) \times 10^9$

Result reported: 9.4×10^9 / l

Explanation of calculation

Each of the four squares in which cells are counted has an area of 1 mm^2 ; the total area is therefore 4 mm^2 . The chamber depth is 0.1 mm , therefore the volume in which cells are counted is $4 \times 0.1 = 0.4 \text{ mm}^3$. Thus division by 4 and multiplication by 10 will give the number of cells in 1 mm^3 of diluted blood. Since the dilution is 1 in 20, multiplication by 20 will give the number of cells in 1 mm^3 of undiluted blood. Finally, there are 1 million (10^6) cubic millimetres in 1 litre, so multiplication by 10^6 will give the number of cells per litre of undiluted blood. This may be summed up as follows:

$$\begin{aligned} \text{Cells per litre} &= \frac{\text{cells counted} \times 10 \times 20}{4} \times 10^6 \\ &= \text{cells counted} \times 50 \times 10^6 \\ &= \text{cells counted} \times 0.05 \times 10^9 \end{aligned}$$

Example:

188 cells are counted in the four squares. The number of cells per cubic millimetre of undiluted blood is therefore

$$\frac{188 \times 10 \times 20}{4} (= 188 \times 50 = 9400)$$

$$\text{and the number per litre is } \frac{188 \times 10 \times 20}{4} \times 10^6 = 9400 \times 10^6 = 9.4 \times 10^9$$

* The calculation and example are given in SI units. However, the traditional unit (number of cells per cubic millimetre) is also explained in the text. (Multiplication of the number of cells counted by 50 gives the number of cells per cubic millimetre.)

(b) Using the Bürker ruled chamber

- Area of chamber = 9 mm^2
- Depth of chamber = 0.1 mm

Count the cells in an area of 4 mm^2 using the squares numbered 1, 3, 7 and 9, as shown in the diagram.

Include in the count the cells seen on the lines of two sides of each square counted (see page 363).

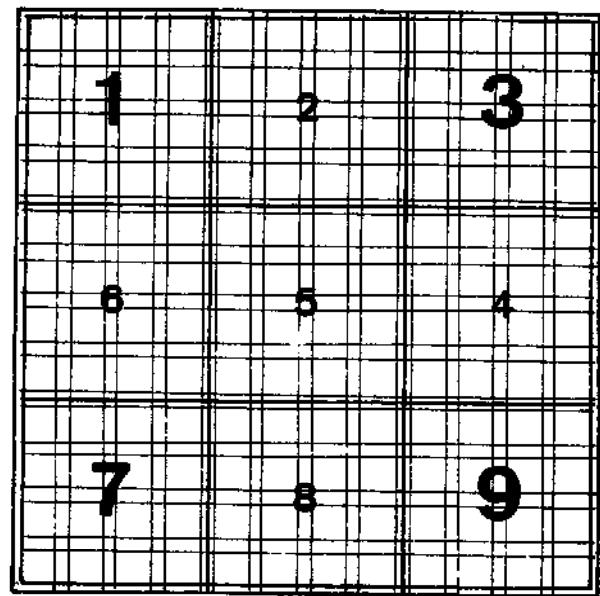

Calculation and example: as for improved Neubauer ruled chamber.

RESULTS

Normal range

	SI units (cells $\times 10^9$ per litre)	Traditional units (cells per mm^3)
Men and women	4-10	4 000-10 000
Children of 10 years	4-10	4 000-10 000
Children of 3 years	4-11	4 000-11 000
Infants (3-9 months)	4-15	4 000-15 000
Newborn infants	10-20	10 000-12 000

High values

An increase in the total number of circulating white cells is called *leukocytosis*. This can occur with certain pyogenic bacterial infections. In leukaemia, leukocyte number concentrations of $50 \times 10^9/\text{l}$ to $400 \times 10^9/\text{l}$ ($50\,000/\text{mm}^3$ to $400\,000/\text{mm}^3$), or even higher values, can be found. It is then necessary, when determining the number concentration, to use a greater dilution of blood – for example, 0.05 ml of blood and 1.95 ml of diluting fluid, which gives a dilution of 1 in 40. If this dilution is used, the number of cells counted is multiplied by 0.1 instead of by 0.05 in order to give the number $\times 10^9$ per litre (if traditional units are being used, multiply by 100 instead of 50 to give the number per cubic millimetre).

Low values

A decrease in the total number of circulating white cells is called *leukopenia*. This can occur with certain infections including typhoid fever and malaria. Leukopenia is also seen following treatment with certain drugs. When the leukocyte number concentration is very low, it is necessary to dilute the blood less – for example, 0.05 ml of blood and 0.45 ml of diluting fluid, which gives a dilution of 1 in 10. If this dilution is used, the number of cells counted is multiplied by 0.25 instead of by 0.05 to give the number $\times 10^9$ per litre (if traditional units are being used, multiply by 25 instead of 50 to give the number per cubic millimetre).

Correction for nucleated red cells

Nucleated red cells or normoblasts (see page 403) are not normally present in the blood. They may, however, be present in the blood in certain diseases such as sickle cell anaemia and other haemolytic anaemias. Normoblasts are not haemolysed in the diluting fluid and are therefore counted with the leukocytes. When normoblasts are present in large numbers, the leukocyte number concentration must be corrected as follows.

Examine a thin Romanowsky-stained blood film (see page 393) and count the number of normoblasts seen for every 100 white cells.

Calculation*

The number concentration of normoblasts (per litre) is:

$$\frac{\text{No. of normoblasts counted}}{100 + \text{No. of normoblasts counted}} \times \text{leukocyte number concentration}$$

Example

If 50 normoblasts are counted and the leukocyte number concentration is $16 \times 10^9/l$, the number concentration of normoblasts is:

$$\frac{50}{100 + 50} \times 16 = 5.3 \times 10^9/l$$

and the corrected leukocyte number concentration is $16 - 5.3 = 10.7 \times 10^9/l$.

* In traditional units, the concentrations of normoblasts and leukocytes are expressed per cubic millimetre. In such units, the calculation for the example given would be:

$$\frac{50}{100 + 50} \times 16\,000 = 5\,300/\text{mm}^3$$

Corrected leukocyte or white cell count = $16\,000 - 5\,300 = 10\,700/\text{mm}^3$.

19. Erythrocyte Number Concentration

The number of erythrocytes (red cells) contained in 1 litre of blood is called the erythrocyte number concentration. (In traditional units, it is expressed as the number of cells per cubic millimetre and is called the erythrocyte or red cell "count".) Accurate determinations of the erythrocyte number concentration are difficult to make with a counting chamber, and it is recommended that the erythrocyte volume fraction (haematocrit, PCV) and the haemoglobin concentration be determined instead. However, the counting of red cells is described for places where the erythrocyte volume fraction cannot be determined.

Principle

The blood is diluted in a red cell diluting fluid. The red cells are counted in a counting chamber under the microscope, and the number of cells in every litre of blood is calculated.

MATERIALS

- Pipettes:
 - (a) blood pipette (often called Sahli pipette) graduated to the 0.02 ml (20 mm^3 or $20 \mu\text{l}$) mark, with rubber tubing and mouthpiece.
- The use of bulb pipettes is not recommended as they are inaccurate, difficult to use and clean, and more expensive.
- (b) 5 ml graduated pipette.
- Counting chamber. Several counting chambers can be used; the use of the improved Neubauer ruled chamber will be described.
- Diluting fluid – formaldehyde citrate solution (reagent No. 24).
- Hand tally counter, if possible.

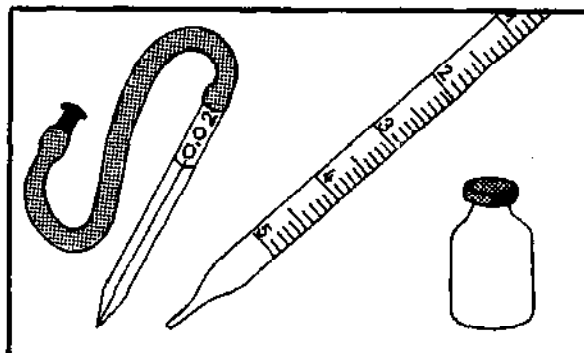

METHOD

1. Pipette 4.0 ml of diluting fluid into a small bottle, using the 5 ml graduated pipette.

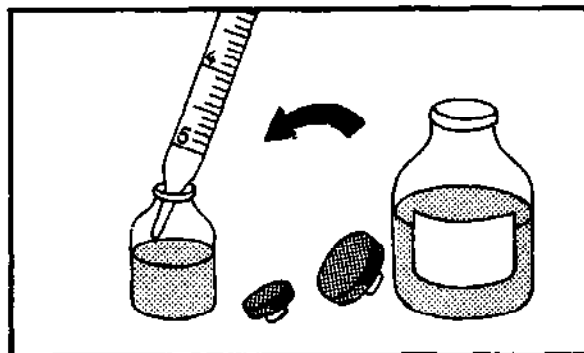

2. Draw venous or capillary blood to the 0.02 ml mark of the blood pipette. Do not allow air bubbles to enter. With venous blood ensure that it is well mixed by inverting the bottle containing it and the anticoagulant (see page 68) repeatedly for about 1 minute immediately before pipetting it.

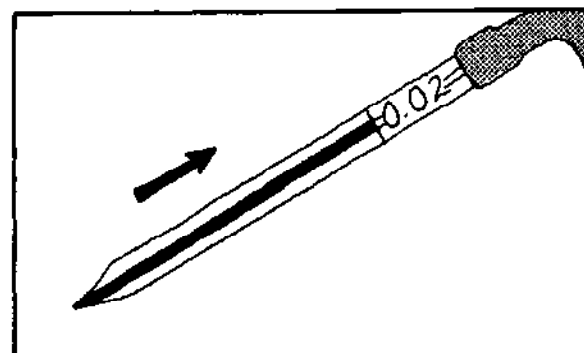

3. Wipe the outside of the pipette with absorbent paper.
Check that the blood is still on the mark.

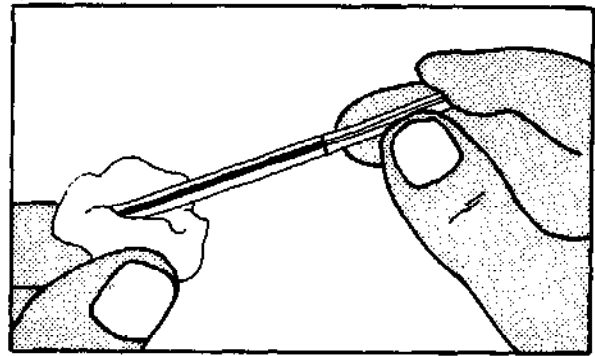

4. Blow the blood into the bottle of diluting fluid.
Rinse the pipette by drawing in and blowing out
the fluid 3 times.
The dilution of the blood is 1 in 200.
Label the bottle with the patient's name or
number.

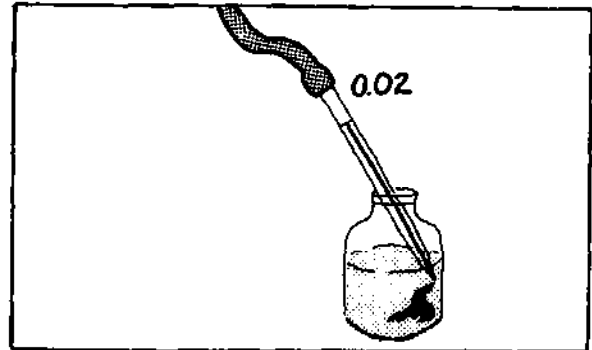

5. Attach the coverglass to the counting chamber
as described on page 361.
Mix well the diluted blood.
Using a Pasteur pipette, fill the two ruled
areas of the chamber. Take care not to overfill
beyond the ruled areas.

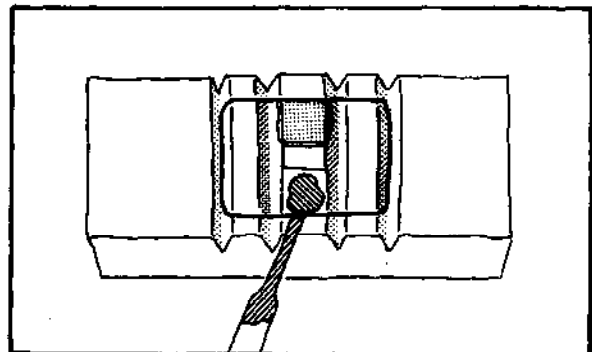

6. Leave the counting chamber on the bench for
3 minutes to allow the cells to settle.
7. Place the chamber on the stage of the microscope.
Use the x 10 objective, find the centre square
of the chamber, then change to the x 40 objective
to count the red cells.

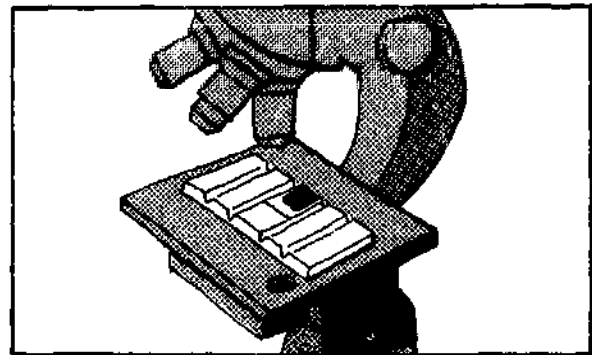

Counting of red cells

Using an improved Neubauer ruled chamber:

Count the cells in an area of 0.2 mm^2 , using the squares marked A, B, C, D and E.

Include in the count the cells on the lines of two sides of each square counted as shown below.

This square represents one of the five counted, i.e. A, B, C, D and E.

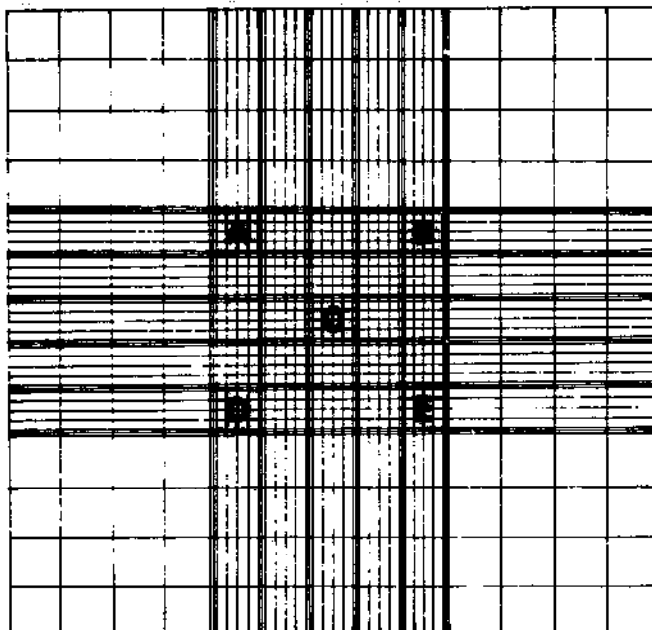
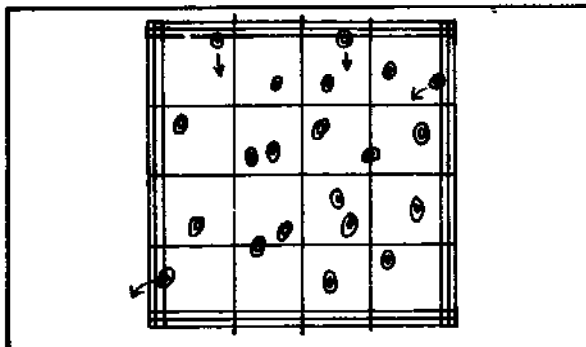

Calculate the number of cells in 1 litre of blood:

- Multiply the number of cells counted in the first group of five squares by 0.01
- Do the same with the number of cells counted in the second set of five squares
- Take the average of the two figures
- Report the result as "number $\times 10^{12}/l$ "

Example:

Number of cells counted in (a) first ruled chamber = 390

Number of cells counted in (b) second ruled chamber = 370

Cells per litre (a) = $(390 \times 0.01) \times 10^{12}$
= 3.9×10^{12}

Cells per litre (b) = $(370 \times 0.01) \times 10^{12} = 3.7 \times 10^{12}$

Average (result reported) = $3.8 \times 10^{12}/l$

Explanation of calculation

Each of the five squares in which cells are counted has an area of 0.04 mm^2 ; the total area is therefore 0.2 mm^2 . The chamber depth is 0.1 mm , therefore the volume in which cells are counted is $0.2 \times 0.1 = 0.02 \text{ mm}^3$. Thus division by 2 and multiplication by 100 (i.e. multiplication by 50) will give the number of cells per cubic millimetre of diluted blood. Since the dilution is 1 in 200, multiplication by 200 will give the number of cells in 1 mm^3 of undiluted blood. Finally, there are 1 million (10^6) cubic millimetres in 1 litre, so multiplication by 10^6 will give the number of cells in 1 litre of undiluted blood. This may be summed up as follows:

Cells per cubic millimetre = cells counted $\times 50 \times 200 =$ cells counted $\times 10\,000$

Since the concentration of red cells is so high, it is easier to write it in millions.

$$\begin{aligned}\text{Cells per cubic millimetre} &= \frac{\text{cells counted} \times 10\,000}{1\,000\,000} \text{ millions} \\ &= (\text{cells counted} \times 0.01) \text{ millions} \\ &= (\text{cells counted} \times 0.01) \times 10^6\end{aligned}$$

The number of cells in 1 litre will be 10^6 times this number, therefore:

$$\begin{aligned}\text{Cells per litre} &= \text{cells counted} \times 0.01 \times 10^6 \times 10^6 \\ &= \text{cells counted} \times 0.01 \times 10^{12}\end{aligned}$$

Example:

390 cells are counted in the first group of five squares. The number of cells in 1 mm^3 of undiluted blood is therefore $390 \times 0.01 \times 10^6 = 3.9$ million. The concentration per litre of undiluted blood is $390 \times 0.01 \times 10^{12}$, or $3.9 \times 10^{12}/l$.

RESULTS

Normal range

	SI units: cells x 10 ¹² per litre	Traditional units: millions of cells per cubic millimetre
Men	4.5-5.5	4.5-5.5
Women	4.0-5.0	4.0-5.0
Children (4 years)	4.2-5.2	4.2-5.2
Infants (1-6 months)	3.8-5.2	3.8-5.2
Newborn infants	5.0-6.0	5.0-6.0

Note that the numbers are the same in both SI units and traditional units – e.g., $5.0 \times 10^{12}/l$ or 5.0 millions/mm³. However, values in traditional units are sometimes written out in full – e.g., 5 000 000/mm³.

Low concentrations

Patients with anaemia caused by red cell loss or red cell haemolysis will have low concentrations.

High concentrations

Patients who are dehydrated or have polycythaemia will have high red cell concentrations.

CLEANING THE EQUIPMENT

1. *Cleaning materials and preparations*

A wide range of cleaning materials should be kept for the maintenance of all the equipment: pipettes, counting chamber, coverglass, etc. The items recommended here are routine and easy to obtain:

- rubber bulb and, if available, vacuum pump
- 500 and 50 ml beakers
- 95% ethanol. Ether. Acetone.
- 0.5% acetic acid in water: acetic acid 5 ml
distilled water 1000 ml.
- Dichromate cleaning solution (reagent No. 16)
- If available: sodium bicarbonate.

2. *Pipettes: daily cleaning*

(a) *Soaking*

Soak pipettes in clean tap water.

(b) *Cleaning*

Using a vacuum pump, or rubber bulb, draw through each pipette the following:

- dilute acetic acid (3 times)
- clean water, distilled if plentiful (4 times)
- air (hold the pipette tip upwards)
- acetone (once)
- air (to dry as much as possible).

(c) *Drying*

If possible use an incubator, leaving the pipettes overnight at 37 °C in a container padded with non-absorbent cotton wool.

If the pipette is required at once use:

- water, preferably distilled
- ether
- dry completely in the air.

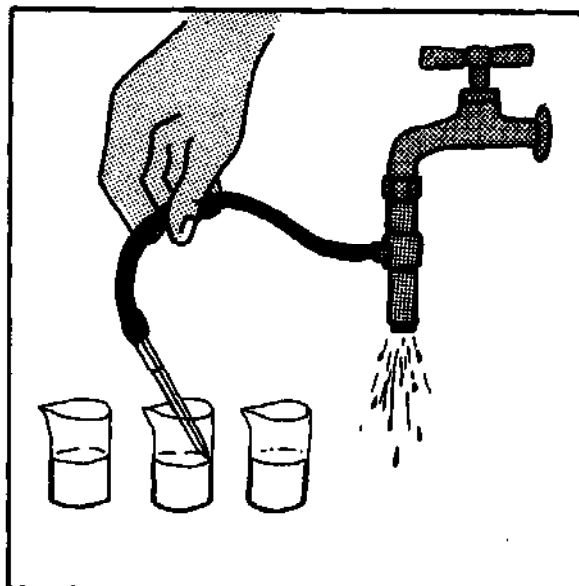

3. *Pipettes: monthly cleaning (more often if necessary)*

- (a) Soak the pipettes in a beaker of dichromate cleaning solution for about 12 hours.
- (b) Rinse the outside, then the inside, with ordinary tap water.
- (c) Soak the pipettes in a beaker of weak sodium bicarbonate solution (approximately 10 g/l; 1%) for 12 hours.
- (d) Clean as described under "daily cleaning".

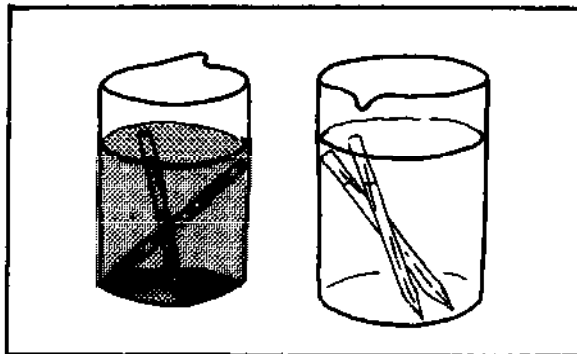

4. *Blocked pipettes*

Try to force a fine nylon thread (000 type) through the mouth of the pipette while applying suction at the other end.

If this fails, leave to soak for 12 hours in a beaker of dichromate cleaning solution.

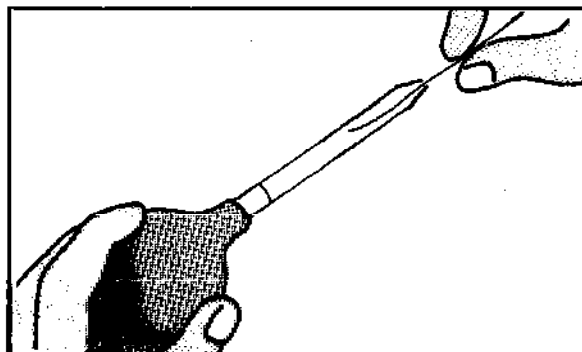

5. *Cleaning of counting chambers and coverglasses*

Clean as soon as possible after use:

- soak in a solution of detergent powder for 2-3 hours
- rinse well under running tap water
- rinse with ethanol, if available
- dry with a soft cloth.

Never use scouring powder as it will scratch the ruled surface of the chamber.

When several tests are done, clean as soon as possible after use by rinsing in water and wiping with a soft clean cloth. Once a month the chamber needs a more thorough cleaning, as above.

20. Haemoglobin: Estimation of Cyanmethaemoglobin, Photometric Method

Haemoglobin is the red pigment contained in the red blood cells. It consists of protein chains and iron-containing molecules. It carries oxygen to the tissue cells of the body.

Units of measurement

Strictly, the SI unit for expressing haemoglobin concentrations is millimole per litre (mmol/l). When this unit is used, it is necessary to specify the chemical structure to which it applies. In practice, this means that the term "haemoglobin(Fe)" should be used instead of the simple term "haemoglobin". However, as an interim measure, before making the change to millimole per litre, some laboratories are using the unit "gram per litre" (g/l). When this unit is used, the simple term "haemoglobin" suffices, and it is not necessary to say "haemoglobin(Fe)". Values in gram per litre may be converted into values in millimole per litre by multiplying by 0.062. Example:

$$\text{haemoglobin } 150 \text{ g/l} \times 0.062 = \text{haemoglobin(Fe) } 9.3 \text{ mmol/l}$$

In this manual calculations and values are usually expressed in both forms. It should be noted that if the unit "gram per litre" is used, the values are 10 times larger than values in the traditional unit "gram per 100 ml". For example, 150 g/l = 15.0 g/100 ml.

Principle

The blood is diluted in Drabkin diluting fluid, which haemolyses the red cells, converting the haemoglobin into cyanmethaemoglobin. The solution obtained is examined in a spectrophotometer or colorimeter. Its absorbance is proportionate to the amount of haemoglobin in the blood.

The cyanmethaemoglobin photoelectric method gives the most accurate haemoglobin estimations. It should be used wherever possible.

MATERIALS

- Photoelectric colorimeter* or spectrophotometer
- Pipettes
 - (a) Blood (Sahli) pipette graduated to 0.02 ml (20 mm³ or 20 μl) with rubber tubing and mouthpiece
 - (b) 5 ml graduated pipette
- Test-tubes
- Drabkin diluting fluid (reagent No. 17).

The reagent can be bought in tablet or powder forms to be dissolved in 1 litre of distilled water. If an analytical balance is available the reagent can be made in the laboratory (see reagent No. 17). The solution can be kept for 1 month in a brown bottle. If the solution becomes cloudy, discard it.

Drabkin diluting fluid must not be allowed to freeze, as this can result in decolorization with reduction of the ferricyanide.

- Cyanmethaemoglobin Reference (Standard)
Solution can be bought, or obtained from a reference laboratory.
The concentration of a bought reference solution is usually given in milligrams per 100 ml (usually commercially labelled mg%).

*Some photometers run either on mains electricity or on current from a motor-car battery. One model is supplied by UNICEF: ref. 09.309.98 (110 V - battery) or 9.310.00 (220 V - battery).

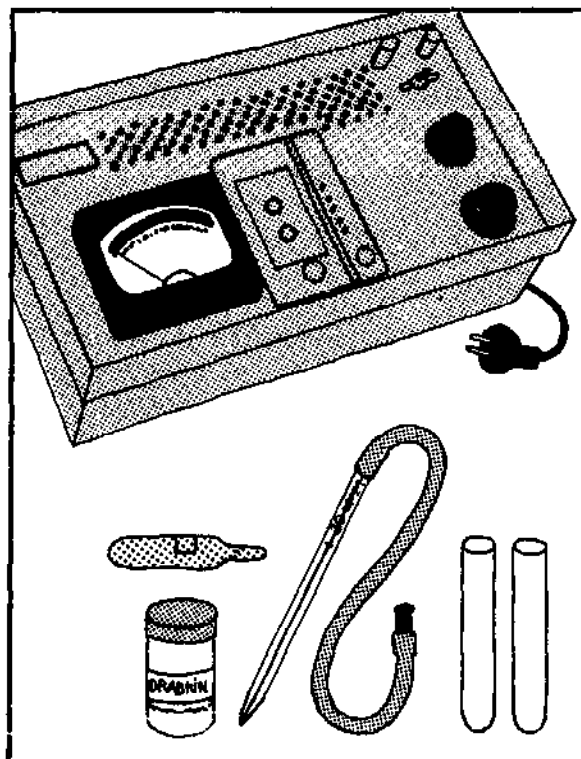

CALIBRATION OF THE COLORIMETER

A calibration curve must be prepared before the colorimeter can be used for haemoglobin estimations. From such a curve a graph can be prepared and a table made for the haemoglobin values.

Method

1. Calculate the haemoglobin value of the reference solution in grams per litre by using the following formula:

$$\frac{\text{concentration in mg/100 ml} \times 10}{1\ 000} \times 251$$

(Note: 10 is the factor for converting 100 ml to 1 litre, 1 000 is the factor for converting milligrams to grams, and 251 is the dilution factor when 0.02 ml of blood is diluted with 5 ml of Drabkin diluting fluid.)

Since $10 \times 251/1\ 000$ is very nearly 2.5, the above formula can be simplified as follows:*

haemoglobin value of reference solution in grams per litre = concentration in mg/100 ml x 2.5

Example

Concentration of reference solution = 60 mg/100 ml

Haemoglobin value = 60×2.5
= 150 g/l

* If a dilution of 1 in 200 is used (i.e. 0.02 ml of blood and 4 ml of Drabkin diluting fluid), multiply by 2.0 instead of 2.5.

2. Make a series of dilutions of the standard solution:
 - prepare 4 tubes and label 1 to 4
 - pipette into each tube as follows:

Tube number	1	2	3	4
Standard solution	4.0 ml	2.0 ml	1.3 ml	1.0 ml
Drabkin fluid	–	2.0 ml	2.7 ml	3.0 ml
Dilution of standard	Undiluted	1 in 2	1 in 3	1 in 4

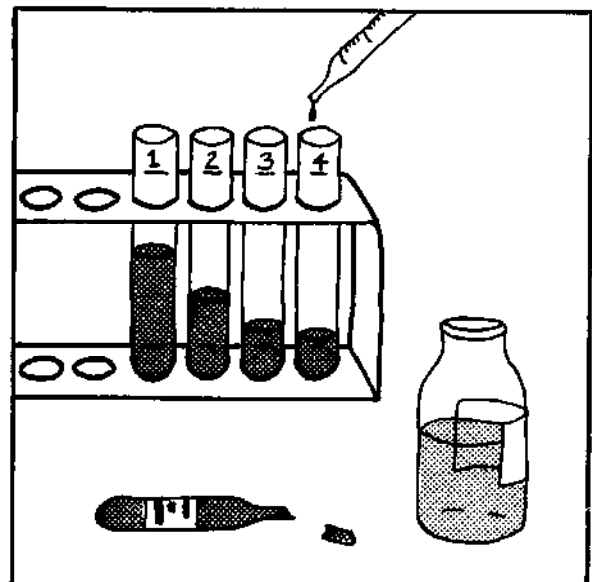
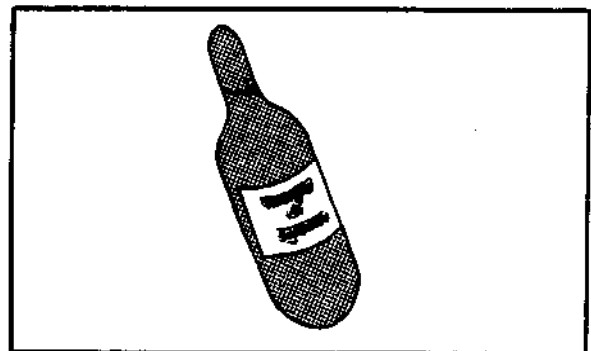

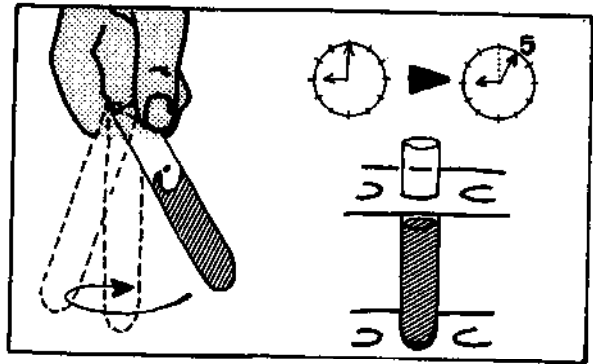

3. Mix and allow to stand for 5 minutes.

4. Read the dilutions in the colorimeter:

- place a green filter (Ilford No. 625) in the colorimeter or set the wavelength at 540 nanometres (nm)
- fill a matched colorimeter test-tube or cuvette with Drabkin diluting fluid and place in the colorimeter
- zero the colorimeter
- read the contents of tubes 1 to 4, using a colorimeter test-tube or cuvette.

Make sure the needle returns to zero between each reading with Drabkin fluid.

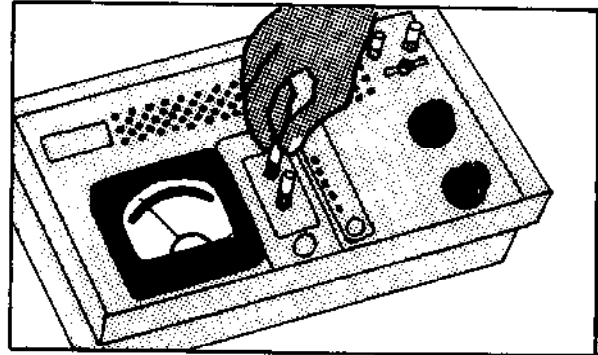

5. Prepare a graph, plotting the colorimeter readings of the diluted standard solutions against their concentrations.

Example

Reference solution concentration calculated as 15 g/l

Standard dilution	Haemoglobin concentration (g/l)	Absorbance
Undiluted	150	35.0
1 in 2	$\frac{150}{2} = 75$	17.5
1 in 3	$\frac{150}{3} = 50$	11.5
1 in 4	$\frac{150}{4} = 37.5$	8.5

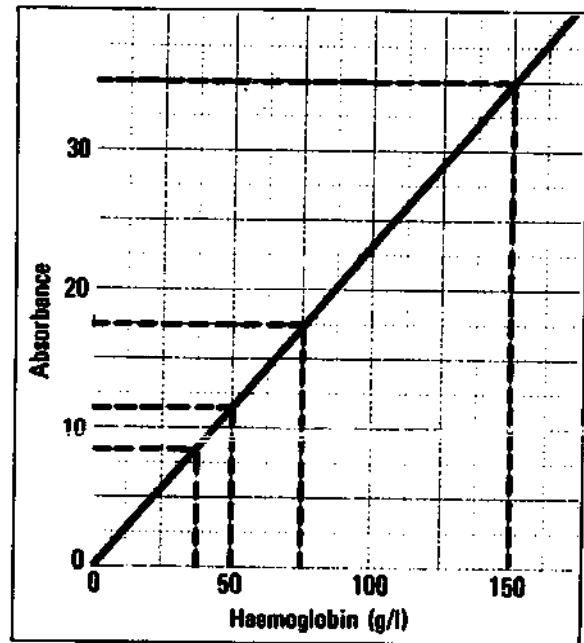

6. From the graph:

- make a table of haemoglobin values from 20 to 180 g/l.

Important:

At the beginning of each day:

- clean the matched colorimeter test-tubes or cuvettes
- fill one of the cleaned tubes with fresh Drabkin diluting fluid, which is used to zero the colorimeter
- read a reference solution. This can be:
 - (a) the fresh cyanmethaemoglobin reference solution used to calibrate the instrument, or
 - (b) a reference grey solution previously calibrated against the cyanmethaemoglobin reference.

HAEMOGLOBIN ESTIMATION USING PATIENT'S BLOOD (cyanmethaemoglobin method)

1. Pipette 5 ml of Drabkin diluting fluid into a tube.

Draw venous or capillary blood to the 0.02 ml mark of a Sahli pipette. Do not allow air bubbles to enter. With venous blood ensure that it is well mixed by inverting the bottle containing it and the anticoagulant (see page 68) repeatedly for about 1 minute immediately before pipetting it.

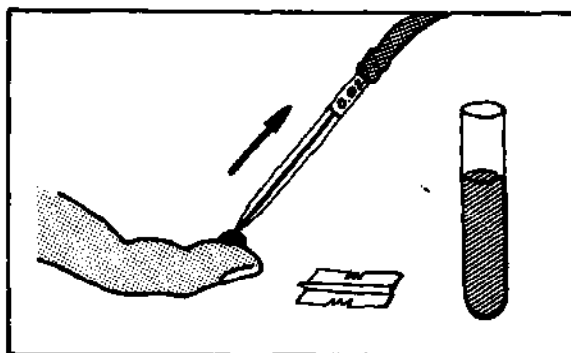

2. Wipe the outside of the pipette. Check that the blood is still on the mark.

Blow the blood into the Drabkin fluid and rinse the pipette several times by drawing up and blowing out the fluid in the tube three times.

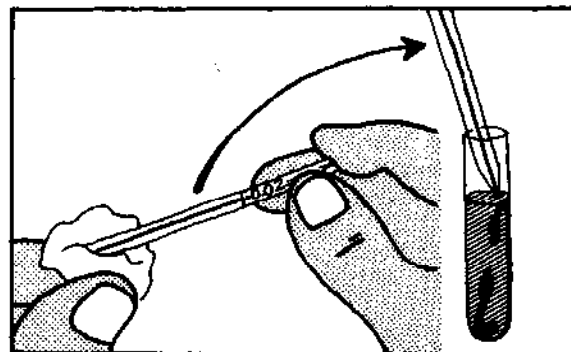

3. Mix the contents of the tube and leave for 5 minutes.

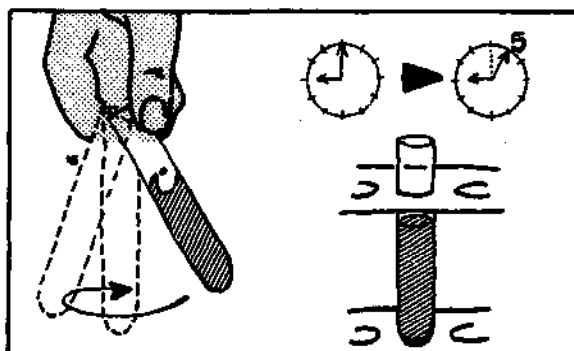

4. Zero the colorimeter, using Drabkin diluting fluid.

Read the absorbance of the patient's diluted blood, using the colorimeter test tube or cuvette.

If cloudiness appears in the diluted blood, this may be attributable to abnormal plasma proteins or to a high leukocyte concentration. Centrifuge the fluid before reading in the colorimeter.

Using the table prepared from the calibration curve, record the haemoglobin in g/l.

RESULTS – NORMAL RANGE

	Haemoglobin(Fe) mmol/l	Haemoglobin g/l
Children at birth	8.4-12.1	136-186
Children at 1 year	7.0- 8.1	113-130
Children, 10-12 years	7.1- 9.2	115-148
Women	7.1-10.2	115-165
Men	8.1-11.2	130-180

21. Haemoglobin Estimation Using a Comparator

Principle

This is a visual method for estimating haemoglobin. The test solution is compared with a series of coloured glass standards that show the amount of haemoglobin.

MATERIALS

- Haemoglobin comparator with standards to cover the range 3-13 g of haemoglobin per decilitre (g/dl)
- Two comparator tubes
- 0.05 ml (50 mm³ or 50 μ l) pipettes
- Haemoglobin diluting fluid. This is made by adding 0.4 ml of strong ammonia solution to 1 litre of distilled water.

METHOD

1. Fill a test tube with 10 ml of the diluting fluid.

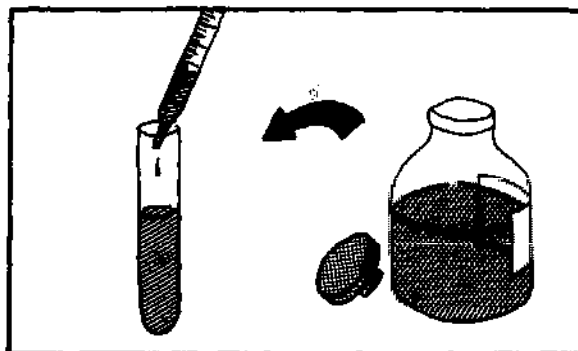

2. Draw venous or capillary blood to the 0.05 ml (or 50 mm³ or 50 μ l) mark of the blood pipette. Do not allow air bubbles to enter. With venous blood ensure that it is well mixed by inverting the bottle containing it and the anticoagulant (see page 68) repeatedly for about 1 minute immediately before pipetting it.

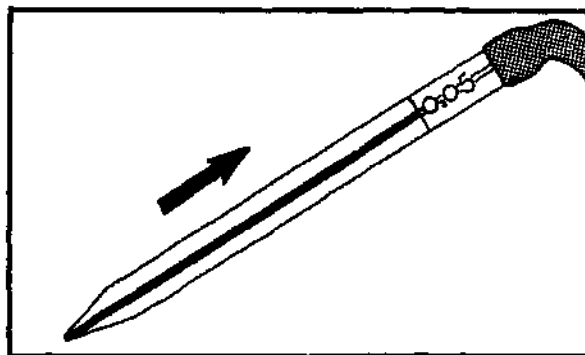

3. Wipe the outside of the pipette, check that the blood is still on the mark, and wash into the 10 ml of diluting fluid.
4. Mix the contents of the tube.
The fluid will become a clear red as the red cells are haemolysed. The colour of the solution will not fade for a few hours.
5. Fill one of the comparator tubes to the mark with the fluid. Lift the lid of the comparator and place the tube in the right-hand side of the comparator.

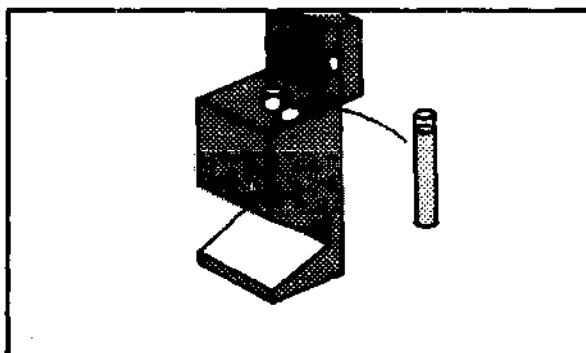

6. Fill the other comparator tube to the mark with the diluting fluid and place this in the left-hand side of the comparator. Close the lid.

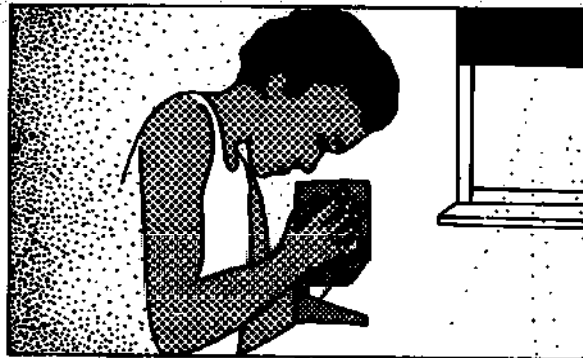

7. Holding the equipment with the front of the comparator directed towards the daylight, look down through the viewing aperture, as seen in the drawing.

8. Daylight must be used, but do not hold the comparator in direct sunlight.

9. Starting with the pale-coloured standards, compare each with the colour of the test solution, as seen in the left-hand side of the viewing aperture.

When the colours are matched as closely as possible, make a final check by comparing with the standard on each side of the one selected.

10. Read the haemoglobin value in grams per decilitre (g/dl) as shown on the disc used to rotate the standards.

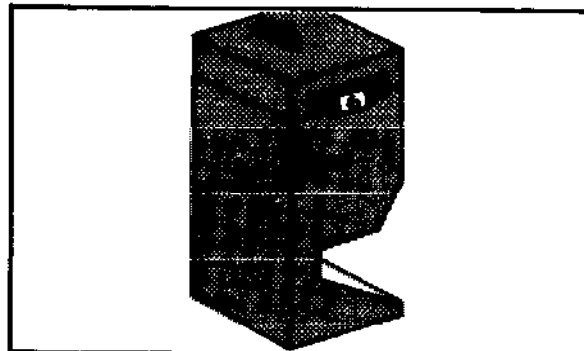

11. When the colour of the test lies between two standards, make an estimate between the two values.

If the test fluid is darker than the 3.0 g/dl standard, report the haemoglobin as greater than 3.0 g/dl. Alternatively dilute the test, using equal volumes of test fluid and diluting fluid (2.5 ml test fluid and 2.5 ml of diluting fluid). Multiply the value obtained by 2.

(Multiply by 10 to obtain the haemoglobin value in g/l, or multiply by 0.62 to give the haemoglobin (Fe) value in mmol/l.)

22. Haemoglobin Estimation by Sahli Method

PRINCIPLE

The blood is diluted in an acid solution, converting the haemoglobin to acid haematin. The test solution is matched against a coloured glass reference.

MATERIALS

- Sahli haemoglobinometer
- Sahli pipette (graduated to 20 mm³, i.e. 0.02 ml, or 20 μ l)
- Small glass rod
- Dropping pipette
- Absorbent paper
- 0.1 mol/l (0.1 N) hydrochloric acid (HCl) (reagent No. 32).

Inaccurate method

The Sahli method is not an accurate way of estimating haemoglobin. Not all the forms of circulating haemoglobin are changed into acid haematin; the colour changes, when viewed visually, are not very great; and the brown colour of the standard is not a true match for an acid haematin solution.

As some places still use this method it is described, but it is not recommended.

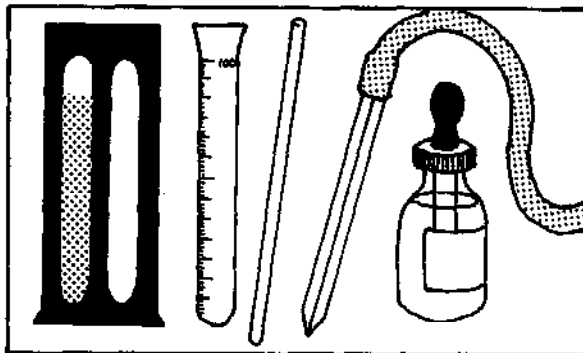

METHOD

1. Fill the graduated tube to the 20 mark (or the mark 3 g/100 ml) with 0.1 mol/l HCl.
2. Draw venous or capillary blood to the 0.02 ml mark of the Sahli pipette. Do not allow air bubbles to enter. With venous blood ensure that it is well mixed by inverting the bottle containing it and the anticoagulant (see page 68) repeatedly for about 1 minute immediately before pipetting it. (Do not take the first drop of blood from the finger.)
3. Wipe the outside of the pipette with absorbent paper. Check that the blood is still on the mark.
4. Blow the blood from the pipette into the graduated tube of the acid solution. Rinse the pipette by drawing in and blowing out the acid solution 3 times. The mixture of blood and acid gives a brownish colour. Allow to stand for 5 minutes.

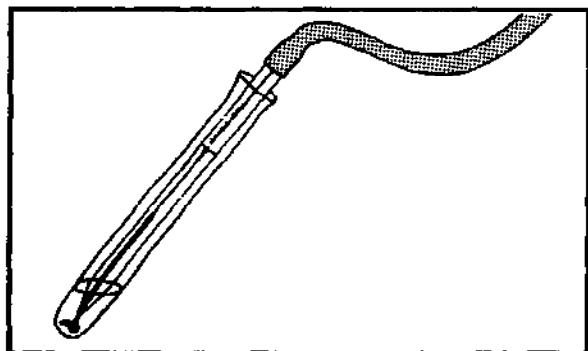
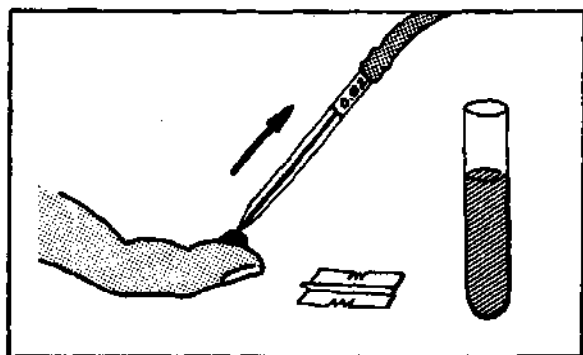
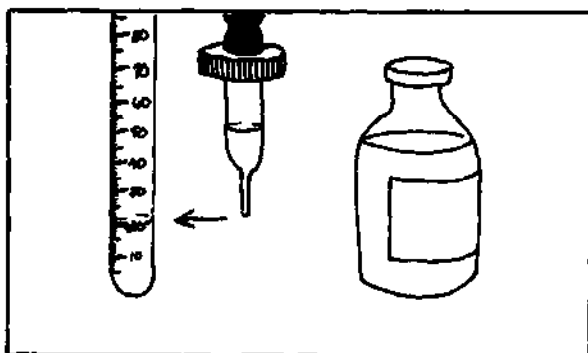

5. Place the graduated tube in the haemoglobinometer. Stand facing a window. Compare the colour of the tube containing diluted blood with the colour of the reference tube.

If the colour is the same as or lighter than that of the reference tube the haemoglobin value is 40 g/l or less.

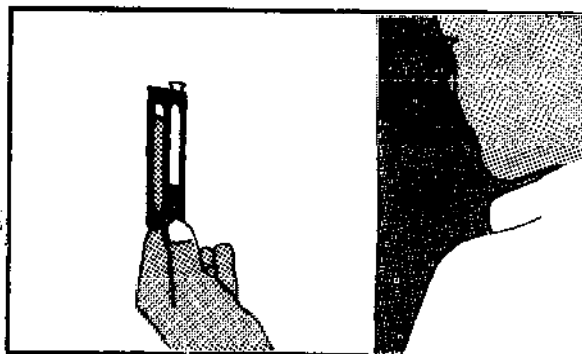

6. If the colour is darker than that of the reference tube continue to dilute by adding 0.1 mol/l HCl drop by drop. Stir with the glass rod after adding each drop. Remove the rod and compare the colours of the 2 tubes.

Stop when the colours match. Distilled water can also be used at this step instead of 0.1 mol/l HCl to continue the dilution of the blood.

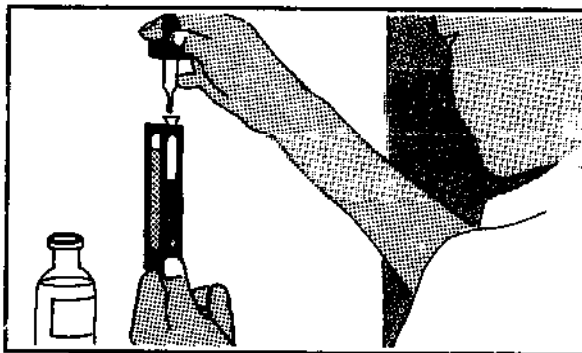

7. Note the mark reached. Depending on the type of haemoglobinometer, this gives the haemoglobin concentration either in g/100 ml or as a percentage of "normal" (the latter type, illustrated, is not recommended). To convert g/100 ml to g/l, multiply by 10. To convert percentages to g/l, multiply by 1.46.

Examples:

(a) $14.8 \text{ g/100 ml} \times 10 = 148 \text{ g/l}$

(b) $85\% \times 1.46 = 124 \text{ g/l}$

(The Sahli method is so unreliable that factors for converting results into mmol/l are not given.)

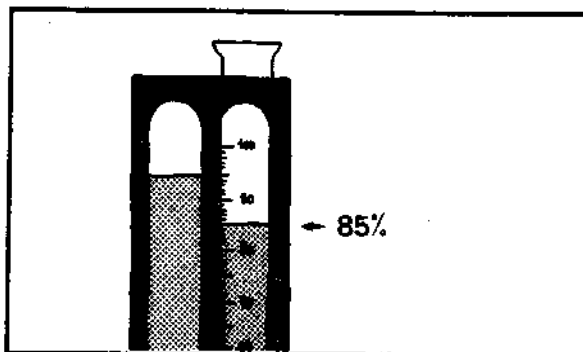

23. Erythrocyte Volume Fraction

Principle

The total volume of the erythrocytes (red cells) in a given volume of blood divided by the volume of blood is called the erythrocyte volume fraction. For example, if the volume of the red cells in 1 litre (1 000 ml) of blood is 450 ml, the erythrocyte volume fraction is $450 \text{ ml}/1\,000 \text{ ml} = 0.45$ (since the fraction is millilitres divided by millilitres, the unit "ml" cancels out, and the result is a simple decimal fraction with no unit). The remainder of the blood is made up almost entirely of plasma, together with a small volume of white cells (leukocytes). If the latter are ignored, the plasma volume fraction in the above example would be $550 \text{ ml}/1\,000 \text{ ml} = 0.55$ (note that $0.45 + 0.55 = 1.0$, i.e. erythrocyte volume fraction plus plasma volume fraction = 1). The erythrocyte volume fraction is therefore a measure of the proportion of red cells to plasma. It is used in estimating the mean erythrocyte haemoglobin concentration (see page 386), and is of diagnostic value in patients suffering from dehydration, shock, or burns.

Before the introduction of SI units, the erythrocyte volume fraction was called either "haematocrit" or "packed cell volume" (PCV), and it was reported as a percentage rather than a decimal fraction. In the traditional system, the "packed cell volume" in the example given above would be 45%. Note that, in using SI units, the numerical value does not change, but becomes 0.45 instead of 45%.

Macro scale

The blood (mixed with anticoagulant) is placed in a graduated tube and centrifuged to pack the red cells. The level of the column of red cells is then read directly in the graduated tube.

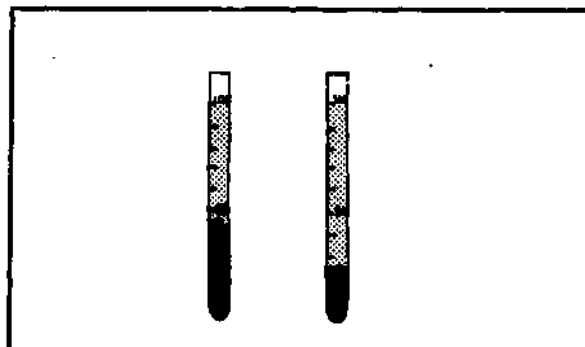

Micro scale

The blood is placed in a long capillary tube and centrifuged using a "microhaematocrit head" attachment. The level reached by the column of red cells is read with a scale reader.

This method is preferable: it is quicker, and blood from the finger can be used.

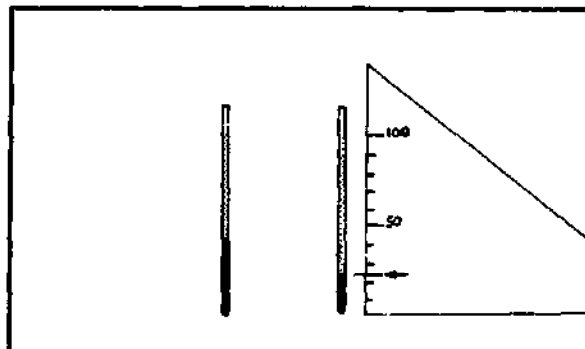

METHOD – MICRO SCALE

Materials

- “Microhaematocrit” centrifuge (electric), with a special flat head, to revolve at high speed
- Specially designed scale for reading the results (usually provided with the centrifuge)
- Capillary tubes containing heparin:
 - 75 mm long
 - 1.5 mm bore(they contain a deposit of dried heparin as anticoagulant).

If venous blood mixed with EDTA dipotassium salt is used the capillary tubes do not need to contain heparin; plain tubes can be used.

- Soft wax or plastic modelling clay (or a spirit lamp)
- Blood lancet and ethanol for taking capillary blood.

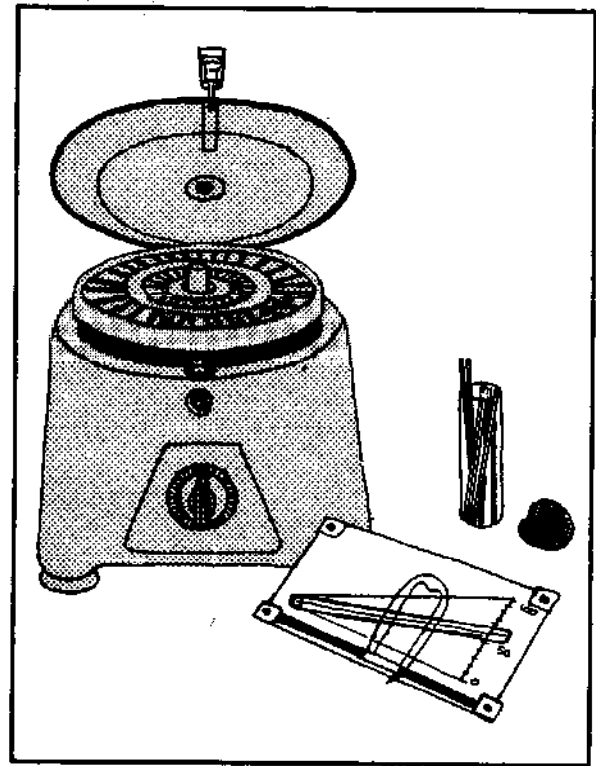

Taking capillary blood

Using a blood lancet, draw blood by pricking:

- the 3rd or 4th finger
- or the lobe of the ear
- or the heel (infants),

after sterilizing the area with ethanol.

The blood should flow freely or with very little pressure to the area. Wipe away the 1st drop with filter paper.

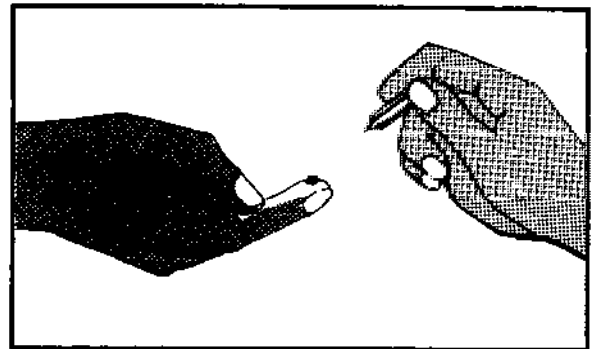

Measurement technique

1. Apply the tip (circled with red) of the heparinized capillary tube to the drop of blood.

The blood flows into the tube by capillarity. Fill about $\frac{3}{4}$ of the tube.

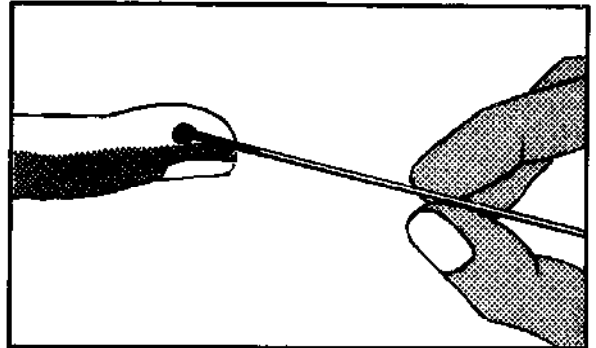

2. Plug the other end of the tube with soft wax (i.e., the end that has not come into contact with the blood).

Check that it is completely plugged to a depth of about 2 mm.

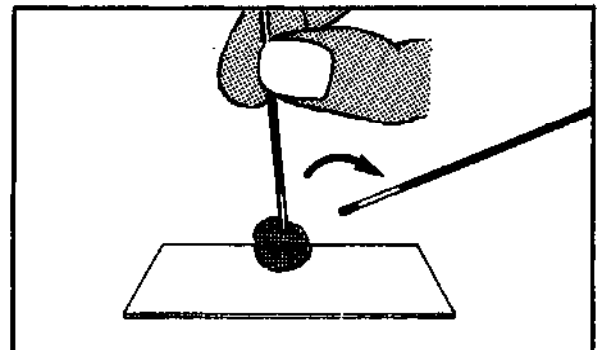

If wax or plastic modelling clay cannot be obtained, seal the end of the tube by heating it carefully over a spirit lamp.

Leave to cool in a *horizontal position*.

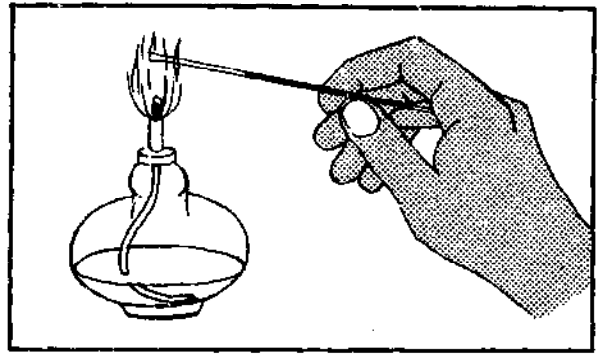

3. It is useful to have ready a numbered stand containing plastic modelling clay, so that each patient's tube can be stuck upright next to the corresponding number.

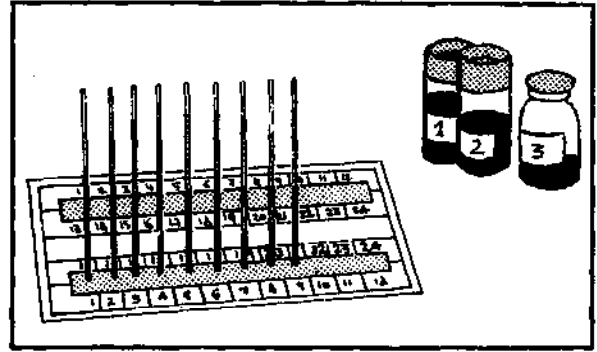

4. Place the capillary tubes in the numbered slots in the centrifuge head, making sure that the number on the slot corresponds with the specimen number. The end of the tube sealed with wax (or in a flame) should point *outwards*, away from the centre.

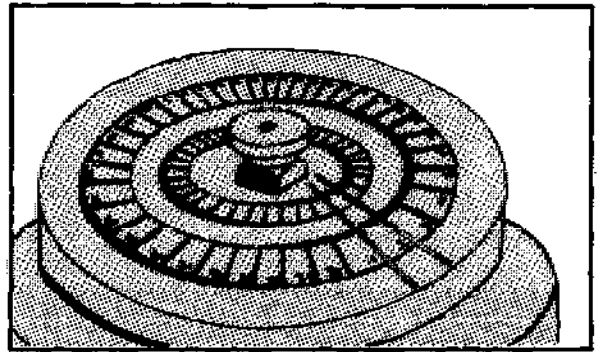

5. Centrifuge at high speed.

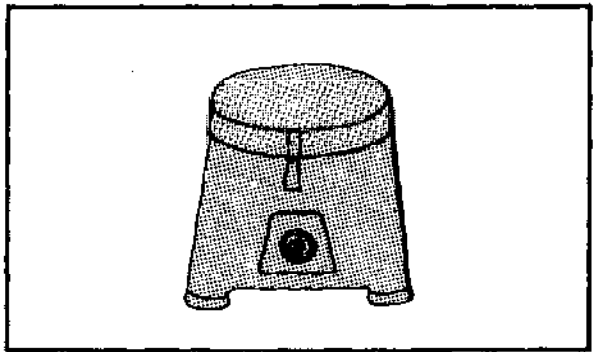

- After centrifugation, the tubes will show 3 layers:
- *at the top*, a column of plasma (P)
 - *in the middle*, a very thin layer of white cells (WC)
 - *at the bottom*, a column of red cells (RC).

The erythrocyte volume fraction reading is made exactly at the top of the column of red cells.

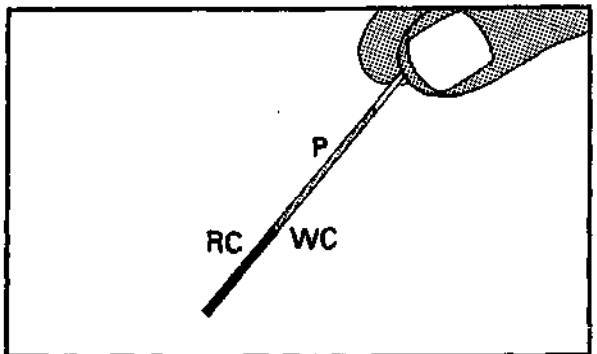

How to use the scale

1. Hold the tube against the scale so that the bottom of the column of red cells (*not* the bottom of the tube) is aligned with the horizontal zero line.
2. Move the tube across the scale until the line marked 1.0 passes through the top of the plasma column. Check to make sure that the bottom of the red cell column is still on line 0; also check (by means of the heavy vertical lines) to make sure that the tube is vertical.
3. The line that passes through the top of the column of red cells gives the erythrocyte volume fraction (0.4 in the illustration). The light intermediate lines represent intervals of 0.05; if the top of the column of red cells is not on a line, but between a heavy line and a light line, its position can be estimated to the nearest 0.01.

Note: If your laboratory has not yet changed to SI units and is still using the traditional system, the same chart can be used. Simply read the numbers as percentages instead of fractions. For example, instead of "erythrocyte volume fraction 0.4" report "packed cell volume 40%".

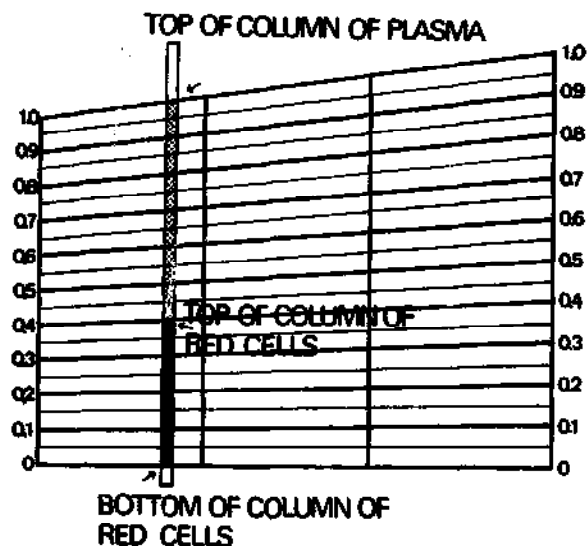

Results

Normal values	Erythrocyte volume fraction	Traditional system: packed cell volume
Men	0.40-0.50	40-50%
Women	0.37-0.43	37-43%
Children (5 years)	0.38-0.44	38-44%
Infants (3 months)	0.35-0.40	35-40%
Newborn infants	0.50-0.58	50-58%

Low values are found in patients suffering from anaemia: in men, the erythrocyte volume fraction is lower than 0.4 and in women it is lower than 0.37 (packed cell volumes of 40% and 37%, respectively).

High erythrocyte volume fractions are found in cases of loss of plasma, severe burns, dehydration, infant diarrhoea, and cholera (also, rarely, in polycythaemia).

METHOD – MACRO SCALE

Materials

- Ordinary electric centrifuge, capable of sustaining a force of 2300g at the base of the buckets
- Special graduated tubes (Wintrobe tubes):
 - bore: 0.6 cm
 - length: 9.5 cm
 - calibrations: 0-100
- Long fine capillary Pasteur pipette (long enough to reach the bottom of the tube) with rubber test.

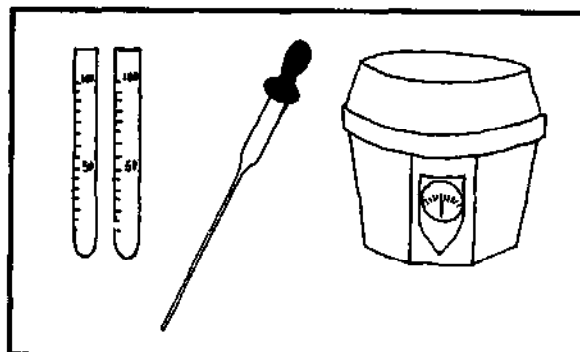

Collection of specimen

Draw venous blood and add it to a tube of anti-coagulant (EDTA dipotassium salt or Wintrobe solution).

Method

1. Using the capillary pipette, fill the graduated tube with blood:
 - up to the 100 mark
 - making sure that no air bubbles form.

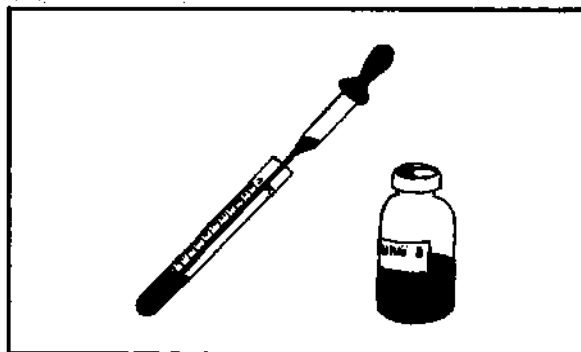

2. Centrifuge for 30 minutes at a centrifugal force of 2300g. If the rotor arm of the centrifuge (measured from the axis of rotation to the base of the bucket holding the tube) is 15 cm long, 3600 r/min will be needed to attain this force; with a 20 cm arm 3100 r/min will be needed.

(Important: a force of less than about 2300g will give a false result.)

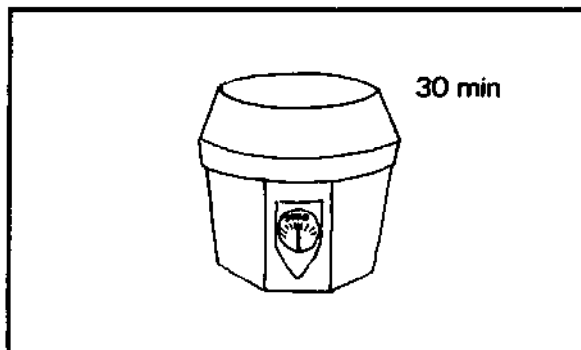

3. Read the level at which the red cells meet the layer of leukocytes. Make sure that the correct set of graduations is being used, upwards towards the 100. The figure obtained is a percentage (the "packed cell volume"); divide by 100 to obtain the erythrocyte volume fraction.

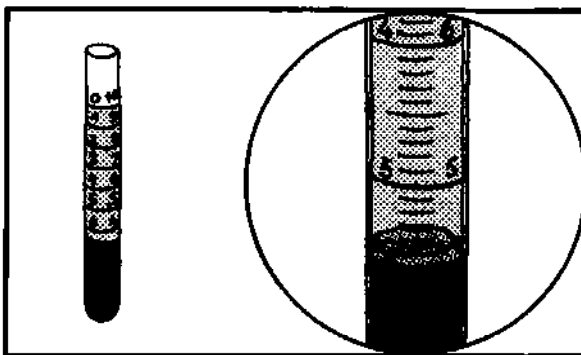

Results

The normal values are the same as those given for the micro scale method.

RELATIONSHIP BETWEEN ERYTHROCYTE NUMBER CONCENTRATION AND VOLUME FRACTION

Normally, the erythrocyte number concentration (cells $\times 10^{12}$ per litre) bears a certain relationship to the erythrocyte volume fraction. If C is the former, the erythrocyte volume fraction will normally be in the range $(C - 0.2)/10$ to $(C - 0.4)/10$.

Example:

If the erythrocyte number concentration is $5 \times 10^{12}/l$, the erythrocyte volume fraction will normally be in the range $(5 - 0.2)/10$ to $(5 - 0.4)/10$; that is, 0.48 to 0.46.

(In traditional units, the relationship is similar, but the formula for calculating is slightly different: if C is the erythrocyte (red cell) count, the packed cell volume (haematocrit), as a percentage, will normally be in the range $(C \times 10) - 2$ to $(C \times 10) - 4$.)

RELATIONSHIP BETWEEN ERYTHROCYTE VOLUME FRACTION AND HAEMOGLOBIN CONCENTRATION

The erythrocyte volume fraction is normally about 0.003 times the haemoglobin concentration when the latter is expressed in grams per litre. If the haemoglobin concentration is expressed in terms of millimoles of haemoglobin(Fe) per litre, the erythrocyte volume fraction is *roughly* 0.05 times the figure.

Example:

A person with a haemoglobin concentration of 130 g/l will normally have an erythrocyte volume fraction of $130 \times 0.003 = 0.39$. In terms of haemoglobin(Fe), the concentration is about 8.0 mmol/l, and the erythrocyte volume fraction will be about $8.0 \times 0.05 = 0.4$.

ADDITIONAL INFORMATION PROVIDED BY ERYTHROCYTE VOLUME FRACTION TEST

Leukocytes (white cells)

Examine the white layer of leukocytes just above the column of red cells. Normally it is very thin; if it seems thick, determine the leukocyte number concentration. The layer will seem abnormally thick if the leukocyte number concentration is greater than $20 \times 10^9/l$ ($20\,000/mm^3$). In cases of leukaemia, when the leukocyte number concentration may be $100 - 200 \times 10^9/l$ ($100\,000 - 200\,000/mm^3$), the layer may be several millimetres thick.

24. Mean Erythrocyte Haemoglobin Concentration

The mean erythrocyte haemoglobin concentration is a measure of the *average* haemoglobin content of the red cells. It is expressed either in grams of haemoglobin per litre or in millimoles of haemoglobin(Fe) per litre,* and is calculated by dividing the haemoglobin concentration of the blood by the erythrocyte volume fraction.

Examples

- (1) If haemoglobin is expressed in grams of haemoglobin per litre:
haemoglobin = 150 g/l; erythrocyte volume fraction = 0.43
mean erythrocyte haemoglobin concentration = $150/0.43 = 349$ g/l
- (2) If haemoglobin is expressed in millimoles of haemoglobin(Fe) per litre:
haemoglobin(Fe) = 9.3 mmol/l; erythrocyte volume fraction = 0.43
mean erythrocyte haemoglobin concentration = $9.3/0.43 = 21.7$ mmol/l

(Note: to convert values in g/l to values in mmol/l, multiply by 0.062 06. Thus, using the above example, 349 g/l \times 0.062 06 = 21.7 mmol/l.)

RESULTS

Normally the mean erythrocyte haemoglobin concentration lies between the following limits: (a) lower limit: haemoglobin 322 g/l or haemoglobin(Fe) 20 mmol/l; (b) upper limit: haemoglobin 371 g/l or haemoglobin(Fe) 23 mmol/l. When the value falls within this range the red cells are said to be "normochromic" (i.e., of normal colour). Values below the lower limit of the normal range indicate that the red cells are "hypochromic" (i.e., less coloured than normal) and are found in hypochromic anaemias. Values higher than the upper limit of the normal range should be suspect, and the mean erythrocyte haemoglobin concentration should be determined again. Red cells are never "hyperchromic" (i.e., more coloured than normal), but they may increase in volume and thus be capable of containing more haemoglobin than normal; in this case the mean erythrocyte haemoglobin concentration may be as high as 380 g/l (haemoglobin(Fe) 23.6 mmol/l), but it never exceeds these values.

Traditional units

In the traditional system, the mean erythrocyte haemoglobin concentration was called "mean corpuscular haemoglobin concentration" (usually abbreviated to MCHC) and was expressed as a percentage. It was calculated by dividing the haemoglobin concentration of the blood in grams per 100 ml by the packed cell volume as a percentage, and multiplying by 100. Example: haemoglobin concentration, 15.0 g/100 ml; packed cell volume, 43%; mean corpuscular haemoglobin concentration = $(15.0/43) \times 100 = 34\%$. In this system, the normal range is 32-36% and the value never exceeds 38%.

* See note about expression of haemoglobin concentration on page 371.

25. Preparation of Thin Blood Films

Principle

A thin smear is prepared by spreading a small drop of blood evenly on a slide so that there is only one layer of cells.

After staining, blood films are used:

- for determining leukocyte type number fractions
- for detecting abnormal red cells
- for identifying certain parasites.

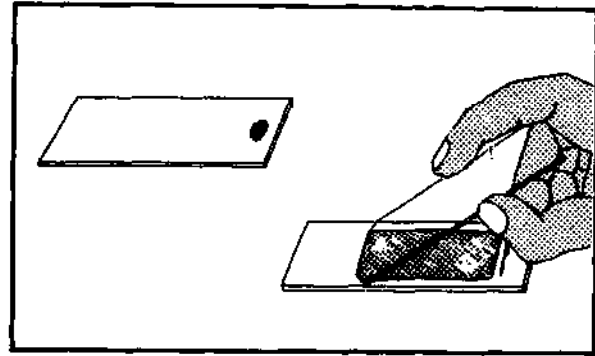

MATERIALS

- Clean grease-free glass slides

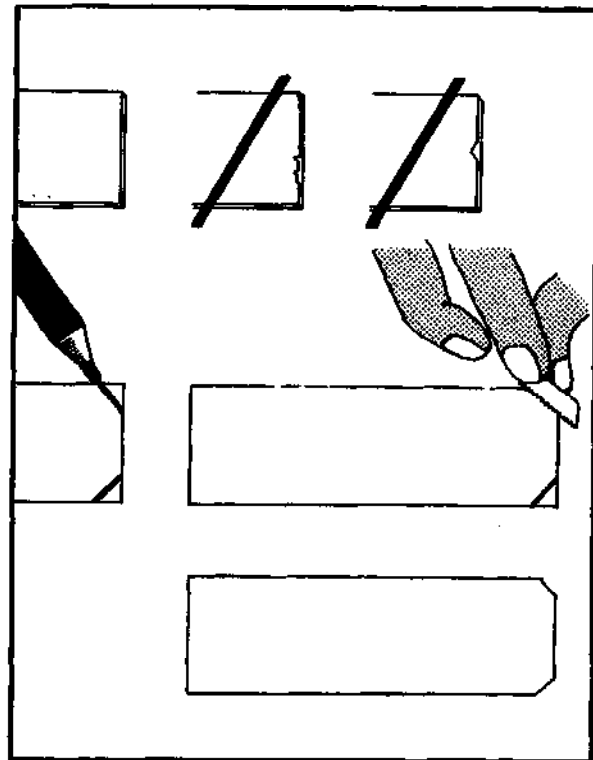

Making a glass spreader

1. Select a slide with a perfectly smooth edge.
2. Make a diagonal mark across the 2 corners at one end of the slide with a file.
3. Snap off the 2 filed corners.

SLIDE PREPARATION

Slides to be used for thin blood films should be well washed and, if necessary, cleaned with ethanol/ether using a piece of soft cloth.

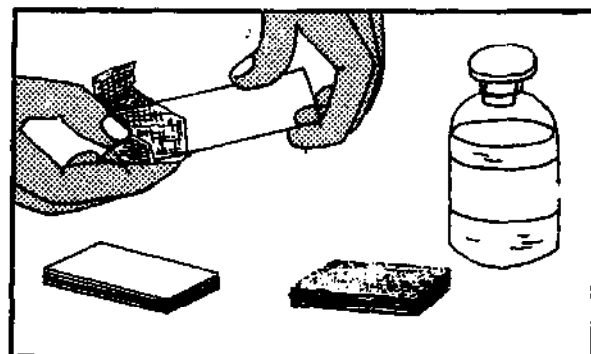

COLLECTION OF BLOOD SPECIMEN

- Take the blood from the
- 3rd or 4th finger
 - on the side.

Let the blood flow freely. First take samples for determining blood cell number concentrations (if requested).

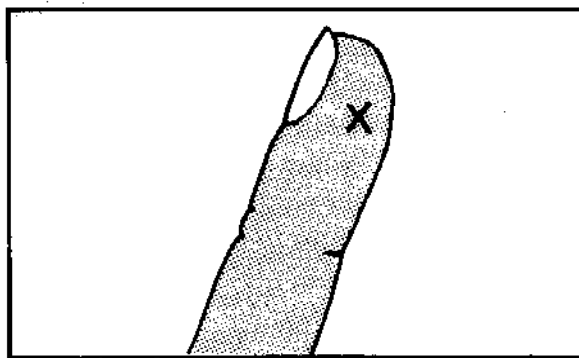

Important. Do not take blood from:

- the index finger or thumb
- an infected finger (paronychia, etc.)
- the ear (too many monocytes).

Use of anticoagulants

Use only dried EDTA dipotassium salt solution; other anticoagulants alter the appearance of leukocytes. It is much better not to let blood stand in an anticoagulant before preparing the film.

MAKING THE FILM

1. Collect a drop of blood about this size: ● by touching it lightly with one end of the slide.

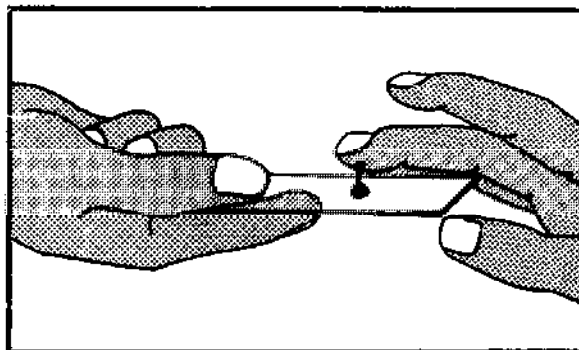

2. Hold the slide with one hand. Using the other hand, place the edge of the spreader just in front of the drop of blood.

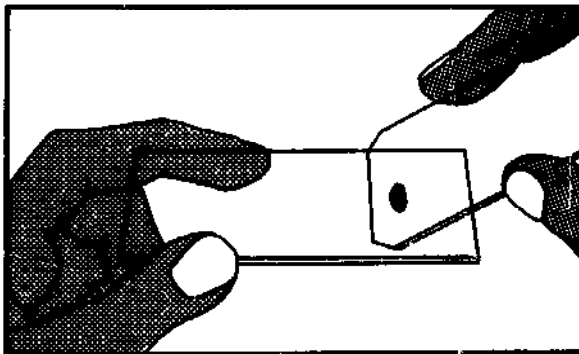

3. Draw the spreader back until it touches the drop of blood.

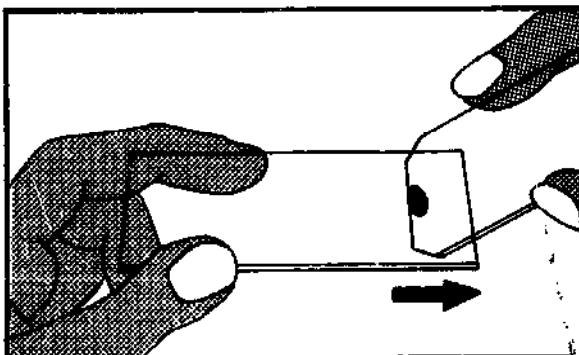

4. Let the blood run along the edge of the spreader.

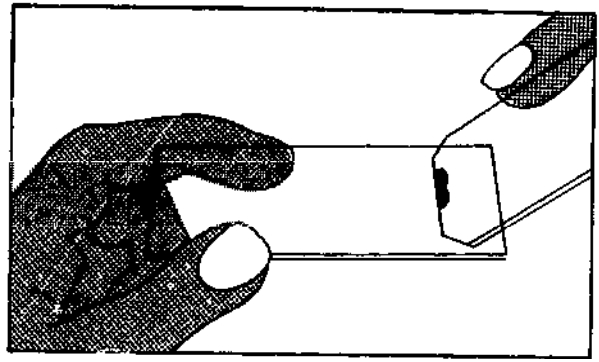

5. Push the spreader to the end of the slide with a smooth movement (all the blood should be used up before you reach the end).

Blood from patients with anaemia should be spread more rapidly.

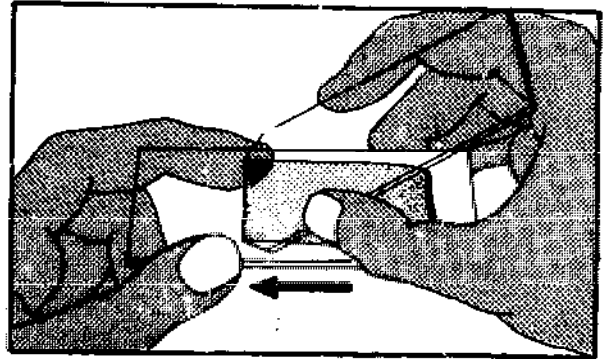

6. Check that the film is satisfactory (see A):

- there should be no lines extending across or down through the film
- the film must be smooth at the end, not ragged and lined as shown in B
- the film must not be too long
- the film must not be too thick
- the film must not contain holes because a greasy slide has been used.

A well spread film is of great importance. A badly spread film will give wrong leukocyte type number fractions and make it impossible to report red cell morphology.

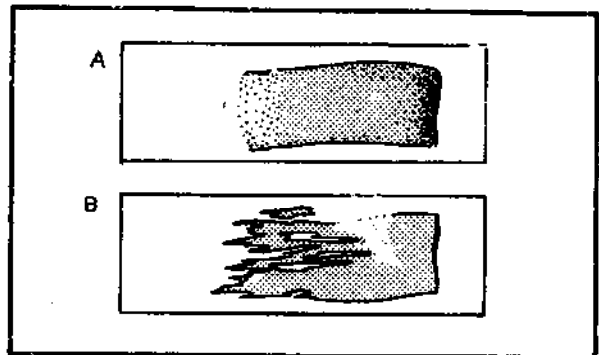

DRYING THE FILM

Adequate drying is essential to preserve the quality of the film, especially in humid climates.

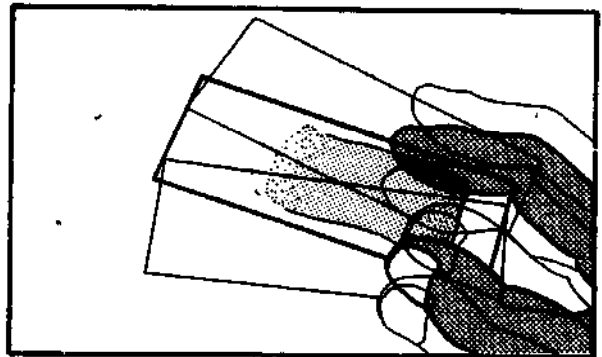

In the wet season (in the tropics)

Dry the film by waving it rapidly about 5 cm away from the flame of a spirit lamp; to the side and slightly above (but never directly over) the flame.

If necessary, protect the blood film from flies.

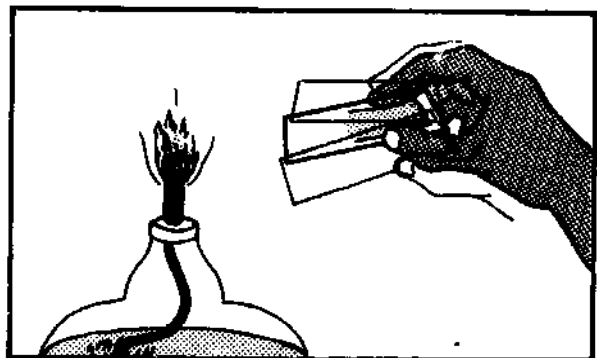

Mark the dry film with the patient's name or number.
Write with a lead pencil on the thick part of the film
not used for examination.

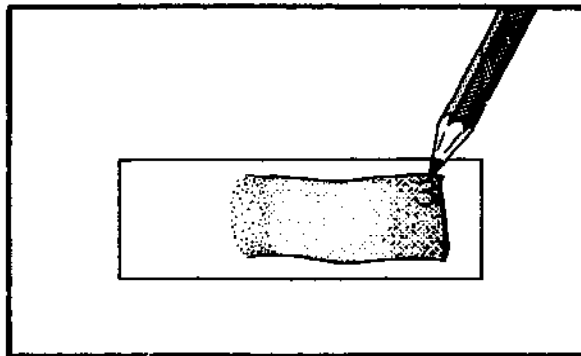

FIXATION

If the film is intended for determining leukocyte type number fractions, it is fixed in methanol or directly with May-Grünwald stain (see page 393).

For detection of parasites (Giemsa or Field stain), the film is fixed in methanol (see pages 393 and 395).

PRESERVATION

Fix films with methanol.
Wrap them individually in sheets of white paper (once they are dry).

26. Staining of Thin Blood Films

Principle

Thin blood films are stained with Romanowsky stains, which contain methylene blue dyes and eosin. The Romanowsky stains most widely used include:

- Leishman and Wright, which give similar results and are used as individual stains
- May-Grünwald and Jenner, which give similar results and are used with Giemsa stain
- Giemsa, which can be used as an individual stain or with May-Grünwald or Jenner stains
- Field A and B, prepared in water unlike the other stains mentioned, which are made up in methanol. Field stains are used for both thin and thick blood films.

The methanol Romanowsky stains can be used to fix thin films before being diluted on the slides to stain the films. Better results are obtained by fixing first with methanol, then staining with pre-prepared diluted stains, as described below.

STAINING WITH LEISHMAN STAIN

Materials

- 2 glass rods either over a sink or over a staining tank
- Measuring cylinder 50 ml or 100 ml
- Wash bottle containing buffered water (reagent No. 12)
- Interval timer clock
- Rack for drying slides
- Leishman stain (reagent No. 35)
- Methanol

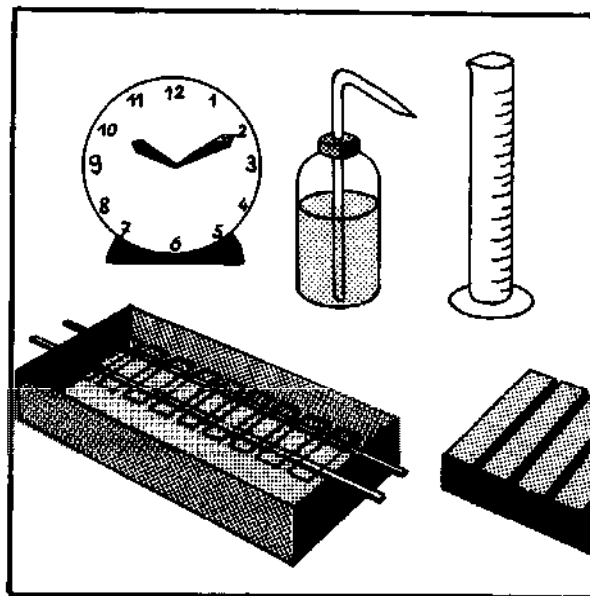

Method

1. Fix the thin blood film with methanol for 2-3 minutes.

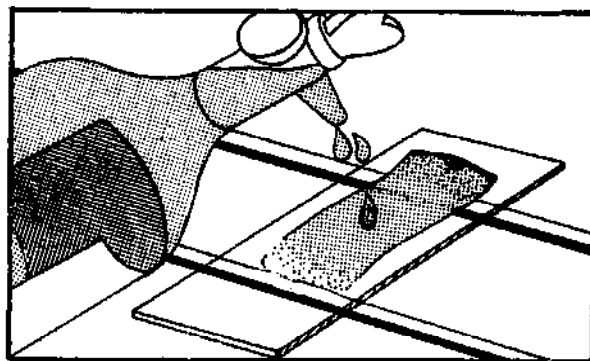

2. Prepare a 1 in 3 dilution of Leishman stain using 1 part of stain and 2 parts of buffered water. Mix.
Example: Use 10 ml stain and 20 ml buffered water.

Prepare sufficient stain for one day's use only, as the diluted stain does not keep well.

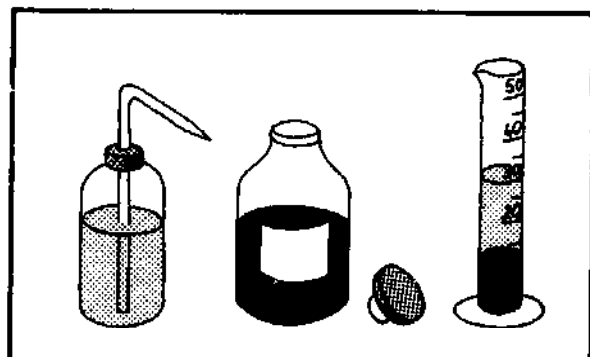

3. Cover the slide with the diluted stain for 7-10 minutes.

Important: The staining time may need changing, especially when a new batch of stain is received or the stain has been stored for a long time.

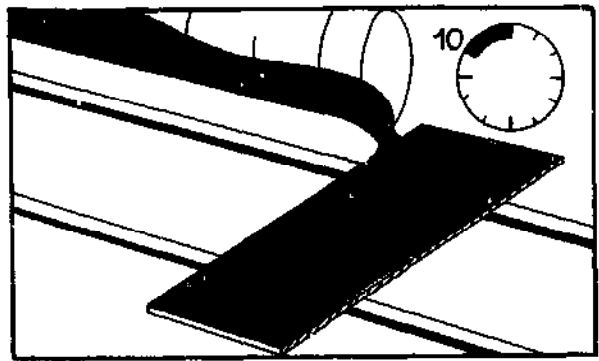

4. Wash the stain off in a stream of buffered water. Do not tip the stain off as this will leave a deposit of stain on the film.

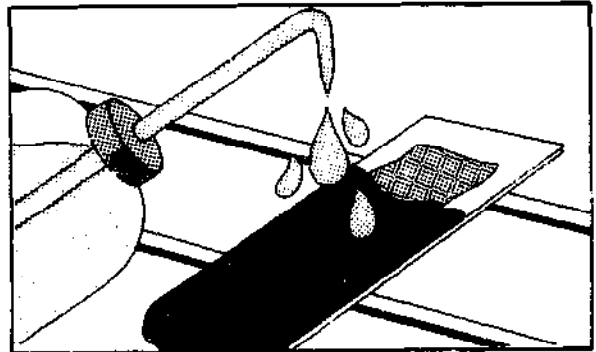

5. Leave clean water on the slide for 2-3 minutes to differentiate the film.

The time taken for differentiation will depend on the stain and the pH of the water used.

The pH is of vital importance in differentiating leukocytes with Leishman stain. It should be between 6.8 and 7.2, and preferably between 7.0 and 7.2 (see page 61).

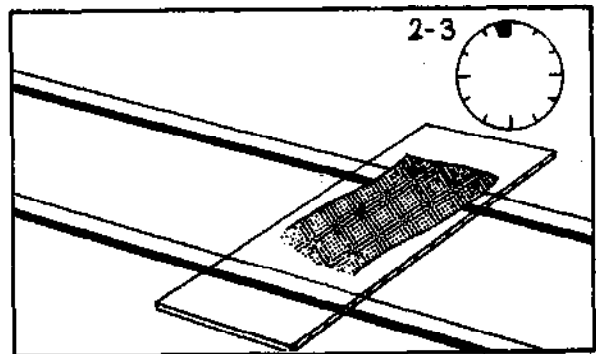

6. Tip the water off and stand the slide in a draining rack to dry.

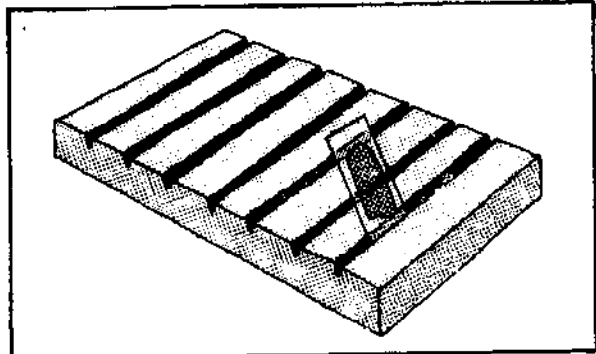

Results

In a well stained film:

<i>Neutrophils</i>	The cytoplasm stains faint pink and contains small mauve granules
<i>Eosinophils</i>	The cytoplasm stains faint pink and contains large red granules
<i>Monocytes</i>	The cytoplasm stains grey-blue
<i>Lymphocytes (large)</i>	The cytoplasm stains a clear blue
<i>(small)</i>	The cytoplasm stains a dark blue
<i>Basophils</i>	Many dark mauve-blue granules fill the cell
<i>Red cells</i>	Stain pink-red
<i>Platelets</i>	Stain mauve-pink.

STAINING WITH MAY-GRÜNWARD AND GIEMSA

Materials

As for Leishman staining.

- May-Grünwald stain (reagent No. 37)
- Giemsa stain (reagent No. 28)
- Buffered water (reagent No. 12).

Method

1. Fix the thin film with methanol for 2-3 minutes.

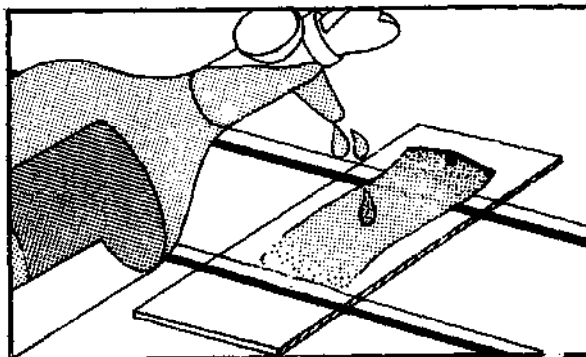

2. Prepare the stains as follows:
 - dilute May-Grünwald stain 1 in 2 using equal volumes of stain and buffered water. Mix.
Example: use 10 ml stain
10 ml buffered water.
 - dilute Giemsa stain 1 in 10 using one volume of stain and 9 volumes of buffered water. Mix gently.
Example: use 2 ml stain
18 ml buffered water.

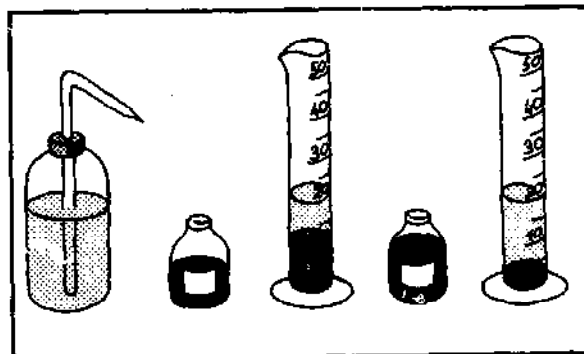

Prepare sufficient of each stain for one day's use only, as the diluted stains do not keep well.

3. Cover the slide with diluted May-Grünwald stain for 5 minutes.

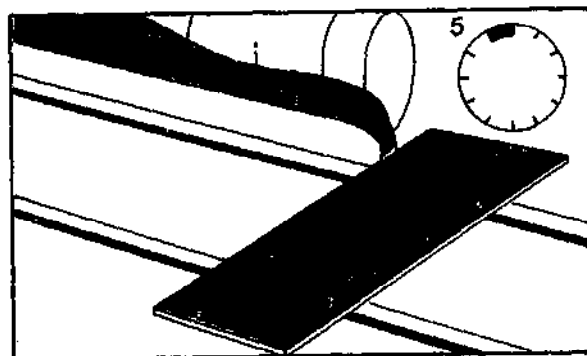

4. Tip the stain off and replace with diluted Giemsa stain for 10 minutes.

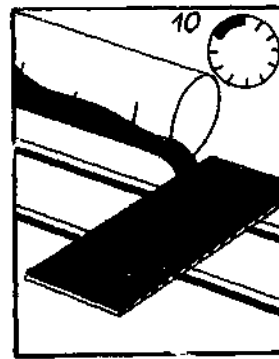
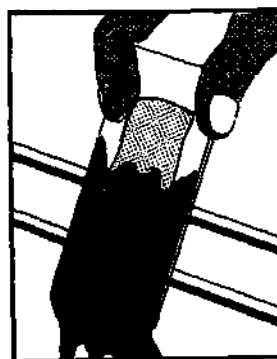

Important: The staining time may need changing, especially when a new batch of stain is received or the stain has been stored for a long time.

5. Wash the stain off in a stream of buffered water. Do not tip the stain off as this will leave a deposit of stain on the film.

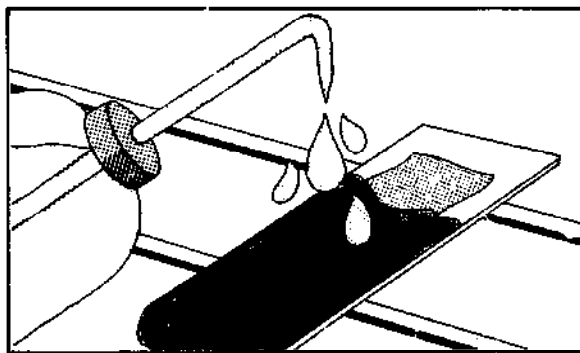

6. Leave clean water on the slide for 2-3 minutes to differentiate the film.

The time for differentiation will depend on the stain and the pH of the water used. The pH should be between pH 6.8-7.0 (see page 61).

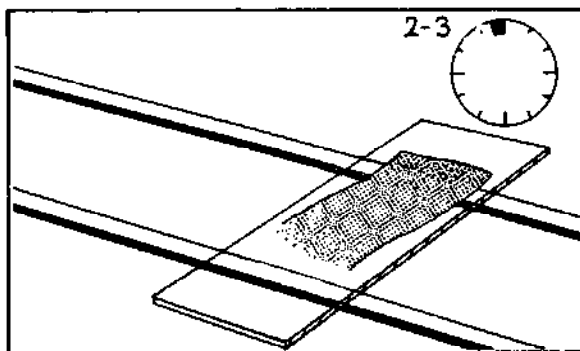

7. Tip the water off and stand the slide in a draining rack to dry.

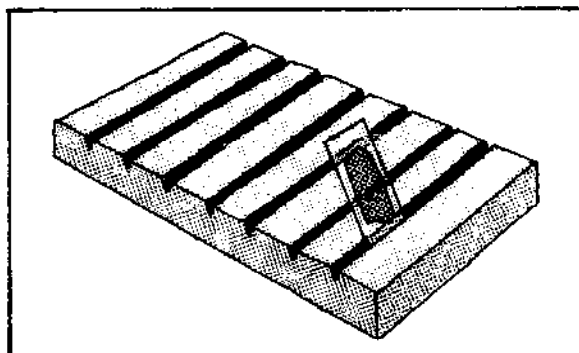

Results

As for Leishman staining (see page 392).

RAPID STAINING OF THIN FILMS WITH FIELD STAIN

The staining of thin films with Field stain is different from the method used for thick films; Field stain B is used *before* Field stain A.

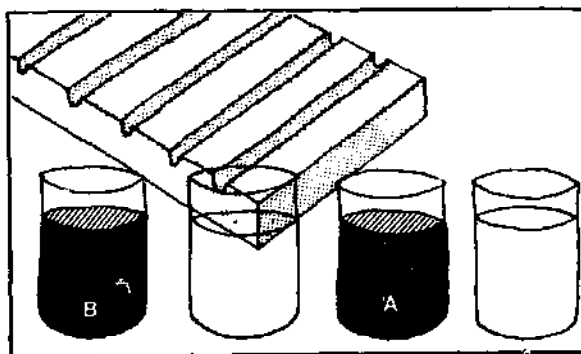

Materials

- Field stains A and B (reagent No. 22)
- Bottles or beakers containing clean tap water (buffered water is not necessary).

Field stains A and B, undiluted, can be used for as long as they give good results. They should be filtered every 2-3 days.

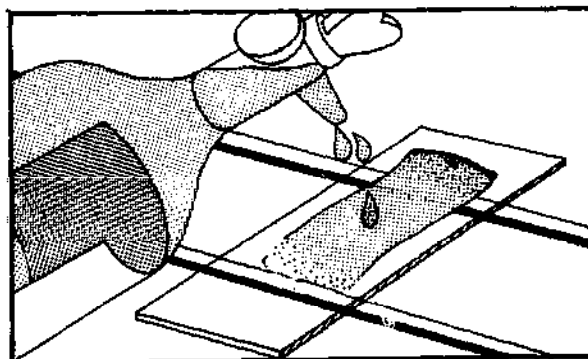

Method

1. Fix the thin film with methanol for 2-3 minutes.

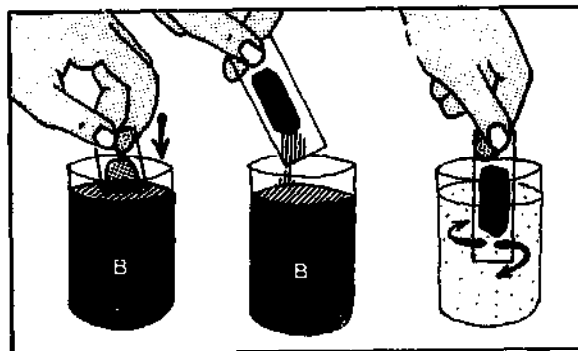

2. Dip the slide into Field stain B and count up to 5. Drain and wash in the first container of tap water.

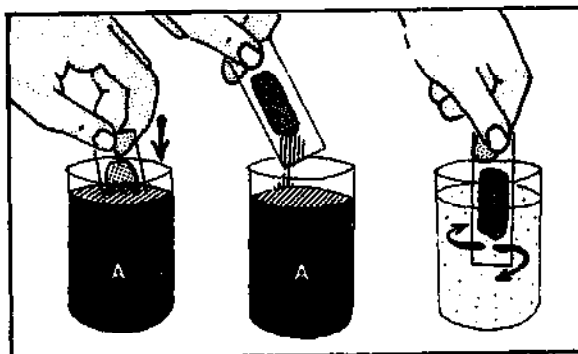

3. Drain and dip into Field stain A and count up to 10. Drain and wash well in the second container of tap water.

4. Examine the colour of the film. It should appear mauve, neither too blue nor too pink.

If it is not satisfactory, return the film to Field stain A or B (either) for a few more seconds, as needed.

If satisfactory, stand the slide in a draining rack to dry.

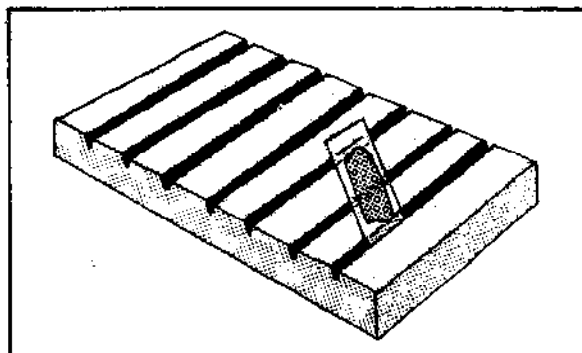

Results

Similar to staining with Leishman (page 392).

ESSENTIAL PRECAUTIONS FOR SUCCESSFUL RESULTS

Avoid the formation of deposits of stain. They appear on the film as masses of little black spots. Avoid poor staining, which makes the film too blue, too pink or too dark.

1. *Perfectly clean glassware:* Wash every day. Do not use acid. Remove stain deposits with methanol.
 2. *Neutral water* (buffered if possible): See preparation technique, page 61. Acid water produces a picture that is too red; alkaline one that is too blue. Neutral water must be freshly prepared, for it becomes acid when exposed to air.
 3. *Giemsa mixture:* Prepare slowly and carefully. Shaking causes the stains to precipitate.
-

HOW TO REMEDY POOR RESULTS

1. *Stain deposits*

They are caused by May-Grünwald stain or neutral water and can be seen with the naked eye in the liquid on the slide. Drain off the stain. Rinse the slide twice in methanol. Dry and re-stain using fresh or filtered May-Grünwald stain.

2. *Deposits of Giemsa stain*

They are seen with the naked eye or under the microscope. Also rinse with methanol, but wash off immediately with neutral water. Dry and repeat the staining procedure from the beginning.

3. *Too much blue in film (basophilic staining)*

Prepare a solution of 1% boric acid in 95% ethanol. Rinse the slide twice in the preparation. Wash at once in neutral water. Dry and examine under the microscope without further treatment. Basophilic staining can usually be prevented by using buffered water at a more acid pH and, if necessary, altering the differentiation time.

27. Leukocyte Type Number Fraction and Examination of Leukocytes

The leukocytes (white cells) in the blood are not all identical. There are five main types of leukocyte, which differ in size, shape of the nucleus, colour of the granules in the cytoplasm, and other factors. The proportion of each leukocyte type is of diagnostic importance. The proportion of each type is called the leukocyte type number fraction.

Principle

100 leukocytes are counted, and the number of each type seen is recorded. The proportion of each leukocyte type is reported as a decimal fraction.* Example:

neutrophils	0.56
lymphocytes	0.25
eosinophils	0.12
monocytes	0.06
basophils	0.01

The total of all the fractions should be 1.

MATERIALS

- Microscope (x 5 or x 6 eyepiece and x 100 oil-immersion objective — a x 40 dry objective with coverslips is also used)
- Immersion oil
- Well spread thin blood film stained with Romanowsky stain (see page 393)
- If available, a special counting keyboard, or a bead counter made locally.

METHOD

Examination of film

Using the x 100 oil-immersion objective, check that the white cells are evenly distributed.

In a badly spread film the neutrophils may have collected at the end of the film.

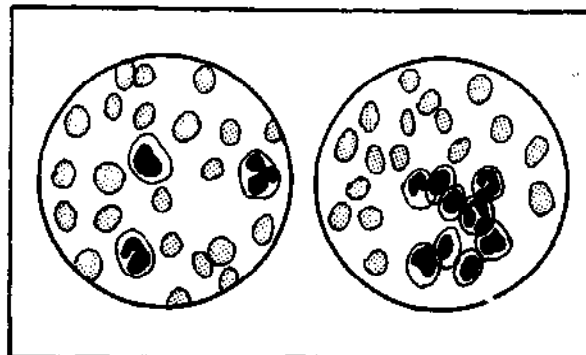

* In the traditional system, the leukocyte type number fractions are called the "differential leukocyte (or white cell) count", and the proportion of each type is reported as a percentage — e.g., neutrophils 56%, lymphocytes 25%, eosinophils 12%, monocytes 6%, and basophils 1% in the example given above.

Counting the white cells

1. Begin the count near the end of the smear, just where the red cells are beginning to overlap.
2. Examine a strip of the film, moving from one field to the next systematically, as shown. Record the type of leukocyte seen in each field.
3. Count a total of 100 leukocytes.

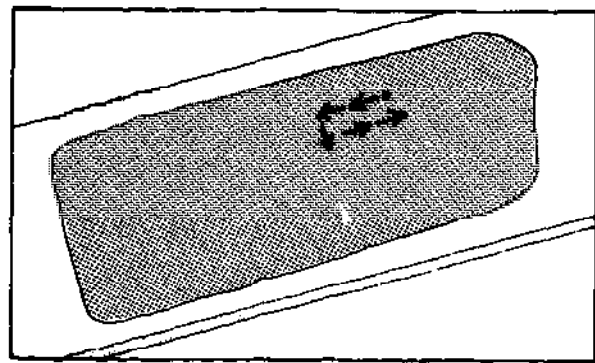

Check that the film is not too thick.

If you see that the film is getting thick (red cells very crowded), stop moving towards the front end; move across and towards the end of the film.

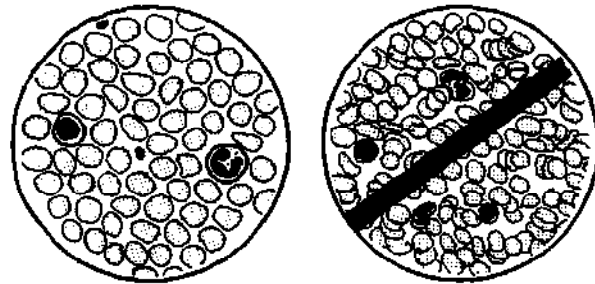

Examination of film for red cell and platelet abnormalities

Examine the red cells (see page 407) and note the presence of any malarial parasites (pages 200-201).

Examine the number of platelets, reporting them as "normal" (N), "low" (L), "high" (H). If the film is made from capillary blood the platelets (page 351) will probably appear clumped.

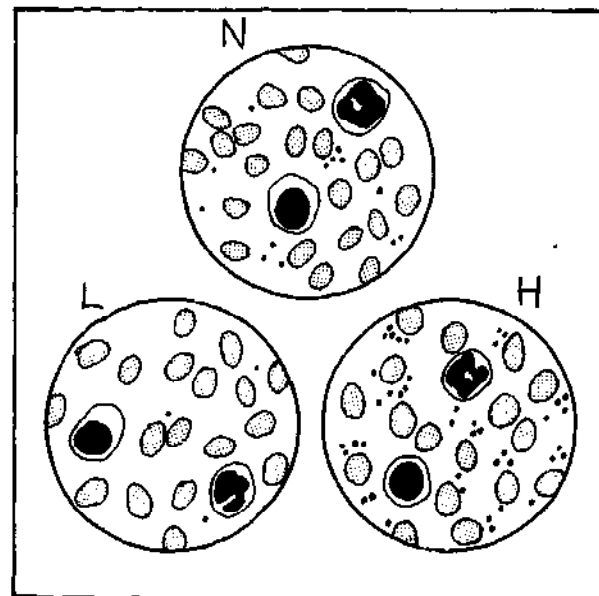

EXAMINATION OF LEUKOCYTES

1. Note the shape of the leukocyte and its size in comparison with that of a red cell (R).

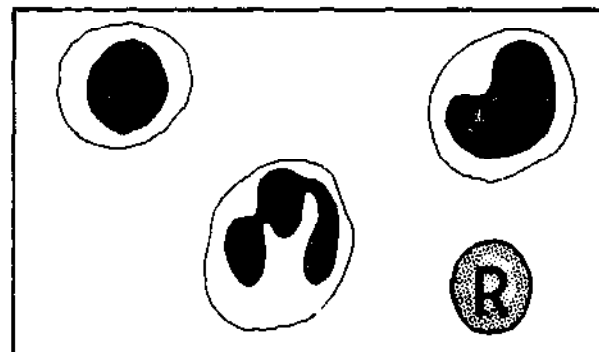

2. Note the shape of the nucleus and its size in relation to the total area of the cell:
- round R, lobed L, indented I.

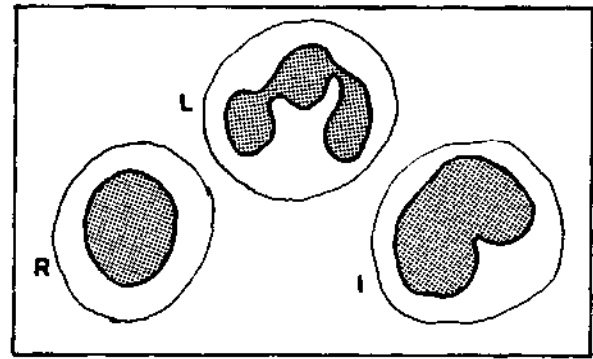

3. Note the appearance of the cytoplasm.

Colour:

- colourless
- pink
- pale blue
- dark blue.

Granules in the cytoplasm:

- neutrophil granules (N) - mauve, small
- eosinophil granules (E) - orange-red, large
- azurophil granules (A) - bright reddish-purple, quite large
- basophil granules (B) - deep purple, very large

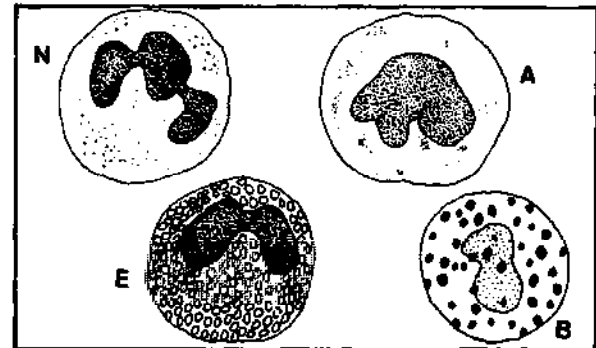

4. Note the appearance of the chromatin of the nucleus: densely or palely stained. Also the position of the nucleus in the cell: central or eccentric.

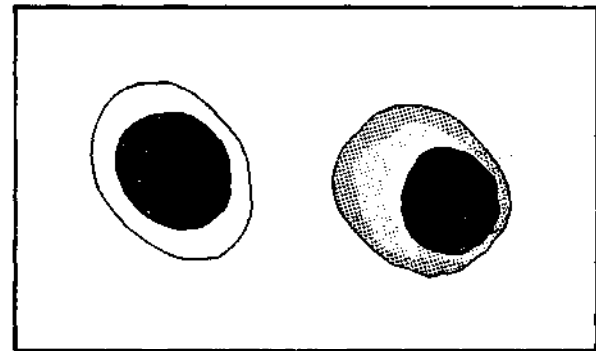

5. Vacuoles and nucleoli are round or oval areas, more or less distinct, that remain unstained or stain very faintly:
- vacuoles (V) in the cytoplasm
 - nucleoli (N) in the nucleus.

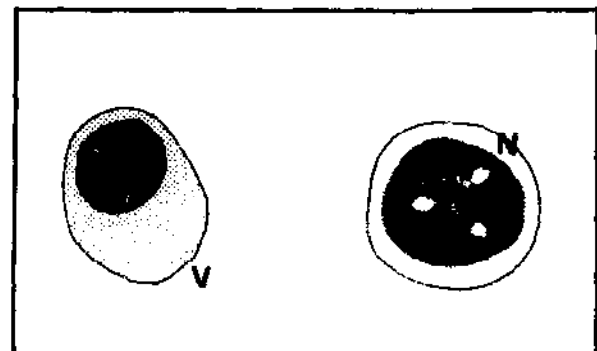

Normal cells

Polymorphonuclear neutrophil cells (P) have:

- a nucleus with several lobes
- granules in the cytoplasm (hence their usual name: granulocytes).

Lymphocytes (L) and monocytes (M) have:

- a compact nucleus
- with or without granules in the cytoplasm

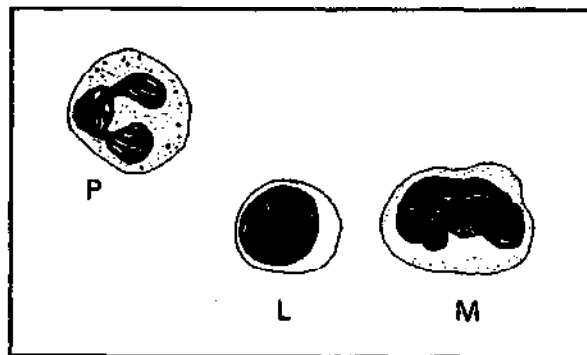

1a. POLYMORPHONUCLEAR NEUTROPHIL CELL

Size 12-15 μm

Shape rounded, well defined

Cytoplasm abundant, pinkish

Granules mauve and very small, numerous but separate

Nucleus several (2-5) lobes, linked by strands of chromatin. The chromatin appears as a uniform deep purple mass.

(The older the cell, the greater the number of lobes in the nucleus.)

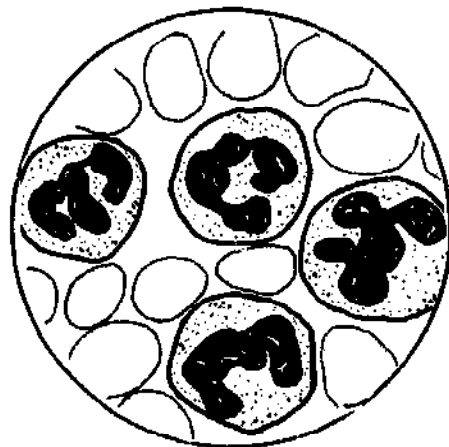

1b. IMMATURE POLYMORPHONUCLEAR NEUTROPHIL CELL ("BAND FORM" OR "STAB CELL")

Similar to the previous leukocyte except that the nucleus is not yet divided into lobes; it is often "S" shaped.

If "stab" cells are seen, report their number fraction as for other types of leukocytes.

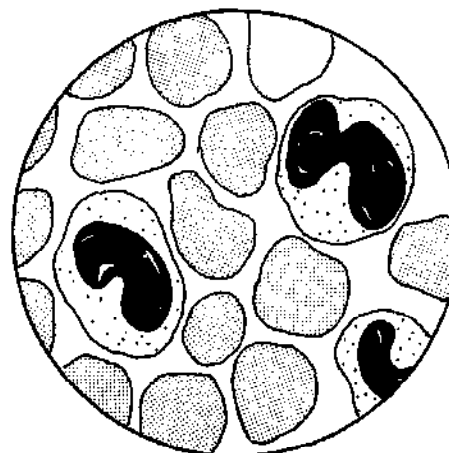

2. POLYMORPHONUCLEAR EOSINOPHIL CELL

Size 12-15 μm
Granules large, round, orange-red, numerous and closely packed
Nucleus usually 2 lobes.

Sometimes the cell appears damaged, with scattered granules.

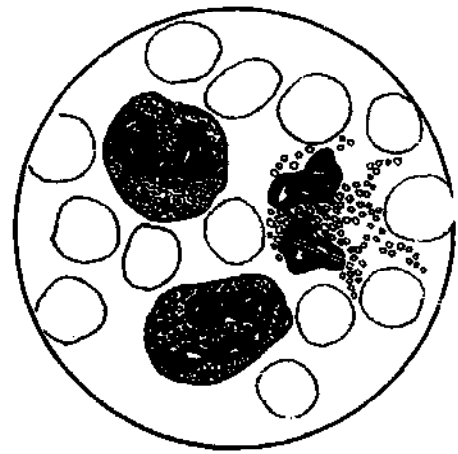

3. POLYMORPHONUCLEAR BASOPHIL CELL

The rarest type of granulocyte.

Size 11-13 μm
Shape round
Granules very large, round, deep purple, numerous but less closely packed than those of the eosinophils
Nucleus difficult to see because covered by the granules
Vacuoles occasional small colourless vacuoles in the cytoplasm.

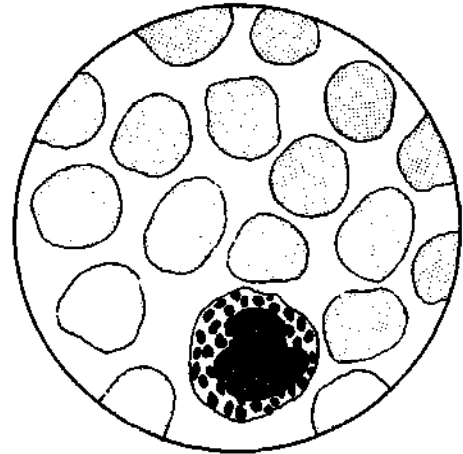

4. SMALL LYMPHOCYTE

Size 7-10 μm
Shape round
Nucleus large, occupying most of the cell, chromatin dark purple, dense
Cytoplasm very little visible; blue with no granules.

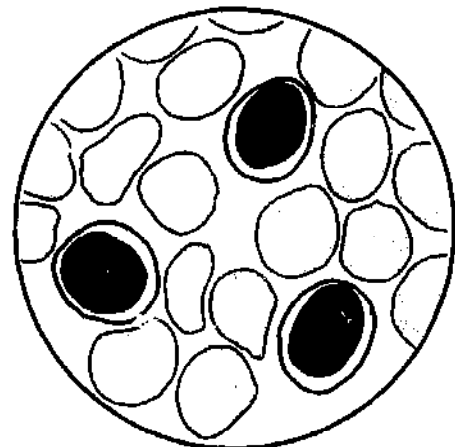

5. LARGE LYMPHOCYTE

- Size** 10-15 μm
Shape round or irregular
Nucleus oval or round, may lie to one side of the cell
Cytoplasm abundant, pale blue
Granules few, quite large, azurophilic (dark red).

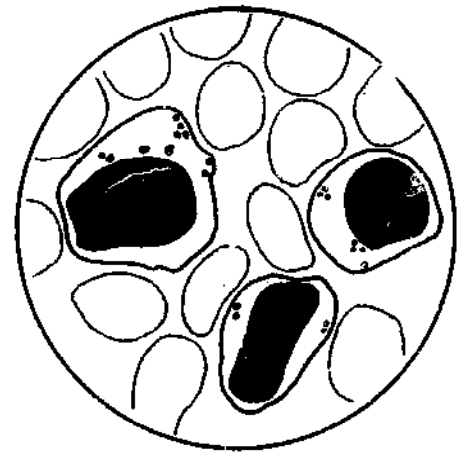

6. MONOCYTE

- Size** 15-25 μm : largest of the leukocytes
Shape irregular
Nucleus variable, often kidney-shaped, chromatin arranged in strands, pale mauve
Granules fine, dust-like, usually reddish
Vacuoles usually present in the cytoplasm.

In patients suffering from *malaria* the cytoplasm often contains brownish-black masses. This is malaria pigment.

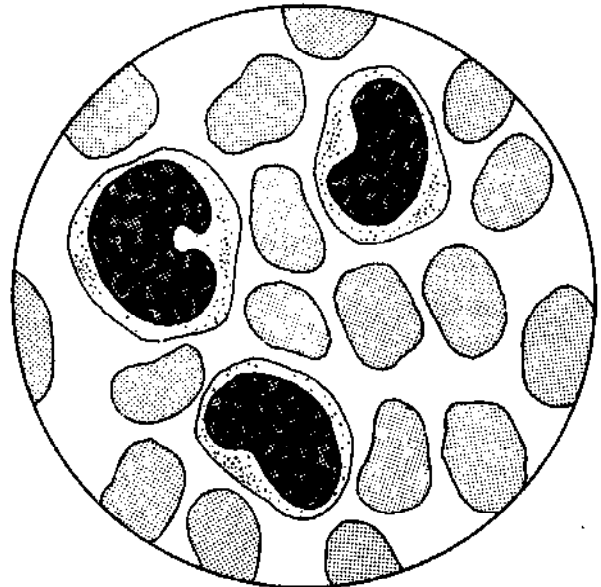

Rare or abnormal cells

7. PLASMA CELL

Plasma cells produce antibodies. They may be seen in the blood film in measles, tuberculosis, other viral and bacterial infections and multiple myeloma.

- Size** 12-15 μm
Shape round or oval
Nucleus round, eccentric, chromatin clumped, often in a wheel-like arrangement
Cytoplasm dark blue with a pale-staining area round the nucleus
Vacuoles numerous and very small; not easily seen.

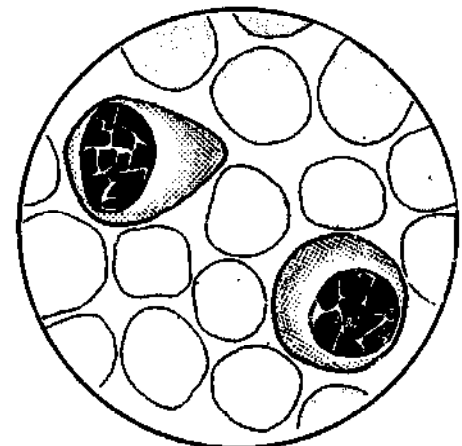

8. NUCLEATED RED CELL (NORMOBLAST)

An immature nucleated red cell normally found in the bone marrow. In certain diseases (anaemias) nucleated red cells can be seen in the blood film.

<i>Size</i>	8-10 μm
<i>Shape</i>	round or irregular
<i>Cytoplasm</i>	pink or greyish-blue, no granules
<i>Nucleus</i>	round, often eccentric, chromatin clumped, dense, dark-staining

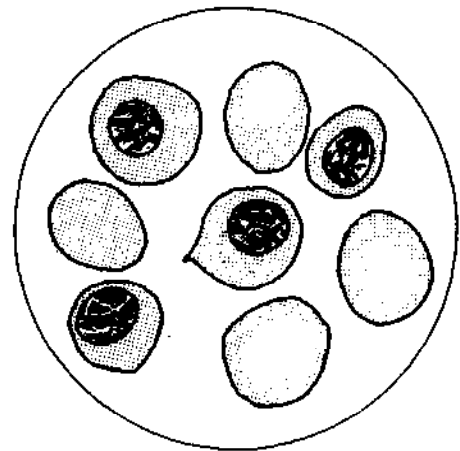

9. IMMATURE GRANULOCYTE

An immature polymorphonuclear granulocyte of the bone marrow that passes into the blood stream in certain diseases (severe bacterial infections). It can be distinguished by the following features:

<i>Size</i>	12-18 μm
<i>Nucleus</i>	single without lobes, chromatin varying in colour from dark red to purple
<i>Cytoplasm</i>	pale blue or pink
<i>Granules</i>	many, large, mauve or dark red. Toxic granulation may be seen, in which the granules are very large and darkly stained.

There are also immature cells without granules and with nucleoli: see No. 12 below.

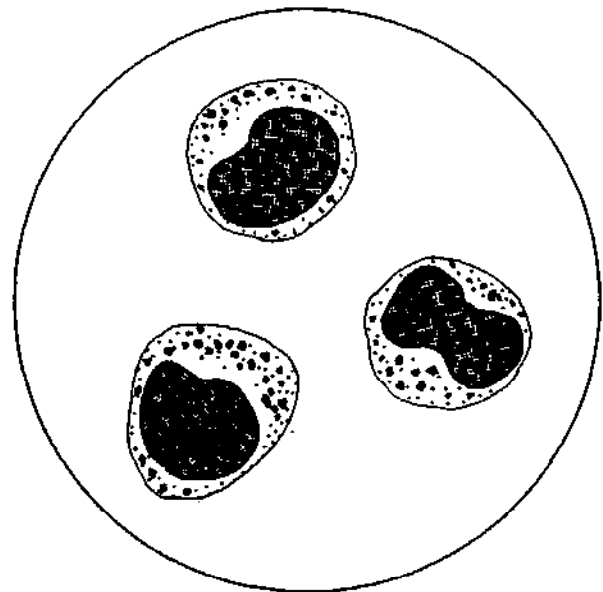

10. HYPERSEGMENTED POLYMORPHONUCLEAR EAR NEUTROPHIL CELL

An "old" polymorphonuclear neutrophil cell that looks like a normal cell except that its nuclei have 5-10 lobes and are often larger in size.

Such neutrophils can be seen in patients with macrocytic anaemia, caused by folic acid or vitamin B-12 deficiency.

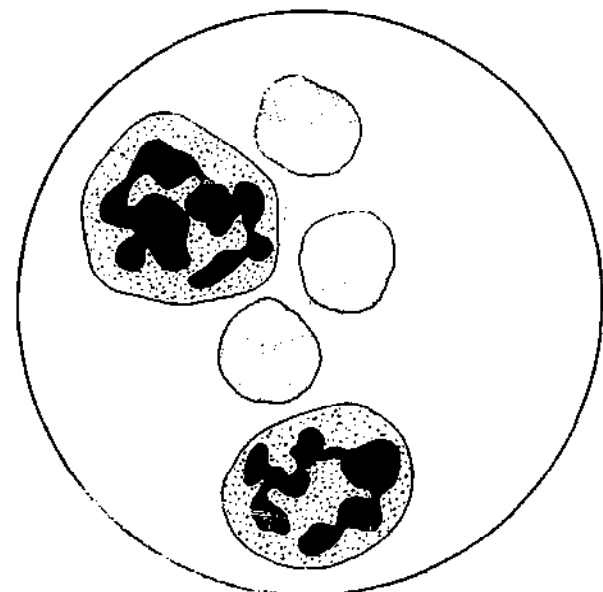

11. ATYPICAL LYMPHOCYTE

Atypical lymphocytes can be seen in viral infections, especially infectious mononucleosis (glandular fever), whooping cough and measles. They are also found in tuberculosis and severe malaria.

- Size* very variable, 12-18 μm
Shape usually irregular
Nucleus round or irregular, often lying to one side of the cell; nucleoli may be seen
Cytoplasm usually darker blue than that of the large lymphocyte; dark edges to the cell.

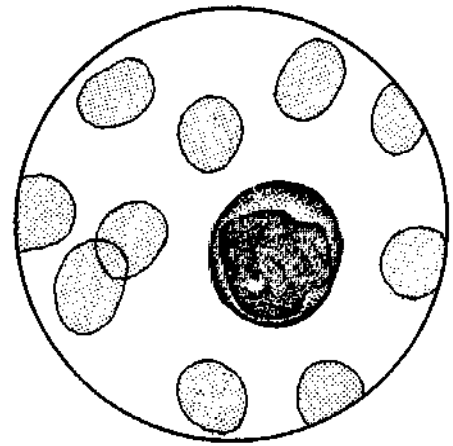

12. BLAST CELL

The earliest (most immature) of all the types of leukocyte. It can be seen in the blood films of patients with leukaemia.

- Size* large, 15-25 μm
Nucleus large, round, pale mauve, always containing 1-5 nucleoli
Cytoplasm dark blue, with a clear unstained area round the nucleus.

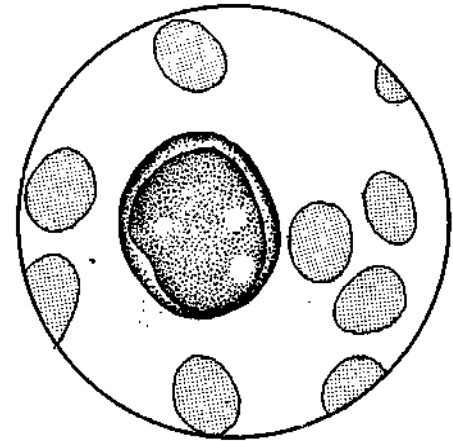

13. MEGAKARYOCYTE

The parent cell of the platelets found in the bone marrow.

- Size* very large, 60-100 μm
Nucleus very irregular, greatly lobulated but dense
Cytoplasm full of fine granules, mostly azurophilic, and platelets
The cell wall is not clearly defined.

(Very rarely found in the blood.)

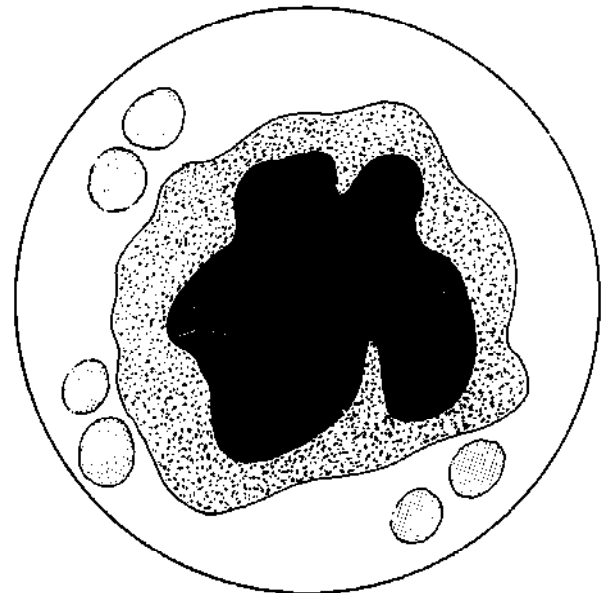

COUNTING METHODS

Using a special counting machine with keys
 These machines have keyboards with a key for each type of leukocyte; the number of each type is registered automatically. They are expensive.

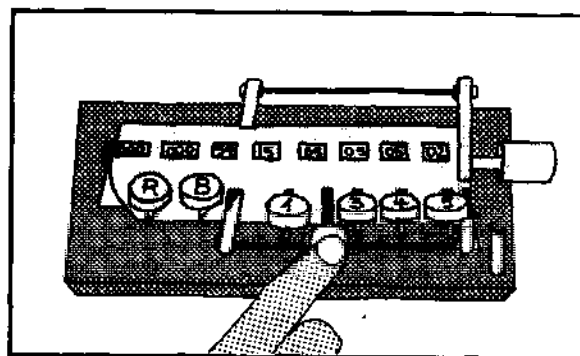

Using bead counter boxes

A counting box like the one shown opposite can be made locally. It consists of:

- 5 boxes labelled as follows:
 N = neutrophils
 E = eosinophils
 B = basophils
 L = lymphocytes
 M = monocytes.
- a 6th box containing 100 beads (or beans or maize grains), used for counting.

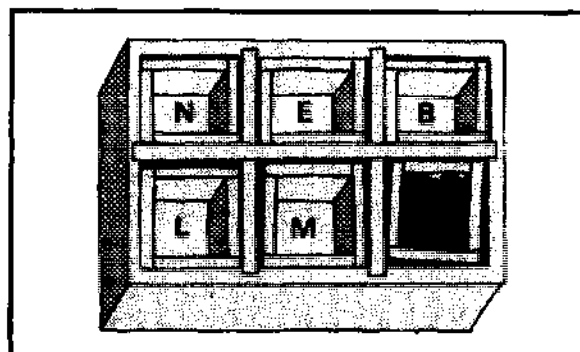

Using a pencil and paper

To record the different types of leukocytes as they are counted, proceed as follows:

Draw up a table with:

- (a) 5 vertical columns (N, E, B, L, M) and
- (b) 10 horizontal lines (see model opposite).

When 10 strokes have been made in the first line, go on to the next. Thus, when the 10th line has been completed, you know that you have counted 100 cells.

Then add up the total for each vertical column.

These totals give the percentage of each type of leukocyte. The totals are turned into decimal fractions by placing a decimal point two digits to the left (in some cases this may necessitate the insertion of a zero). Thus 59 becomes 0.59, 8 becomes 0.08, 1 becomes 0.01, 28 becomes 0.28, etc., as in the last line of the illustration. These decimals are the number fractions of each leukocyte type and are the results that are reported when SI units are used.

	N	E	B	L	M
1					
2					
3					
4					
5					
6					
7					
8					
9					
10					
Total	59	8	1	28	4
Frac.	0.59	0.08	0.01	0.28	0.04

RESULTS

	Normal ranges for following age groups*				
	Newborns	After 4 days	1-4 years	10 years	Adults
Polymorphonuclear neutrophils	0.55-0.65	0.40-0.48	0.36-0.48	0.45-0.55	0.55-0.65
Polymorphonuclear eosinophils	0.02-0.04	0.02-0.05	0.02-0.05	0.02-0.05	0.02-0.04
Polymorphonuclear basophils	0 -0.01	0 -0.01	0 -0.01	0 -0.01	0 -0.01
Lymphocytes	0.30-0.35	0.40-0.48	0.44-0.54	0.38-0.45	0.25-0.35
Monocytes	0.03-0.06	0.05-0.10	0.03-0.06	0.03-0.06	0.03-0.06

The distribution of different leukocyte types thus shows 2 principal patterns

- one with a majority of *lymphocytes* → infants and children under 10
- one with a majority of *polymorphonuclear neutrophils* → adults, children over 10 and newborns

Each different type of leukocyte may be reported in terms of number concentration (i.e., number of cells per litre) instead of as a number fraction. The number concentration is calculated by multiplying the number fraction of a particular leukocyte type by the total leukocyte number concentration. Example:**

$$\begin{aligned} \text{Leukocyte number concentration} &= 5 \times 10^9/\text{l} \\ \text{Neutrophil number fraction} &= 0.42 \\ \text{Neutrophil number concentration} &= 0.42 \times 5 \times 10^9 = 2.1 \times 10^9/\text{l} \end{aligned}$$

Abnormal findings

- (a) **NEUTROPHILIA:** an increased proportion of neutrophils (above 0.65). Particularly in acute infections.
- (b) **EOSINOPHILIA:** an increased proportion of eosinophils (above 0.05). Almost always suggests a parasitic worm infection localized in the tissues: schistosomiasis, filariasis, hookworm, ascariasis, etc. Can also be caused by an allergy.
- (c) **LYMPHOCYTOSIS:** an increased proportion of lymphocytes (above 0.35). Found in certain virus infections (measles, etc.), certain chronic infections (malaria, tuberculosis, etc.) and some toxic conditions.
- (d) **MONOCYTOSIS:** an increased proportion of monocytes (above 0.06). Found in certain bacterial and parasitic infections such as typhoid fever, malaria and kala-azar.
- (e) **NEUTROPENIA:** a decreased number of neutrophils. May occur in certain infections and some other diseases.

* The values are given in SI units - i.e., as number fractions. To obtain values in traditional units (i.e., as percentages), multiply each value by 100.

** In traditional units, the calculation is made by multiplying the percentage of neutrophils by the total leukocyte (white cell) count and dividing by 100. Example:

$$\begin{aligned} \text{Total leukocyte count} &= 5000/\text{mm}^3 \\ \text{Percentage of neutrophils} &= 42\% \\ \text{"Absolute neutrophil count"} &= (42 \times 5000)/100 = 2100/\text{mm}^3. \end{aligned}$$

28. Abnormal Red Cells: Microscopical Examination

In certain diseases, especially anaemia, the red cells may have an:

- abnormal shape
 - abnormal size
 - abnormal colour.
-

MICROSCOPICAL EXAMINATION

Where to look at red cells

Just before the end of the film: this is where they are spread out just touching one another but not overlapping.

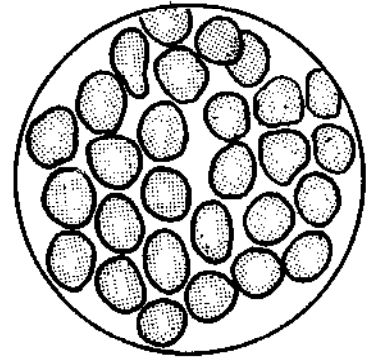
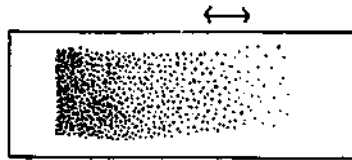

Wrong

Here the film is too thick; the red cells are too closely packed.

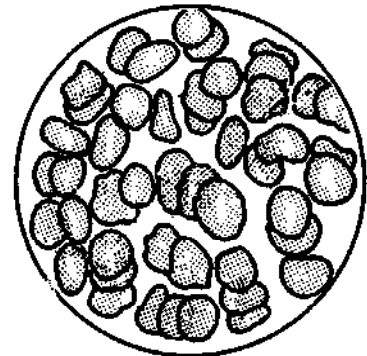
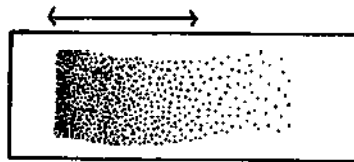

Wrong

Here the red cells are too few.

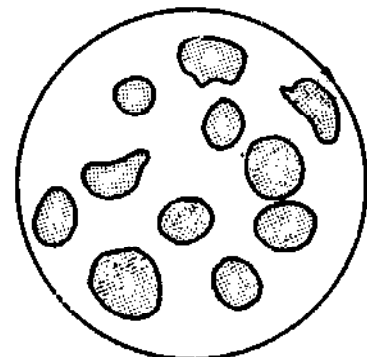
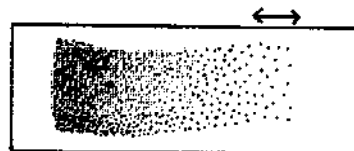

NORMAL RED CELLS

Size 7-8 μm
Shape round, occasionally slightly irregular
Staining periphery deep pink, centre pale pink or almost colourless.

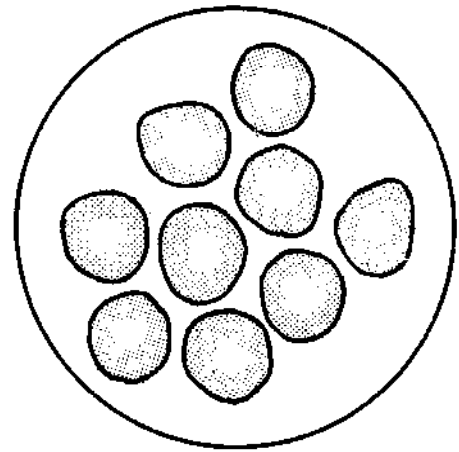

TARGET CELLS

Size 6-8 μm
Shape round or slightly irregular
Staining centre and rim stain well, but between them there is a colourless ring.

Seen in thalassaemia, sickle-cell anaemia and other anaemias caused by abnormal haemoglobins, and in iron-deficiency anaemia.

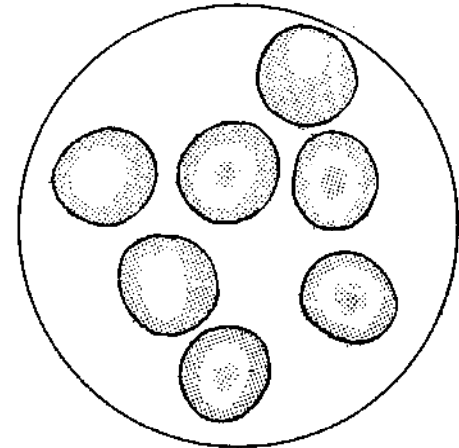

NUCLEATED RED CELLS (NORMOBLASTS)

Size 8-10 μm
Shape round, but often irregular
Nucleus small, deep purple, often eccentric nucleus, chromatin dense
Cytoplasm pink or greyish-blue

Seen in severe anaemias, for example sickle-cell anaemia, in severe bacterial infections and in leukaemias.

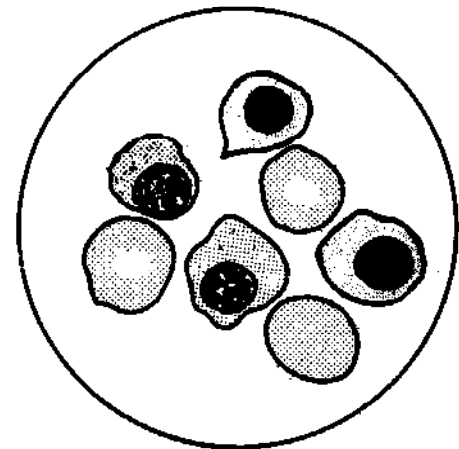

SICKLE CELLS

Shape elongated and narrow, often with one or both ends curved and pointed.

Seen in sickle-cell anaemia and sickle-cell thalassaemia, along with nucleated red cells, target cells and often macrocytes.

Examination of sickle cells in wet preparations is described on page 411.

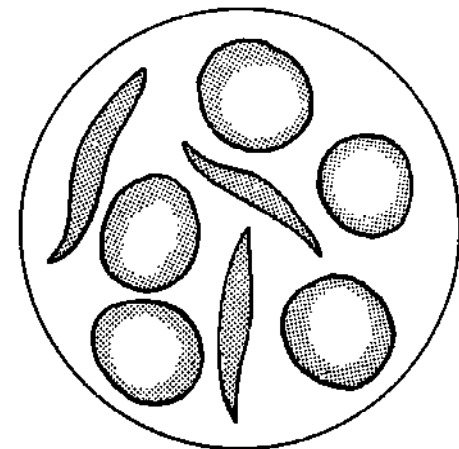

ANISOCYTOSIS

This term is used to describe a condition in which red cells of *different sizes* are present in the same blood, e.g. red cells of $9\ \mu\text{m}$ mixed with small red cells of $6\ \mu\text{m}$.

Seen in many types of anaemia.

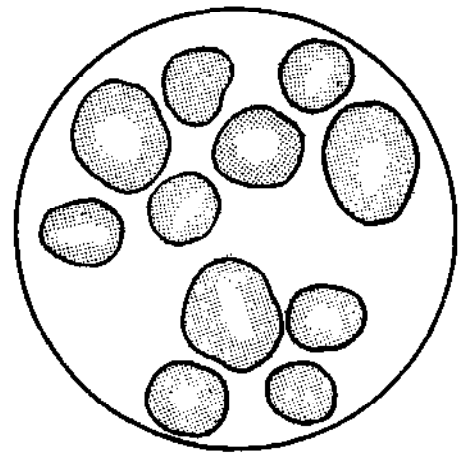

POIKILOCYTES

Red cells of *different shapes* in the same blood, e.g. a mixture of round, oval, triangular, pear-shaped, indented.

Seen in many types of anaemia.

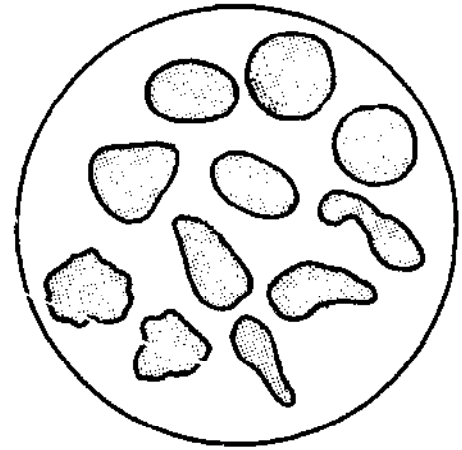

MICROCYTES (m)

Small red cells measuring about $5\ \mu\text{m}$.

Seen often in iron-deficiency anaemia.

MACROCYTES (M)

Large red cells measuring $9\text{--}10\ \mu\text{m}$.

Seen in macrocytic anaemias caused by folic acid or vitamin B-12 deficiency, and in certain liver diseases.

Large red cells staining pale blue-mauve (polychromasia) are reticulocytes (see page 414).

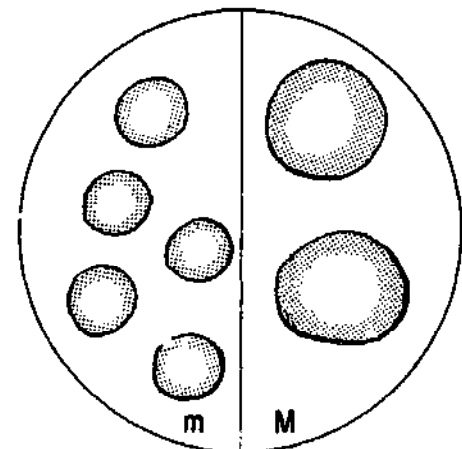

HYPOCHROMIC CELLS (A)

Size normal or slightly smaller than normal
Staining only the periphery of the cell stains, owing to lack of iron

Seen in iron-deficiency anaemia.

SPHEROCYTES (S)

Size small ($6\ \mu\text{m}$)
Shape perfectly round
Staining uniform, the whole cell evenly and more darkly stained.

Seen in haemolytic anaemias.

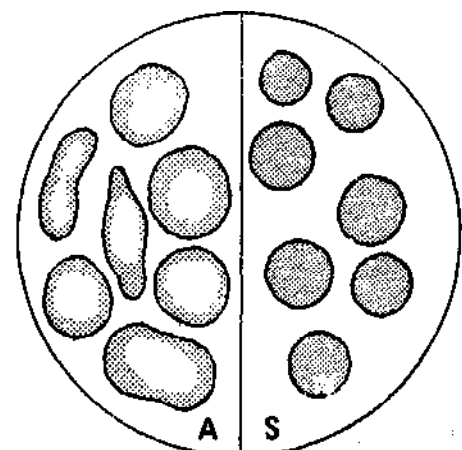

ELLIPTOCYTES

Size normal (8 μ m)
Shape oval
Staining darker at the periphery (especially at the poles)

Seen very occasionally. Found in hereditary elliptocytosis.

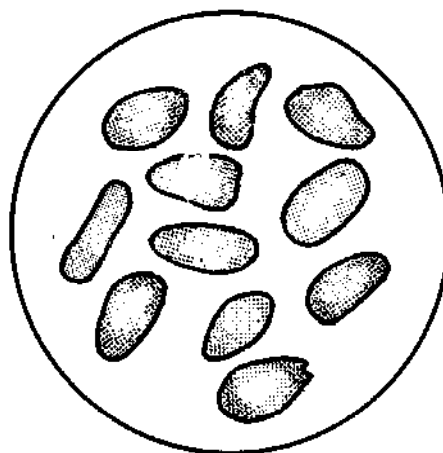

RED CELLS CONTAINING HOWELL-JOLLY (H.J.) BODIES

Red cells containing one or more large purple granules (nuclear remnants).
Do not confuse with platelets lying on the cells.

RED CELLS CONTAINING CABOT RING BODIES (C)

Red cells containing thin red lines in the form of loops or figures of eight.
Do not confuse with malaria parasites.

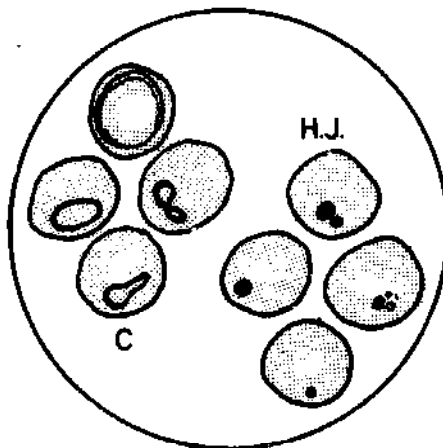

RED CELLS CONTAINING BASOPHILIC GRANULES

Red cells containing a number of fine purple-blue granules.
Do not confuse with stain deposits.

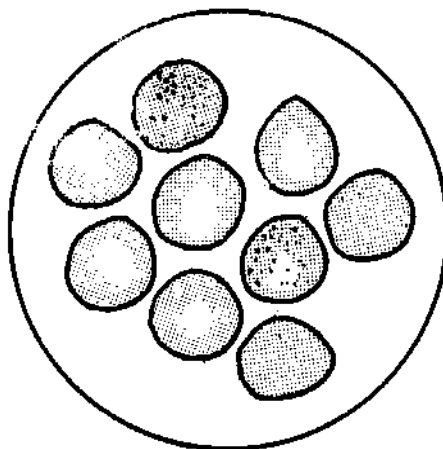

Note: Whenever you find red cells that look abnormal and are difficult to identify, refer the film to a specialist.

29. Test for Sickle Cells

Principle

One drop of blood is mixed with one drop of a sodium metabisulfite reagent on a slide. If the red cells contain an abnormal haemoglobin called haemoglobin S, they will become sickle-shaped or half-moon shaped.

The reagent removes oxygen from the cells, allowing sickling to take place.

Haemoglobin S is an inherited abnormal haemoglobin. If inherited from both parents it causes sickle-cell anaemia, a serious disease. If inherited from only one parent it causes sickle-cell trait, which does not usually cause disease.

The sickle-cell slide test does not distinguish between sickle-cell anaemia and sickle-cell trait.

Haemoglobin S occurs mainly in tropical Africa but also in the Middle East and among American Negroes.

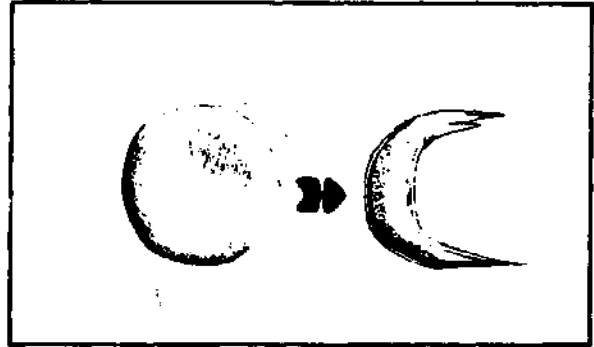

MATERIALS

- Glass slide and coverglass
- Pasteur pipette (or dropping pipette)
- 20 g/l sodium metabisulfite - fresh (reagent No. 48)
- Container to prevent drying of the preparation, such as a Petri dish.

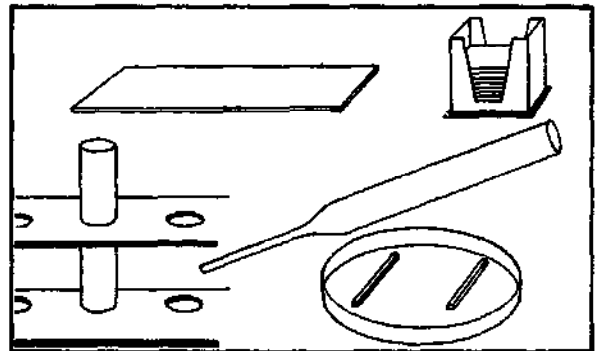

TECHNIQUE USING SODIUM METABISULFITE

1. Place a small drop of capillary blood (about 0.02 ml) in the centre of a slide.

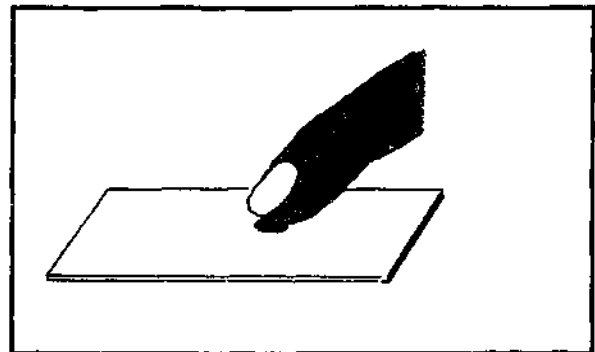

2. Add an equal drop of the sodium metabisulfite solution.

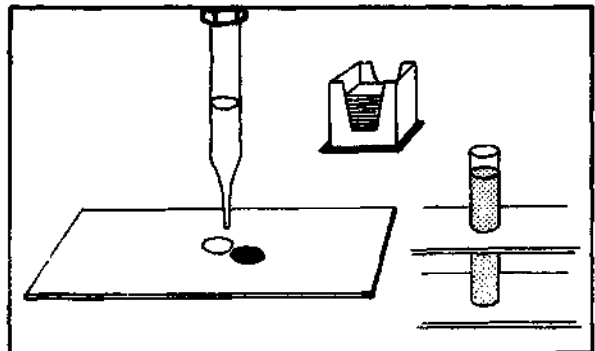

3. Mix carefully with the corner of the coverslip.
Cover with the coverslip, making sure that
no air bubbles form.

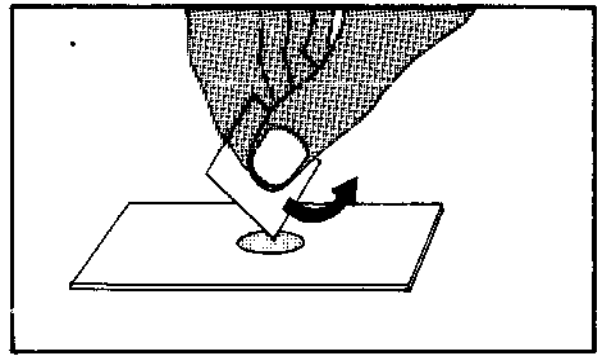

4. Place in a Petri dish that has wet filter paper in the bottom. Support the slide on two sticks.
Note: When using a reducing reagent such as sodium metabisulfite it is not necessary to seal the preparation.

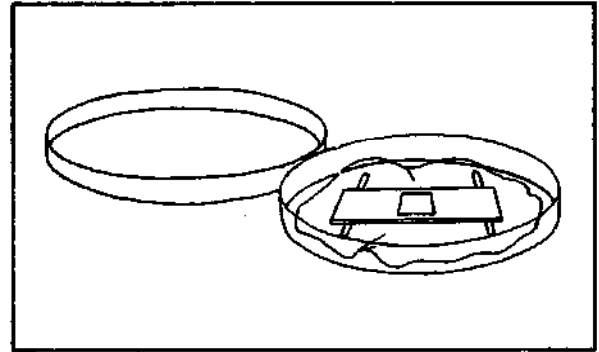

5. Wait 15 minutes.
Examine under the microscope (x 40 objective).
If the result is negative, re-examine after a further
15 minutes, then after 1 hour and 2 hours.

Results

Negative result: the red cells remain round.

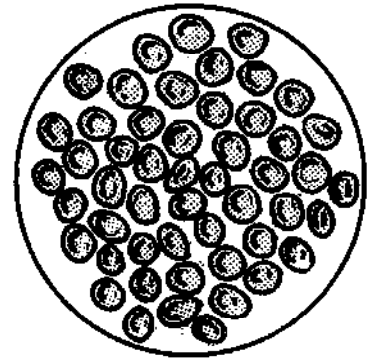

Positive result: the red cells become sickle-shaped or banana-shaped (a), often with spikes (b).

It is important to examine several parts of the preparation, as sickling can occur more quickly in one part than in another.

Do not mistake for sickle-cells cells lying on their side or crenated cells.



OTHER METHODS

1. The test can be carried out on venous blood provided it is *freshly* collected (1-2 hours) into an anticoagulant (EDTA dipotassium salt).
2. Tube method: commercial reagents are available for this method.

3. The sodium metabisulfite solution can be replaced by a drop of a thick suspension of coliform bacilli (*Escherichia coli*) from a stool specimen in sodium chloride solution.

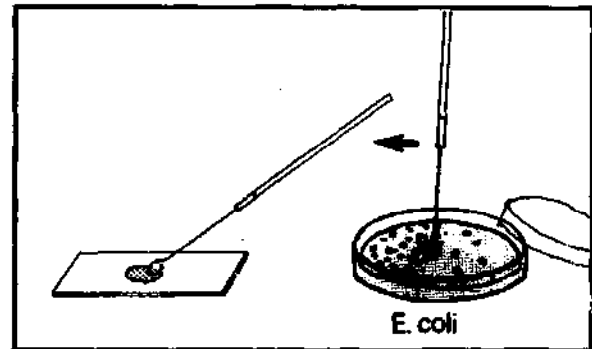

Important:

If the slide test is positive a thin blood film should be examined. Patients with sickle-cell anaemia have irreversibly sickled cells, nucleated red cells, target cells, marked poikilocytosis and often macrocytosis. Patients with sickle-cell trait are not usually anaemic and have a normal red cell morphology. Whenever possible haemoglobin electrophoresis should be carried out to confirm a diagnosis of sickle-cell disease. This can be done in a reference laboratory.

30. Reticulocytes

Reticulocytes are immature red cells that pass into the blood stream from the bone marrow. The number of reticulocytes in the blood indicates the degree of activity of the bone marrow, and when the marrow is very active (as in anaemias) their number increases.

Principle

Reticulocytes contain fine granules that can be stained with brilliant cresyl blue. A blood film is stained with this dye and a certain number of red cells observed under the microscope. From this observation, either (a) the number of reticulocytes per litre of blood or (b) the proportion of red blood cells that are reticulocytes is calculated.

MATERIALS

- Slides (grease-free)
- Glass spreader
- Small test-tubes
- Funnel
- Filter paper
- 2 Pasteur pipettes with teats
- Hand tally counter, if available
- Saturated solution of brilliant cresyl blue (reagent No. 9).

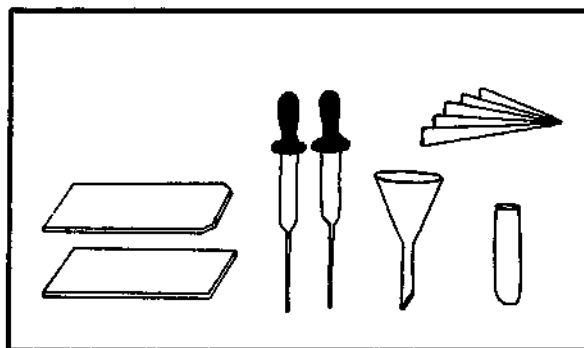

METHOD

1. Filter a little of the cresyl blue solution into a test-tube.
In the bottom of another tube place:
 - 2 drops of the filtered cresyl blue solution.

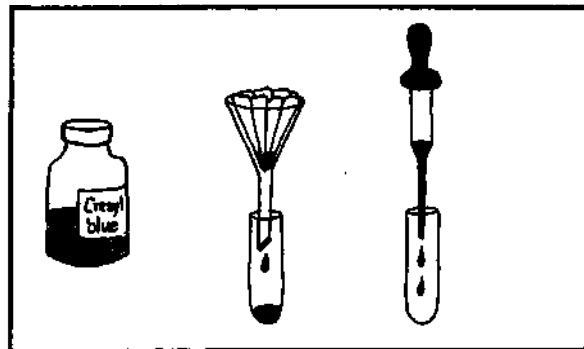

2. Collect a few drops of blood from the finger with a Pasteur pipette, or use venous blood collected in EDTA dipotassium salt and mix well.

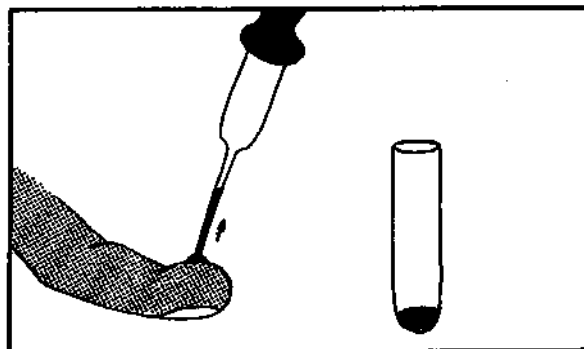

3. Add to the tube containing 2 drops of cresyl blue solution:
— 2 drops of blood.

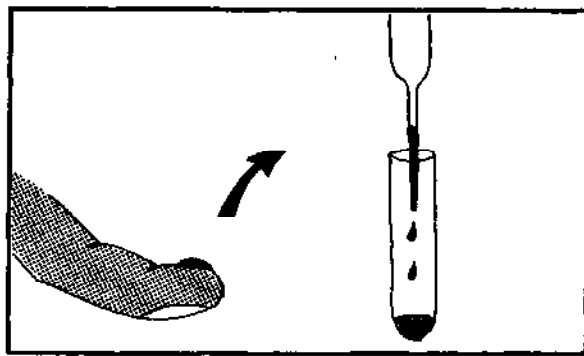

4. Mix by gently shaking the tube.
Plug the tube with non-absorbent cotton wool.
Leave for 15 minutes.

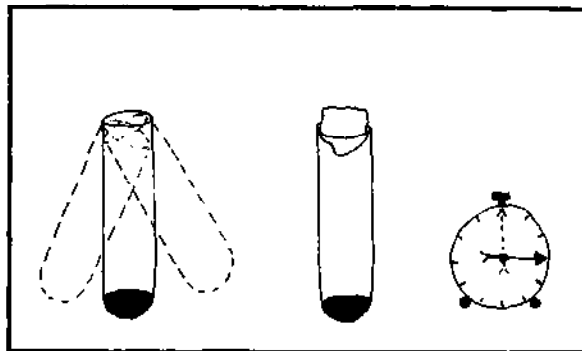

5. Take the tube and shake it gently.
Remove one drop of the mixture.
Place it on a slide ready for spreading.

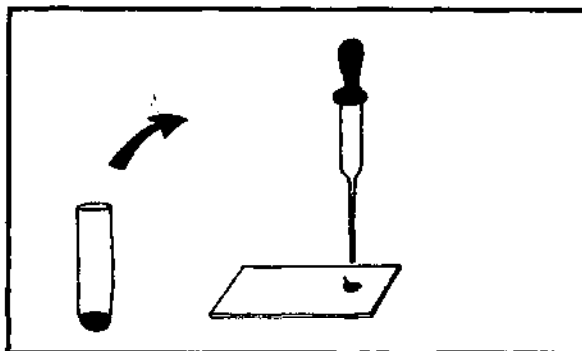

6. Make a thin smear of the mixture with the spreader.

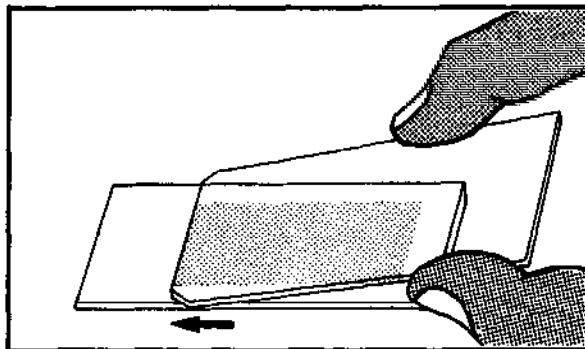

7. Dry the smear in the air.

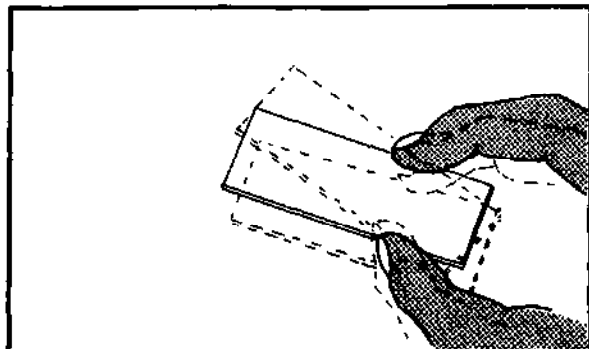

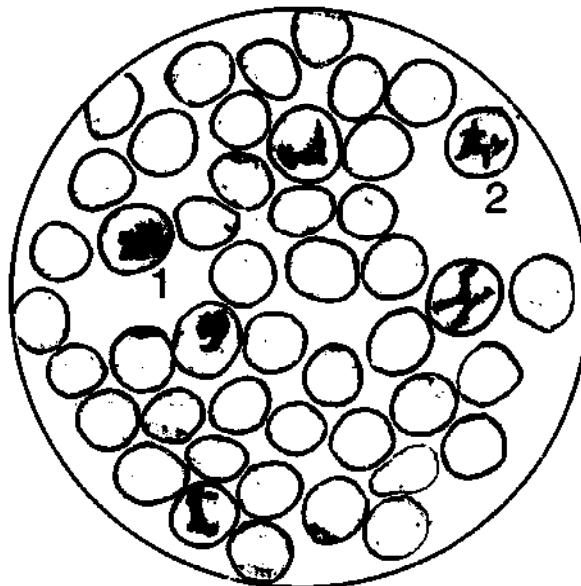

8. Examine the smear using the oil-immersion objective. Look at the end of the smear, where the red cells should be well separated from each other.

Red cells stain pale blue.

Reticulocytes are red cells that contain fine, deep-violet granules arranged in a network (reticulum). Reticulocytes may contain granules (1) or filaments (2).

9. Using the x 100 oil-immersion objective, examine at least 100 red cells. Keep a careful count of (a) the total number of red cells examined and (b) the number of this total that are reticulocytes. (Counting is easier if the size of the microscope field is reduced. This can be done by placing in the eyepiece a small circular piece of stiff black paper in which a hole about 5 mm in diameter has been punched.)
10. Some haematologists prefer reticulocytes to be reported in terms of number concentration (number of reticulocytes per litre of blood), while others prefer them to be reported in terms of number fraction (the proportion of red cells that are reticulocytes). Depending on the practice in your laboratory or the specification of the requesting physician, make the calculation as follows:*

- (a) *Number concentration.* To calculate this, you must know the total erythrocyte number concentration. If C is the latter (omitting the " $\times 10^{12}/l$ ") and n the number of reticulocytes seen in observing 500 erythrocytes, the reticulocyte number concentration is $C \times 2n \times 10^9/l$. Example:

$$\begin{aligned} \text{erythrocyte number concentration} &= 4.5 \times 10^{12}/l \\ \text{number of reticulocytes seen in counting 500 erythrocytes} &= 6 \\ \text{reticulocyte number concentration} &= 4.5 \times (2 \times 6) \times 10^9/l \\ &= 4.5 \times 12 \times 10^9/l \\ &= 54 \times 10^9/l \text{ (report this result).} \end{aligned}$$

- (b) *Number fraction.* To calculate this you do not need to know the erythrocyte number concentration. If n is the number of reticulocytes seen in examining 500 erythrocytes, the reticulocyte number fraction is $2n \times 10^{-3}$. Example:

$$\begin{aligned} \text{number of reticulocytes seen in counting 500 erythrocytes} &= 6 \\ \text{reticulocyte number fraction} &= (2 \times 6) \times 10^{-3} = 12 \times 10^{-3}. \end{aligned}$$

Note: If more than 500 erythrocytes are examined on the blood film, the calculation will have to be adjusted accordingly.

Normal range

	reticulocyte number concentration**	reticulocyte number fraction
Infants at birth	$100 \times 10^9/l - 300 \times 10^9/l$	$20 \times 10^{-3} - 60 \times 10^{-3}$
Adults and children	$8 \times 10^9/l - 110 \times 10^9/l$	$2 \times 10^{-3} - 20 \times 10^{-3}$

* The calculations (and the table of normal ranges) are given in SI units. Traditionally, reticulocytes have been reported in the form of percentages (i.e., the proportion, expressed as a percentage, of the erythrocytes in the blood that are reticulocytes). If 500 erythrocytes are observed on the blood film, and n of them are reticulocytes, the percentage of erythrocytes is calculated by multiplying n by 0.2. Example: of 500 erythrocytes examined, 25 are reticulocytes. The percentage of reticulocytes is then $25 \times 0.2 = 5\%$. The normal range for infants at birth is 2.0%–6.0%, and that for adults and children is 0.2%–2.0%.

** Approximate values. The concentration depends on the erythrocyte number concentration; see table on page 369.

OTHER STRUCTURES THAT CAN BE SEEN IN THE BLOOD FILM

The blood film stained with brilliant cresyl blue that is used for the reticulocyte determination may also show the following bodies:

Haemoglobin H bodies. These, if present, will be seen as pale blue dots, variable in size; unlike the reticulum of the reticulocytes, they occur in most of the red cells. They are found in alpha thalassaemia intermedia or haemoglobin H disease.

Heinz bodies. These, if present, will be seen as blue granules, variable in size, lying to one side of the cell, near the cell membrane. They occur in glucose-6-phosphate dehydrogenase deficiency following treatment with certain drugs.

31. Erythrocyte Sedimentation Rate (ESR)

Principle

Blood collected into an anticoagulant is placed in a long graduated tube held in a vertical position.

The red cells settle to the bottom leaving a layer of plasma above.

The height of the column of plasma after 1 hour indicates the sedimentation rate of the erythrocytes (red cells).

MATERIALS

- Westergren ESR tube:
 - internal diameter 2.5 mm
 - graduated from 0 to 200 mm (often marked 1 to 20, 1 corresponding to 10, 2 to 20, etc.)
- Westergren stand
- Anticoagulant: 38 g/l (3.8%) trisodium citrate solution (reagent No. 54) (keep in refrigerator)
- 5 ml graduated syringe
- Timer.

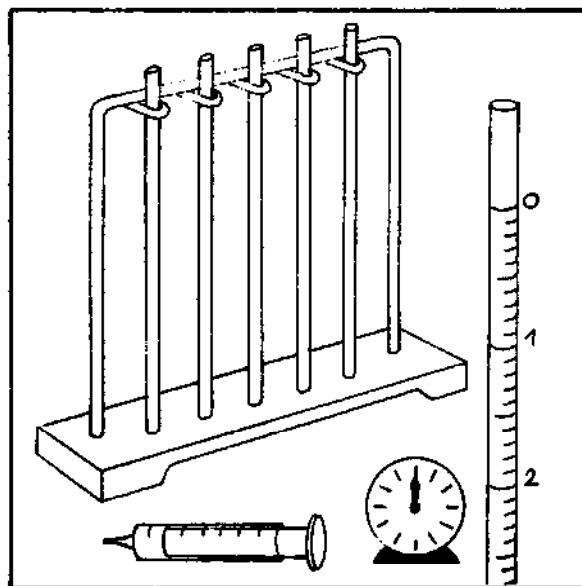

METHOD

1. Place in a tube or bottle:
 - 0.4 ml of the trisodium citrate solution.

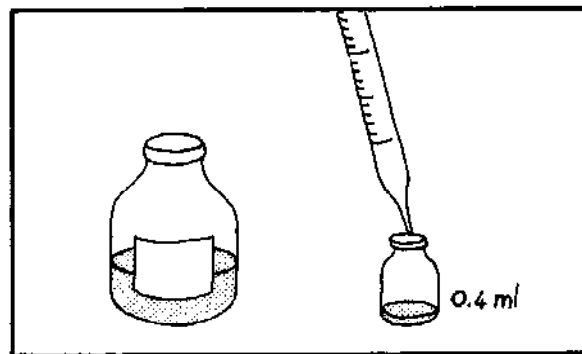

2. Collect venous blood.*

Apply the tourniquet as loosely as possible; puncture the vein at once and release the tourniquet.

Collect into a syringe:

- 2 ml of blood.

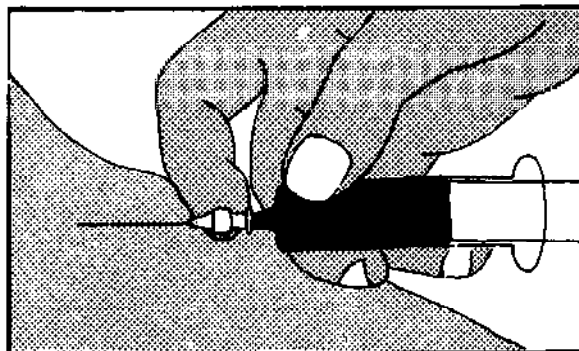

*Blood previously collected into a bottle with EDTA dipotassium salt can also be used for this test.

3. Remove the needle from the syringe and add 1.6 ml blood to the bottle containing anticoagulant (marked to contain a total of 2.0 ml).

Shake gently.

Measurement of the ESR should begin within 2 hours of collection of the blood.

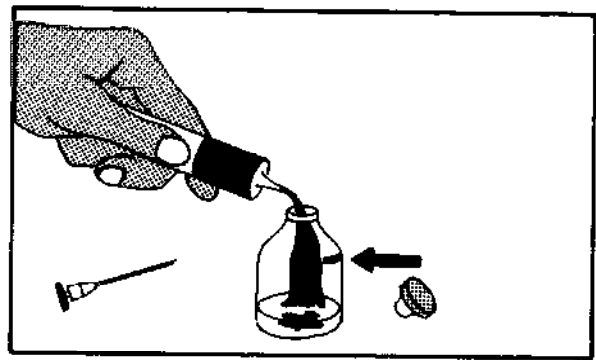

4. Draw the citrated blood into the Westergren tube (using a rubber bulb if possible) up to the 0 mark.

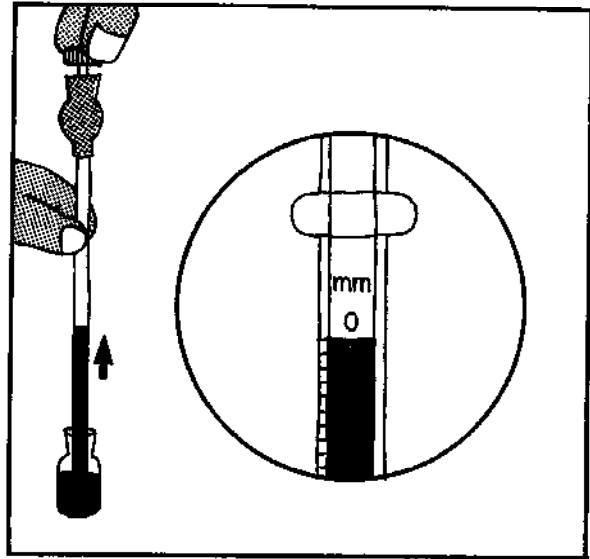

5. Place the tube in the Westergren stand, making sure that the tube is completely upright.

Check that there are no air bubbles in the tube.

Check that the stand is level.

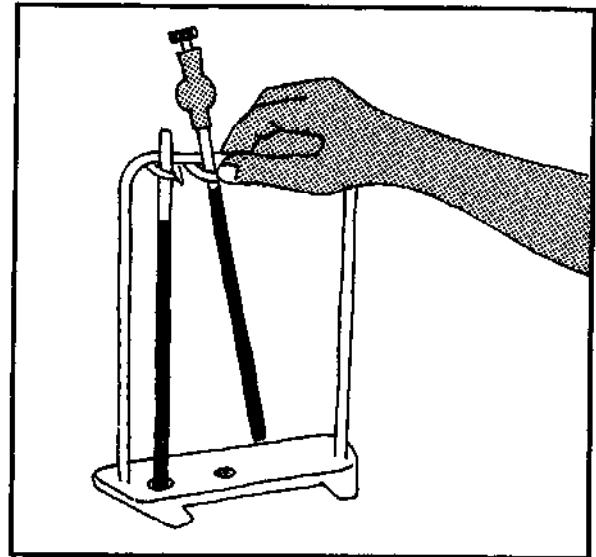

Wait one hour (set the timer to ring), then note the height of the column of plasma in mm graduations starting from the 0 mark at the top of the tube.

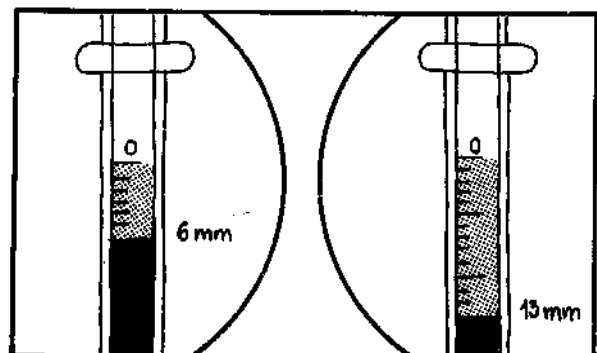

RESULTS

The result is expressed as follows:
ESR mm/h.

Normal range

Men: 1-10 mm/h
Women: 3-14 mm/h.

ESR and anaemia

If the patient has a deficiency of red cells measurement of the ESR is of little value.

It is pointless to measure the ESR for patients who have an erythrocyte volume fraction of less than 0.3 (packed cell volume of less than 30%).

ESR and dehydration

If a patient is dehydrated measurement of the ESR has little value.

Increased ESR

Any disease that produces plasma protein changes will increase the ESR.

Chronic infections also do so.

Very high ESR values occur in:

- tuberculosis
- trypanosomiasis
- malignant diseases.

In normal pregnancy the ESR is raised.

Temperature of the test

The ESR increases with the temperature (from 23 °C). In hot countries make sure that the stand is not placed in a warm part of the laboratory (e.g. not in the sun).

Washing Westergren tubes

Rinse in water, then leave to soak in clean water for 12 hours.

Dry completely (in the incubator at 37 °C, if possible).

Do not use washing powder, acids or ethanol.

32. Bleeding Time: Duke Method

Principle

A small cut is made with a lancet in the lobe of the ear. Blood flows from the puncture; the time it takes for the bleeding to stop is measured.

The test is performed:

- for the diagnosis of certain haemorrhagic disorders
- before surgical operations
- before liver or spleen puncture.

MATERIALS

- 1 sterile blood lancet
- Ether
- 1 slide
- Filter (or blotting) paper
- 1 stopwatch, if available, otherwise a watch with a second hand.

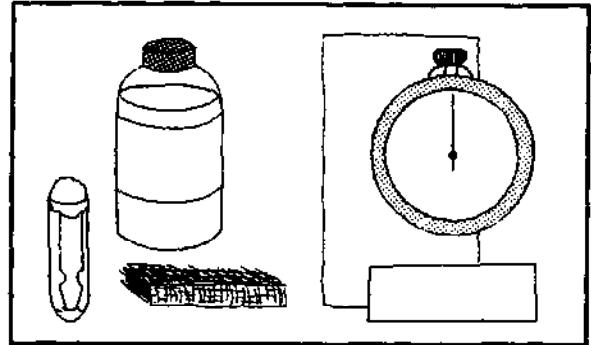

METHOD

1. Gently clean the lobe of the ear with cotton wool and ether. Do not rub.

Allow to dry.

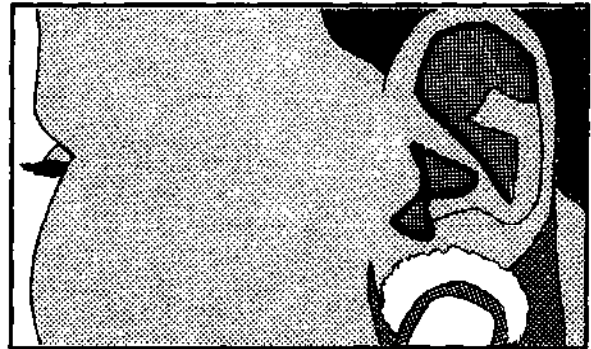

2. Puncture the ear lobe deeply.

Start the stopwatch.

The blood should flow freely, without need to squeeze the ear lobe.

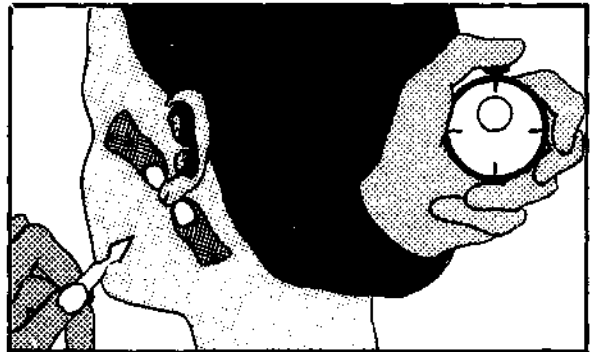

3. After 30 seconds:

Collect the 1st drop of blood on a corner of the blotting paper.

Do not touch the skin with the paper.

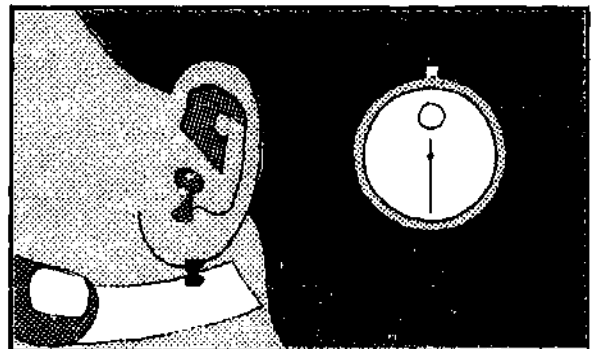

4. *Wait 30 seconds more:*

Collect the 2nd drop of blood in the same way, a little further along the strip of paper.

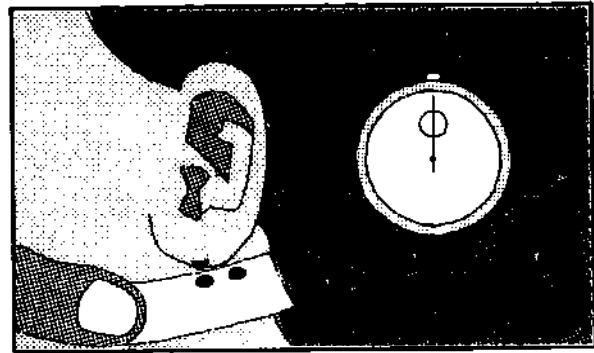

5. Continue to collect one more drop of blood every 30 seconds.

The drops become progressively smaller.

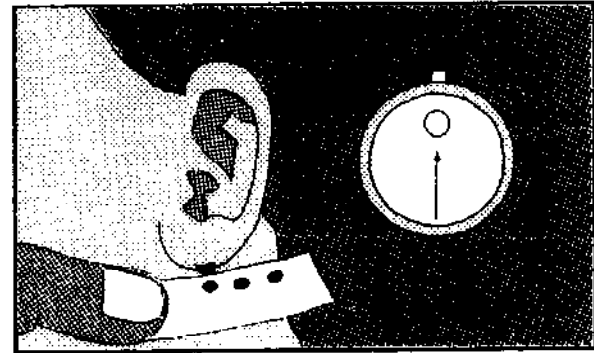

6. When no more blood appears *stop* the stopwatch (or note the time on the watch).

Another method is to count the number of drops on the blotting paper and multiply by 30 seconds.

For example: there are 7 drops.

The bleeding time is 7×30 seconds = $3\frac{1}{2}$ minutes.

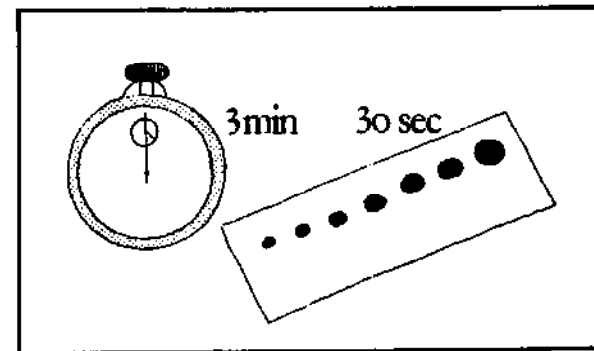

RESULTS

Report the bleeding time to the nearest half minute.

Mention also the normal range for the method used.

Example: bleeding time $3\frac{1}{2}$ minutes (Duke normal 1-5 minutes).

Normal range

– 1-5 minutes

If the bleeding time is prolonged examine a Romanowsky-stained thin blood film (see page 391) to see whether the platelets appear few in number (venous blood must be used).

33. Whole Blood Coagulation Time: Lee and White Method

Principle

Venous blood is collected in a glass tube.
The time it takes for the blood to coagulate (clot)
is noted.

The test is of limited value, as it detects only
severe clotting factor deficiencies.

MATERIALS

- 2 clean 75 x 10 mm glass tubes of the same bore, marked to hold 1 ml
- Stopwatch or timer
- 37 °C water bath, or vacuum flask containing water at 37 °C
- Materials to carry out venepuncture.

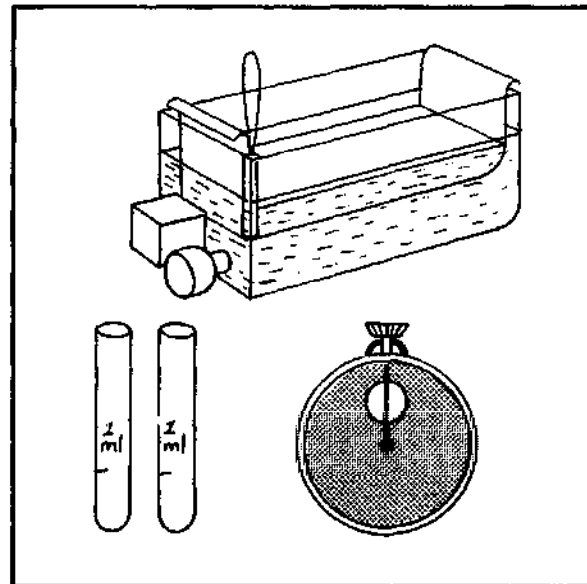

METHOD

1. Collect just over 2 ml venous blood using a plastic syringe.

Venepuncture must be carried out quickly and well.

Start the stopwatch as soon as the blood enters the syringe.

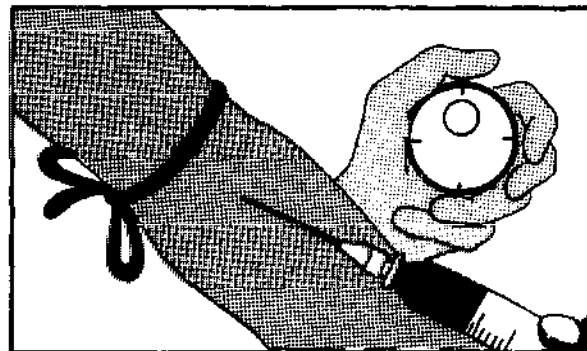

2. Remove the needle from the syringe and fill each tube with blood to the 1 ml mark.
Plug both tubes with non-absorbent cotton wool.
Place them in the water bath at 37 °C (or in the vacuum flask of water kept at that temperature).

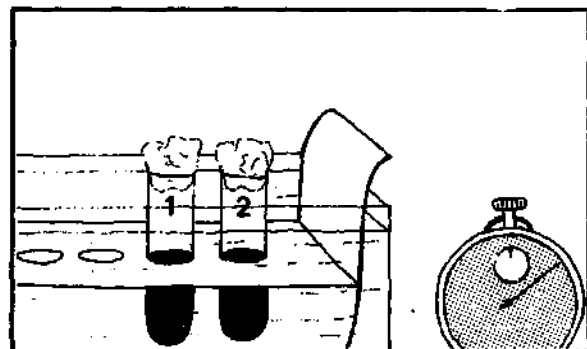

3. *After 3 minutes* remove the 1st tube from the water bath.

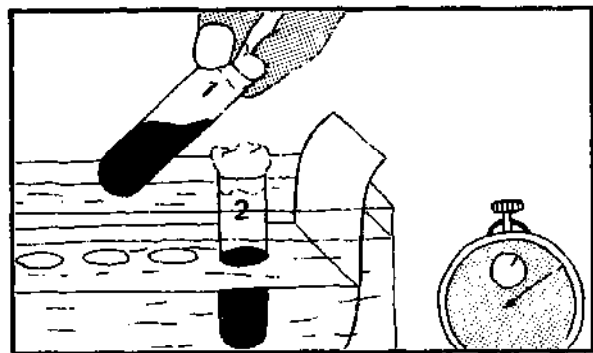

- Tilt the tube at an angle of 45° to see whether the blood has clotted.
4. If the blood has not clotted, return it to the water bath and examine it at 30-second intervals to see if it has clotted.

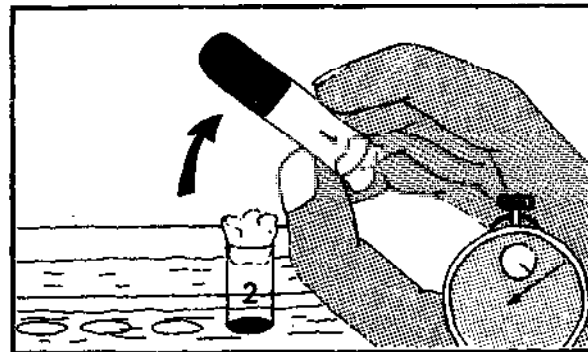

5. After the blood in the first tube has clotted, examine the second tube immediately.
- The blood in the second tube usually clots very soon after the blood in the first tube. *Stop* the stopwatch, or note the time.
- The coagulation time is reported as the clotting time of the second tube.

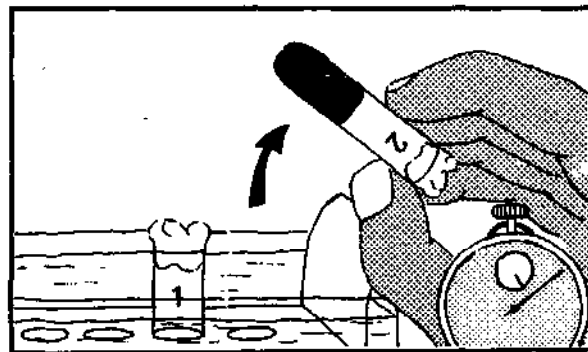

RESULTS

Record the clotting time in minutes to the nearest half minute.

Normal range

– 5–12 minutes.

A patient with a prolonged clotting time should be referred to a specialist centre for further investigation.

34. Clot Retraction and Lysis Time

Principle

The whole blood coagulation time is measured as indicated on page 423.

The tubes are kept:

- for observation of the retraction of the clot
- for measurement of the time it takes for the clot to dissolve (lysis).

These tests are carried out:

- for the diagnosis of certain haemorrhagic disorders
- before and after surgical operations.

METHOD

1. Leave the tubes in the water bath (or at room temperature).

Examine the clot:

- after 1 hour
- after 2 hours
- after 3 hours
- after 4 hours.

The clot normally remains solid during the first 4 hours, though it begins to retract, usually in the first hour.

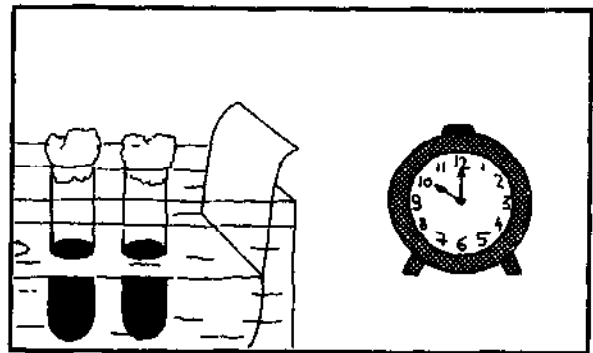

2. After 4 hours examine the clot.

It will have retracted, the red cell mass separating from the yellow serum.

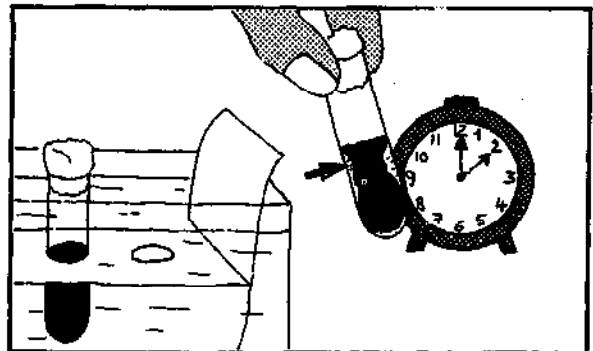

RESULTS

(a) Normal retraction

The red clot is well separated and, at the surface, is attached to the sides of the tube. There may be a small deposit of red cells in the bottom of the tube; it should not be more than 5 mm thick.

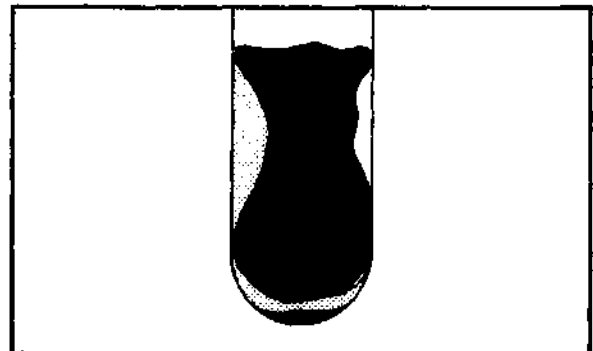

(b) Abnormal retraction

1. There may be a small red clot at the bottom of the tube, not necessarily attached to the sides of the tube. It is surrounded by sedimented red cells and covered by supernatant plasma/serum.

— The blood is deficient in fibrinogen.

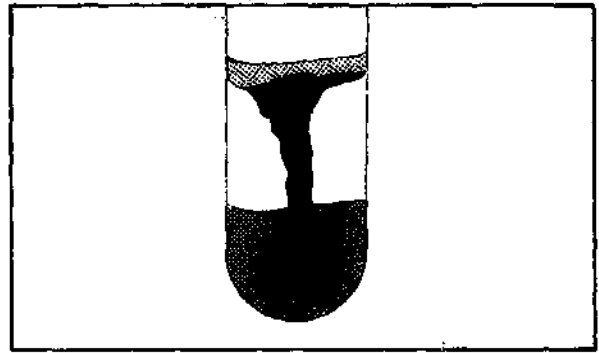

2. There may be a red clot that remains almost completely attached to the sides of the tube and has retracted very little, if at all. Hardly any serum has exuded.

— The blood is deficient in platelets.

(Examine a Romanowsky-stained thin blood film, using venous blood, see page 391.)

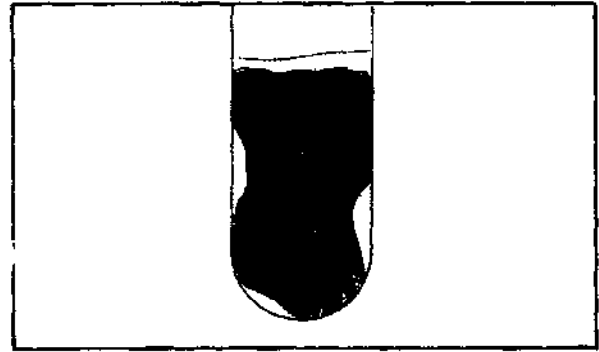

3. There may be a yellow clot: clotted plasma. Beneath it is a poorly retracted red clot.

— This plasma coagulation is caused by abnormal plasma proteins.

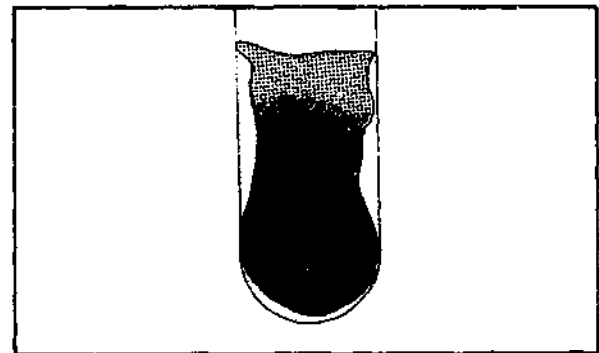

4. There may be no clot at all or a yellow clot that forms very slowly over the red cell deposit.

— There is a serious clotting factor deficiency such as can occur with haemophilia.

Haemophilia is a hereditary haemorrhagic disease affecting males.

Report the clot retraction as:

- normal
— abnormal, with a description of the clot.

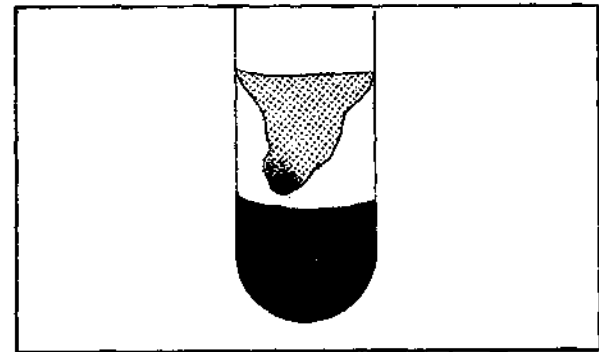

Lysis time

Examine the clot:

- after 12 hours
— after 24 hours
— after 48 hours
— after 72 hours

until lysis occurs; that is, until the clot dissolves completely and all the red cells sink to the bottom of the tube.

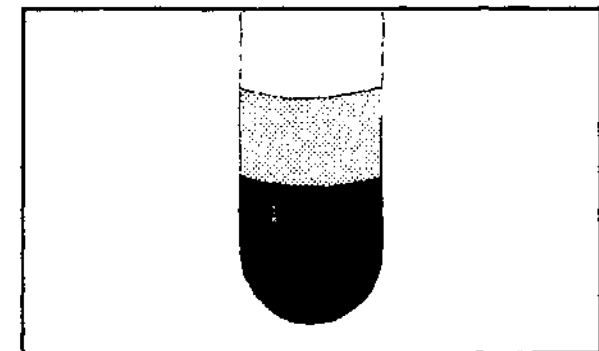

Results

Normal clot lysis time 72 hours or more.

Reduced clot lysis time 1-48 hours.

In cases of acute fibrinolytic disease the clot may dissolve in 1-4 hours.

Report the clot lysis time in hours.

D. BLOOD CHEMISTRY

35. Blood and CSF Glucose Estimation: Orthotoluidine Method

Principle

The proteins are first precipitated by trichloroacetic acid. The glucose in the filtrate reacts with the orthotoluidine reagent to give a green colour. This is then measured in a photoelectric colorimeter.

A blood glucose (sugar) estimation is required to help in the diagnosis of diabetes mellitus or any other condition in which there is abnormal carbohydrate metabolism. In diabetes mellitus there is a deficiency of the hormone insulin, which controls sugar metabolism in the body. In this disease glucose is usually found in the urine (see page 311). CSF sugar estimation is required to help in the diagnosis of meningitis (see page 344).

MATERIALS

- Glucose reagents (reagent No. 29)
 - (a) trichloroacetic acid, 30 g/l (3%)
 - (b) orthotoluidine reagent
 - (c) benzoic acid, 1 g/l (0.1%)
 - (d) glucose stock reference solution
 - (e) glucose working reference
- Colorimeter
- Whole blood (capillary or venous), plasma or serum, taken from a fasting patient*
- Conical tubes and larger size test-tubes (able to hold 20 ml)
- Pipettes graduated 0.1 ml (100 μ l), 1.0 ml, 5.0 ml
- Boiling water bath
- Control serum. A control serum should be used with each batch of tests. If the result of the control serum is correct, it can be assumed that the patient's results will also be correct.

* If venous blood is used, it is advisable to use fluoride oxalate (reagent No. 23) as the anticoagulant. This will prevent the glucose from being destroyed in the blood.

METHOD

1. Into a conical centrifuge tube pipette 1.9 ml of trichloroacetic acid solution.
2. With a 0.1 ml blood pipette deliver 0.1 ml of whole blood, serum or plasma (B in the drawing) at the bottom of the tube – that is, under the trichloroacetic acid solution (A in the drawing). The trichloroacetic acid solution will become cloudy where it makes contact with the blood, etc.
3. Raise the pipette and draw clear trichloroacetic acid solution into it in order to wash out all traces of blood, plasma or serum.
4. Expel the trichloroacetic acid solution from the pipette into the centrifuge tube.
5. Mix well (the entire solution will become cloudy) and allow to stand for 5 minutes.
6. To sediment the precipitated proteins and obtain a clear supernatant fluid, centrifuge at maximum speed for 5 minutes.

Note: Trichloroacetic acid is *corrosive*. Use it with care.

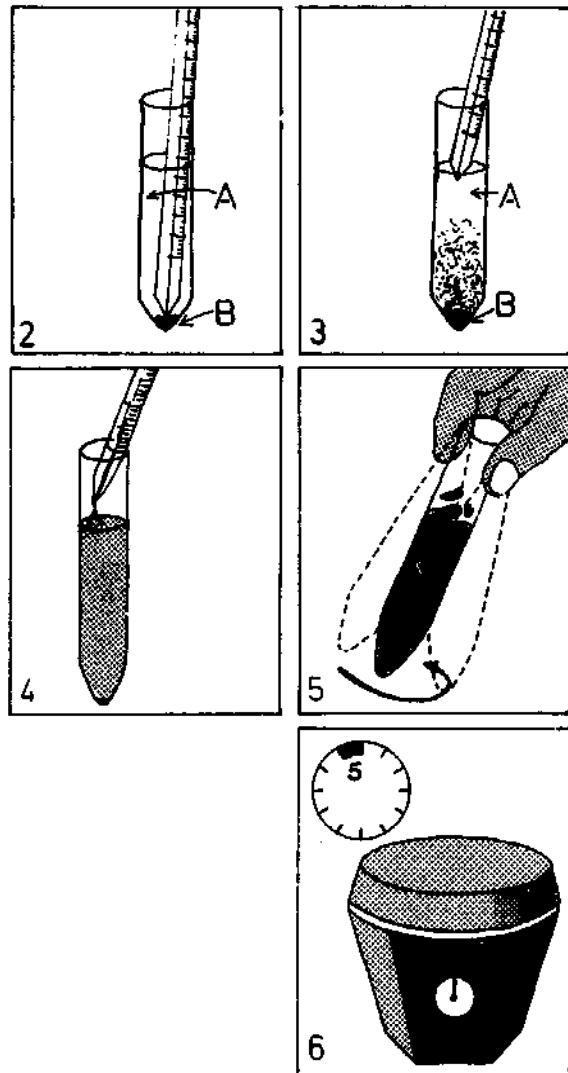

7. Take 3 (or more if needed) large test-tubes and label as follows:
- Blank tube - B
 - Reference tube - R
 - Patient tube - P

Note: if more than one estimation is being carried out, label each of the tubes with the name or number of the patient.

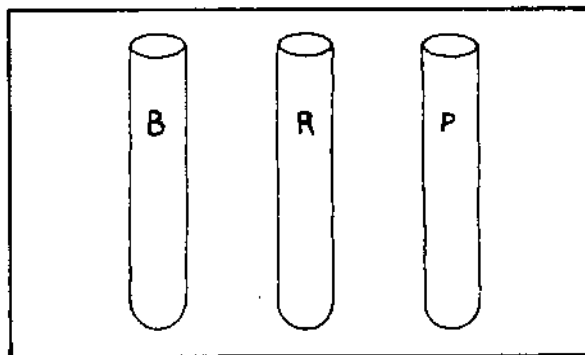

8. Pipette into each tube as follows:

- Blank - 1.0 ml of distilled water
- 5.0 ml orthotoluidine reagent
- Reference - 1.0 ml of working glucose reference solution
- 5.0 ml orthotoluidine reagent
- Patient - 1.0 ml supernatant fluid
- 5.0 ml orthotoluidine reagent

Note: The orthotoluidine reagent is *corrosive*; use, if possible, a rubber bulb to draw up the fluid in the pipette.

9. Mix the contents of each tube. Place all the tubes in a boiling water bath for 10 minutes to allow the green colour to develop.

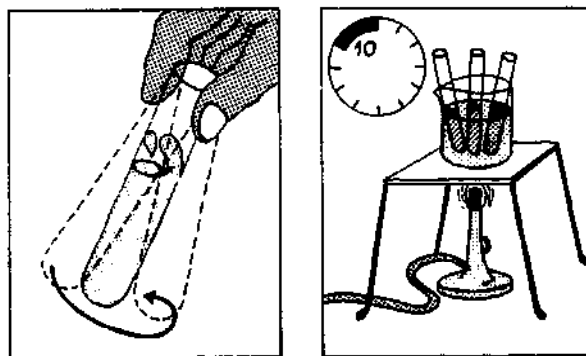

10. Remove the tubes and allow them to cool in a beaker of cold water for 15 minutes.

Measure the colour produced in a colorimeter at a wavelength of 630 nm:

- place the orange-red filter in the colorimeter
- fill the colorimeter test-tube or cuvette with the solution contained in the tube marked B (blank) and place in the colorimeter.
- adjust the reading of the colorimeter to zero with the cuvette containing solution B in place
- pour solution B out of the cuvette, rinse the latter with a small amount of solution R (reference), pour this out, and fill the cuvette with solution R; place the cuvette in the colorimeter and read the absorbance, A_R
- pour solution R out of the cuvette, rinse the latter with a small amount of solution P (patient), pour this out, and fill the cuvette with solution P; place the cuvette in the colorimeter and read the absorbance, A_P .

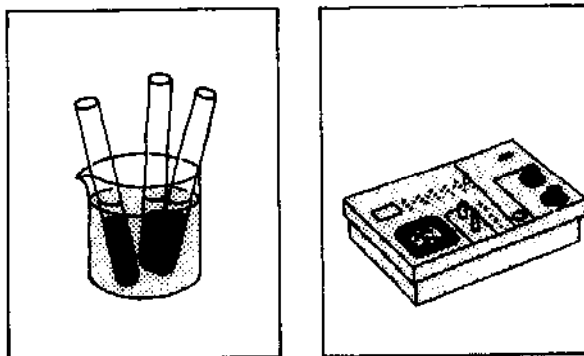

CALCULATION

Calculate the concentration of glucose in the blood or cerebrospinal fluid as follows:*

(a) *Blood*

Concentration of glucose = $(A_P/A_R) \times 11.1$ mmol/l (millimoles per litre)

(b) *Cerebrospinal fluid*

Concentration of glucose = $(A_P/A_R) \times 2.78$ mmol/l

Note: If a control serum has been included, make the calculation for that serum in exactly the same way, substituting A_C (absorbance of the control solution) for A_P in the formula.

Normal range

The normal ranges of blood glucose concentration in fasting patients are approximately as follows:

venous blood, serum, or plasma: 3-5 mmol/l
capillary blood: 3.3-5.5 mmol/l.

The normal range in cerebrospinal fluid is approximately 2.5-4.2 mmol/l.

High and low concentrations

If unusually high or low glucose concentrations are found, the test should be repeated in order to confirm the results, as described below.

Concentrations higher than 16.5 mmol/l: Dilute solutions B (blank) and P (patient) with an equal quantity of glacial acetic acid. Using diluted solution B in the cuvette, set the colorimeter reading to zero. Then read the absorbance A_P with diluted solution P in the cuvette. Recalculate the glucose concentration, using the new value of A_P and the value of A_R that was obtained previously. Multiply the result by 2 (because solution P has been diluted 1 in 2) to obtain the true glucose concentration.

Concentrations lower than 2.2 mmol/l. If values as low as this are obtained, the entire test should be repeated. In step 1, use 1.8 ml of trichloroacetic acid solution (instead of 1.9 ml), and in step 2 use 0.2 ml of blood, serum or plasma (instead of 0.1 ml). Perform the test and calculate the result exactly as before. Divide the result by 2 to obtain the true glucose concentration.

* The calculations given are for SI units. In traditional units blood glucose concentrations are calculated by the formula $(A_P/A_R) \times 200 =$ concentration in mg/100 ml; CSF glucose concentrations are calculated by the formula $(A_P/A_R) \times 50 =$ concentration in mg/100 ml. Approximate normal values are: venous blood, 55-90 mg/100 ml; capillary blood, 60-100 mg/100 ml; cerebrospinal fluid, 45-75 mg/100 ml.

36. Urea Estimation: Diacetyl Monoxime/Thiosemicarbazide Method

Principle

The proteins are first precipitated by trichloroacetic acid. The urea in the filtrate reacts with diacetyl monoxime in the presence of acid, oxidizing reagent and thiosemicarbazide to give a solution coloured red. This is then measured in a photoelectric colorimeter.

Urea is a waste product formed in the liver following the breakdown of proteins. It passes into the blood, is filtered out by the kidneys and excreted in the urine.

If the kidneys do not remove the urea the amount of urea in the blood is increased. This can happen if the kidney tubules become damaged or if the volume of blood flowing through the kidneys is reduced.

MATERIALS

- Urea reagents (reagent No. 56):
 - (a) Trichloroacetic acid, 100 g/l (10%)
 - (b) Stock diacetyl monoxime
 - (c) Stock thiosemicarbazide
 - (d) Working diacetyl monoxime/thiosemicarbazide
 - (e) Acid reagent
 - (f) Blank reagent
 - (g) Urea stock reference solution
 - (h) Urea working reference solution.
- Colorimeter
- Patient's serum, plasma, or blood (in EDTA dipotassium salt solution)
- Conical tubes and test-tubes able to hold 20 ml
- Graduated pipettes 0.5 ml (if possible) or 1 ml, 2 ml, 5 ml, 10 ml
- Small 25 ml measuring cylinder (if possible)
- Boiling water bath
- Control serum.

A control serum or a pool of patients' serum should be used with each batch of tests. If the result of the control serum is correct, it can be assumed that the patient's results will be correct also.

METHOD

1. Prepare the colour reagent immediately before use, using a 1 in 6 dilution of the working diacetyl monoxime/thiosemicarbazide reagent in the acid reagent.

Example: The blank tube, reference tube, and patient tube will each require 5 ml of colour reagent.

	Acid reagent	Working diacetyl monoxime/ thiosemicarbazide
Therefore: For 1 urea estimation use . .	15 ml	3 ml
For 2 urea estimations use —	20 ml	4 ml
For 3 urea estimations use —	25 ml	5 ml

Mix the reagent in a large test-tube or small flask

2. Pipette into a conical centrifuge tube:
- 0.8 ml distilled water
 - 0.2 ml whole blood treated with EDTA dipotassium salt, or serum or plasma.

Mix.

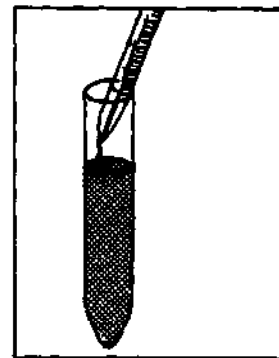
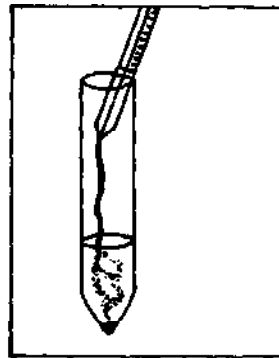

3. Add 1 ml of 10% trichloroacetic acid and mix. The mixture will become cloudy.

To sediment the precipitated proteins and obtain a clear supernatant fluid, centrifuge for 5 minutes at high speed.

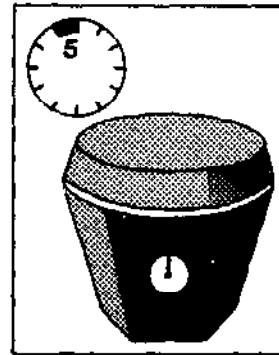
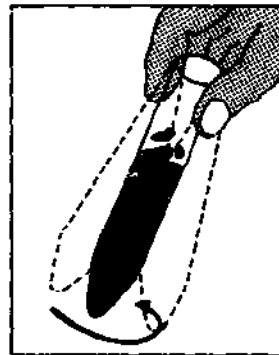

4. Take 3 (or more if needed) large test-tubes and label as follows:
- Blank tube - B
 - Reference tube - R
 - Patient tube - P.

Note: If more than one estimation is being carried out, label each of the P tubes with the name or number of the patient.

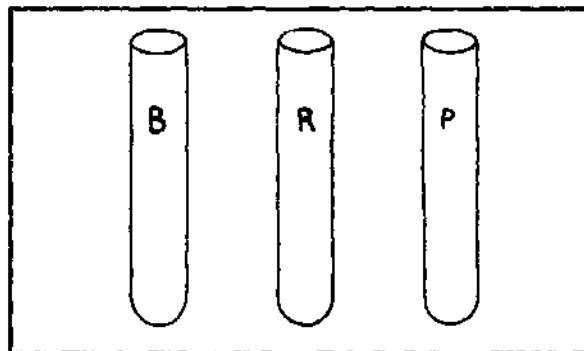

5. Pipette into each tube as follows:
- Blank
 - 0.5 ml blank reagent
 - 5.0 ml freshly prepared colour reagent
 - Reference
 - 0.5 ml working reference solution
 - 5.0 ml freshly prepared colour reagent
 - Patient
 - 0.5 ml supernatant fluid
 - 5.0 ml freshly prepared colour reagent.

6. Mix the contents of each tube. Place all the tubes in a boiling water bath for 5 minutes to allow the red colour to develop.

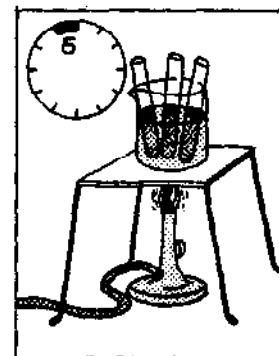
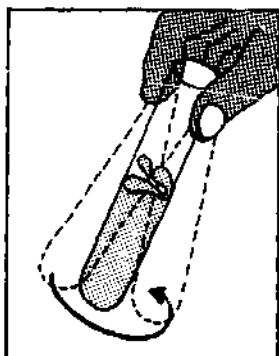

7. Remove the tubes and allow to cool in a beaker of cold water for 10 minutes.

Measure the colour produced in a colorimeter at a wavelength of 520 nm:

- place the green filter in the colorimeter
- fill the colorimeter test-tube or cuvette with the solution contained in the tube marked B (blank) and place in the colorimeter
- adjust the reading of the colorimeter to zero with the cuvette containing solution B in place
- pour solution B out of the cuvette, rinse the latter with a small amount of solution R (reference), pour this out, and fill the cuvette with solution R; place the cuvette in the colorimeter and read the absorbance, A_R
- pour solution R out of the cuvette, rinse the latter with a small amount of solution P (patient), pour this out, and fill the cuvette with solution P; place the cuvette in the colorimeter and read the absorbance, A_P .

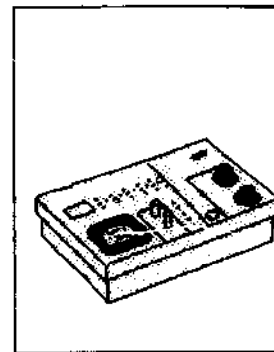
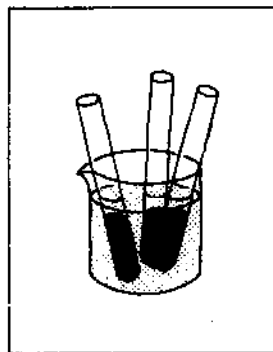

CALCULATION

Calculate the concentration of urea in the blood as follows:*

$$\text{Urea concentration} = (A_P/A_R) \times 16.7 \text{ mmol/l (millimoles per litre).}$$

Normal range

The normal blood urea concentration range is approximately 3-7 mmol/l.

High values

If a value greater than 25 mmol/l is obtained, repeat the entire test, using 0.1 ml of whole blood treated with EDTA dipotassium salt, or using serum or plasma, and 0.9 ml of distilled water in step 2. Perform the test and calculate the result exactly as before, but divide the result by 2 to obtain the true urea concentration.

* The calculation is given in SI units. In traditional units, blood urea concentrations are calculated by the formula $(A_P/A_R) \times 100 =$ urea concentration in milligrams per 100 millilitres (mg/100 ml). The normal range in traditional units is approximately 20-40 mg/100 ml. Tests should be repeated if values higher than 150 mg/100 ml are obtained.

E. BLOOD TRANSFUSION

37. Blood Groups: Theory

The purpose of blood transfusion is to enable a patient to receive blood with safety. This involves:

- finding out what group or type of blood he has
- carefully matching his blood against that of a suitable donor (cross-matching).

ABO SYSTEM: 4 GROUPS

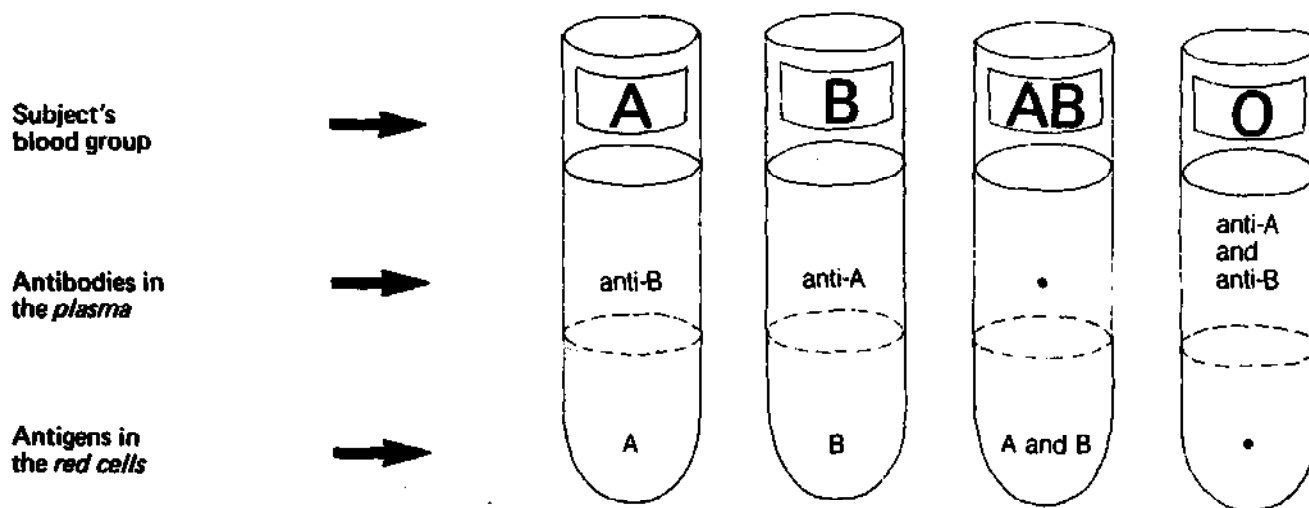

Antigen A exists as a strongly reacting antigen called A_1 , and a weakly reacting antigen called A_2 . This therefore further divides the groups A and AB into the following subgroups: A_1 , A_1B , A_2 and A_2B .

RHESUS SYSTEM: 2 MAIN GROUPS*

	Rh Positive	Rh Negative
The red cells contain	D antigen	No D antigen

Persons who are Rhesus negative do not normally have anti-D antibody in their plasma.

Rhesus antibodies may be produced in persons who receive Rhesus antigens they do not already have. This can be by blood transfusion or pregnancy.

Other blood group systems

ii, Lutheran, P, Lewis, MN, Kidd, Kell, Duffy, etc. These are less important for the prevention of haemolytic disease in the newborn and transfusion reactions.

*The Rhesus system is a complex blood group system consisting not only of antigen D, but also of other Rhesus antigens; for example antigens C, E, c, e.

BLOOD TRANSFUSION REACTIONS: ABO SYSTEM

Example: Group A donor
Group B receiver.

The red blood cells of the donor A are destroyed by anti-A antibodies in the blood of the receiver B. A serious reaction results.

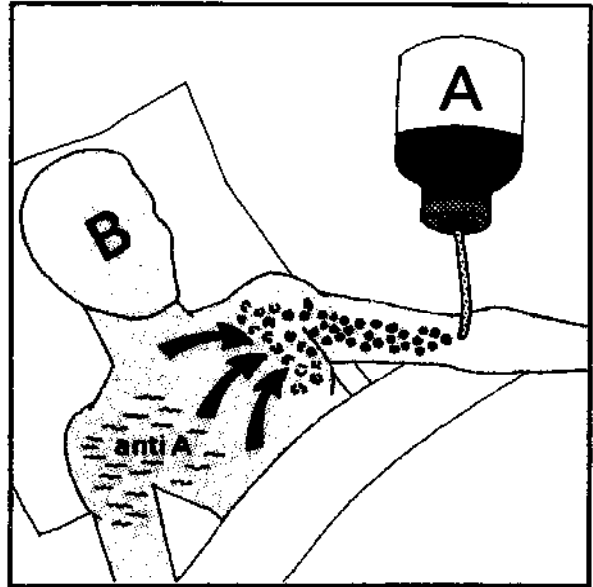

AVOIDANCE OF ACCIDENTS

1. Group the blood of each donor and receiver very carefully:
 - by testing the red cells (for antigens) with known anti-A, anti-B and anti-AB grouping sera (see page 437).
 - by testing the plasma or serum (for antibodies) with known test cells of A, B and O groups (see page 443).
 - by testing the red cells for the Rhesus factor with known anti-D test serum (see page 448) and when necessary with other specific antisera for the Rhesus system (in specialized laboratories).
2. Select the right blood group to be given to a patient. Whenever possible a patient should receive his own blood group.

In smaller hospitals, and especially in cases of emergency, a patient may need to receive blood of another group. The following rules apply:

 - *Group A patient* Should receive group A blood and, if not available, group O
 - *Group B patient* Should receive group B blood and, if not available, group O
 - *Group AB patient* Should receive group AB blood and, if not available, group A, group B, or group O (in that order of preference)
 - *Group O patient* Can only receive group O blood.
3. Carefully cross-match the serum of the patient against the red cells of the donor (compatibility test), to make sure that the blood is safe to give.
4. Work alongside an experienced person until you have sufficient practical and theoretical knowledge to work with safety and responsibility.

38. ABO Grouping with Antisera

Principle

The red cells are tested with 3 antisera:

- anti-A serum
- anti-B serum
- anti-AB serum.

The test can be performed:

- on a slide
- in a test-tube (particularly in doubtful cases).

A. TESTING BY THE SLIDE METHOD

Materials

- Dropping pipette (calibrated: 20 drops per ml)
- Pasteur pipettes with teats
- Beakers
- Centrifuges
- Grease pencil
- Sodium chloride solution (reagent No. 45).
- Tubes 50 x 11 mm for washing red cells
- Control red cells of Group A, Group B and Group O.

Antisera: anti-A, anti-B and anti-AB:

Store as instructed by the manufacturer, either at 4 °C or in the freezer compartment of the refrigerator.

If the antiserum appears cloudy, it is probably infected with bacteria and must not be used.

Keep opened bottles in the refrigerator at 4 °C.

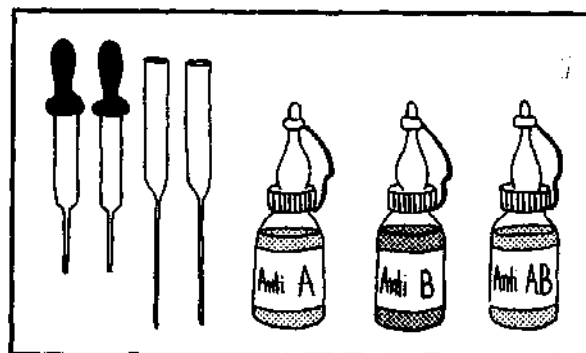

1. Collection of blood: separation

Use:

(a) *Venous blood collected into an anticoagulant (EDTA dipotassium salt):*

- centrifuge for 5 minutes at high speed
- draw off the plasma with a Pasteur pipette.
Keep it for grouping with known red cells (see page 443).

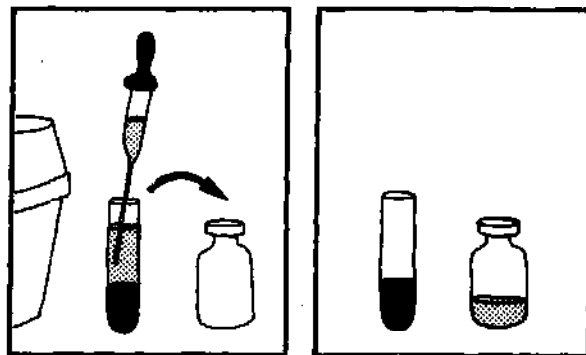

(b) *Coagulated venous blood: 5-10 ml in a glass tube:*

- allow the blood to clot (for rapid clotting place an applicator stick in the blood and leave for 15-20 minutes at 37 °C)
- centrifuge for 5 minutes at high speed.

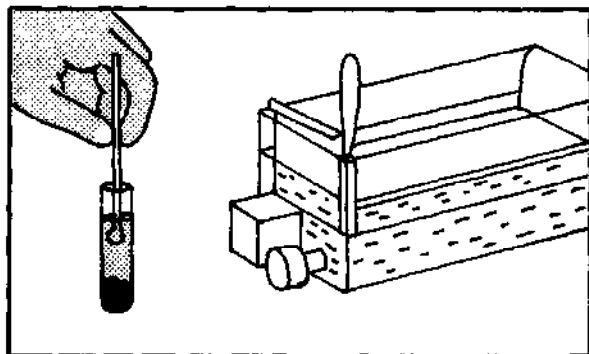

- draw off the serum with a Pasteur pipette. Keep it for grouping with known red cells.

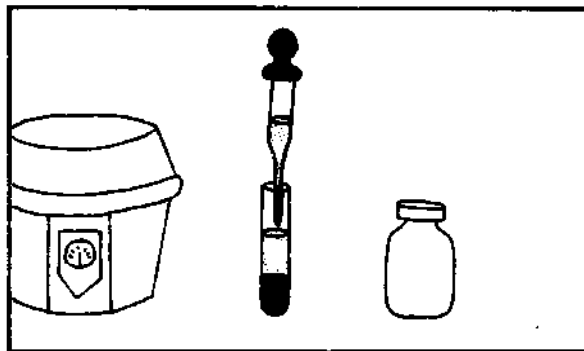

(c) Capillary blood:

- place 3 drops of 38 g/l trisodium citrate solution (reagent No. 54) in a test-tube
- collect 10 drops of blood immediately into the citrated tube: it will not coagulate. (This is a useful method for infants.)

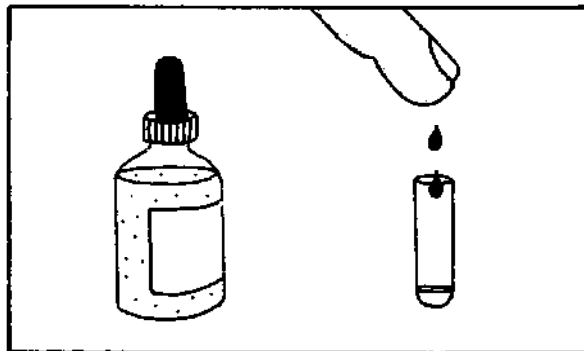

2. Washing the red blood cells

Mix:

- 5 drops of the red cell deposit
- 2 ml of sodium chloride solution.

Centrifuge at high speed.

Draw off the supernatant fluid and throw it away.

Again add:

- 2 ml of fresh sodium chloride solution.

Shake gently.

This gives a 10% suspension of red cells.

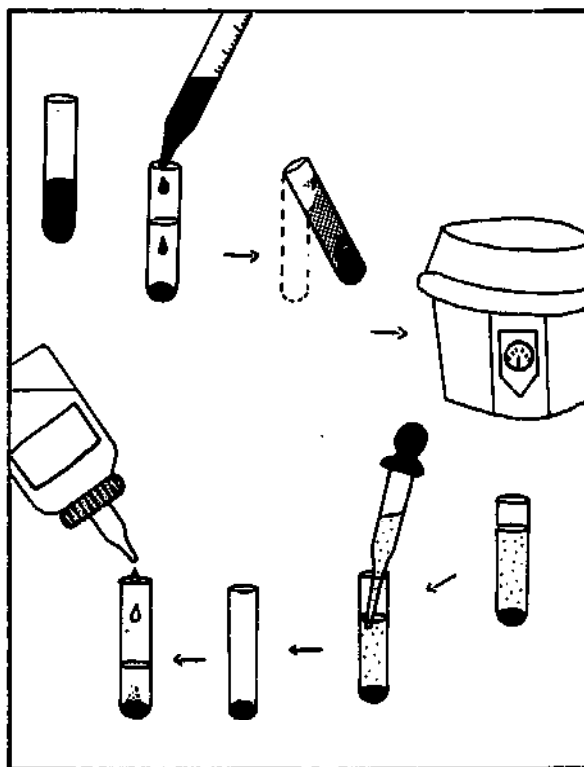

3. The test

Prepare and label 3 slides.

Place:

on slide No. 1

on slide No. 2

on slide No. 3

1 drop of anti-A serum

1 drop of anti-B serum

1 drop of anti-AB serum

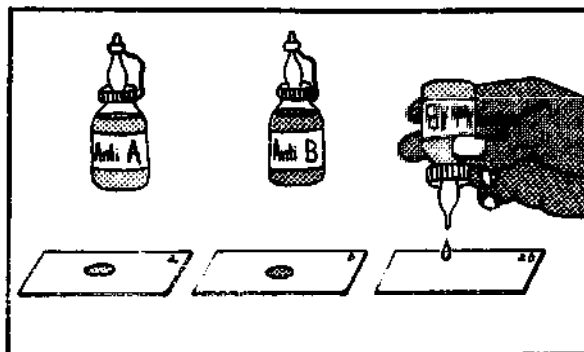

Add to each slide:

1 drop 1 drop 1 drop
of the 10% suspension of red cells to be tested.

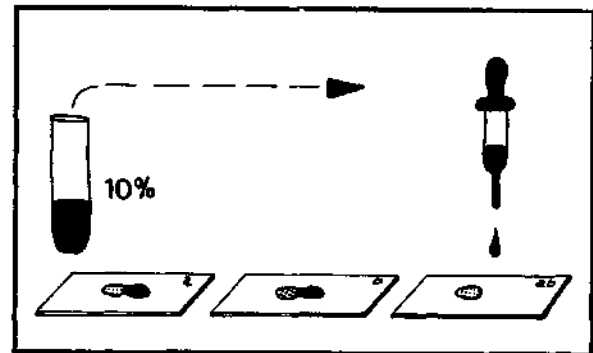

Mix the preparation on each slide:

- with a wooden applicator
- with the rounded end of a small test-tube
- or with a corner of a slide.

Use a fresh wooden applicator for each slide, or clean the test-tube between each slide. Do not transfer the mixture from one slide to the next.

Avoid coming into contact with the blood of the patient or the donor (danger of infectious hepatitis).

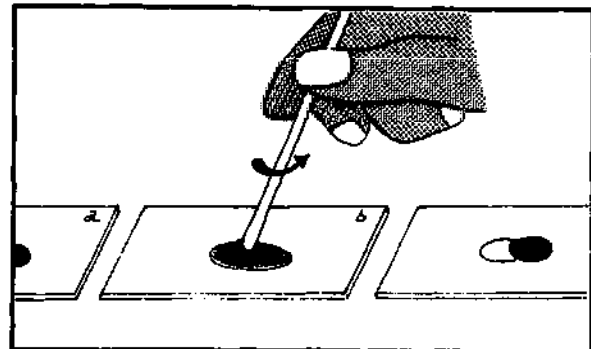

Tilt the slide backwards and forwards to complete the mixing. Read within 2 minutes, but take care that no evaporation has taken place as it may cause false agglutination.

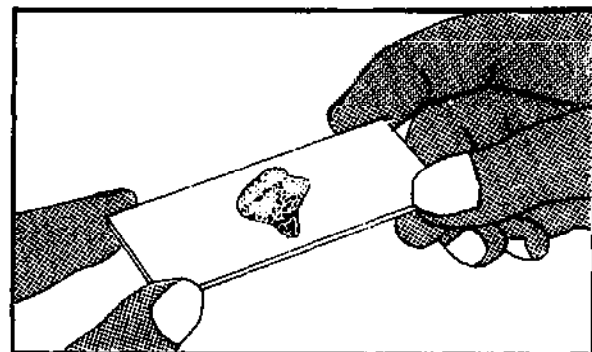

4. Reading of result

Positive agglutination (+)

Little clumps of red cells are seen floating separately in a clear liquid. Agglutination should occur in *under 2 minutes*.

Negative reaction (-)

No agglutination of the red cells.

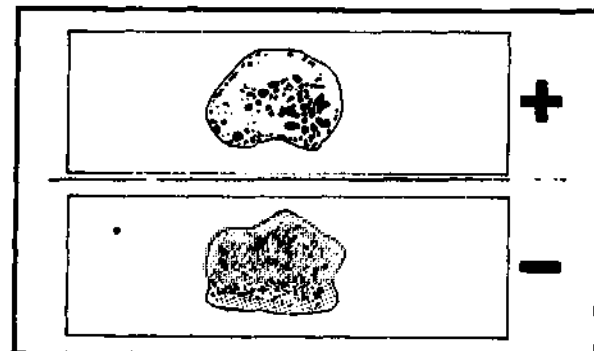

Results

Slide 1 anti-A	Slide 2 anti-B	Slide 3 anti-AB	Subject's group
+	-	+	Group A
-	+	+	Group B
+	+	+	Group AB
-	-	-	Group O

Important:

A blood group cannot be determined by this method alone (with antisera).

A second test must be carried out on the subject's plasma or serum using *known red cells* (see page 443).

B. TEST-TUBE METHOD

Grouping by the test-tube method takes longer and requires more equipment, but the results are more reliable. For that reason many blood transfusion centres use only the test-tube technique. When the slide method is used, all doubtful cases or results that are difficult to read must be checked by the test-tube method.

Materials

The same as for the slide method, plus:

- small test-tubes, with a rack
- a concave microscope mirror.

1. Washing the red cells (3 times)

Mix:

- 2 drops of the red cell deposit
- 4 ml of sodium chloride solution.

Centrifuge at high speed.

Draw off the supernatant fluid.

Add:

- 4 ml of fresh sodium chloride solution.

Shake gently to form a suspension.

The result is a 2% suspension of red cells.

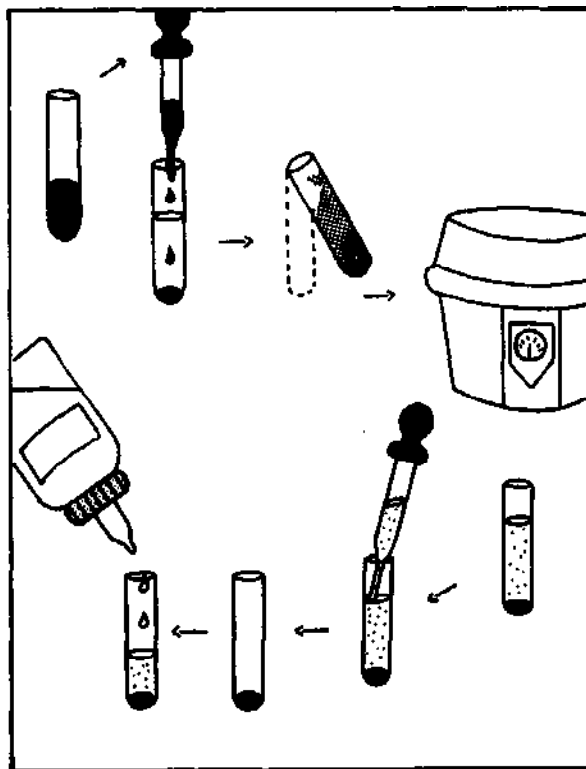

2. The test

Label 3 tubes with the serum number.

Place in the tubes:

No. 1	No. 2	No. 3
1 drop of anti-A serum	1 drop of anti-B serum	1 drop of anti-AB serum

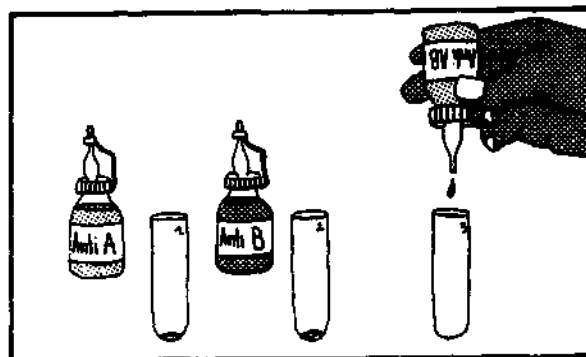

Add to each tube:

- 1 drop of the 2% suspension of red cells to be tested.

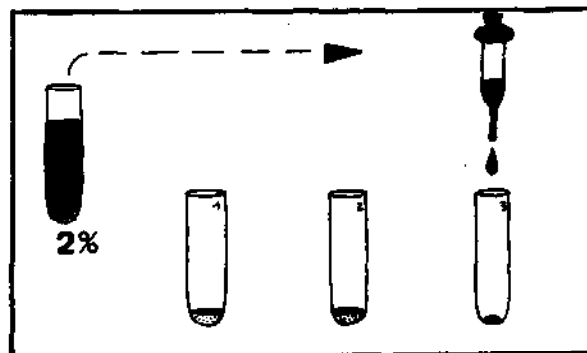

3. Incubation without centrifuging

Let the tubes stand for *1 hour* at room temperature.

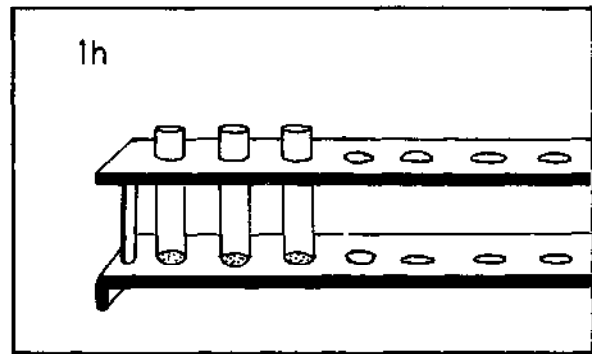

4. Technique using centrifuge (rapid method)

Let the tubes stand for *15 minutes* at room temperature.

Then centrifuge for 1 minute at low speed.

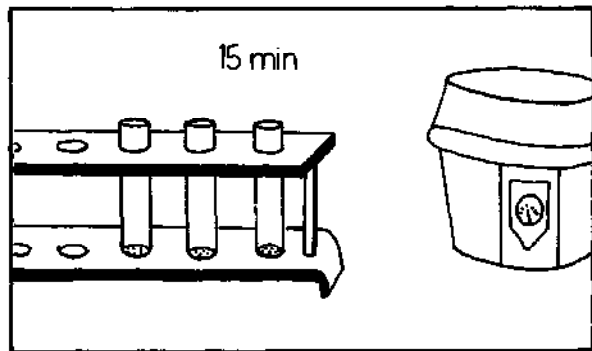

5. Reading the reaction

Shaking the bottom of the tube gently, examine the deposit of red cells. The concave mirror can be used.

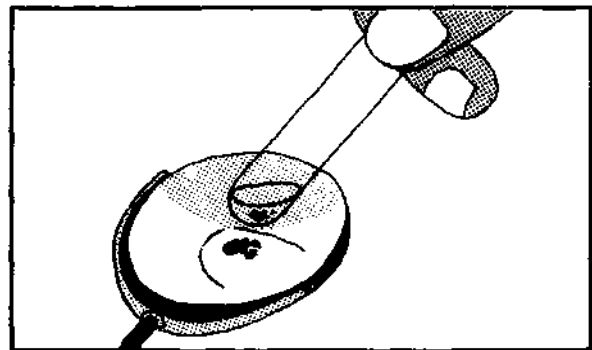

6. Positive agglutination (+)

The red cells form one or more clumps with a clear supernatant fluid.

Negative reaction (-)

The red cells resuspend easily, without any visible clumping.

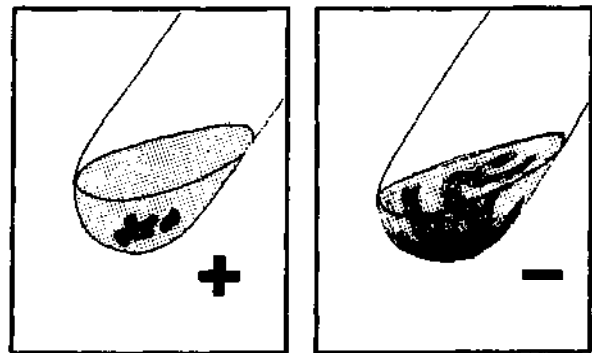

CONTROLS

The antisera used should be controlled by testing:

- anti-A and anti-B antisera against known group A, group B and group O red cells, using the test-tube method.

DOUBTFUL REACTIONS – ERRORS

1. Reading results under the microscope

In cases of weak agglutination, place a drop of the red cell serum on a slide and examine it under the microscope (x 10 objective).

- (a) *Clear agglutination:*
large clumps of red cells on a clear background
- (b) *Weak agglutination:*
smaller clumps of red cells with some free cells in the field
- (c) *No agglutination:*
all the red cells are free.



a

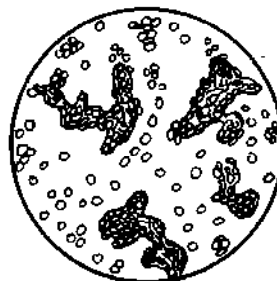

b

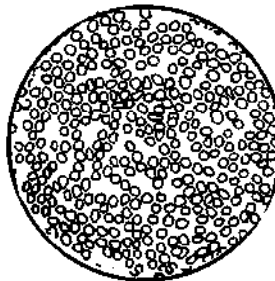

c

2. Rouleau formation

The red cells are not agglutinated but are piled up on each other like a stack of plates or coins. This gives the appearance of a false agglutination. It is difficult to distinguish with the naked eye.

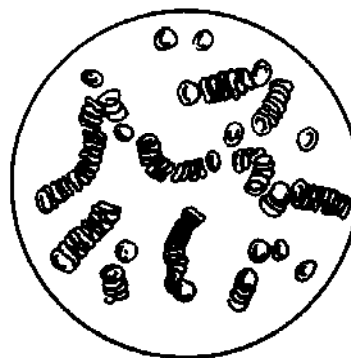

To disperse rouleau formation, add 2 drops of sodium chloride solution to the drop of the red-cell-serum mixture on the slide. Examine under the microscope. In false agglutination the rouleau disperses but in true agglutination the clumps remain.

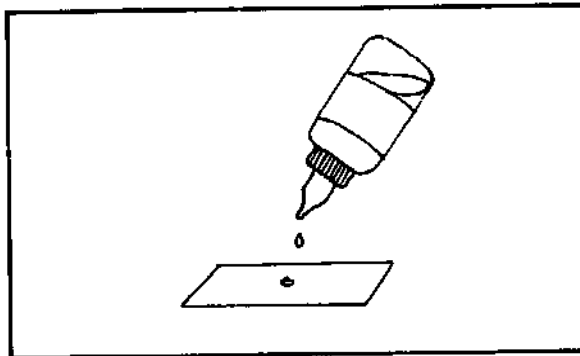

Storage of antisera

1. Before use: as directed by the manufacturer.
2. After opening the bottle: in the refrigerator at + 4 °C.
3. Always keep the bottles tightly closed, and leave them as little as possible at room temperature.
4. Contaminated serum looks cloudy and whitish. Examine a drop under the microscope with the x 40 objective. If it contains bacteria, throw the antiserum away.

39. ABO Grouping with Standard Red Cells

Principle

The serum or plasma to be grouped is tested against 3 suspensions of known red cells:

- group A₁ red cells
- group B red cells
- group O red cells.

The test can be carried out:

- on a slide
- in a test-tube (particularly in doubtful cases).

A. TESTING BY SLIDE OR TILE METHOD

Materials

The same as for blood grouping using antisera (see page 437). Separate the subject's serum or plasma from the red cells as described on page 437.

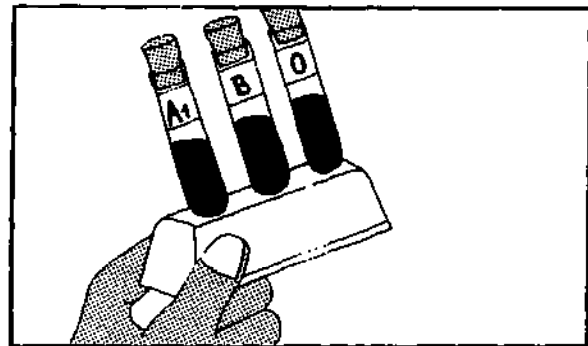

Reagents - reference red blood cells

Select fresh specimens of known A₁, B and O blood.

Group A₁ blood

Test several group A bloods with anti-A₁ serum as indicated on page 437 (slide method) or page 440 (test-tube method).

Slide method: agglutination occurs within 30 seconds if the blood tested is group A₁.

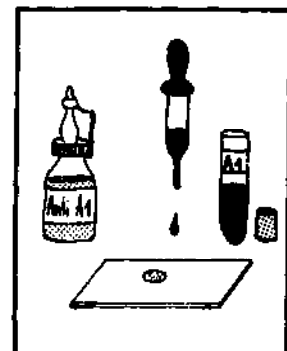
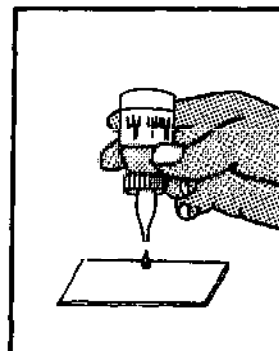

Washing the reference cells

Wash the 3 types of reference cells in 3 test-tubes. In each tube mix:

- 1 ml of whole blood (with anticoagulant) with 4 ml of sodium chloride solution
- or
- 0.5 ml of packed red cells with 4.5 ml of sodium chloride solution.

Centrifuge for 5 minutes at high speed. Discard the supernatant fluid. Replace with the equivalent volume of sodium chloride solution. Mix. Centrifuge. Discard the supernatant fluid.

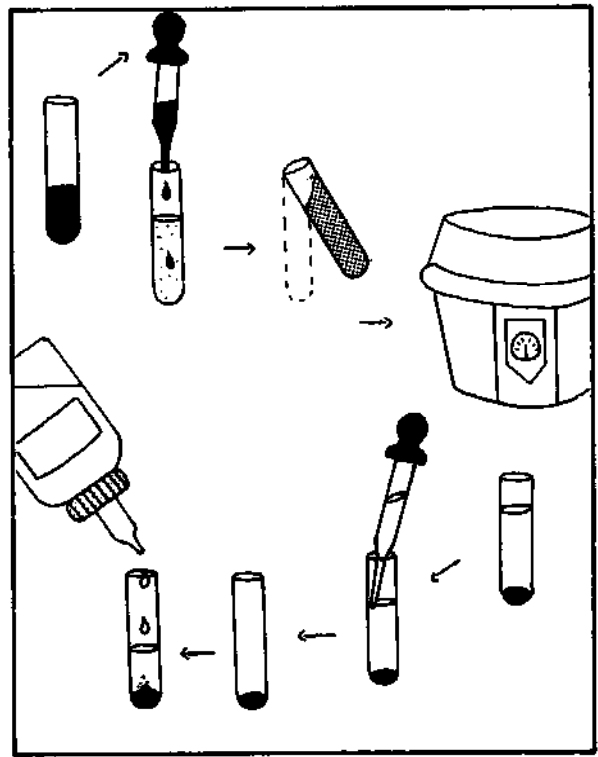

Preservative for washed red cells

After washing, keep the deposit of red cells in suspension in a preservative:

- either ACD solution
 - or sodium chloride solution
- always in the same proportions:
- 4.5 ml of preservative for
 - 0.5 ml washed (packed) red cells.

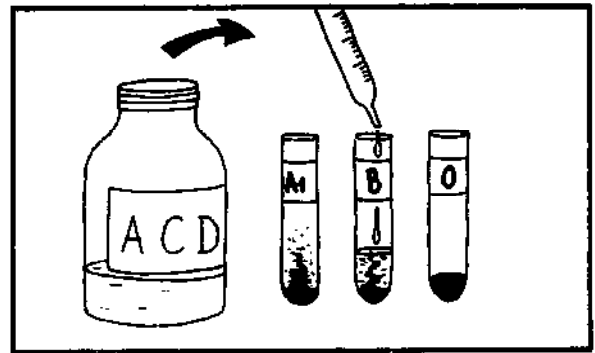

This produces a 10% suspension of reference red cells, which can be kept in the refrigerator at 4 °C in labelled drop bottles (mark the bottles with the date of preparation).

Preservation time:

- in sodium chloride solution - 3 days
- in ACD - 1 week

ACD solution (acid-citrate-dextrose): may be prepared in the laboratory (reagent No. 1) or obtained from blood transfusion bottles which must be discarded if any of the ACD solution is removed.

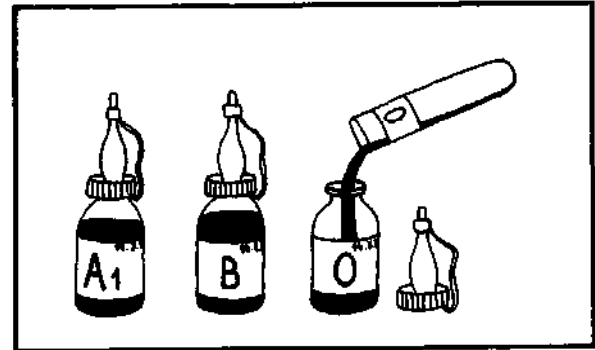

The test

Prepare 3 slides labelled A₁, B and O.

Place on

slide A ₁	slide B	slide O
1 drop of 10% suspension of A ₁ cells	1 drop of 10% suspension of B cells	1 drop of 10% suspension of O cells

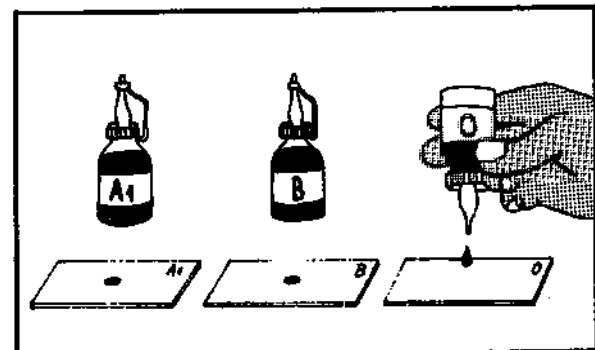

Discard the reference red cells if the supernatant preservative shows that haemolysis has occurred (it turns pink).

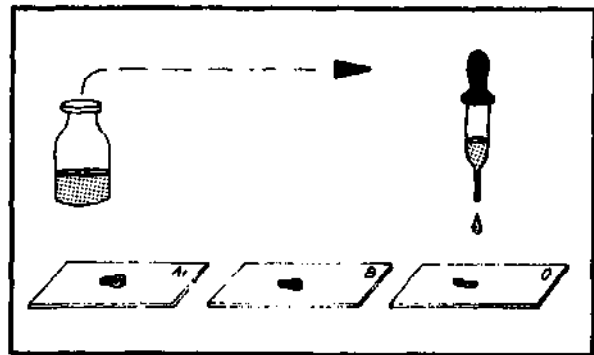

Add to each slide:
2 drops of the serum or plasma to be tested.

Mix the preparation on each slide, using a wooden applicator or the rounded end of a test-tube. Do not transfer any of the mixture from one slide to another. Tilt the slide backwards and forwards to complete the mixing.

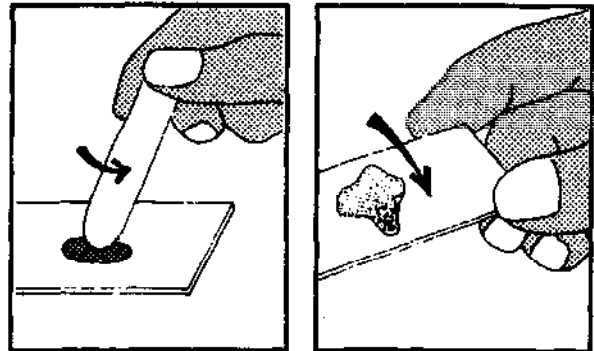

Reading the result

The size of the agglutinates varies from one person to another (depending on the concentration of anti-A or anti-B antibodies in the serum).

The agglutinates are usually smaller than those observed when testing red cells with antisera, but their appearance is similar.

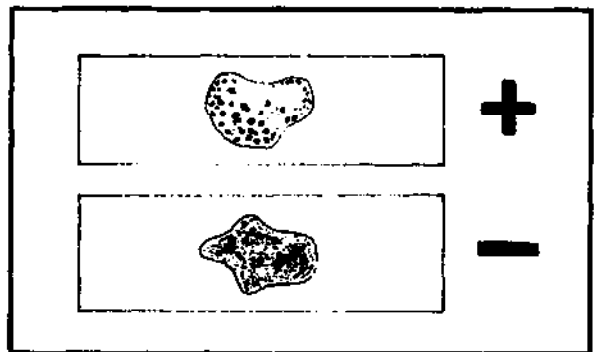

Results

A ₁ cells	B cells	O cells	Subject's group
-	+	-	group A
+	-	-	group B
-	-	-	group AB
+	+	-	group O

Compare the findings with the results of the test using antisera. You should have reached the same results by both techniques. If the results are not the same by both tests repeat the tests.

Doubtful reactions

Examine under the microscope. Rouleau formation may be detected as indicated on page 442.



B. TEST-TUBE METHOD

Preparation of reference red cells (2%)

Prepare 2% suspensions of standard A₁, B and O red cells from the 10% suspensions prepared for the test using the slide method (see page 444).

Mix:

- 2 ml of sodium chloride solution
- 10 drops of the 10% suspension.

This 2% suspension must be used on the same day.

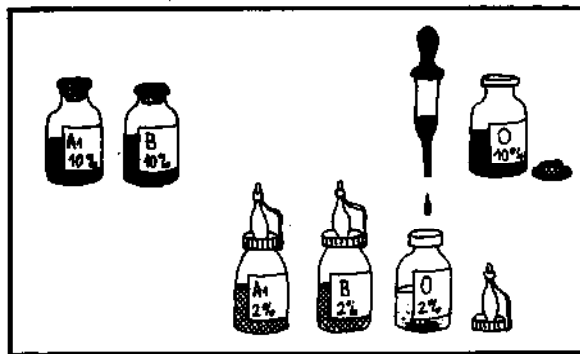

The test

Label 3 test-tubes A₁, B and O.

Place in:	tube A ₁	tube B	tube O
	2 drops	2 drops	2 drops

of the serum or plasma to be tested.

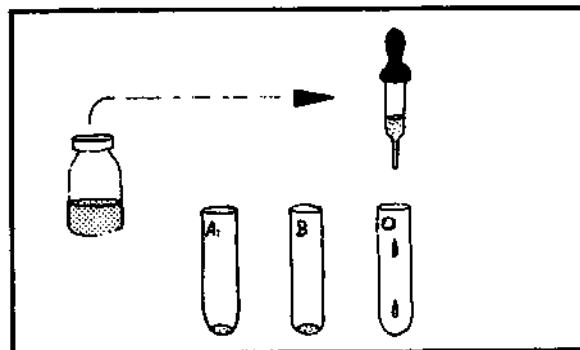

Add to:	tube A ₁	tube B	tube O
	1 drop of 2% suspension of A ₁ cells	1 drop of 2% suspension of B cells	1 drop of 2% suspension of O cells

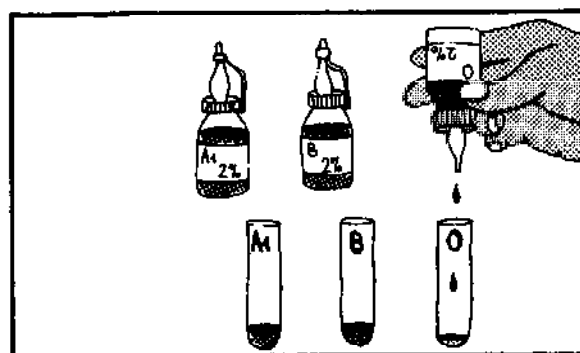

Incubation without centrifuging

Let the tubes stand for *1 hour* at room temperature.

Technique using centrifuge (rapid method)

Let the tubes stand for *15 minutes* at room temperature.

Then centrifuge for *2 minutes* at low speed.

Reading the reaction

Shaking the tube gently, examine for agglutination:

- Positive agglutination: the red cells form small clumps.
- Negative agglutination: the red cells resuspend easily, without visible clumping.

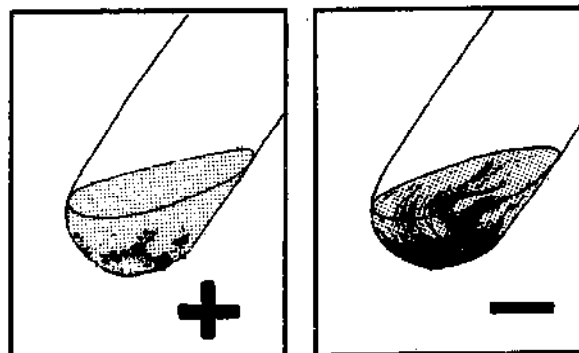

Combined results

	ANTISERA			REFERENCE RED CELLS		
	Anti-A	Anti-B	Anti-AB	A ₁	B	O
Group A	+	-	+	-	+	-
Group B	-	+	+	+	-	-
Group AB	+	+	+	-	-	-
Group O	-	-	-	+	+	-

IMPORTANCE OF TESTING WITH GROUP O CELLS

This provides a check that the subject's serum does not contain abnormal antibodies that agglutinate all types of red cells.

If there is any suspicion of this, carry out an additional test for autoantibodies. In a tube pipette put:

- 2 drops of the patient's serum
- 1 drop of the patient's own red cells in 2% suspension.

Incubate for 1 hour at room temperature. Examine for agglutination.

A positive reaction indicates the presence of autoantibodies. The blood grouping results using the patient's washed red cells will be a better guide as to the patient's true blood group.

The patient's serum and cells should be sent to a reference laboratory for investigation if you suspect autoantibodies or if the test with antisera and reference red cells does not give the results shown in the table above.

REASON FOR USING GROUP A₁ RED CELLS

Of any 10 persons belonging to group A, about

- 8 are group A₁
- 2 are group A₂.

(Other A subgroups are rare.)

Group A₂ red cells are weakly agglutinated by the anti-A antibodies of group B and group O subjects. Thus, if A₂ red cells were to be used, there would be a risk of doubtful agglutination and the results would be difficult to interpret.

DISTRIBUTION OF BLOOD GROUPS THROUGHOUT THE WORLD (estimate)

	White races	Yellow races	Black races
Group O	43%	36%	48%
Group A	44%	28%	27%
Group B	9%	23%	21%
Group AB	4%	13%	4%

40. Rhesus Grouping

Principle

The red cells are tested for antigen D using anti-D serum.

Persons with antigen D are called Rhesus (Rh) positive.

Persons with no antigen D are called Rhesus (Rh) negative.

The test is carried out at 37 °C–40 °C:

- on a slide
- or in a test-tube.

A. SLIDE METHOD

Materials

- Slides
- Capillary pipette
- Electrically warmed box ("Diamond" box)
- Anti-D serum*
- Control specimens of Rh positive and Rh negative blood (if available).

Important:

When using commercial anti-D serum, the method for testing given by the manufacturer must be followed. It may be different from what is described below.

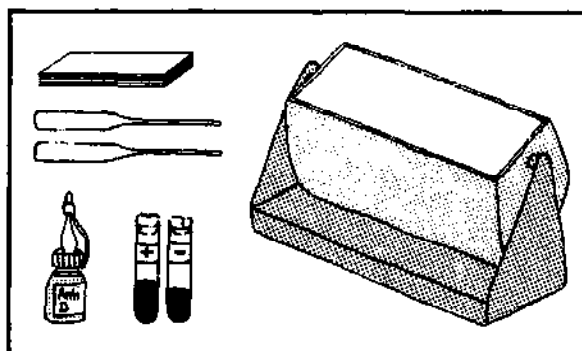

Preparation of blood for grouping

Prepare a 50% suspension of red cells in their own serum or plasma.

(a) Blood with anticoagulant (EDTA dipotassium salt)

- Centrifuge 2–5 ml of blood for 5 minutes at high speed
- Check that the volume of the red cell deposit is equal to that of the supernatant plasma
- If the volume of plasma is greater (anaemic blood), remove the excess plasma with a pipette until the volume of plasma and that of red cells are equal
- Then mix the plasma and red cells gently.

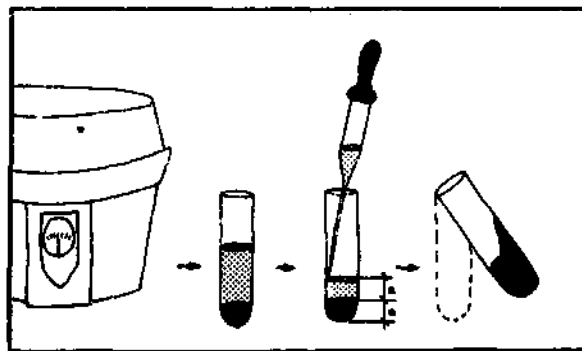

(b) Coagulated blood

- Break up the clot with a capillary pipette to free the red cells
- Transfer a portion of the freed red cells with serum to a centrifuge tube
- Centrifuge for 5 minutes at high speed
- Pipette off the excess serum until the volume of serum and that of red cells are equal
- Mix the serum and red cells gently
- Spread a drop of the cell suspension on a clean slide and examine microscopically (x 10 objective). If it contains clumps of red cells discard the suspension and prepare a fresh one, taking care to use free red cells only.

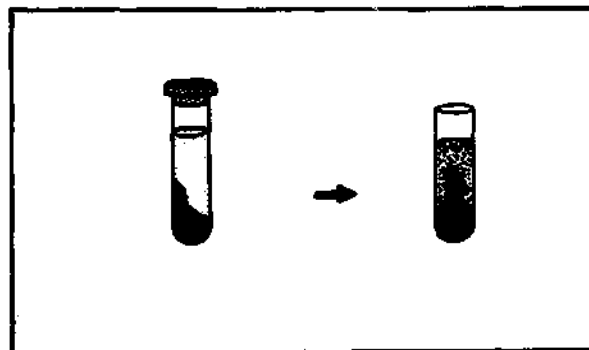

* Anti-D serum can be of the complete type, which will agglutinate red cells in saline, or of the incomplete type, which will agglutinate red cells in albumin. Most anti-D sera are of the incomplete type.

Method

1. Switch on the heater, the surface temperature of which should be 40°C

Place the numbered slides to be used for the test on it.

Leave to warm for 5 minutes.

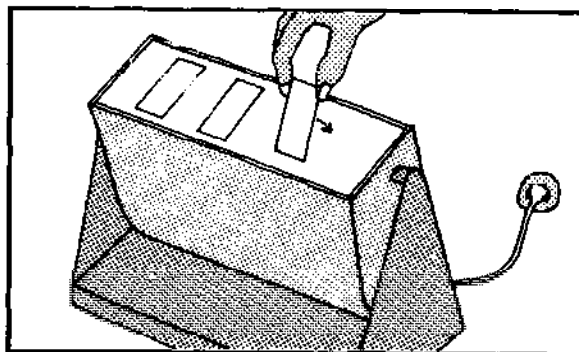

If no warm box is available, the slides can be heated over a spirit lamp before the test. Check their temperature against the back of your hand: the heat should be bearable.

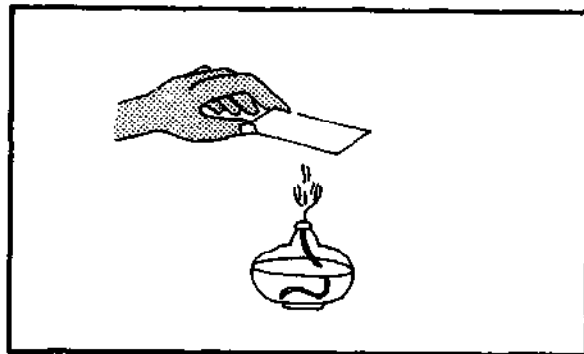

2. Place on the test slide:
 - 1 drop of anti-D serum
 - 1 drop of the mixture of red cells and serum to be tested.

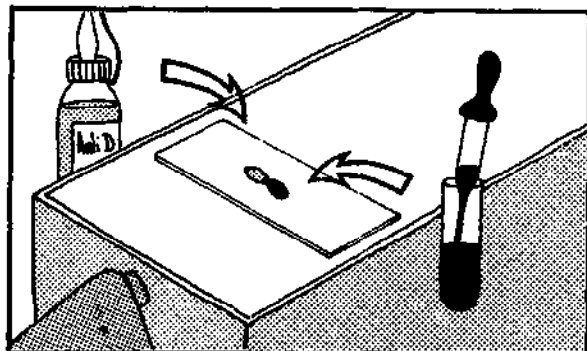

3. Mix with an applicator stick or the end of a small test-tube.

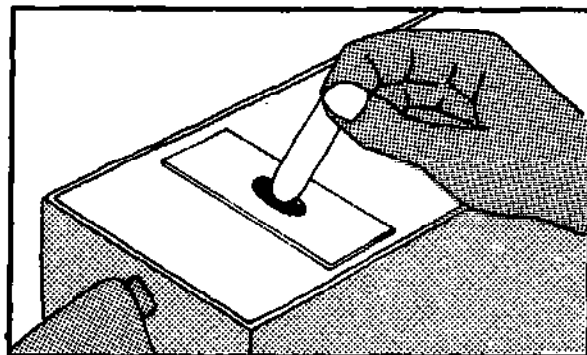

4. Continue mixing by tilting the warm box backwards and forwards.

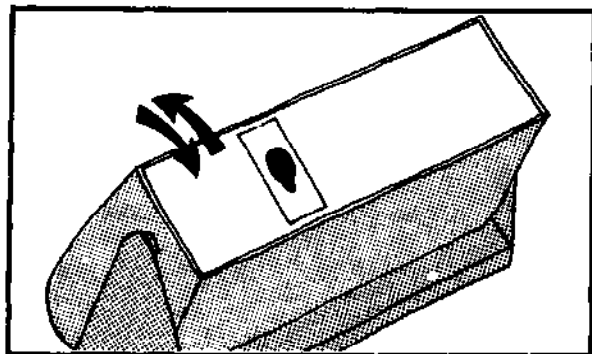

Results

Agglutination = Rh positive

A large number of agglutinates of red cells are clearly seen, both in the centre and around the edges of the blob. Agglutination should occur within 3 minutes.

No agglutination = Rh negative

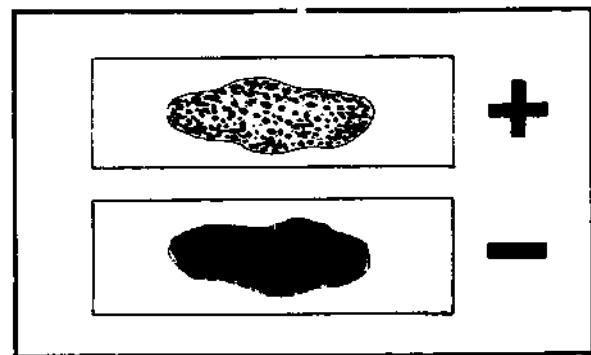

Controls

It is recommended that for each daily series of tests the following should be set up:

- a positive control using Rh positive blood
- a negative control using Rh negative blood (if available).

A check on blood found to be Rh positive and suspected of autoagglutination can be made by testing the patient's red cells against his own serum.

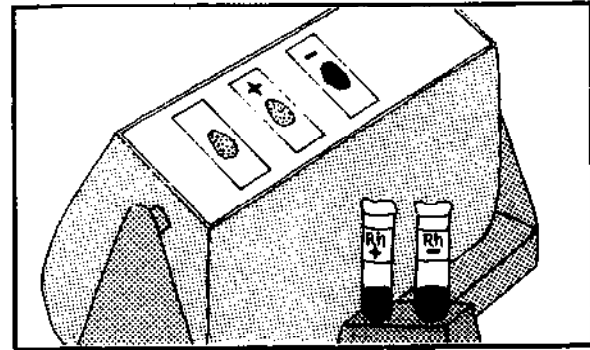

Difficulties in reading results

1. *Streaky reaction*

After 2 minutes streaks appear in the smear, especially around the edges.

They are caused by rouleau formation, which develops because of evaporation (excessive heat), because not enough anticoagulant has been used, or because the plasma has a high protein content.

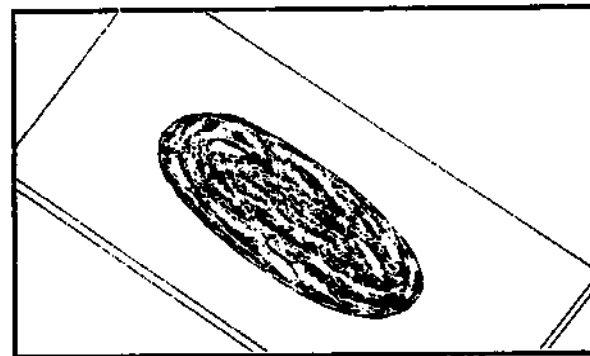

Add a small drop of sodium chloride solution and mix. If the blood is Rh negative the rouleaux usually disperse.

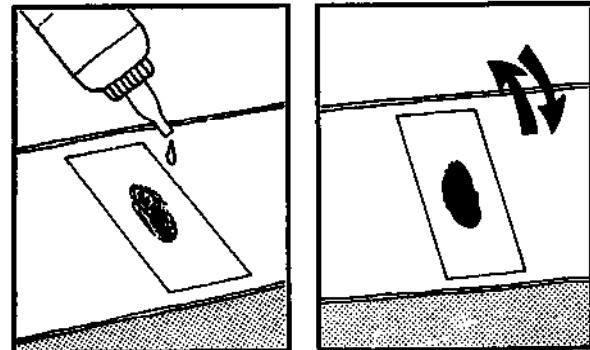

2. *Weak agglutination*

First check the anti-D serum with known Rh positive blood to ensure that it produces strong agglutination.

Weak reactions may also occur because:

- the blood belongs to a Rh subgroup (Du)
- the blood contains unusual antibodies.

Check doubtful results by the test-tube method (see B opposite). In specialized laboratories additional tests are made (Coombs test, enzyme techniques, etc.)

B. TEST-TUBE METHOD

1. Prepare a 2% suspension of red cells in their own serum or plasma.

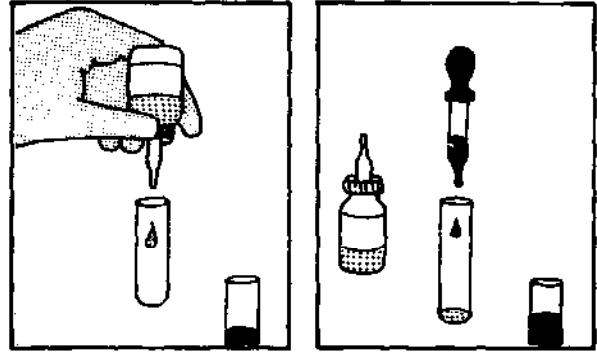

2. Place in a small tube:
 - 1 drop of anti-D serum
 - 1 drop of the 2% suspension of red cells.

Incubation without centrifuging

Recommended method.

Leave for 1 hour at 37 °C (in a water bath or incubator).

Technique using centrifuge (rapid method)

Leave for 30 minutes at 37 °C.

Then centrifuge for 1 minute at low speed.

Reading the result with the naked eye

Examine the liquid in the bottom of the test-tube, turning the tube gently in an almost horizontal position. If possible, examine over an illuminated surface (the plate of the warm box or a lamp).

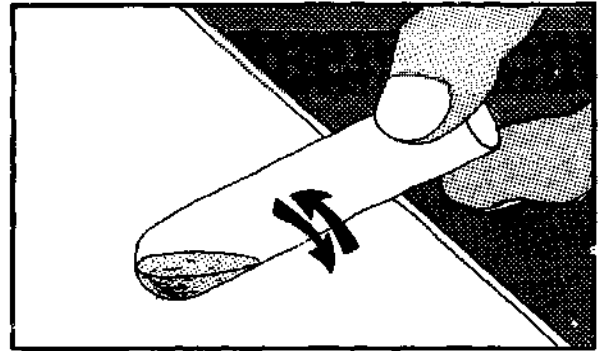

Rh positive reaction

Small agglutinates of red cells are seen in a clear liquid.

Rh negative reaction

The red cells suspend, with no visible agglutinates.

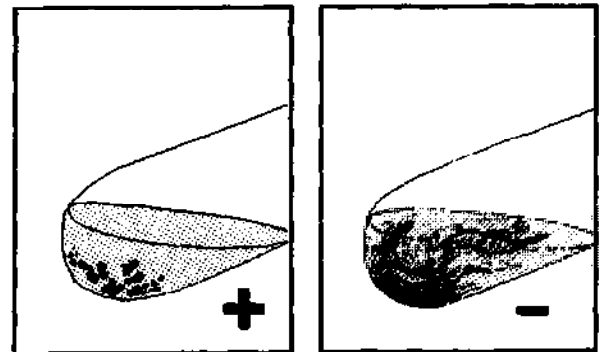

Reading under the microscope

If in doubt, warm a slide, take a drop of the red cell deposit with a Pasteur pipette and smear it on the slide. Examine under the microscope (x 10 objective).



C. ERRORS IN Rh GROUPING

1. *Anti-D serum contaminated by bacteria*

Contaminated serum looks cloudy and whitish. It should be discarded.

2. *Errors in reading labels*

3. *Patient's blood haemolysed or citrated*

Haemolysed blood (the plasma turns pink) kept in the refrigerator for more than 2 days is difficult to group. Blood collected in sodium citrate solution can be grouped only by the test-tube method.

4. *Tubes shaken too much*

Centrifuge for the time and at the speed indicated. Remove the tubes gently from the centrifuge. Turn them slowly in a horizontal position. False negative results are often obtained because of too much shaking.

5. *Correct use of anti-D sera*

Some anti-D sera are intended for use either with the test-tube method only or with the slide method only. Other anti-D sera must be used in sodium chloride solution: in that case, prepare a 2% suspension of red cells in the solution and use the test-tube method. Always read the instructions for use on the labels of antisera bottles.

D. IMPORTANCE OF RHESUS GROUPING

1. *Multiple transfusions*

Example: a patient is *O Rh negative*

- 1st transfusion: he is given *O Rh positive* blood and develops anti-D antibodies.
- 2nd transfusion: if he is again given *O Rh positive* blood the anti-D antibodies he has developed may agglutinate the Rh positive (D) red cells from the donor.

2. *Haemolytic disease of the newborn*

Example: a mother is *Rh negative*

- 1st pregnancy: she has a child that is *Rh positive*. During delivery some of the fetal red cells (having antigen D) may enter the mother's circulation, causing her to produce anti-D antibodies.
- 2nd pregnancy: she has a second *Rh positive* child. The anti-D antibodies of the mother may haemolyse the red cells of the fetus and the child may be born with haemolytic disease.

It is therefore recommended that Rh grouping should be carried out on all pregnant women.

DISTRIBUTION OF ANTIGEN D

Peoples of South-East Asia and the Pacific	98 – 100% Rhesus positive
Peoples of Ecuador and Chile	91 – 97% Rhesus positive
Peoples of Brazil and Argentina	82 – 94% Rhesus positive
Peoples of Africa (Bantu, Ethiopians)	94 – 97% Rhesus positive
Peoples of Africa (Negroes)	82 – 94% Rhesus positive
Peoples of West European and North American countries	80 – 85% Rhesus positive

41. Cross-matching (Compatibility Testing)

Principle

Cross-matching (compatibility testing) is carried out to prevent blood transfusion reactions. The object is to check whether the serum of the patient contains any antibodies that could agglutinate the red cells of the donor.

MATERIALS

- Patient's serum (see page 437)
- Patient's red cells
- Donor's red cells from the pilot bottle
- 8.5 g/l sodium chloride solution (reagent No. 45)
- 20% bovine albumin (reagent No. 8)
- 37 °C water bath or incubator
- Centrifuge
- Pipettes
- Test-tubes – small and medium.

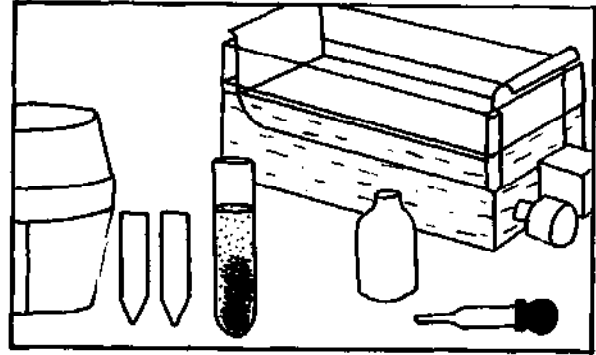

STANDARD CROSS-MATCHING

Select the right donor blood to be cross-matched according to the blood group of the patient (see page 436).

1. Prepare a 2-5% suspension of the donor's washed red cells:
 - label a medium-sized test-tube with the donor's group and number
 - fill the tube with about 4 ml sodium chloride solution
 - add 3 drops of the donor's red cells
 - mix
 - wash the cells three times as described on page 440.

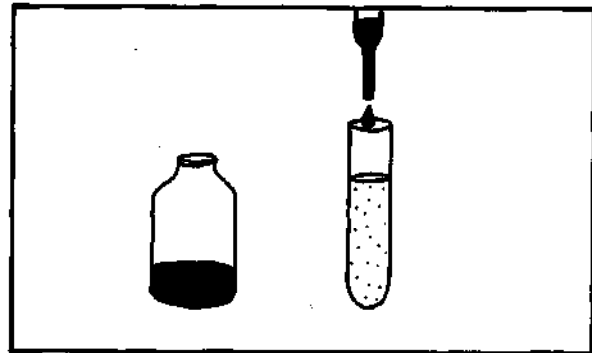

2. Take 4 small test-tubes and label them 1 to 4:
 - tube 1 – the sodium chloride solution cross-match
 - tube 2 – the albumin cross-match
 - tube 3 – the sodium chloride solution auto-control
 - tube 4 – the albumin auto-control.

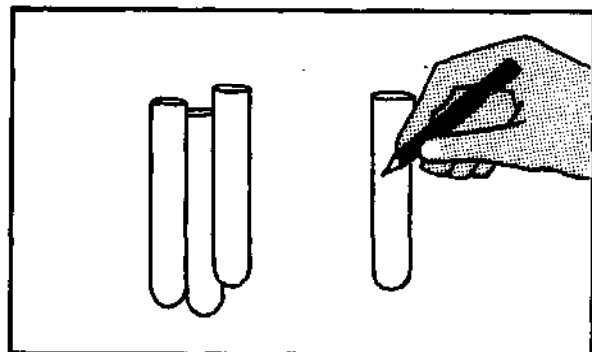

3. Pipette into the tubes as follows:

tube 1 and tube 2:

- 2 drops of the patient's serum
- 2 drops of the 2-5% suspension of the donor's washed red cells

tube 3 and tube 4:

- 2 drops of the patient's serum
- 2 drops of the 2-5% suspension of the patient's washed red cells.

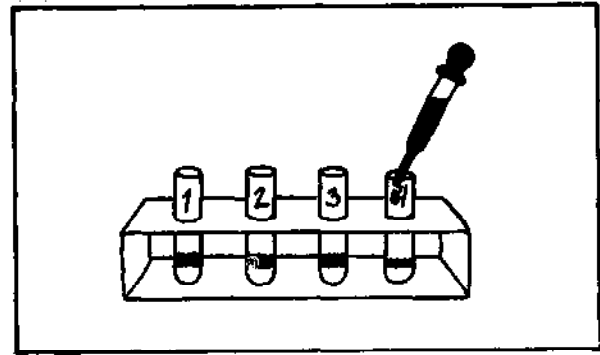

4. Mix the cells and serum by gently tapping the bottom of each tube.

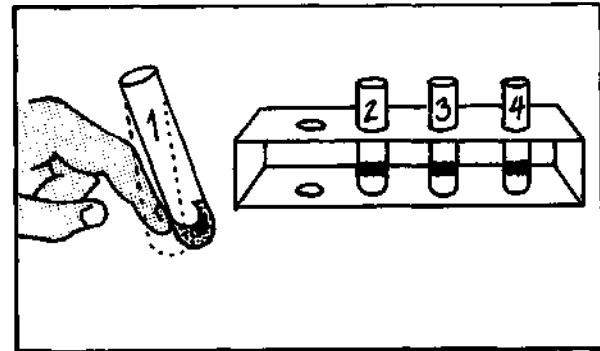

5. Place the tubes in a 37 °C water bath or incubator. Leave for 1½ hours.

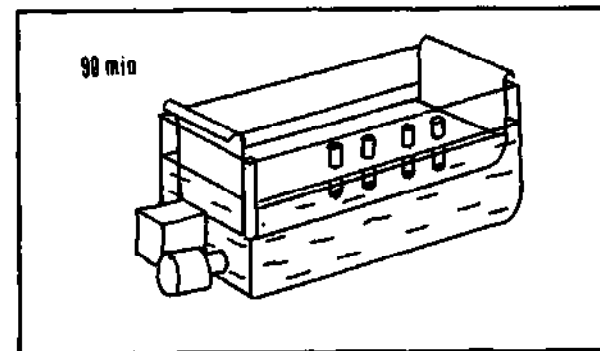

6. Add 2 drops of 20% bovine albumin:
- to tube 2
- to tube 4.

Do not mix.

Incubate for a further 20-30 minutes.

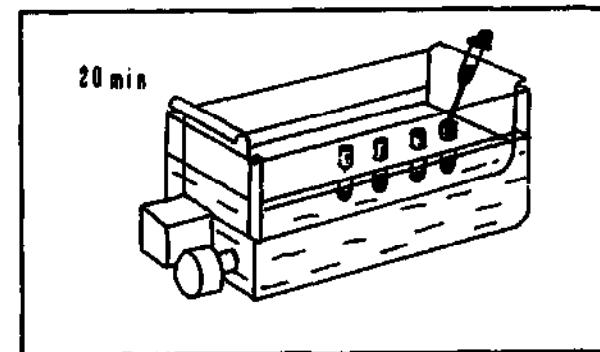

7. Examine the red cell deposit from each tube under the microscope:
- use a Pasteur pipette (unbroken tip)
- carefully draw up the red cell deposit, taking care not to disturb it too much
- spread it across a clean slide
- examine under the microscope for agglutination using the x 10 objective.

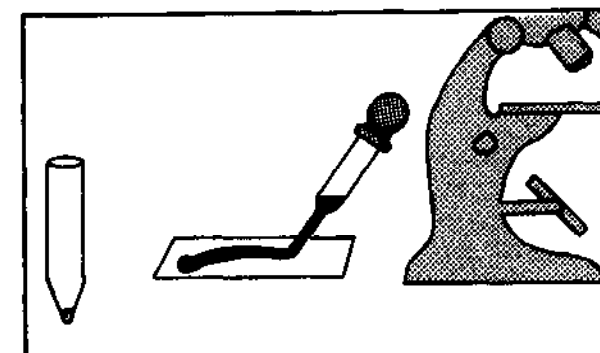

RESULTS

No agglutination

The blood is compatible and can safely be given to the patient.

Heavy agglutination or haemolysis in tube 1, with less agglutination in tube 2

The blood is incompatible and must not be given to the patient. Probably the wrong ABO blood group is being used. Check the blood group of the patient and the donor again.

Agglutination in tube 1 only

The blood is incompatible and must not be given. The patient has what are called complete antibodies. It may be possible to find compatible blood using another donor, but whenever possible obtain advice from a specialist centre.

Agglutination in tube 2 only

The blood is incompatible and must not be given. The patient probably has immune antibodies, for example anti-D if the patient is Rhesus negative and Rhesus positive blood is being used.

Agglutination in all 4 tubes

The patient's serum contains autoantibodies. Advice from a specialist centre should be obtained and, if possible, the cross-matching should be carried out by the centre.

Rouleaux

The appearance of heavy rouleaux may be difficult to distinguish from true agglutination. The rouleaux will often be less in the albumin tubes. Adding sodium chloride solution to the cell suspension on the slide may disperse the rouleaux sufficiently to see the difference (see page 442).

EMERGENCY CROSS-MATCHING

In an emergency it may not be possible to incubate the tubes for the full length of time. If less than 45 minutes can be allowed, examine tube 1:

- centrifuge tube 1 for 1 minute at low speed.
- examine the red cell deposit microscopically.

If there is no agglutination, issue the blood for the patient, writing clearly on the label "Blood compatible by emergency cross-match". Always complete the test-tube cross-matching method.

42. Detection of Dangerous Group O Donors

Important

In an emergency, group O blood sometimes has to be given to a patient belonging to group A, B or AB. In some group O subjects the plasma contains increased amounts of anti-A and, less rarely, anti-B antibodies, which may react with the A, B or AB red cells of the receiving patient. These group O subjects must therefore be detected to ensure that they are not used as "universal donors".

Blood containing increased amounts of anti-A or anti-B antibodies must be used only for group O patients.

Principle

Fresh serum from the donor is incubated with a very small quantity of A₁ and B red cells. If there is a high titre of anti-A and anti-B antibodies haemolysis will occur and the serum will turn pink.

METHOD

Prepare:

- a 5% suspension of A₁ cells in sodium chloride solution
- a 5% suspension of B cells in sodium chloride solution.

(Follow the instructions given for the preparation of reference red cells, page 443).

Wash the red cells twice.

1. Separate the donor's serum (from the tube without anticoagulant).

The test must be carried out *within 6 hours* of taking the specimen.*

* If this time-limit is exceeded, an equal volume of fresh group AB serum may be added.

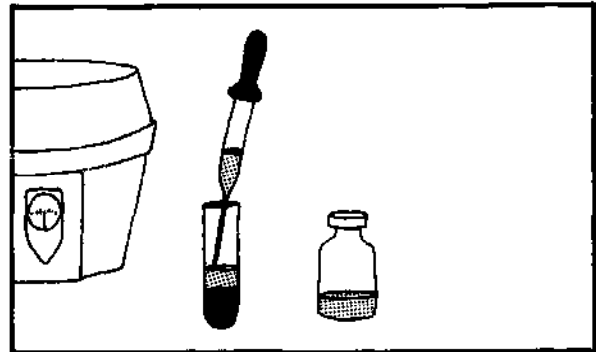

2. Place in 2 tubes:

	Tube A ₁	Tube B
fresh donor serum	9 drops	9 drops
5% suspension of A ₁ cells	1 drop	-
5% suspension of B cells	-	1 drop

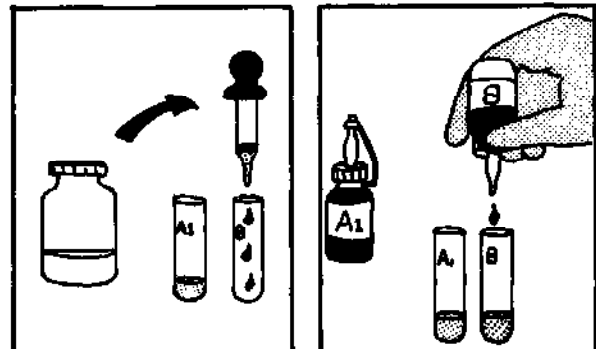

3. Leave the tubes:
— for 2 hours at 37 °C (in an incubator or water bath).

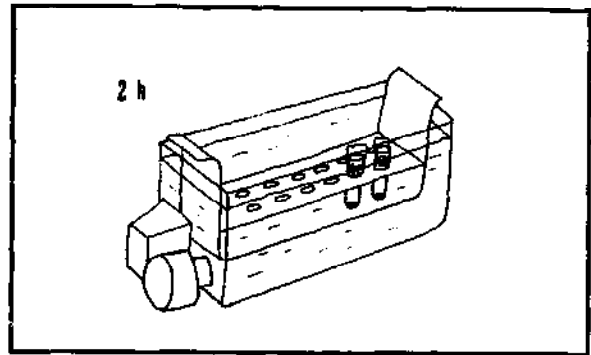

4. Tap the tubes gently to resuspend the cells.
Centrifuge for 1 minute at low speed.

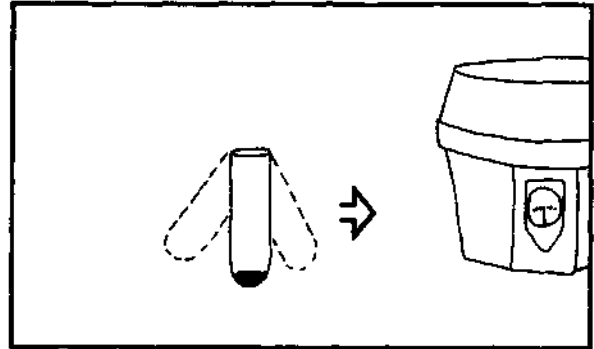

Check the colour of the supernatant serum.

RESULTS

1. *Yellow colour:*

There will be a deposit of red cells.
This donor may be used as a universal donor.

2. *Pinkish colour:*

All or most of the red cells will have been haemolysed and there will be only a small deposit left.

This group O donor's blood can be given to group O patients only.

In this case write on the label of the blood bottle:

**DANGEROUS GROUP O DONOR
USE FOR GROUP O PATIENTS ONLY**

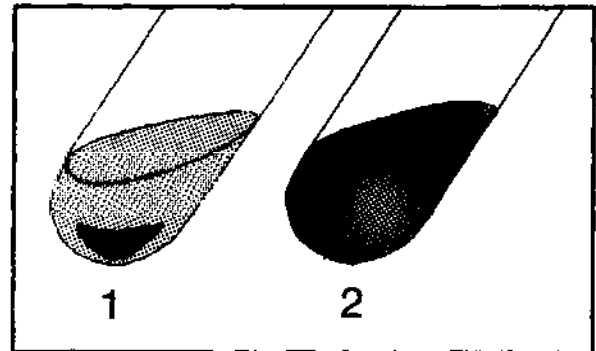

43. Collection and Storage of Blood

Blood for transfusion purposes must be collected and stored correctly to avoid transfusion reactions.

BLOOD DONORS

Requirements:

- healthy adults not under 18 years and not over 50 years of age
- a haemoglobin level above 125 g/l or haemoglobin(Fe) above 7.8 mmol/l.

A pregnant woman should not be asked to donate blood.

A person can donate blood every 4-6 months.

Blood group the donor by the slide grouping method (see pages 437 and 443).

COLLECTION OF BLOOD

Materials

- Cotton wool and ethanol
- A blood pressure cuff
- Blood collecting bottle (or plastic pack)
- Airway needle for collecting bottle
- Blood collecting set containing 120 ml of ACD solution
- Object for donor to squeeze
- Forceps
- Scissors
- Adhesive tape
- Pilot bottle containing 1 ml of ACD solution (reagent No. 1; see page 444) attached to collecting bottle
- Serum tube, if the blood is group O.

Method

1. Ask the donor to lie on a bed and support his head with a pillow.

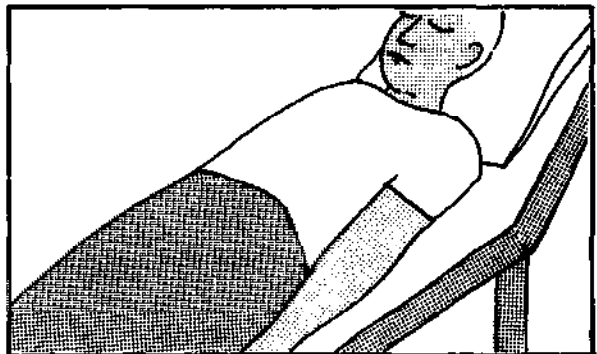

2. Prepare the blood collecting bottle, following any instructions supplied by the manufacturer. If the collecting bottle is glass and without a vacuum:
 - clean the top of the bottle with ethanol
 - insert an airway needle
 - insert the needle from the collecting set, making sure that the end of the needle is below that of the airway needle.

If at the same level, blood may be drawn up into the airway needle and block it.

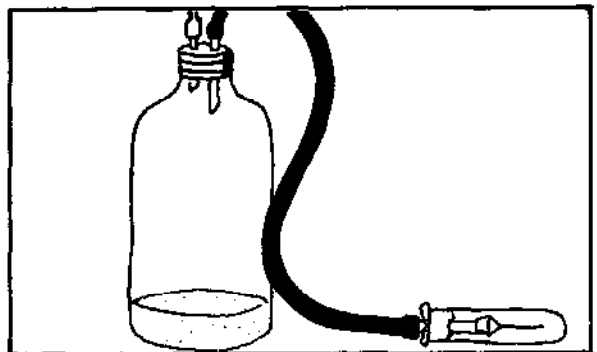

3. Place a pressure cuff on the upper part of the donor's arm.

Raise the pressure to 80–100 mmHg (11–13.5 kPa) and feel for the vein. (See page 353 for venepuncture.)

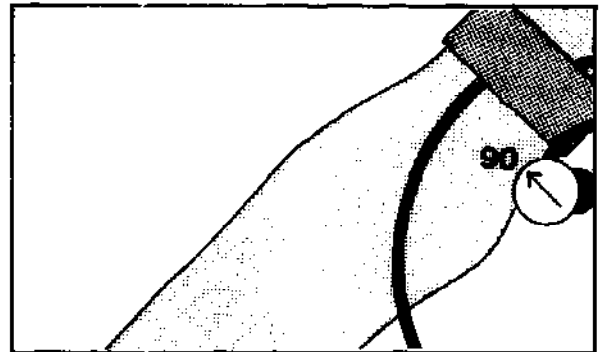

4. Clean the area round the vein well with 70% ethanol, using a cotton wool swab.

Insert the needle along the line of the vein.

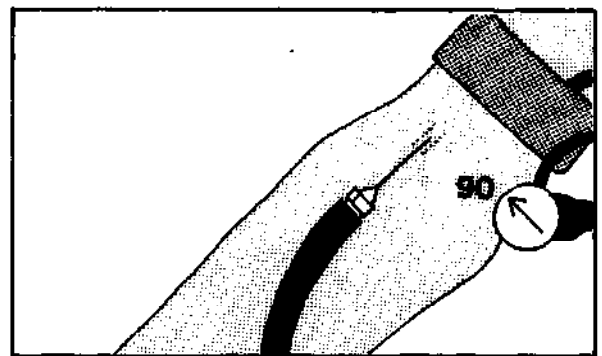

5. When blood begins to flow into the bottle, reduce the pressure to between 40 and 60 mmHg (5.5 and 8 kPa) and move the collecting bottle gently to ensure mixing of the blood with the anticoagulant.

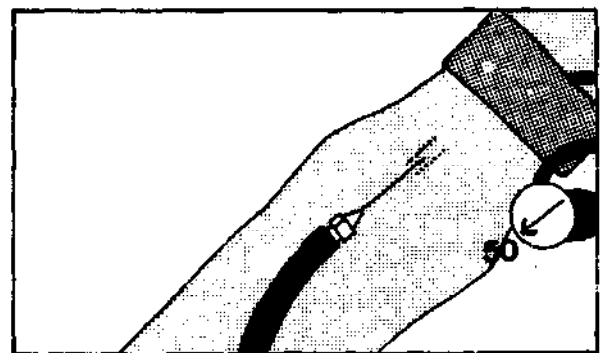

6. Ask the donor to squeeze his hand on a small object to help the flow of blood.

If the flow of blood slows down:

- raise the pressure to about 80 mmHg (11 kPa).

If this does not help:

- insert a second airway needle into the bottle.

If this does not help:

- try gently and carefully to adjust the needle in the vein.

If the needle comes out of the vein and a swelling (haematoma) appears because of bleeding under the skin, reduce the pressure, remove the needle, and press firmly with a cotton wool swab until the bleeding stops.

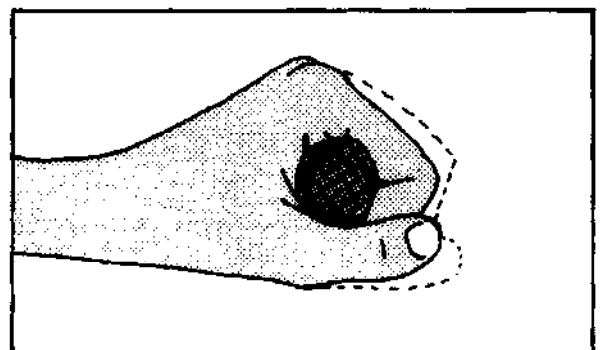

Important:

If the flow of blood stops, *never reduce* the pressure without first inserting another airway needle into the bottle. The flow of blood may have stopped because of a blocked airway, causing a build-up of air pressure in the bottle. If the pressure is reduced, the air will be forced out of the bottle, up the tubing and into the patient's vein, which can cause air embolism (blockage) and be fatal.

7. When the blood reaches the mark, usually 540 ml (120 ml ACD anticoagulant, and 420 ml of blood):
- reduce the pressure
 - clamp the tubing near the bottle
 - remove the object from the donor's hand.

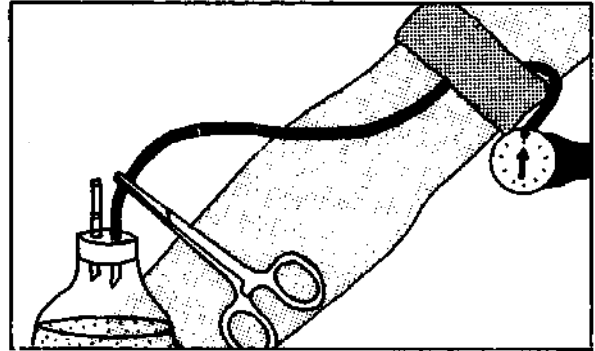

8. Remove the pressure cuff. Take out the needle, pressing the puncture site with a cotton wool swab.

Place the needle in the pilot bottle.

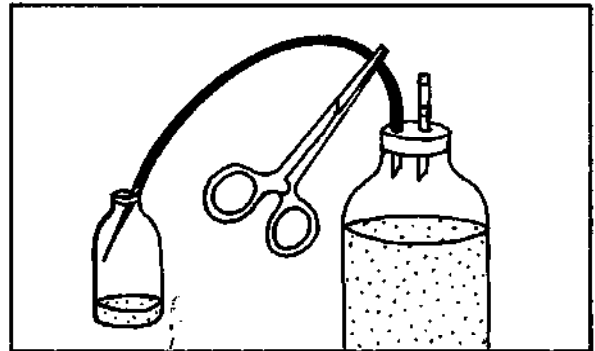

9. Remove the needle from the blood bottle:
- release the forceps
 - allow the blood to drain into the pilot bottle.

If the blood is group O, place a little in an empty tube also. The serum is needed for haemolysin testing (see page 456).

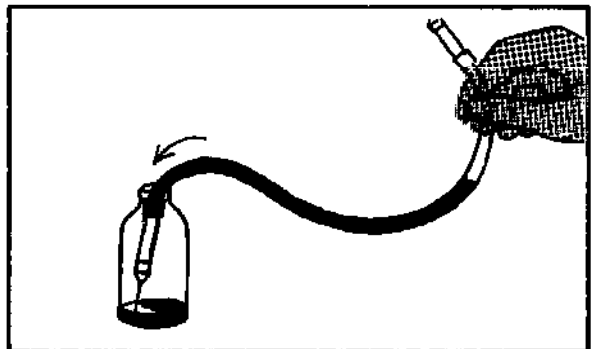

10. Remove the airway needle from the collecting bottle. Cover the top of the bottle with a plastic cap or adhesive tape.

11. Remove the needle from the pilot bottle. Cap the bottle.

Mix the blood with the anticoagulant in the pilot bottle by inverting the bottle several times.

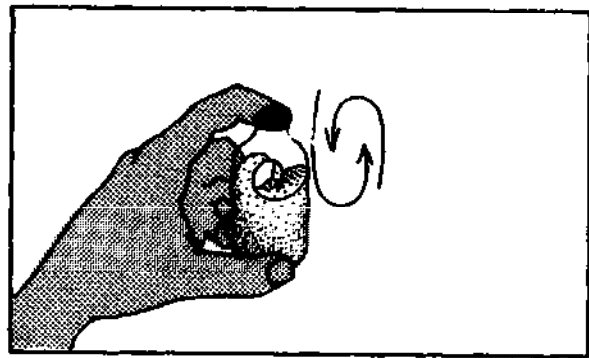

12. Label the pilot bottle and the blood bottle carefully with:

- the ABO and Rhesus group
- the number of the donor bottle
- the date of expiry (3 weeks from the time the blood is collected).

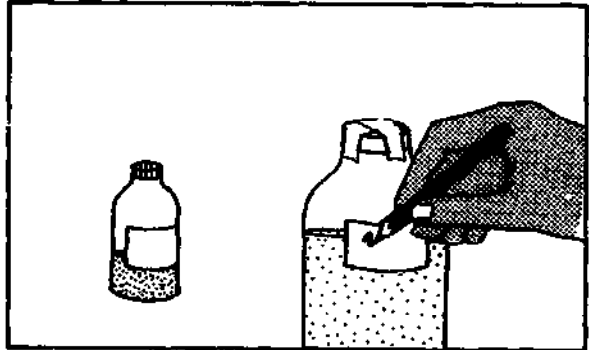

13. Make sure any bleeding from the venepuncture has stopped.

Cover the wound with a dressing.

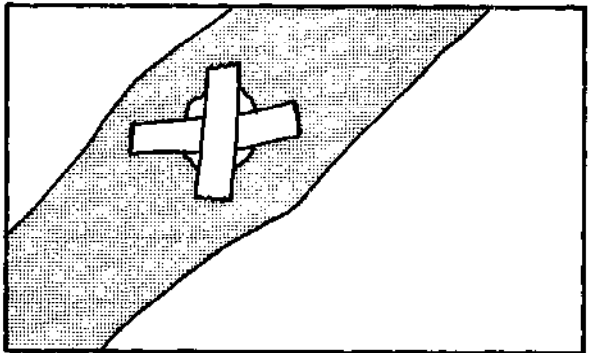

14. Give the donor a drink (fruit juice is suitable – not an alcoholic drink).

Give the donor a certificate of blood donation, obtained from the blood transfusion centre.

Keep a blood donor book, entering the donor's name, group, haemoglobin level, number and date of collection.



STORAGE OF BLOOD

Blood can be refrigerated and stored for up to three weeks under certain conditions:

- The temperature must be between 4 °C and 6 °C. This requires a thermostatically controlled refrigerator, preferably of the compression type. A domestic absorption type can also be used, operated either on gas or on electricity, provided that the refrigerator is not opened frequently.
- Blood stored for more than a few days at 8–10 °C must be discarded.
- Blood must not be stored with vaccines, reagents or medicines that require frequent use of the refrigerator.
- A daily temperature record must be kept using a thermometer kept in a bottle of water in the refrigerator. Ideally a temperature recorder should be fitted to a blood bank refrigerator.
- A written record of all the blood used and kept in the refrigerator should be maintained.

TESTS ON DONOR BLOOD

Certain diseases can be transmitted in the blood: testing for these may be required:

- Malaria parasites can be found in the blood, especially in endemic areas. It is usually best to give a course of chloroquine to patients receiving blood in such areas rather than discard blood in which the parasites are found. The parasites are not killed by storing the blood at 4-6 °C.
- *Treponema pallidum*, which causes syphilis, can remain viable in the blood for up to 48 hours. If therefore the blood is stored for longer than 2 days the organisms cannot be transmitted. Whenever possible VDRL testing should be done.
- Trypanosomes causing African and South American trypanosomiasis should be tested for in endemic areas by examining Romanowsky-stained thick blood smears. *T. cruzi* usually requires serological tests, since there are few organisms in the blood. For African trypanosomiasis the ESR may be a useful screening test together with a thick film examination.
- *Leishmania donovani*, which causes kala-azar, should be tested for in endemic areas by a formaldehyde gel screening test* on the serum. If the test is positive the blood must not be used.
- Pathogenic microfilariae can cause allergic reactions but cannot transmit filariasis.
- Viral hepatitis can be transmitted by blood transfusion. Whenever the appropriate facilities are available, it is advisable that Australia antigen testing for the virus should be carried out.

*Technique: To 1 ml of serum add 1 drop of 40% (commercial) formaldehyde. Complete coagulation occurs in a few seconds (the serum does not move when tube is inverted) when the test is positive. The mixture becomes turbid in 20 minutes. The reaction may be slow in the early stage of disease.

44. Blood Grouping and Cross-matching: Summary Plan of Work

BLOOD GROUPING (TYPING)

Slide or tile method

1. Prepare a suspension of patient's cells in sodium chloride solution (reagent No. 45). (Prepare in serum for Rhesus grouping.)
2. Take tiles, mark and pipette as follows:

Anti-A	Anti-B	Anti-AB
- 1 drop anti-A - 1 drop patient's cells	- 1 drop anti-B - 1 drop patient's cells	- 1 drop anti-AB - 1 drop patient's cells

A ₁ cells	B cells	O cells
- 1 drop A ₁ cells - 1 drop patient's serum	- 1 drop B cells - 1 drop patient's serum	- 1 drop O cells - 1 drop patient's serum

Anti-D
- 1 drop anti-D - 1 drop patient's cells (serum suspension)

3. Mix.
4. Warm the anti-D slide on a warm box.
5. Read the results:

Group	Anti-A	Anti-B	Anti-AB	A ₁ cells	B cells	O cells	Anti-D
A Pos	+	-	+	-	+	-	+
B Pos	-	+	+	+	-	-	+
AB Pos	+	+	+	-	-	-	+
O Pos	-	-	-	+	+	-	+

6. Record all the results in a blood grouping register.

Test-tube method

1. Prepare a suspension of patient's cells in 2-5% sodium chloride solution. (Prepare in serum for Rhesus grouping.)
2. Take 7 tubes, label and pipette as follows:

1 1 drop anti-A
1 drop patient's cells

2 1 drop anti-B
1 drop patient's cells

3 1 drop anti-AB
1 drop patient's cells

4 2 drops patient's serum
1 drop A₁ cells

5 2 drops patient's serum
1 drop B cells

6 2 drops patient's serum
1 drop O cells

7 1 drop anti-D
1 drop patient's cells (serum suspension)

3. Mix.
4. Incubate the anti-D tube at 37 °C.
5. Leave all tubes for 2 hours.
6. Read the results, checking the negative results by microscope.

CROSS-MATCHING (COMPATIBILITY TESTING)

Routine cross-match

1. Prepare a cell suspension of donor's and patient's red cells in 2% sodium chloride solution.
2. Take 4 tubes, label and pipette as follows:



1 *Albumin cross-match*
2 drops patient's serum
1 drop donor's cells



2 *Albumin auto-control*
2 drops patient's serum
1 drop patient's cells



3 *Sodium chloride solution cross-match*
2 drops patient's serum
1 drop donor's cells

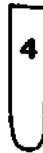

4 *Sodium chloride solution auto-control*
2 drops patient's serum
1 drop patient's cells

3. Mix.
4. Incubate all the tubes at 37°C for 1 hour.
5. Add 2 drops of 20% bovine albumin to tubes 2 and 4. DO NOT MIX.
6. Leave at 37°C for a further 20 minutes.
7. Examine the red cell deposit from each tube under the microscope.

If there is no agglutination, the blood is compatible. Issue the blood with the routine cross-match label.
If there is agglutination, see page 455 for interpretation.
Record all the results in a blood transfusion book.

Emergency cross-match

1. As for routine cross-match.
2. As for routine cross-match.
3. As for routine cross-match.
4. Incubate all the tubes at 37 °C for as long as possible.
If less than 45 minutes:
— centrifuge tube 1 for 1 minute at low speed.
5. Examine the red cell deposit from tube 1 under the microscope.

If there is no agglutination, issue blood with an emergency cross-match label.

Important:

Complete the cross-match following steps 5 to 7 as on page 454. If you observe any agglutination inform the doctor immediately.

REAGENTS AND THEIR PREPARATION

Order

Reagents are listed in alphabetical order. For example:

acetic acid	is under	A
brilliant cresyl blue	is under	B
carbol fuchsin	is under	C
hydrochloric acid	is under	H
sodium carbonate	is under	S

Each reagent has a number which appears after the name (the numbers are given in the techniques).

q.s. = the quantity required to make up
a certain volume

For example: sodium chloride 8.5 g
distilled water *q.s.* 1000 ml

This means:
Place 8.5 g of sodium chloride in a volumetric flask or
measuring cylinder. Add enough water (*q.s.*) to obtain
a total volume of 1000 ml.

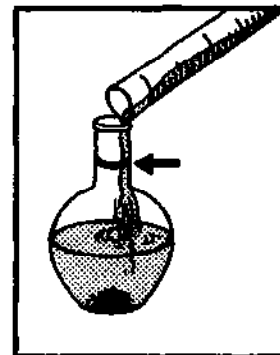
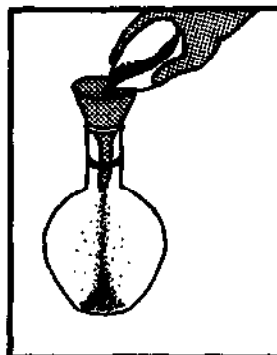

Chemical formulae

In most cases the chemical formulae of the compounds used are given immediately after the English names:

- sodium chloride (NaCl)
- potassium hydroxide (KOH)
- sulfuric acid (H₂SO₄)
- etc.

This can be useful when checking the label on the bottle.

An aqueous solution is a solution of a compound dissolved in water.

ACD SOLUTION (No. 1)*

Glucose	2.45 g
Trisodium citrate	2.20 g
Citric acid	0.89 g
Distilled water	100 ml

*United States Pharmacopeia (USP) formula

ACETIC ACID, 100 g/l (10%) (No. 2)

Glacial acetic acid (CH ₃ COOH)	20 ml
Distilled water	q.s. 200 ml

Warning: Glacial acetic acid is highly corrosive.

ACID-ETHANOL for Ziehl-Neelsen stain (No. 3)

Hydrochloric acid, concentrated	3 ml
Ethanol, 95%	97 ml

Warning: Hydrochloric acid is highly corrosive.

ACID REAGENT (No. 4)

Concentrated sulfuric acid	40 ml
Orthophosphoric acid 85%	5 ml
Iron ("ferric") chloride solution, 50 g/l (5%)	5 ml
Distilled water	q.s. 500 ml

Half fill a 500 ml flask with water, add the sulfuric acid very slowly, stirring constantly, and follow with the phosphoric acid (mixing). Add the iron chloride and make up to the 500 ml mark with water. Store in a brown bottle.

Warning: Sulfuric acid is highly corrosive.

BARIUM CHLORIDE, 100 g/l (10%) AQUEOUS SOLUTION (No. 5)

Barium chloride (BaCl ₂)	10 g
Distilled water	q.s. 100 ml

BENEDICT QUALITATIVE SOLUTION (No. 6)

Copper sulfate (CuSO ₄ ·5H ₂ O)	17.3 g
Trisodium citrate (Na ₃ C ₆ H ₅ O ₇ ·2H ₂ O)	173.0 g
Sodium carbonate (Na ₂ CO ₃) anhydrous	100.0 g
Distilled water	1000 ml

Dissolve the copper sulfate crystals by heat in 100 ml distilled water. Dissolve the trisodium citrate and the sodium carbonate in about 800 ml water. Add the copper sulfate solution slowly to the sodium carbonate/trisodium citrate solution, stirring constantly. Make up the mixture to 1000 ml with distilled water.

BLANK REAGENT (No. 7)

Trichloroacetic acid solution, 100 g/l (10%) 50 ml
 Distilled water q.s. 100 ml

Mix.

Warning: Trichloroacetic acid is highly corrosive.

BOVINE ALBUMIN 20% (No. 8)

For blood transfusion work.

Prepare from a 30% bovine albumin solution, which can be bought from a manufacturer.

30% bovine albumin 10 ml
 Sterile distilled water 5 ml

A 22% solution is available also. It can be used without further dilution and is recommended by some workers.

BRILLIANT CRESYL BLUE (No. 9)

Brilliant cresyl blue 1.0 g
 Trisodium citrate 0.4 g
 Sodium chloride solution, 8.5 g/l (0.85%) (reagent No. 21) 100 ml

Dissolve the dye and the citrate together in the sodium chloride solution. Filter the solution obtained.

BUFFERED GLYCEROL SALINE (No 10)

Sodium chloride 4.2 g
 Dipotassium hydrogen phosphate (K_2HPO_4), anhydrous 3.1 g
 Potassium dihydrogen phosphate (KH_2PO_4), anhydrous 1.0 g
 Phenol red 0.003 g
 Distilled water 700.0 ml
 Glycerol 300.0 ml

Final pH = 7.2

Dispense in bijou bottles so that there is only a 2 cm gap between the top of the medium and the top of the bottle.

BUFFER SOLUTION for the VDRL test (No. 11)

Disodium hydrogen phosphate (Na_2HPO_4), anhydrous 0.04 g
 Potassium dihydrogen phosphate (KH_2PO_4), anhydrous 0.17 g
 Sodium chloride 10.00 g
 Distilled water 1000.00 ml
 Formaldehyde solution, at least 37%, neutral, reagent grade 0.50 ml

Dissolve the salts in the distilled water, first the disodium hydrogen phosphate, then the potassium dihydrogen phosphate, then the sodium chloride, stirring well. Then add the formaldehyde solution. Check the pH of the solution, which should be $pH\ 6.0 \pm 0.1$. Store in screw-capped or glass-stoppered bottles.

Warning: Formaldehyde is corrosive and poisonous.

BUFFERED WATER (No. 12)

Buffer solution for May-Grünwald, Giemsa and Leishman stains

Disodium hydrogen phosphate ($\text{Na}_2\text{HPO}_4 \cdot 2\text{H}_2\text{O}$)	3.76 g
Potassium dihydrogen phosphate (KH_2PO_4), anhydrous	2.1 g
Distilled water	q.s. 1000 ml

Check the pH using narrow-range pH papers, or a comparator as shown on page 61. The pH should be 7.0-7.2.

CARBOL FUCHSIN for Ziehl-Neelsen stain (No. 13)

Solution A:

Saturated solution of basic fuchsin

Basic fuchsin	3 g
Ethanol, 95%	100 ml

Solution B:

Phenol solution, 50 g/l (5%), aqueous

Phenol	10 g
Distilled water	q.s. 200 ml

Then:

Solution A	10 ml
Solution B	90 ml

Warning: This solution is highly corrosive and poisonous.

CARY-BLAIR TRANSPORT (HOLDING) MEDIUM (No. 14)

Sodium thioglycolate	1.5 g
Disodium hydrogen phosphate (Na_2HPO_4), anhydrous	1.1 g
Sodium chloride	5.0 g
Agar	5.0 g
Distilled water	991.0 ml

1. If possible, prepare in chemically clean glassware.
2. Heat while mixing until the solution just becomes clear.
3. Cool to 50 °C, add 9 ml of freshly prepared aqueous calcium chloride solution, 10 g/l (1%), and adjust the pH to about 8.4.
4. Pour 7 ml into previously rinsed and sterilized 9 ml screw-capped vials.
5. Steam the vials containing the media for 15 minutes, cool, and tighten the caps.

CRYSTAL VIOLET, MODIFIED HUCKER (No. 15)

Solution A:

Crystal violet (certified)	2 g
Ethanol, 95%	20 ml

Solution B:

Ammonium oxalate ($(\text{NH}_4)_2\text{C}_2\text{O}_4 \cdot \text{H}_2\text{O}$)	0.8 g
Distilled water	80.0 ml

Mix solutions A and B. Store for 24 hours before use.
Filter through paper into staining bottle.

DICHROMATE CLEANING SOLUTION (No. 16)

For cleaning glassware.

Potassium dichromate ($K_2Cr_2O_7$)	100 g
Water	1000 ml
Pure sulfuric acid (H_2SO_4)	100 ml

Dissolve the dichromate in the water. Add the acid little by little, very carefully, stirring constantly. The acid must always be added to the water, NOT the water to the acid. If commercial detergents such as Teepol 053, Labrite, or Extran are available, dichromate cleaning solution is not usually necessary.

Warning: Since potassium dichromate and sulfuric acid are both corrosive and the mixture even more so, avoid using the solution as much as possible.

DRABKIN DILUTING FLUID (No. 17)

Drabkin diluting fluid can be prepared from reagent tablets bought direct from manufacturers. The instructions are supplied by the manufacturer.

For laboratories equipped with an accurate balance, Drabkin fluid can be prepared as follows:

Potassium ferricyanide	0.4 g
Potassium cyanide	0.1 g
Potassium dihydrogen phosphate	0.28 g
Nonidet P40 (Shell Chemical Co.) (or Sterox SE.)	2 ml (1 ml)
Distilled water	q.s. 2000 ml

Dissolve the first three chemicals in the water and mix.

Add the Nonidet (or Storex) detergent and mix gently.

The reagent should be clear and pale yellow in colour.

When measured against water as blank, in a spectrophotometer at a wavelength of 540 nm, the absorbance should be zero.

Store in a brown bottle. If the reagent appears cloudy, discard.

Warning: Potassium cyanide is a highly poisonous chemical and should be used only by experienced chemists. When not in use it should be kept in a locked cupboard. After using the chemical, wash your hands thoroughly.

EDTA DIPOTASSIUM SALT SOLUTION, 100 g/l (10%) ("potassium edetate") (No. 18)

Dipotassium ethylenediaminetetraacetate	20 g
Distilled water	q.s. 200 ml

For use, pipette 0.04 ml of this solution into small containers marked to hold 2.5 ml of blood. Allow the anticoagulant to dry by leaving the containers overnight on a warm bench or in a 37 °C incubator.

EHRlich REAGENT (No. 19)

Paradimethylaminobenzaldehyde	2 g
Concentrated hydrochloric acid (HCl)	20 ml
Distilled water	80 ml

Mix the chemical in the water and then add the acid carefully.

Mix well.

Warning: Hydrochloric acid is highly corrosive.

EOSIN, 10 g/l (1%) AQUEOUS SOLUTION (No. 20)

Eosin	1 g
Distilled water	q.s. 100 ml

EOSIN, 20 g/l (2%) SOLUTION IN SALINE (No. 21)

Eosin	2 g
Sodium chloride, 8.5 g/l (0.85%) aqueous solution	q.s. 100 ml

FIELD STAIN (No. 22)

FIELD STAIN A:

Preparation from prepared powders:

Field stain A powder 5.0 g
Hot distilled water q.s. 600 ml

Mix until dissolved. Filter when cool.

Preparation from original stains and chemicals:

Methylene blue (medicinal) 1.6 g
Azur I 1.0 g
Disodium hydrogen phosphate (Na_2HPO_4), anhydrous 10.0 g
Potassium dihydrogen phosphate (KH_2PO_4), anhydrous 12.5 g
Distilled water q.s. 1000 ml

Dissolve the two phosphates in the water. Pour about half of the phosphate solution into a litre bottle containing a few glass beads. Add the stain powders and mix well. Add the remainder of the phosphate solution. Mix well and filter.

FIELD STAIN B:

Preparation from prepared powders:

Field stain B powder 4.8 g
Hot distilled water q.s. 600 ml

Mix until dissolved. Filter when cool.

Preparation from original stain and chemicals:

Eosin (yellow water-soluble) 2.0 g
Disodium hydrogen phosphate (Na_2HPO_4), anhydrous 10.0 g
Potassium dihydrogen phosphate (KH_2PO_4), anhydrous 12.5 g
Distilled water q.s. 1000 ml

Dissolve the two phosphates in the water. Pour into a litre bottle. Add the eosin. Mix until dissolved. Filter.

FLUORIDE OXALATE (No. 23) Anticoagulant

Sodium fluoride 1.2 g
Potassium oxalate 6.0 g
Distilled water q.s. 100 ml

For use, pipette 0.1 ml of the anticoagulant into small containers, marked to hold 2 ml of blood (or CSF).

Warning: Both sodium fluoride and potassium oxalate are poisonous.

FORMALDEHYDE CITRATE (No. 24)

Sodium citrate 3.0 g
Commercial formaldehyde solution, at least 37% ("formalin") 1.0 ml
Distilled water 100.0 ml

Warning: Formaldehyde is corrosive and poisonous.

FORMALDEHYDE SALINE (No. 25)

Neutral formaldehyde solution, at least 37% ("formalin") 10 ml
Sodium chloride solution, 8.5 g/l (0.85%) (No. 45) 90 ml

Commercial formaldehyde solution is neutralized by adding a few drops of 50 g/l (5%) sodium carbonate solution (reagent No. 44). Test with pH indicator paper.

Warning: Formaldehyde is corrosive and poisonous.

FORMALDEHYDE SOLUTION, 10% (No. 26)

Commercial formaldehyde solution, at least 37% ("formalin") 100 ml
Distilled water 300 ml

Warning: Formaldehyde is corrosive and poisonous.

FOUCHET REAGENT (No. 27)

1. First prepare a 10% solution of iron ("ferric") chloride:
Iron chloride (FeCl_3) 10 g
Distilled water q.s. 100 ml
2. Preparation of reagent:
Iron chloride solution 10 ml
Trichloroacetic acid (CCl_3COOH) 25 g
Distilled water 100 ml

Dissolve the acid in about 70 ml of distilled water in a 100 ml volumetric flask. Add the 10 ml of 10% iron chloride solution. Make the volume up to 100 ml with distilled water.

Warning: Trichloroacetic acid is highly corrosive.

GIEMSA STAIN (No. 28)

Powdered Giemsa stain 0.75 g
Methanol (CH_3OH) 65 ml
Glycerol 35 ml

Put the ingredients in a bottle containing glass beads and shake. Shake the bottle 3 times a day for 4 consecutive days. Filter.
(Check the manufacturer's instructions in case the quantities indicated are not the same).

In some countries Wright stain (No. 60) is used instead of Giemsa stain.

GLUCOSE REAGENTS (No. 29)

TRICHLOROACETIC ACID, 30 g/l (3%)

Trichloroacetic acid 15 g
Distilled water q.s. 500 ml

Weigh the acid out quickly, since it is highly deliquescent. Transfer to a beaker. Add water to dissolve the chemical. Transfer to a 500 ml flask and make up to the mark with water. Keep indefinitely in the refrigerator.

Warning: Trichloroacetic acid is highly corrosive.

ORTHOTOLUIDINE REAGENT

Thiourea 0.75 g
Glacial acetic acid 470 ml
Orthotoluidine 30 ml

Dissolve the thiourea in the glacial acetic acid. (If it is difficult to dissolve stand the flask in a bowl of hot water.) Add the orthotoluidine and mix well. Store in a brown bottle, and keep at room temperature.

Warning: Avoid contact with these chemicals; glacial acetic acid is highly corrosive.

BENZOIC ACID, 1 g/l (0.1%)

Benzoic acid 1 g
Distilled water q.s. 1000 ml

Measure 1000 ml distilled water and heat to just below boiling. Add the benzoic acid. Dissolve. Allow to cool.

GLUCOSE REAGENTS (continued)

GLUCOSE STOCK REFERENCE SOLUTION

Glucose (dextrose), pure, anhydrous 5 g
Benzoic acid solution, 1 g/l q.s. 500 ml

Weigh out the glucose with great accuracy. Transfer to a 500 ml volumetric flask and make up to the mark with the benzoic acid solution. Mix well.

Freeze in quantities of about 20 ml. Use a new bottle of frozen stock reference solution each time the working reference is prepared.

WORKING GLUCOSE REFERENCE SOLUTION

100 mg reference:

Glucose stock reference solution 1.0 ml
Benzoic acid, 1 g/l q.s. 100 ml

Using great accuracy, pipette 1.0 ml of the stock reference solution into a 100 ml volumetric flask. Make up to the mark with the benzoic acid solution. Mix well. Store in a refrigerator. Renew monthly.

GLYCEROL WATER (No. 30)

Glycerol, pure 5 ml
Distilled (or filtered and boiled) water q.s. 1000 ml

GRAM IODINE SOLUTION (No. 31)

Iodine 1 g
Potassium iodide (KI) 2 g
Distilled water 300 ml

Grind the dry iodine and potassium iodide in a mortar. Add water, a few ml at a time, and grind thoroughly after each addition until the iodine and iodide dissolve. Rinse the solution into an amber glass bottle with the remainder of the distilled water. Alternatively:

Measure 100 ml of water in a cylinder. First dissolve the potassium iodide in about 30 ml of the water. Add the iodine and mix until dissolved. Add the remainder of the water and mix well. Store in a brown bottle.

HYDROCHLORIC ACID, 0.1 mol/l (0.1 N) (No. 32)

Hydrochloric acid (HCl), concentrated 8.6 ml
Distilled water q.s. 1000 ml

Measure out 500 ml of water. Add the acid, drop by drop. Make up to 1 litre with the rest of the water. The solution obtained may be used only for haemoglobin estimation by the Sahli method. Renew monthly.

Warning: Hydrochloric acid is highly corrosive.

ISOTONIC SALINE (see Sodium chloride solution)

KINYOUN CARBOL FUCHSIN (No. 33)

Basic fuchsin 4 g
Phenol 8 g
Ethanol, 95% 20 ml
Distilled water 100 ml

First dissolve the fuchsin in ethanol. Then add phenol and water.

Warning: Phenol is highly corrosive and poisonous.

LACTOPHENOL COTTON BLUE MOUNTING SOLUTION (No. 34)

Phenol crystals	20 mg
Lactic acid	20 ml
Glycerol	40 ml
Distilled water	20 ml

Mix and dissolve by heating gently. Add 0.05 g of cotton blue.

Warning: Phenol is highly corrosive and poisonous.

LEISHMAN STAIN (No. 35)

Leishman powder	1.5 g
Methanol	q.s. 1000 ml

Rinse out a clean bottle with methanol. Add a few clean dry glass beads. Add the staining powder and methanol. Mix well to dissolve the stain. The stain is ready for use the following day. When preparing an ethanol Romanowsky stain such as Leishman, it is important to allow no moisture to enter the stain during its preparation or storage.

LUGOL IODINE SOLUTION (No. 36)

Iodine	1 g
Potassium iodide (KI)	2 g
Distilled water	q.s. 100 ml

Weigh the iodine in a porcelain dish or a watch glass. Grind the dry iodine and potassium iodide in a mortar. Add water, a few millilitres at a time, and grind thoroughly after each addition until the iodine and iodide dissolve. Put the solution into an amber glass bottle with the remainder of the distilled water. Alternatively:

Measure 100 ml of water in a cylinder. First dissolve the potassium iodide in about 30 ml of the water. Add the iodine and mix until dissolved. Add the remainder of the water and mix well. Store in a brown bottle.

MAY-GRÜNWARD STAIN (No. 37)

May-Grünwald powder	5 g
Methanol	q.s. 1000 ml

Rinse out a clean bottle with methanol. Add a few clean dry glass beads. Add the staining powder and methanol. Mix well to dissolve all the stain.

The stain is improved by keeping for 1-2 weeks, mixing at intervals. When preparing an ethanol Romanowsky stain such as May-Grünwald, it is important to allow no moisture to enter the stain during its preparation or storage.

METHYLENE BLUE, AQUEOUS (No. 38)

Methylene blue	0.3 g
Distilled water	100 ml

Filter after dissolving.

MIF (No. 39)

1. Prepare a stock solution:

Tincture of thiomersal, 1:1000 (Merthiolate, Lilly)	200 ml
Formaldehyde solution (No. 26)	25 ml
Glycerol	5 ml
Distilled water	250 ml

Store in a brown bottle for up to 3 months.

2. Preparation of 50 g/l (5%) Lugol iodine solution:

Iodine	5 g
Potassium iodide (KI)	10 g
Distilled water	q.s. 100 ml

Prepare in the same way as Lugol iodine solution (No. 36). Store in a brown bottle for no more than 1 month.

3. On the day of use, mix:

Stock thiomersal solution	9.4 ml
Lugol iodine solution, 50 g/l (5%)	0.6 ml

Warning: Formaldehyde is corrosive and poisonous.

PANDY REAGENT (No. 40)

Phenol 30 g
 Distilled water 500 ml

Put the phenol in a 1000 ml bottle. Add the water. Shake vigorously. Leave to stand for one day. Check whether any phenol remains undissolved. If so, filter. (If all the phenol has dissolved, add a further 10 g and wait another day before filtering.) Pandy reagent is a saturated solution of phenol.

Warning: Phenol is highly corrosive and poisonous.

POTASSIUM HYDROXIDE, 200 g/l (20%) (No. 41)

Potassium hydroxide pellets (KOH) 20 g
 Distilled water q.s. 100 ml

Warning: Potassium hydroxide is corrosive.

SAFRANINE SOLUTION (No. 42)

Stock solution:
 Safranin O (certified) 2.5 g
 Ethanol, 95% q.s. 100.0 ml

Working solution:
 Stock solution 10 ml
 Distilled water 90 ml

SILVER NITRATE, 17 g/l (1.7%) SOLUTION (No. 43)

Silver nitrate 5.1 g
 Distilled water q.s. 300 ml

Warning: Silver nitrate is caustic.

SODIUM CARBONATE, 50 g/l (5%) AQUEOUS SOLUTION (No. 44)

Sodium carbonate (Na_2CO_3), anhydrous (or an equivalent quantity of one of the hydrates) 5 g
 Distilled water q.s. 100 ml

SODIUM CHLORIDE SOLUTION, 8.5 g/l (0.85%) ("isotonic saline") (No. 45)

Sodium chloride 8.5 g
 Distilled water q.s. 1000 ml

SODIUM CITRATE SOLUTIONS. See Trisodium citrate.

SODIUM HYDROXIDE 30 g/l (3%) AQUEOUS SOLUTION (No. 46)

Sodium hydroxide pellets 3 g
 Distilled water q.s. 100 ml

Warning: Sodium hydroxide is corrosive.

SODIUM HYDROXIDE, 100 g/l (10%) AQUEOUS SOLUTION (No. 47)

Sodium hydroxide pellets 10 g
 Distilled water q.s. 100 ml

SODIUM METABISULFITE, 20 g/l (2%) AQUEOUS SOLUTION (No. 48)

Sodium metabisulfite ($\text{Na}_2\text{S}_2\text{O}_5$) 0.5 g
Distilled water q.s. 25 ml

Make up freshly for use.

SODIUM THIOSULFATE, 30 g/l (3%) AQUEOUS SOLUTION (No. 49)

Sodium thiosulfate, anhydrous (or an equivalent quantity of
 $\text{Na}_2\text{S}_2\text{O}_3 \cdot 5\text{H}_2\text{O}$) 3 g
Distilled water q.s. 100 ml

Store in a brown drop bottle. Used to neutralize any chlorine in water samples taken for bacteriological analysis.

STUART TRANSPORT MEDIUM, MODIFIED (No. 50)

Agar 4.00 g
Distilled water 1.00 l

Heat until dissolved and add while hot:

Sodium chloride 3.00 g
Potassium chloride 0.20 g
Disodium hydrogen phosphate (Na_2HPO_4), anhydrous 1.15 g
Sodium dihydrogen phosphate (NaH_2PO_4), anhydrous 0.20 g
Sodium thioglycolate 1.00 g
Calcium chloride, 10 g/l (1%) aqueous solution freshly prepared. . . 10.00 ml
Magnesium chloride, 10 g/l (1%) aqueous solution 10.00 ml

Final pH : 7.3

1. Stir until dissolved. Add 10 g neutral charcoal powder.
2. Dispense 5-6 ml per 13 x 10 mm screw-capped tube (avoid crushing).
3. Autoclave at 121 °C for 20 minutes. Invert tubes prior to solidification in order to distribute the charcoal uniformly. Store in refrigerator.

SULFOSALICYLIC ACID 300 g/l (30%) AQUEOUS SOLUTION (No. 51)

Sulfosalicylic acid 30 g
Distilled water q.s. 100 ml

SULFOSALICYLIC ACID 30 g/l (3%) SOLUTION (No. 52)

For quantitative protein tests using protein standards:

- dilute the 300 g/l solution as follows:
 - 300 g/l sulfosalicylic acid 50 ml
 - distilled water 450 ml.

TRISODIUM CITRATE, 20 g/l (2%) AQUEOUS SOLUTION (No. 53)

Trisodium citrate. 2 g
Sodium chloride solution (No. 45) q.s. 100 ml

Keep in refrigerator.

TRISODIUM CITRATE, 38 g/l (3.8%) AQUEOUS SOLUTION (No. 54)

Trisodium citrate, anhydrous (or an equivalent quantity of either the
dihydrate or the pentahydrate) 3.8 g
Distilled water q.s. 100 ml

Keep in the refrigerator. Use 1 ml of the solution per 4 ml of blood.

TÜRK SOLUTION (No. 55)

Acetic acid (CH₃COOH), glacial 4 ml
Distilled water q.s. 200 ml
Aqueous methylene blue solution 10 drops

The methylene blue solution is prepared by dissolving 0.3 g methylene blue in 100 ml of distilled water. Filter before adding to the acid solution.

Warning: Acetic acid is corrosive.

UREA REAGENTS (No. 56)

TRICHLOROACETIC ACID, 100 g/l (10%)

Trichloroacetic acid 20 g
Distilled water q.s. 200 ml

Weigh the acid out quickly, since it is highly deliquescent. Transfer to a beaker. Add water to dissolve the chemical. Transfer to a 200 ml stoppered cylinder or flask and make up to the 200 ml mark with water.

Warning: Trichloroacetic acid is highly corrosive.

STOCK DIACETYL MONOXIME

Diacetyl monoxime (also called 2, 3-butanedione monoxime) 6.25 g
Distilled water q.s. 250 ml

Dissolve the chemical in the water. The solution should be renewed every month.

STOCK THIOSEMICARBAZIDE

Thiosemicarbazide 0.63 g
Distilled water q.s. 250 ml

Dissolve the chemical in the water. The solution is stable at room temperature.

5% TRISODIUM CITRATE SOLUTION

Trisodium citrate 5 g
Distilled water q.s. 100 ml

WORKING DIACETYL MONOXIME/THIOSEMICARBAZIDE

Stock diacetyl monoxime 24 ml
Stock thiosemicarbazide 10 ml
Distilled water q.s. 100 ml

Mix the solutions together. Renew the solution every month.

UREA STOCK REFERENCE SOLUTION

Urea 0.5 g
Benzoic acid aqueous solution, 10 g/l (1%) q.s. 500 ml

Weigh with great accuracy. Using a 500 ml volumetric flask, dissolve the chemical in the solution. Mix well.

UREA WORKING REFERENCE SOLUTION

Urea stock reference solution 10 ml
10% trichloroacetic acid 50 ml
Benzoic acid aqueous solution, 10 g/l (1%) q.s. 100 ml

Pipette with great accuracy. Mix the solutions well in a 100 ml volumetric flask.

Warning: Trichloroacetic acid is highly corrosive.

WAYSON STAIN (No. 57)

Solution A₁:

Basic fuchsin	0.2 g
Methanol, anhydrous ("absolute")	10 ml

Solution A₂:

Methylene blue	0.7 g
Methanol, anhydrous ("absolute")	10 ml

Combine the two solutions = Solution A.

Solution B: (50 g/l (5%) aqueous solution of phenol)

Phenol	10 g
Distilled water	200 ml

Add Solution A to Solution B. The staining properties of Wayson stain improve with age. Make the stain in large quantities and dispense it in small amounts in dark bottles for future use.

Warning: Phenol is corrosive.

WILLIS SOLUTION (No. 58)

This is a saturated solution of sodium chloride.

Sodium chloride	125 g
Distilled water	500 ml

Dissolve the sodium chloride by heating the mixture to boiling point. Leave to cool and stand. Check that some of the salt remains undissolved. If it has all dissolved add a further 50 g. Filter and keep in a corked bottle.

WINTROBE MIXTURE (No. 59)

Anticoagulant solution.

Ammonium oxalate ((NH ₄) ₂ C ₂ O ₄ .H ₂ O)	1.2 g
Potassium oxalate (K ₂ C ₂ O ₄ .H ₂ O)	0.8 g
Distilled water	q.s. 100 ml

Put 0.5 ml of this mixture in each 5 ml bottle used for the collection of blood. Leave the open bottles to dry at room temperature or, preferably, put them in an incubator at 37°C.

WRIGHT STAIN (No. 60)

Wright stain (powder)	0.3 g
Glycerol	3 ml
Methanol	97 ml

ZENKER FIXATIVE (No. 61)

Potassium dichromate	2.5 g
Mercuric chloride	5.0 g
Sodium sulfate	1.0 g
Distilled water	q.s. 100 ml

Just before use, add to the 100 ml of solution:

Acetic acid, glacial	5 ml
----------------------------	------

Warning: Glacial acetic acid is highly corrosive, and mercuric chloride is highly poisonous. This fixative should be made up by fully qualified and experienced technicians only.

INDEX

A

- ABO grouping of blood, 435-436
 - with antisera, slide method, 437-439
 - test-tube method, 440-441
 - with standard red cells, slide (tile) method, 443-445, 463
 - test-tube method, 446, 463
- Accidents, 98
 - avoidance of, 101
- ACD solution, 444, 458, 466
- Acetic acid, 100 g/l, 175, 331, 334, 466
- Acid-ethanol, 249, 253, 257, 466
 - modified, 259
- Acid reagent, 432, 466
- Actinomycetes, 240
- Amoebae, 73
 - cysts, 157-158
 - motile forms, 148, 150-152, 165
- Ancylostoma duodenale*, 123, 142
 - eggs, 125, 126, 163
 - larvae, 169
 - worms, 146
- Anisocytosis, 409
- Anthrax bacilli, 239
- Anticoagulants, 68-69, 72, 352, 466, 469, 470, 475, 477
- Antigen D, 435, 448
 - geographical distribution, 452
- Ascaris lumbricoides*, 123, 142
 - eggs, 125, 127, 140, 163
 - worms, 143
- Autoclave, 33-35

B

- Bacilli, acid-fast, 249, 252
 - anthrax, 239
 - diphtheria, 270, 271
 - Gram negative, 240, 244
 - Gram positive, 239, 244
 - leprosy, 252, 259-262, 264
 - plague, 265-267
 - tetanus, 239
 - tubercle, 249-258, 277

- Bacteriological examination, 231-234
 - gonorrhoea, 243-244
 - leprosy, 259-264
 - plague, 265-267
 - staining, 235-237
 - stools, dispatch for, 268-269
 - syphilis, 246-248
 - throat specimens, 270-272
 - tuberculosis, 249-258
 - urine, 275-277
 - water, dispatch for, 279-284
- Balances, 48-51
- Balantidium coli*, cysts, 155, 159
 - motile form, 148, 154
- Barium chloride, 100 g/l aqueous solution, 317, 466
- Basophil cells, polymorphonuclear, 401
- Basophilic granules, 410
- Benadict method for glucose in urine, 311
- Benedict qualitative solution, 311, 466
- Benzidine test, 177
- Benzoic acid, 1 g/l, 429, 471
- Bile pigments, in urine, 316-318
- Biopsy material, fixation and dispatch, 73, 75-77
- Blank reagent, 432, 467
- Blast cells, 404
- Blastocystis, in stools, 160
- Bleeding time, 421-422
- Blood, cerebrospinal fluid in, 340
 - collection, capillary, 189-190, 358, 388
 - venous, 353-358, 437, 458-461
 - dispatch, 72, 285-287
 - dried, 287
 - glucose estimation, 429-431
 - occult, in stools, 175-177
 - urea in, 432-434
 - in urine, 337
- Blood coagulation, 325
 - tests for, 421-427
- Blood cross-matching, 453-455, 464
- Blood donors, 458
 - dangerous group O, 456-457
 - register, 82
- Blood film, thick, preparation, 189-191
 - staining, 191-196
- Blood film, thin, fixation, 390
 - preparation, 387-390
 - staining, 391-396
- Blood grouping, 435-436
 - ABO system, 437-447
 - plan of work, 463-464
 - rhesus system, 448-452
- Blood plasma *see* Plasma, blood
- Blood platelets *see* Thrombocytes
- Blood serum *see* Serum, blood

Blood transfusion, 435-464
Borrelia, 241
Bovine albumin, 20%, 453, 464, 467
Brilliant cresyl blue, 414, 417, 467
Brugia malayi, 213, 214
Buffered glycerol saline, 72, 269, 467
Burettes, 46
Bürker ruled chamber for blood cell counts, 364
Burns, acid, 98
 alkali, 99
 heat, 100

C

Cabot bodies, 410
Candida, 270, 272, 349
Carbol fuchsin, Kinyoun, 257, 472
 Ziehl-Neelsen, 249, 253, 468
 modified for leprosy test, 259
Cary-Blair transport medium, 265, 268, 468
Casts, in urinary deposits, 330-332
Centrifuges, 52-55
 see also Microhaematocrit centrifuge
Cerebrospinal fluid, appearance, 340
 collection, 339
 dispatch, 71, 350
 fungi in, 349
 glucose estimation, 344, 429
 Gram staining, 348
 leukocyte concentration in, 342
 meningococci in, 346
 microscopical examination, 347
 pneumococci in, 348
 protein in, 345-346
 register, 80
 trypanosomes in, 347
 Ziehl-Neelsen staining, 349
Chagas' disease see Trypanosomiasis, South American
Chilomastix mesnili, cysts, 158
 motile forms, 148, 154
Cholera vibrios, 72, 268, 269
Ciliates, cysts, 155, 158
 motile forms, 148, 154
Clonorchis sinensis, 123
 eggs, 125, 128, 141, 163
 worm, 146
Clot retraction and lysis time, 425-427
Coagulation time, whole blood, 423-424
Cocci, Gram negative, 244
 Gram positive, 239, 244
Coccidia, in stools, 161
Coccobacilli, Gram negative, 240
Compatibility testing of blood, 453-455, 463-464

Concentration methods, microfilariae, 223-225
 parasites in stools, 162-169
 trypanosomes, 207-208
Containers for specimens, 68-73
 biopsy tissue, 73, 76
 blood, 68-69, 72, 286-287, 461
 cerebrospinal fluid, 71, 350
 disposal and sterilization, 39-41
 pus, 71, 245-246
 throat, 71, 273
 sputum, 70, 255
 stools, 72-73, 114, 268
 urine, 73, 305
 water, 279
Corynebacterium diphtheriae, 270, 271
Cross-matching blood for transfusion, 453-455, 464
Crystal violet, modified Hucker, 235, 468
Crystals, in urinary deposits, 332-335
CSF see Cerebrospinal fluid
Cysts in stools, 155-161
 artifacts, 160-161
 microscopical appearance, 157-159
 recognition features, 156
 slide examination, 155

D

Diabetes mellitus, 429
Diacetyl monoxime/thiosemicarbazide
 method for urea estimation, 432-434
Dichromate cleaning solution, 30, 369, 469
Dicrocoelium, 123, 142
 eggs, 128, 141, 163
 worms, 146
Dientamoeba fragilis, 158
 motile form, 148, 152
Differential leukocyte count see Leukocyte
 type number concentration
Differential white cell count see Leukocyte
 type number concentration
Dipetalonema perstans, 213
Dipetalonema streptocerca, 218
Diphtheria bacilli, 271
Diphyllobothrium latum, 123, 142
 eggs, 128, 141
Diplococci, Gram negative, 239, 243
Dipylidium caninum, 123, 142
 eggs, 129
 worms, 145
Drabkin diluting fluid, 371, 469
Duke method for bleeding time, 421-422

E

- Echinococcus granulosus*, 185
- EDTA dipotassium salt solution, 68, 72, 352, 380, 383, 388, 413, 414, 418, 433, 437, 448, 469
- Eggs, in sputum, 183-184
 - in stools, alphabetical list, 123
 - artifacts, 138-140
 - concentration methods, 163-169
 - identification key, 125
 - microscopical appearance, 121, 126-137, 140-141
 - terms used, 124
- in urine, 178-180
- Ehrlich reagent, 319, 469
- Electrical equipment, setting up and maintenance, 87-93
- Electric shock, 101
- Elliptocytes, 410
- Endolimax nana*, cysts, 158
 - motile form, 148, 152
- Entamoeba coli*, cysts, 157
 - motile form, 150, 151
- Entamoeba hartmanni*, cysts, 157
 - motile form, 152
- Entamoeba histolytica*, cysts, 155, 157, 159
 - motile form, 148, 150, 151
- Enterobius vermicularis*, 123, 142
 - collection of eggs, 119-21
 - eggs, 125, 129, 140
 - worms, 143
- Eosin, 10 g/l aqueous solution, 297, 469
 - 20 g/l solution in saline, 147, 469
- Eosinophilia, 406
- Eosinophils, polymorphonuclear, 401
- Epithelial cells, in urinary deposits, 329
- Erythrocyte count *see* Erythrocyte number concentration
- Erythrocyte number concentration, 9, 366-370, 384
- Erythrocyte sedimentation rate, 418-420
- Erythrocyte volume fraction, 8, 9, 379-385
- Erythrocytes, 351
 - abnormal, 407-410
 - in urinary deposits, 327
- ESR *see* Erythrocyte sedimentation rate

F

- Fasciola hepatica*, 123, 142
 - eggs, 125, 130, 141, 163
 - worms, 146

- Fasciolopsis buski*, 123, 142
 - eggs, 125, 130, 141, 163
 - worms, 146

- Field stain *see* Stain, Field
- Filariae *see* Microfilariae
- First aid procedures, 98-101
- Fixation, bacterial smears, 233-235, 250, 261, 266
 - biopsy tissue, 73, 75-76
 - thick blood films, 191
 - thin blood films, 390, 391, 393, 395
- Flagellates, in stools, cysts, 158
 - motile forms, 148, 153-154, 165
 - recognition features, 156
- in urine, 181
- Flukes, blood *see* *Schistosoma*
 - cat liver *see* *Opisthorchis felineus*
 - Chinese liver *see* *Clonorchis sinensis*
 - giant intestinal *see* *Fasciolopsis buski*
 - giant liver *see* *Fasciola hepatica*
 - Japanese *see* *Metagonimus yokogawai*
 - lancet *see* *Dicrocoelium*
 - oriental lung *see* *Paragonimus westermani*
 - small oriental *see* *Heterophyes heterophyes*
- Fluoride oxalate, 341, 344, 352, 429, 470
- Formaldehyde citrate solution, 366, 470
- Formaldehyde-ether concentration technique, 162, 165-167
- Formaldehyde saline, 73, 75, 470
- Formaldehyde solution, 10%, 72, 73, 165, 173, 325, 471
- Fouchet reagent, 317, 471
- Fuchs-Rosenthal counting chamber, 343
- Fungi, in cerebrospinal fluid, 349
 - in genitourinary discharge, 188
 - in stools (yeasts), 160
 - in urinary deposits (yeasts), 328

G

- Gametocytes, 197, 200-201
- Giardia lamblia*, cysts, 155, 158, 159
 - motile form, 148, 153
- Giemsa stain *see* Stain, Giemsa
- Glassware, 27-32, 34, 37, 64-67, 105, 369-370
- Glossina*, 226
- Glucose, estimation in blood, 429-431
 - in cerebrospinal fluid, 344, 429
 - in urine, 311-312
- Glucose reagents, 429, 471-472
- Gonococci, 239, 243-244
- Gonorrhoea, 231, 243-244
- Gram stain *see* Stain, Gram
- Granulocytes, 403

H

- Haematocrit *see* Erythrocyte volume fraction
Haemoglobin, concentration, 385
 estimation by cyanmethaemoglobin
 photometric method, 371-374
 estimation by Sahli method, 377-378
 estimation using comparator, 375-376
 units of measurement, 371
Haemoglobin H bodies, 417
Haemoglobin S, 411
Haemophilus influenzae, 348
Hansen's bacillus *see* *Mycobacterium leprae*
Harada-Mori stool concentration technique,
 162, 168-169
Heinz bodies, 417
Heparin, 69, 380
Heterophyes heterophyes, 123
 eggs, 131, 141, 163
 worms, 146
Hookworm *see* *Ancylostoma duodenale* and
 Necator americanus
Hot air oven, 37
Howell-Jolly bodies, 410
Hydatid scolex, 185
Hydrochloric acid, 0.1 mol/l, 377, 472
Hymenolepis diminuta, 123, 142
 eggs, 131, 141
Hymenolepis nana, 123, 142
 eggs, 125, 132, 140, 163
 worms, 145
Hypochromic cells, 409

I

- Inoculating loop, making, 232
Iodamoeba butschli, cysts, 158
 motile form, 148, 152
Isotonic saline *see* Sodium chloride, 8.5 g/l
 solution

J

- Jenner stain *see* Stain, Jenner

K

- Kala-azar, blood test, 462
Ketone bodies in urine, 320-321
Kinyoun carbol fuchsin, 257, 472

L

- Laboratory apparatus and equipment, 27,
 104-107
Laboratory glassware, 27
 cleaning, 29
 making, 64
Laboratory plans, 102-103
Laboratory registers, examples, 78-83
Lactophenol cotton blue mounting solution,
 300, 473
Lee and White method for whole blood
 coagulation time, 423-424
Leishman stain *see* Stain, Leishman
Leishmania donovani, 462
Leprosy, 259-264
Leptospira icterohaemorrhagiae, in urine, 182
Leptospirosis, 182
Leukocyte count *see* Leukocyte number
 concentration
Leukocyte number concentration, 9, 360-365
Leukocyte type number fraction, 8, 9, 193,
 343, 397-398
Leukocytes, 351
 counting, 363, 405-406
 examination, 398-404
 in cerebrospinal fluid, 342
 in stools, 160
 in urinary deposits, 327
Leukocytosis, 364
Leukopenia, 364
Loa loa, 212, 214
Loeffler culture medium, 271, 273
Lovibond comparator, 61
Lugol iodine solution, 116, 147, 155, 165,
 173, 316, 473
Lugol iodine test, 316
Lymphocytes, 401-402, 404
Lymphocytosis, 406
Lysis time of blood clots, 426

M

- Macrocytes, 409
- Malaria parasites, 196-203
 - blood film preparation, 196
 - thick films, 189-192
 - thin films, 387-390
 - density, 198, 203
 - developmental stages, 197
 - in donor blood, 462
 - geographical distribution, 199
 - recognition features, 200-202
- Mansonella ozzardi*, 213, 214
- May-Grünwald stain *see* Stain, May-Grünwald
- McArthur microscope, 26
- Mean corpuscular haemoglobin concentration *see* Mean erythrocyte haemoglobin concentration
- Mean erythrocyte haemoglobin concentration, 10, 386
- Megakaryocytes, 404
- Meningitis, 339, 344, 347-349, 429
- Meningococci, 239
 - in cerebrospinal fluid, 346
- Metagonimus yokogawai*, 123
 - eggs, 132, 141, 163
 - worms, 146
- Methylene blue, aqueous, 249, 253, 257, 473
 - modified, 259
- Microcytes, 409
- Microfilariae, blood, concentration, 207-208
 - recognition features, 210-214
 - species, 212-214
 - staining, 209
 - time of day for specimen collection, 204
 - wet preparation, 204-206
- eye, 219
- in glandular fluid, 230
- skin, 215-219
- in urine, 181-182
- Microhaematocrit centrifuge, 208, 224, 379-383
- Microscope, 19-26
 - adjustment system, 17
 - illumination system, 16
 - magnification system, 14
 - object focusing, 21
 - precautions in use, 24
 - routine maintenance, 23
 - setting up, 18
 - support system, 13
- Microscope slides, cleaning, 31
- MIF solution, 73, 165, 173, 473
- MIF stool concentration technique, 162, 167
- Moniliasis, 272
- Monocytes, 402
 - in malaria, 202
- Monocytosis, 406
- Monthly report, example of, 84

- Motile forms of protozoa in stools, 147-154
 - microscopical appearance, 150-154
 - recognition features, 149
 - slide examination, 147
- Mycelium filaments, in genitourinary discharge, 188
- Mycobacterium leprae*, 259
- Mycobacterium tuberculosis*, 249, 253

N

- Nasal smears, leprosy bacilli in, 264
- Necator americanus*, 123, 142
 - eggs, 125, 132, 140, 163
 - worms, 146
- Needles, 105, 226, 265
 - cleaning, 32
 - sterilization, 34
 - VDRL test, for, 288, 294
 - venepuncture, 353
- Neisseria gonorrhoeae*, 243
- Neubauer ruled chamber for blood cell counts, 363, 368
- Neutropenia, 406
- Neutrophilia, 406
- Neutrophils, polymorphonuclear, 400
- Normoblasts, 364, 403, 408

O

- Onchocerca volvulus*, 215
 - in urine, 181
 - recognition features, 218
- Onchocerciasis, 215-219
- Opisthorchis felinus*, 123
 - eggs, 133, 141, 163
 - worms, 146
- Orthotoluidine method for glucose estimation, 429-431
- Orthotoluidine reagent, 429, 471
- Ova *see* Eggs
- Oxyuris* *see* *Enterobius vermicularis*

P

- Packed cell volume *see* Erythrocyte volume fraction
- Pandy reagent, 346, 474
- Pandy test for globulin in CSF, 346
- Paragonimus westermani*, 123
 - eggs, 125, 133, 141, 163, 183-184
- Parasites, 111
 - concentration in stools, 162
 - in urine, 178-182
 - see also specific organisms*
- Pasteurella pestis* *see* *Yersinia pestis*
- Peripheral laboratory, equipment of, 104-107
 - plan, 102-103
- pH determination of urine, 309-310
 - of water, 60, 61-63
- Pinta, 288
- Pinworm *see* *Enterobius vermicularis*
- Pipettes, 43
 - cleaning of, 30
 - dropping, 46
 - Pasteur, 64, 246
- Pityriasis versicolor, direct examination, 297-299
- Pityrosporum furfur*, 297
- Plague, 265-267
- Plasma, blood, 352
- Plasma cells, 402
- Plasmodium*, 199-202
- Platelets *see* Thrombocytes
- Plumbing, simple procedures, 94-97
- Poikilocytes, 409
- Poisoning, 100
- Polymorphonuclear cells, 400-401, 403
- Poly(vinyl alcohol), 73, 173, 174
- Potassium hydroxide, 200 g/l, 300, 474
- Pregnancy tests, 336
- Pressure cooker for sterilization, 36
- Protein, in cerebrospinal fluid, 345-346
 - in urine, 313-315
- Protozoa, 113, 142
 - cysts, 155-159, 165
 - motile forms, 147-161
 - see also specific organisms*
- Pus, in stools, 161
 - urethral, 71, 243-245
- PVA *see* poly(vinyl alcohol)

Q

- Quantities, names for, 7-10

R

- Reagents, preparation, 465-477
- Record forms and registers, 79-83
 - blood chemistry, 79
 - blood donor, 82
 - blood transfusion, 80-81
 - cerebrospinal fluid, 80-81
 - haematology, 79
 - parasitology, 83
 - serology, 83
 - urine analysis, 80-81
- Red blood cells *see* Erythrocytes
- Red cell count *see* Erythrocyte number concentration
- Registers, 78-83
- Reports, bacteriological examination, 242
 - monthly, laboratory, 84
 - stool examination, 172
- Reticulocyte count *see* Reticulocyte number concentration *and* Reticulocyte number fraction
- Reticulocyte number concentration, 9, 416
- Reticulocyte number fraction, 9, 416
- Reticulocytes, 414-417
- Rhesus grouping of blood, 435-436
 - slide method, 448-450
 - test-tube method, 451-463
- Ringworm *see* Tinea
- River blindness *see* Onchocerciasis
- Romanowsky stain *see* Stain, Romanowsky
- Rouleau formation, 442, 450, 455
- Roundworm *see* *Ascaris lumbricoides*

S

- Safranine solution, 235, 244, 474
- Salmonella*, 268
- Saprophytes, 238, 239, 241, 244
- Schistosoma bovis*, 123, 142
 - eggs, 133, 163
 - worms, 146
- Schistosoma haematobium*, 123, 142
 - eggs, 125, 134, 140, 163, 178-180, 332
 - worms, 146
- Schistosoma intercalatum*, 123, 142
 - eggs, 134, 141, 163
 - worms, 146
- Schistosoma japonicum*, 123, 142
 - eggs, 125, 135, 141, 163
 - worms, 146
- Schistosoma mansoni*, 123, 142
 - eggs, 122, 125, 135, 140, 163, 180
 - worms, 146

Schizont, 197, 200-201
Serum, blood, 352
 collection, 285-286
 colour in donor blood, 457
 dispatch, 286
 preservation, 286
Shigella, 268
Sickle cells, 408, 411-413
Silver nitrate, 17 g/l solution, 58, 474
Similium, 215
SI units, 6-10
Skin lesions, leprosy bacilli in, 259-262
Sleeping sickness see *Trypanosomiasis*, African
Smears, for bacteriological examination, fixation, 233-234
 preparation, 232-233
 staining, 234
Sodium carbonate, 98, 474
Sodium chloride, 8.5 g/l solution, 116, 121, 147, 155, 165, 186, 204, 209, 215, 220, 226, 264, 265, 288, 437, 453, 463, 474
Sodium hydroxide, 30 g/l aqueous solution, 183, 474
 100 g/l aqueous solution, 178, 474
Sodium metabisulfite, 20 g/l aqueous solution, 411, 475
Sodium nitroprusside see *Sodium pentacyanonitrosylferrate(2-)*
Sodium pentacyanonitrosylferrate(2-), 320
Sodium thiosulfate, 30 g/l aqueous solution, 279, 475
Specific gravity of urine, 307-308
Specimens, dispatch, 71-73
 disposal, 39-41
 packing, 74
 registration, 78
Spermatozoa, in urinary deposits, 329
Spherocytes, 409
Spirochaetes, 182, 241, 246-248, 272
Sputum, collection, 254
 dispatch, 71, 255
 eggs in, 183-184
 smear preparation, 249-251
 tubercle bacilli in, 249
Stab cells, 400
Stain, Field A and B, 191, 196, 222, 390, 395
 Giemsa, 191, 193-195, 196, 207, 209, 218, 222, 230, 241, 390, 393
 Gram, 235-237, 238, 242, 244, 270, 275, 348
 Jensen, 391
 Kinyoun, 257-258
 Leishman, 391
 May-Grünwald, 193, 390, 393
 Romanowsky, 391
 Wayson, 265-267
 Wright, 391
 Ziehl-Neelsen, 238, 242, 249, 253, 259, 262, 264, 275, 349
Staphylococci, 239
Sterilization, 33-38
Stirring rod, making, 66
Stools, collection, 114
 concentration of parasites in, 162-169

Stools, (continued)
 dispatch, 72-73, 173-174, 268-269
 examination, 113, 170-172
 occult blood in, 175-177
 protozoa in, 147-161
 worms, adult, in, 143-146
 eggs, in, 122-141
Streptococci, 239
Strongyloides stercoralis, 123, 142
 eggs, 125, 136, 141
 larvae, 136, 140, 163, 168-169
Stuart transport medium, modified, 246, 273, 350, 475
Sulfosalicylic acid, 30 g/l aqueous solution, 345, 475
 300 g/l aqueous solution, 313, 475
Supplies, inventory, 85
 ordering, 86
 storage, 85
Swabs, preparation, 274
Syphilis, 246-248, 287, 288
Syringes, 105
 sterilization, 34

T

Taenia saginata, 123, 142
 eggs, 125, 137, 140, 163
 worms, 144, 145
Taenia solium, 123, 142
 eggs, 125, 137, 140, 163
 worms, 144, 145
Tapeworm, beef see *Taenia saginata*
 dog see *Dipylidium caninum*
 dwarf see *Hymenolepis nana*
 fish see *Diphyllobothrium latum*
 pork see *Taenia solium*
 rat see *Hymenolepis diminuta*
Target cells, 408, 413
Tetanus bacilli, 239
Thiosemicarbazide reagent, 432, 476
Threadworm see *Strongyloides stercoralis*
Throat specimens, dispatch, 71, 273
 examination, 270-272
 swab preparation, 274
Thrombocyte count see *Thrombocyte number concentration*
Thrombocyte number concentration, 9, 351
Thrombocytes (platelets), 203, 351, 398, 426
Thrush, 272
Tinea, direct examination, 300-302
Transgrow transport medium, 71, 245, 273, 350
Transport media, for cerebrospinal fluid, 350
 for gonococci, 245-246
 for sputum, 255
 for stools, 268-269
 for throat specimens, 273

Treponema pallidum, 246, 462
Treponema pertenuis, 246
Treponema vincentii, 241, 272
Trichomonas hominis, motile form, 148, 153
Trichomonas vaginalis, in genitourinary discharge, 186-187
 in urinary deposits, 329
 in urine, 181
Trichostrongylus, 123, 142
 eggs, 137, 141
Trichuris trichiura, 123, 142
 eggs, 125, 137, 140
 worms, 146
Trichloroacetic acid, 30 g/l, 429, 471
 100 g/l, 432, 476
Trisodium citrate, 20 g/l aqueous solution, 207, 208, 475
 38 g/l aqueous solution, 69, 72, 352, 418, 438, 475
Trophozoite, 197, 200-201
Trypanosoma cruzi, 225, 462
Trypanosoma gambiense, 222
Trypanosoma rangeli, 225
Trypanosoma rhodesiense, 222
Trypanosomes, in blood, 220-224, 287, 462
 in cerebrospinal fluid, 347
 in lymph node fluid, 226-230
 recognition features, 221, 222, 225, 229, 230
Trypanosomiasis, African, 220, 226
 South American, 220, 225
Tsetse fly *see Glossina*
Tuberculosis, 231, 249-258
Türk solution, 342, 360, 476

U

Urea estimation, 432-434
Urea reagents, 432, 476
Urethral pus, dispatch of specimens, 71, 245
 examination, 243
Urinary deposits, casts in, 330-332
 crystals in, 332-335
 microscopical appearance, 327-335
 preparation, 326
Urine, analysis register, 80
 appearance, 306
 bile pigments in, 316-318
 blood in, 337
 collection, 275, 305
 cultures of, 278
 direct bacterial examination, 275-277
 glucose in, 311-312, 323
 indicator papers for examination, 323-324
 ketone substances in, 320-322, 324
 parasites in, 178-182

Urine, (continued)
 pH, 309-310
 pregnancy tests, 336
 protein in, 313-315, 323
 specific gravity, 307-308
 tubercle bacilli in, 277
 urobilinogen in, 319, 324
Urobilinogen, 319, 324

V

VDRL test, 248, 288
 buffer solution, 289, 467
 preparation of antigen suspension, 288
 qualitative, 291-293
 quantitative, 294-296
Venepuncture, 353-358, 458-461
Vincent's angina, 241, 272
Volume, measurement of, 42-47

W

Wash bottle, making, 67
Water, buffered, 61-63, 468
 clean, 56
 demineralized, 59
 distilled, 57
 for laboratory use, 56
 pH of, 58, 60, 61-63
 sampling for analysis, 279-284
Whipworm *see Trichuris trichiura*
White blood cells *see Leukocytes*
White cell count *see Leukocyte number*
 concentration
Willis concentration technique, 162, 163-164
Willis solution, 163, 477
Wintrobe mixture, 352, 383, 477
Worms, adult, in stools, 143-146
 see also Eggs
Wright stain *see Stain, Wright*
Wuchereria bancrofti, 212, 214
 in urinary deposits, 332
 in urine, 181

X

Xanthochromia, 342

Y

Yaws, 246, 247, 287, 288

Yeasts, 240

in genitourinary discharge, 188

in stools, 160

in urinary deposits, 328

Yersinia pestis, 265, 267

Z

Zenker fixative, 73, 75, 477

WHO publications may be obtained, direct or through booksellers, from:

- ALGERIA:** Societe Nationale d'Edition et de Diffusion, J. bd Zirout Youcef, ALGERIA
- ARGENTINA:** Carlos Hirsch SRL, Florida 165, Galerias Güemes, Escribano 453/465, BUENOS AIRES
- AUSTRALIA:** Mail Order Sales, Australian Government Publishing Service, P.O. Box 14, CANBERRA A.C.T. 2600; or over the counter from Australian Government Publishing Service Bookshops, at: 70 Alinga Street, CANBERRA CITY A.C.T. 2600, 294 Adelaide Street, BRISBANE, Queensland 4000; 347 Swanston Street, MELBOURNE, VIC 3000; 309 Pitt Street, SYDNEY, N.S.W. 2000; Mt Newman House, 200 St. George's Terrace, PERTH, WA 6000; Industry House, 12 Pirie Street, ADELAIDE, SA 5000; 156-162 Macquarie Street, HOBART, TAS 7000 — Hunter Publications, 584 Gipps Street, COLLINGWOOD, VIC 3066
- AUSTRIA:** Gerold & Co., Graben 31, 1011 VIENNA 1
- BANGLADESH:** The WHO Programme Coordinator, G.P.O. Box 250, Dacca 5 — The Association of Voluntary Agencies, P.O. Box 5045, Dacca 5
- BELGIUM:** Office International de Librairie, 30 avenue Maraix, 1050 BRUSSELS — *Subscriptions to World Health Unit:* Jean de Lannoy, 202 avenue du Roi, 1060 BRUSSELS
- BRAZIL:** Biblioteca Regional de Medicina OMS/OPS, Unidade de Venda de Publicações, Caixa Postal 20.381, Vila Clementino, 04023 São Paulo, S.P.
- BRITAIN:** see India, WHO Regional Office
- CANADA:** Single and bulk copies of individual publications (not subscriptions): Canadian Public Health Association, 1335 Carling Avenue, Suite 210, OTTAWA, Ont. K1Z 8N8. *Subscriptions:* Subscription orders, accompanied by cheque made out to the Royal Bank of Canada, OTTAWA, Account World Health Organization, should be sent to the World Health Organization, P.O. Box 1800, Postal Station B, OTTAWA, Ont. K1P 5R5. *Correspondence concerning subscriptions should be addressed to the World Health Organization, Distribution and Sales, 1211 Geneva 27, Switzerland*
- CHINA:** China National Publications Import Corporation, P.O. Box 88, BEIJING (PEKING)
- COLOMBIA:** Distribibros Ltd. Pio Alfonso Garcia, Carrera 4a. Nos 36-119, CARTAGENA
- CYPRUS:** Publishers Distributors Cyprus, 30 Demokratias Ave Ayios Dhometios, P.O. Box 4165, NIKOSIA
- CZECHOSLOVAKIA:** Arta, Ve Smeckach 30, 11127 PRAGUE 1
- DENMARK:** Munkegaard Ltd, Nørregade 6, 1165 COPENHAGEN K
- Ecuador:** Libreria Cientifica S.A., P.O. Box 362, Luján 223, GUAYAQUIL
- EGYPT:** Nahaa El Fikr Bookshop, 55 Saad Zaghloul Street, ALEXANDRIA
- EL SALVADOR:** Libreria Estudiantil, Edificio Comercial B No 3, Avenida Libertad, SAN SALVADOR
- FINLAND:** The WHO Programme Coordinator, P.O. Box 113, SLVA
- FINLAND:** Akateeminen Kirjakauppa, Keskuskatu 2, 00101 HELSINKI 10
- FRANCE:** Librairie Arnette, 2 rue Casimir-Delavigne, 75006 PARIS
- GERMAN DEMOCRATIC REPUBLIC:** Buchhaus Leipzig, Postfach 1-40, 701 LEIPZIG
- GERMANY, FEDERAL REPUBLIC OF:** Govi-Verlag GmbH, Ginnheimstrasse 20, Postfach 5360, 6236 ESCHENAU — W. E. Saarbach, Postfach 101610, Follerstrasse 2, 5000 KÖLN 1 — Alex. Horn, Spiegelgasse 9, Postfach 3340, 6200 WIESBADEN
- GHANA:** Fides Enterprises, P.O. Box 1628, ACCRA
- GREECE:** G. C. Eleftheroudakis S.A., Librairie internationale, rue Nikis 4, ATHENS (T. 126)
- HAITI:** Max Bouchereau, Librairie "A la Caravelle", Boite postale 111-B, PORT-AU-PRINCE
- HONG KONG:** Hong Kong Government Information Services, Beaconsfield House, 6th Floor, Queen's Road, Central, VICTORIA
- HUNGARY:** Kultura, P.O. B. 149, BUDAPEST 62 — Akadémiai Könyvesbolt, Váci utca 22, BUDAPEST V
- ICELAND:** Snaebjörn Jónsson & Co., P.O. Box 1131, Hafnarstræti 9, REYKJAVIK
- INDIA:** WHO Regional Office for South-East Asia, World Health House, Indraprastha Estate, Ring Road, NEW DELHI 110002 — Oxford Book & Stationery Co., Scindia House, NEW DELHI 110001; 17 Park Street, CALCUTTA 700016 (*Sub-agent*)
- INDONESIA:** M/s Kalmun Book Service Ltd, Jln. Cikini Raya No. 63, P.O. Box 3105/JKI, JAKARTA
- IRAN:** Iranian Amalgamated Distribution Agency, 151 Khiaban Soraya, TEHRAN
- IRAQ:** Ministry of Information, National House for Publishing, Distributing and Advertising, BAGHDAD
- IRELAND:** The Stationery Office, DUBLIN 4
- ISRAEL:** Heiliger & Co., 3 Nathan Strauss Street, JERUSALEM
- ITALY:** Edizioni Minerva Medica, Corso Bramante 83-85, 10126 TORINO; Via Lamarmora 3, 20100 MILAN
- JAPAN:** Maruzen Co. Ltd, P.O. Box 5050, TOKYO International, 100-31
- KOREA, REPUBLIC OF:** The WHO Programme Coordinator, Central P.O. Box 540, SEOUL
- KUWAIT:** The Kuwait Bookshops Co. Ltd, Thunayan Al-Ghanem Bldg, P.O. Box 2942, KUWAIT
- LAO PEOPLE'S DEMOCRATIC REPUBLIC:** The WHO Programme Coordinator, P.O. Box 343, VIENTIANE
- LEBANON:** The Levant Distributors Co. S.A.R.L., Box 1181, Makdassi Street, Hanna Bldg, BEIRUT
- LUXEMBOURG:** Librairie du Centre, 49 bd Royal, LUXEMBOURG
- MALAWI:** Malawi Book Service, P.O. Box 30044, (Nchitu), BLANTYRE 3
- MALAYSIA:** The WHO Programme Coordinator, Room 1004, Fitzpatrick Building, Jalan Raja Chulan, KUALA LUMPUR 05-02 — Jubilee (Book) Store Ltd, 97 Jalan Tuanku Abdul Rahman, P.O. Box 629, KUALA LUMPUR 01-08 — Parry's Book Centre, K. L. Hilton Hotel, Jln. Treacher, P.O. Box 960, KUALA LUMPUR
- MEXICO:** La Prensa Médica Mexicana, Ediciones Científicas, Paseo de las Facultades 26, Apt. Postal 20-413, MEXICO CITY 20, D.F.
- MONGOLIA:** see India, WHO Regional Office
- MOROCCO:** Editions La Porte, 281 avenue Mohammed V, RABAT
- MOZAMBIQUE:** INLD, Caixa Postal 4030, MAPUTO
- NEPAL:** see India, WHO Regional Office
- NETHERLANDS:** N. V. Martinus Nijhoff's Boekhandel en Uitgeverij Maatschappij, Lange Voorhout 9, THE HAGUE 2000
- NEW ZEALAND:** Government Printing Office, Mulgrave Street, Private Bag, WELLINGTON 1 — *Government Bookshops at:* Rutland Street, P.O. 5344, AUCKLAND; 130 Oxford Terrace, P.O. Box 1721, CHRISTCHURCH; Alma Street, P.O. Box 857, HAMILTON; Princes Street, P.O. Box 1104, DUNEDIN — R. Hill & Son, Ltd, Ideal House, Car Gihes Avenue & Eden St., Newmarket, AUCKLAND 1
- NIGERIA:** University Bookshop Nigeria Ltd, University of Ibadan, IBADAN — G. O. Oduwa Publishers & Booksellers Co., 9 Benin Road, Okinwa Junction, SAFELE, BENDEL STATE
- NORWAY:** J. G. Tanum A/S, P.O. Box 1177 Sentrum, OSLO 1
- PAKISTAN:** Mirza Book Agency, 65 Shahrah-E-Quaid-E-Azam, P.O. Box 729, LAHORE 1
- PAPUA NEW GUINEA:** The WHO Programme Coordinator P.O. Box 5896, BOROBU
- PHILIPPINES:** World Health Organization, Regional Office for the Western Pacific, P.O. Box 2932, MANILA — The Modern Book Company Inc., P.O. Box 632, 926 Rizal Avenue, MANILA
- POLAND:** Składnica Księgarska, ul. Mazowiecka 9, 00052 WARSAW (*except periodicals*) — BKWZ Ruch, ul. Wrona 23, 00840 WARSAW (*periodicals only*)
- PORTUGAL:** Livraria Rodrigues, 186 Rua do Ouro, LISBON 2
- SIERRA LEONE:** Sierra University College Bookshop (University of Sierra Leone), Private Mail Bag, FREETOWN
- SINGAPORE:** The WHO Programme Coordinator, 144 Moulmein Road, G.P.O. Box 3457, SINGAPORE 1 — Select Books (Pte) Ltd, 215 Tanglin Shopping Centre, 2/F, 19 Tanglin Road, SINGAPORE 10
- SOUTH AFRICA:** Van Schaik's Bookstore (Pty) Ltd, P.O. Box 224, 268 Church Street, PRETORIA 0001
- SPAIN:** Comercial Athenium S.A., Consejo de Ciéncia 131-136, BARCELONA 15; General Moscardó 29, MADRID 20 — Libreria Diaz de Santos, Lagasca 95, MADRID 6; Balmes 417 y 419, BARCELONA 6
- SRI LANKA:** see India, WHO Regional Office
- SWEDEN:** Aktebolaget C. E. Fritzes Kungl. Hovbokhandel, Regeringsgatan 12, 10327 STOCKHOLM
- SWITZERLAND:** Medizinischer Verlag Hans Huber, Länggass Strasse 76, 3012 BERN 9
- SYRIAN ARAB REPUBLIC:** M. Farras Kekhia, P.O. Box No. 5221, ALEPPO
- THAILAND:** see India, WHO Regional Office
- TUNISIA:** Société Tunisienne de Diffusion, 5 avenue de Carthage, TUNIS
- TURKEY:** Haset Kitapevi, 469 Istiklal Caddesi, Beyoğlu, ISTANBUL
- UNITED KINGDOM:** H.M. Stationery Office, 49 High Holborn, LONDON WC1Y 6HB; 13a Castle Street, EDINBURGH EH2 3AR; 41 The Hayes, CARDIFF CF1 1JW; 80 Chichester Street, BELFAST BT1 4JY; Brazenose Street, MANCHESTER M60 6AS; 258 Broad Street, BIRMINGHAM B1 2HE; Southey House, Wine Street, BRISTOL BS1 2BQ. *All mail orders should be sent to P.O. Box 569, LONDON SE1 9NH*
- UNITED STATES OF AMERICA:** Single and bulk copies of individual publications (not subscriptions): WHO Publications Centre USA, 49 Sheridan Avenue, ALBANY, N.Y. 12210. *Subscriptions:* Subscription orders, accompanied by check made out to the Chemical Bank, New York, Account World Health Organization, should be sent to the World Health Organization, P.O. Box 5284, Church Street Station, New York, N.Y. 10249. *Correspondence concerning subscriptions should be addressed to the World Health Organization, Distribution and Sales, 1211 Geneva 27, Switzerland. Publications are also available from the United Nations Bookshop, NEW YORK, N.Y. 10017 (retail only)*
- USSR:** For readers in the USSR requiring Russian editions: Kumsomolskiy prospekt 18, Medicinskaja Kniga, Moscow — For readers outside the USSR requiring Russian editions: Kuzneckij most 18, Mezdunarodnaja Kniga, Moscow G-200
- VENEZUELA:** Editorial Interamericana de Venezuela C.A., Apartado 30.785, CARACAS 105 — Libreria del Este, Apartado 60.337, CARACAS 106 — Libreria Médica Paris, Apartado 60.681, CARACAS 106
- YUGOSLAVIA:** Jugoslavenska Knjiga, Terzije 27/II, 11000 BELGRADE
- ZAMBIA:** Librairie universitaire, avenue de la Paix No 167, B.P. 1682, KREMSHA 1

Special terms for developing countries are obtainable on application to the WHO Programme Coordinators or WHO Regional Offices listed above or to the World Health Organization, Distribution and Sales Service, 1211 Geneva 27, Switzerland. Orders from countries where sales agents have not yet been appointed may also be sent to the Geneva address, but must be paid for in pounds sterling, US dollars, or Swiss francs.

Price: Sw. fr.30.—

Prices are subject to change without notice.

C/1/80