

# Latitude & Temperature

Subject: LM-1) Introduction:

- latitude & temperature:

After the PS it would be desirable to easily determine with common items your Latitude, predict average seasonal temperatures, and measure the cloud density-clearing rate. It may be that one has lost track of days and now wishes to know what the earth is telling us the seasons are. Assume for now there are no dip needles available and one does not know how to make one (a subject for another time).

All of this can be determined by measuring the length of daylight for the longest and/or shortest day or any two days of the year. The longest days will occur when the earth is tilted such that you are closest to the equator and will tell you the first day of summer 21 Jun. The shortest days occur when the earth is tilted away from the equator and give the first day of winter 21 Dec.

The readings can be taken with a normal watch, or clock (described later) or can be taken semi-automatically by building a simple circuit. Once the readings are taken one need only use some simple graphs to calculate Latitude, predict seasonal temperatures, and if needed determine what season of the year one is currently at.

I have been working this project for a number years and it will take seven separate posting to fully explain it. I have attempted to make it as simple to use as I can. Print it out and use it as an after PS reference document. You may want to build the circuit below before the PS and test it out.

The following E-mail posts will make up this subject:

(LM = Light Measurements)

LM-1) Introduction

LM-2) Photocell measurements:

LM-3) Results of measurements part1:

LM-4) Results of measurements part2: Graphs to use

LM-5) Results of measurements part3: Formula to use

LM-6) Light meter construction and use:

LM-7) Temperature, precipitation versus latitude:

-----

Subject: LM-2) Photocell measurements:

Several years ago I built the following circuit and begin taking measurements. See PhotoCell.gif. The circuit was designed to measure the duration of night and daylight over the last 24 hrs. It works by turning on a normal old AC-house clock during daylight and then turning it off at night.

## Latitude & Temperature

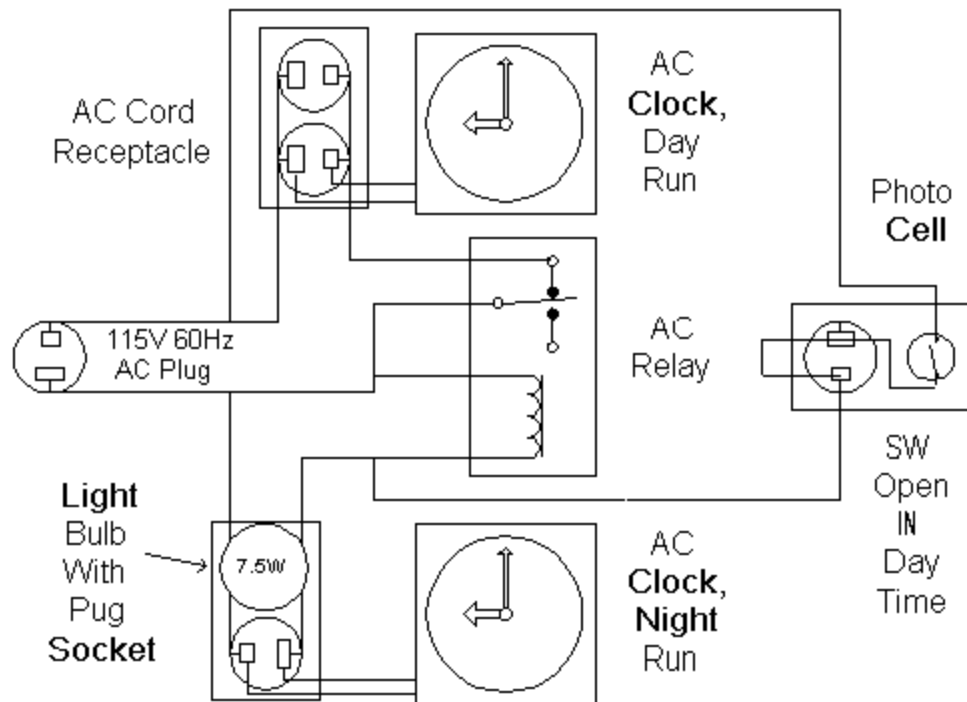

PhotoCell.vsd - (2 Sep 01)

List of parts needed: (includes description of its use)

Quantity-1 AC-Relay: I used DPDT Radio Shack PN 275-217C \$7.99. It is a 125v AC 15amp Plug-in Relay. Almost any AC normally closed Relay will work. Only need to solder wires one side of this unit. At this low power usage after several years of running 24 hours/day the contacts are not a bit burnt. At the time of transition between night to day or day to night the relay chatters and sounds like a buzzer. This goes on for several minutes (2 minutes 6.6 sec on the average) and can be used as a reminder once a day to reset the clocks and take the readings to mark them on a list.

Quantity-2 AC-house clocks (typically old alarm clocks): One measure daylight and the other measure dark time. Both are reset to 12:00 once a day. The clock that measures the length of nighttime is really not needed. I used it to determine how accurate my measurements were. I found as an average 2 minutes 6.6 sec of buzz or dead time where neither clock were running (for some 270 readings).

Quantity-1 Photo Cell: I adapted an Indoor photocell lamp plug-in unit from Home Depot about \$6.00. It is sold as a 300-watt automatic light control to turn off incandescent lights at dawn and on at dusk. It's a rectangular box 2.25" by 1.5" by 1.25" with a plug on one side and a receptacle on the other side. It's designed to plug into the wall and measure the ambient light. Once it goes dark it turns on allowing AC to flow through to the receptacle socket on it. I wired it so as to jumper over the output receptacle. Cut off an extension-cord-plug and wind both wires together so the plug becomes a short circuit. This is then plugged into the photocell. I taped the photocell to the end of a stick of wood and mounded it on the roof (on top of my TV antenna). Place your photocell as high as you can and in a position so as to not be obstructed by a big barrier in the east-west direction. Two wires run into my house through a crack in a window. I used silicon rubber caulking to seal the unit before putting it in the weather. I also placed a thin

## Latitude & Temperature

white opaque plastic (type used in light tables) as a diffuser over the photocell sensor to help defuse light coming in from an angle so the unit could be facing up and still work for sun rise and sun set.

Quantity-3 extension cords: Two short light lamp extension cords were cut up to provide the plug and two receptacles as shown in the diagram. A much longer extension cord was used to run to the roof and plug into the

photocell. The outdoor connections were sealed with silicon rubber. Practically no power is used so number 18 or 16 gauge wire is plenty big enough.

-----  
Subject: LM-3) Results of measurements:

I took 327 measurements over two years and plotted figure A1:  
PhotoC-A1.gif.

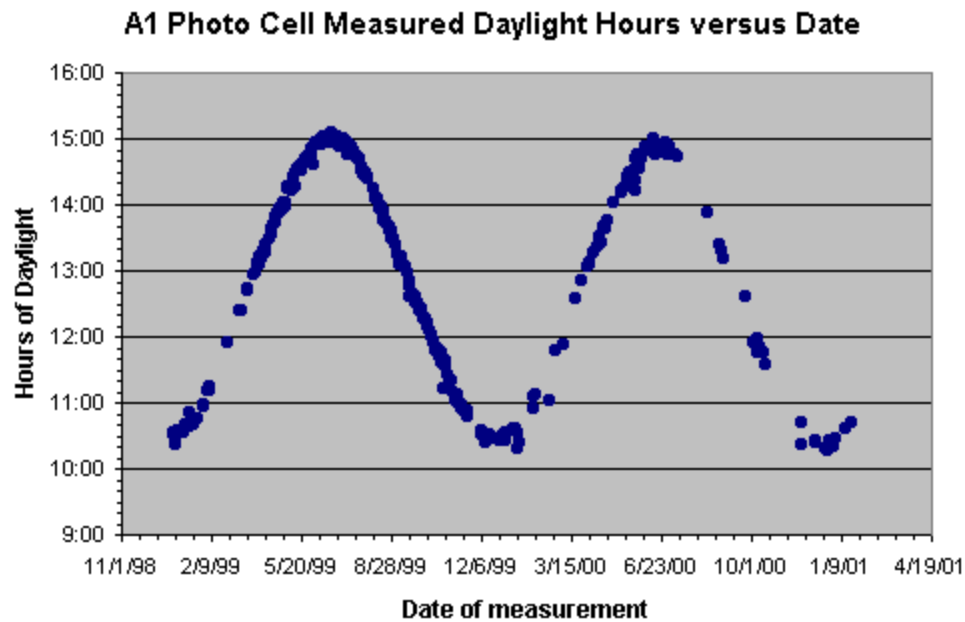

This is the typical sine wave, as one would expect, with the maximum daylight at 21 Jun and the minimum at 21 Dec for each year.

Now if the tilt of earth with time of year is factored in, the following plot of daylight hours versus latitude results:

# Latitude & Temperature

**A2 - Nautical and Astronomical Twilight compared to Photo Cell Measurements Taken At 32 Degrees Latitude [Jun 21 (left end) to Dec 21 (right end)]**

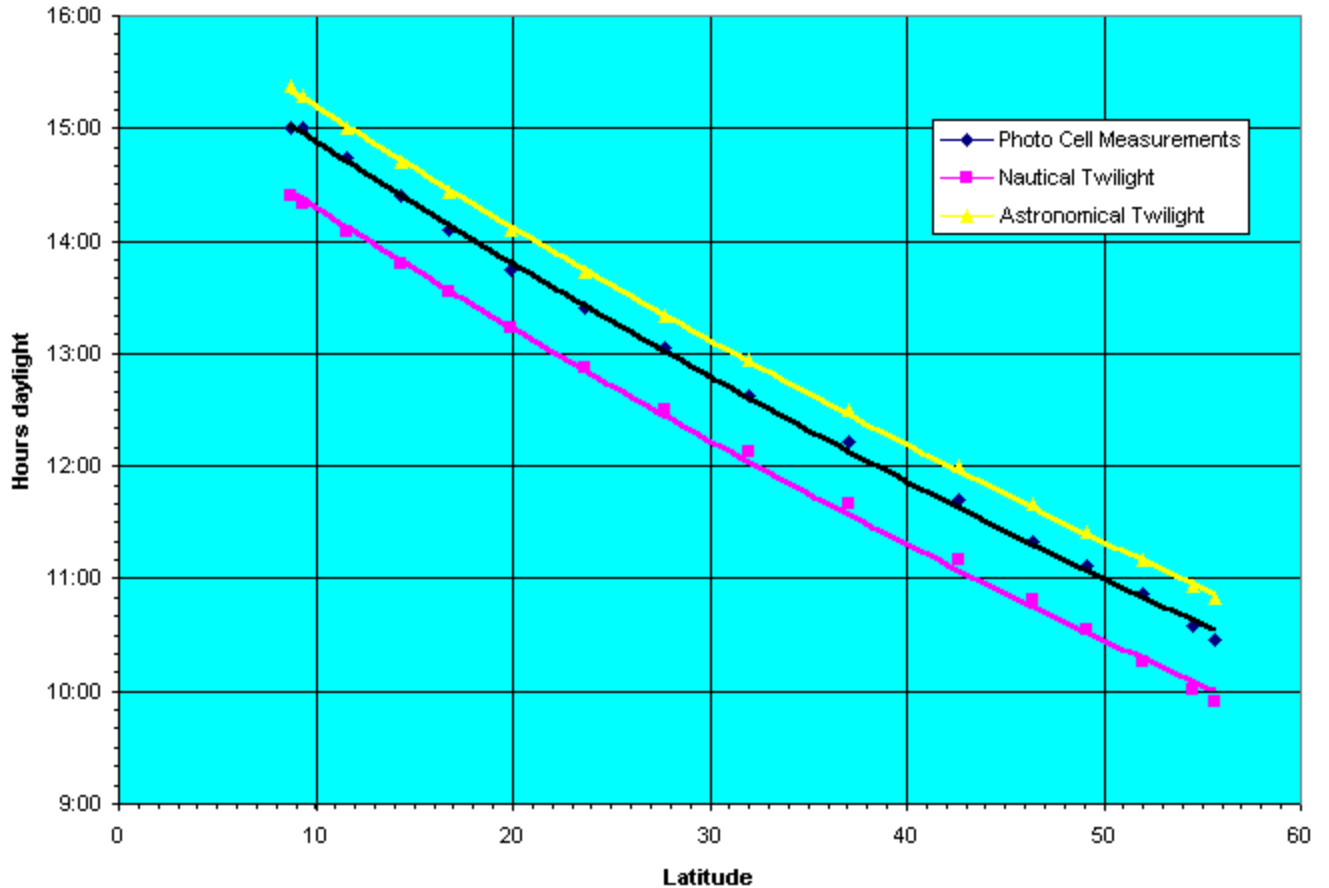

PhotoC-A2.gif. Latitude in this curve is "relative latitude" of sun's position (with respect to equatorial plane) and the current position of earth. What it is saying is that if measurements are taken at a fixed point of 32-degree latitude then there is a uniform almost straight-line relationship of daylight with respect to relative Latitude (tilt of earth).

The important point to get from this graph is that the photocell measurements on clear days occur uniformly a given percentage in this case 63.8% between Nautical and Astronomical Twilight. The photocell is measuring 63.8% of 18-12 degrees or 3.83 degrees from Nautical Twilight. Thus (12+3.83 =) 15.83 degrees below the horizon is what this photocell typically measures for a clear day. One degree is about 3.95 minutes or 236.7 seconds of time. The photocell typically measures 18-15.83= 2.17 degrees or 2.17\*3.95= 8.57 min before Astronomical Twilight.

Now I will digress a minute and pick up the definitions of these terms from the navy site [http://aa.usno.navy.mil/faq/docs/RST\\_defs.html](http://aa.usno.navy.mil/faq/docs/RST_defs.html)

Twilight: Before sunrise and again after sunset there are intervals of time, twilight, during which there is natural light provided by the upper atmosphere, which does receive direct sunlight and reflects part of it toward the Earth's surface.

## Latitude & Temperature

Nautical twilight is defined to begin in the morning, and to end in the evening, when the center of the sun is geometrically 12 degrees below the horizon. At the beginning or end of nautical twilight, under good atmospheric conditions and in the absence of other illumination, general outlines of ground objects may be distinguishable, but detailed outdoor operations are not possible, and the horizon is indistinct.

Astronomical twilight is defined to begin in the morning, and to end in the evening when the center of the Sun is geometrically 18 degrees below the horizon. Before the beginning of astronomical twilight in the morning and after the end of astronomical twilight in the evening the Sun does not contribute to sky illumination; for a considerable interval after the beginning of morning twilight and before the end of evening twilight, sky illumination is so faint that it is practically imperceptible.

I think what the above is saying in simple terms: Nautical twilight is good enough darkness to start taking reading of the sky for navigational purpose. Astronomical twilight is good enough darkness to start taking Astronomical sightings.

In my current location on a clear day it is total dark (between 1 and 2 LUX) above with faint hint of a glow on horizon occurs about 18-20 minutes after the photocell decides to switch. At the Photocell switching point looking up it is a dark blue on a clear day. There is still indirect light from the horizon that is lighting the soundings and to some extent the sky. The light illumination intensity of 28-38 LUX is on the average measured just after the photocell decides to switch when measuring sunset twilight. 28 LUX was measured near the beginning and now I get about 38 LUX. Must be acclimating dirt on it over the last several years. I typically measure about 140,000 LUX during an average clear day for maximum sun intensity. Thus when the intensity gets to about 1/5,000th to 1/3,000th of midday sun intensity then the photocell switches. 28 LUX is equivalent of 10 times less light as compared to being 5 ft under a two-bulb florescent 40-watt fixture. At this time of the day you see most street lights have turned on.

My measurements indicate that on a cloudy day as compared to a clear day (on an adjacent days) on the average the time is shortened by about 7 minutes (6 min 57 sec to be exact). If it is cloudy for both morning and night then this subtracts about 14 min from the day.

-----  
LM-4) Results of measurements part2: Graphs to use

The next task was to use what was learned from the previous measurements and bounce them against naval tables for Astronomical and Nautical twilight to result in a generalized set of plots that would have broad planet wide use. The maximum daylight (upper curves) and minimum (lower curves) daylight for an observer sitting at Greenwich and changing latitude were then plotted. This was done for Astronomical and Nautical Twilight-to-Twilight measuring daylight times only. See chart B1. PhotoC-B1.gif.

**B1) Nautical and Astronomical Twilight Max and Min Daylight Time During A Year**

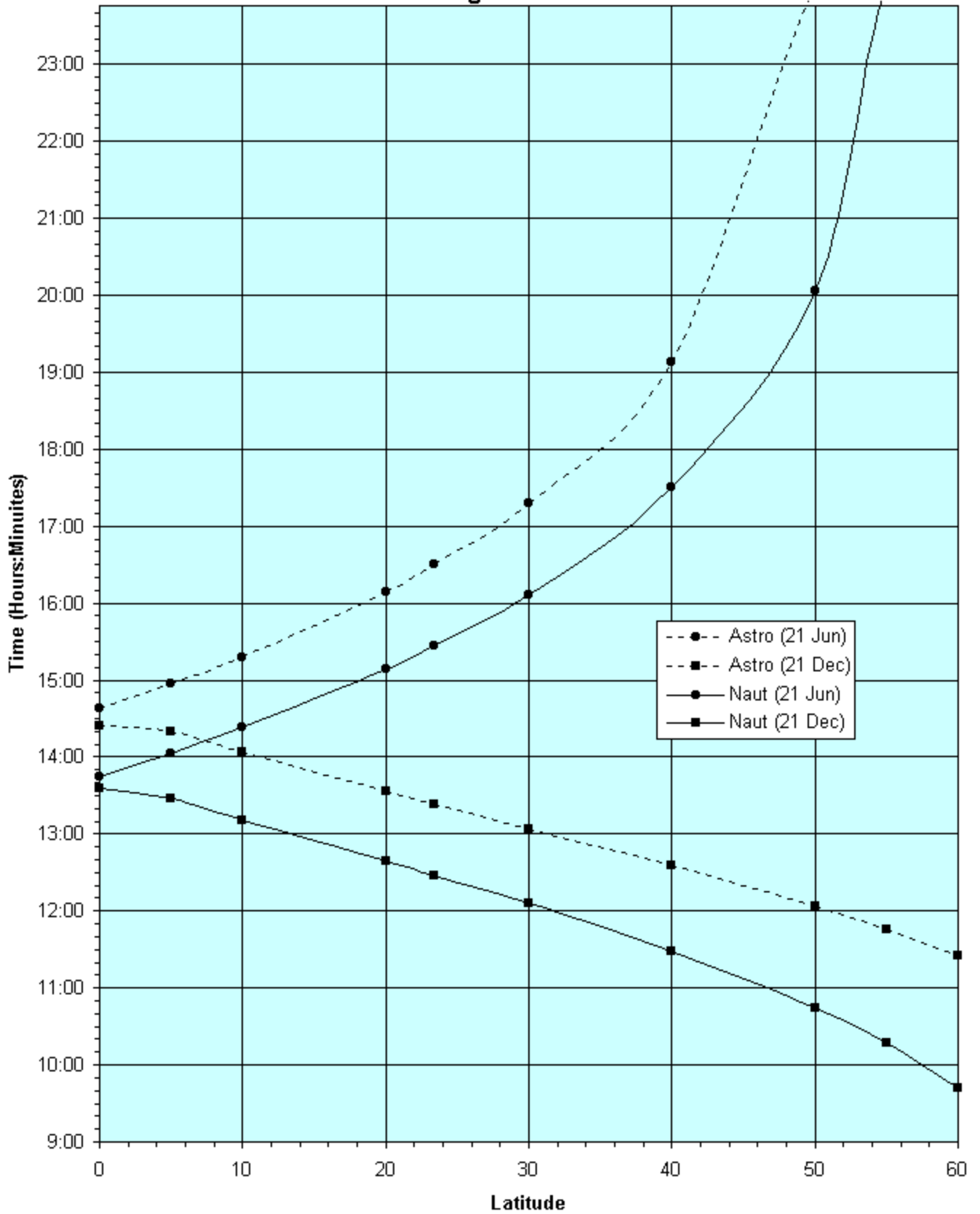

## Latitude & Temperature

Recall that the measured (63.8%) between Nautical and Astronomical Twilight was for clear days. If we shortened the day by making it always cloudy at the beginning and cloudy at the end then we take about 14 min off each daylight measurement. This result is equivalent to when the sun is about 14.06 degrees below the horizon. On Cloudy days one then calculates the predicted photocell results for full range of latitude we get the following results. See charts C1, C2, or C3 depending on how far north you end up. If you are close to the equator use plot C1 this will be easier to interpolate your measurements.  
<http://home1.gte.net/mikelob/PhotoC-C1.gif>.

# Latitude & Temperature

## C1) Photo Cell Measurements Max and Min Daylight Time During A Year

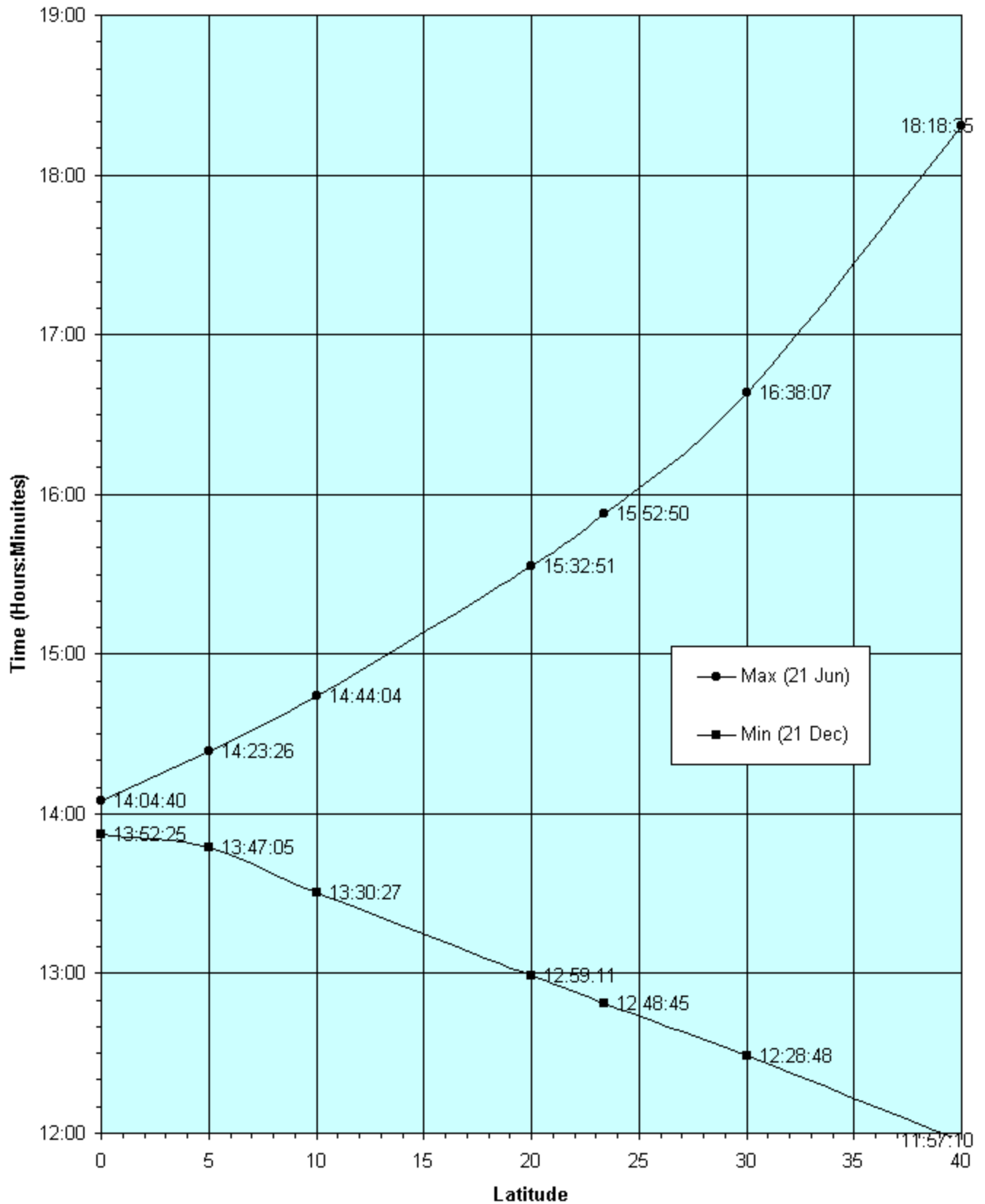



# Latitude & Temperature

<http://home1.gte.net/mikelob/PhotoC-C2.gif>.

# Latitude & Temperature

## C2) Photo Cell Measurements Max and Min Daylight Time During A Year

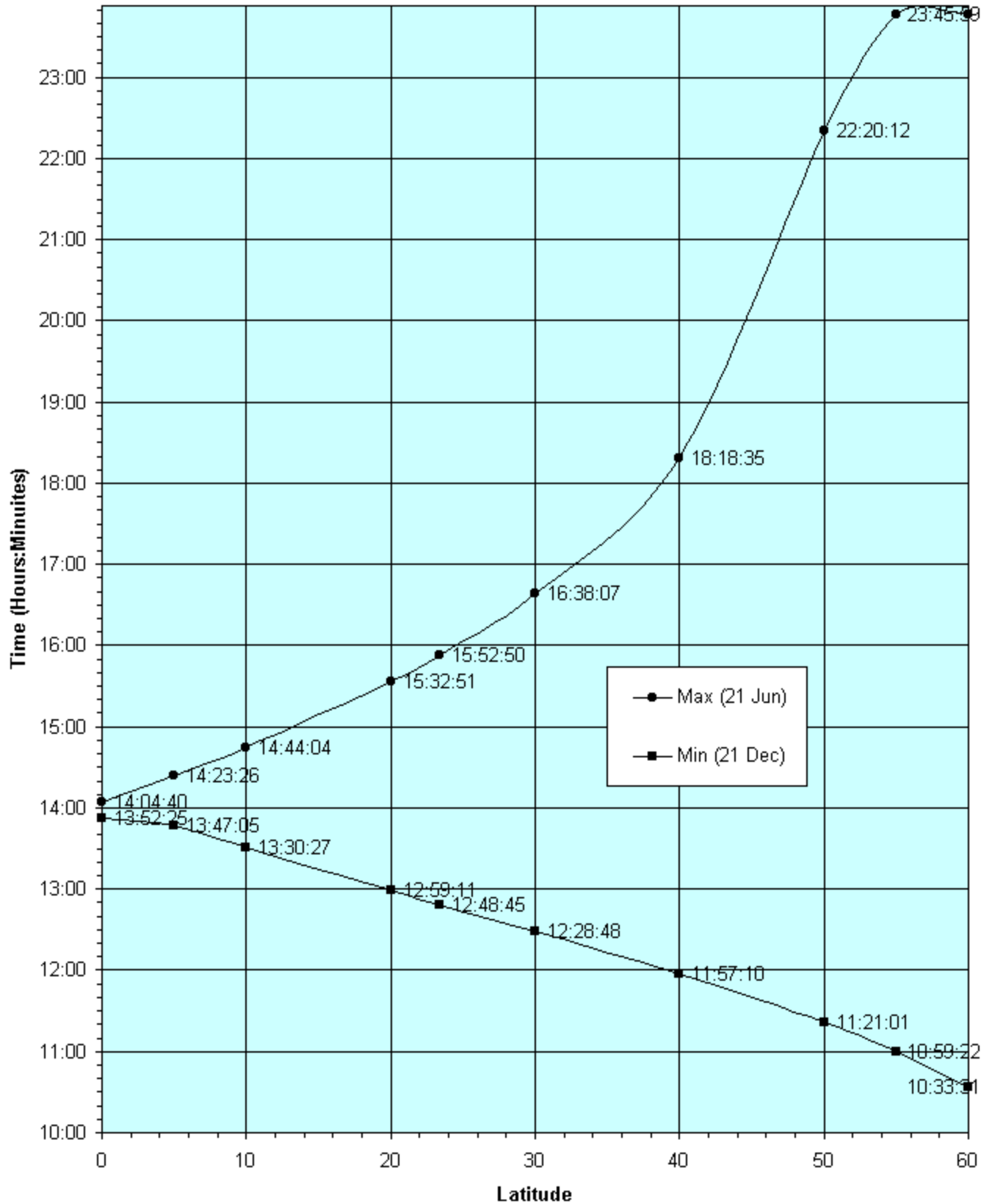

# Latitude & Temperature

<http://home1.gte.net/mikelob/PhotoC-C3.gif>

### C3) Photo Cell Measurements Max and Min Daylight Time During A Year

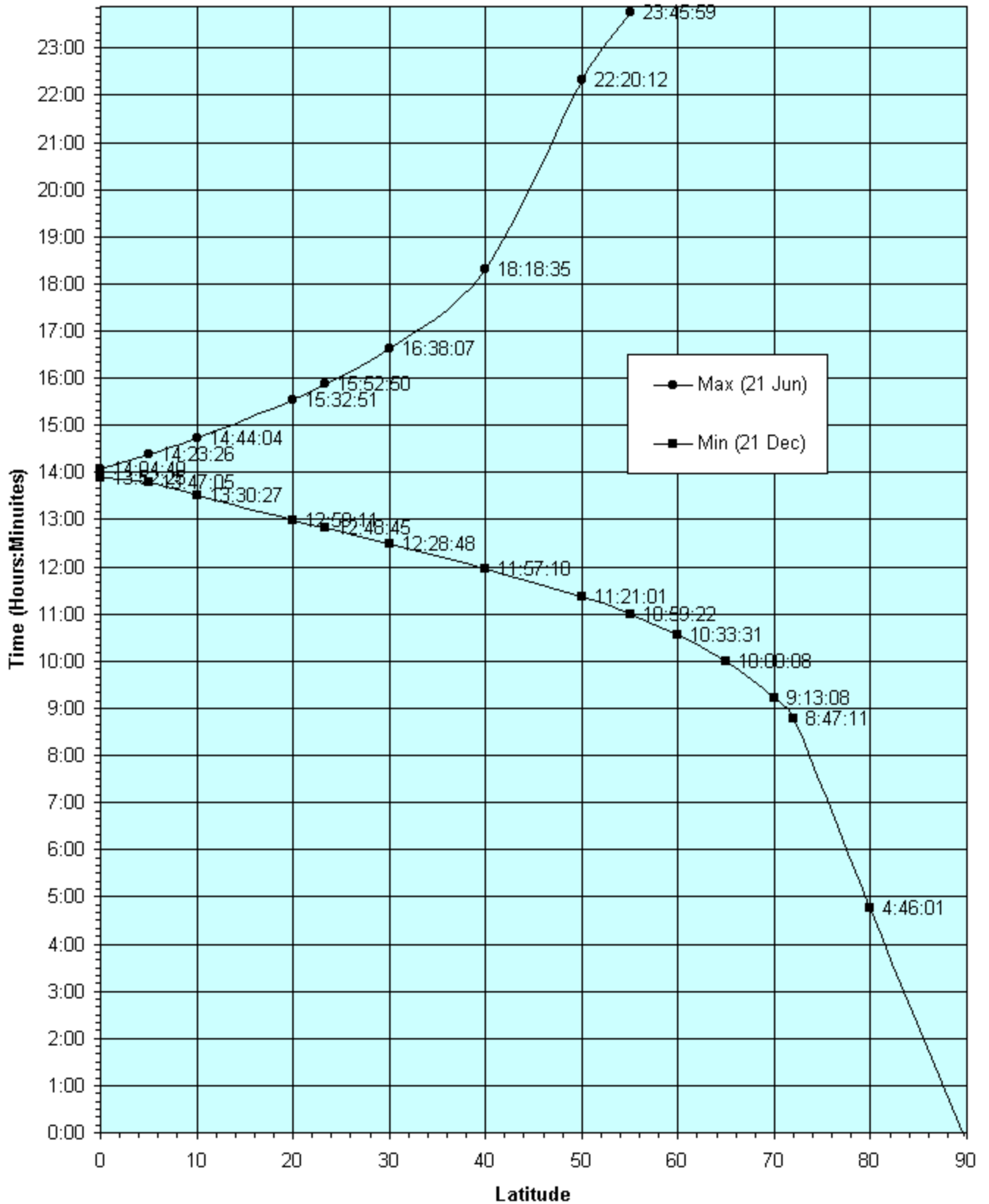

## Latitude & Temperature

How do you use these graphs in practice? If you have a working watch or clock that has a built in calendar and it has been working since before the PS, then you can wait until near 21 Jun (maximum daylight) or 21 Dec (minimum Daylight) and then take some length of daylight type of measurements. If you don't trust the north south rotational axis to be aligned in the same direction (toward north star), or if you have lost track of days then you can take measurements once a week or once ever several weeks until the tend slows down and changes direction. At the slow point one may want to take more frequent readings. Plot this on graph paper so you can see the trends. Results would be summarily to curve A1 above.

Once you have found either the minimum or maximum day length then look it up on one of the above graphs to determine what latitude you are at. Jun 21 2003 is very close to May 2003 and the earth my not have going back to close to it's 24 hr/day rotation sufficiently enough. It may be that your fist good reading will be Dec 21 2003.

The next set of curves shows what we get if we subtract the minimum from the maximum length of day. This has one disadvantage in that one needs to wait an additional 6 months over the above curves. It has several big advantages. Any constant cloud density filtering effect that shortens daylight measured time or any differences in photocell sensitivity to light are canceled out of the equation. What this is saying is - if the clouds after PS are much more dense as compared to the clouds I measured, it won't make a difference. It does assume the relative cloud density stays about the same over the 6-month period of measurement. This can be verified by taking regular midday light intensity readings with a light meter aimed straight up.

The big advantage to the following curves is you can measure length of day using almost any method you want. As long as it is gives uniform repeatable results, use it. For example, one could use a solar cell hooked to a digital meter and measure some arbitrary round number of current reading within the hour or half hour before total dark. One could wait until some object in the distance cannot be seen or until you can barely read your watch. If this were the assumed (doing the same every time) criteria for starting and stopping a timer, then the following curves would still work.  
<http://homel.gte.net/mikelob/PhotoC-D1.gif>.

# Latitude & Temperature

D1) Difference between Max & Min Day Length During Any Year For Any Given Latitude Using Photo Cell Measurements

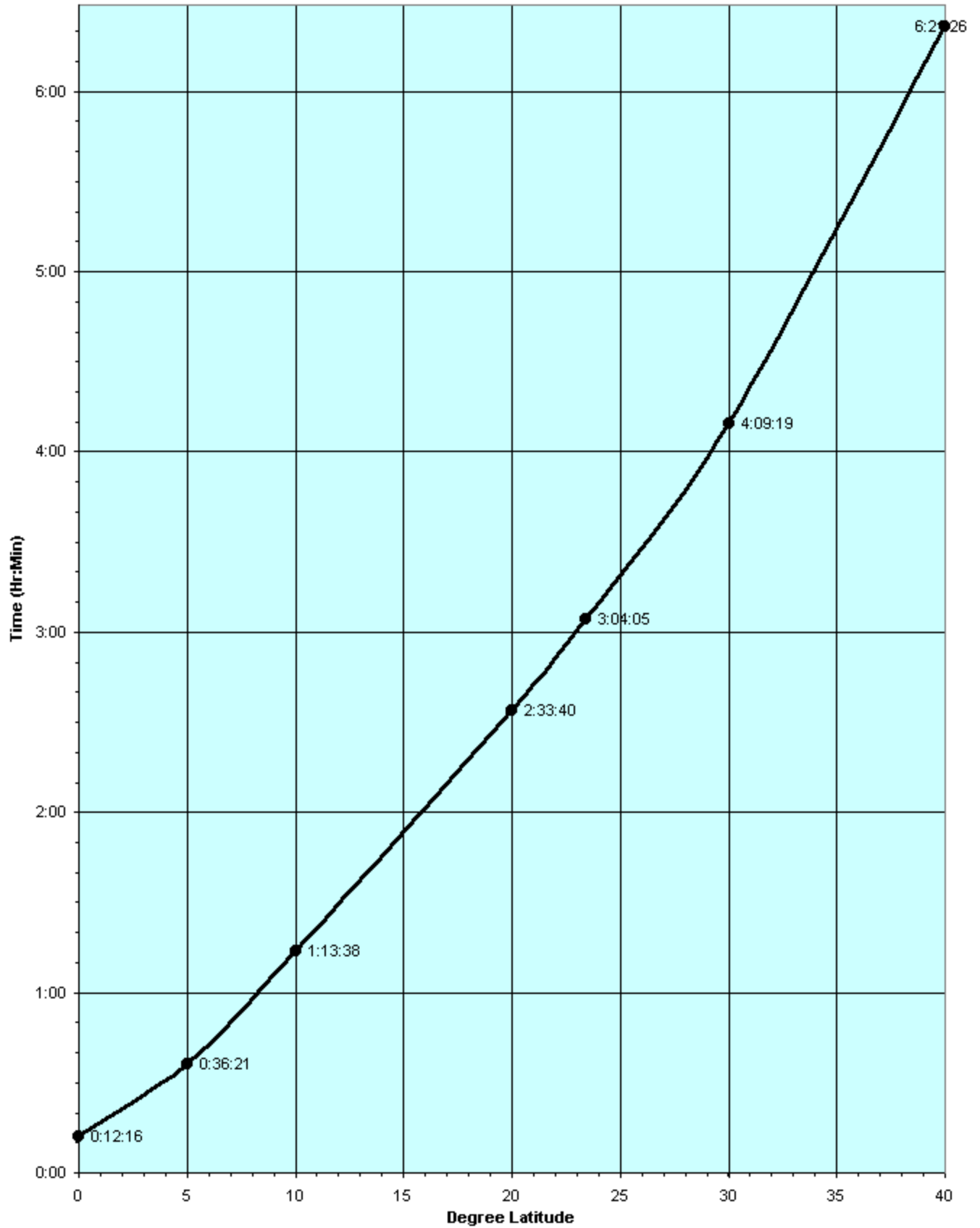

# Latitude & Temperature

<http://home1.gte.net/mikelob/PhotoC-D2.gif>

**D2) Difference between Max & Min Day Lenth During Any Year For Any Given Latatude Using Photo Cell Measurements**

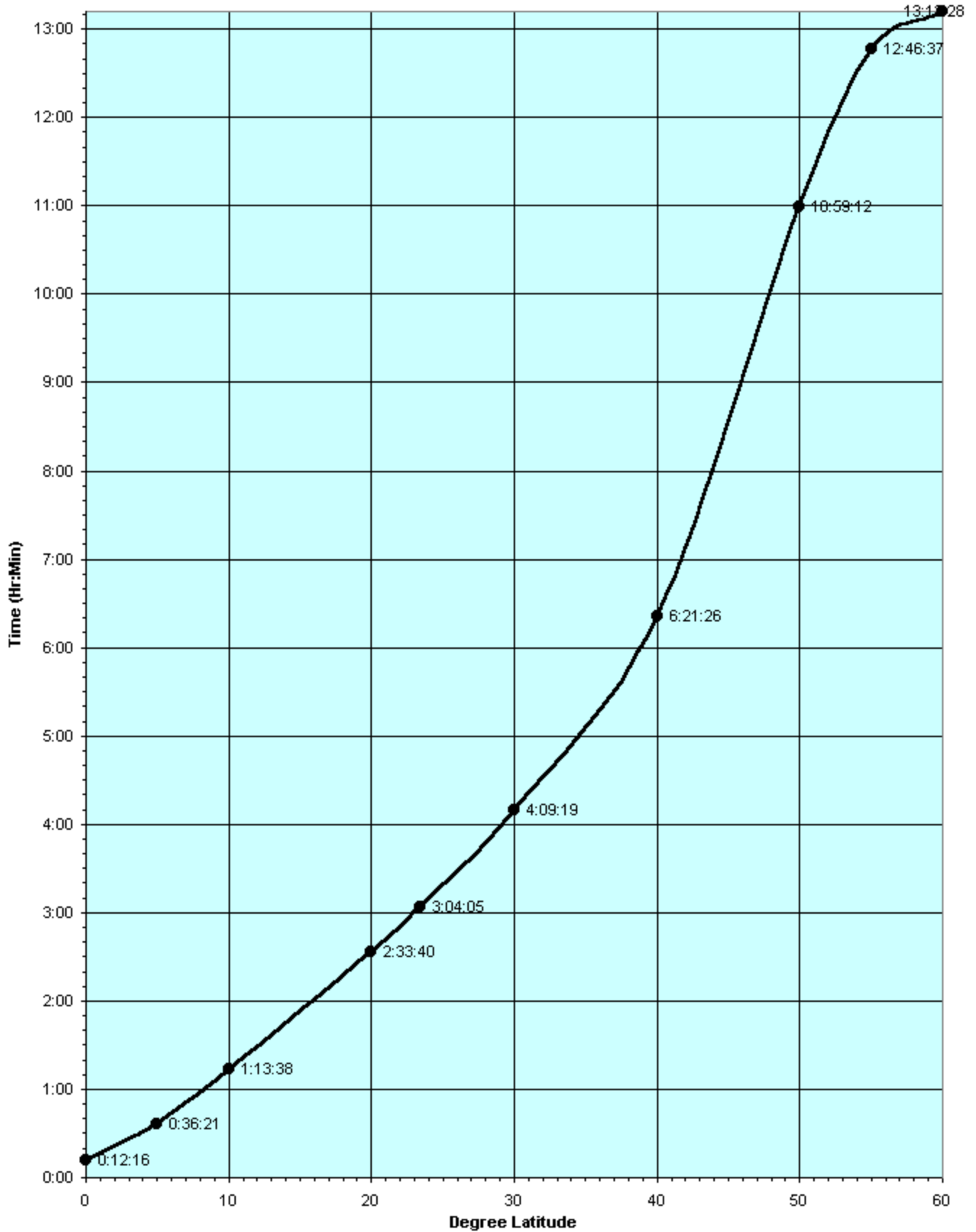

# Latitude & Temperature

<http://home1.gte.net/mikelob/PhotoC-D3.gif>

**D3) Difference between Max & Min Day Lenth During Any Year For Any Given Latatude  
Using Photo Cell Measurements**

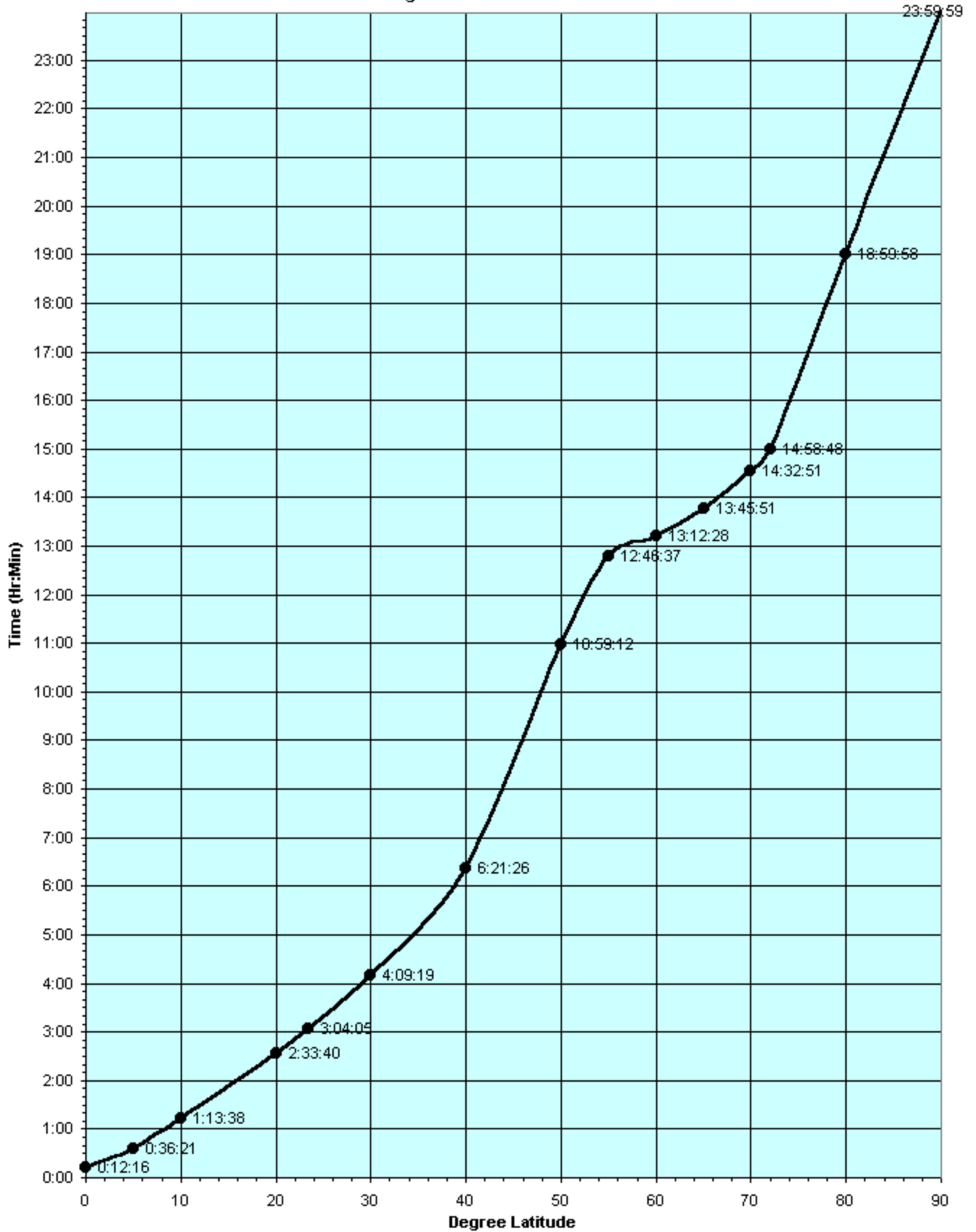

# Latitude & Temperature

How do you use these curves? Simply measure the maximum and minimum length of daylight over 6+ months to a year. Then subtract to find the difference. Look up the result on curve D1, D2, or D3 depending on which fits your situation best. Follow over to the curve then down to determine the latitude you are at.

Rule of thumb from the slope of graph: For latitudes between 5 and 40 degrees: for every 10 degrees latitude you travel away from the equator you add approximately 1.5 hrs of additional time to the difference of maximum and minimum daylight times.

-----

LM-5) Results of measurements part3: Formula to use

For some who are willing to endure a bit of simple math it will be possible to take any two measurements any time of the year and knowing the date of the year calculate the delta of the daylight max-minimums needed for the D1-D3 tables previously presented.

If you recall PhotoC-A1.gif. Shows that a sine wave will fit this curve nicely. This sin wave doesn't start until approximately 21 mar of each year. This is 80 days into the year. Next note that there are 365.24 days/year and only 360 degrees for a full sine wave. Thus calculation of days Dn for any day of the year Day# (number of the day in the year) for the equation below becomes:

If the date is before 21 mar then use:

$$Dn = (365.24 + \text{Day}\# - 80) * (360 / 365.24) = (285.24 + \text{Day}\#) * (.98565)$$

If the date is after or equal to 21 mar then use:

$$Dn = (\text{Day}\# - 80) * (360 / 365.24) = (\text{Day}\# - 80) * (.9856)$$

In the above chart-A1 note there is a constant call it "K" of about 10:20 that could represent the offset of the sine wave from zero to the bottom of the wave. Now Assume "C" is the distance between the maximum and minimum (amplitude about 4hr 40 min in this case). If we take two measurements then two equations can be written:

Measurement 1:  $M1 = K + C(1 + \sin(D1))$  where D1 is calculated using equation for Dn

Measurement 2:  $M2 = K + C(1 + \sin(D2))$  where D2 is calculated using equation for Dn

If we now subtract these two equations we get:

$$M1 - M2 = K - K + C(1 - 1 + \sin(D1) - \sin(D2)) = C(\sin(D1) - \sin(D2))$$

$$\text{Thus } C = (M1 - M2) / (\sin(D1) - \sin(D2))$$

"C" once calculated can be looked up in the following potted curves to determine Latitude.

<http://home1.gte.net/mikelob/PhotoC-D1.gif>.

<http://home1.gte.net/mikelob/PhotoC-D2.gif>.

<http://home1.gte.net/mikelob/PhotoC-D3.gif>.

See above the same plots.

Note: You will need a scientific calculator or a table sine values to do these calculations. More accuracy will be obtained if the time between



## Latitude & Temperature

M1 and M2 results in a fair sized difference.

This calculation will allow determination of Latitude at any time of the year once mastered. It does rely on having a working calendar date reference past the PS. One could use several watches with a date calendar. One watch would keep going while the battery is changed and reset in the other.

-----  
Subject: LM-6) Light meter construction and use:

If after the PS you are curious about how fast the darkness is clearing up. Then take your light meter out side near noontime once a week or month and plot a graph of light intensity versus Time. This way you can predict when you will have enough light for efficient outdoors growing.

A useful light meter can be made really cheaply for under \$20 from a harbor freight tools using a low cost digital multi-meter (part number 30756) \$6.50 to about \$13 depending on sale price at the time. See: <http://www.harborfreight.com/>. And enter the part number under "find item number:" then click "GO". A silicon solar cell can be purchased from radio shack for about \$5 and hooked directly using any 2 wires with 2 Radio Shack Banana Plugs (cat no. 274-721c) for \$1.59.

The solar cell comes with a nice little plastic box. Solder the leads on. One trick with this -- solder it without flux on the solder. Melt a big drop of solder on the wire on a piece of paper to take off the rosin, let cool, transfer to the back of the solar cell. Holding the wire heat enough to get it to stick. This worked best for me. Other wise once the flux gets on the back of the solar cell it becomes hard or nearly imposable to get solder to stick. One can add a small amount of foam rubber to hold the solar cell to the front face. Close the box and use five-minute epoxy over the crack to seal it up and keep it from opening.

Readings are taking using the DC milliamp and microampere current scales. The unit can be calibrated before the PS if needed. Compare with a know light meter, the sun for high end, and light bulbs or a candle for the low end. For measuring Latitude no celebration is needed. I plotted the following as a typical calibration curve.

# Latitude & Temperature

**A1) Radio Shack Solar Cell and Digital Amp-meter Calibration Curve**  
Read Milliamps from meter and using appropriate curve find light intensity.

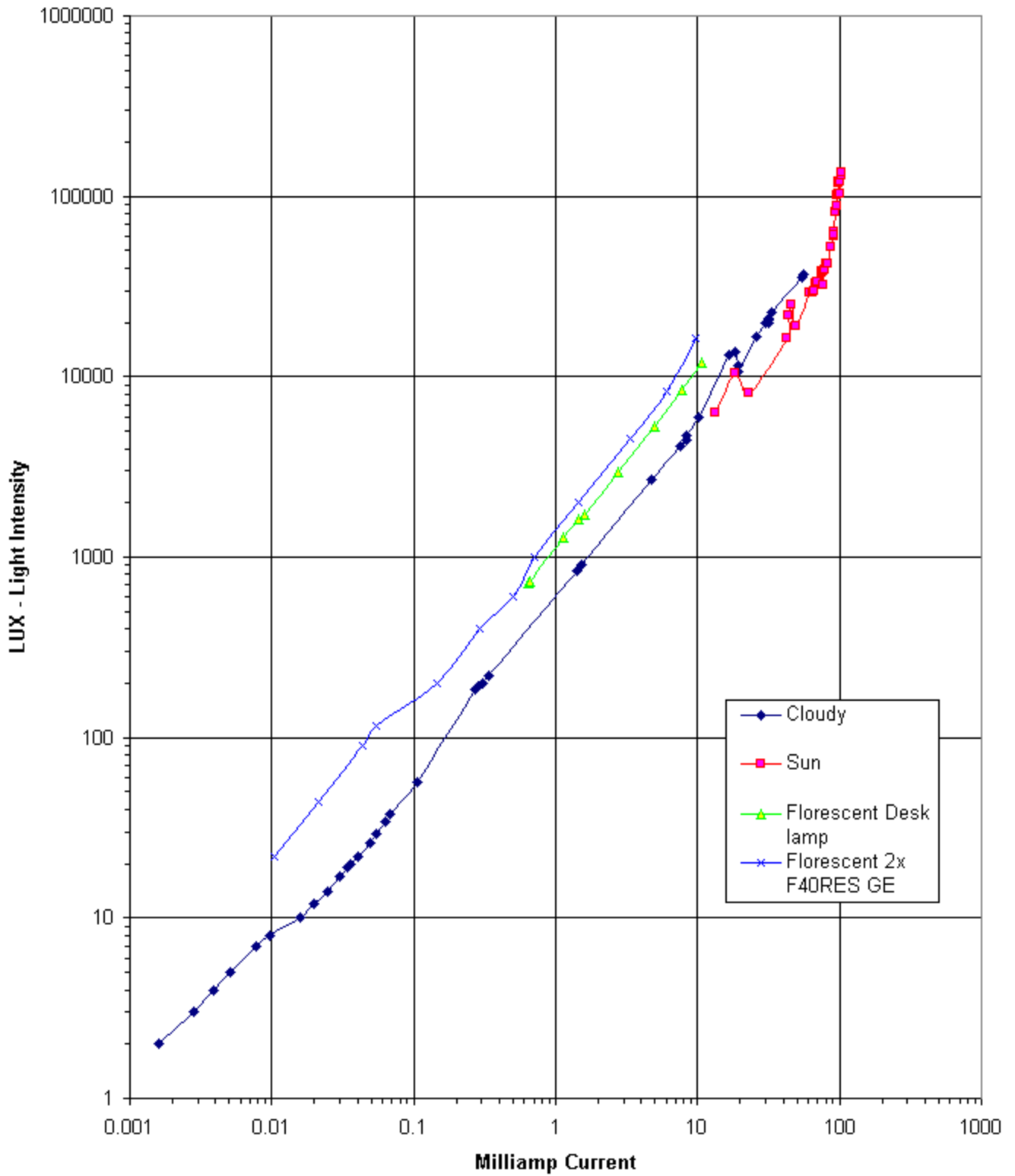

LuxMeter-A1.gif. Note the different curves that resulted because of the different light spectrum for each type of light. Bright sun has more infrared, florescent and cloudy skies have

## Latitude & Temperature

much less. To use this curve one would take a reading in milliamps and follow over to the curve that is appropriate and then over to the LUX axis to see what the light intensity is. I used a LX-101 LUX meter as a standard. This can be purchased at Electronics Express 1-800-972-2225 for \$65.95 and has a part No. 01LX101.

Typical maximum measurements of 150,000 LUX are found on a bright sunny day. With cloudy conditions it can get down to approximately 10,000 LUX. For a typical clear day the sun goes down with the most rapid light change (steepest slope) between 100 LUX and 5 LUX. See <http://home1.gte.net/mikelob/SUNLUX1.gif>.

# Latitude & Temperature

## Typical Light Intensity (Clear day) as the Sun Goes Down (May 99)

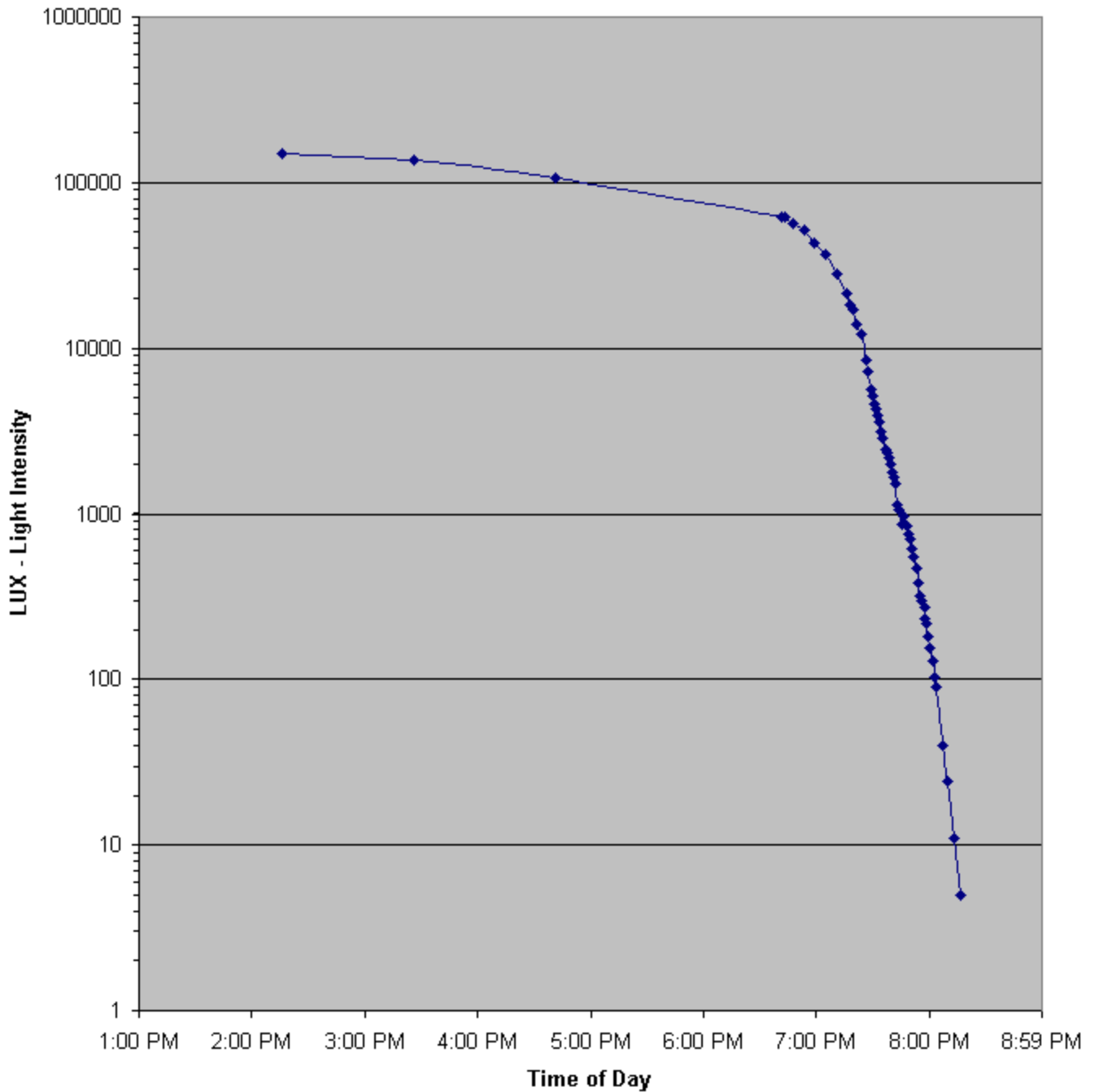

At the intensity of where photocells typically switch we get about 10 LUX change/min. Thus it becomes possible to measure the length of the day fairly precisely using these devices.

-----  
Subject: LM-7) Temperature, precipitation versus latitude:

For the data available right now I get the following curves:  
Temperature Fahrenheit <http://home1.gte.net/mikelob/PhotoC-E1.gif>.

# Latitude & Temperature

E1) Average High and Low Temperatures per Latitude

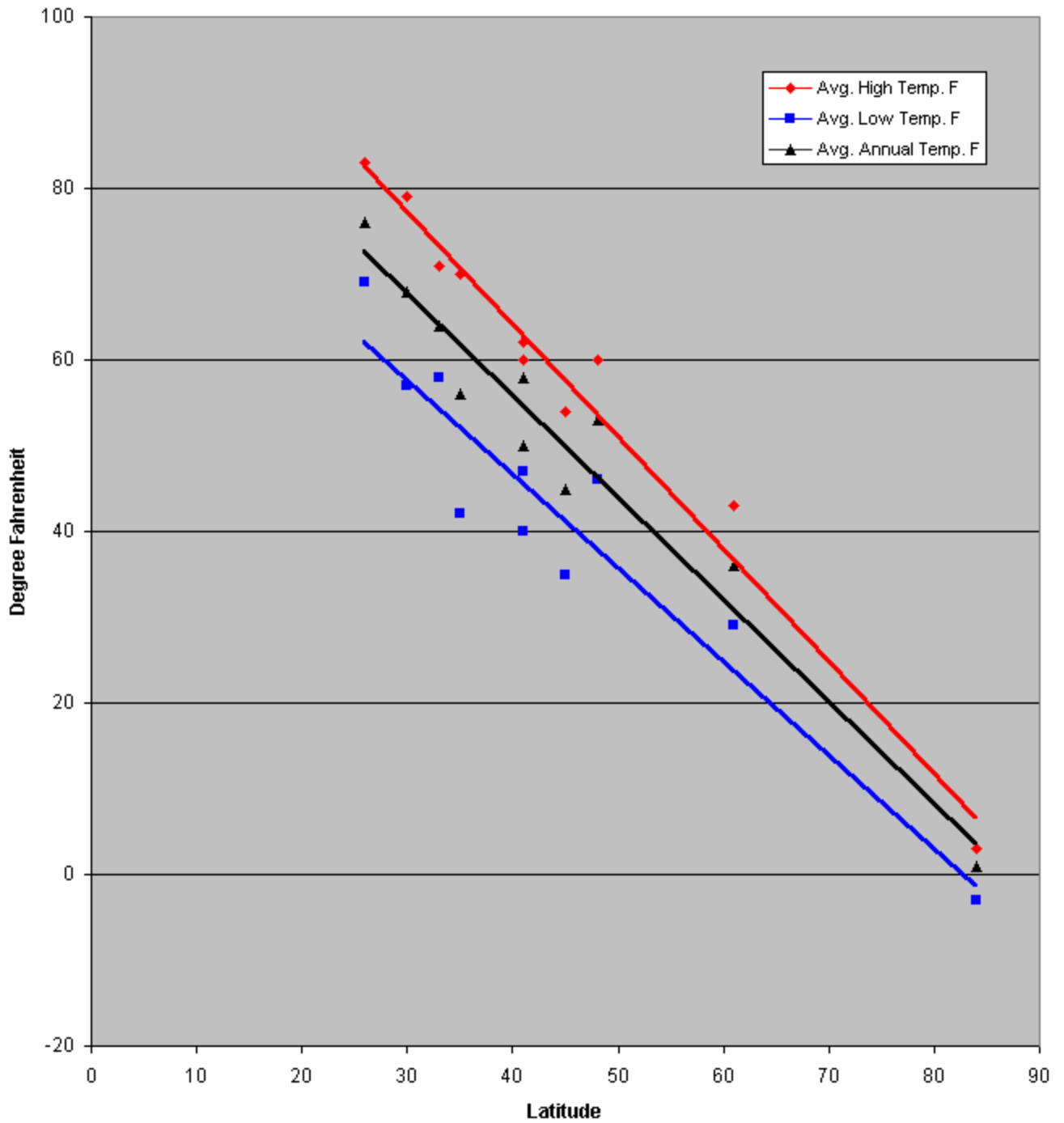

Temperature Centigrade <http://home1.gte.net/mikelob/PhotoC-E2.gif>.

# Latitude & Temperature

## E2) Average High and Low Temperatures per Latitude

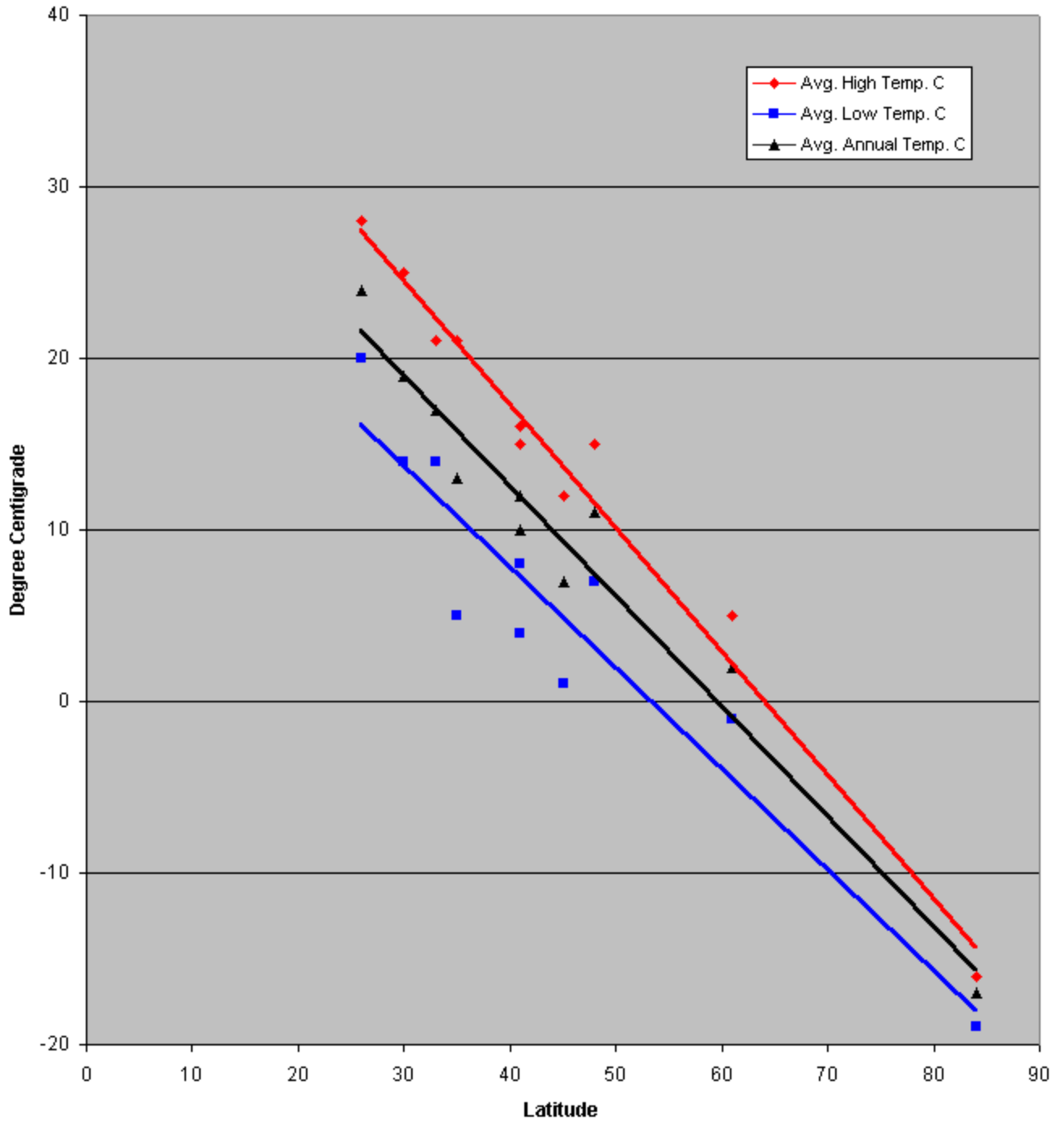

# Latitude & Temperature

Precipitation Inches <http://home1.gte.net/mikelob/PhotoC-E3.gif>.

## E3) Annual Precipitation (Inches)

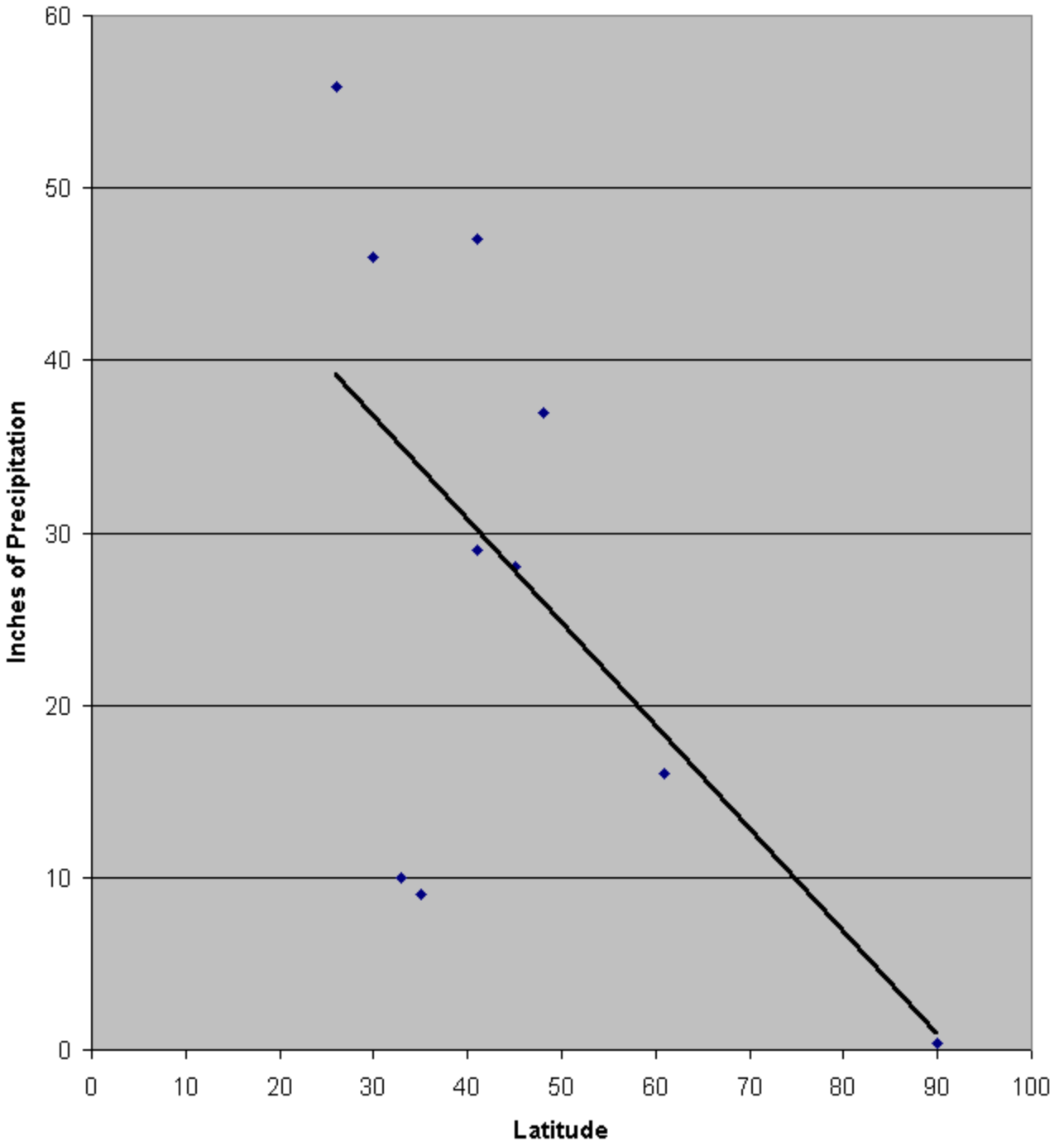

Precipitation cm <http://home1.gte.net/mikelob/PhotoC-E4.gif>.

# Latitude & Temperature

## E4) Annual Precipitation (cm)

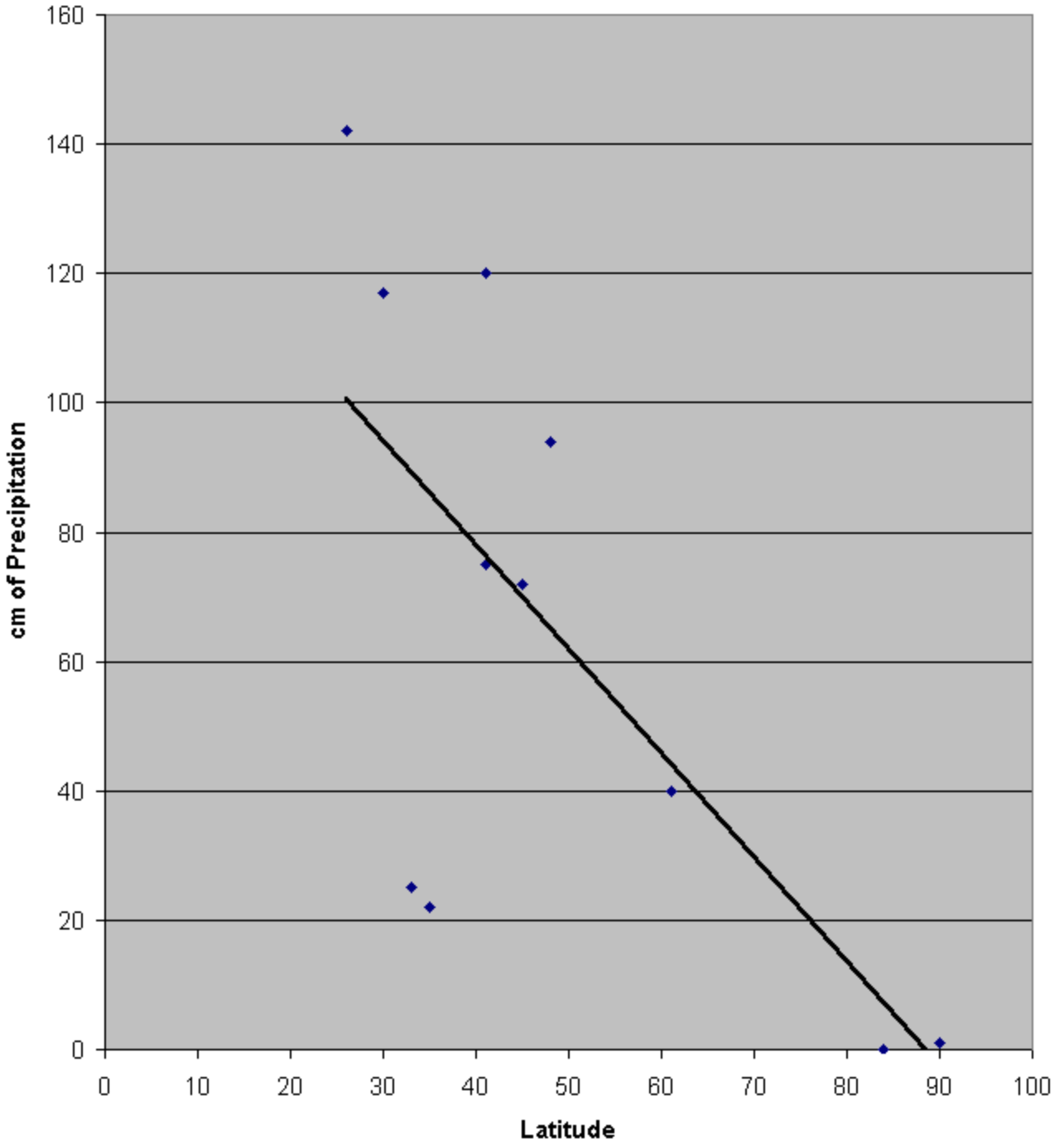

Data came from the following site

<http://www.nsf.gov/od/lpa/nstw/teach/nstw98/english/actb/smpfx1.htm>

Sorry, for the length of this report: I couldn't find this subject discussed on the web so had to do the necessary basic research to determine the results we could all use. If anyone finds more data on temperatures, precipitation versus latitude or other useful data please post it.